

TOSHIBA Portégé M200
Portable Personal Computer
User's Manual

Copyright

© 2003 by TOSHIBA Corporation. All rights reserved. Under the copyright laws, this manual cannot be reproduced in any form without the prior written permission of TOSHIBA. No patent liability is assumed, with respect to the use of the information contained herein.

TOSHIBA Portégé M200 Portable Personal Computer User's Manual

First edition November 2003

Disclaimer

This manual has been validated and reviewed for accuracy. The instructions and descriptions it contains are accurate for the TOSHIBA Portégé M200 Portable Personal Computer at the time of this manual's production. However, succeeding computers and manuals are subject to change without notice. TOSHIBA assumes no liability for damages incurred directly or indirectly from errors, omissions or discrepancies between the computer and the manual.

Trademarks

IBM is a registered trademark of International Business Machines Corporation. Intel, Pentium and Centrino are registered trademarks and SpeedStep is a trademark of Intel Corporation.

Windows and Microsoft are registered trademarks of Microsoft Corporation. Bluetooth is a trademark owned by its proprietor and used by TOSHIBA under licence.

Other trademarks and registered trademarks not listed above may be used in this manual.

FCC information

Product Name : *Portégé M200*

Model number : *PPM20*

FCC notice "Declaration of Conformity Information"

This equipment has been tested and found to comply with the limits for a Class B digital device, pursuant to part 15 of the FCC rules. These limits are designed to provide reasonable protection against harmful interference in a residential installation. This equipment generates, uses and can radiate radio frequency energy and, if not installed and used in accordance with the instructions, may cause harmful interference to radio communications. However, there is no guarantee that interference will not occur in a particular installation. If this equipment does cause harmful interference to radio or television reception, which can be determined by turning the equipment off and on, the user is encouraged to try to correct the interference by one or more of the following measures:

- Reorient or relocate the receiving antenna.
- Increase the separation between the equipment and receiver.
- Connect the equipment into an outlet on a circuit different from that to which the receiver is connected.
- Consult the dealer or an experienced radio/TV technician for help.

WARNING: *Only peripherals complying with the FCC class B limits may be attached to this equipment. Operation with non-compliant peripherals or peripherals not recommended by TOSHIBA is likely to result in interference to radio and TV reception. Shielded cables must be used between the external devices and the computer's external monitor port, USB port and microphone jack. Changes or modifications made to this equipment, not expressly approved by TOSHIBA or parties authorized by TOSHIBA could void the user's authority to operate the equipment. The modular cable that comes with the computer must be used to connect a modem.*

FCC conditions

This device complies with part 15 of the FCC Rules. Operation is subject to the following two conditions:

1. This device may not cause harmful interference.
2. This device must accept any interference received, including interference that may cause undesired operation.

Contact

Address: TOSHIBA America Information Systems, Inc.
9740 Irvine Boulevard
Irvine, California 92618-1697

Telephone: (949)583-3000



EU Declaration of Conformity

TOSHIBA declares, that the product: PPM20* conforms to the following Standards:

Supplementary Information: “The product complies with the requirements of the Low Voltage Directive 73/23/EEC, the EMC Directive 89/336/EEC and/or the R&TTE Directive 1999/05/EEC.”

This product is carrying the CE-Mark in accordance with the related European Directives. Responsible for CE-Marking is TOSHIBA Europe, Hammfelddamm 8, 41460 Neuss, Germany.

VCCI Class B Information

この装置は、情報処理装置等電波障害自主規制協議会（VCCI）の基準に基づくクラスB情報技術装置です。この装置は、家庭環境で使用することを目的としていますが、この装置がラジオやテレビジョン受信機に近接して使用されると、受信障害を引き起こすことがあります。

取扱説明書に従って正しい取り扱いをして下さい。

Modem warning notice

Conformity Statement

The equipment has been approved to [Commission Decision “CTR21”] for pan-European single terminal connection to the Public Switched Telephone Network (PSTN).

However, due to differences between the individual PSTNs provided in different countries/regions the approval does not, of itself, give an unconditional assurance of successful operation on every PSTN network termination point.

In the event of problems, you should contact your equipment supplier in the first instance.

Network Compatibility Statement

This product is designed to work with, and is compatible with the following networks. It has been tested to and found to conform with the additional requirements conditional in EG 201 121.

Germany	ATAAB AN005,AN006,AN007,AN009,AN010 and DE03,04,05,08,09,12,14,17
Greece	ATAAB AN005,AN006 and GR01,02,03,04
Portugal	ATAAB AN001,005,006,007,011 and P03,04,08,10
Spain	ATAAB AN005,007,012, and ES01
Switzerland	ATAAB AN002
All other countries/regions	ATAAB AN003,004

Specific switch settings or software setup are required for each network, please refer to the relevant sections of the user guide for more details.

The hookflash (timed break register recall) function is subject to separate national type approvals. It has not been tested for conformity to national type regulations, and no guarantee of successful operation of that specific function on specific national networks can be given.

Japan regulations

Region selection

If you are using the computer in Japan, technical regulations described in the Telecommunications Business Law require that you select the Japan region mode. It is illegal to use the modem in Japan with any other selection.

Redial

Up to two redial attempts can be made. If more than two redial attempts are made, the modem will return **Black Listed**. If you are experiencing problems with the Black Listed code, set the interval between redials at one minute or longer.

Japan's Telecommunications Business Law permits up to two redials on analogue telephones, but the redials must be made within a total of three minutes.

The internal modem is approved by Japan Approvals Institute for Telecommunications Equipment.



A02-0604JP

Pursuant to FCC CFR 47, Part 68:

When you are ready to install or use the modem, call your local telephone company and give them the following information:

- The telephone number of the line to which you will connect the modem
- The registration number that is located on the device

The FCC registration number of the modem will be found on either the device which is to be installed, or, if already installed, on the bottom of the computer outside of the main system label.

- The Ringer Equivalence Number (REN) of the modem, which can vary. For the REN of your modem, refer to your modem's label.

The modem connects to the telephone line by means of a standard jack called the USOC RJ11C.

Type of service

Your modem is designed to be used on standard-device telephone lines. Connection to telephone company-provided coin service (central office implemented systems) is prohibited. Connection to party lines service is subject to state tariffs. If you have any questions about your telephone line, such as how many pieces of equipment you can connect to it, the telephone company will provide this information upon request.

Telephone company procedures

The goal of the telephone company is to provide you with the best service it can. In order to do this, it may occasionally be necessary for them to make changes in their equipment, operations, or procedures. If these changes might affect your service or the operation of your equipment, the telephone company will give you notice in writing to allow you to make any changes necessary to maintain uninterrupted service.

If problems arise

If any of your telephone equipment is not operating properly, you should immediately remove it from your telephone line, as it may cause harm to the telephone network. If the telephone company notes a problem, they may temporarily discontinue service. When practical, they will notify you in advance of this disconnection. If advance notice is not feasible, you will be notified as soon as possible. When you are notified, you will be given the opportunity to correct the problem and informed of your right to file a complaint with the FCC. In the event repairs are ever needed on your modem, they should be performed by TOSHIBA Corporation or an authorized representative of TOSHIBA Corporation.

Disconnection

If you should ever decide to permanently disconnect your modem from its present line, please call the telephone company and let them know of this change.

Fax branding

The Telephone Consumer Protection Act of 1991 makes it unlawful for any person to use a computer or other electronic device to send any message via a telephone fax machine unless such message clearly contains in a margin at the top or bottom of each transmitted page or on the first page of the transmission, the date and time it is sent and an identification of the business, other entity or individual sending the message and the telephone number of the sending machine or such business, other entity or individual. In order to program this information into your fax modem, you should complete the setup of your fax software before sending messages.

Instructions for IC CS-03 certified equipment

- 1 The Industry Canada label identifies certified equipment. This certification means that the equipment meets certain telecommunications network protective, operational and safety requirements as prescribed in the appropriate Terminal Equipment Technical Requirements document(s). The Department does not guarantee the equipment will operate to the user's satisfaction.

Before installing this equipment, users should ensure that it is permissible to be connected to the facilities of the local telecommunications company. The equipment must also be installed using an acceptable method of connection.

The customer should be aware that compliance with the above conditions may not prevent degradation of service in some situations. Repairs to certified equipment should be coordinated by a representative designated by the supplier. Any repairs or alterations made by the user to this equipment, or equipment malfunctions, may give the telecommunications company cause to request the user to disconnect the equipment.

Users should ensure for their own protection that the electrical ground connections of the power utility, telephone lines and internal metallic water pipe system, if present, are connected together. This precaution may be particularly important in rural areas.

***CAUTION:** Users should not attempt to make such connections themselves, but should contact the appropriate electric inspection authority, or electrician, as appropriate.*

- 2 The user manual of analog equipment must contain the equipment's Ringer Equivalence Number (REN) and an explanation notice similar to the following:
The Ringer Equivalence Number (REN) of the modem, which can vary. For the REN of your modem, refer to your modem's label.

***NOTICE:** The Ringer Equivalence Number (REN) assigned to each terminal device provides an indication of the maximum number of terminals allowed to be connected to a telephone interface. The termination on an interface may consist of any combination of devices subject only to the requirement that the sum of the Ringer Equivalence Numbers of all the devices does not exceed 5.*

- 3** The standard connecting arrangement (telephone jack type) for this equipment is jacktype(s): USOC RJ11C.

The IC registration number of the modem is shown below.

Canada: 1353A-L4AINT

Notes for Users in Australia and New Zealand

Modem warning notice for Australia

Modems connected to the Australian telecoms network must have a valid Austel permit. This modem has been designed to specifically configure to ensure compliance with Austel standards when the country/region selection is set to Australia. The use of other country/region setting while the modem is attached to the Australian PSTN would result in you modem being operated in a non-compliant manner. To verify that the country/region is correctly set, enter the command ATI which displays the currently active setting.

To set the country/region permanently to Australia, enter the following command sequence:

```
AT%TE=1
ATS133=1
AT&F
AT&W
AT%TE=0
ATZ
```

Failure to set the modem to the Australia country/region setting as shown above will result in the modem being operated in a non-compliant manner. Consequently, there would be no permit in force for this equipment and the Telecoms Act 1991 prescribes a penalty of \$12,000 for the connection of non-permitted equipment.

Notes for use of this device in New Zealand

- ❑ The grant of a Telepermit for a device in no way indicates Telecom acceptance of responsibility for the correct operation of that device under all operating conditions. In particular the higher speeds at which this modem is capable of operating depend on a specific network implementation which is only one of many ways of delivering high quality voice telephony to customers. Failure to operate should not be reported as a fault to Telecom.
- ❑ In addition to satisfactory line conditions a modem can only work properly if:
 - a/ it is compatible with the modem at the other end of the call and
 - b/ the application using the modem is compatible with the application at the other end of the call - e.g., accessing the Internet requires suitable software in addition to a modem.
- ❑ This equipment shall not be used in any manner which could constitute a nuisance to other Telecom customers.
- ❑ Some parameters required for compliance with Telecom's PTC Specifications are dependent on the equipment (PC) associated with this modem. The associated equipment shall be set to operate within the following limits for compliance with Telecom Specifications:
 - a/ There shall be no more than 10 call attempts to the same number within any 30 minute period for any single manual call initiation, and
 - b/ The equipment shall go on-hook for a period of not less than 30 seconds between the end of one attempt and the beginning of the next.
 - c/ Automatic calls to different numbers shall be not less than 5 seconds apart.
- ❑ Immediately disconnect this equipment should it become physically damaged, and arrange for its disposal or repair.
- ❑ The correct settings for use with this modem in New Zealand are as follows:
 - ATB0(CCITT operation)
 - AT&G2(1800Hz guard tone)
 - AT&P1 (Decadic dialing make-break ratio=33%/67%)
 - ATS0=0 (not auto answer)
 - ATS6=4(Blind dial display)
 - ATS7=less than 90 (Time to wait to carrier after dialing)
 - ATS10=less than 150 (loss of carrier to hang up delay, factory default of 15 recommended)

ATS11=90(DTMF dialing on/off duration=90 ms)

ATX2 (Dial tone detect, but not (U.S.A.) call progress detect)

- ❑ When used in the Auto Answer mode, the S0 register must be set with a value of 3 or 4. This ensures:
 - (a) a person calling your modem will hear a short burst of ringing before the modem answers. This confirms that the call has been successfully switched through the network.
 - (b) caller identification information (which occurs between the first and second ring cadences) is not destroyed.
- ❑ The preferred method of dialing is to use DTMF tones (ATDT...) as this is faster and more reliable than pulse (decadic) dialing. If for some reason you must use decadic dialing, your communications program must be set up to record numbers using the following translation table as this modem does not implement the New Zealand “Reverse Dialing” standard.

Number to be dialed: 0 1 2 3 4 5 6 7 8 9

Number to program into computer: 0 9 8 7 6 5 4 3 2 1

Note that where DTMF dialing is used, the numbers should be entered normally.

- ❑ The transmit level from this device is set at a fixed level and because of this there may be circumstances where the performance is less than optimal. Before reporting such occurrences as faults, please check the line with a standard Telepermitted telephone, and only report a fault if the phone performance is impaired.
- ❑ It is recommended that this equipment be disconnected from the Telecom line during electrical storms.
- ❑ When relocating the equipment, always disconnect the Telecom line connection before the power connection, and reconnect the power first.
- ❑ This equipment may not be compatible with Telecom Distinctive Alert cadences and services such as Fax Ability.

NOTE THAT FAULT CALLOUTS CAUSED BY ANY OF THE ABOVE CAUSES MAY INCUR A CHARGE FROM TELECOM

General conditions

As required by PTC 100, please ensure that this office is advised of any changes to the specifications of these products which might affect compliance with the relevant PTC Specifications.

The grant of this Telepermit is specific to the above products with the marketing description as stated on the Telepermit label artwork. The Telepermit may not be assigned to other parties or other products without Telecom approval.

A Telepermit artwork for each device is included from which you may prepare any number of Telepermit labels subject to the general instructions on format, size and colour on the attached sheet.

The Telepermit label must be displayed on the product at all times as proof to purchasers and service personnel that the product is able to be legitimately connected to the Telecom network.

The Telepermit label may also be shown on the packaging of the product and in the sales literature, as required in PTC 100.

The charge for a Telepermit assessment is \$337.50. An additional charge of \$337.50 is payable where an assessment is based on reports against non-Telecom New Zealand Specifications. \$112.50 is charged for each variation when submitted at the same time as the original.

An invoice for \$NZ1237.50 will be sent under separate cover.

Table of Contents

Preface

Manual contents	xix
Conventions	xx
Abbreviations	xx
Icons	xx
Keys	xx
Key operation	xxi
Display	xxi
Messages	xxi

General Precautions

Stress injury	xxiii
Heat injury	xxiii
Pressure or impact damage	xxiii
PC card overheating	xxiv
Mobile phone	xxiv
Central Processing Unit ("CPU") Performance Disclaimer	xxiv
Cooling fan	xxv

Chapter 1 Introduction

Equipment checklist	1-1
Hardware	1-1
Software	1-1
Features	1-2
Special features	1-7
Utilities	1-9
Options	1-11

Chapter 2 The Grand Tour

Front with the display closed	2-1
Left side	2-2
Right side	2-3
Back side	2-4
Underside	2-5

Front with the display open	2-7
Indicators	2-9
AC adaptor	2-12

Chapter 3 Getting Started

Setting up your work space	3-2
General conditions	3-2
Placement of computer	3-3
Seating and posture	3-3
Lighting	3-4
Work habits	3-4
Operating the computer in tablet mode	3-5
Connecting the AC adaptor	3-6
Opening the display	3-8
Turning on the power	3-9
Starting up for the first time	3-10
Turning off the power	3-10
Shut Down mode (Boot mode)	3-10
Hibernation mode	3-11
Standby mode	3-13
Restarting the computer	3-15
Restoring the preinstalled software from the Product Recovery CD-ROM	3-15

Chapter 4 Operating Basics

Using the Touch Pad	4-1
Using the Tablet PC Pen and Reserve Pen	4-2
Inserting the Tablet PC Pen	4-4
Removing the Tablet PC Pen	4-5
Pen actions	4-5
Single tap	4-5
Double tap	4-5
Press and hold	4-5
Drag	4-6
Drag and drop	4-6
Replacing the pen tip	4-6
Inserting the Reserve Pen	4-7
Removing the Reserve Pen	4-7
Changing to the Tablet mode	4-8
Changing the screen orientation	4-10

Method 1: Changing the screen orientation using TOSHIBA Accelerometer Utilities	4-11
Method 2: Changing the screen orientation using Enter/Menu Button	4-12
Method 3: Changing the screen orientation using Task Bar	4-12
Changing to the laptop mode	4-13
Using the USB FDD Kit	4-13
Connecting the USB diskette drive	4-14
Disconnecting the USB diskette drive	4-15
Diskette care	4-15
Wireless communications	4-16
Wireless LAN	4-16
Bluetooth wireless technology	4-17
Wireless communication switch	4-18
Wireless communication Indicator	4-18
LAN	4-19
LAN cable types	4-19
Connecting LAN cable	4-19
Disconnecting LAN cable	4-20
Using the microphones	4-21
Audio	4-21
Using the internal modem	4-24
Region selection	4-25
Properties menu	4-25
Connecting	4-26
Disconnecting	4-27
Cleaning the computer	4-27
Moving the computer	4-28
Heat dispersal	4-28

Chapter 5 The Keyboard

Typewriter keys	5-1
F1 ... F12 function keys	5-2
Soft keys: Fn key combinations	5-2
Emulating keys on enhanced keyboard	5-2
Hotkeys	5-4
Fn Sticky key	5-7
Windows special keys	5-7
Keypad overlay	5-7
Turning on the overlays	5-7

Temporarily using normal keyboard (overlay on)	5-8
Temporarily using overlay (overlay off)	5-9
Temporarily changing modes	5-9
Generating ASCII characters	5-9

Chapter 6 Power and Power-Up Modes

Power conditions	6-1
Power indicators	6-3
Battery indicators	6-3
DC IN 15V indicator	6-3
Power indicator	6-4
Battery types	6-4
Battery Pack	6-4
Real time clock battery	6-5
Care and use of the Battery Pack	6-5
Safety precautions	6-6
Charging the batteries	6-9
Monitoring battery capacity	6-10
Maximizing battery operating time	6-11
Retaining data with power off	6-12
Extending battery life	6-12
Replacing the Battery Pack	6-13
Removing the Battery Pack	6-13
Installing the Battery Pack	6-15
TOSHIBA Password Utility	6-16
User password	6-16
Supervisor password	6-17
Starting the computer by password	6-18
Tablet mode	6-18
Power-up modes	6-19
Windows utilities	6-19
Hotkeys	6-19
Panel power off	6-19
System Auto Off	6-20

Chapter 7 HW Setup

HW Setup	7-1
Accessing HW Setup	7-1
HW Setup window	7-1

Chapter 8 Optional Devices

PC cards	8-2
Inserting a PC card	8-2
Removing a PC card	8-3
SD cards	8-3
Inserting an SD card	8-4
Removing an SD card	8-4
Memory expansion	8-6
Installing memory module	8-7
Removing memory module	8-9
Battery Pack	8-10
Universal AC Adaptor	8-10
Battery Charger	8-11
USB diskette Kit	8-11
Tablet Multi Dock	8-11
External monitor	8-12
Tablet PC Pen set	8-12
Reserve pen	8-12
Security lock	8-13

Chapter 9 Troubleshooting

Problem solving process	9-1
Preliminary checklist	9-1
Analyzing the problem	9-2
Hardware and system checklist	9-3
System start-up	9-3
Self test	9-4
Power	9-4
Password	9-7
Keyboard	9-8
LCD panel	9-8
Hard disk drive	9-9
Diskette drive	9-9
Infrared port	9-10
Pointing device	9-10
PC card	9-13
SD card	9-14
Monitor	9-14
Sound system	9-15
USB	9-15
Memory expansion	9-16

Standby/Hibernation	9-17
Modem	9-17
LAN	9-19
Wireless LAN	9-19
Bluetooth	9-20
Real Time Clock	9-20
TOSHIBA support	9-21
Before you call	9-21
Where to write	9-21

Appendixes

Appendix A	
Specifications	A-1
Appendix B	
Display Controller and Modes	B-1
Appendix C	
AT Commands	C-1
Appendix D	
S-registers	D-1
Appendix E	
V.90	E-1
Appendix F	
Wireless LAN	F-1
Appendix G	
AC Power Cord and Connectors	G-1
Appendix H	
Internal Modem Guide	H-1
Appendix I	
Parts Numbers	I-1

Glossary

Index

Preface

Congratulations on your purchase of the TOSHIBA Portégé M200 computer. This powerful, lightweight notebook computer is designed to provide years of reliable, high-performance computing.

This manual tells how to set up and begin using your TOSHIBA Portégé M200 computer. It also provides detailed information on configuring your computer, basic operations and care, using optional devices and troubleshooting.

If you are a new user of computers or if you're new to portable computing, first read over the *Introduction* and *The Grand Tour* chapters to familiarize yourself with the computer's features, components and accessory devices. Then read *Getting Started* for step-by-step instructions on setting up your computer.

If you are an experienced computer user, please continue reading the preface to learn how this manual is organized, then become acquainted with this manual by browsing through its pages. Be sure to look over the *Special features* section of the *Introduction*, to learn about features that are uncommon or unique to the computers and carefully read *HW Setup*. If you are going to install PC cards or connect external devices such as a monitor, be sure to read Chapter 8, *Optional Devices*.

Manual contents

This manual is composed of nine chapters, nine appendixes, a glossary, and an index.

Chapter 1, *Introduction*, is an overview of the computer's features, capabilities, and options.

Chapter 2, *The Grand Tour*, identifies the components of the computer and briefly explains how they function.

Chapter 3, *Getting Started*, provides a quick overview of how to begin operating your computer in laptop mode and tablet mode and gives tips on safety and designing your work area.

Chapter 4, *Operating Basics*, includes tips on care of the computer and on using the Touch Pad, Tablet PC Pen, external diskette drive, Wireless LAN, Bluetooth, LAN, microphone and internal modem.

Chapter 5, *The Keyboard*, describes special keyboard functions including the keypad overlay and hotkeys.

Chapter 6, *Power and Power-Up Modes*, gives details on the computer's power resources and battery save modes and how to set a password.

Chapter 7, *HW Setup*, explains how to configure the computer using the HW Setup program.

Chapter 8, *Optional Devices*, describes the optional hardware available.

Chapter 9, *Troubleshooting*, provides helpful information on how to perform some diagnostic tests, and suggests courses of action if the computer doesn't seem to be working properly.

The *Appendixes* provide technical information about your computer.

The *Glossary* defines general computer terminology and includes a list of acronyms used in the text.

The *Index* quickly directs you to the information contained in this manual.

Conventions

This manual uses the following formats to describe, identify, and highlight terms and operating procedures.

Abbreviations

On first appearance, and whenever necessary for clarity, abbreviations are enclosed in parentheses following their definition. For example: Read Only Memory (ROM). Acronyms are also defined in the Glossary.

Icons

Icons identify ports, dials, and other parts of your computer. The indicator panel also uses icons to identify the components it is providing information on.

Keys

The keyboard keys are used in the text to describe many computer operations. A distinctive typeface identifies the key top symbols as they appear on the keyboard. For example, **Enter** identifies the Enter key.

Key operation

Some operations require you to simultaneously use two or more keys. We identify such operations by the key top symbols separated by a plus sign (+). For example, **Ctrl + C** means you must hold down **Ctrl** and at the same time press **C**. If three keys are used, hold down the first two and at the same time press the third.

ABC When procedures require an action such as clicking an icon or entering text, the icon's name or the text you are to type in is represented in the type face you see to the left.

Display

ABC Names of Windows® or icons or text generated by the computer that appears on its display screen is presented in the type face you see to the left.

Messages

Messages are used in this manual to bring important information to your attention. Each type of message is identified as shown below.

***CAUTION:** Pay attention! A caution informs you that improper use of equipment or failure to follow instructions may cause data loss or damage your equipment.*

***NOTE:** Please read. A note is a hint or advice that helps you make best use of your equipment.*

General Precautions

TOSHIBA computers are designed to optimize safety, minimize strain and withstand the rigors of portability. However, certain precautions should be observed to further reduce the risk of personal injury or damage to the computer.

Be certain to read the general precautions below and to note the cautions included in the text of the manual.

Stress injury

Carefully read the *Instruction Manual for Safety & Comfort*. It contains information on prevention of stress injuries to your hands and wrists than can be caused by extensive keyboard use. Chapter 3, *Getting Started*, also includes information on workspace design, posture and lighting that can help reduce physical stress.

Heat injury

- ❑ Avoid prolonged physical contact with the computer. If the computer is used for long periods, its surface can become very warm. While the temperature will not feel hot to the touch, if you maintain physical contact with the computer for a long time (if you rest the computer on your lap, or if you keep your hands on the palm rest, for example) your skin might suffer low-heat injury.
- ❑ If the computer has been used for a long time, avoid direct contact with the metal plate supporting the I/O ports. It can become hot.
- ❑ The surface of the AC adaptor can become hot when in use. This condition does not indicate a malfunction. If you need to transport the AC adaptor, disconnect it and let it cool before moving it.
- ❑ Do not lay the AC adaptor on a material that is sensitive to heat. The material could be damaged.

Pressure or impact damage

Do not apply heavy pressure to the computer or subject it to strong impact. Excessive pressure or impact can cause damage to computer components or otherwise cause malfunctions.

PC card overheating

Some PC cards can become hot with prolonged use. Overheating of a PC card can result in errors or instability in the PC card operation. Also be careful when you remove a PC card that has been used for a long time.

Mobile phone

Use of mobile phones can interfere with the audio system. Computer operation is not impaired but is recommended that a distance of 30 cm be maintained between the computer and a mobile phone in use.

Central Processing Unit ("CPU") Performance Disclaimer

CPU Performance in your computer product may vary from specifications under the following conditions:

1. use of certain peripheral products
2. use of battery power instead of AC power
3. use of certain multimedia games or videos with special effects
4. use of standard telephone lines or low speed network connections
5. use of complex modeling software, such as high end computer aided design application
6. use of computer in areas with low air pressure (high altitude >1,000 meters or >3,280 feet above sea level)
7. use of computer at temperatures outside the range of 5°C to 35°C (41°F to 95°F) or >25°C (77°F) at high altitude (all temperature reference are approximate).

CPU Performance may also vary from specifications due to design configuration.

Under some conditions, your computer product may automatically shut-down. This is a normal protective feature designed to reduce the risk of lost data or damage to the product when used outside recommended conditions. To avoid risk of lost data, always make back-up copies of data by periodically storing it on an external storage medium. For optimum performance, use your computer product only under recommended conditions. Read additional restrictions under "Environmental Conditions" in your product Resource Guide. Contact TOSHIBA Service and Support for more information.

Cooling fan

This product is equipped with a CPU cooling fan, VGA cooling fan and vent holes. Please make sure to follow the cautions below to avoid overheat.

- Clean any dust or dirt that has accumulated on the CPU cooling fan, VGA cooling fan or vent holes.
- Do not block the CPU cooling fan, VGA cooling fan or vent holes.
- Use, place and carry the computer in the recommended manner.

NOTE: Do not block the vents during use. Cooling fans draw in outside air.

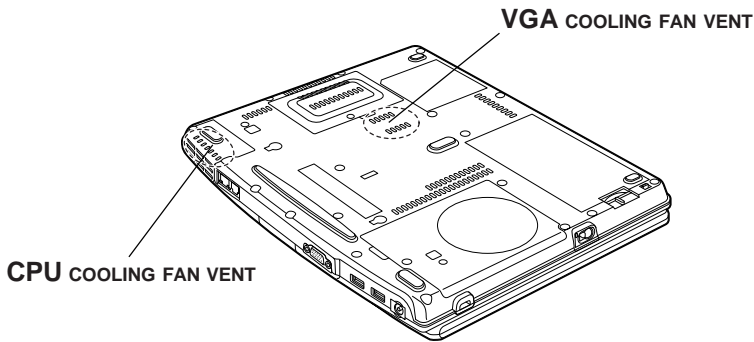

CPU cooling fan, VGA cooling fan and vents

Chapter 1

Introduction

Equipment checklist	1-1
Hardware	1-1
Software	1-1
Features	1-2
Special features	1-7
Utilities	1-9
Options	1-11

Introduction

This chapter provides an equipment checklist, and it identifies the computer's features, options and accessories.

***CAUTION:** Some of the features described in this manual may not function properly if you use an operating system that was not preinstalled by TOSHIBA.*

Equipment checklist

Hardware

Carefully unpack your computer. Save the box and packing materials for future use.

Check to make sure you have all the following items:

- Portégé M200 Portable Personal Computer
- Universal AC adaptor and power cord
- Modular cable
- Tablet PC Pen

***NOTE:** Tablet PC Pen is included in the carton of pen set with the product when purchased. Spare pen tip and draw-out tool are also included in the carton.*

Software

- The following software is preinstalled:
 - Microsoft® Windows XP Tablet PC Edition
 - TOSHIBA Modem driver
 - TOSHIBA Display driver
 - TOSHIBA Touch Pad driver
 - TOSHIBA Sound driver

- TOSHIBA Bluetooth drivers (Can be used only in Bluetooth models)
 - TOSHIBA Wireless LAN Driver
 - TOSHIBA Mobile Extension3
 - TOSHIBA Utilities
 - TOSHIBA Hotkey Utility for Display Devices
 - TOSHIBA Tablet Access code Logon Utility
 - TOSHIBA Zooming Utility
 - TOSHIBA Rotation Utility
 - TOSHIBA Accelerometer Utilities
 - TOSHIBA Power Saver
 - TOSHIBA Common Modules
 - TOSHIBA Console
 - TOSHIBA Config Free
 - TOSHIBA SD Memory Boot Utility
 - TOSHIBA Skins for Windows Media Player
 - SD card Driver Set
 - PC Diagnosis Tool
 - Online manual
 - Sensiva Symbol Commander
- Documentation:
- *Portégé M200 Portable Personal Computer User's Manual*
 - Microsoft Windows XP Tablet PC Edition manual package
 - *Instruction Manual for Safety & Comfort*
 - End User License Agreement
 - International Limited Warranty (ILW) Instruction
(This instruction is included only with computers sold in ILW supported areas.)
- Product Recovery CD-ROM (contains TOSHIBA Management Console, which is not preinstalled)

Features

The computer uses TOSHIBA's advanced Large Scale Integration (LSI), Complementary Metal-Oxide Semiconductor (CMOS) technology extensively to provide compact size, minimum weight, low power usage, and high reliability. This computer incorporates the following features and benefits:

Processor

Built-in The computer is equipped with an Intel®, which incorporates a math co-processor, a 32 KB level 1 cache memory and a 1MB level 2 cache memory. It also supports Enhanced Intel® SpeedStep™ technology.

Intel® Pentium® M processor 1.4 GHz

Intel® Pentium® M processor 1.5 GHz

Intel® Pentium® M processor 1.6 GHz

Intel® Pentium® M processor 1.7 GHz

***NOTE:** Some models of the computers carry Intel® Centrino™ technology, which is based on three separate technologies of Intel® Pentium® M, Intel® PRO/Wireless Network Connection, and Intel® 855 Chipset Family.*

Memory

Slot The slot accepts a 128, 256, 512 or 1,024 MB memory module can be installed in the two memory slots for a maximum of 2GB system memory.

Level 2 cache 1 MB level 2 cache is provided to maximize performance.

VideoRAM 32MB of RAM is provided for Video display

Disks

Built-in Hard disk

- 40 billion bytes (37.26 GB)
- 60 billion bytes (55.87 GB)
- 80 billion bytes (74.53 GB)



Display

The computer's LCD panel supports high-resolution video graphics. The screen can be set at a wide range of viewing angles for maximum comfort and readability.

Built-in 12.1" SXGA+ -TFT, 1400 horizontal × 1050 vertical pixels, up to 16 M colors

Graphics controller Graphics controller maximizes display performance. Refer to *Appendix B* for more information.

Keyboard

Built-in 84 keys or 85 keys, compatible with IBM® enhanced keyboard, embedded numeric overlay, dedicated cursor control,  and  keys. See Chapter 5, *The Keyboard*, for details.

Touch pad

Built-in A touch pad and control buttons in the palm rest enable control of the on-screen pointer and scrolling of windows.

Tablet PC Pen

Supplied A pen enables data entry directly through the display screen.

Reserve pen A pen enables data entry directly through the display screen. Supplied pen uses a pen instead of Supplied pen at the time of loss or breakage.

Power

Battery pack The computer is powered by one rechargeable lithium-ion battery pack.

RTC battery The internal RTC battery backs up the Real Time Clock (RTC) and calendar.

AC adaptor The universal AC adaptor provides power to the system and recharges the batteries when they are low. It comes with a detachable power cord. Because it is universal, it can receive a range of AC voltage between 100 and 240 volts.

Ports

Headphone Enables connection of a stereo headphone

Microphone Enables connection of a monaural microphone

Infrared The serial infrared port is compatible with Infrared Data Association (IrDA 1.1) standards. It enables cableless 4 Mbps, 1.152 Mbps, 115.2 kbps, 57.6 kbps, 38.4 kbps, 19.2 kbps or 9.6 kbps data transfer with IrDA 1.1 compatible external devices.

External monitor	15-pin, analog VGA port supports VESA DDC2B compatible functions.
Docking	Special port for connecting an Tablet Multi Dock.
Universal Serial Bus (USB 2.0)	The computer has two Universal Serial Bus ports that comply with the USB 2.0 standard, which enables data transfer speeds 40 times faster than the USB 1.1 standard. (The ports also support USB 1.1.)

Slots

PC card	A PC card slot accommodates one 5mm Type II card.
SD card	This slot lets you easily transfer data from devices, such as digital cameras and Personal Digital Assistants, that use SD card flash-memory. You can use memory module in this slot.

Multimedia

Sound System	Windows Sound System compatible sound system provides internal speaker as well as jacks for an external microphone and headphone.
--------------	---

Communications

Modem	An internal modem provides capability for data and fax communication. It supports V.90 (V.92). Refer to <i>Appendix E</i> . The speed of data transfer and fax depends on analog telephone line conditions. It has a modem jack for connecting to a telephone line. It is preinstalled as a standard device in some markets. Both of V.90 and V.92 are supported only in USA, Canada and Australia. Only V.90 is available in other regions.
LAN	The computer is equipped with a LAN card that supports Ethernet LAN (10 Mbit/s, 10BASE-T) and Fast Ethernet LAN (100 Mbit/s, 100BASE-TX). It is preinstalled as a standard device in some markets.

- Wireless LAN Some computers in this series are equipped with a wireless LAN mini-PCI card that is compatible with other LAN systems based on Direct Sequence Spread Spectrum/Orthogonal Frequency Division Multiplexing radio technology that complies with the IEEE802.11 Standard. The configuration of the built-in Wireless LAN depends on the model you purchased.(Revision B or G) Revision G support a data transfer rate up to 54 Mbit/s. Revision B support a data transfer rate up to 11 Mbit/s. Turbo Mode support a data transfer rate up to 108 Mbit/s.
- Wireless communication switch This switch turns the Wireless LAN and Bluetooth communication switchfunctions on and off.
- Bluetooth Some computers in this series are equipped with Bluetooth functions. Bluetooth wireless technology eliminates the need for cables between electronic devices such as computers and printers. Bluetooth provides fast, reliable, and secure wireless communication in a small space.

Security

- Security lock slot Connects an optional security lock to anchor the computer to a desk or other large object.

Software

- Operating System One of the following operating systems are Windows XP Tablet PC Edition. Refer to the *preinstalled software* section at the front of this chapter.
- TOSHIBA Utilities A number of utilities and drivers are preinstalled to make your computer more convenient to use. Refer to the *Utilities* section in this chapter.
- Plug and Play When you connect an external device to the computer or when you install a component, Plug and Play capability enables the system to recognize the connection and make the necessary configurations automatically.

Special features

The following features are either unique to TOSHIBA computers or are advanced features, which make the computer more convenient to use.

- | | |
|-----------------------------|---|
| Hot keys | Key combinations let you quickly modify the system configuration directly from the keyboard without running a system configuration program. |
| Keypad overlay | Gray keys with gray lettering make up the keypad overlay, which lets you use the keyboard for ten-key operations or cursor control. |
| Display automatic power off | This feature automatically cuts off power to the internal display when there is no keyboard input for a time specified. Power is restored when any key is pressed. You can specify the time in the <i>Turn off monitor</i> item of the <i>Power Save Mode</i> window in TOSHIBA Power Saver. |
| HDD automatic power off | This feature automatically cuts off power to the hard disk drive when it is not accessed for a time specified. Power is restored when the hard disk is accessed. You can specify the time in the <i>Turn off hard disks</i> item of the <i>Power Save Mode</i> window in TOSHIBA Power Saver. |
| System automatic power off | This feature automatically turns off power to the system when there is no input for a time specified. You can specify the time in the <i>System standby</i> or <i>System hibernate</i> item of the <i>System Power Mode</i> window in TOSHIBA Power Saver. |
| Battery save mode | This feature lets you save battery power. You can specify the Power Save Mode in the <i>Running on batteries</i> item of the <i>Power Save Modes</i> window in TOSHIBA Power Saver. |
| Power on password | Two levels of password security are available: supervisor and user. This feature prevents unauthorized access to your computer. |
| Instant security | A hot key function blanks the screen and disables the computer providing quick and easy data security. |

Advanced Instant Security	<p>This function is a utility (one of the acceleration sensor utilities) with the following functions.</p> <ul style="list-style-type: none"> <input type="checkbox"/> It performs from CrossMenu and PC is changed into a WorkStation lock state. <input type="checkbox"/> If PC is moved in the state of a WorkStation lock, beep sound will sound. Cancel a WorkStation lock, in order to stop beep sound. <input type="checkbox"/> If a WorkStation lock is canceled, a program will be ended automatically. 						
Panel power on/off	<p>This feature turns power to the computer off when the display panel is closed and turns it back on when the panel is opened. You can specify the setting in the <i>When I close the lid</i> item of the <i>System Power Mode</i> window in TOSHIBA PowerSaver.</p>						
Auto power on	<p>This feature lets you set a time and date for the computer to turn on automatically. The feature is useful for receiving remote communications while you are asleep or away. You can specify the setting in Scheduled Tasks.</p>						
Standby	<p>If you have to interrupt your work, you can turn off the power without exiting from your software. Data is maintained in the computer's main memory. When you turn on the power again, you can continue working right where you left off.</p>						
Hibernation	<p>This feature lets you turn off the power without exiting from your software. The contents of main memory are saved to the hard disk, when you turn on the power again, you can continue working right where you left off.</p>						
Heat dispersal	<p>To protect from overheating, the CPU has an internal temperature sensor. If the computer's internal temperature rises to a certain level, the cooling fan is turned on or the processing speed is lowered. Use the <i>Fan</i> item of the <i>Power Save Modes</i> window in TOSHIBA Power Saver.</p> <table border="0" style="margin-left: 20px;"> <tr> <td style="padding-right: 20px;">Maximum Performance</td> <td>Turns on fan first, then if necessary lowers CPU processing speed.</td> </tr> <tr> <td style="padding-right: 20px;">Performance</td> <td>Uses a combination of fan and lowering the CPU processing speed.</td> </tr> <tr> <td style="padding-right: 20px;">Battery optimized</td> <td>Lowers the CPU processing speed first, then if necessary turns on the fan.</td> </tr> </table>	Maximum Performance	Turns on fan first, then if necessary lowers CPU processing speed.	Performance	Uses a combination of fan and lowering the CPU processing speed.	Battery optimized	Lowers the CPU processing speed first, then if necessary turns on the fan.
Maximum Performance	Turns on fan first, then if necessary lowers CPU processing speed.						
Performance	Uses a combination of fan and lowering the CPU processing speed.						
Battery optimized	Lowers the CPU processing speed first, then if necessary turns on the fan.						

TOSHIBA Accelerometer Utilities When TOSHIBA Accelerometer Utilities is enabled, you can invoke the Start menu, switch active windows or launch predefined applications by shaking the computer vertically or horizontally, or tilting it. You can boot TOSHIBA Accelerometer Utilities from the menu bar as follows.
 [Start]-[All Programs]- [TOSHIBA]-[Tablet PC]-[Setting of TOSHIBA Accelerometer Utilities]
 The Setting of TOSHIBA Accelerometer Utilities screen appears.

Utilities

This section describes preinstalled utilities and tells how to start them. For details on operations, refer to each utility's online manual, help files or readme.txt files.

- TOSHIBA PowerSaver** To access this power savings management program, open the Control Panel, click Performance and Maintenance and click the TOSHIBA Power Saver icon.
- HW Setup** This program lets you customize your hardware settings according to the way you work with your computer and the peripherals you use. To start the utility, open the Control Panel, click Printers and Other Hardware and click the TOSHIBA HW Setup icon.
- Fn-esse** This Windows program lets you define your own “short-cut” keys to quickly launch applications and speed your work in Windows. To start the utility, click the Windows Start button, point to All Programs, point to TOSHIBA, point to Utilities and click Fn-esse.
- TOSHIBA Password Utility** The TOSHIBA Password Utility provides two levels of password security: User and Supervisor.
- Display Driver for Windows** The display driver enables simultaneous display on the internal LCD, and on an external computer monitor. To enable this function, use the Display Properties dialogue box.
- SymbolCommander** This software enables the user to run an application or to show home page by drawing a simple mark on the display with the Tablet PC Pen. You can customize the action to boot the computer and to run the application.

- Sound drivers A broad range of audio controls are available through the ADI sound driver, including Software Synthesize, Mic Volume, Noise Resudction and Audio Power Management. Click Control Panel and click SoundMAX icon to change the Mic Noise Reduction settings and the Power Management settings.
- For other sound settings, use the Windows Device Manager, Multimedia Panel or Volume Dial.
- TOSHIBA Accessibility This utility lets you make the Fn key sticky, that is, you can press it once, release it, and they press an “F number” key. The Fn key remains active until another key is pressed.
- TOSHIBA Mobile Extension3 This utility allows you to dock with or undock from a docker or port replicator, while your system is powered on, or while in Stand-by or Hibernation. Settings can be modified from the "TOSHIBA Mobile Extension3" icon in the TOSHIBA Console.
- Hot key utility This utility lets you display or hide a confirmation message when you press Fn + F3 or Fn + F4.
- TOSHIBA Tablet Access Code Logon Utility This utility allows you to logon to the system. If a password has been set, a dialog box with a prompt (e.g. **Password=**) appears when you turn the power on. If the system is in tablet mode, you can enter a password by clicking on keys of the soft keyboard with the Tablet PC Pen.
- TOSHIBA Zooming Utility This utility allows you to enlarge or reduce the text size on the Internet Explorer window and the icon size on the desktop.
- TOSHIBA Console TOSHIBA Console is a graphical user interface that provides easy access to help and services. It is the default function launched by the TOSHIBA Console button.
- PC Diagnosis Tool TOSHIBA PC Diagnostic Tool displays the basic in formation on PC, and the test of built-in devices can also be performed. You can boot TOSHIBA PC Diagnostic Tool form the menu bar as follows.
- [Start]-[All Programs]-[TOSHIBA]-[Utilities]-[PC Diagnostic Tool]

Bluetooth TOSHIBA Stack This software enables communication between remote Bluetooth devices. Refer to the *Quick Start Guide*.

NOTE: *Bluetooth cannot be used in models that do not have a Bluetooth module installed.*

TOSHIBA ConfigFree TOSHIBA ConfigFree is a suite of utilities to allow easy control of communication device and network connections. TOSHIBA ConfigFree also allows you to find communication problems and create profiles for easy switching between location and communication networks. You can boot TOSHIBA ConfigFree from the menu bar as follows.

[Start]-[All Programs]-[TOSHIBA]-[Networking]-[ConfigFree]

TOSHIBA SD Memory Boot Utility The TOSHIBA SD memory boot utility is a utility which can create SD memory card to a boot disk. You can boot TOSHIBA SD Memory Boot Utility from the menu bar as follows.

[Start]-[All Programs]-[TOSHIBA]-[Utility]-[SD Memory Boot Utility]

Dragon Drop CD+DVD The setup image for Drag'n Drop CD+DVD is located in C:\TOSHIBA. Before using it, please execute the "Setup.exe" for installation. However, you can only use Drag'n Drop CD+DVD with the following drives:

- The CD/DVD recordable drives which can connect to the slim select bay of Tablet Multi Dock
- External CD-RW/DVD-ROM Drive (PA3352x)

Options

You can add a number of options to make your computer even more powerful and convenient to use. The following options are available:

Memory expansion A 128, 256, 512 or 1,024 MB memory module (PC2700 DDR) can easily be installed in the computer.

Battery Pack An addition Battery Pack can be purchased from your TOSHIBA dealer. The Battery Pack is identical to the one that came with your computer. Use it as a spare or replacement.

- | | |
|--------------------------------|--|
| Universal AC Adaptor | If you use your computer at more than one site, it may be convenient to purchase an additional Universal AC Adaptor (PA3282,PA3283) for each site so you will not have to carry the adaptor with you. |
| USB FDD Kit | A 3 1/2" diskette drive accommodates 1.44-megabyte or 720-kilobyte diskettes. It connects to a USB port. (You cannot format 720-kilobyte diskettes on Windows XP, but you can use previously formatted disks.) |
| Battery Charger | The Battery Charger lets you charge extra batteries outside the computer. |
| Security locks | The slots are available to attach a security cable to the computer to deter theft. |
| Tablet Multi Dock | The Tablet Multi Dock provides the ports available on the computer in addition to separate lineout jack, External monitor port, Universal Serial Bus port × 3, LAN jack and Slim Select Bay module. |
| Wireless LAN Kit | This option enables Wireless LAN functions in computer that does not have preinstalled Wireless LAN. It is installed by dealers only. |
| Bluetooth Kit | This option enables Bluetooth wireless communications in computer that does not have preinstalled Bluetooth. It is installed by dealers only. |
| Tablet PC Pen | Tablet PC Pen can be purchased from your TOSHIBA dealer. Use it as a spare to your computer. Spare pen tip and draw-out tool are included. |
| Reserve pen | Tablet PC Pen can be purchased from your TOSHIBA dealer. Supplied pen uses a pen instead of Supplied pen at the time of loss or breakage. The pen is set inside the computer, which connects a battery pack. |
| DVD-ROM Drive | DVD-ROM Drive is available as an optional external optical disk drive. You can buy the drive from TOSHIBA dealer. |
| External CD-RW/
DVD-RW | External CD-RW/DVD-RW is an optional accessory compatible with USB 2.0 port on this computer. You can buy the drive from TOSHIBA dealer. |
| Bluetooth SD card ² | Bluetooth SD card is an optional accessory compatible with the SD Card slot of this computer. You can buy the drive from TOSHIBA dealer. |

Chapter 2

The Grand Tour

Front with the display closed	2-1
Left side	2-2
Right side	2-3
Back side	2-4
Underside	2-5
Front with the display open	2-7
Indicators	2-9
AC adaptor	2-12

The Grand Tour

This chapter identifies the various components of your computer. Become familiar with each component before you operate the computer.

Front with the display closed

Figure 2-1 shows the computer's front with its display panel in the closed position.

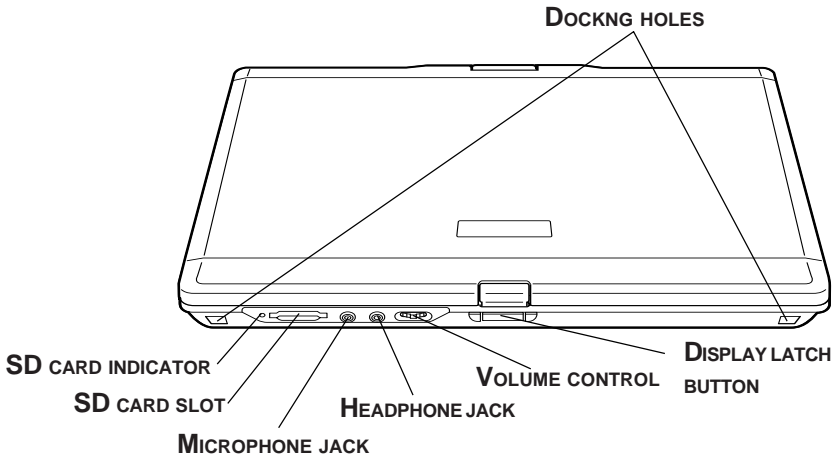

Figure 2-1 Front of the computer with the display closed

Microphone jack



A standard 3.5 mm mini microphone jack enables connection of a monaural microphone or other device for audio input.

Headphone jack



A standard 3.5 mm mini headphone jack enables connection of a stereo headphones (16 ohm minimum) or other device for audio output. When you connect headphones, the internal speaker is automatically disabled.

Volume control



Use this dial to adjust the volume of the speaker.

SD card slot  This slot lets you transfer data from the device to your computer.

CAUTION: Keep foreign objects out of the SD card slot. A pin or similar object can damage the computer's circuitry.

SD card indicator This indicator glows green when the computer is accessing the SD card slot.

Display latch button The latch mechanism secures the LCD panel in its closed position. Push the Display latch button to release the latch to open the display.

Docking holes These holes ensure a proper connection between the computer and an option Dock.

Left side

Figure 2-2 shows the computer's left side.

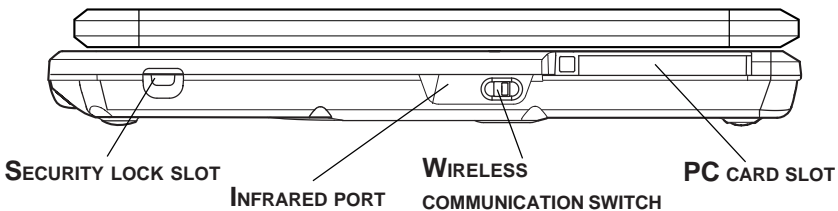



Figure 2-2 The left side of the computer

Security lock slot  A security cable is attached to this slot. The optional security cable anchors your computer to a desk or other large object to deter theft.

PC card slot  A PC card slot can accommodate one 5 mm PC card (Type II). The slot supports 16-bit PC cards and CardBus PC cards.

CAUTION: Keep foreign objects out of the PC card slot. A pin or similar object can damage the computer's circuitry.

Wireless communication switch

Slide this switch to the left to turn on Bluetooth and Wireless LAN. Slide it to the right to turn off the functions.



CAUTION: Set the switch to off in airplanes and hospitals. Check the wireless communication indicator. It will stop glowing when the wireless communication function is off.

Infrared port



This infrared port is compatible with Infrared Data Association (IrDA 1.1) standards. It enables cable less 4 Mbps, 1.152 Mbps, 115.2 kbps, 57.6 kbps, 38.4 kbps, 19.2 kbps or 9.6 kbps data transfer with IrDA 1.1 compatible external devices.

Right side

Figure 2-3 shows the computer's right side.

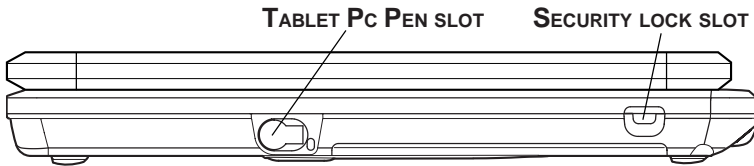

Figure 2-3 The right side of the computer

Tablet PC Pen

Pen is contained in the right hand side. A pen enables data entry directly through display screen. Refer to the *Using the Tablet PC Pen* section Chapter 4, *Operating Basics*.

Tablet PC Pen slot

This Tablet PC pen slot is contained of a Tablet PC pen.

Security lock slot



A security cable is attached to this slot. The optional security cable anchors your computer to a desk or other large object to deter theft.

Back side

Figure 2-4 shows the computer's back side.

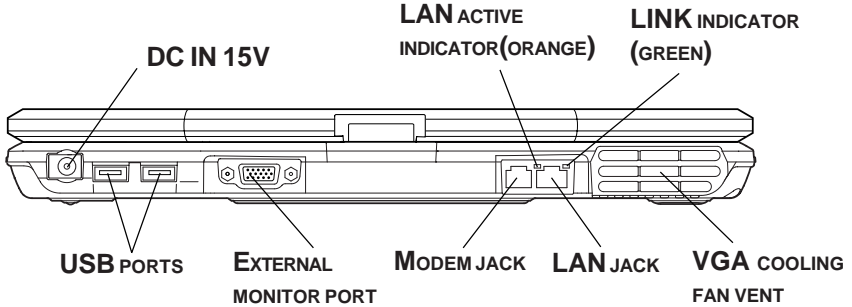
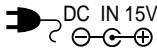

Figure 2-4 The computer's back side

VGA cooling fan vent This cooling fan in takes air to cool VGA.

CAUTION: Be careful not to block the fan vent. Also be careful to keep foreign objects out of the vent. A pin or similar object can damage the computer's circuitry.

DC IN 15V The AC adaptor is connected to this socket. Use only the model of AC adaptor that comes with the computer. Using the wrong adaptor can damage your computer.



External monitor port This 15-pin port lets you connect an external monitor.



Universal Serial Bus (USB 2.0) port Two Universal Serial Bus ports are on the back side. The ports comply with the USB 2.0 standard, which enables data transfer speeds 40 times faster than the USB 1.1 standard. (The ports also support USB 1.1.)



CAUTION: Keep foreign objects out of the USB connectors. A pin or similar object can damage the computer's circuitry.

LAN jack

This jack lets you connect to a LAN. The adaptor has built-in support for Ethernet LAN (10 megabits per second, 10BASE-T) and Fast Ethernet LAN (100 megabits per second, 100BASE-Tx).

LAN active indicator (orange)

This indicator glows in yellow when data is being exchanged between the computer and the LAN.

Link indicator (green)

This indicator glows in green when the computer is connected to a LAN and the LAN is functioning properly.

Modem jack

In areas where an internal modem is installed as standard equipment, there is a modem jack that lets you use a modular cable to connect the modem directly to a telephone line. The modem is not supported in some marketing regions.

- CAUTIONS:**
1. *In case of a lightning storm, unplug the modem cable from the telephone jack.*
 2. *Do not connect the modem to a digital telephone line. A digital line will damage the modem.*

Underside

Figure 2-5 shows the underside of the computer. Make sure the display is closed before turning over your computer.

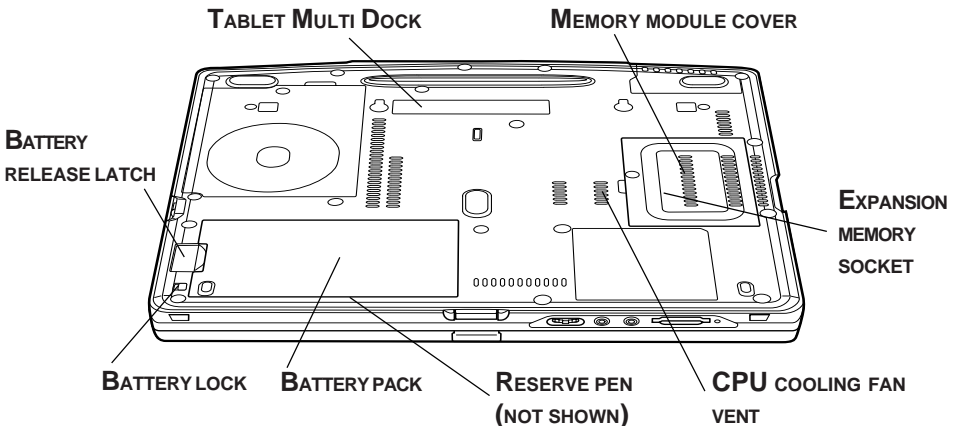

Figure 2-5 The underside of the computer

Tablet Multi Dock Use this port to connect an optional Tablet Multi Dock.



CAUTION: Keep foreign objects out of the docking port. A pin or similar object can damage the computer's circuitry.

Expansion memory socket The computer is equipped with two expansion memory slots (sockets). Use these slots (sockets) to install memory module to increase your computer's memory. Refer to the *Memory expansion* section in Chapter 8, *Optional Devices* for the detail.



Battery Pack The Battery Pack powers the computer when the AC adaptor is not connected. The *Battery types* section in Chapter 6, *Power and Power-Up Modes*, describes how to access the Battery Pack. Battery Packs can be purchased from your TOSHIBA dealer to extend the computer's battery operating time.

Battery lock The battery lock prevents inadvertent release of the Battery Pack.



Battery release latch Releasing the battery lock and sliding the Battery release latch to the outside of the computer enables to remove the battery from the computer.



Reserve pen Pen is contained in the battery pack of Underside. A pen enables data entry directly through display screen. Refer to the *Using the Tablet PC Pen* section in Chapter 4, *Operating Basics*.

CPU cooling fan vent This cooling fan in takes air to cool CPU.

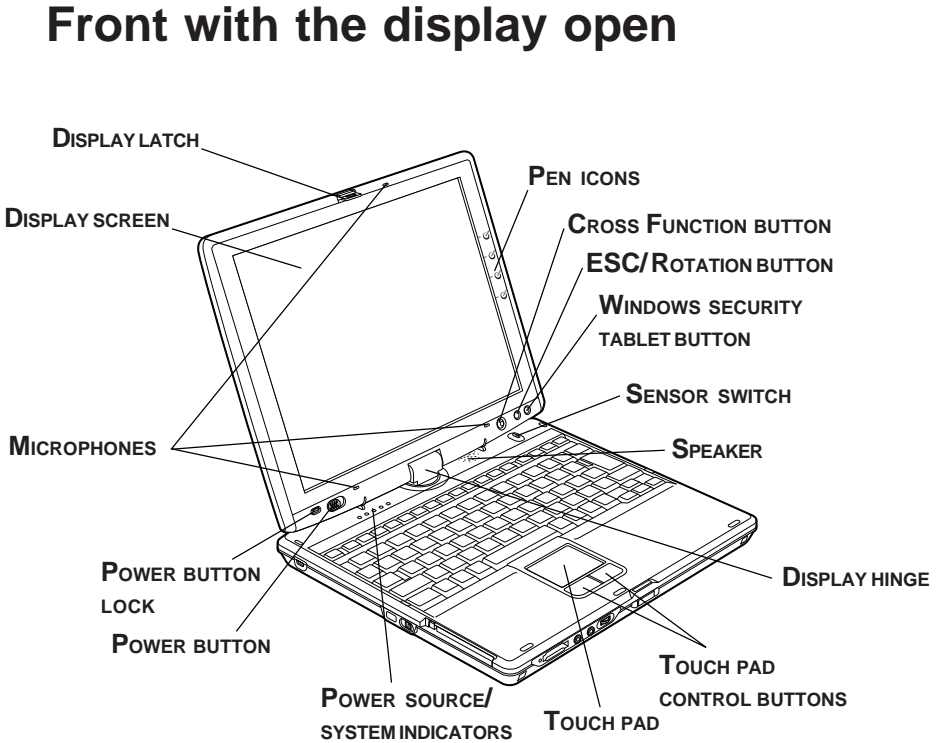

Figure 2-6 The front with the display open

- Display latch** The Display latch secures the Display screen in its closed position. The latch can be rotated to lock the Display screen in the tablet mode.
- Display screen** The full-color LCD displays high-contrast text and graphics and is compatible with the industry standard Video Graphics Array (VGA). The LCD consists of up to SXGA 1400 × 1050 pixels or dots. The computer has a Thin-Film Transistor (TFT) display. Refer to *Appendix B*.

When the computer operates on power through the AC adaptor, the display screen's image will be somewhat brighter than when it operates on battery power. The lower brightness level is intended to save battery power.

Display hinge The display hinge holds the display screen at easy-to-view angles.

Microphones A built-in microphones can be used to record stereo sounds into your application.

Power button Slide the power button to turn the computer's power on and off.



Power button lock Set this lock to the locked position to prevent inadvertent power on or off.



Power source/system indicators LEDs let you monitor the status of various computer functions. Details are given in the *Indicators* section.

Sensor switch This switch shuts down the computer when you close the cover in laptop mode and the panel power on/off feature is enabled. This switch does not shut down the computer when operating in tablet mode.

Touch pad A Touch pad located in the center of the palm rest is used to control the on-screen pointer. Refer to the *Using the Touch pad* section in Chapter 4, *Operating Basics*.

Touch pad control buttons Control buttons close to the Touch pad let you select menu items or manipulate text and graphics designated by the on-screen pointer.

Windows Security tablet button This button functions as the same to Ctrl + Alt + Del keys to show Windows Task Manager.







Cross Function button This button functions as the same to Enter key when tapped, or shows the menu screen when pressed for more than a second.



Speaker The speaker emits sound generated by your software as well as audio alarms, such as low battery condition, generated by the system.

ESC/Rotation button Press this button more than one second to change the orientation of the screen. This button also functions as ESC. When Rotation Utility is running, the top and bottom of the screen are automatically recognized to change the orientation by pressing this button.



- Pen Icons** The four icons on the right of the display allow you to run an application or perform other operations such as holding down the Shift key or the Ctrl key by tapping an icon with the pen.
- Pen Button 1** Tapping this icon will run Office OneNote. If Office OneNote is already running, tapping this icon is equivalent to pressing **Ctrl + C** (copy).
- 
- Pen Button 2** Tapping this icon will change the system into Multi Monitor mode that is useful for presentation. If Office OneNote is already running, tapping this icon is equivalent to pressing **Ctrl + X** (cut).
- 
- Pen Button 3** Tapping this icon is equivalent to holding down the Shift key. If Office OneNote is already running, tapping this icon is equivalent to pressing **Ctrl + V** (paste).
- 
- Pen Button 4** Tapping this icon is equivalent to holding down the Ctrl key. If Office OneNote is already running, pressing this icon is equivalent to pressing **Ctrl + Z** (undo).
- 

Indicators

Figure 2-7 shows the indicators, which light when various computer operations are in progress.

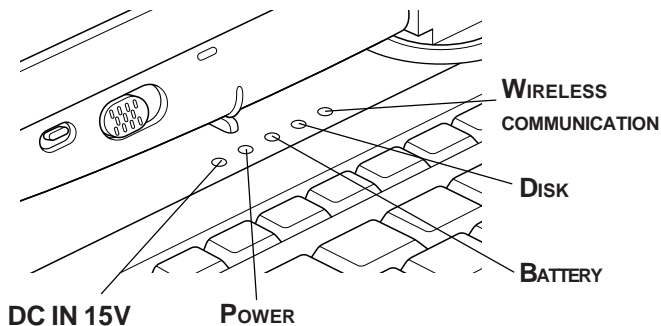

Figure 2-7 The power source/system indicators(laptop mode)

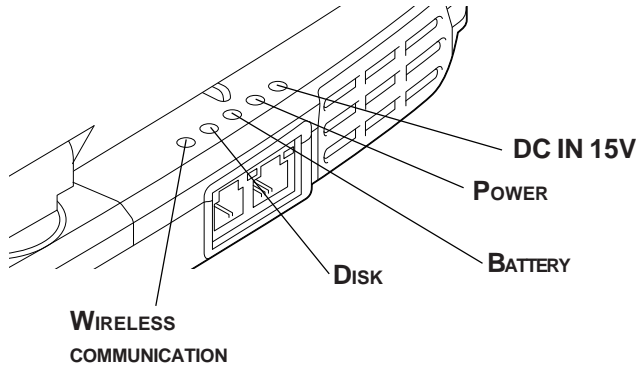







Figure 2-8 The power source/system indicators (tablet mode)

Power source/system indicators

- | | |
|--|---|
| <p>DC IN 15V</p>  | <p>The DC IN 15V indicator glows green when DC power is supplied from the AC power adaptor. If the adaptor's output voltage is abnormal or if the power supply malfunctions, this indicator flashes in orange.</p> |
| <p>Power</p>  | <p>The Power indicator glows green when the computer is on. If you turn off the computer in Resume mode, this indicator blinks orange (one second on, two seconds off) while the computer shuts down.</p> |
| <p>Battery</p>  | <p>The Battery indicator shows the condition of the charge. Green means fully charged and orange means being charged. Refer to Chapter 6, <i>Power and Power-Up Modes</i>.</p> |
| <p>Disk</p>  | <p>The Disk indicator glows in green when the computer is accessing a disk drive.</p> |
| <p>Wireless communication</p>  | <p>The Wireless communication indicator lights when the Bluetooth and Wireless LAN functions are turned on.</p> |

The figures below show the positions of the keypad overlay indicators and the CapsLock indicator.

When the F10 key indicator glows, the keypad overlay lets you control the cursor. When the F11 key indicator glows, the keypad overlay lets you enter numbers.

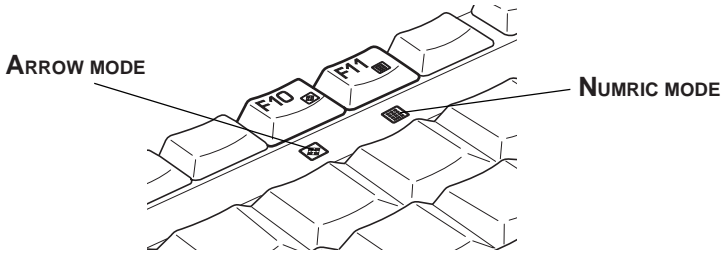

Figure 2-9 Keypad overlay indicators

When the CapsLock indicator glows, the keyboard is in all-caps mode.

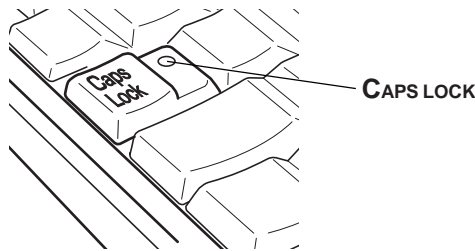

Figure 2-10 CapsLock indicator

Keyboard indicator

CapsLock This indicator glows green when the alphabet keys are locked in uppercase.

Arrow mode When the **Arrow mode** indicator lights green, you can use the keypad overlay (white labeled keys) as cursor keys. Refer to the *Keypad overlay* section in Chapter 5, *The Keyboard*.



Numeric mode You can use the keypad overlay (white labeled keys) for numeric input when the **Numeric mode** indicator lights green. Refer to the *Keypad overlay* section in Chapter 5, *The Keyboard*.



AC adaptor

The AC adaptor converts AC power to DC power and reduces the voltage supplied to the computer. It can automatically adjust to any voltage from 100 to 240 volts and to a frequency of either 50 or 60 hertz, enabling you to use the computer in almost any region.

To recharge the battery, simply connect the AC adaptor to a power source and the computer. See Chapter 6 *Power and Power-Up Modes* for details.

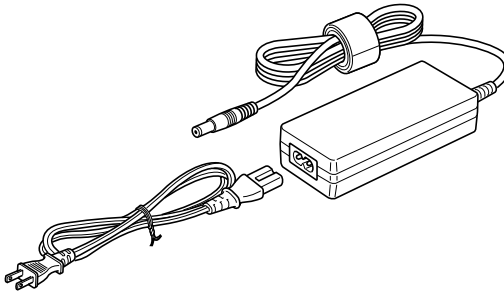

Figure 2-11 The AC adaptor

CAUTION: Use only the AC adaptor that came with the computer or an equivalent optional adaptor. Use of the wrong adaptor could damage your computer. TOSHIBA assumes no liability for any damage in such case.

Chapter 3

Getting Started

Setting up your work space	3-2
General conditions	3-2
Placement of computer	3-3
Seating and posture	3-3
Lighting	3-4
Work habits	3-4
Operating the computer in tablet mode	3-5
Connecting the AC adaptor	3-6
Opening the display	3-8
Turning on the power	3-9
Starting up for the first time	3-10
Turning off the power	3-10
Shut Down mode (Boot mode)	3-10
Hibernation mode	3-11
Standby mode	3-13
Restarting the computer	3-15
Restoring the preinstalled software from the Product Recovery CD-ROM	3-15

Getting Started

This chapter provides basic information to get you started using your computer. It covers the following topics:

- ❑ Setting up your work space — for your health and safety

***NOTE:** Be sure also to read Instruction Manual for Safety & Comfort. This guide, which is included with the computer, explains product liability.*

- ❑ Opening the computer in tablet mode
- ❑ Connecting the AC adaptor
- ❑ Opening the display
- ❑ Turning on the power
- ❑ Starting up for the first time
- ❑ Turning off the power
- ❑ Restarting the computer
- ❑ Restoring the preinstalled software from the product recovery CD-ROM

***NOTE:** All users should be sure to carefully read the sections turning on the power.*

Setting up your work space

Establishing a comfortable work site is important for you and your computer. A poor work environment or stressful work habits can result in discomfort or serious injury from repetitive strain to your hands, wrists or other joints. Proper ambient conditions should also be maintained for the computer's operation. This section discusses the following topics:

- General conditions
- Placement of the computer and peripheral devices
- Seating and posture
- Lighting
- Work habits

General conditions

In general, if you are comfortable, so is your computer, but read the following to make sure your work site provides a proper environment.

- Make sure there is adequate space around the computer for proper ventilation.
- Make sure the AC power cord connects to an outlet that is close to the computer and easily accessible.
- The temperature should be 5 to 35 degrees Centigrade (41 to 95 degrees Fahrenheit) and the relative humidity should be 20 to 80 percent.
- Avoid areas where rapid or extreme changes in temperature or humidity may occur.
- Keep the computer free of dust, moisture, and exposure to direct sunlight.
- Keep the computer away from heat sources, such as electric heaters.
- Do not use the computer near liquids or corrosive chemicals.
- Do not place the computer near objects that create strong magnetic fields (e.g., stereo speaker).
- Do not operate the computer in close proximity to a mobile phone.
- Leave ample ventilation room for the fan. Do not block the vents.

Placement of computer

Position the computer and peripheral devices to provide comfort and safety.

- ❑ Set the computer on a flat surface at a comfortable height and distance. The display should be no higher than eye level to avoid eye strain.
- ❑ Place the computer so that it is directly in front of you when you work and make sure you have adequate space to easily operate other devices.
- ❑ Allow adequate space behind the computer to let you freely adjust the display. The display should be angled to reduce glare and maximize visibility.
- ❑ If you use a paper holder, set it at about the same height and distance as the computer.

Seating and posture

The height of your chair in relation to the computer and keyboard as well as the support it gives your body are primary factors in reducing work strain. Refer to the following tips and to figure 3-1.

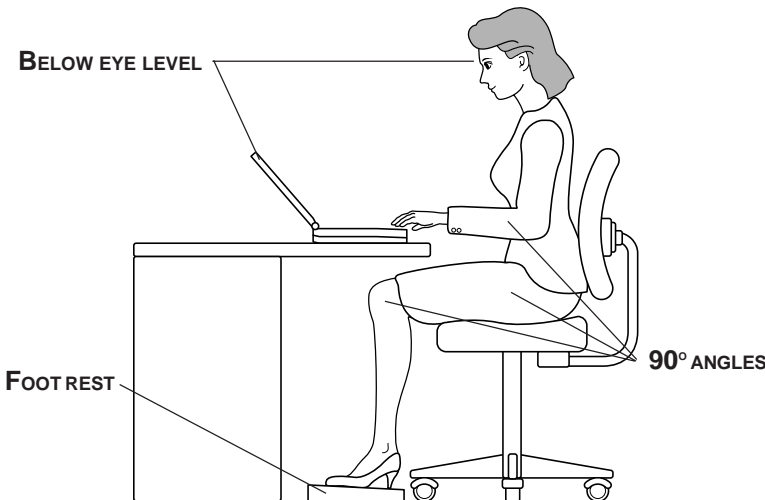

Figure 3-1 Posture and positioning of the computer

- ❑ Place your chair so that the keyboard is at or slightly below the level of your elbow. You should be able to type comfortably with your shoulders relaxed.

- Your knees should be slightly higher than your hips. If necessary, use a foot rest to raise the level of your knees to ease pressure on the back of your thighs.
- Adjust the back of your chair so it supports the lower curve of your spine.
- Sit straight so that your knees, hips and elbows form approximately 90 degree angles when you work. Do not slump forward or lean back too far.

Lighting

Proper lighting can improve legibility of the display and reduce eye strain.

- Position the computer so that sunlight or bright indoor lighting does not reflect off the screen. Use tinted windows, shades or other screen to eliminate sun glare.
- Avoid placing the computer in front of bright light that could shine directly in your eyes.
- If possible, use soft, indirect lighting in your computer work area. Use a lamp to illuminate your documents or desk, but be sure to position the lamp so that it does not reflect off the display or shine in your eyes.

Work habits

A key to avoiding discomfort or injury from repetitive strain is to vary your activities. If possible, schedule a variety of tasks into your work day. If you must spend long periods at the computer, finding ways to break up the routine can reduce stress and improve your efficiency.

- Sit in a relaxed posture. Good positioning of your chair and equipment as described earlier can reduce tension in your shoulders or neck and ease back strain.
- Vary your posture frequently.
- Occasionally stand up and stretch or exercise briefly.
- Exercise and stretch your wrists and hands a number of times during the day.
- Frequently, look away from the computer and focus your eyes on a distant object for several seconds, for example 30 seconds every 15 minutes.
- Take frequent short breaks instead of one or two long breaks, for example, two or three minutes every half hour.
- Have your eyes examined regularly and visit a doctor promptly, if you suspect you might be suffering from a repetitive strain injury.

A number of books are available on ergonomics and repetitive strain injury or repetitive stress syndrome. For more information on these topics or for pointers on exercises for such stress points as hands and wrists, please check with your library or book vendor. Also refer to the computer's *Instruction Manual for Safety & Comfort*.

Operating the computer in tablet mode

NOTE: TOSHIBA Portégé M200 computer can be used in two ways; ordinary laptop PC and tablet PC. You can use the computer as tablet PC that is operated with attached Tablet PC Pen by turning LCD panel in 180 degrees and closing it. This manual calls the use as an ordinary laptop PC as laptop mode, and the use as tablet PC as tablet mode. Refer to Changing to the Tablet mode section in Chapter 4, Operating Basic for the changing of the mode.

When operating the computer in tablet mode, follow the instructions below.

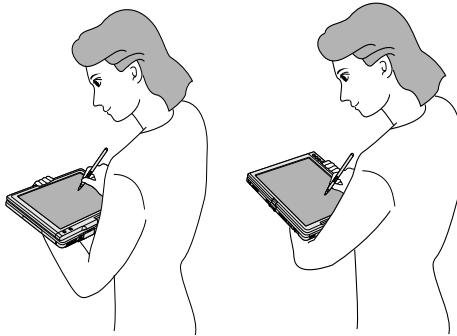

Figure 3-2 Operating the computer in tablet mode

- Hold the computer firmly on your forearm. Do not block the vent.
- Remove the connector of AC adapter from the computer when using the computer in tablet mode held in your forearm.
- Do not use the computer while walking or driving a car.

- ❑ Change to laptop mode and turn off the computer before carrying. Do not carry the computer with power on or in stand by state. Do not carry the computer while DISK LED is glowing.
- ❑ Do not expose the computer with rapid temperature change (such as the case to bring the PC from cold outside into warm room).
When rapid temperature change is unavoidable, turn on the computer after a couple of hours. Avoid dew condensation.
- ❑ Remove all external peripheral devices and their connection cables from the computer before carrying.
- ❑ Do not drop the computer nor apply excessive impact on the computer. Do not leave the computer in an automobile where the computer is exposed to direct sunbeam.
- ❑ Do not put the computer in tablet mode in a bag.

CAUTION: Do not block the vent of the computer when holding it in your forearm to use in tablet mode. If you maintain to expose your skin to the hot air released from the vent for a long time, your skin might suffer low temperature injury.

Connecting the AC adaptor

Attach the AC adaptor when you need to charge the battery or you want to operate from AC power. It is also the fastest way to get started, because the Battery Pack will need to be charged before you can operate from battery power.

The AC adaptor can be connected to any power source supplying from 100 to 240 volts and 50 or 60 hertz. For details on using the AC adaptor to charge the Battery Pack, refer to Chapter 6, *Power and Power-Up Modes*.

WARNING: Use only the AC adaptor supplied as an accessory. Other AC adaptors have different voltage and terminal polarities and use of them may produce heat and smoke or even result in fire or rupture.

- CAUTIONS:**
1. Use only the AC adaptor supplied with your computer or an equivalent adaptor that is compatible. Use of any incompatible adaptor could damage your computer. TOSHIBA assumes no liability for any damage caused by use of an incompatible adaptor.
 2. When you connect the AC adaptor to the computer, always follow the steps in the exact order as described in the User's Manual. Connecting the power cable to a live electrical outlet should be the last step otherwise the adaptor DC output plug could hold an electrical charge and cause an electrical shock or minor bodily injury when touched. As a general safety precaution, avoid touching any metal parts.

1. Connect the power cord to the AC adaptor.

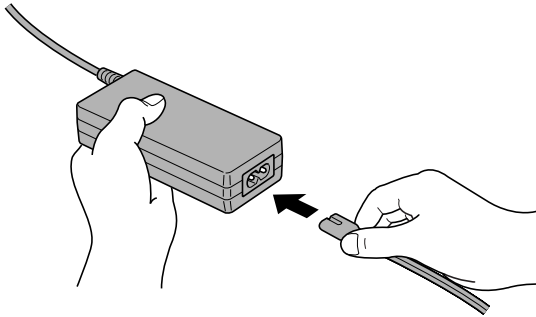

Figure 3-3 Connecting the power cord to the AC adaptor

2. Connect the AC adaptor's DC output plug to the **DC IN 15V** port on the back of the computer.

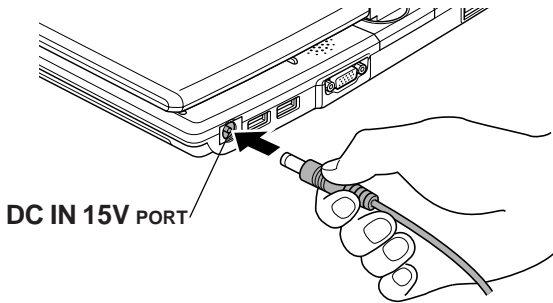

Figure 3-4 Connecting the adaptor to the computer

3. Plug the power cord into a live wall outlet. The **Battery** and **DC IN 15V** indicator on the front of the computer should glow.

Opening the display

The display panel can be rotated in a wide range of angles for optimal viewing.

1. Push down the display latch on the front of the computer to unlatch the display panel.
2. Lift the panel up and adjust it to the best viewing angle for you.

CAUTION: *User reasonable care when opening and closing the display panel. Opening it vigorously or slamming it shut could damage the computer.*

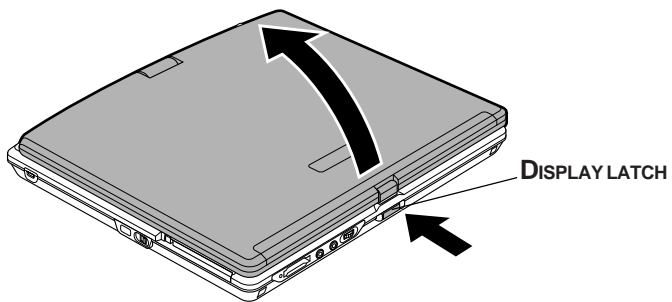

Figure 3-5 Opening the display panel

Turning on the power

This section describes how to turn on the power.

NOTE: After you turn on the power for the first time, do not turn it off until you have set up the operating system. Refer to the section *Starting up for the first time* in this chapter.

1. If the external diskette drive is connected, make sure it is empty. If a diskette is in the drive, press the eject button and remove the diskette.
2. Open the display panel.
3. Slide the power button lock toward the up of the computer to unlock the button, then slide the button toward the right.

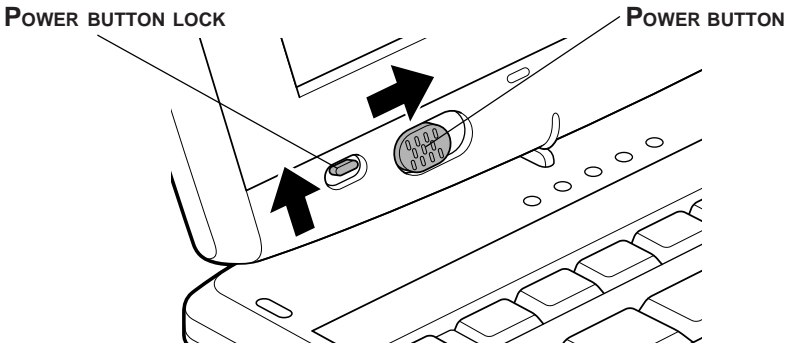

Figure 3-6 Turning on the power

Starting up for the first time

When you first turn on the power, the computer's initial screen is the Microsoft Windows XP Tablet PC Edition Startup Screen Logo. Follow the on-screen directions for each screen. During setup, you can click the **Back** button to return to the previous screen.

Be sure to read the **Windows End User License Agreement** display carefully.

- NOTES:**
1. You cannot use the Tablet PC Pen when Windows is in Setup. Use keyboard or touch pad while Windows is setting up.
 2. Be sure to read the License Agreement carefully.

Turning off the power

The power can be turned off in one of the following modes: Shut down (Boot), Hibernation or Standby mode.

Shut Down mode (Boot mode)

When you turn off the power in Shut Down mode, no data is saved and the computer will boot to the operating system's main screen.

1. If you have entered data, save it to the hard disk or to a diskette.
2. Make sure all disk activity has stopped, then remove any CD/DVD-ROMs or diskette.

CAUTION: Make sure the **Disk** indicators is off. If you turn off the power while a disk is being accessed, you can lose data or damage the disk.

3. Click **start** then click **Turn off computer**. From the **Turn off computer** menu select, click **Turn off**.
4. Turn off the power to any peripheral devices.

CAUTION: Do not turn the computer or devices back on immediately. Wait a moment to let all capacitors fully discharge.

Hibernation mode

The hibernation feature saves the contents of memory to the hard disk when the computer is turned off. The next time the computer is turned on, the previous state is restored. The hibernation feature does not save the status of peripheral devices.

- CAUTIONS:**
1. *Save your data. While entering hibernation mode, the computer saves the contents of memory to the HDD. However, for safety sake, it is best to save your data manually.*
 2. *Data will be lost if you remove the battery or disconnect the AC adaptor before the save is completed. Wait for the **Disk** indicator to go out.*
 3. *Do not install or remove a memory module while the computer is in hibernation mode. Data will be lost.*

Benefits of hibernation

The hibernation feature provides the following benefits:

- Saves data to the hard disk when the computer automatically shuts down because of a low battery.

NOTE: *For the computer to shut down in hibernation mode, the hibernation feature must be enabled in two places in TOSHIBA Power Saver: the Hibernate window and the Battery Alarm item of the Alarm window. Otherwise, the computer will shut down in Standby mode. If battery power becomes depleted, data saved in Standby mode will be lost.*

- You can return to your previous working environment immediately when you turn on the computer.
- Saves power by shutting down the system when the computer receives no input or hardware access for the duration set by the system hibernate feature.
- You can use the panel power off feature.

Starting Hibernation

***NOTE:** You can also enable Hibernation by pressing **Fn + F4**. See Chapter 5, The Keyboard for details.*

To enter Hibernation mode, follow the steps below.

1. Click **start**.
2. Select **Turn Off Computer**.
3. Open the **Turn Off Computer** dialog box. **Hibernate** is not displayed.
4. Press the **Shift** key. The **Standby** item will change to **Hibernate**.
5. Select **Hibernate**.

Automatic Hibernation

The computer will enter Hibernate mode automatically when you slide the power button or close the lid. First, however, make the appropriate settings according to the steps below.

1. Open the **Control Panel**.
2. Open **Performance and Maintenance** and open **Power Options**.
3. Select the **Hibernate** window in the **Power Options Properties**, select the **Enable hibernation** check box and click the **Apply** button.
4. Open **TOSHIBA Power Saver**.
5. Select the **Setup Action** window.
6. Enable the desired Hibernation settings for **When I slide the power button** and **When I close the lid**.
7. Click the **OK** button.

Data save in hibernation mode

When you turn off the power in hibernation mode, the computer takes a moment to save current memory data to the hard disk. During this time, the **Disk** indicator will light.

After you turn off the computer and memory is saved to the hard disk, turn off the power to any peripheral devices.

***CAUTION:** Do not turn the computer or devices back on immediately. Wait a moment to let all capacitors fully discharge.*

Standby mode

If you have to interrupt your work, you can turn off the power without exiting from your software. Data is maintained in the computer's main memory. When you turn on the power again, you can continue working right where you left off.

- NOTES:**
- 1. When the AC adaptor is connected, the computer will go into Standby mode according to the settings in the TOSHIBA Power Saver utility.*
 - 2. To restore operation from Standby mode, slide the power button or press any key. The latter action works only if Wake-up on Keyboard is enabled in HW Setup.*
 - 3. If the computer automatically enters Standby mode while a network application is active, the application might not be restored when the computer wakes up from Standby.*
 - 4. To prevent the computer from automatically entering Standby mode, disable Standby in TOSHIBA Power Saver. That action, however, will nullify the computer's Energy Star compliance.*

- CAUTIONS:**
- 1. Before entering Standby mode, be sure to save your data.*
 - 2. Do not install or remove a memory module while the computer is in standby mode. The computer or the module could be damaged.*
 - 3. Do not remove the battery pack while the computer is in standby mode (unless the computer is connected to an AC power source). Data in memory will be lost.*
 - 4. If you carry the computer on board an aircraft or into a hospital, be sure to shut down the computer in hibernation mode or in shutdown mode to avoid radio signal interference.*

Benefits of standby

The standby feature provides the following benefits:

- ❑ Restores the previous working environment more rapidly than does hibernation.
- ❑ Saves power by shutting down the system when the computer receives no input or hardware access for the duration set by the System Standby feature.
- ❑ You can use the panel power off feature.

Executing standby

*NOTE: You can also enable Standby by pressing **Fn + F3**. See Chapter 5, The Keyboard, for details.*

You can enter standby mode in one of three ways:

1. Click **Start**, click **Turn Off Computer** and click **Stand by**.
2. Close the display panel. This feature must be enabled. Refer to the *System Power Mode* item in *TOSHIBA Power Saver Utility* described in the Control Panel.

Open **Performance and Maintenance** and open **TOSHIBA Power Saver**.

3. Slide the power button. This feature must be enabled. Refer to the *System Power Mode* item in *TOSHIBA Power Saver Utility* described in the Control Panel.

When you turn the power back on, you can continue from where you left when you shut down the computer.

NOTES: 1. When the computer is shut down in standby mode, the power indicator flashes in orange.

2. *If you are operating the computer on battery power, you can lengthen the operating time by shutting down in hibernation mode. Standby mode consumes more power.*

Standby limitations

Standby will not function under the following conditions:

- Power is turned back on immediately after shutting down.
- Memory circuits are exposed to static electricity or electrical noise.

Restarting the computer

Certain conditions require that you reset the system. For example, if:

- You change certain computer settings.
- An error occurs and the computer does not respond to your keyboard commands.

There are three ways to restart the computer system:

1. Press **Ctrl + Alt + Del** or Windows Security tablet button to display the **Windows Task Manager**, then select **Shutdown** and **Restart**.
2. Select **Restart** from the **Turn Off Computer** window in the start menu.
3. Slide the power button and hold it down for five seconds. Wait 10 to 15 seconds, then turn the power on again by sliding the power button.

Restoring the preinstalled software from the Product Recovery CD-ROM

If preinstalled files are damaged, use the Product Recovery CD-ROM to restore them. To restore the operating system and all preinstalled software, follow the steps below.

***CAUTION:** When you reinstall the Windows operating system, the hard disk will be reformatted and all data will be lost.*

1. Load the Product Recovery CD-ROM in the external optional optical disk drive and turn off the computer's power.
2. Hold down the **F12** key and turn on the power. When **In Touch with Tomorrow TOSHIBA** appears, release the **F12** key.
3. Use the left or right cursor key to select the CD-ROM icon in the display menu. For details, refer to the *Boot priority* section in Chapter 7, *HW Setup*.
4. Follow the on-screen instructions.

Chapter 4

Operating Basics

Using the Touch Pad	4-1
Using the Tablet PC Pen and Reserve Pen	4-2
Inserting the Tablet PC Pen	4-4
Removing the Tablet PC Pen	4-5
Pen actions	4-5
Single tap	4-5
Double tap	4-5
Press and hold	4-5
Drag	4-6
Drag and drop	4-6
Replacing the pen tip	4-6
Inserting the Reserve Pen	4-7
Removing the Reserve Pen	4-7
Changing to the Tablet mode	4-8
Changing the screen orientation	4-10
Method 1: Changing the screen orientation using TOSHIBA Accelerometer Utilities	4-11
Method 2: Changing the screen orientation using Enter/Menu Button	4-12
Method 3: Changing the screen orientation using Task Bar	4-12
Changing to the laptop mode	4-13
Using the USB FDD Kit	4-13
Connecting the USB diskette drive	4-14
Disconnecting the USB diskette drive	4-15
Diskette care	4-15
Wireless communications	4-16
Wireless LAN	4-16
Bluetooth wireless technology	4-17
Wireless communication switch	4-18
Wireless communication Indicator	4-18
LAN	4-19
LAN cable types	4-19
Connecting LAN cable	4-19
Disconnecting LAN cable	4-20

Using the microphones	4-21
Audio	4-21
Using the internal modem	4-24
Region selection	4-25
Properties menu	4-25
Connecting	4-26
Disconnecting	4-27
Cleaning the computer	4-27
Moving the computer	4-28
Heat dispersal	4-28

Operating Basics

This chapter gives information on basic operations including using the Touch Pad, the Tablet PC Pen, the external diskette drive, the wireless communication, LAN and the internal modem. It also provides tips on caring for your computer and on heat dispersal.

Using the Touch Pad

To use the Touch Pad, simply press and move your finger tip across it in the direction you want the on-screen pointer to go.

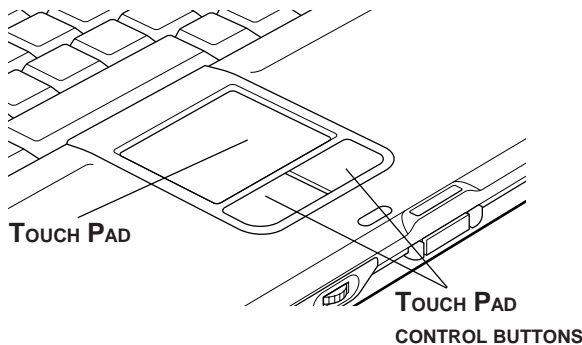

Figure 4-1 Touch Pad and Touch Pad control buttons

Two Touch Pad control buttons are used like the buttons on a mouse pointer. Press the left button to select a menu item or to manipulate text or graphics designated by the pointer. Press the right button to display a menu or other function depending on the software you are using.

CAUTION: Do not press the touch pad too hard nor press it with a sharp object such as a ball point pen against the touch pad. The touch pad could be damaged.

For some functions, you can tap the touch pad instead of pressing a control button.

- Click** Tap the touch pad once.
- Double-click** Tap the touch pad twice.
- Drag and drop**
 1. Select the material you want to move.
 2. Leave your finger on the Touch Pad after selecting the material and move it.
 3. Lift your finger to drop the item at a place where you want it.
- Scroll** Vertical: Move your finger to and fro the right edge of the touch pad.
Horizontal: Move your finger left or right along the bottom edge of the touch pad.

Using the Tablet PC Pen and Reserve Pen

- Eraser button** You can use this button as an eraser when using the application software for graphics. The application software for texts enables you to select and delete characters with one-touch action.
- Pen button** Acts as the clicking of the right touch pad control button.
- Pen point** Acts as the clicking of the left touch pad control button.

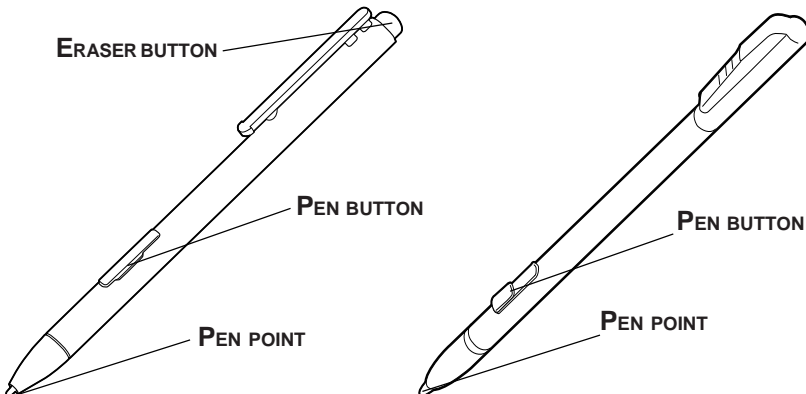

Figure 4-2 The Tablet PC Pen and Reserve Pen

You can use the Tablet PC Pen to execute actions and enter data. Hold the Tablet PC Pen in a natural position and tap, press or trace on the screen lightly. Before you begin using the TOSHIBA Portégé M200 for the first time, you will need to calibrate the Tablet PC Pen. Refer to the *Pointing device* section in Chapter 9, *Trouble shooting*.

Some computers in the series are equipped with a Reserve Pen

CAUTIONS: *Observe the following precautions on the handling of the Tablet PC Pen.*

- 1. Do not tap or press the Tablet PC Pen forcefully against the Display screen. It could damage the Tablet PC Pen and Display screen.*
- 2. Avoid using or keeping the Tablet PC Pen in the place of rapid temperature change or in a car where the Tablet PC Pen is exposed to direct sunbeam. Keep the Tablet PC Pen without pressure constantly applied to the switch of the Tablet PC Pen. Constant pressure to the button causes a malfunction or characteristic deterioration.*
- 3. The Tablet PC Pen is composed of precision parts. Do not drop the Tablet PC Pen. Strong impact causes a malfunction or characteristic deterioration.*
- 4. Do not apply excessive force to the Tablet PC Pen point and the side switch. Excessive force applied to these parts causes short life or characteristic deterioration. (Allowable force to pen point, Eraser button, Pen button: less than 1 kg, for less than 30 seconds)*
- 5. Avoid water to enter in the Tablet PC Pen or dew condensation. Intrusion of water or dew condensation causes malfunction.*
- 6. Do not disassemble the Tablet PC Pen. It causes maladjustment or short life.*
- 7. Do not stain the Tablet PC Pen with cosmetics or chemicals. It causes deterioration of appearance. Use a glass wiping cloth or dry cloth to clean the Tablet PC Pen when cleaning. Do not use volatile liquid such as alcohol, thinner or petroleum benzene.*

8. Do not apply excessive force to the Tablet PC Pen point. Crooked or deformed pen point due to excessive force causes malfunction.
9. Keep the small parts of the Tablet PC Pen such as the pen point or the knob of the side switch away from infant to prevent them to swallow.
10. Do not use a ball point pen instead of the Tablet PC Pen delivered with the product.
11. Do not use a broken pen tip.
12. The lead cannot be replaced if it is worn. (Reserve Pen only)

NOTE: TOSHIBA is not liable to the quality problem of the products due to the use of the Tablet PC Pen in an environment where above conditions are not satisfied because of the use by unspecified number of users.

Inserting the Tablet PC Pen

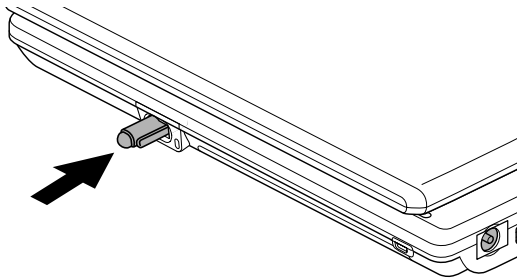

Figure 4-3 Inserting the Tablet PC Pen

The Tablet PC Pen is included in the product when purchased. Take out the Tablet PC Pen from the carton and install it to the computer as the following.

1. Insert the Tablet PC Pen into the pen holder until it clicks.

NOTE: The Tablet PC Pen and the emergency Tablet PC Pen are different in shape. Do not insert the Reserve Pen into the pen holder.

Removing the Tablet PC Pen

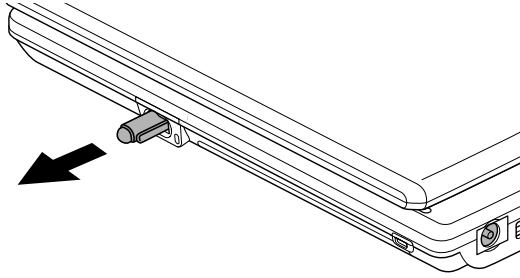

Figure 4-4 Removing the Tablet PC Pen

1. Gently push the Tablet PC Pen down. The pen rises up slightly.
2. Pull the Tablet PC Pen to remove it from the holder.

Pen actions

You can use the Tablet PC Pen to enter data, start programs, move objects and execute other actions.

Single tap

Lightly tap the tip of the Tablet PC Pen on an object and lift it immediately to execute an action. A single tap is similar to clicking the left touch pad control button.

Double tap

Lightly tap the tip of the Tablet PC Pen twice on an object and lift it immediately to execute an action. A double-tap is similar to double-clicking the left touch pad control button.

Press and hold

Touch the tip of the Tablet PC Pen to the display screen and hold it there to display a pop-up menu or other action. Press and hold is similar to clicking the right touch pad control button.

Drag

Touch the Tablet PC Pen to the screen. Without lifting the Tablet PC Pen, drag it across the screen to select text or objects.

Drag and drop

Touch the Tablet PC Pen to the screen to select an object. Without lifting the Tablet PC Pen, drag it across the screen. Lift the Tablet PC Pen to drop the object to a new location.

Replacing the pen tip

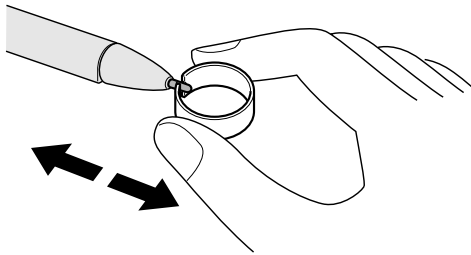

Figure 4-5 Replacing the pen tip

1. To replace the pen tip, pinch the tip with a draw-out tool and pull it out.
2. Insert a new tip into the Tablet PC Pen at the flat end of the tip and press it to seat securely.

NOTES: 1. Short and worn pen point is difficult to pull out. Replace the pen point with refill before it becomes too short.

2. TOSHIBA recommends the customer to keep another pen set as a spare. You can buy the pen set from TOSHIBA dealer.

CAUTION: Do not use the broken pen tip. When it breaks, replace it with a refill delivered with the Tablet PC Pen. Use of the broken pen tip causes to make scratches on the display panel. When the reserve refills have run out, purchase a new pen set from a TOSHIBA dealer.

Inserting the Reserve Pen

1. Remove the Battery Pack.
2. Gently push the Reserve Pen into the pen holder to insert it.
3. Reinstall the Battery Pack.

NOTE: Refer to the Replacing the Battery Pack section in Chapter 6, Power and Power-Up Modes for more information on how to remove and reinstall the Battery Pack.

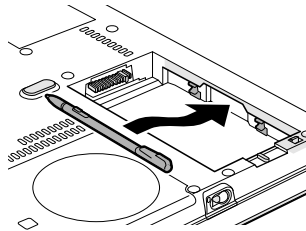

Figure 4-6 Inserting the Reserve Pen

Removing the Reserve Pen

1. Remove the Battery Pack.
2. Remove the Reserve Pen from the holder.
3. Reinstall the Battery Pack.

NOTE: Refer to the Replacing the Battery Pack section in Chapter 6, Power and Power-Up Modes formation on how to remove and reinstall the Battery Pack.

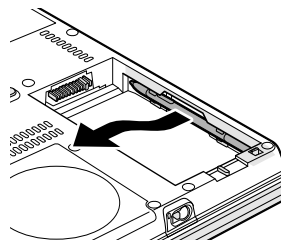

Figure 4-7 Removing the Reserve Pen

Changing to the Tablet mode

To change the laptop mode to the tablet mode, follow the instructions below.

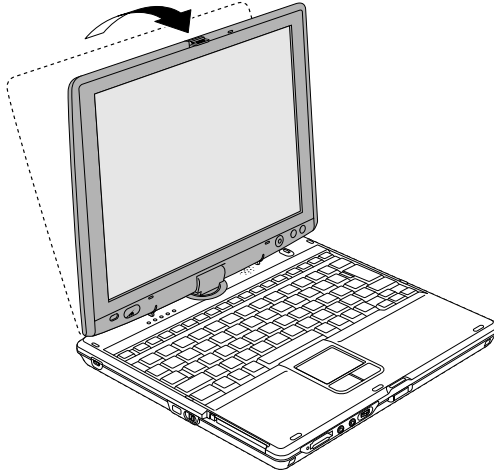

Figure 4-8 Changing to the Tablet mode (1)

CAUTION: Place the computer on a stable, flat place such as a desktop and rotate the display panel slowly, holding the panel at its lower part. The display panel is designed not to rotate more than 180 degrees. Rotating the display panel more than 180 degrees with an excessive force causes to damage the panel.

The rotating direction to change the mode is the following:

From laptop mode to Tablet mode: clockwise 180 degrees

Tablet mode icon

Turn the display panel to the direction indicated by the Tablet mode icon .



From Tablet mode to laptop mode: counter-clockwise 180 degrees

Laptop mode icon

Turn the display panel to the direction indicated by the laptop mode icon.



1. Open the display panel to the upright position.



Figure 4-9 Changing to the Tablet mode (2)

2. Rotate the display panel clockwise slowly.

NOTE: Do not apply excessive rotating force to the display panel. It causes damage of the display panel.

3. Turn the Display latch in 180 degrees to the down side.

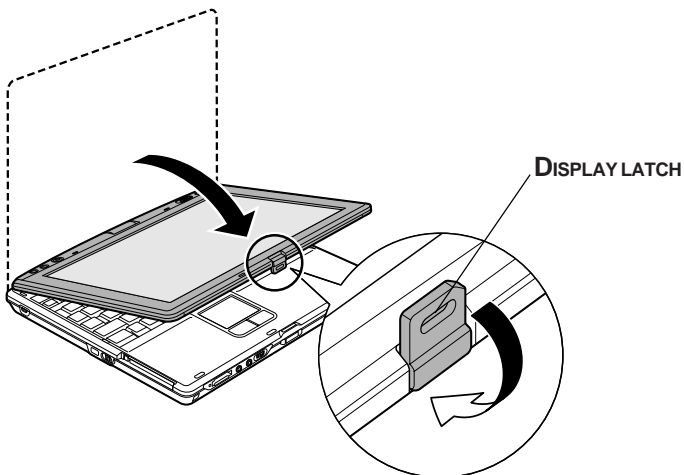

Figure 4-10 Changing to the Tablet mode (3)

4. Close the display panel slowly with LCD surface outside.

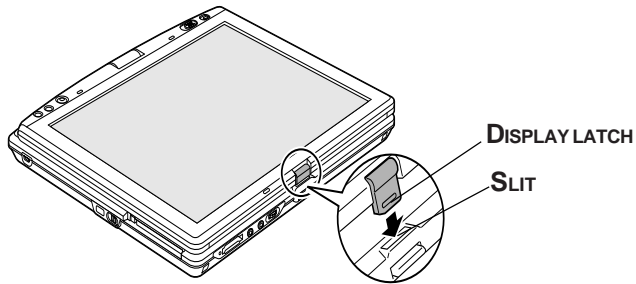

Figure 4-11 Changing to the Tablet mode (4)

5. Turn the Display latch downward.
6. Insert the Display latch in the slit.
7. Press the display panel downward softly.

Changing the screen orientation

The orientation of desktop screen can be changed to one of the following four display modes:

- Primary portrait

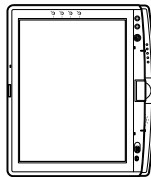

- Secondary portrait

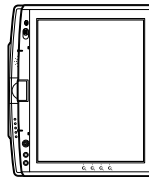

- Primary landscape

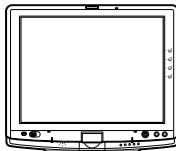

- Secondary landscape

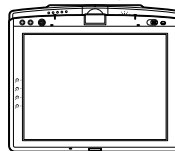

NOTES:

1. Execute the following applications on Primary landscape:

- 3D game software
- 3D screen saver
- Playback of motion picture, such as a case of DVD-Video playback on the computer connecting an external DVD-ROM Drive.

CAUTION: Do not play 3D game software or replay DVD-Video on the screen other than Primary landscape. An abnormality will appear on the Windows screen display when you replay a DVD-Video on the screen other than Primary landscape because DVD playback software can boot only in the Primary landscape.

2. The screen cannot rotate in one of the following cases. Quit the running application and then rotate the screen:

- Running of the application that changes the screen resolution dynamically (such as a game that is execute on full-screen mode)
- DOS prompt in full-screen mode
- Running of 3D screen saver

CAUTION: An abnormality will appear a part of the Windows screen display when you change the PC from Tablet mode to laptop mode while 3D screen saver is running. In such a case, press any key in the laptop mode to cancel 3D screen saver.

Method 1: Changing the screen orientation using TOSHIBA Accelerometer Utilities

When TOSHIBA Accelerometer Utilities is enabled, you can invoke the Start menu, switch active windows or launch predefined applications by shaking the computer vertically or horizontally, or tilting it.

CAUTION: When you shake the computer:

- Do not shake the computer too strongly.
If so, the computer may drop from your hands or hit persons or things around.
- Avoid using the computer in crowded places. (e.g. in commuter trains or in busy streets)
This may cause injury to a child or adult, and damage to the computer.

It is safe that you hold the computer with both hands horizontally as shown in the example.

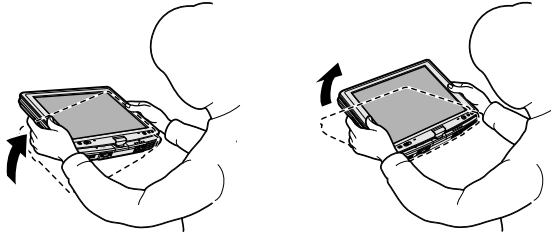

Figure 4-12 Shake the computer

Method 2: Changing the screen orientation using Enter/Menu Button

1. Press Enter/Menu Button for more than one second. TOSHIBA Table Menu will appear.
2. Point the cursor at Screen Rotation using Arrow Button (1) or (2) and press Enter/Menu Button.
3. Select the rotation angle using Arrow Button (1) or (2) and press Enter/Menu Button.

Method 3: Changing the screen orientation using Task Bar

1. Right click "Change tablet and pen settings" icon in the Task Bar. Click "Change screen orientation" from the menu.
The screen orientation is set to change in the following order when purchased.

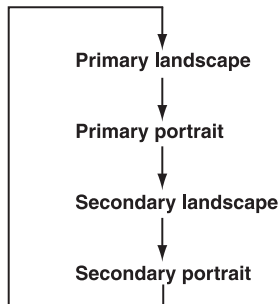

You can change the above sequence in the following procedure:

- (1) Double click **Change tablet and pen settings** icon in the Task Bar.
- (2) Click **Change** button in **Display** tab.
- (3) Change the sequence in **Orientation Sequence Settings** screen. Click **OK** button.

NOTE: You can set the orientation of the desktop screen just after rotating the display from

Start → **All Programs** → **Tablet PC** → **TOSHIBA**
Rotation Utility

Changing to the laptop mode

To change the Tablet mode to the laptop mode, follow the instructions below.

1. Press the Display latch and raise the display to the upright position carefully.
2. Rotate the display counter-clockwise slowly.
3. Turn the display latch toward you for the next closing of the display.

Using the USB FDD Kit

A 3 1/2" diskette drive connects to the computer's USB port. It accommodates 1.44-megabyte or 720-kilobyte diskettes. Refer to the *Options* section in Chapter 1, *Introduction*, for more information.

NOTE: The USB FDD Kit is an option with some models.

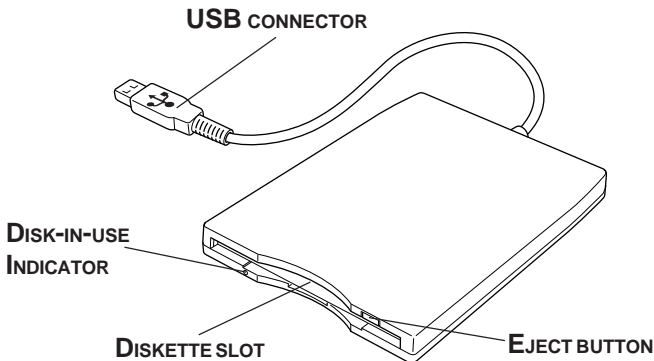

Figure 4-13 The 3 1/2" USB FDD Kit

- Eject button** When a diskette is fully seated in the drive, the eject button pops out. To remove a diskette, push in the eject button and the diskette pops out partially for easy removal.
- Diskette slot** Insert diskettes in this slot.
- Disk-In-Use Indicator** This indicator lights when the diskette is being accessed.

CAUTION: Check the **Disk-In-Use** indicator when you use the diskette drive. Do not press the eject button, disconnect a drive cable or turn off the computer while the light is glowing. Doing so could destroy data and damage the diskette or the drive.

- NOTES:**
1. The external diskette drive should be placed on a flat, horizontal surface when in use. Do not set the drive on an incline greater than 20° while it is operating.
 2. Do not set anything on top of the diskette drive.
 3. If you need to boot the computer from the diskette drive or if you use an OS that does not support USB, you must set the **USB-FDD Legacy Emulation** feature in **HW Setup** to **Enabled**. Refer to the **USB** section in **Chapter 7, HW SetUP**.

Connecting the USB diskette drive

To connect the drive, plug the diskette drive connector into a USB port. Refer to Figure 4-13.

NOTE: Make sure the connector is right side up and properly aligned with the socket. Do not try to force the connection, doing so can damage the connecting pins.

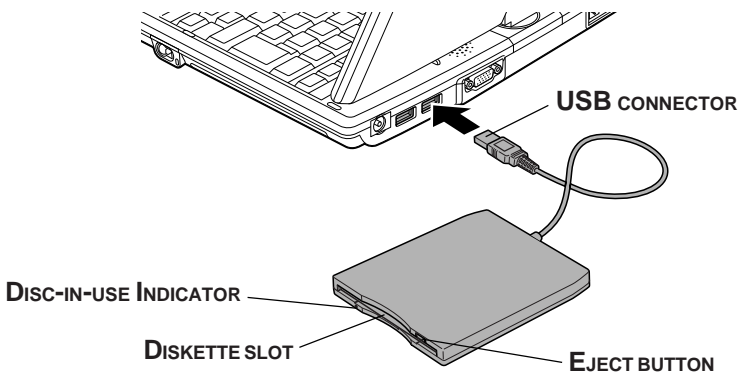

Figure 4-14 Connecting the diskette drive to the computer

***NOTE:** If you connect the diskette drive after turning on the computer, it will take about 10 seconds for the computer to recognize the drive. Do not disconnect and reconnect before 10 seconds has elapsed.*

Disconnecting the USB diskette drive

When you have finished using the diskette drive, follow the procedures below to disconnect it:

1. Wait for the indicator light to go out to make sure all diskette activity has stopped.

***CAUTION:** If you disconnect the diskette drive or turn off the power while the computer is accessing the drive you may lose data or damage the diskette or the drive.*

2. Pull the diskette drive connector out of the USB port.

Diskette care

Handle your diskettes with care. The following simple precautions will increase the lifetime of your diskettes and protect the data you store on them:

1. Store your diskettes in the container they came in to protect them and keep them clean. If a diskette is dirty, do not use cleaning fluid. Clean it with a soft damp cloth.
2. Do not slide back the diskette's protective metal covering or touch the diskette's magnetic surface. Fingerprints may prevent the diskette drive from reading data from the diskette.
3. Data may be lost if the diskette is twisted; bent; or exposed to direct sunlight or extreme heat or cold.
4. Do not place heavy objects on your diskettes.
5. Do not eat, smoke, or use erasers near your diskettes. Foreign particles inside the diskette's jacket can damage the magnetic surface.
6. Magnetic energy can destroy the data on your diskettes. Keep your diskettes away from speaker, radios, television sets and other sources of magnetic fields.

Wireless communications

The computer's wireless communication function supports both Wireless LAN and Bluetooth devices.

In this chapter, the descriptions on Wireless LAN or Bluetooth are applicable to the model equipped with Wireless LAN or Bluetooth function respectively.

Carefully check that the computer is available for Wireless LAN communication in Tablet mode for Wireless LAN and Bluetooth.

Laptop mode gives the highest reception sensitivity of wireless communication. Change the operation mode of the computer to the laptop mode when you cannot use the wireless communication in the Tablet mode.

Also try to use the computer in the laptop mode with the LCD panel open when you cannot use the wireless communication even if in the laptop mode with the LCD closed.

The reception sensitivity of wireless communication becomes lower in the operation mode described below.

Laptop mode (with LCD panel open) > Laptop mode (with LCD panel closed) > Tablet mode

Wireless LAN

The Wireless LAN is compatible with other LAN systems based on Direct Sequence Spread Spectrum/Orthogonal Frequency Division Multiplexing radio technology that complies with IEEE802.11 Wireless LAN standard.(Revision B or G) The configuration of the built-in Wireless LAN depends on the model you purchased.

Supported features

It supports the following features:

- Automatic Transmit Rate Select mechanism in the transmit range of 54, 48, 36, 24, 18, 12, 9 and 6 Mbit/s. (Revision G, A/B, B/G, combo type)
- Automatic Transmit Rate Select mechanism in the transmit range of 11, 5.5, 2 and 1 Mbit/s. (Revision B)
- Frequency Channel Selection Revision B/G: 2.4GHz)
- Roaming over multiple channels
- Card Power Management
- Wired Equivalent Privacy (WEP) data encryption, based on the 152 bit encryption algorithm. (Revision B/G, combo type)

- ❑ Advanced Encryption Standard (AES) data encryption, based on 256 bit encryption algorithm. (Revision B/G combo type)

NOTE: Wake-up on LAN does not function on a Wireless LAN.

Security

Be sure to enable WEP (encryption) function. Otherwise your computer will allow the illegal access by outsider through Wireless LAN to cause illegal intrusion, eavesdropping, and loss or destruction of stored data. TOSHIBA strongly recommend the customer to enable the WEP function.

Bluetooth wireless technology

Bluetooth™ wireless technology eliminates the need for cables between electronic devices such as desktop computers, printers and mobile phones.

You cannot use the built-in Bluetooth functions and an optional Bluetooth PC card simultaneously.

Bluetooth wireless technology has the following features:

Worldwide operation

The Bluetooth radio transmitter and receiver operates in the 2.45 GHz band, which is license-free and compatible with radio systems in most countries in the world.

Radio links

You can easily establish links between two or more devices. The link is maintained even if the devices are not within line of sight.

Security

Two advanced security mechanisms ensure a high level of security:

- ❑ Authentication prevents access to critical data and makes it impossible to falsify the origin of a message.
- ❑ Encryption prevents eavesdropping and maintains link privacy.

Wireless communication switch

You can enable or disable Wireless LAN and Bluetooth function, with the on/off switch. No transmissions are sent or received when the switch is off. Slide the switch toward the back of the computer to turn it on and toward the front of the computer to turn it off.

CAUTION: Set the switch to off in airplanes and hospitals. Check the indicator. It will stop glowing when the wireless communication function is off.

Wireless communication Indicator

The wireless communication indicator indicates the status of the wireless communication functions.

Indicator status	Indication
Indicator off	Wireless communication switch is set to off. Automatic power down because of overheating. Power malfunction.
Indicator glows	Wireless communication switch is on. Wireless LAN or Bluetooth is turned on by an application.

If you used the Task Bar to disable W-LAN, restart the computer or follow the procedures below to enable the system to recognize W-LAN. Open or click the following: **start, Control Panel, System, Hardware Device Manager, Network adapters, Atheros AR5001X+ Wireless Network Adapter** and **enable**.

NOTE: Indication of Wireless Communication Standards (Wireless LAN and Bluetooth) The indication of Wireless LAN and Bluetooth is described on the sticker affixed to the computer. The sticker can be seen by removing a battery pack from the computer.

LAN

The computer has built-in support for Ethernet LAN (10 megabits per second, 10BASE-T) and Fast Ethernet LAN (100 megabits per second, 100BASE-Tx). This section describes how to connect/disconnect to a LAN.

CAUTION: Do not install or remove an optional memory module while Wake-up on LAN is enabled.

NOTE: Wake-up on LAN does not work without the AC adaptor. Leave it connected, if you are using this feature.

LAN cable types

CAUTION: The computer must be configured properly before connecting to a LAN. Logging onto a LAN using the computer's default settings could cause a malfunction in LAN operation. Check with your LAN administrator regarding set-up procedures.

If you are using Fast Ethernet LAN (100 megabits per second, 100BASE-TX), be sure to connect with a CAT5 cable. You cannot use a CAT3 cable.

If you are using Ethernet LAN (10 megabits per second, 10BASE-T), you can connect with either a CAT5 or a CAT3.

Connecting LAN cable

To connect the LAN cable, follow the steps below.

CAUTION: Connect the AC adaptor before connecting the LAN cable. The AC adaptor must remain connected during LAN use. If you disconnect the AC Adaptor while the computer is accessing a LAN, the system may hang up.

1. Turn off the power to the computer and to all external devices connected to the computer.

2. Plug one end of the cable into the LAN's jack. Press gently until you hear the latch click into place.

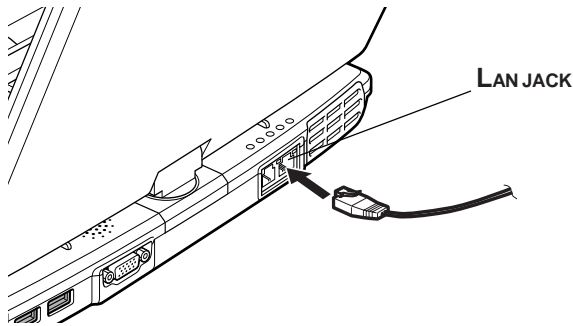

Figure 4-15 Connecting the LAN cable

3. Plug the other end of the cable into a LAN hub connector. Check with your LAN administrator before connecting to a hub.

NOTE: When the computer is exchanging data with the LAN, the **LAN Active** indicator glow in orange. When the computer is connected to a LAN hub but is not exchanging data, the **Link** indicator glows in green.

Disconnecting LAN cable

To disconnect the LAN cable, follow the steps below.

CAUTION: Make sure the LAN Active indicator (orange LED) is out before you disconnect the computer from the LAN.

1. Pinch the lever on the connector in the computer and pull out the connector.
2. Disconnect the cable from the LAN hub in the same manner. Check with your LAN administrator before disconnecting from the hub.

Using the microphones

Your computer has a built-in microphones that can be used to record stereo sounds into your applications. It can also be used to issue voice commands to applications that support such functions.

Since your computer has a built-in microphones and speaker, "howling" may be heard under certain conditions. Howling occurs when sound from the speaker is picked up in the microphones and amplified back to the speaker, which amplifies it again to the microphones.

This howling occurs repeatedly and causes a very loud, high-pitched noise. It is a common phenomenon that occurs in any sound system when the microphones input is output to the speaker (throughput) and the speaker volume is too loud or too close to the microphones. You can control throughput by adjusting the volume of your speaker or through the Mute function.

To adjust the volume or activate Mute, click **start**, point to **All Programs**, point to **Accessories**, point to **Entertainment** and click **Volume Control**. In the **Master Volume** panel, you can use the slide bars to adjust the volume level or click **Mute** at the bottom of the panel.

Audio

This section describes audio controls including sound levels and power management.

Volume control

The Volume Control utility lets you control the audio volume in Windows for both playback and recording.

- To launch Volume Control for playback, click **Start**, point to **All Programs**, point to **Accessories**, point to **Entertainment** and click **Volume Control**.
- To launch Recording Control, click **Options**, point to **Properties**, choose **Recording** and click **OK**.
- To view details of the Volume Control, click **Help** on the Volume Control.

Microphone level

The change the microphone gain, follow the steps below.

1. Click **Start**, point to **All Programs**, point to **Accessories**, point to **Entertainment** and click **Volume Control**.

2. Click **Options** and select **Advanced Controls**.
3. Click **Advanced**.
4. Check the **MIC Boost** checkbox.

SoundMAX Control Panel

The SoundMAX control panel lets you control additional functions for the Microphone Enhancement and Audio Power Management. To launch the SoundMAX Control Panel, follow the steps below.

1. Click **Start** and click Control Panel.

***NOTE:** If you are viewing the Control Panel in Category View, click on Switch to Classic View.*

2. Double-click the **SoundMAX** icon.

Microphone Enhancements

The **Microphone Setup** allows you to optimize the microphone input settings for your particular configuration. Choose **Standard Microphone** if you have an ordinary desktop microphone. Choose **Headset** if you have a wearable microphone that is positioned directly in front of your mouth.

***NOTE:** SoundMAX Superbeam™ Microphone is for an optional microphone which is sold by Andrea Electronics. You can get information about the microphone at the web site of Andrea Electronics.*

You can launch the **Setup Wizard** from the Control Panel to help you to automatically set proper microphone input volumes and ensure that your voice input(s) are working correctly. As you speak into the microphone, the Sound Meter indicates the audio signal that your PC is receiving.

The **Noise Reduction** enhancement helps to eliminate ambient noise from the voice input signal to provide a clean and clear signal to applications. This feature can be used with any microphone.

***NOTE:** If the **Noise Reduction** check box is selected, a monaural sound is recorded when recording by a stereo microphone. You need to disable this check box if you would like to record a stereo sound by a stereo microphone.*

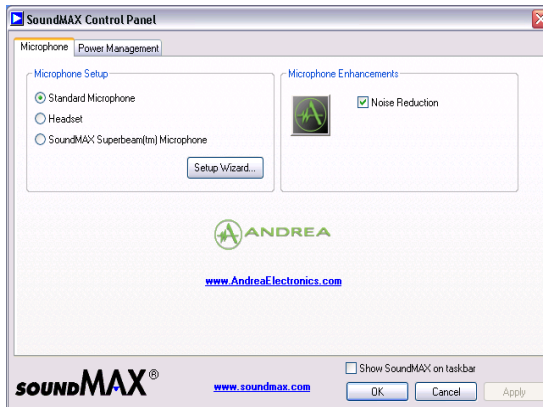

Figure 4-16 Microphone window

Power management

The audio controller can be powered down when the audio function is idle. To enable the Audio Power Management, follow the steps below.

1. Clicked the **Power Management** tab.
2. Select the **Normal Power Savings** in the Power Mode pull-down list.

***NOTE:** If the **No Power Savings** is selected, the audio controller always runs.*

If you want to a more effect for the power management, you can select another mode, the **High Power Savings** which can save the power than the Normal Power Savings. To select it, follow the steps below.

1. Clicked the **Power Management** tab.
2. Select the **High Power Savings** in the Power Mode pull-down list.
3. Input a time in **Power Save Delay (Seconds)**.

***NOTE:** If the **High Power Saving** is selected, you need to play an audio file once before you use a microphone or play an audio CD by the analog CD audio.*

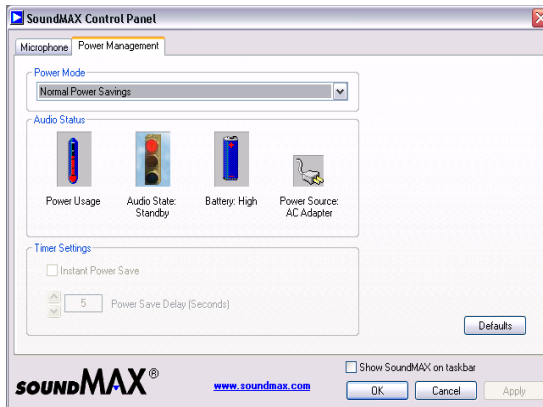

Figure 4-17 Power Management window

Trademarks:

SoundMAX® and the SoundMAX logo are registered trademarks of Analog Devices, Inc. PureAudio®, DSDA®, and Superbeam® are trademarks of Andrea Electronics. The Sensaura logo, Virtual Theater and Virtual Ear are trademarks and/or registered trademarks of Sensaura Limited. Yamaha XGlite is a trademark of Yamaha Corporation. All other trademarks are the property of their respective owners. All specifications subject to change without notice. © 2003 Analog Devices, Inc. All Rights Reserved.

Using the internal modem

If you purchased a computer model with a preinstalled internal modem, read this section for directions on connecting the modem. Refer to the online help files for the internal modem and for details on operation of your modem and modem software.

NOTE: *The internal modem does not support the voice functions. All data and fax functions are supported.*

- CAUTIONS:**
- 1. In case of a lightning storm, unplug the modem cable from the telephone jack.*
 - 2. Do not connect the modem to a digital telephone line. A digital line will damage the modem.*

Region selection

Telecommunication regulations vary from one region to another, so you will need to make sure the internal modem's settings are correct for the region in which it will be used.

1. Click **start**, point to **All Programs**, point to **TOSHIBA**, point to **Networking** and click **Modem Region Select**.

NOTE: Do not use the Country/Region Select function in the Modem setup utility in the Control Panel if the function is available. If you change the Country/Region in the Control Panel, the change may not take effect.

2. The Region Selection icon will appear in the Windows Task Bar.
3. Click the icon with the primary mouse button to display a list of regions that the modem supports. A sub menu for telephony location information will also be displayed. A check will appear next to the currently selected region and telephony location.
4. Select a region from the region menu or a telephony location from the sub-menu.
 - When you click a region it becomes the modem's region selection, and the New Location for telephony will be set automatically.
 - When you select a telephony location, the corresponding region is automatically selected and it becomes the modem's current region setting.

Properties menu

Click the icon with the secondary mouse button to display the following menu.

Setting

You can enable or disable the following settings:

AutoRun Mode

Region Select Utility starts automatically when you start up the operating system.

Open the Dialing Properties dialog box after selecting region.

The dialing properties dialog box will be displayed automatically after you select the region.

Location list for region selection.

A submenu appears displaying location information for telephony.

Open dialog box, if the modem and Telephony Current Location region code do not match.

A warning dialog box is displayed if current settings for region code and telephony location are incorrect.

Modem Selection

If the computer cannot recognize the internal modem, a dialog box is displayed. Select the COM port for your modem to use.

Dialing Properties

Select this item to display the dialing properties.

CAUTION: *If you are using the computer in Japan, technical regulations described in the Telecommunications Business Law require that you select Japan region mode. It is illegal to use the modem in Japan with any other selection.*

Connecting

To connect the internal modem cable, follow the steps below.

WARNING: *The modular cable that comes with the computer must be used to connect a modem. Connect the end of the modular cable with the core to the computer.*

CAUTIONS:

1. *In case of a lightning storm, unplug the modem cable from the telephone jack.*
2. *Do not connect the modem to a digital telephone line. A digital line will damage the modem.*

1. Plug one end of the modular cable into the modem jack.

2. Plug the other end of the modular cable into a telephone jack.

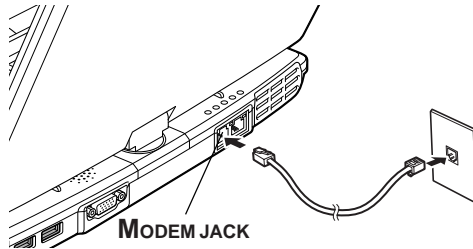

Figure 4-18 Connecting the internal modem

CAUTION: Do not pull on the cable or move the computer while the cable is connected.

NOTE: If you use a storage device such as a CD-ROM drive or HDD connected to a 16-bit PC card, you might experience the following modem problems:

1. Modem speed is slow or communication is interrupted.
2. Skip may occur in sound.

Disconnecting

To disconnect the internal modem cable, follow the steps below:

1. Pinch the lever on the connector in the telephone jack and pull out the connector.
2. Disconnect the cable from the computer in the same manner.

Cleaning the computer

To help ensure long, trouble-free operation, keep the computer free of dust and use care with liquids around the computer.

- ❑ Be careful not to spill liquids into the computer. If the computer does get wet, turn the power off immediately and let the computer dry completely before you turn it on again.

- ❑ Clean the computer using a slightly damp (with water) cloth. You can use glass cleaner on the display. Spray a small amount of cleaner on a soft, clean cloth and wipe the screen gently with the cloth.

CAUTION: *Never spray cleaner directly onto the computer or let liquid run into any part of it. Never use harsh or caustic chemical products to clean the computer.*

Moving the computer

The computer is designed for rugged durability. However, a few simple precautions taken when moving the computer will help insure trouble-free operation.

- ❑ Turn off the computer. Do not carry the computer with power on or in stand by state. Do not carry the computer while DISK indicator is glowing.
- ❑ Do not expose the computer with rapid temperature change (such as the case to bring the PC from cold outside into warm room).
When rapid temperature change is unavoidable, turn on the computer after a couple of hours.
- ❑ Remove all external peripheral devices and their connection cables from the computer before carrying. If an optical disk is inserted in an optical disk drive, eject it.
- ❑ Do not drop the computer nor apply excessive impact on the computer. Do not leave the computer in an automobile where the computer is exposed to direct sunbeam.
- ❑ Close the display panel when carrying.
- ❑ Do not put the computer in Tablet mode in a bag.

Heat dispersal

To protect from overheating, the CPU has an internal temperature sensor. If the computer's internal temperature rises to a certain level, the cooling fan is turned on or the processing speed is lowered. You can select whether to control the CPU temperature by turning on the fan first, then if necessary, lowering the CPU speed. Or, by lowering the CPU speed first, then if necessary, turning on the fan. Use the *Cooling Method* item of the *Power Save Mode* window in TOSHIBA Power Saver.

- Maximum performance** Turn on the fan first, then if necessary, lower the CPU processing speed.
- Performance** Use a combination of the fan and lowering the CPU processing speed.
- Battery optimized** Lower the CPU processing speed first, then if necessary turn on the fan.

When the CPU temperature falls to a normal range, the fan is turned off and the CPU operation returns to standard speed.

***NOTE:** If the CPU temperature reaches an unacceptably high level with either setting, the system automatically shuts down to prevent damage. Data in memory will be lost.*

Chapter 5

The Keyboard

Typewriter keys	5-1
F1 ... F12 function keys	5-2
Soft keys: Fn key combinations	5-2
Emulating keys on enhanced keyboard	5-2
Hotkeys	5-4
Fn Sticky key	5-7
Windows special keys	5-7
Keypad overlay	5-7
Turning on the overlays	5-7
Temporarily using normal keyboard (overlay on)	5-8
Temporarily using overlay (overlay off)	5-9
Temporarily changing modes	5-9
Generating ASCII characters	5-9

The Keyboard

The computer's keyboard layouts are compatible with a 101/102-key enhanced keyboard. By pressing some keys in combination, all the 101/102-key keyboard functions can be executed on the computer.

The number of keys on your keyboard depends on which country/region's keyboard layout your computer is configured with. Keyboards for numerous languages are available.

There are five types of keys: typewriter keys, keypad overlay, function keys, soft keys and cursor control keys.

Typewriter keys

The typewriter keys, produce the upper- and lowercase letters, numbers, punctuation marks, and special symbols that appear on the screen.

There are some differences, however, between using a typewriter and using a computer keyboard:

- ❑ Letters and numbers produced in computer text vary in width. Spaces, which are created by a "space character," may also vary depending on line justification and other factors.
- ❑ The lowercase l (el) and the number 1 (one) are not interchangeable on computers as they are on a typewriter.
- ❑ The uppercase O (oh) and the 0 (zero) are not interchangeable.
- ❑ The **Caps Lock** function key locks only the alphabetic characters in uppercase while the shift lock on a typewriter places all keys in the shifted position.
- ❑ The **Shift** keys, the **Tab** key, and the **BkSp** (backspace) key perform the same function as their typewriter counterparts but also have special computer functions.

F1 ... F12 function keys

The function keys, not to be confused with **Fn**, are the 12 keys at the top of your keyboard. These keys are dark gray, but function differently from the other dark gray keys.



F1 through **F12** are called function keys because they execute programmed functions when pressed. Used in combination with the **Fn** key, keys marked with icons execute specific functions on the computer. See the section, *Soft keys: Fn key combinations*, in this chapter. The function executed by individual keys depends on the software you are using.

Soft keys: Fn key combinations

The **Fn** (function) is unique to TOSHIBA computers and is used in combination with other keys to form soft keys. Soft keys are key combinations that enable, disable or configure specific features.

NOTE: Some software may disable or interfere with soft-key operations. Soft-key settings are not restored by the Resume feature.

Emulating keys on enhanced keyboard

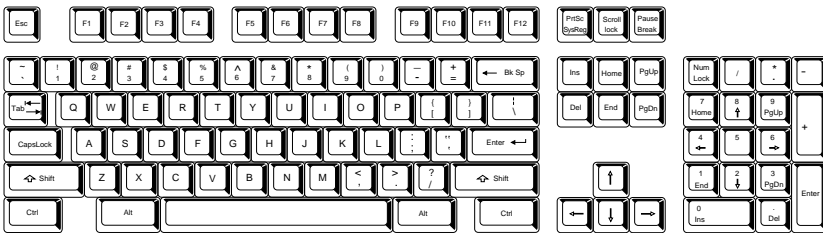
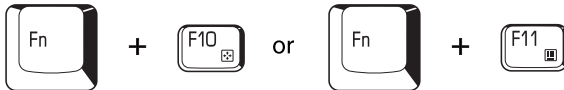

Figure 5-1 A 101-key enhanced keyboard layout

The keyboard is designed to provide all the features of the 101-key enhanced keyboard, shown in figure 5-1. The 101/102-key enhanced keyboard has a numeric keypad and scroll lock key. It also has additional **Enter** and **Ctrl** keys to the right of the main keyboard. Since the keyboard is smaller and has fewer keys, some of the enhanced keyboard functions must be simulated using two keys instead of one on the larger keyboard.

Your software may require you to use keys that the keyboard does not have. Pressing the **Fn** key and one of the following keys simulates the enhanced keyboard's functions.



Press **Fn + F10** or **Fn + F11** to access the integrated keypad. When activated, the keys with gray markings on the side face become numeric keypad keys (**Fn + F11**) or cursor control keys (**Fn + F10**). Refer to the *Keypad overlay* section in this chapter for more information on how to operate these keys. The power on default for both settings is off.



Press **Fn + F12 (ScrLock)** to lock the cursor on a specific line. The power on default is off.



Press **Fn + Enter** to simulate **Enter** on the enhanced keyboard's numeric keypad.



Press **Fn + Ctrl** to simulate the enhanced keyboard's right **Ctrl** key.

Hotkeys

Hotkeys (**Fn** + another key) let you enable or disable certain features of the computers.



Sound mute: Pressing **Fn + Esc** in a Windows environment turns sound on or off. When you press these hotkeys, the current setting will be displayed as an icon.



Instant security: Press **Fn + F1** to blank the screen to prevent others from accessing your data. To restore the screen and original settings, press any key or press the Touch Pad. If a screensaver password is registered, a dialog box will appear. Enter the screensaver password and click **OK**. If no password is set, the screen will be restored when you press any key or press the Touch Pad.



Power save mode: Pressing **Fn + F2** changes the power save mode.

If you press **Fn + F2**, the Power Save Mode is displayed in a dialog box. Continue holding down **Fn** and press **F2** again to change the setting. You can also change this setting through the *Plugged in* or *Running on batteries* item of the *Power Saver Properties* window in Power Saver.



Standby: When you press **Fn + F3**, the computer can enter Standby. To avoid entering Standby unexpectedly, a dialog box appears for verification. However, if you check the checkbox in the dialog box, it will not appear from the next time.



Hibernation: When you press **Fn + F4**, the computer can enter Hibernation. To avoid entering Hibernation unexpectedly, a dialog box appears for verification. However, if you check the checkbox in the dialog box, it will not appear from the next time.



Display selection: Press **Fn + F5** to change the active display device. When you press these hot keys a dialog box appears. Only selectable devices will be displayed. Hold down **Fn** and press **F5** again to change the device. When you release **Fn** and **F5**, the selected device will change. If you hold down the keys for three seconds the selection will return to **LCD**.



LCD Display Brightness: Pressing **Fn + F6** decreases the LCD display brightness in decrements. When you press these hotkeys, the current setting will be displayed for two seconds by a pop-up icon. You can also change this setting through the *Monitor brightness* item of the *Power Save Mode* window in Power Saver.



LCD Display Brightness: Pressing **Fn + F7** increases the LCD display brightness in decrements. When you press these hotkeys, the current setting will be displayed for two seconds by a pop-up icon. You can also change this setting through the *Monitor brightness* item of the *Power Save Mode* window in Power Saver.

NOTE: You cannot change the display brightness for about 18 seconds after the LCD turns on. To protect display quality, the brightness level is set at the maximum value.



Wireless setting: If your computer has both Bluetooth and wireless LAN functions, you can press **Fn + F8** to select which type of wireless communication you want to use. When you press these hotkeys, a dialog box will appear. Continue holding down **Fn** and press **F8** to change the setting. If wireless communication is turned off, **Disabled Wireless Communication Switch** will be displayed.

NOTE: If no wireless communication device is installed, no dialog box will appear.



Touch Pad: Pressing **Fn + F9** enables or disables the Touch Pad function. When you press those hotkeys, the current setting will change and be displayed as an icon.



Display resolution selection: Press **Fn + space keys** to change the display resolution. Each time when you press these hot keys, the display resolution changes as follows: From the current resolution (the original resolution) to 1024×768, from 1024×768 to 800×600, from 800×600 to the original resolution.



Smooth View (reduce): To reduce the icon size on the desktop or the size of an application window, press the **1** key while holding down the **Fn** key.



Smooth View (enlarge): To enlarge the icon size on the desktop or the size of an application window, press the **2** key while holding down the **Fn** key.

Fn Sticky key

You can use the TOSHIBA Accessibility Utility to make the **Fn** key sticky, that is, you can press it once, release it, and then press an “**F number**” key.

Windows special keys

The keyboard provides two keys that have special functions in Windows : one activates the **Start** menu and the other has the same function as the secondary mouse button.



This key activates the Windows **Start** menu.



This key has the same function as the secondary mouse button.

Keypad overlay

Your computer’s keyboard does not have an independent numeric keypad, but its numeric keypad overlay functions like one.

The keys in the center of the keyboard with white letters make up the numeric keypad overlay. The overlay provides the same functions as the numeric keypad on the 101/102-key enhanced keyboard in figure 5-2.

Turning on the overlays

The numeric keypad overlay can be used for numeric data input or cursor and page control.

Arrow mode

To turn on the Arrow mode, press **Fn + F10**. The Arrow mode indicator lights. Now try cursor and page control using the keys shown in figure 5-2. Press **Fn + F10** again to turn off the overlay.

Numeric mode

To turn on the Numeric mode, press **Fn + F11**. The Numeric mode indicator lights. Now try numeric data entry using the keys in figure 5-2. Press **Fn + F11** again to turn off the overlay.

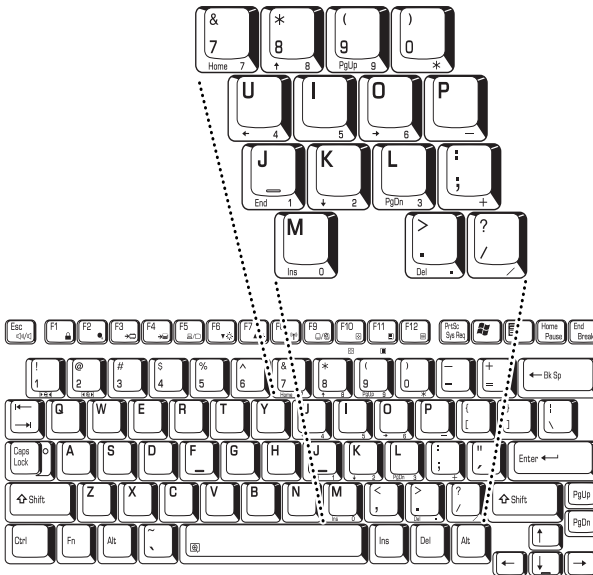

Figure 5-2 The numeric keypad overlay

Temporarily using normal keyboard (overlay on)

While using the overlay, you can temporarily access the normal keyboard without turning off the overlay:

1. Hold **Fn** and press any other key. All keys will operate as if the overlay were off.

2. Type uppercase characters by holding **Fn + Shift** and pressing a character key.
3. Release **Fn** to continue using the overlay.

Temporarily using overlay (overlay off)

While using the normal keyboard, you can temporarily use the keypad overlay without turning it on:

1. Press and hold down **Fn**.
2. Check the keyboard indicators. Pressing **Fn** turns on the most recently used overlay. If the Numeric mode indicator lights, you can use the overlay for numeric entry. If the Arrow mode indicator lights, you can use the overlay for cursor and page control.
3. Release **Fn** to return to normal keyboard operation.

Temporarily changing modes

If the computer is in **Numeric mode**, you can switch temporarily to **Arrow mode** by pressing a shift key.

If the computer is in **Arrow mode**, you can switch temporarily to **Numeric mode** by pressing a shift key.

Generating ASCII characters

Not all ASCII characters can be generated using normal keyboard operation. But, you can generate these characters using their ASCII codes.

With the overlay on:

1. Hold down **Alt**.
2. Using the overlay keys, type the ASCII code.
3. Release **Alt**, and the ASCII character appears on the display screen.

With the overlay off:

1. Hold **Alt + Fn**.
2. Using the overlay keys, type the ASCII code.
3. Release **Alt + Fn**, and the ASCII character appears on the display screen.

Chapter 6

Power and Power-Up Modes

Power conditions	6-1
Power indicators	6-3
Battery indicators	6-3
DC IN 15V indicator	6-3
Power indicator	6-4
Battery types	6-4
Battery Pack	6-4
Real time clock battery	6-5
Care and use of the Battery Pack	6-5
Safety precautions	6-6
Charging the batteries	6-9
Monitoring battery capacity	6-10
Maximizing battery operating time	6-11
Retaining data with power off	6-12
Extending battery life	6-12
Replacing the Battery Pack	6-13
Removing the Battery Pack	6-13
Installing the Battery Pack	6-15
TOSHIBA Password Utility	6-16
User password	6-16
Supervisor password	6-17
Starting the computer by password	6-18
Tablet mode	6-18
Power-up modes	6-19
Windows utilities	6-19
Hotkeys	6-19
Panel power off	6-19
System Auto Off	6-20

Power and Power-Up Modes

The computer’s power resources include the AC adaptor and internal batteries. This chapter gives details on making the most effective use of these resources including charging and changing batteries, tips for saving battery power, and power up modes.

Power conditions

The computer’s operating capability and battery charge status are affected by the power conditions: whether an AC adaptor is connected, whether a battery is installed and what the charge level is for the battery.

Table 6-1 Power conditions

		Power on	Power off (no operation)
AC adaptor connected	Battery fully charged	<ul style="list-style-type: none"> Operates LED: Battery green DC IN 15V green 	<ul style="list-style-type: none"> LED: Battery green DC IN 15V green
	Battery partially charged or no charge	<ul style="list-style-type: none"> Operates Quick charge LED: Battery orange DC IN 15V green 	<ul style="list-style-type: none"> Quick charge LED: Battery orange DC IN 15V green
	No battery installed	<ul style="list-style-type: none"> Operates No charge LED: Battery off DC IN 15V green 	<ul style="list-style-type: none"> No charge LED: Battery off DC IN 15V green

Table 6-1 Power conditions continued

		Power on	Power off (no operation)
AC adaptor not connected	Battery charge is above low battery trigger point	<ul style="list-style-type: none"> Operates LED: Battery off DC IN 15V off 	
	Battery charge is below low battery trigger point	<ul style="list-style-type: none"> Operates LED: Battery flashes in orange DC IN 15V off 	
	Battery charge is exhausted	Computer goes into resume mode and shuts down	
	No battery installed	<ul style="list-style-type: none"> Cannot operate LED: Battery off DC IN 15V off 	

Power indicators

The **Battery**, **DC IN 15V** and **Power** indicators on the system indicator panel alert you to the computer's operating capability and battery charge status.

Battery indicators

Check the **Battery** indicator to determine the status of the battery. The following indicator lights indicate the battery status:

- | | |
|--------------------|--|
| Flashing in orange | The battery charge is low. The AC adaptor must be connected to recharge the battery. |
| Orange | Indicates the AC adaptor is connected and charging the battery. |
| Green | Indicates the AC adaptor is connected and the battery is fully charged. |
| No light | Under any other conditions, the indicator does not light. |

***NOTE:** If the battery becomes too hot while it is being charged, the charge will stop and the battery indicator will go out. When the battery's temperature falls to a normal range, charging will resume. This event occurs regardless of whether the power to the computer is on or off.*

DC IN 15V indicator

Check the **DC IN 15V** indicator to determine the power status with the AC adaptor connected:

- | | |
|--------------------|---|
| Green | Indicates the AC adaptor is connected and supplying proper power to the computer. |
| Flashing in orange | Indicates a problem with the power supply. Plug the AC adaptor into another outlet. If it still does not operate properly, contact TOSHIBA dealer. Refer to Chapter 9, <i>Troubleshooting</i> . |
| No light | Under any other conditions, the indicator does not light. |

Power indicator

Check the **Power** indicator to determine the power status.

- | | |
|--------------------|--|
| Green | Indicates power is being supplied to the computer and the computer is turned on. |
| Blinking in orange | Indicates the power was turned off while the computer was in Resume mode. The indicator turns on for one second and turns off for two seconds. |
| No light | Under any other conditions, the indicator does not light. |

Battery types

The computer has two types of batteries:

- Battery Pack
- Real Time Clock (RTC) battery

Battery Pack

When the AC power cord is not connected, the computer's main power source is a removable lithium-ion Battery Pack, also referred to in this manual as the main battery. You can purchase Battery Packs for extended use of the computer away from an AC power source.

- CAUTIONS:**
- 1. The battery pack is a lithium-ion battery, which can explode if not properly replaced, used, handled or disposed of. Dispose of the battery as required by local ordinances or regulations. Use only battery recommended by TOSHIBA as replacements.*
 - 2. Do not remove the battery pack while the computer is in Standby mode. Data is stored in RAMs, so if the computer loses power it will be lost. When the computer is powered off in Standby mode, and the AC adaptor is not connected, the battery pack supplies power to maintain data and program in memory. If the battery pack is completely discharged, Standby mode does not function and the computer loses all data in memory.*

To ensure that the Battery Pack maintains its maximum capacity, operate the computer on battery power at least once a month until the Battery Pack is fully discharged. Refer to *Extending battery life* in this chapter for procedures. If the computer is continuously operated on AC power, through an AC adaptor for an extended period, more than a month, the battery may fail to retain a charge. It may not function efficiently over the expected life of the battery and the Battery LED may not indicate a low-battery condition.

Real time clock battery

The Real Time Clock (RTC) battery provides power for the internal real time clock and calendar. It also maintains the system configuration.

The RTC battery is charged when the power of the computer is on.

If the RTC battery becomes completely discharged, the system loses this data and the real time clock and calendar stop working. The following message appears when you turn on the power:

```
*** Bad RTC battery ***  
Check system. Then press [F1] key . . . . .
```

***CAUTION:** The computer's RTC battery is a lithium ion battery and should be replaced only by your dealer or by a TOSHIBA service representative. The battery can explode if not properly replaced, used, handled or disposed of. Dispose of the battery as required by local ordinances or regulations.*

***NOTE:** You can change the setting of RTC by pressing **F1** key. Refer to Chapter 9, Troubleshooting for the detail.*

Care and use of the Battery Pack

The Battery Pack is a vital component of portable computing. Taking proper care of it will help ensure longer operating time on battery power as well as a longer life for your Battery Pack. Follow the instructions in this section carefully to ensure safe operation and maximum performance.

Safety precautions

Mishandling of batteries can cause death, serious injury or property damage. Carefully observe the following advisories:

Danger: Indicates an imminently hazardous situation, which could result in death or serious injury, if you do not follow instructions.

Warning: Indicates a potentially hazardous situation, which could result in death or serious injury, if you do not follow instructions.

Caution: Indicates a potentially hazardous situation, which if not avoided, may result in moderate or minor injury of property damage.

Note: Provides important information.

Danger

1. Never try to dispose of the battery pack by burning or expose it to a heating device such as a microwave oven. The battery pack could explode and cause bodily injury.
2. Never try to disassemble, repair or otherwise tamper with a battery pack. The battery pack will overheat and ignite. Leakage of caustic alkaline solution or other electrolytic substances will cause fire or injury, possibly resulting in death or serious injury.
3. Never short-circuit the battery pack by contacting the terminals with a metal object. A short-circuit can cause fire or otherwise damage the battery pack and possibly cause injury. To avoid accidental short-circuit, always wrap the battery pack in plastic and cover the terminals with electrical tape when storing or disposing of the battery pack.
4. Never puncture the battery pack with a nail or other sharp object. Never strike it with a hammer or other object. Never step on it.
5. Never try to charge the battery pack in any manner other than that described in the user's manual. Never connect the battery pack to a plug socket or to a automobile's cigarette lighter socket. It may rupture or ignite.
6. Use only the battery pack supplied with the computer or other device or a battery pack approved by the computer or device's manufacture. Battery packs have different voltages and terminal polarities. Use of an improper battery could cause smoke, fire or rupture of the battery pack.

7. Never subject a battery pack to heat, such as storage near a heat source. Exposure to heat can cause the battery pack to ignite, explode or leak caustic liquid and cause death or serious injury. It could also fail or malfunction causing data loss.
8. Never expose the battery pack to abnormal shock, vibration or pressure. The battery pack's internal protective device will fail, causing it to overheat, explode, ignite or leak caustic liquids possibly resulting in death or serious injury.
9. Never let a battery pack become wet. A wet battery pack will overheat, ignite or rupture possibly resulting in death or serious injury.

Warning

1. Never allow caustic electrolyte fluid leaked from a battery pack to contact your eyes, skin or clothing. If caustic electrolyte fluid should contact your eyes, immediately wash your eyes with large amounts of running water and seek medical attention, to help prevent eye damage. If electrolyte fluid should contact your skin immediately wash it under running water to prevent rash. If it contacts your clothes, promptly remove them to prevent the fluid from contacting your skin or eyes.
2. Immediately turn off the power, disconnect the AC adapter and remove the battery if any of the following events are observed in the battery pack: offensive or unusual odor, excessive heat, discoloration or deformation. Never use the computer again until it has been checked by a TOSHIBA service provider. It might generate smoke or fire, or the battery pack might rupture.
3. Make sure the battery is securely installed in the computer before attempting to charge the battery pack. Improper installation could generate smoke or fire, or cause the battery pack to rupture.
4. Keep the battery pack out of reach of infants and children. It can cause injury.

Caution

1. Never continue to use a battery pack after its recharging capacity has become impaired, or after the display of a warning message indicating that the battery pack's power is exhausted. Continued use of an exhausted or impaired battery pack could cause the loss of data.
2. Never dispose of battery packs with normal trash. Bring them to your TOSHIBA dealer or to another recycling center to save resources and prevent environmental damage. Cover the terminals with electrical tape to prevent short-circuits, which could cause the battery pack to ignite or rupture.
3. Use only battery pack recommended by TOSHIBA as replacements.
4. Always make sure the battery pack is installed correctly and securely. Otherwise, a battery pack could fall out and possibly cause injury.
5. Charge the battery pack only in an ambient temperature between 5 and 35 degrees Celsius. Otherwise, the electrolyte solution might leak, battery pack performance might deteriorate and the battery life might be shortened.
6. Be sure to monitor the remaining battery power. If the battery pack and real time clock battery discharge completely, Standby and Suspend will not function and data in memory will be lost. Also, the computer might register an incorrect time and date. In this case, connect the AC adaptor to recharge the batteries.
7. Never install or remove the battery pack without first turning off the power and disconnecting the AC adaptor. Never remove the battery pack while the computer is in Suspend or Standby mode. Data will be lost.

Note

1. Never remove the battery pack while the Wake-up on LAN function is enabled. Data will be lost. Before you remove a battery pack, disable the Wake-up on LAN function.
2. To ensure the battery pack maintains maximum capacity, operate the computer on battery power once a week until the battery pack is fully discharged. Refer to the section *Extending battery life* in this chapter for procedures. If the computer is continuously operated on AC power for an extended period, more than a week, the battery might fail to retain a charge. It might not function efficiently over the expected life of the battery pack and the **Battery** indicator might not indicate a low-battery condition.
3. After the battery pack is charged, avoid leaving the AC adaptor connected and the computer turned off for more than a few hours at a time. Continuing to charge a fully-charged battery pack can damage the battery.

Charging the batteries

When the power in the Battery Pack becomes low, the **Battery** indicator flashes in orange indicating that only a few minutes of battery power remain. If you continue to use the computer while the **Battery** indicator flashes, the computer enables Resume mode (so you do not lose data) and automatically turns off.

***NOTE:** The computer enters Hibernation mode only if Hibernation is enabled in two places in TOSHIBA Power Saver: the Hibernate window and the Battery Alarm item of the Alarm window.*

You must recharge a Battery Pack when it becomes discharged.

Procedures

To recharge a Battery Pack while it is installed in the computer, connect the AC adaptor to the **DC IN 15V** socket and plug the other end into a working outlet.

The **Battery** indicator glows in orange when the battery is being charged.

***CAUTION:** Use only the computer connected to an AC power source or the optional TOSHIBA Battery charger to charge the Battery Pack. Do not attempt to charge the Battery Pack with any other charger.*

Time

The following table shows the approximate time required to fully charge a discharged battery.

Battery type	Charging time (hours)	
	Power on	Power off
Battery Pack	8.5 (approx.)	2.5 (approx.)
RTC battery	8.0	Doesn't charge

***NOTE:** The charging time when the computer is on is affected by ambient temperature, the temperature of the computer and how you use the computer. If you make heavy use of external devices, for example, the battery might scarcely charge at all during operation. Refer also to the section Maximizing battery operating time.*

Battery charging notice

The battery may not charge right away under the following conditions:

- The battery is extremely hot or cold. If the battery is extremely hot, it might not charge at all. Also, to ensure the battery charges to its full capacity, charge the battery at room temperature of 10° to 30°C (50° to 86°F).
- The battery is nearly completely discharged. Leave the AC adaptor connected for a few minutes and the battery should begin charging.

The **Battery** indicator may show a rapid decrease in battery operating time when you try to charge a battery under the following conditions:

- The battery has not been used for a long time.
- The battery has completely discharged and been left in the computer for a long time.
- A cool battery is installed in a warm computer.

In such case, follow the steps below.

1. Fully discharge the battery by leaving it in the computer with the power on until the power automatically shuts off.
2. Plug in the AC adaptor.
3. Charge the battery until the **Battery** indicator glows green.

Repeat the steps two or three times until the battery recovers normal capacity.

***NOTE:** Leaving the AC adaptor connected will shorten battery life. At least once a month, run the computer on battery power until the battery is fully discharged, then recharge the battery.*

Monitoring battery capacity

Remaining battery power can be monitored in the *Power Save Modes* window in Power Saver of Windows.

***NOTES:** 1. Wait at least 16 seconds after turning on the computer before trying to monitor the remaining operating time. The computer needs this time to check the battery's remaining capacity and to calculate the remaining operating time, based on the current power consumption rate and remaining battery capacity. The actual remaining operating time may differ slightly from the calculated time.*

2. *With repeated discharges and recharges, the battery's capacity will gradually decrease. Therefore, an often used, older battery will not operate for as long as a new battery even when both are fully charged. In this case, TOSHIBA Power Saver will indicate a 100% charge for both the old and new battery, but the displayed estimated time remaining will be shorter for the older battery.*

Maximizing battery operating time

A battery's usefulness depends on how long it can supply power on a single charge.

How long the charge lasts in a battery depends on:

- How you configure the computer, for example, whether you enable battery power saving options. The computer provides a battery save mode to conserve battery power. This mode has the following options:
 - Processing speed
 - Display auto off
 - HDD auto off
 - System auto off
 - LCD Brightness
- How often and how long you use the hard disk and the diskette drive.
- How much charge the battery contained to begin with.
- How you use optional devices, such as a PC card, to which the battery supplies power.
- Enabling Resume mode conserves battery power if you are frequently turning the computer off and on.
- Where you store your programs and data.
- Closing the display when you are not using the keyboard saves power.
- Operating time decreases at low temperatures.
- The condition of the battery terminals. Make sure the battery terminals stay clean by wiping them with a clean dry cloth before installing the Battery Pack.

Retaining data with power off

When you turn off your computer with fully charged batteries, the batteries retain data for the following approximate time periods:

Battery pack (4400 mAh)	5 days (approx. in Resume mode)
	60 days (approx. in Boot mode)
RTC battery	1 month

Extending battery life

To maximize the life of your Battery Pack:

- At least once a month, disconnect the computer from a power source and operate it on battery power until the Battery Pack fully discharges. Before doing so, follow the steps below.
 1. Turn off the computer's power.
 2. Disconnect the AC adaptor and turn on the computer's power. If it does not turn on go to step 4.
 3. Operate the computer on battery power for five minutes. If the Battery Pack has at least five minutes of operating time, continue operating until the Battery Pack is fully discharged. If the **Battery** indicator flashes or there is some other warning to indicate a low battery, go to step 4.
 4. Connect the AC adaptor to the computer and the power cord to a power outlet. The **DC IN 15V** indicator should glow in green, and the **Battery** should glow in orange to indicate that the Battery Pack is being charged. If the **DC IN 15V** indicator does not glow, power is not being supplied. Check the connections for the AC adaptor and power cord.
 5. Charge the Battery Pack until the **Battery** indicator glows in green.
- If you have spare Battery Packs, rotate their use.
- If you will not be using the system for an extended period, more than one month, remove the Battery Pack.
- Disconnect the AC adaptor when the battery is fully charged. Overcharging makes the battery hot and shortens life.
- If you are not going to use the computer for more than eight hours, disconnect the AC adaptor.
- Store spare Battery Packs in a cool dry place out of direct sunlight.

Replacing the Battery Pack

When the Battery Pack reaches the end of its operating life you will need to install a new one. The life of the Battery Pack is generally about 500 recharges. If the **Battery** indicator flashes in orange shortly after fully recharging the battery, the Battery Pack needs to be replaced.

You might also replace a discharged Battery Pack with a charged spare when you are operating your computer away from an AC power source. This section explains how to remove and install Battery Packs.

***NOTE:** Place a mat beneath the computer to prevent making a scratch on the lid when replacing the Battery pack. Avoid the mat that generates static electricity.*

Removing the Battery Pack

To replace a discharged Battery Pack, follow the steps below.

- CAUTIONS:** 1. When handling battery packs, be careful not to short circuit the terminals. Also do not drop, hit or otherwise apply impact; do not scratch or break the casing and do not twist or bend the battery pack*
- 2. Do not remove the battery pack while the computer is in Standby mode. Data is stored in RAM, so if the computer loses power it will be lost.*
- 3. In Hibernation mode, data will be lost if you remove the battery or disconnect the AC adaptor before the save is completed. Wait for the **Disk** indicator to go out.*
1. Save your work.
 2. Turn the computer's power off. Make sure the **Power** indicator is off.
 3. Remove all cables connected to the computer.
 4. Turn the computer upside down with the front side of the computer facing to you.
 5. Release the battery lock.
 6. Slide the battery release latch to free the battery pack for removal.

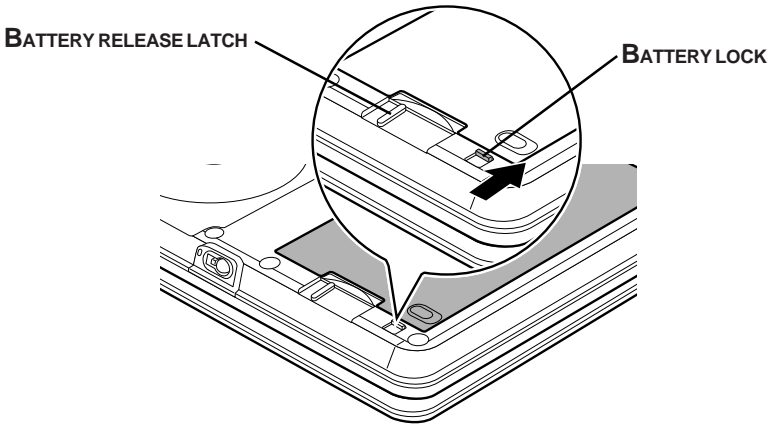

Figure 6-1 Removing the Battery Pack (1)

7. The battery pack is removed the whole battery cover, applying a finger to a hollow, sliding the battery release latch.

CAUTION: For environmental reasons, do not throw away a spent Battery Pack. Please return spent Battery Packs to your TOSHIBA dealer.

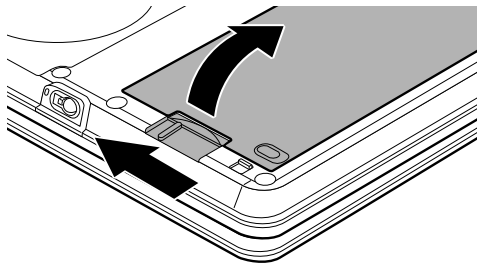

Figure 6-2 Removing the Battery Pack (2)

Installing the Battery Pack

To install a Battery Pack, follow the steps below.

CAUTION: *The Battery Pack is a lithium-ion battery, which can explode if not properly replaced, used, handled or disposed of. Dispose of the battery as required by local ordinances or regulations. Use only battery recommended by TOSHIBA as replacements.*

1. Be sure the computer's power is off and all cables are disconnected.
2. Inserts calmly until the battery pack in the connector aslant and there until it clicks.
3. Secure the battery lock.

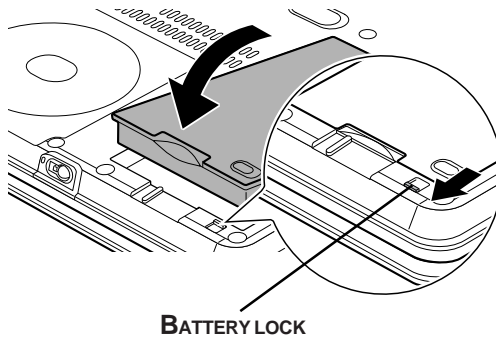

Figure 6-3 Installing the Battery Pack

TOSHIBA Password Utility

The TOSHIBA Password Utility provides two levels of password security: User and Supervisor.

NOTE: Passwords set in TOSHIBA Password Utility are different from the Windows password.

User password

To start the utility, point to or click the following items:

**Start -> All Programs -> TOSHIBA Utilities ->
TOSHIBA Password Utility**

The user password dialog box contains two main fields: **User Password** and **User Token**.

User Password field

Set (button)

Click this button to register a password of up to 50 characters. After a password is set, you will be prompted to enter it when you start the computer.

NOTE: After you set the password, a dialog box will be displayed asking whether you want to save it to a diskette or other media. If you forget the password, you can open the password file on another computer. Be sure to keep the media in a safe place.

Delete (button)

Click this button to delete a registered password. Before you can delete a password, you must first enter the current password correctly or insert a proper token.

Change (button)

Click this button to change a registered password. Before you can change a password, you must first enter the current password correctly or insert a proper token.

Owner String (text box)

You can use this box to associate text with the password. After you enter text, click **Apply** or **OK**. The text will be displayed when you are prompted to enter a password.

User Token field

Create (button)

You can use an SD card token, instead of entering the password. After you have registered a password, insert an SD card and click **Create**. You can use an SD card of any capacity, but it must be formatted correctly.

If an unformatted card or one with an incompatible format is inserted, you will be prompted to format it with a tool named TOSHIBA SD Memory Card Format. To start the format tool, point to or click the following items:

Start -> All Programs -> TOSHIBA SD Card

Utilities -> TOSHIBA SD Memory Card Format

***CAUTION:** When you format an SD Memory card, all data will be deleted. Be sure to save data on the card to other media before you format the card.*

Disable (button)

Click this button to invalidate the token. You cannot revalidate old tokens, but you can use the same SD cards to create new tokens.

Supervisor password

If you set a supervisor password, some functions might be restricted when a user logs on with the user password. To set a supervisor password, execute the file TOSUP.EXE. The file is located at:

**C:\Program Files\Toshiba\Windows
Utilities\SVPWTool\TOSUP.EXE**

This utility lets you do the following:

- Register, delete or change the supervisor password.
- Create or invalidate a supervisor token

***NOTE:** This function in the TOSHIBA password utility lets you invalidate only supervisor tokens or all tokens, including user and supervisor tokens.*

- Specify restrictions for general users.

Starting the computer by password

If you registered a password, there are two ways to start the computer:

- Insert a password token before you turn on the computer. The computer will start normally, without displaying a password prompt.
- Enter the password manually.

***NOTE:** The password is necessary only if the computer was shut down in boot mode. It is not needed in Hibernation or Standby mode.*

To enter a password manually, follow these steps:

1. Turn on the power as described in Chapter 3, *Getting Started*. The following message will appear in the LCD:
Password=
2. Enter the Password.
3. Press Enter.

***NOTE:** If you enter the password incorrectly three times in a row, the computer shuts off. In this case, you must turn the computer back on to retry password entry.*

Tablet mode

Enter your password by tapping the on-screen keyboard using the tablet pen.

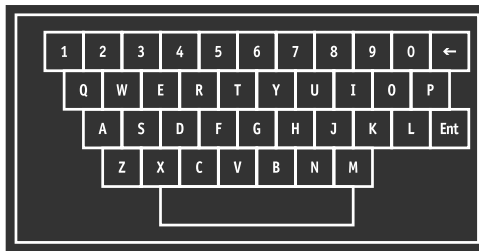

Figure 6-4 On-screen keyboard

- ❑ The beep sounds when tapping the on-screen keyboard with the tablet pen. An * (asterisk) is displayed after "Password =" and one character is input for every tapping.

NOTE: Register your password to the computer in the laptop mode using the standard keyboard. Refer to Chapter 7, HW Setup for the detail.

Power-up modes

The computer has the following power-up modes:

- ❑ Boot: Computer shuts down without saving data. Always save your work before you turn the computer off in boot mode.
- ❑ Hibernation: Data in memory is saved to the hard disk.
- ❑ Standby: Data is maintained in the computer's main memory.

NOTE: Refer also to the sections Turning on the power and Turning off the power in Chapter 3, Getting Started.

Windows utilities

You can specify the setting in TOSHIBA Power Saver.

Hotkeys

You can use hotkeys Fn + F3 to enter Standby mode and Fn + F4 to enter Hibernation. See Chapter 5, *The Keyboard* for details.

Panel power off

You can set up your computer so that power turns off automatically when you close the display panel. When you open the panel, power turns on in Standby or Hibernation mode but not in boot mode.

However, when the system is running in the tablet mode, it does not shut down even if the display panel is closed.

NOTE: If the panel power off function is enabled and you use Shut down Windows, do not close the display until the shut down function is completed.

System Auto Off

This feature turns the system off automatically if the computer is not used for a set duration. The system shuts down in Standby mode or Hibernation mode in Windows.

However, when the system is running in the tablet mode, it does not shut down even if the display panel is closed.

Chapter 7

HW Setup

HW Setup	7-1
Accessing HW Setup	7-1
HW Setup window	7-1

HW Setup

This chapter explains how to use TOSHIBA HW Setup program to configure your computer. TOSHIBA HW Setup lets you configure settings for display, CPU, boot priority, Keyboard, USB, LAN, general and device configuration.

Accessing HW Setup

To run HW Setup, click **start**, click **Control Panel**, click **Printers and Other Hardware** and select **TOSHIBA HW Setup**.

HW Setup window

The HW Setup window contains the following tabs: Display, CPU, Boot Priority, Keyboard, USB, LAN, General, Device Config.

General

This window displays the BIOS version and contains two buttons: **Default** and **About**.

- Default** Return all HW Setup values to the factory settings.
- About** Display the HW Setup version.

Setup

This field displays **BIOS Version** and date.

Device Config

Device Configuration

This option lets you set the device configuration.

- All Devices** BIOS sets all devices.
- Setup by OS** Operating system sets devices that it can control. (Default)

Display

This tab lets you customize your computer's display settings for either the internal LCD screen or for an external monitor.

Power On Display

Lets you set the display to be used when the computer is booted.

- Auto-Selected** Selects an external monitor if one is connected. Otherwise, it selects the internal LCD. (Default)
- LCD+Analog RGB** Selects both the internal LCD and external monitor for simultaneous display.
- System LCD Only** Selects the internal LCD even if the external monitor is connected.

CPU

Dynamic CPU Frequency Mode

This option lets you choose from the following settings:

- Dynamically Switchable** CPU power consumption and clock speed automatic switching function is enabled. When the computer is in use, CPU operation is automatically switched when necessary. (Default)
- Always High** CPU power consumption and clock speed automatic switching function is disabled. The CPU always runs at its fastest speed.
- Always Low** CPU power consumption and clock speed automatic switching function is disabled. The CPU always runs at low power consumption and low speed.

Boot Priority

Boot Priority Options

This option sets the priority for booting the computer. Select from the following settings:

- | | |
|---------------------------------|---|
| HDD → FDD → CD-ROM → LAN | The computer looks for bootable files in the following order: HDD, diskette drive* ¹ , CD-ROM* ² and LAN. (Default) |
| FDD → HDD → CD-ROM → LAN | The computer looks for bootable files in the following order: diskette drive* ¹ , HDD, CD-ROM* ² and LAN. |
| HDD → CD-ROM → LAN → FDD | The computer looks for bootable files in the following order: HDD, CD-ROM* ² , LAN and diskette drive* ¹ . |
| FDD → CD-ROM → LAN → HDD | The computer looks for bootable files in the following order: diskette drive* ¹ , CD-ROM* ² , LAN and HDD. |
| CD-ROM → LAN → HDD → FDD | The computer looks for bootable files in the following order: CD-ROM* ² , LAN, HDD, diskette drive* ¹ . |
| CD-ROM → LAN → FDD → HDD | The computer looks for bootable files in the following order: CD-ROM* ² , LAN, diskette drive* ¹ and HDD. |

*¹ FDD is looked for when the boot disk is contained in external FDD. When SD card is set as the boot disk, external FDD is looked for first. Next, SD card is looked for.

*² The CD-ROM is available only with the optional optical disk drive.

You can override the settings and manually select a boot device in one of the following two ways.

Press one of the following keys while the computer is booted:

- U** Selects the USB diskette drive.
- N** Selects the Network.
- 1** Selects the primary HDD.
- P** Selects the PC card HDD.
- C** Selects the CD-ROM*¹.

This procedure does not affect the settings.

Use hot keys.

1. Hold down **F12** and boot the computer.
2. The following menu will be displayed with the following icons: Built-in HDD, CD-ROM, FDD, and SD, Network (LAN), PCA (ATA) card boot.



NOTE: A bar will appear only under the selected device.

3. Use the left/right cursor keys to highlight the boot device you want and press **Enter**.

- NOTES:**
1. *If a supervisor password is set, the menu above does not appear when you use the user password to start the computer.*
 2. *The selection method above does not change the boot priority settings in HW Setup.*
 3. *If you press a key other than one of those above or if the selected device is not installed, the system will boot according to the current setting in HW Setup.*

HDD Priority Options

This option sets the priority for booting the computer from the HDD. Select from the following settings:

Built-in HDD → PC Card (Default)

The computer will look for the Built-in HDD first, next the the PC Card (Default).

PC Card → Built-in HDD

The computer will look for the PC Card first, next the Built-in HDD.

NOTE: *If a boot command is not found on the first detected HDD, the system will not boot from the other HDD. It will search the next device in the boot priority for a boot command.*

Network Boot Protocol

This feature sets the protocol to remotely boot from the network.

[PXE] Sets PXE as the protocol. (Default)

[RPL] Sets RPL as the protocol.

- NOTES:**
1. *PC card HDD boot is supported only by the PC card slot on the computer. Support is guaranteed only for TOSHIBA PC card HDDs.*
 2. *When you assign a PC card HDD top priority, “PC” is not displayed. However, the PC card HDD takes the position of HDD in the Boot Priority Options list above.*

Keyboard

Wake-up on Keyboard

When this feature is enabled and the computer is in Standby mode, you can turn on the computer by pressing any key. It is effective only for the internal keyboard and only when the computer is in Standby mode.

Enabled Enables the Wake-up on Keyboard.

Disabled Disables the Wake-up on Keyboard. (Default)

USB

USB KB/Mouse Legacy Emulation

Use this option to enable or disable USB KB/Mouse Legacy Emulation. If your operating system does not support USB, you can still use a USB mouse and keyboard by setting the **USB KB/Mouse Legacy Emulation** item to **Enabled**.

Enabled Enables the USB KB/Mouse Legacy Emulation. (Default)

Disabled Disables the USB KB/Mouse Legacy Emulation.

USB-FDD Legacy Emulation

Use this option to enable or disable USB-FDD Legacy Emulation.

- Enabled** Enables the USB-FDD Legacy Emulation. (Default)
- Disabled** Disables the USB-FDD Legacy Emulation.

LAN

Wake-up on LAN

This feature lets the computer's power be turned on when it receives a wake-up signal from the LAN.

- Enabled** Enables Wake-up on LAN.
- Disabled** Disables Wake-up on LAN. (Default)

***CAUTION:** Do not install or remove an optional memory module while Wake-up on LAN is enabled.*

***NOTE:** Wake-up on LAN does not work without the AC adaptor. Leave it connected, if you are using this feature.*

Built-in LAN

- Enabled** Enables built-in LAN functions. (Default)
- Disabled** Disables built-in LAN functions.

Chapter 8

Optional Devices

PC cards	8-2
Inserting a PC card	8-2
Removing a PC card	8-3
SD cards	8-3
Inserting an SD card	8-4
Removing an SD card	8-4
Memory expansion	8-6
Installing memory module	8-7
Removing memory module	8-9
Battery Pack	8-10
Universal AC Adaptor	8-10
Battery Charger	8-11
USB diskette Kit	8-11
Tablet Multi Dock	8-11
External monitor	8-12
Tablet PC Pen set	8-12
Reserve pen	8-12
Security lock	8-13

OPTIONAL DEVICES

Optional Devices

Optional devices can expand the computer's capabilities and its versatility. The following optional devices are available from your TOSHIBA dealer:

Cards/memory

- PC cards
- SD cards
- Memory module

Power devices

- Battery Pack
- Universal AC Adaptor
- Battery Charger

Peripheral devices

- Hard disk drive pack
- USB diskette Kit
- Tablet Multi Dock
- External monitor
- Tablet PC Pen set
- Reserve Pen

Other

- Security lock

PC cards

The computer is equipped with a PC card expansion slot that can accommodate one 5 mm Type II card. Any PC card that meets industry standards (manufactured by TOSHIBA or other vendor) can be installed. The slots support 16-bit PC cards, including PC card 16's multifunction card and Card Bus PC cards.

Card Bus supports the new standard of 32-bit PC cards. The bus provides superior performance for the greater demands of multimedia data transmission.

Inserting a PC card

The PC card connector is located on the left side of the computer.

Windows' not-installed feature lets you insert PC cards while the computer's power is on.

- NOTES:**
1. Do not insert a PC card while the computer is in standby or hibernation mode. Some cards might not work properly.
 2. An HDD or CD-ROM connected to a 16-bit PC card, might affect the performance of the computer's sound system and data transmission, including slower transmission speeds and dialing errors.

To insert a PC card, follow the steps below:

1. Insert the PC card.
2. Press gently to ensure a firm connection.

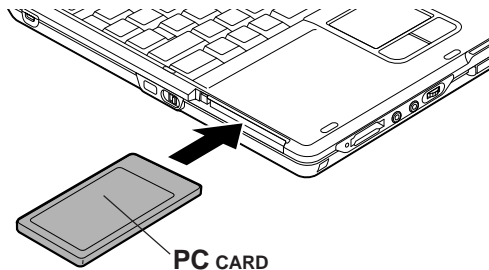

Figure 8-1 Inserting the PC card

After inserting the card, refer to the card's manual and check the configuration in Windows to make sure it is appropriate for your card.

Removing a PC card

To remove the PC card, follow the steps below:

1. Click the **Safety Remove Hardware** icon on the Task Bar.
2. Click **PC card**.
3. Press the PC card eject button to extend it.
4. Press the extended eject button to pop the card out slightly.
5. Pinch the PC card and draw it out.

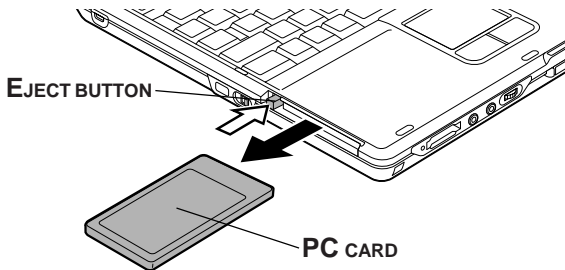

Figure 8-2 Removing the PC card

SD cards

The computer is equipped with an SD card slot that can accommodate Secure Digital flash memory cards with various capacities. SD cards let you easily transfer data from devices, such as digital cameras and Personal Digital Assistants, that use SD card flash-memory. The cards have a high level of security and copy protection features.

You can use an SD card of memory module.

The slot cannot accommodate Multi Media cards.

- CAUTIONS:**
1. *Keep foreign objects out of the SD card slot. A pin or similar object can damage the computer's circuitry.*
 2. *Do not format an SD memory card in Windows, My Computer screen. It might cause that the SD memory card cannot be used by a digital camera or an audio player.*

***NOTE:** SD memory cards comply with SDMI (Secure Digital Music Initiative), which is a technology adapted to prevent unlawful copy of playback of digital music. For this reason, you cannot copy or playback protected material on another computer or other device. You may not use the reproduction of any copyrighted material except for your personal enjoyment.*

Inserting an SD card

To insert an SD card, follow the steps below.

1. Insert the SD card.
2. Press gently to ensure a firm connection.

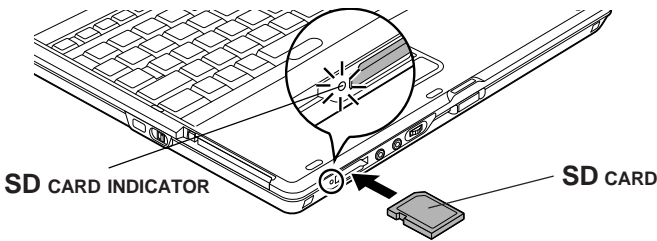

Figure 8-3 Inserting an SD card

***CAUTION:** Make sure the SD card is oriented properly before you insert it.*

Removing an SD card

To remove an SD card, follow the steps below:

1. Click the **Safety Remove Hardware** icon on the Task Bar.
2. Point to **SD card** and click.
3. Push in the card and release it to pop the card out slightly.

4. Pinch the SD card and draw it out.

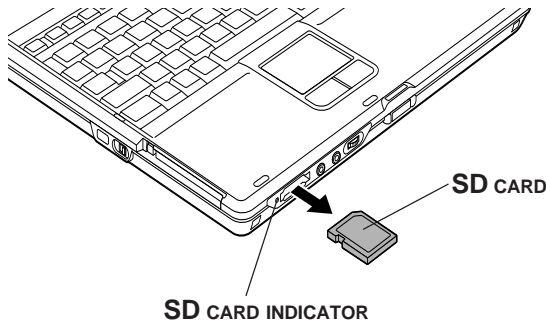

Figure 8-4 Removing an SD card

CAUTION: Make sure the **SD card** indicator is out before you remove the card or turn off the computer's power. If you remove the card or turn off the power while the computer is accessing the card you may lose data or damage the card.

SD card care

CAUTION: Set the write-protect switch to the lock position, if you do not want to record data.

1. Do not write in an SD card if the battery power is low. Low power could affect writing accuracy.
2. Do not remove an AD card while read/write is in progress.
3. The SD card is designed so that it can be installed only one way. Do not try to force the card into the slot.
4. Do not leave an SD card partially inserted in the slot. Press the SD card until you hear it click into place.
5. Do not twist or bend SD cards.
6. Do not expose SD cards to liquids or store in humid areas or lay media close to containers of liquid
7. After using an SD card, return it to its case.
8. Do not touch the metal part or expose it to liquids or let it get dirty.

Formatted SD cards

Usually new SD cards are pre-formatted before shipping.

When you reformat the formatted SD cards, select the Toshiba SD card format as a format type. Formatted SD cards can also be reformatted with devices that use this type of memory card (digital cameras and audio players).

Refer to the manual or help provided with devices you are using for instructions to format SD cards on these devices.

- NOTES:**
- 1. Do not format SD cards on Windows (My Computer screen). In some cases, these cards cannot be used on other devices including digital cameras and audio players.*
 - 2. Reformatting will delete any information on the SD card. Be careful when you reformat SD cards that contain information.*

Memory expansion

This computer is equipped with two memory module sockets; Slot A beneath the keyboard and Slot B in the backside of the computer. You can increase the amount of RAM to 1024MB by installing an additional memory or replacing default memories with additional memories.

- NOTES:**
- 1. Observe the following instructions according to the model you purchased.*
 - a. Install an additional memory module to Slot B for the computer with vacant Slot B.*
 - b. You can increase the memory amount by replacing the memory module in Slot A and/or B with a memory module of larger memory amount when both Slot A and Slot B are occupied. However, replacing of memory module in Slot B is recommended because it is easier to replace the memory module in Slot B than A.*
 - c. It is strongly recommended to leave the replacing of memory module preinstalled in Slot A to TOSHIBA dealer because the installing or replacing of memory module in Slot A needs skill.*

2. Place a mat beneath the computer to prevent making a scratch on the lid when replacing the memory module. Avoid the mat that generates static electricity.

CAUTIONS: 1. Use only memory modules approved by TOSHIBA.

2. Do not try to install or remove a memory module under the following conditions. You can damage the computer and the module. Also, data will be lost.

- a. The computer is turned on.
- b. The computer was shut down using the Standby mode or Hibernation mode.
- c. Wake-up on LAN is enabled.

If you install a memory module that is not compatible with the computer, beep will sound when you turn on the power. If the module is installed in slot A, there will be a long beep (1 second) followed by two short beeps (0.5 second each). If the memory module is in slot B, there will be a long beep followed by four short beeps. If the both memory modules in slot A and slot B are incompatible, there will be a long beep followed by two short beeps and after a pause (1 second) a long beep followed by four short beeps. In this case, shut down the power and remove the incompatible module(s).

CAUTION: Be sure to install memory module to Slot A. The computer does not boot when Slot A is vacant.

NOTE: Use a 1-bit, Phillips screwdriver to remove and fasten screws. Use of an incorrect screwdriver can damage the screw heads.

Installing memory module

Follow the steps below to install a memory module.

1. Save data, shutdown Windows and turn the power off.
2. Remove the AC adapter cable and other cables from the computer.

3. Close the display panel and turn the computer over. Remove the Battery Pack.
4. Remove a screw on the cover of the memory module slot.

NOTE: Be careful that the removed screw will not be fallen into the memory module slot.

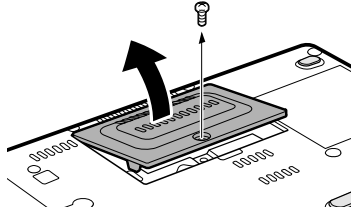

Figure 8-5 Removing the memory module cover

5. Insert the memory module obliquely against the connector of the memory module slot. Gently push the memory module until it is secured in place.

NOTES: 1. The memory module slot consists of two sub slots (connectors): Slot A (lower slot) and Slot B (upper slot).
2. Align the grooves of the memory module with the locking tabs of the connector and insert the module into the connector firmly. If you find it difficult to install the memory module, try to adjust the tabs of the connector with a pen tip or other tools. Make sure to hold the memory module with your fingers on the side edges (sides with grooves).

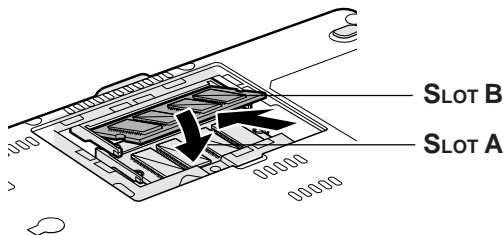

Figure 8-6 Inserting a module (1)

6. Reinstall the cover of the memory module slot. Fasten the screw you removed in Step 4.

NOTE: Be sure that the cover is closed firmly.

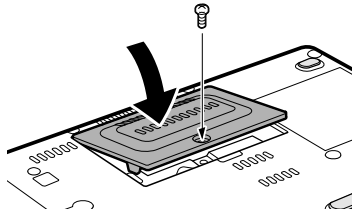

Figure 8-7 Seating the memory module cover

7. Reinstall the Battery Pack.

NOTE: After installing a memory module, turn the power of the computer on to see a total memory size. The system will calculate the total memory size.

Removing memory module

To remove the memory module, make sure the computer is in boot mode then:

1. Save data, shutdown Windows and turn the power off.
2. Remove the AC adapter cable and other cables from the computer.
3. Close the display panel and turn the computer over. Remove the Battery Pack.
4. Remove a screw on the cover of the memory module slot.

NOTE: Be careful that the removed screw will not be fallen into the memory module slot.

5. Push slightly outwards the latch tabs on both sides that secure the memory module with a pen tip or other tools, and remove the memory module.

NOTE: When the memory module rises obliquely, you can remove it from the slot.

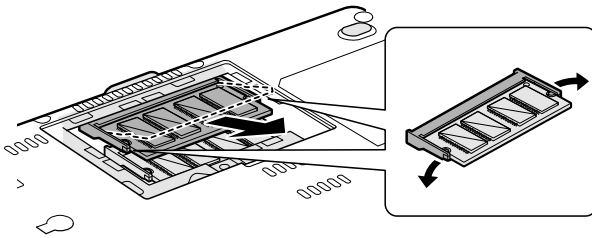

Figure 8-8 Removing the memory module

6. Reinstall the cover of the memory module slot. Fasten the screw you removed in Step 4.
7. Reinstall the Battery Pack.

NOTE: After installing a memory module, turn the power of the computer on to see a total memory size. The system will calculate the total memory size.

Battery Pack

You can increase the portability of the computer with Battery Packs. If you're away from an AC power source, you can replace a low battery with a fully charged one. See Chapter 6, *Power and Power-Up Modes*.

Universal AC Adaptor

If you frequently transport the computer between different sites such as your home and office, purchasing an AC adaptor (PA3282 or PA3283) for each location will reduce the weight and bulk of your carrying load. The AC adaptor (PA3282) is included in the product when purchased.

Battery Charger

The battery charger (PA3091U) provides a convenient way to charge battery packs without requiring the use your computer. The battery charger holds up to two Lithium-ion battery packs.

USB diskette Kit

The 3 1/2" external diskette drive module can be connected to the USB port. For details on connecting the 3 1/2" external diskette drive module, refer to Chapter 4, *Operating Basics*.

Tablet Multi Dock

In addition to the ports available on the computer, the Tablet Multi Dock provides, audio line-out jack.

The Tablet Multi Dock connects directly to the docking interface on the bottom of the computer. The AC adaptor connects the Tablet Multi Dock to a power source.

CAUTION: *The computer must be configured properly before connecting to a LAN. Logging onto a LAN using the computer's default settings could cause a malfunction in LAN operation. Check with your LAN administrator regarding set-up procedures.*

NOTE: *You must connect the AC adaptor before you connect to a Tablet Multi Dock.*

The following ports and accessories are available on the Tablet Multi Dock.

- One RJ45 LAN jack
- External monitor port
- DCIN 15V socket
- Security lock slot
- Audio line-out jacks
- Universal Serial Bus (three) ports
- SlimSelectBay Slot

NOTE: *When a Tablet Multi Dock is connected to the computer, remove all cables connected to the computer.*

External monitor

An external analog monitor can be connected to the external monitor port on the computer. The computer supports VGA and Super VGA video modes. To connect a monitor, follow the steps below.

1. Turn the computer off.
2. Connect the monitor to the external monitor port.
3. Turn the monitor's power on.
4. Turn the computer on.

When you turn on the power, the computer automatically recognizes the monitor and determines whether it is color or monochrome.

To change the display settings, press **Fn + F5**. If you disconnect the monitor before you turn the computer off, be sure to press **Fn + F5** to switch to the internal display. Refer to Chapter 5, *The Keyboard*, for details on using hot keys to change the display setting.

Tablet PC Pen set

Use it as a spare to your computer. Spare pen tip and draw-out tool are included. Refer to Chapter 6, *Power and Power-Up Modes*, for the detailed usage.

Reserve pen

Supplied pen uses a pen instead of Supplied pen at the time of loss or breakage. The pen is set inside the computer, which connects a battery pack. Refer to Chapter 6, *Power and Power-Up Modes*, for the detailed usage.

Security lock

A security lock enables you to anchor your computer to a desk or other heavy object to help prevent unauthorized removal of the computer.

Attach one end of a cable to the desk and the other end to the security lock slot on the left side or right side of the computer.

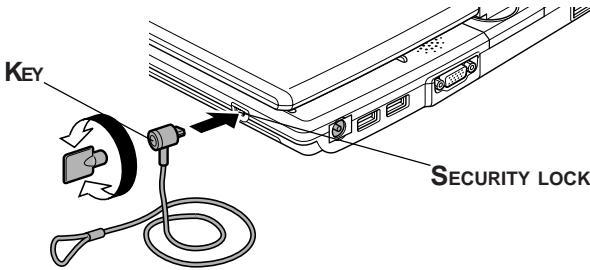

Figure 8-9 Security lock

Chapter 9

Troubleshooting

Problem solving process	9-1
Preliminary checklist	9-1
Analyzing the problem	9-2
Hardware and system checklist	9-3
System start-up	9-3
Self test	9-4
Power	9-4
Password	9-7
Keyboard	9-8
LCD panel	9-8
Hard disk drive	9-9
Diskette drive	9-9
Infrared port	9-10
Pointing device	9-10
PC card	9-13
SD card	9-14
Monitor	9-14
Sound system	9-15
USB	9-15
Memory expansion	9-16
Standby/Hibernation	9-17
Modem	9-17
LAN	9-19
Wireless LAN	9-19
Bluetooth	9-20
Real Time Clock	9-20
TOSHIBA support	9-21
Before you call	9-21
Where to write	9-21

Troubleshooting

TOSHIBA designed the computer for durability. However, should problems occur, following the procedures in this chapter can help to determine the cause.

All readers should become familiar with this chapter. Knowing what might go wrong can help prevent problems from occurring.

Problem solving process

Resolving problems will be much easier if you observe the following guidelines:

- Stop immediately when you recognize a problem exists. Further action may result in data loss or damage. You may destroy valuable problem-related information that can help solve the problem.
- Observe what is happening. Write down what the system is doing and what actions you performed immediately before the problem occurred. If you have a printer attached, print a copy of the screen using **PrtSc**.

The questions and procedures offered in this chapter are meant as a guide, they are not definitive problem solving techniques. Many problems can be solved simply, but a few may require help from your dealer. If you find you need to consult your dealer or others, be prepared to describe the problem in as much detail as possible.

Preliminary checklist

Consider the simplest solution first. The items in this checklist are easy to fix and yet can cause what appears to be a serious problem.

- Make sure you turn on all peripheral devices before you turn on the computer. This includes your printer and any other external device you are using.
- Before you attach an external device, turn the computer off. When you turn the computer back on it recognizes the new device.
- Make sure all options are set properly in the setup program.
- Check all cables. Are they correctly and firmly attached? Loose cables can cause signal errors.
- Inspect all connecting cables for loose wires and all connectors for loose pins.

- Check that your diskette is correctly inserted and that the diskette's write protect tab is correctly set.

Make notes of your observations and keep them in a permanent error log. This will help you describe your problems to your dealer. If a problem recurs, the log will help you identify the problem faster.

Analyzing the problem

Sometimes the system gives clues that can help you identify why it is malfunctioning. Keep the following questions in mind:

- Which part of the system is not operating properly: keyboard, diskette drives, hard disk drive, printer, display. Each device produces different symptoms.
- Is the operating system configuration set properly? Check the configuration options.
- What appears on the display screen? Does it display any messages or random characters? Print a copy of the screen if you have a printer attached. Look up the messages in the software and operating system documentation. Check that all connecting cables are correctly and firmly attached. Loose cables can cause erroneous or intermittent signals.
- Do any icons light? Which ones? What color are they? Do they stay on or blink? Write down what you see.
- Do you hear any beeps? How many? Are they long or short? Are they high pitched or low? Is the computer making any unusual noises? Write down what you hear.

Record your observations so you can describe them to your dealer.

Software The problems may be caused by your software or diskette. If you cannot load a software package, the media (usually a diskette) may be damaged or the program might be corrupted. Try loading another copy of the software.

If an error message appears while you are using a software package, check the software documentation. These documents usually include a problem solving section or a summary of error messages.

Next, check any error messages in the OS documentation.

Hardware If you cannot find a software problem, check your hardware. First run through the items in the preliminary checklist above. If you still cannot correct the problem, try to identify the source. The next section provides checklists for individual components and peripherals.

Hardware and system checklist

This section discusses problems caused by your computer's hardware or attached peripherals. Basic problems may occur in the following areas:

- | | |
|--|---|
| <input type="checkbox"/> System start-up | <input type="checkbox"/> SD card |
| <input type="checkbox"/> Self test | <input type="checkbox"/> Monitor |
| <input type="checkbox"/> Power | <input type="checkbox"/> Sound system |
| <input type="checkbox"/> Password | <input type="checkbox"/> USB |
| <input type="checkbox"/> Keyboard | <input type="checkbox"/> Memory expansion |
| <input type="checkbox"/> LCD panel | <input type="checkbox"/> Modem |
| <input type="checkbox"/> Hard disk drive | <input type="checkbox"/> Stand by / Hibernation |
| <input type="checkbox"/> Diskette drive | <input type="checkbox"/> LAN |
| <input type="checkbox"/> Infrared port | <input type="checkbox"/> Wireless LAN |
| <input type="checkbox"/> Pointing device | <input type="checkbox"/> Bluetooth |
| <input type="checkbox"/> PC card | <input type="checkbox"/> RealTimeClock (RTC) |

System start-up

When the computer does not start properly, check the following items:

- Self Test
- Power Sources
- Power-on Password

Self test

When the computer starts up, the self-test will be run automatically, and the following will be displayed:

```
In Touch with Tomorrow  
TOSHIBA
```

This message remains on the screen for a few seconds.

If the self test is successful, the computer tries to load the operating system, depending on how the Boot Priority is set in the HW Setup program.

If any of the following conditions are present, the self test failed:

- The computer stops and does not proceed to display information or messages.
- Random characters appear on the screen, and the system does not function normally.
- The screen displays an error message.

Turn off the computer and check all cable connections. If the test fails again, contact your dealer.

Power

When the computer is not plugged into an AC adaptor, the Battery Pack is the primary power source. However, your computer has a number of other power resources, including intelligent power supply and Real Time Clock battery. These resources are interrelated and any one could affect apparent power problems. This section provides check lists for AC adaptor and the main battery. If you cannot resolve a problem after following them, the cause could lie with another power resource. In such case, contact your dealer.

Overheating power down

If the computer's internal temperature becomes too high, the computer will automatically enter Hibernation or Resume mode and shut down.

Problem	Procedure
Computer shuts down DC IN 15V indicator blinks orange	Leave the computer off until the DC IN 15V and indicator stops blinking. <i>NOTE: It is recommended to leave the computer off until the its interior reaches room temperature even though the DC IN 15V indicator stops blinking.</i> If the computer has reached room temperature and still does not start, or if it starts but shuts down quickly contact your dealer.
Computer shuts down and its DC IN 15V indicator is flashing in green	Indicates a problem with the heat dispersal system. Please contact your dealer.

AC power

If you have trouble turning on the computer with the AC adaptor connected, check the **DC IN 15V** indicator. Refer to Chapter 6, *Power and Power-Up Modes* for more information.

Problem	Procedure
AC adaptor doesn't power the computer (DC IN 15V indicator does not glow green)	Check the connections. Make sure the cord is firmly connected to the computer and a power outlet.

Check the condition of the cord and terminals. If the cord is frayed or damaged, replace it. If the terminals are soiled, wipe them with cotton or a clean cloth.

If the AC adaptor still does not power the computer, contact your dealer.

Battery

If you suspect a problem with the battery, check the **DC IN 15V** indicator as well as the **Battery** indicator. For information on indicators and battery operation see Chapter 6, *Power and Power-Up Modes*.

Problem	Procedure
Battery doesn't power the computer	The battery may be discharged. Connect the AC adaptor to charge the battery.
Battery doesn't charge when the AC adaptor is attached (Battery indicator does not glow in orange.)	<p>If the battery is completely discharged, it will not begin charging immediately. Wait a few minutes.</p> <p>If the battery still does not charge, make sure the outlet of the AC adaptor is supplying power. Test it by plugging in an appliance.</p> <hr/> <p>Check whether the battery is hot or cold to the touch. If the battery is too hot or too cold, it will not charge properly. Let it reach room temperature.</p> <hr/> <p>Unplug the AC adaptor and remove the battery to make sure the terminals are clean. If necessary wipe them with a soft dry cloth dipped in alcohol.</p> <p>Connect the AC adaptor and replace the battery. Make sure it is securely seated.</p>

Check the **Battery** indicator. If it does not glow, let the computer charge the battery for at least 20 minutes. If the **Battery** indicator glows after 20 minutes, let the battery continue to charge at least another 20 minutes before turning on the computer.

If the indicator still does not glow, the battery may be at the end of its operating life. Replace it. If you do not think the battery is at the end of its operating life, see your dealer.

Battery doesn't power the computer as long as expected

If you frequently recharge a partially charged battery, the battery might not charge to its full potential. Fully discharge the battery, then try to charge it again.

Check the power consumption settings in Power Saver utility. Consider using a power saving mode.

Password

Problem	Procedure
---------	-----------

Cannot enter password

Refer to the <i>Password</i> section in Chapter 6, <i>Power and Power-Up Modes</i> .
--

Keyboard

Keyboard problems can be caused by your setup configuration. For more information refer to Chapter 5, *The Keyboard*.

Problem	Procedure
Some letter keys produce numbers	Check that the numeric keypad overlay is not selected. Press Fn + F10 and try typing again.
Output to screen is garbled	Make sure the software you are using is not remapping the keyboard. Remapping involves reassigning the meaning of each key. See your software's documentation. If you are still unable to use the keyboard, consult your dealer.

LCD panel

Apparent LCD problems may be related to the computer's setup. Refer to Chapter 7, *HW Setup*, for more information.

Problem	Procedure
No display	Press hotkeys Fn + F5 to change the display priority, to make sure it is not set for an external monitor.
Problems above remain unresolved or other problems occur	Refer to your software's documentation to determine if the software is causing the difficulty. Run the diagnostic test. Contact your dealer if the problems continue.

Hard disk drive

Problem	Procedure
Computer does not boot from hard disk drive	<p>Check if a diskette is in the diskette drive. If a diskette is inserted, remove it and reboot.</p> <hr/> <p>There may be a problem with your operating system files. Refer to your OS documentation.</p>
Slow performance	<p>Your files may be fragmented. Run SCANDISK and defragmenter to check the condition of your files and disk. Refer to your OS documentation or online HELP for information on running SCANDISK and the defragmenter.</p> <hr/> <p>As a last resort, reformat the hard disk. Then, reload the operating system and other files.</p> <hr/> <p>If problems persist, contact your dealer.</p>

Diskette drive

For more information, refer to Chapter 4, *Operating Basics*.

Problem	Procedure
Drive does not operate	<p>There may be a faulty cable connection. Check the connection to the computer and to the drive.</p>
Some programs run correctly but others do not	<p>The software or hardware configuration may be causing a problem. Make sure the hardware configuration matches your software needs.</p>

You cannot access the external 3 1/2" diskette drive

Try another diskette. If you can access the diskette, the original diskette (not the drive) is probably causing the problem.

If problems persist, contact your dealer.

Infrared port

Refer also to the documentation for your IrDA compatible device and related software.

Problem	Procedure
----------------	------------------

Infrared devices do not work as expected

Check that the device is connected to an electric outlet. Make sure the outlet is supplying power by plugging in an appliance.

Make sure there is no obstruction blocking communication between the computer and the target device.

If problems persist, contact your dealer.

Pointing device

If you are using a USB mouse, also refer to the *USB* section in this chapter and to your mouse documentation.

TOSHIBA Tablet PC Pen

Problem	Procedure
----------------	------------------

On-screen pointer does not respond to tablet pen operation

The system might be busy. If the pointer is shaped as an hourglass, wait for it to resume its normal shape and try again to move it.

The tablet Pen might be set unable to use.

Press **Fn + F9** keys to change Pen setting to enabled.

Tablet pen and on-screen pointer do not move in the same manner

Adjust the coordinate axis in the following procedure.

1. Open the **Control Panel** and click **Printer and other Hardware**.
2. Click the **Tablet and Pen** setting.
3. Select screen orientation with "**Calibrate**" in "**Setting**" tab.
4. Click "**Calibrate**" button.
5. Click the cross in "**Calibrate the screen**" and click "**OK**".

Unable input from tablet pen

Adjust the setting in the following procedure.

1. Open the **Control Panel** and click **Printer and other Hardware**.
2. Click the **Tablet and Pen** setting.
3. Adjust setting of each item of "**Pen options**" tab and click "**OK**".

Touch Pad

Problem

Procedure

On-screen pointer does not respond to Pad operation

The system might be busy. If the pointer is shaped as an hourglass, wait for it to resume its normal shape and try again to move it.

Double-tapping does not work

Try changing the double-click speed setting in the mouse control utility.

1. Open the **Control Panel**, select the **Mouse** icon and press **Enter**.
2. Click the **Buttons** tab.
3. Set the double-click speed as instructed and click **OK**.

The mouse pointer moves too fast or too slow

Try changing the speed setting in the mouse control utility.

1. Open the **Control Panel**, select the **Mouse** icon and press **Enter**.
2. Click the **Pointer Options** tab.
3. Set the speed as instructed and click **OK**.

If problems persist, contact your dealer.

USB mouse

Problem	Procedure
----------------	------------------

On-screen pointer does not respond to mouse operation

The system might be busy. If the pointer is shaped as an hourglass, wait for it to resume its normal shape and try again to move it.

Make sure the mouse is properly connected to the USB port.

Double-clicking does not work

Try changing the double-click speed setting in the mouse control utility.

1. Open the **Control Panel**, select the **Mouse** icon and press **Enter**.
2. Click the **Buttons** tab.
3. Set the double-click speed as instructed and click **OK**.

The mouse pointer moves too fast or too slow

Try changing the speed setting in the mouse control utility.

1. Open the **Control Panel**, select the **Mouse** icon and press **Enter**.
2. Click the **Pointer Options** tab.
3. Set the speed as instructed and click **OK**.

The mouse pointer moves erroneously

The mouse might be dirty. Refer to your mouse documentations for instructions on cleaning.

If problems persist, contact your dealer.

PC card

Refer also to Chapter 8, *Optional Devices*.

Problem

Procedure

PC card error occurs

Reseat the PC card to make sure it is firmly connected.

Make sure the connection between the external device and the card is firm.

Check the card's documentation.

If problems persist, contact your dealer.

SD card

Refer also to Chapter 8, *Optional Devices*.

Problem	Procedure
SD card error occurs	Reseat the SD card to make sure it is firmly connected. <hr/> Check the card's documentation.
You cannot write in an SD card	Make sure the card is not write protected.
You cannot read a file	Make sure the target file is on the SD Card inserted in the slot. <hr/> If problems persist, contact your dealer.
SD card cannot be started	Create a startup disk using the Toshiba SD memory boot utility.

Monitor

Refer also to Chapter 8, *Optional Devices*, and to your monitor's documentation.

Problem	Procedure
Monitor does not turn on	Make sure that the external monitor's power switch is on. Confirm that the external monitor's power cable is plugged into a working power outlet.
No display	Try adjusting the contrast and brightness controls on the external monitor. <hr/> Press hotkeys Fn + F5 to change the display priority and make sure it is not set for the internal display.

Display error occurs	Check that the cable connecting the external monitor to the computer is attached firmly. If problems persist, contact your dealer.
----------------------	---

Sound system

Refer also to documentation for your audio devices.

Problem	Procedure
No sound is heard	Adjust the volume control dial. Check the software volume settings. Make sure the headphone connection is secure. If problems persist, contact your dealer.

USB

Refer also to your USB device's documentation.

Problem	Procedure
USB device does not work	Check for a firm cable connection between the USB ports on the computer and the USB device. Make sure the USB device drivers are properly installed. Refer to your Windows documentation for information on checking the drivers.

If you are using an operating system that does not support USB, you can still use a USB mouse and/or USB keyboard. If these devices do not work, make sure the USB KB/Mouse Legacy Emulation item in HW Setup is set to **Enabled**.

If problems persist, contact your dealer.

Memory expansion

Refer also to Chapter 8, *Optional Devices*, for information on installing memory modules.

Problem	Procedure
Beep sounds. (If memory is in slot A, a long beep (1 second) followed by two short beeps (0.5 second each). If in slot B, a long beep followed by four short beeps. If both in slot A and slot B, a long beep followed by two short beeps and after a pause (1 second) a long beep followed by four short beeps.)	Make sure the memory module installed in the expansion slot is compatible with the computer. If an incompatible module has been installed, follow the steps below. <ol style="list-style-type: none">1. Turn off the power.2. Disconnect the AC adaptor and all peripheral devices.3. Remove the battery pack.4. Remove the memory module.5. Install the memory module compatible with the computer.6. Install the battery pack and/or connect the AC adaptor.7. Turn on the power.

Standby/Hibernation

Problem	Procedure
The system will not enter Standby/Hibernation	Is Windows Media™ Player open? The system might not enter Standby/Hibernation, if Windows Media Player is either playing a selection or finished playing a selection. Close Windows Media Player before you select Standby/Hibernation. If problems persist, contact your dealer.

Modem

Refer to the online help files for *Appendix C* and *D*.

Problem	Procedure
Communication software can't initialize modem	Make sure the computer's internal modem settings are correct. Refer to <i>Modem Properties</i> in the Control Panel.
You can hear a dial tone but can't make a call	If the call is going through a PBX machine, make sure the communication application's tone dial detection feature is disabled. You can also use the ATX command. Refer to <i>Appendix C, AT Commands</i> .
You place a call, but a connection can't be made	Make sure the settings are correct in your communications application.

After making a call you can't hear a ring

Make sure the tone or pulse selection in your communications application is set correctly.

You can also use the ATD command. Refer to Appendix C, *AT Commands*.

Communication is cut off unexpectedly

The computer will automatically cut off communication when connection with the carrier is not successful for a set time interval. Try lengthening this time interval.

A **CONNECT** display is quickly replaced by **NO CARRIER**

Check the error control setting in your communications application.

You can also use the ATN command. Refer to Appendix C, *AT Commands*.

Character display becomes garbled during a communication

In data transmission, make sure the parity bit and stop bit settings correspond with those of the remote computer.

Check the flow control and communication protocol.

You cannot receive an incoming call

Check the rings before auto answer setting in your communications application.

You can also use the ATS0 command. Refer to Appendix D, *S-registers*.

If problems persist, contact your dealer.

LAN

Problem	Procedure
Cannot access LAN	Check for a firm cable connection between the LAN jack and the LAN HUB. If problems persist, consult your LAN administrator.
Wake-up on LAN does not work	Make sure the AC adaptor is connected. The Wake-up on LAN function consumes power even when the system is off. If problems persist, consult your LAN administrator.

Wireless LAN

If the following procedures do not restore LAN access, consult your LAN administrator. For more information on wireless communication, refer to Chapter 4, *Operating Basics*.

Problem	Procedure
Cannot access Wireless LAN	Make sure the computer's wireless communication switch is set to on. If problems persist, consult your LAN administrator.

Bluetooth

For more information on wireless communication, refer to Chapter 4, *Operating Basics*.

Problem	Procedure
Cannot access Bluetooth device	<p>Make sure the computer's wireless communication switch is set to on.</p> <p>Make sure the Bluetooth Manager is running and the power to the Bluetooth device is turned on.</p> <p>Make sure no optional Bluetooth PC card is installed in the computer. The built-in Bluetooth function and an optional Bluetooth PC card cannot operate simultaneously.</p> <p>If problems persist, contact your dealer.</p>

Real Time Clock

Problem	Procedure
The following message is displayed on the LCD: RTC battery is low or CMOS checksum is inconsistent. Press [F1] key to set Date/Time.	<p>The battery for RTC is wearing. Set the date and time in BIOS setup with the following steps:</p> <ol style="list-style-type: none">1. Press [F1] key. BIOS setup will boot up.2. Set the date in [System Date].3. Set the time in [System Time].4. Press [End] key. <p>Confirmation message will appear.</p> <ol style="list-style-type: none">5. Press [Y] key. BIOS setup will terminate and the computer will be rebooted.

TOSHIBA support

If you require any additional help using your computer or if you are having problems operating the computer, you may need to contact TOSHIBA for additional technical assistance.

Before you call

Some problems you experience may be related to software or the operating system. It is important to investigate other sources of assistance first. Before contacting TOSHIBA, try the following:

- Review troubleshooting sections in the documentation for software and peripheral devices.
- If a problem occurs when you are running software applications, consult the software documentation for troubleshooting suggestions. Call the software company's technical support for assistance.
- Consult the dealer you purchased your computer and/or software from. They are your best sources for current information and support.

Where to write

If you are still unable to solve the problem and suspect that it is hardware related, write to TOSHIBA at the nearest location listed on the below.

Outside of Europe

Australia

TOSHIBA Australia Pty. Ltd.
Information Systems Division
84-92 Talavera Road
North Ryde N.S.W. 2113
Sydney

Canada

TOSHIBA of Canada Ltd.
191 McNabb Street,
Markham, Ontario
L3R8H2

China

TOSHIBA Computer Systems
(Shanghai) Co., Ltd. Bldg.33, No.35,
Jinzang Road,
Pudong New Area,
Shanghai,
P.R. China 201206

Singapore

TOSHIBA Singapore Pte. Ltd.
438B Alexandra Road #06-01
Alexandra Technopark
Singapore 119968

United States of America

TOSHIBA America Information
Systems, Inc.
9740 Irvine Boulevard
Irvine, California 92618
USA

In Europe

Germany & Austria

TOSHIBA Europe (I.E.) GmbH
Geschäftsbereich,
Deutschland-Österreich
Hammfelddamm 8,
D-41460 Neuss, Germany

France

TOSHIBA Systèmes France S.A.
7, Rue Ampère B.P. 131,
92804 Puteaux Cedex

Netherlands

TOSHIBA Information Systems,
Benelux B.V.
Rivium Boulevard
41 2909 LK Capelle a/d IJssel

Spain

TOSHIBA Information Systems,
ESPAÑA
Parque Empresarial San Fernando
Edificio Europa, 1ª Planta,
Escalera A 28830 Madrid

United Kingdom

TOSHIBA Information Systems (U.K.)
Ltd.
TOSHIBA Court
Weybridge Business Park
Addlestone Road
Weybridge, Surrey KT15 2UL

The Rest of Europe

TOSHIBA Europe (I.E.) GmbH
Geschäftsbereich,
Deutschland-Österreich
Hammfelddamm 8,
D-41460 Neuss, Germany

Appendixes

Appendix A Specifications	A-1
Appendix B Display Controller and Modes	B-1
Appendix C AT Commands	C-1
Appendix D S-registers	D-1
Appendix E V.90	E-1
Appendix F Wireless LAN	F-1
Appendix G AC Power Cord and Connectors	G-1
Appendix H Internal Modem Guide	H-1
Appendix I Parts Numbers	I-1

Specifications

This appendix summarizes the computer's technical specifications.

Physical Dimensions

Size

With TFT display 295(w)×239(d)×36.9(h) millimeters

Weight

Hard disk	Memory	Display	Kilograms
40GB	256MB	12" SXGA+-TFT	2.0 kg typical*

* Weight will vary depending on whether the computer has Wireless LAN capability.

Environmental Requirements

Conditions	Ambient temperature	Relative humidity
Operating	5°C (41°F) to 35°C (95°F)	20% to 80%
Non operating	-20°C (-4°F) to 65°C (149°F)	10% to 90%
Thermal Gradient	20°C per hour maximum	
Wet-bulb temperature	26°C maximum	
Conditions	Altitude (from sea level)	
Operating	-60 to 3,000 meters	
Non operating	-60 to 10,000 meters <i>maximum</i>	

Power Requirements

AC adaptor	100-240 volts AC 50 or 60 hertz (cycles per second)
Computer	15VDC 3.0 amperes

Built-in Modem

Network control unit (NCU)

Type of NCU	AA
Type of line	Telephone line (analog only)
Type of dialing	Pulse Tone
Control command	AT commands EIA-578 commands
Monitor function	Computer's speaker

Communication specifications

Communication system	Data: Full duplex Fax: Half duplex
Communication protocol	Data ITU-T-Rec V.21/V.22/V.22bis/V.32 (Former CCITT) /V.32bis/V.34/V.90 Bell 103/212A Fax ITU-T-Rec V.17/V.29/V.27ter (Former CCITT) /V.21 ch2
Communication speed	Data transmission and reception 300/1200/2400/4800/7200/9600/12000/14400/ 16800/19200/21600/24000/26400/28800/31200/ 33600 bps Data reception only with V.90 28000/29333/30666/32000/33333/34666/36000/37333/ 38666/40000/41333/42666/44000/45333/46666/48000/ 49333/50666/52000/53333/54666/56000 bps Fax 2400/4800/7200/9600/12000/14400 bps

Error correcting MNP class 4 and ITU-T V.42
Data compression MNP class 5 and ITU-T V.42bis
Transmitting level -10dBm
Receiving level -10 to -40dBm
Input/output impedance 600 ohms \pm 30%
Power supply +3.3V (supplied by computer)

Display Controller and Modes

Display controller

The display controller interprets software commands into hardware commands that turn particular pixels on or off.

The controller is an advanced Video Graphics Array (VGA) that provides Super VGA (SVGA) and Extended Graphics Array (XGA) support for the internal LCD and external monitors. The displays up to 1400×1050 (SXGA+). The controller also supports simultaneous display on the internal LCD and on an external monitor.

A high-resolution external monitor connected to the computer can display up to 1600 horizontal and 1536 vertical pixels and up to 64K colors.

The display controller also controls the video mode, which uses industry standard rules to govern the screen resolution and the maximum number of colors that can be displayed on screen.

Software written for a given video mode will run on any computer that supports the mode.

The computer's display controller supports all VGA and SVGA modes, the most widely used industry standards.

Video modes

The computer supports video modes defined in the table below. If your application offers a selection of mode numbers that do not match the numbers on the table, select a mode based on mode type, resolution, character matrix, number of colors and refresh rates. Also, consider the following points:

- If your software supports both graphics and text modes, the screen display may appear to operate faster using a text mode.
- The LCD's highest graphics resolution is 1400 horizontal × 1050 vertical lines.

Table 1 Video modes (Landscape)

<i>Video mode</i>	<i>Type</i>	<i>Resolution</i>	<i>Character matrix (pels)</i>	<i>LCD colors</i>	<i>CRT colors</i>	<i>Scanning frequency Vertical</i>
0, 1	VGA Text	40 × 25 Characters	8 × 8	16 of 256K	16 of 256K	70Hz
2, 3	VGA Text	80 × 25 Characters	8 × 8	16 of 256K	16 of 256K	70Hz
0*, 1*	VGA Text	40 × 25 Characters	8 × 14	16 of 256K	16 of 256K	70Hz
2*, 3*	VGA Text	80 × 25 Characters	8 × 14	16 of 256K	16 of 256K	70Hz
0+, 1+	VGA Text	40 × 25 Characters	8(9) × 16	16 of 256K	16 of 256K	70Hz
2+, 3+	VGA Text	80 × 25 Characters	8(9) × 16	16 of 256K	16 of 256K	70Hz
4, 5	VGA Grph	320 × 200 Pels	8 × 8	4 of 256K	4 of 256K	70Hz
6	VGA Grph	640 × 200 Pels	8 × 8	2 of 256K	2 of 256K	70Hz
7	VGA Text	80 × 25 Characters	8(9) × 14	Mono	Mono	70Hz
7+	VGA Text	80 × 25 Characters	8(9) × 16	Mono	Mono	70Hz

Table 1 Video modes (Landscape) continued

<i>Video mode</i>	<i>Type</i>	<i>Resolution</i>	<i>Character matrix (pels)</i>	<i>LCD colors</i>	<i>CRT colors</i>	<i>Scanning frequency Vertical</i>
D	VGA Grph	320 × 200 Pels	8 × 8	16 of 256K	16 of 256K	70Hz
E	VGA Grph	640 × 200 Pels	8 × 8	16 of 256K	16 of 256K	70Hz
F	VGA Grph	640 × 350 Pels	8 × 14	Mono	Mono	70Hz
10	VGA Grph	640 × 350 Pels	8 × 14	16 of 256K	16 of 256K	70Hz
11	VGA Grph	640 × 480 Pels	8 × 16	16 of 256K	16 of 256K	60Hz
12	VGA Grph	640 × 480 Pels	8 × 16	16 of 256K	16 of 256K	60Hz
13	VGA Grph	320 × 200 Pels	8 × 8	256 of 256K	256 of 256K	70Hz
	SVGA Grph	640 × 480 Pels		256 of 256K	256 of 256K	60Hz 75Hz 85Hz 100Hz
	SVGA Grph	800 × 600 Pels		256 of 256K	256 of 256K	60Hz 75Hz 85Hz 100Hz
	SVGA Grph	1024 × 768 Pels		256 of 256K	256 of 256K	60Hz 75Hz 85Hz 100Hz
	SVGA Grph	1280 × 1024 Pels			256 of 256K	60Hz 75Hz 85Hz 100Hz

APPENDIX B

Table 1 Video modes (Landscape) continued

<i>Video mode</i>	<i>Type</i>	<i>Resolution</i>	<i>Character matrix (pels)</i>	<i>LCD colors</i>	<i>CRT colors</i>	<i>Scanning frequency Vertical</i>
	SVGA Grph	1600 × 1200 Pels			256 of 256K	60Hz 75Hz 85Hz 100Hz
	SVGA Grph	1920 × 1400 Pels			256 of 256K	60Hz 75Hz 85Hz
	SVGA Grph	2048 × 1536 Pels			256 of 256K	60Hz 75Hz
	SVGA Grph	640 × 480 Pels		64K of 64K	64K of 64K	60Hz 75Hz 85Hz 100Hz
	SVGA Grph	800 × 600 Pels		64K of 64K	64K of 64K	60Hz 75Hz 85Hz 100Hz
	SVGA Grph	1024 × 768 Pels		64K of 64K	64K of 64K	60Hz 75Hz 85Hz 100Hz
	SVGA Grph	1280 × 1024 Pels			64K of 64K	60Hz 75Hz 85Hz 100Hz
	SVGA Grph	1600 × 1200 Pels			64K of 64K	60Hz 75Hz 85Hz 100Hz
	SVGA Grph	1920 × 1440 Pels			64K of 64K	60Hz 75Hz 85Hz

Table 1 Video modes (Landscape) continued

<i>Video mode</i>	<i>Type</i>	<i>Resolution</i>	<i>Character matrix (pels)</i>	<i>LCD colors</i>	<i>CRT colors</i>	<i>Scanning frequency Vertical</i>
	SVGA Grph	2048 × 1536 Pels			64K of 64K	60Hz 75Hz
	SVGA Grph	640 × 480 Pels		16M of 16M	16M of 16M	60Hz 75Hz 85Hz 100Hz
	SVGA Grph	800 × 600 Pels		16M of 16M	16M of 16M	60Hz 75Hz 85Hz 100Hz
	SVGA Grph	1024 × 768 Pels		16M of 16M	16M of 16M	60Hz 75Hz 85Hz 100Hz
	SVGA Grph	1280 × 1024 Pels			64M of 16M	60Hz 75Hz 85Hz 100Hz
	SVGA Grph	1600 × 1200 Pels			64M of 16M	60Hz 75Hz 85Hz 100Hz
	SVGA Grph	1920 × 1440 Pels			64M of 16M	60Hz 75Hz
	SVGA Grph	2048 × 1536 Pels			64M of 16M	60Hz 75Hz

APPENDIX B

Table 2 Video modes (Portrait)

<i>Video mode</i>	<i>Type</i>	<i>Resolution</i>	<i>Character matrix (pels)</i>	<i>LCD colors</i>	<i>CRT colors</i>	<i>Scanning frequency Vertical</i>
	SVGA Grph	480 × 640 Pels		256 of 256K	256 of 256K	60Hz 75Hz 85Hz 100Hz
	SVGA Grph	600 × 800 Pels		256 of 256K	256 of 256K	60Hz 75Hz 85Hz 100Hz
	SVGA Grph	768 × 1024 Pels		256 of 256K	256 of 256K	60Hz 75Hz 85Hz 100Hz
	SVGA Grph	1024 × 1280 Pels			256 of 256K	60Hz 75Hz 85Hz 100Hz
	SVGA Grph	1200 × 1600 Pels			256 of 256K	60Hz 75Hz 85Hz 100Hz
	SVGA Grph	1440 × 1920 Pels			256 of 256K	60Hz 75Hz 85Hz
	SVGA Grph	1536 × 2048 Pels			256 of 256K	60Hz 75Hz
	SVGA Grph	480 × 640 Pels		64K of 64K	64K of 64K	60Hz 75Hz 85Hz 100Hz

Table Video modes (Portrait) continued

<i>Video mode</i>	<i>Type</i>	<i>Resolution</i>	<i>Character matrix (pels)</i>	<i>LCD colors</i>	<i>CRT colors</i>	<i>Scanning frequency Vertical</i>
	SVGA Grph	600 × 800 Pels		64K of 64K	64K of 64K	60Hz 75Hz 85Hz 100Hz
	SVGA Grph	768 × 1024 Pels		64K of 64K	64K of 64K	60Hz 75Hz 85Hz 100Hz
	SVGA Grph	1024 × 1280 Pels			64K of 64K	60Hz 75Hz 85Hz 100Hz
	SVGA Grph	1200 × 1600 Pels			64K of 64K	60Hz 75Hz 85Hz 100Hz
	SVGA Grph	1440 × 1920 Pels			64K of 64K	60Hz 75Hz 85Hz
	SVGA Grph	1536 × 2048 Pels			264K of 64K	60Hz 75Hz
	SVGA Grph	480 × 640 Pels		16M of 16M	16M of 16M	60Hz 75Hz 85Hz 100Hz
	SVGA Grph	600 × 800 Pels		16M of 16M	16M of 16M	60Hz 75Hz 85Hz 100Hz

APPENDIX B

Table 2 Video modes (Portrait) continued

<i>Video mode</i>	<i>Type</i>	<i>Resolution</i>	<i>Character matrix (pels)</i>	<i>LCD colors</i>	<i>CRT colors</i>	<i>Scanning frequency Vertical</i>
	SVGA Grph	768 × 1024 Pels		16M of 16M	16M of 16M	60Hz 75Hz 85Hz 100Hz
	SVGA Grph	1024 × 1280 Pels			16M of 16M	60Hz 75Hz 85Hz 100Hz
	SVGA Grph	1200 × 1600 Pels			16M of 16M	60Hz 75Hz 85Hz 100Hz
	SVGA Grph	1440 × 1920 Pels			16M of 16M	60Hz 75Hz
	SVGA Grph	1536 × 2048 Pels			16M of 16M	60Hz 75Hz

AT Commands

In most cases, you will not need to type AT commands manually. However, there might be some occasions when you will need to do so.

This chapter describes AT commands for data mode. Fax and voice commands are taken care of by application software.

The format for entering AT commands is:

ATXn

where **X** is the AT command, and **n** is the specific value for that command. After you type in the command press **Enter**.

Any command issued is acknowledged with a response in either text or numeric values known as result codes.

All commands and command-values accepted by the modem are described in this section; any entry other than those listed results in an error.

+++ Escape sequence

The escape sequence allows the modem to exit data mode and enter on-line command mode. While in on-line command mode, you can communicate directly to your modem using AT commands. Once you finish, you can return to data mode using the ATO command.

A pause, the length of which is set by Escape Guard Time (S12), must be completed after an escape sequence is entered. This pause prevents the modem from interpreting the escape sequence as data.

The value of the escape sequence character may be changed using register S2.

A/ Repeat last command

This command repeats the last command string entered. Do not precede this command with an AT prefix or conclude it by pressing **Enter**.

A Answer command

This command instructs the modem to go off-hook and answer an incoming call.

Bn Communication standard setting

This command determines the communication standard CCITT or Bell.

- B0** Selects CCITT V.22 mode when the modem is at 1200 bps.
- B1** Selects Bell 212A when the modem is at 1200 bps (default).
- B15** Selects V.21 when the modem is at 300 bps.
- B16** Selects Bell 103J when the modem is at 300 bps (default).

Result Codes:

- OK** n=0,1,15,16
- ERROR** Otherwise

Dn Dial

This command instructs the modem to dial a telephone number. Enter n (the telephone number and any modifiers) after the ATD command.

Any digit or symbol (0-9, *, #, A, B, C, D) may be dialed as touch-tone digits. Characters such as spaces, hyphens, and parentheses do not count. They are ignored by the modem, but you may want to include them to make the number and modifiers easier to read.

The following may be used as phone number modifiers:

- P** Pulse dialing.
- T** Touch-tone dialing (default).
- ,** Pause during dialing. Pause for time specified in Register S8 before processing the next character in the dial string.
- W** Wait for dial tone. Modem waits for a second dial tone before processing the dial string.
- @** Wait for quiet answer. Wait for five seconds of silence after dialing the number. If silence is not detected, the modem sends a NO ANSWER result code back to the caller.
- !** Hook flash. Causes the modem to go on-hook for 0.5 seconds and then return to off-hook.

- ;
Return to command mode. Causes the modem to return to command mode after dialing a number, without disconnecting the call.
- S=n
Dial a telephone number previously stored using the &Zn=X command (See &Zn=X command for more information). The range is 0-3.

En Echo command

This command controls whether or not the characters entered from your computer keyboard are displayed on your monitor (echoed) while the modem is in command mode.

- E0** Disables echo to the computer.
- E1** Enables echo to the computer (default).

Result Codes:

- OK** n=0,1
- ERROR** Otherwise

Hn Hook control

This command instructs the modem to go on-hook to disconnect a call, or off-hook to make the phone line busy.

- H0** Modem goes on-hook (default).
- H1** Modem goes off-hook.

Result Codes:

- OK** n=0,1
- ERROR** Otherwise

In Request ID information

This command displays product information about the modem.

- I0** Returns modem identity string and driver version number.
- I3** Same as **I0**.
- I9** Returns region ID in English.

Result Codes:

- OK** n=0,3,9
- ERROR** Otherwise

Ln Monitor speakers volume

This command sets speakers volume to low, medium, or high.

- L0** Low volume.
- L1** Low volume. (Same as **L0**)
- L2** Medium volume (default).
- L3** High volume.

Result Codes:

- OK** n=0,1,2,3
- ERROR** Otherwise

Mn Monitor speakers mode

This command turns the speakers on or off.

- M0** The speakers are off.
- M1** The speakers are on until the modem detects the carrier signal (default).
- M2** The speakers are always on when modem is off-hook.
- M3** Speakers are on until the carrier is detected, except when dialing.

Result Codes:

- OK** n=0,1,2,3
- ERROR** Otherwise

Nn Modulation handshake

This command controls whether or not the local modem performs a negotiated handshake at connection time with the remote modem when the communication speed of the two modems is different.

- N0** When originating or answering, this is for handshake only at the communication standard specified by S37 and the ATB command.
- N1** When originating or answering, begin the handshake at the communication standard specified by S37 and the ATB command (default).

During handshake, a lower transmission speed may be selected.

Result Codes:

OK n=0,1

ERROR Otherwise

On Return on-line to data mode

O0 Instructs the modem to exit on-line command mode and return to data mode (see AT escape sequence, +++).

O1 This command issues a retrain before returning to on-line data mode.

O3 This command issues a rate renegotiation before returning to on-line data mode.

Result Codes:

OK n=0,1,3

ERROR Otherwise

P Select pulse dialing

This command configures the modem for pulse (non touch-tone) dialing. Dialed digits are pulsed until a T command or dial modifier is received. Tone dial is the default setting.

Qn Result code control

Result codes are informational messages sent from the modem and displayed on your monitor. Basic result codes are **OK**, **CONNECT**, **RING**, **NO CARRIER**, and **ERROR**. The ATQ command allows the user to turn result codes on or off.

Q0 Enables modem to send result codes to the computer (default).

Q1 Disables modem from sending result codes to the computer.

Result Codes:

OK n=0,1

ERROR Otherwise

T Select tone dialing

This command instructs the modem to send DTMF tones while dialing. Dialed digits are tone dialed until a P command or dial modifier is received. This is the default setting.

Vn DCE response format

This command controls whether result codes (including call progress and negotiation progress messages) are displayed as words or their numeric equivalents.

V0 Displays result codes as digits.

V1 Displays result codes as text (default).

Result Codes:

OK n=0,1

ERROR Otherwise

Xn Result code selection, call progress monitoring

This command selects which result codes will be used by the modem.

Command	Dial tone detect	Busy signal detect	Supported Result Code
X0	Disable	Disable	OK, CONNECT, RING, NO CARRIER, ERROR
X1	Disable	Disable	OK, RING, NO CARRIER, ERROR, CONNECT <RATE>
X2	Enable	Disable	OK, RING, NO CARRIER, ERROR, NODIALTONE, CONNECT <RATE>
X3	Disable	Enable	OK, RING, NO CARRIER, ERROR, BUSY, CONNECT <RATE>, BLACKLISTED
X4 (default)	Enable	Enable	OK, RING, NO CARRIER, ERROR, NODIALTONE, BUSY, CONNECT <RATE>, DELAYED, BLACKLISTED, REORDER, WARBLE, CALL WAITING DETECTED

X5	Enable	Enable	OK, RING, NO CARRIER, ERROR, NODIALTONE, BUSY, CONNECT <RATE>, RRING, NO BONGTONE, DELAYED, BLACKLISTED, REORDER, WARBLE, CALL WAITING DETECTED
----	--------	--------	---

Dial tone detect

Disabled: The modem dials a call regardless of whether it detects a dial tone.

Enabled: The modem dials only upon detection of a dial tone, and disconnects the call if the dial tone is not detected within 10 seconds.

Busy tone detect

Disabled: The modem ignores any busy tones it receives.

Enabled: The modem monitors for busy tones.

Result Codes:

OK n=0,1,2,3,4,5

ERROR Otherwise

Zn Recall stored profile

The modem performs a soft reset and restores (recalls) the configuration profile according to the parameter supplied. If no parameter is specified, zero is assumed. Either Z0 or Z1 restores the profile.

Result Codes:

OK n=0,1

ERROR Otherwise

&Cn Data Carrier Detect (DCD) control

Data Carrier Detect is a signal from the modem to the computer indicating that a carrier signal is being received from a remote modem. DCD normally turns off when the modem no longer detects the carrier signal.

- &C0** The state of the carrier from the remote modem is ignored. DCD circuit is always on.
- &C1** DCD turns on when the remote modem's carrier signal is detected, and off when the carrier signal is not detected (default).

Result Codes:

- OK** n=0,1
- ERROR** Otherwise

&Dn DTR control

This command interprets how the modem responds to the state of the DTR signal and changes to the DTR signal.

- &D0** Ignore. The modem ignores the true status of DTR and treats it as always on. This should only be used if your communication software does not provide DTR to the modem.
- &D1** If the DTR signal is not detected while in on-line data mode, the modem enters command mode, issues an **OK** result code, and remains connected.
- &D2** If the DTR signal is not detected while in on-line data mode, the modem disconnects (default).
- &D3** Reset on the on-to-off DTR transition.

Result Codes:

- OK** n=0,1,2,3
- ERROR** Otherwise

&F Load factory settings

This command loads the configuration stored and programmed at the factory. This operation replaces all of the command options and the S-register settings in the active configuration with factory values.

- &F** Recall factory setting as active configuration.

&Gn V.22bis guard tone control

This command determines which guard tone, if any, to transmit while transmitting in the high band (answer mode). This command is only used in V.22 and V.22bis mode. This option is not used in North America and is for international use only.

&G0 Guard tone disabled (default).

&G1 Sets guard tone to 550 Hz.

&G2 Sets guard tone to 1800 Hz.

Result Codes:

OK n=0,1,2

ERROR Otherwise

&Kn Local flow control selection

&K0 Disable flow control.

&K3 Enable CTS/RTS flow control (default).

&K4 Enable XON/XOFF flow control.

Result Codes:

OK n=0,3,4

ERROR Otherwise

&Pn Select Pulse Dial Make/Break Ratio (WW)

&P0 Selects 39% - 61% make/break ratio at 10 pulses per second.

&P1 Selects 33% - 67% make/break ratio at 10 pulses per second.

&P2 Selects 33% - 67% make/break ratio at 20 pulses per second.

Result Codes:

OK n=0,1,2

ERROR Otherwise

&Tn Self-test commands

These tests can help to isolate problems if you experience periodic data loss or random errors.

- &T0** Abort. Stops any test in progress.
- &T1** Local analog loop. This test verifies modem operation, as well as the connection between the modem and computer. Any data entered at the local DTE is modulated, then demodulated, and returned to the local DTE. To work properly, the modem must be off-line.

Result Codes:

- OK** n=0
- CONNECT** n=1
- ERROR** Otherwise

&V Display Current Configuration

This command displays the current configuration of the modem. If nonvolatile memory is supported the stored profiles are displayed as well.

- &V** View profiles.

&W Store current configuration

Saves the current (active) configuration (profile), including S-Registers.

The current configuration comprises a list of storable parameters illustrated in the **&V** command. These settings are restored to the active configuration upon receiving a **Zn** command or at power up. Refer to the **&V** command.

- &W** Stores the current configuration.

&Zn=x Store telephone number

This command is used to store up to four dialing strings in the modem's nonvolatile memory for later dialing. The format for the command is **&Zn**="stored number" where n is the location 0-3 to which the number should be written. The dial string may contain up to 34 characters. The **ATDS=n** command dials using the string stored in location n.

Result codes:

- OK** n=0, 1, 2, 3
- ERROR** Otherwise

\Nn Error control mode selection

This command determines the type of error control used by the modem when sending or receiving data.

\N0 Buffer mode. No error control.

\N1 Direct mode.

\N2 MNP or disconnect mode. The modem attempts to connect using MNP2-4 error control procedures. If this fails, the modem disconnects.

This is also known as MNP reliable mode.

\N3 V.42, MNP, or buffered (default).

The modem attempts to connect in V.42 error control mode. If this fails, it attempts to connect in MNP mode. If this fails, it connects in buffer mode and continues operation. This is also known as V.42/MNP auto reliable mode (same as **&Q5**).

\N4 V.42 or disconnect. The modem attempts to connect in V.42 error control mode. If this fails, the modem disconnects.

\N5 V.42. MNP or buffered (same as **\N3**).

\N7 V.42. MNP or buffered (same as **\N3**).

Result Codes:

OK n=0,1,2,3,4,5,7

ERROR Otherwise

\Qn Local flow control selection

\Q0 Disable flow control.

\Q1 XON/XOFF software flow control.

\Q3 CTS/RTS to DTE (default).

Result Codes:

OK n=0,1,3

ERROR Otherwise

\Wn Protocol result code

\W0 Disable protocol result code appended to DCE speed.

\W1 Enable protocol result code appended to DCE speed (default).

Result Codes:

OK n=0,1

ERROR Otherwise

%B View numbers in blacklist

If blacklisting is in effect, this command displays the numbers for which the last call attempted in the past two hours failed. The ERROR result code appears in regions that do not require blacklisting.

%Cn Data compression control

This command determines the operation of V.42bis and MNP class 5 data compression. On-line changes do not take effect until a disconnect occurs first.

%C0 V.42bis/MNP 5 disabled. No data compression.

%C3 V.42bis/MNP 5 enabled. Data compression enabled (default).

Result Codes:

OK n=0,3

ERROR Otherwise

S-registers

S-registers contain the settings that determine how a number of functions of the internal modem operate. For example, how many times to let the telephone ring before the modem answers and how long to wait before it hangs up if a connection fails. You can also customize certain AT commands such as the escape sequence and command line termination.

The contents of the registers are changed automatically when you modify corresponding settings in your communication software. If you choose, however, you can display and edit the contents of the registers manually when the modem is in command mode. If the value is out of the acceptable range, then an error is generated.

This chapter describes the settings for each S-register.

S-register values

The format for displaying the value of an S-register is:

ATSn?

where **n** is the register number. After you type in the register press **Enter**.

The format for modifying the value of an S-register is:

ATSn=r

where **n** is the register number, and **r** is the new register value. After you type in the register and its new value press **Enter**.

NOTE: Some registers vary from one country/region to another.

S0 Auto answer ring number

This register determines the number of rings the modem will count before automatically answering a call. Enter 0 (zero) if you do not want the modem to automatically answer at all. When disabled, the modem can only answer with an ATA command.

Range: 0-255

Default: 0

Units: rings

S1 Ring counter

This register is read only. The value of S1 is incremented with each ring. If no ring occurs over a six-second interval, this register is cleared.

Range: 0-225

Default: 0

Units: rings

S2 AT escape character (user defined)

This register determines the ASCII values used for an escape sequence. The default is the + character. The escape sequence allows the modem to exit data mode and enter command mode when on-line. Values greater than 127 disable the escape sequence.

Range: 0-255, ASCII decimal

Default: 43

Units: ASCII

S3 Command line termination character (user defined)

This register determines the ASCII values as the carriage return character. This character is used to end command lines and result codes.

Range: 0-127, ASCII decimal

Default: 13 (carriage return)

Units: ASCII

S4 Response formatting character (user defined)

This register determines the ASCII value used as the line feed character. The modem uses a line feed character in command mode when it responds to the computer.

Range: 0-127, ASCII decimal

Default: 10 (line feed)

Units: ASCII

S5 Command line editing character (user defined)

This register sets the character recognized as a backspace and pertains to asynchronous only. The modem will not recognize the backspace character if it is set to a value that is greater than 32 ASCII. This character can be used to edit a command line. When the echo command is enabled, the modem echoes back to the local DTE the backspace character, an ASCII space character, and a second backspace character. This means a total of three characters are transmitted each time the modem processes the backspace character.

Range: 0-127, ASCII decimal

Default: 8 (backspace)

Units: ASCII

S6 Wait before dialing

This register sets the length of time, in seconds, that the modem must wait (pause) after going off-hook before dialing the first digit of the telephone number. The modem always pauses for a minimum of two seconds, even if the value of S6 is less than two seconds. The wait for dial tone call progress feature (W dial modifier in the dial string) will override the value in register S6. This operation, however, may be affected by some ATX options according to country/region restrictions. In some countries/regions, S6 will set dial tone detect time.

Range: 3-255

Default: 3

Units: seconds

S7 Connection completion time-out

This register sets the time, in seconds, that the modem must wait before hanging up because carrier is not detected. The timer is started when the modem finishes dialing (originate), or goes off-hook (answer). In originate mode, the timer is reset upon detection of an answer tone if allowed by county restriction. The timer also specifies the wait for silence time for the @ dial modifier in seconds. S7 is not associated with the W dial modifier.

Range: 1-255

Default: 50

Units: seconds

S8 Comma pause time

This register sets the time, in seconds, that the modem must pause when it encounters a comma (,) in the dial command string. In some countries/regions, S8 will set both wait before dialing and comma pause time.

Range: 0-255

Default: 2

Units: seconds

S11 DTMF dialing speed

This register determines the dialing speed which is prefixed for each country/region.

Range: 50-255

Default: 95

Units: .001 seconds

S12 Escape guard time

This register sets the value (in 20 millisecond increments) for the required pause after the escape sequence.

Range: 0-255

Default: 50

Units: .02 seconds

S37 Dial line rate

S37=0 (default)	maximum modem speed
S37=1	reserved
S37=2	1200/75 bps
S37=3	300 bps
S37=4	reserved
S37=5	1200 bps
S37=6	2400 bps
S37=7	4800 bps
S37=8	7200 bps
S37=9	9600 bps
S37=10	12000 bps
S37=11	14400 bps
S37=12	16800 bps
S37=13	19200 bps
S37=14	21600 bps
S37=15	24000 bps
S37=16	26400 bps
S37=17	28800 bps
S37=18	31200 bps
S37=19	33600 bps

AT command set result codes

The following table shows the result codes.

The result code summary

Result Code	Numeric	Description
OK	0	Command executed
CONNECT	1	Modem connected to line
RING	2	A ring signal has been detected
NOCARRIER	3	Modem lost carrier signal, or does not detect carrier signal, or does not detect answer tone
ERROR	4	Invalid command
CONNECT1200EC*1	5	Connection at 1200 bps
NODIALTONE	6	No dial tone detected
BUSY	7	Busy signal detected
NOANSWER	8	No quiet answer
CONNECT2400EC*1	10	Connection at 2400 bps
CONNECT4800EC*1	11	Connection at 4800 bps
CONNECT9600EC*1	12	Connection at 9600 bps
CONNECT14400EC*1	13	Connection at 14400 bps
CONNECT19200EC*1	14	Connection at 19200 bps
CONNECT7200EC*1	24	Connection at 7200 bps
CONNECT12000EC*1	25	Connection at 12000 bps
CONNECT16800EC*1	86	Connection at 16800 bps
CONNECT300EC*1	40	Connection at 300 bps
CONNECT21600EC*1	55	Connection at 21600 bps
CONNECT24000EC*1	56	Connection at 24000 bps
CONNECT26400EC*1	57	Connection at 26400 bps
CONNECT28800EC*1	58	Connection at 28800 bps
CONNECT31200EC*1	59	Connection at 31200 bps
CONNECT33600EC*1	60	Connection at 33600 bps

Result Code	Numeric	Description
DELAYED*2	88	Delay is in effect for the dialed number
BLACKLISTED*2	89	Dialed number is blacklisted
BLACKLISTFULL*2	90	Blacklist is full

*1: *EC only appears when the Extended Result Codes configuration option is enabled. EC is replaced by one of the following symbols, depending upon the error control method used:*

V.42bis - V.42 error control and V.42bis data compression.

V.42 - V.42 error control only.

MNP 5 - MNP class 4 error control and MNP class 5 data compression.

MNP 4 - MNP class 4 error control only.

NoEC - No error control protocol.

*2: *In some countries/regions, these result codes may not appear.*

V.90

The TOSHIBA internal modem uses V.90 technology. The modem is capable of downstream speeds of 56Kbps (kilobits per second) when connected to an Internet service provider that supports V.90. As with any modem, the actual throughput (speed of data transfer) depends on analog telephone line conditions, which can vary considerably. Therefore, many users will experience throughput in the range of 32-44Kbps under normal telephone line conditions. Upstream data flows at the V.34 rate.

***NOTE:** V.90 rates can be achieved only when one V.90 capable modem is connected to another. The TOSHIBA Internal modem will select automatically V.34 if the remote modem lacks V.90 capability or if a combination of network and/or phone line conditions prevent V.90 connection.*

V.90 mode

Function	Transmission speed
Data V.90	From 56K (maximum) to 28Kbps (minimum) Reception only

Table E-1 Result codes for a V.90 connection

No.	Result code	Description
70	CONNECT 32000 EC*	Connection at 32000 bits/s
72	CONNECT 36000 EC*	Connection at 36000 bits/s
74	CONNECT 40000 EC*	Connection at 40000 bits/s
76	CONNECT 44000 EC*	Connection at 44000 bits/s
78	CONNECT 48000 EC*	Connection at 48000 bits/s
80	CONNECT 52000 EC*	Connection at 52000 bits/s
82	CONNECT 56000 EC*	Connection at 56000 bits/s
100	CONNECT 28000 EC*	Connection at 28000 bits/s
101	CONNECT 29333 EC*	Connection at 29333 bits/s
102	CONNECT 30666 EC*	Connection at 30666 bits/s
103	CONNECT 33333 EC*	Connection at 33333 bits/s
104	CONNECT 34666 EC*	Connection at 34666 bits/s
105	CONNECT 37333 EC*	Connection at 37333 bits/s
106	CONNECT 38666 EC*	Connection at 38666 bits/s
107	CONNECT 41333 EC*	Connection at 41333 bits/s
108	CONNECT 42666 EC*	Connection at 42666 bits/s
109	CONNECT 45333 EC*	Connection at 45333 bits/s
110	CONNECT 46666 EC*	Connection at 46666 bits/s
111	CONNECT 49333 EC*	Connection at 49333 bits/s
112	CONNECT 50666 EC*	Connection at 50666 bits/s
113	CONNECT 53333 EC*	Connection at 53333 bits/s
114	CONNECT 54666 EC*	Connection at 54666 bits/s

*EC stands for the Error Control method, which appears only when the extended result codes configuration option is enabled. EC is replaced by one of the following symbols, depending on the error control method used.

V42bis V.42 error control and V.42bis data compression

V42 V.42 error control only

NoEC No error control protocol

AT Command

-V90=* V.90DialLineRate

-V90 sets the maximum V.90 downstream that the modem attempts to connect.

-V90=0 V.90 disabled

-V90=1 V.90 enabled: automatic speed selection - maximum modem speed (default)

Wireless LAN

This appendix is intended to help you get your Wireless LAN network up and running, with a minimum of parameters.

Card specifications

Form Factor	■ Mini PCI TypeIII
Capability	■ Wi-Fi (Wireless Fidelity) certified by the Wi-Fi Alliance. The "Wi-Fi CERTIFIED" logo is a certification mark of the Wi-Fi Alliance.
Network Operating System	■ Microsoft Windows® Networking
Media Access Protocol	■ CSMA/CA (Collision Avoidance) with Acknowledgment (ACK)
Data Rate	■ 54/48/36/24/18/12/9/6 Mb/s (Revision G) ■ 11/5.5/2/1 Mb/s (Revision B)

Radio characteristics

Radio characteristics of Wireless LAN cards may vary according to:

- Country/region where the product was purchased
- Type of product

Wireless communication is often subject to local radio regulations. Although Wireless LAN wireless networking products have been designed for operation in the license-free 2.4 GHz band, local radio regulations may impose a number of limitations to the use of wireless communication equipment.

NOTE: Refer to the sheet Information to the User for regulatory information that may apply in your country/region.

- R-Frequency ■ Band 2.4 GHz (2400-2483.5 MHz) (Revision B and G)
- Modulation Technique N DSSS-CCK, DSSS-DQPSK, DSSSDBPSK (Revision B)
 - OFDM-BPSK, OFDM-QPSK, OFDM-16QAM, OFDM-64QAM (Revision G)

The range of the wireless signal is related to the transmit rate of the wireless communication. Communications at lower transmit range may travel larger distances.

- The range of your wireless devices can be affected when the antennas are placed near metal surfaces and solid high-density materials.
- Range is also affected by "obstacles" in the signal path of the radio signals that may either absorb or reflect the radio signal.

Supported frequency sub-bands

Subject to the radio regulations that apply in your country/region, your Wireless LAN card may support a different set of 2.4 GHz channels.

Consult your Authorized Wireless LAN or TOSHIBA Sales office for information about the radio regulations that apply in your country/region.

Wireless IEEE 802.11 Channels Sets (Revision B and G)

Frequency Range Channel ID	2400-2472 MHz
1	2412
2	2417
3	2422
4	2427
5	2432
6	2437
7	2442
8	2447
9	2452
10	2457*1
11	2462
12	2467 *2
13	2472 *2

*1 Factory-set default channels

*2 Refer to the sheet Approved Countries/Regions for use for the countries/regions that in which these channels can be used.

When installing Wireless LAN cards, the channel configuration is managed as follows:

- For wireless clients that operate in a Wireless LAN Infrastructure, the Wireless LAN card will automatically start operation at the channel identified by the Wireless LAN Access Point. When roaming between different access points the station can dynamically switch to another channel if required.
- For Wireless LAN cards installed in wireless clients operating in a peer-to-peer mode, the card will use the default channel 10.
- In a Wireless LAN Access Point, the Wireless LAN card will use the factory-set default channel (printed in bold), unless the LAN Administrator selected a different channel when configuring the Wireless LAN Access Point device.

APPENDIX F

AC Power Cord and Connectors

The power cord's AC input plug must be compatible with the various international AC power outlets and the cord must meet the standards for the country/region in which it is used. All cords must meet the following specifications:

Length:	Minimum 2 meters
Wire size:	Minimum 0.75 mm ²
Current rating:	Minimum 2.5 amperes
Voltage rating:	125 or 250 VAC (depending on country/region's power standards)

Certification agencies

U.S. and Canada: UL listed and CSA certified

No. 18 AWG, Type SVT or SPT-2 two conductor

Europe:

Austria:	OVE	Italy:	IMQ
Belgium:	CEBEC	The Netherlands:	KEMA
Denmark:	DEMKO	Norway:	NEMKO
Finland:	SETI	Sweden:	SEMKO
France:	UTE	Switzerland:	SEV
Germany:	VDE	United Kingdom:	BSI

Australia: AS

Japan: DENANHO

In Europe, power cords must be VDE type, H05VVH2-F and two conductor.

For the United States and Canada, plug configuration must be a 2-15P (250 V) or 1-15P (125 V) as designated in the U.S. National Electrical code handbook and the Canadian Electrical Code Part II.

The following illustrations show the plug shapes for the U.S.A. and Canada, the United Kingdom, Australia and Europe.

USA and Canada

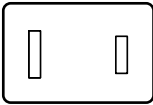

UL approved
CSA approved

United Kingdom

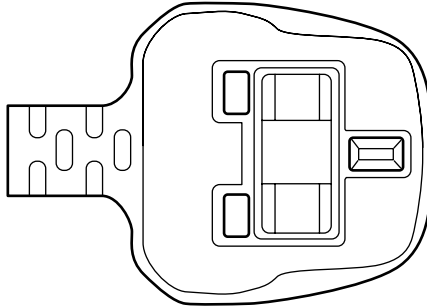

BS approved

Australia

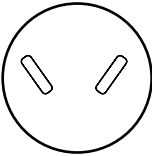

AS approved

Europe



Approved by the
appropriate agency

Internal Modem Guide

This appendix describes how to install and the remove the internal modem.

- CAUTIONS:**
1. *Do not remove the base cover except to remove or install the internal modem or to check the PTT label.*
 2. *Do not disassemble the computer beyond the steps described in this instruction or touch any components not specifically described.*
 3. *Always remove the Battery Pack and disconnect the AC Adaptor before removing the base cover.*
 4. *Be careful not to drop any screws or other foreign matter into the computer. Metal or other foreign matter can damage the computer.*

Installing the internal modem

NOTE: *The internal modem is preinstalled. The following is for information only.*

To install the modem board, follow the steps below.

1. Save your data, quit Windows and turn off the power.
2. Disconnect the AC Adaptor and any other peripheral devices.
3. Close the display panel and turn the computer over. Remove the Battery Pack.
4. Remove one screw under the battery pack slot.
5. Remove the memory slot cover and remove the fan cable.
6. Remove the cover of a hard disk drive slot.
7. Remove nine screws of the base cover of the computer, and remove the base cover.
8. Connect the modem cable to the modem board.
9. Secure the modem board with the two screws.

10. Seat the base cover and secure it with nine screws.
11. Seat the cover of a hard disk drive slot.
12. Connect the fan cable in a memory slot cover, and seat the memory slot cover.
13. Screw under the battery pack slot with the one screw.
14. Install the battery pack.

Removing the internal modem

To remove the internal modem.

1. Save your data, quit Windows and turn off the power.
2. Disconnect the AC Adaptor and any other peripheral devices.
3. Close the display panel and turn the computer over. Remove the Battery Pack.
4. Remove one screw under the battery pack slot.
5. Remove the memory slot cover and remove the fan cable.
6. Remove the cover of a hard disk drive slot.
7. Remove nine screws of the base cover of the computer, and remove the base cover.

NOTE: The standard (PTT) label can be checked.

8. Remove the two screws which are fixing the modem.
9. Disconnect the modem cable from the modem board.
10. Seat the base cover and secure it with nine screws.
11. Seat the cover of a hard disk drive slot.
12. Connect the fan cable in a memory slot cover, and seat the memory slot cover.
13. Screw under the battery pack slot with the one screw.
14. Install the battery pack.

The internal modem is approved by Japan Approvals Institute for Telecommunications Equipment.

Parts Numbers

The computer configuration and parts numbers, printed on a label on the bottom of the computer, indicate the CPU, LCD, memory, HDD and communication devices.

Configurations

The following table shows the computer configuration indicated on a label. Shaded areas indicate abbreviations used on the label. The explanations are to the left of the shading. Abbreviations are not limited to those in this chart. They may change without notice.

CPU		LCD		Memory		HDD		Communication	
Pentium-M									
1.4G	PM1.4	12.1" TFT-SXGA	12+	256MB	256MB	40GB	40	802.11b	WLB
1.5G	PM1.5			256MB+256MB	512MB	60GB	60	802.11g	WLg
1.6G	PM1.6			512MB	512MB	80GB	80	BT	BT
1.7G	PM1.7			512MB+256MB	768MB			802.11b & BT	WLB / BT
				512MB+512MB	1024MB			802.11ab & BT	WLab / BT
				1024MB	1024MB			802.11g & BT	WLg / BT
				1024MB+256MB	1280MB			802.11ag & BT	WLag / BT
				1024MB+512MB	1536MB				
		1024MB+1024MB	2048MB						

* Figures indicate the CPU operating speed in megahertz. For example, PM1.7 means Mobile Intel® Pentium® -M processor 1.7 GHz-M.

Glossary

The terms in this glossary cover the topics discussed in this manual. Alternate naming is included for reference.

Abbreviations

AC: alternating current

ANSI: American National Standards Institute

APM: advanced power manager

ASCII: American Standard Code for Information Interchange

BIOS: basic input output system

CMOS: complementary metal-oxide semiconductor

CPU: central processing unit

CRT: cathode ray tube

DAA: Data Access Arrangement

DC: direct current

DDC: display data channel

DMA: direct memory access

DOS: disk operating system

DVI: Digital Visual Interface

ECP: extended capabilities port

EGA: enhanced graphics adaptor

FDD: floppy disk drive

FIR: fast infrared

HDD: hard disk drive

IDE: integrated drive electronics

I/O: input/output

IrDA: Infrared Data Association

IRQ: interrupt request

KB: kilobyte

LCD: liquid crystal display

LED: light emitting diode

LSI: large scale integration

MDA: monochrome display adaptor

MS-DOS: Microsoft Disk Operating System

OCR: optical character recognition (reader)

PCB: printed circuit board

PCI: peripheral component interconnect

RAM: random access memory

RGB: red, green, and blue

ROM: read only memory

RTC: real time clock.

SCSI: small computer system interface

SIO: serial input/output

SVGA: super video graphics adaptor

TFT: thin-film transistor

UART: universal asynchronous receiver/transmitter

USB: Universal Serial Bus

(Abbreviations continued)

VESA: Video Electronic Standards Association

VGA: video graphics array

VRT: voltage reduction technology

A

adaptor: A device that provides an interface between two dissimilar electronic devices. For example, the AC adaptor modifies the power from a wall outlet for use by the computer. This term also refers to the add-in circuit cards that control external devices, such as video monitors and magnetic tape devices.

allocate: To assign a space or function for a specific task.

alphanumeric: Keyboard characters including letters, numbers and other symbols, such as punctuation marks or mathematical symbols.

alternating current (AC): Electric current that reverses its direction of flow at regular intervals.

analog signal: A signal whose characteristics such as amplitude and frequency vary in proportion to (are an analog of) the value to be transmitted. Voice communications are analog signals.

ANSI: American National Standards Institute. An organization established to adopt and define standards for a variety of technical disciplines. For example, ANSI defined the ASCII standard and other information processing requirements.

antistatic: A material used to prevent the buildup of static electricity.

application: A group of programs that together are used for a specific task such as accounting, financial planning, spreadsheets, word processing, and games, etc.

ASCII: American Standard Code for Information Interchange. ASCII code is a set of 256 binary codes that represent the most commonly used letters, numbers, and symbols.

async: Short for asynchronous.

asynchronous: Lacking regular time relationship. As applied to computer communications, asynchronous refers to the method of transmitting data that does not require a steady stream of bits to be transmitted at regular time intervals.

AUTOEXEC.BAT: A batch file that executes a series of MS-DOS commands and programs each time you start the computer.

B

backup: A duplicate copy of files kept as a spare in case the original is destroyed.

batch file: A file that can be executed from the system prompt containing a sequence of operating system commands or executable files. See also AUTOEXEC.BAT.

binary: The base two number system composed of zeros and ones (off or on), used by most digital computers. The right most digit of a binary number has a value of 1, the next a value of 2, then 4, 8, 16, and so on. For example, the binary number 101 has a value of 5. *See also* ASCII.

BIOS: Basic Input Output System. The firmware that controls data flow within the computer. *See also* firmware.

bit: Derived from “binary digit,” the basic unit of information used by the computer. It is either zero or one. Eight bits is one byte. *See also* byte.

Bluetooth: A short-range radio technology designed to simplify wireless communication among computers, communication devices and the Internet.

board: A circuit board. An internal card containing electronic components, called chips, which perform a specific function or increase the capabilities of the system.

boot: Short for bootstrap. A program that starts or restarts the computer. The program reads instructions from a storage device into the computer’s memory.

bps: Bits per second. Typically used to describe the data transmission speed of a modem.

buffer: The portion of the computer’s memory where data is temporarily stored. Buffers often compensate for differences in the rate of flow from one device to another.

bus: An interface for transmission of signals, data or electric power.

byte: The representation of a single character. A sequence of eight bits treated as a single unit; also the smallest addressable unit within the system.

C

cache memory: High speed memory which stores data that increases processor speed and data transfer rate. When the CPU reads data from main memory, it stores a copy of this data in cache memory. The next time the CPU needs that same data, it looks for it in the cache memory rather than the main memory, which saves time. The computer has two cache levels. Level one is incorporated into the processor and level two resides in external memory.

capacity: The amount of data that can be stored on a magnetic storage device such as a diskette (floppy disk) or hard disk. It is usually described in terms of kilobytes (KB), where one KB = 1024 bytes and megabytes (MB), where one MB = 1024KB.

card: Synonym for board. *See* board.

CardBus: An industry standard bus for 32-bit PC Cards.

CD-ROM: A Compact Disk-Read Only Memory is a high capacity disk that can be read from but not written to. The CD-ROM drive uses a laser, rather than magnetic heads, to read data from the disk.

character: Any letter, number, punctuation mark, or symbol used by the computer. Also synonymous with byte.

chassis: The frame containing the computer.

chip: A small semiconductor containing computer logic and circuitry for processing, memory, input/output functions and controlling other chips.

CMOS: Complementary Metal-Oxide Semiconductor. An electronic circuit fabricated on a silicon wafer that requires very little power. Integrated circuits implemented in CMOS technology can be tightly packaged and are highly reliable.

cold start: Starting a computer that is currently off (turning on the power).

commands: Instructions you enter at the terminal keyboard that direct the actions of the computer or its peripheral devices.

communications: The means by which a computer transmits and receives data to and from another computer or device.

Compact Flash: A small removable mass storage device, designed with flash technology, a non-volatile storage solution that does not require a battery to retain data indefinitely.

compatibility: 1) The ability of one computer to accept and process data in the same manner as another computer without modifying the data or the media upon which it is being transferred. 2) the ability of one device to connect to or communicate with another system or component.

components: Elements or parts (of a system) which make up the whole (system).

computer program: A set of instructions written for a computer that enable it to achieve a desired result.

computer system: A combination of hardware, software, firmware, and peripheral components assembled to process data into useful information.

configuration: The specific components in your system (such as the terminal, printer, and disk drives) and the settings that define how your

system works. You use the HW Setup program to control your system configuration.

control keys: A key or sequence of keys you enter from the keyboard to initiate a particular function within a program.

controller: Built-in hardware and software that controls the functions of a specific internal or peripheral device (e.g. keyboard controller).

co-processor: A circuit built into the processor that is dedicated to intensive math calculations.

CPS: Characters per second. Typically used to indicate the transmission speed of a printer.

CPU: Central processing unit. The portion of the computer that interprets and executes instructions.

CRT: Cathode Ray Tube. A vacuum tube in which beams projected on a fluorescent screen-producing luminous spots. An example is the television set.

cursor: A small, blinking rectangle or line that indicates the current position on the display screen.

D

data: Information that is factual, measurable or statistical that a computer can process, store, or retrieve.

data access arrangement: Circuitry that isolates a modem or other device from telephone lines.

data bits: A data communications parameter controlling the number of bits (binary digits) used to make up a byte. If data bits = 7 the computer can generate 128 unique characters. If data bits = 8 the computer can generate 256 unique characters.

DC: Direct Current. Electric current that flows in one direction. This type of power is usually supplied by batteries.

default: The parameter value automatically selected by the system when you or the program do not provide instructions. Also called a preset value.

delete: To remove data from a disk or other data storage device. Synonymous with erase.

device driver: A program that controls communication between a specific peripheral device and the computer. The CONFIG.SYS file contains device drivers that MS-DOS loads when you turn the computer on.

dialog box: A window that accepts user input to make system settings or record other information.

disk drive: The device that randomly accesses information on a disk and copies it to the computer's memory. It also writes data from memory to the disk. To accomplish these tasks, the

disk storage

unit physically rotates the disk at high speed past a read-write head.

disk storage: Storing data on magnetic disk. Data is arranged on concentric tracks much like a phonograph record.

diskette: A removable disk that stores magnetically encoded data used on a microcomputer. Also called floppy disk.

display: A CRT, plasma screen, LCD, or other image producing device used to view computer output.

documentation: The set of manual and/or other instructions written for the users of a computer system or application. Computer system documentation typically includes procedural and tutorial information as well as system functions.

DOS: Disk operating system. *See* operating system.

driver: A software program, generally part of the operating system, that controls a specific piece of hardware (frequently a peripheral device such as a printer or mouse).

E

echo: To send back a reflection of the transmitted data to the sending device. You can display the information on the screen, or output it to the printer, or both. When a computer receives back data it transmitted to a CRT (or other

peripheral device) and then retransmits the data to printer, the printer is said to echo the CRT.

erase: *See* delete.

escape: 1) A code (ASCII code 27), signaling the computer that what follows are commands; used with peripheral devices such as printers and modems. 2) A means of aborting the task currently in progress.

escape guard time: A time before and after an escape code is sent to the modem which distinguishes between escapes that are part of the transmitted data, and escapes that are intended as a command to the modem.

execute: To interpret and execute an instruction.

Extended Capability Port: An industry standard that provides a data buffer, switchable forward and reverse data transmission, and run length encoding (RLE) support.

F

fast infrared: An industry standard that enables cableless infrared serial data transfer at speeds of up to 4 Mbps.

file: A collection of related information; a file can contain data, programs, or both.

firmware: A set of instructions built into the hardware which controls and

directs a microprocessor's activities.

fixed disk: *See* hard disk.

floppy disk: *See* diskette.

floppy disk drive (FDD): An electromechanical device that reads and writes to floppy disks. *See also* diskette.

Fn-esse: A TOSHIBA utility that lets you assign functions to hotkeys.

folder: An icon in Windows used to store documents or other folders.

format: The process of readying a blank disk for its first use. Formatting establishes the structure of the disk that the operating system expects before it writes files or programs onto the disk.

function keys: The keys labeled **F1** through **F12** that tell the computer to perform certain functions.

G

gigabyte (GB): A unit of data storage equal to 1024 megabytes. *See also* megabyte.

GND: Ground. An RS-232C signal used in the exchange of data between a computer and serial device.

graphics: The use of drawings, pictures, or other images, such as charts or graphs, to present information.

H

hard disk: A non-removable disk usually referred to as drive C. The factory installs this disk and only a trained engineer can remove it for servicing. Also called fixed disk.

hard disk drive (HDD): An electromechanical device that reads and writes a hard disk. *See also* hard disk.

hardware: The physical electronic and mechanical components of a computer system: typically, the computer itself, external disk drives, etc. *See also* software and firmware.

hertz: A unit of wave frequency that equals one cycle per second.

hexadecimal: The base 16 numbering system composed of the digits 0 through 9 and the letters A, B, C, D, E, and F.

host computer: The computer that controls, regulates, and transmits information to a device or another computer.

hot dock/undock: Connecting or disconnecting a device to or from the computer while the computer's power is turned on.

hotkey: The computer's feature in which certain keys in combination with the extended function key, **Fn**, can be used to set system parameters, such as speaker volume.

HW Setup

HW Setup: A TOSHIBA utility that lets you set the parameters for various hardware components.

I

icon: A small graphic image displayed on the screen or in the indicator panel. In Windows, an icon represents an object that the user can manipulate.

infrared port: A cableless communications capable of using infrared signals to send serial data.

input: The data or instructions you provide to a computer, communication device or other peripheral device from the keyboard or external or internal storage devices. The data sent (or output) by the sending computer is input for the receiving computer.

instruction: Statements or commands that specify how to perform a particular task.

interface: 1) Hardware and/or software components of a system used specifically to connect one system or device to another. 2) To physically connect one system or device to another to exchange information. 3) The point of contact between user, the computer, and the program, for example, the keyboard or a menu.

interrupt request: A signal that gives a component access to the processor.

I/O: Input/output. Refers to acceptance and transfer of data to and from a computer.

I/O devices: Equipment used to communicate with the computer and transfer data to and from it.

J

jumper: A small clip or wire that allows you to change the hardware characteristics by electrically connecting two points of a circuit.

K

K: Taken from the Greek word kilo, meaning 1000; often used as equivalent to 1024, or 2 raised to the 10th power. *See also* byte and kilobyte.

KB: *See* kilobyte.

keyboard: An input device containing switches that are activated by manually pressing marked keys. Each keystroke activates a switch that transmits a specific code to the computer. For each key, the transmitted code is, in turn, representative of the (ASCII) character marked on the key.

kilobyte (KB): A unit of data storage equal to 1024 bytes. *See also* byte and megabyte.

L

level 2 cache: *See* cache.

Light Emitting Diode (LED): A semiconductor device that emits light when a current is applied.

Liquid Crystal Display (LCD): Liquid crystal sealed between two sheets of glass coated with transparent conducting material. The viewing-side coating is etched into character forming segments with leads that extend to the edge of the glass. Applying a voltage between the glass sheets darkens the liquid crystal to provide contrast to lighted portions of the display.

LSI: Large Scale Integration. 1) A technology that allows the inclusion of up to 100,000 simple logic gates on a single chip. 2) An integrated circuit that uses the large scale integration.

M

main board: *See* motherboard.

megabyte (MB): A unit of data storage equal to 1024 kilobytes. *See also* kilobyte.

megahertz: A unit of wave frequency that equals 1 million cycles per second. *See also* hertz.

menu: A software interface that displays a list of options on the screen. Also called a screen.

microprocessor: A hardware component contained in a single integrated circuit that carries out instructions. Also called the central processing unit (CPU), one of the main parts of the computer.

mode: A method of operation, for example, the boot mode or the resume mode.

modem: Derived from modulator/demodulator, a device that converts (modulates) digital data for transmission over telephone lines and then converts modulated data (demodulates) to digital format where received.

monitor: A device that uses rows and columns of pixels to display alphanumeric characters or graphic images. *See* CRT.

motherboard: A name sometimes used to refer to the main printed circuit board in processing equipment. It usually contains integrated circuits that perform the processor's basic functions and provides connectors for adding other boards that perform special functions. Sometimes called a main board.

N

non-system disk: A formatted diskette (floppy disk) you can use to store programs and data but you cannot use to start the computer. *See* system disk.

nonvolatile memory: Memory, usually read-only (ROM), that is capable of permanently storing information. Turning the computer's power off does not alter data stored in nonvolatile memory.

numeric keypad overlay: A feature that allows you to use certain keys on the keyboard to perform numeric entry, or to control cursor and page movement.

O

OCR: Optical Character Recognition (reader). A technique or device that uses laser or visible light to identify characters and input them into a storage device.

OCR wand: A device that reads, using an optical device, hand written or machine printed symbols into a computer. *See also* OCR.

online state: A functional state of a peripheral device when it is ready to receive or transmit data.

operating system: A group of programs that controls the basic operation of a computer. Operating

system functions include interpreting programs, creating data files, and controlling the transmission and receipt (input/output) of data to and from memory and peripheral devices.

output: The results of a computer operation. Output commonly indicates data 1) printed on paper, 2) displayed at a terminal, 3) sent through the serial port of internal modem, or 4) stored on some magnetic media.

P

parity: 1) The symmetrical relationship between two parameter values (integers) both of which are either on or off; odd or even; 0 or 1. 2) In serial communications, an error detection bit that is added to a group of data bits making the sum of the bits even or odd. Parity can be set to none, odd, or even.

password: A unique string of characters used to identify a specific user. The computer provides various levels of password protection such as user, supervisor and eject.

pel: The smallest area of the display that can be addressed by software. Equal in size to a pixel or group of pixels. *See* pixel.

peripheral component interconnect: An industry standard 32-bit bus.

peripheral device: An I/O device that is external to the central processor and/or main memory such as a printer or a mouse.

pixel: A picture element. The smallest dot that can be made on a display or printer. Also called a pel.

plug and play: A capability with Windows that enables the system to automatically recognize connections of external devices and make the necessary configurations in the computer.

port: The electrical connection through which the computer sends and receives data to and from devices or other computers.

printed circuit board (PCB): A hardware component of a processor to which integrated circuits and other components are attached. The board itself is typically flat and rectangular, and constructed of fiberglass, to form the attachment surface.

program: A set of instructions a computer can execute that enables it to achieve a desired result. See also application.

prompt: A message the computer provides indicating it is ready for or requires information or an action from you.

R

Radio frequency interference (RFI) shield: A metal shield enclosing the printed circuit boards of the printer or computer to prevent radio and TV interference. All computer equipment generates radio frequency signals. The FCC regulates the amount of signals a computing device can allow past its shielding. A Class A device is sufficient for office use. Class B provides a more stringent classification for home equipment use. TOSHIBA portable computers comply with Class B computing device regulations.

Random Access Memory (RAM): High speed memory within the computer circuitry that can be read or written to.

restart: Resetting a computer without turning it off (also called 'warm boot' or 'soft reset'). To restart the computer, press **Ctrl + Alt + Del** while the computer is on. See also boot.

RGB: Red, green, and blue. A device that uses three input signals, each activating an electron gun for a primary additive color (red, green, and blue) or port for using such a device. *See also* CRT.

RJ11: A modular telephone jack.

ROM: Read Only Memory: A nonvolatile memory chip manufactured to contain information that controls the computer's basic operation. You cannot access or change information stored in ROM.

S

SCSI: Small Computer System Interface is an industry standard interface for connection of a variety of peripheral devices.

SD card: SD (Secure Digital) card was developed as a non-volatile memory card with a postage stamp size (24X32X2.1 mm). SD card is featuring the function of copyright protection.

SIO: Serial Input/Output. The electronic methodology used in serial data transmission.

soft key: Key combinations that emulate keys on the IBM keyboard, change some configuration options, stop program execution, and access the numeric keypad overlay.

software: The set of programs, procedures and related documentation associated with a computer system. Specifically refers to computer programs that direct and control the computer system's activities. *See also* hardware.

stop bit: One or more bits of a byte that follow the transmitted character or group codes in asynchronous serial communications.

subpixel: Three elements, one red, one green and blue (RGB), that make up a pixel on the color LCD. The computer sets subpixels independently, each may emit a different degree of brightness. *See also* pixel.

synchronous: Having a constant time interval between successive bits, characters or events.

system disk: A disk that has been formatted with an operating system. For MS-DOS the operating system is contained in two hidden files and the COMMAND.COM file. You can boot a computer using a system disk. Also called an operating system disk.

T

Tablet PC: A fully functional computer that runs Microsoft Windows XP Tablet PC Edition. With a Tablet PC, you can write directly on the screen by using a tablet pen and use the pen to perform mouse functions.

terminal: A typewriter-like keyboard and CRT display screen connected to the computer for data input/output.

TFT: A color LCD technology that applies individual transistors to each pixel enabling fine display control and excellent screen legibility.

TOSHIBA Power Saver: A TOSHIBA utility that lets you set the parameters for various power-saving functions.

TOSHIBA tablet pen: An input device for Tablet PC. User can write the character on a display screen with a digitizing function or tap to select the item appearing on the screen using the tablet pen.

Touch pad: A pointing device integrated into the TOSHIBA computer palm rest.

TTL: Transistor-transistor logic. A logic circuit design that uses switching transistors for gates and storage.

U

Universal Serial Bus: This serial interface lets you communicate with several devices connected in a chain to a single port on the computer.

V

VGA: Video graphics array is an industry standard video adaptor that lets you run any popular software.

volatile memory: Random access memory (RAM) that stores information as long as the computer is connected to a power source.

W

Warm dock/undock: Connecting or disconnecting a device to or from the computer while the computer is suspended.

warm start: Restarting or resetting a computer without turning it off.

window: A portion of the screen that can display its own application or document. Often used to mean a Microsoft Windows window.

Wireless LAN: A short-range radio technology designed to simplify wireless communication with other LAN systems based on Direct Sequence Spread Spectrum radio technology that complies with the IEEE 802.11 Standard (Revision B).

write protection: A method for protecting a diskette (floppy disk) from accidental erasure.

Index

A

- AC adaptor 1-4, 2-12
 - DCIN 15V port 2-4
 - connecting 3-6
 - universal 1-12, 8-10
- ASCII characters 5-9
- Auto power on, *See* Power

B

- Battery, *See also* Battery Pack
 - charging 6-9
 - extending life 6-12
 - indicator 2-9, 6-3
 - lock 2-6, 6-14
 - monitoring capacity 6-10
 - real time clock 1-4, 6-5
 - safety precautions 6-6
 - save mode 1-7
 - types 6-4
- Battery Charger 1-12, 8-11
- Battery Pack 1-4, 1-11, 6-5
 - location 2-5
 - replacing 6-13
- Bluetooth 1-6, 4-17
- Boot priority 7-3

C

- Cache memory
 - Level 2 cache 1-3
- Charger, *See* Battery Charger
- Cleaning the computer 4-27
- Cooling, *See* Heat dispersal

D

- DCIN 15V indicator 2-10, 6-3
- Disk indicator 2-9
- Diskette care 4-15
- Display 1-3, 2-7, *See also* Video
 - modes *and* Monitor external
 - automatic power off 1-7
 - controller 1-3, Appendix B
 - driver 1-9
 - hinge 2-7
 - opening 3-8
 - selection, *See* Hot keys
- Documentation list 1-2

E

- Environment, *See* Work space
- Equipment checklist 1-1
- Equipment setup
 - general conditions 3-2
 - placement 3-3
- Ergonomics
 - lighting 3-4
 - seating and posture 3-3
 - work habits 3-4
- Expansion memory, *See* Memory
 - expansion

F

- Fn + Ctrl (enhanced keyboard simulation) 5-3
- Fn + Enter 5-3
- Fn + Esc (sound mute) 5-4
- Fn-esse 1-9
- Fn + F1 (instant security) 5-4
- Fn + F2 (power save mode) 5-4

Fn + F3 (standby) 5-4
Fn + F4 (hibernation) 5-5
Fn + F5 (display selection) 5-5
Fn + F6 (display brightness) 5-5
Fn + F7 (display brightness) 5-5
Fn + F8 (wireless setting) 5-6
Fn + F9 (touch pad) 5-6
Fn + F10 (arrow mode) 5-3, 5-8
Fn + F11 (numeric mode) 5-3, 5-8
Fn + F12 (ScrLock) 5-3
Fn Sticky key 5-7
Function Keys 5-2

H

Hard disk drive 1-3
 automatic power off 1-7
 problems 9-9
Heat dispersal 1-8
Hibernation 1-8, 5-5
Hotkeys 1-7, 5-4
 display brightness 5-5
 display selection 5-5
 hibernation 5-5
 instant security 5-4
 power save mode 5-4
 standby 5-4
 sticky key utility 5-7
HW Setup 1-9
 accessing 7-1
 Boot Priority 7-3
 CPU 7-2
 Device Config 7-2
 Display 7-2
 General 7-1
 Keyboard 7-5
 LAN 7-6
 USB 7-5
 window 7-1

I

Indicators 2-9, 6-3

Infrared port, *See also* Ports
 problems 9-10
Instant security, *See* Hot keys
Interfaces, *See* Ports

K

Keyboard 1-4, 5-1
 emulating enhanced keyboard 5-2
 F1 . . . F12 function keys 5-2
 problems 9-8
 Typewriter keys 5-1
Keypad overlay 1-7, 5-7
 arrow mode 5-8
 numeric mode 5-8
 temporarily changing modes 5-9
 temporarily using normal keyboard
 (overlay on) 5-8
 temporarily using overlay (overlay
 off) 5-9
 turning on 5-7
 Windows special keys 5-7

L

LAN, *See also* Wireless LAN 1-6
 active indicator 2-5
 cable types 4-19
 connecting 4-19
 disconnecting 4-20
 jack location 2-4
 problems 9-19
 using 4-19
Laptop mode 3-5
LCD, *See* Display, Video modes and
 Monitor external
Level 2 cache, *See* Cache memory
Lock, security, *See* Security lock

M

Memory 1-3
 expansion 1-11, 8-6
 installing 8-7

- removing 8-9
 - slots 1-3
 - Microphone, *See* sound system, microphone
 - Microprocessor, *See* Processor
 - Modem 1-5, 4-24
 - connecting 4-26
 - disconnecting 4-27
 - jack location 2-4
 - problems 9-17
 - properties menu 4-25
 - region selection 4-25
 - Monitor external 8-12, *See also* Video modes *and* Ports
 - problems 9-14
 - Moving the computer 4-28
- N**
- Numeric keypad, *See* Keypad overlay
- O**
- Operating system, *See* Windows
 - Overlay, *See* Keypad overlay
- P**
- Panel power on/off, *See* Power
 - Password
 - power on 1-7
 - starting the computer with 6-18
 - supervisor 1-9, 6-17
 - user 6-16
 - PC card 1-5
 - inserting 8-2
 - location of slots 2-2
 - problems 9-13
 - removing 8-4
 - Ports
 - DCIN 15V 2-4
 - external monitor 1-5, 2-4
 - headphone, *See* Sound system
 - infrared 1-4, 2-1
 - LAN 2-5
 - microphone, *See* Sound system
 - modem 2-5
 - USB 1-5, 2-4
 - Power
 - auto power on 1-8
 - button location 2-7
 - indicator 2-9, 6-4
 - panel power on/off 1-8
 - restarting 3-15
 - turning off 3-10
 - turning on 3-9
 - system auto off 1-7
 - Power cord 1-4, 2-11, Appendix G
 - Problems
 - AC power 9-5
 - analyzing symptoms 9-2
 - battery 9-6
 - Bluetooth 9-20
 - diskette drive 9-9
 - hard disk drive 9-8
 - hardware and system checklist 9-3
 - infrared port 9-10
 - keyboard 9-8
 - LAN 9-19
 - LCD panel 9-8
 - memory expansion 9-16
 - modem 9-17
 - monitor, external 9-14
 - password 9-7
 - PC card 9-13
 - pointing device 9-10
 - power 9-4
 - preliminary checklist 9-1
 - SD card 9-14
 - self test 9-4
 - sound system 9-15
 - support from TOSHIBA 9-21
 - system start-up 9-3
 - TOSHIBA Tablet PC Pen 9-10
 - Touch Pad 9-11
 - USB 9-15

USB mouse 9-12
Wireless LAN 9-19

Processor 1-3

R

Real time clock battery, *See* Battery
Recovery CD-ROM 3-15

S

Screen, *See* Display
 orientation 4-10
ScrLock (Fn + F12), *See* Soft keys
SD card 1-5
 indicator 2-2
 inserting 8-4
 location of slot 2-1
 problems 9-14
 removing 8-4
Security lock 1-12
 attaching 8-13
 location 2-3
Self Test, *See* Problems
Sensor switch 2-8
Soft keys 5-2
 cursor control mode 5-3
 Enter 5-3
 numeric mode 5-8
 right Ctrl key 5-3
 ScrLock 5-3
Sound system 1-5
 drivers 1-10
 headphone 1-5, 2-1
 microphone 1-5, 2-1
 problems 9-15
 speaker 2-8
Standby 1-8
System auto off 1-7

T

Tablet mode 3-5
Tablet PC 3-5

Tablet PC Pen 1-1, 1-4, 4-2
TOSHIBA Console 1-2
TOSHIBA Power Saver 1-2
Touch Pad 1-4, 2-7
 control buttons 2-7, 4-1
 problems 9-11
 using 4-1
Troubleshooting, *See* Problems

U

Utilities
 list 1-9
USB 1-5
 location 2-4
 problems 9-15
USB FDD Kit 1-11, 8-11
 connecting 4-14
 disconnecting 4-15
 problems 9-9
 using 4-13

V

Video modes, Appendix B
Video RAM 1-3

W

Wireless communication
 indicator 2-9, 4-18
 switch 2-3, 4-18
Wireless LAN 1-6, 4-16
 problems 9-19
 using 4-16
Work space 3-3