



TOSHIBA

User's Manual

TECRA M7

Table of Contents

Copyright	vi
Disclaimer	vi
Trademarks	vi
FCC information	vii
EU Declaration of Conformity	viii
VCCI Class B Information	viii
Modem warning notice	viii
Japan regulations	ix
Instructions for IC CS-03 certified equipment	xii
Notes for Users in Australia and New Zealand	xiii
Optical disc drive safety instructions	xvi
International precautions	xxi
Preface	
Conventions	xxiii
General Precautions	
Creating a computer-friendly environment	xxv
Stress injury	xxv
Heat injury	xxvi
Pressure or impact damage	xxvi
PC card overheating	xxvi
Mobile phones	xxvi
Instruction Manual for Safety & Comfort	xxvi
<i>Chapter 1</i> Getting Started	
Equipment checklist	1-1
Getting Started	1-3
Operating the computer in Tablet mode	1-4
Connecting the AC adaptor	1-6
Opening the display	1-8
Turning on the power	1-8
Starting up for the first time	1-9
Turning off the power	1-9

	Restarting the computer	1-13
	Create Optical Recovery Discs	1-13
	Restoring the preinstalled software from the Recovery HDD	1-14
	Restoring the preinstalled software from your creating Recovery Media	1-14
<i>Chapter 2</i>	The Grand Tour	
	Front with the display closed	2-1
	Left side	2-3
	Right side	2-4
	Back side	2-5
	Underside	2-7
	Front with the display open	2-8
	Operation buttons	2-11
	System indicators	2-11
	Keyboard indicators	2-12
	Optical disc drives	2-13
	AC adaptor	2-16
<i>Chapter 3</i>	Features, Utilities and Options	
	Features	3-1
	Special features	3-6
	Utilities	3-8
	Optional devices	3-12
	PC card	3-13
	Bridge media slot	3-15
	Memory expansion	3-22
	Battery Pack	3-27
	Universal AC Adaptor	3-28
	Slice Expansion Battery	3-28
	Battery Charger	3-29
	USB FDD Kit	3-29
	Tablet PC Pen	3-31
	Reserve Pen	3-31
	External monitor	3-31
	TV	3-32
	Displaying movies on a TV or CRT	3-33
	i.LINK (IEEE1394)	3-34
	TOSHIBA Express Port Replicator	3-36
	Bluetooth USB Adaptor	3-37
	Wireless Optical Mouse with Bluetooth Technology	3-37
	Wireless Stereo Headset with Bluetooth Technology	3-37
	Security lock	3-37
	Options	3-38
<i>Chapter 4</i>	Operating Basics	
	Using the Touch Pad	4-1

	Using the Tablet PC Pen and Reserve Pen	4-2
	Changing to the Tablet mode	4-7
	Changing the screen orientation	4-9
	Using Accelerometer Utilities	4-11
	Changing to the laptop mode	4-12
	Using the Fingerprint Sensor	4-12
	Using optical disc drives	4-19
	Writing CDs on DVD-ROM&CD-R/RW drive	4-23
	Writing CD/DVDs on DVD Super Multi drive	4-25
	Media care	4-31
	Sound System	4-32
	Modem	4-33
	Wireless communications	4-36
	LAN	4-40
	Cleaning the computer	4-42
	Moving the computer	4-42
	Using the Hard Disk Drive (HDD) Protection	4-43
	Heat dispersal	4-45
Chapter 5	The Keyboard	
	Typewriter keys	5-1
	Function keys: F1 ... F12	5-2
	Soft keys: Fn key combinations	5-2
	Hot keys	5-3
	Windows special keys	5-7
	Keypad overlay	5-7
	Generating ASCII characters	5-9
Chapter 6	Power and Power-Up Modes	
	Power conditions	6-1
	Power indicators	6-4
	Battery types	6-5
	Care and use of the battery pack	6-7
	Replacing the battery pack	6-11
	TOSHIBA Password Utility	6-13
	Tablet mode	6-17
	Power-up modes	6-17
	Panel power on/off	6-18
	System Auto Off	6-18
Chapter 7	HW Setup & BIOS Setup	
	Accessing HW Setup	7-1
	HW Setup window	7-1
	BIOS Setup Program	7-8
Chapter 8	Troubleshooting	
	Problem solving process	8-1

	Hardware and system checklist	8-3
	TOSHIBA support	8-22
<i>Appendix A</i>	Specifications	
	Physical Dimensions	A-1
<i>Appendix B</i>	Display Controller and Modes	
	Display controller	B-1
	Video mode	B-1
	PowerMizer	B-2
<i>Appendix C</i>	AT Commands	
<i>Appendix D</i>	S-registers	
	S-register values	D-1
	AT command set result codes	D-6
<i>Appendix E</i>	V.90	
	V.90 mode	E-1
	AT Command	E-3
<i>Appendix F</i>	Wireless LAN	
	Card Specifications	F-1
	Radio Characteristics	F-2
	Supported Frequency Sub-bands	F-3
<i>Appendix G</i>	Bluetooth wireless technology Interoperability	
	Bluetooth wireless technology and your Health	G-3
	Regulatory statements	G-3
	Using Bluetooth® Card from TOSHIBA equipment in Japan	G-5
<i>Appendix H</i>	AC Power Cord and Connectors	
	Certification agencies	H-1
<i>Appendix I</i>	TOSHIBA Anti-theft Protection Timer	
<i>Appendix J</i>	Legal Footnotes	
	Non-applicable Icons*1	J-1
	CPU*2	J-1
	Memory (Main System)*3	J-2
	Battery Life*4	J-2
	Hard Disk Drive (HDD) Capacity*5	J-3
	LCD*6	J-3
	Graphics Processor Unit ("GPU")*7	J-3
	Wireless LAN*8	J-3
	Copy Protection*9	J-3
	Images*10	J-3
	Glossary	
	Index	

Copyright

© 2006 by TOSHIBA Corporation. All rights reserved. Under the copyright laws, this manual cannot be reproduced in any form without the prior written permission of TOSHIBA. No patent liability is assumed, with respect to the use of the information contained herein.

TOSHIBA TECRA M7 Portable Personal Computer User's Manual

First edition June 2006

Copyright authority for music, movies, computer programs, data bases and other intellectual property covered by copyright laws belongs to the author or to the copyright owner. Copyrighted material can be reproduced only for personal use or use within the home. Any other use beyond that stipulated above (including conversion to digital format, alteration, transfer of copied material and distribution on a network) without the permission of the copyright owner is a violation of copyright or author's rights and is subject to civil damages or criminal action. Please comply with copyright laws in making any reproduction from this manual.

Disclaimer

This manual has been validated and reviewed for accuracy. The instructions and descriptions it contains are accurate for the TOSHIBA TECRA M7 Portable Personal Computer at the time of this manual's production. However, succeeding computers and manuals are subject to change without notice. TOSHIBA assumes no liability for damages incurred directly or indirectly from errors, omissions or discrepancies between the computer and the manual.

Trademarks

IBM is a registered trademark and IBM PC is a trademark of International Business Machines Corporation.

Intel, Intel SpeedStep, Intel Core, Celeron and Centrino are trademarks or registered trademarks of Intel Corporation.

Windows and Microsoft are registered trademarks of Microsoft Corporation.

Photo CD is a trademark of Eastman Kodak.

Sonic RecordNow! is a registered trademark of Sonic Solutions.

Bluetooth is a trademark owned by its proprietor and used by TOSHIBA under license.

Memory Stick and i.LINK are trademark and registered trademark of Sony Corporation.

InterVideo and WinDVD are registered trademarks of InterVideo Inc.

Other trademarks and registered trademarks not listed above may be used in this manual.

FCC information

Product Name : TECRA M7

Model number : PTM70/PTM71

FCC notice "Declaration of Conformity Information"

This equipment has been tested and found to comply with the limits for a Class B digital device, pursuant to part 15 of the FCC rules. These limits are designed to provide reasonable protection against harmful interference in a residential installation. This equipment generates, uses and can radiate radio frequency energy and, if not installed and used in accordance with the instructions, may cause harmful interference to radio communications. However, there is no guarantee that interference will not occur in a particular installation. If this equipment does cause harmful interference to radio or television reception, which can be determined by turning the equipment off and on, the user is encouraged to try to correct the interference by one or more of the following measures:

- Reorient or relocate the receiving antenna.
- Increase the separation between the equipment and receiver.
- Connect the equipment into an outlet on a circuit different from that to which the receiver is connected.
- Consult the dealer or an experienced radio/TV technician for help.



Only peripherals complying with the FCC class B limits may be attached to this equipment. Operation with non-compliant peripherals or peripherals not recommended by TOSHIBA is likely to result in interference to radio and TV reception. Shielded cables must be used between the external devices and the computer's external monitor port, USB port, IEEE1394 port and microphone jack. Changes or modifications made to this equipment, not expressly approved by TOSHIBA or parties authorized by TOSHIBA could void the user's authority to operate the equipment.

FCC conditions

This device complies with part 15 of the FCC Rules. Operation is subject to the following two conditions:

1. This device may not cause harmful interference.
2. This device must accept any interference received, including interference that may cause undesired operation.

Contact

Address: TOSHIBA America Information Systems, Inc.
9740 Irvine Boulevard
Irvine, California 92618-1697

Telephone: (949) 583-3000

EU Declaration of Conformity



TOSHIBA declares, that the product: PTM70*/PTM71* conforms to the following Standards:

Supplementary Information:	“The product complies with the requirements of the Low Voltage Directive 73/23/EEC, the EMC Directive 89/336/EEC and/or the R&TTE Directive 1999/5/EC.”
----------------------------	---

This product is carrying the CE-Mark in accordance with the related European Directives. Responsible for CE-Marking is TOSHIBA Europe GmbH, Hammfelddamm 8, 41460 Neuss, Germany.

VCCI Class B Information

この装置は、情報処理装置等電波障害自主規制協議会（VCCI）の基準に基づくクラスB情報技術装置です。この装置は、家庭環境で使用することを目的としていますが、この装置がラジオやテレビジョン受信機に近接して使用されると、受信障害を引き起こすことがあります。
取扱説明書に従って正しい取り扱いをして下さい。

Modem warning notice

Conformity Statement

The equipment has been approved to [Commission Decision "CTR21"] for pan-European single terminal connection to the Public Switched Telephone Network (PSTN).

However, due to differences between the individual PSTNs provided in different countries/regions the approval does not, of itself, give an unconditional assurance of successful operation on every PSTN network termination point.

In the event of problems, you should contact your equipment supplier in the first instance.

Network Compatibility Statement

This product is designed to work with, and is compatible with the following networks. It has been tested to and found to conform with the additional requirements conditional in EG 201 121.

Germany	ATAAB AN005,AN006,AN007,AN009,AN010 and DE03,04,05,08,09,12,14,17
Greece	ATAAB AN005,AN006 and GR01,02,03,04
Portugal	ATAAB AN001,005,006,007,011 and P03,04,08,10
Spain	ATAAB AN005,007,012, and ES01
Switzerland	ATAAB AN002

All other countries/regions ATAAB AN003,004

Specific switch settings or software setup are required for each network, please refer to the relevant sections of the user guide for more details.

The hookflash (timed break register recall) function is subject to separate national type approvals. It has not been tested for conformity to national type regulations, and no guarantee of successful operation of that specific function on specific national networks can be given.

Japan regulations

Region selection

If you are using the computer in Japan, technical regulations described in the Telecommunications Business Law require that you select the Japan region mode. It is illegal to use the modem in Japan with any other selection.

Redial

Up to two redial attempts can be made. If more than two redial attempts are made, the modem will return **Black Listed**. If you are experiencing problems with the Black Listed code, set the interval between redials at one minute or longer.

Japan's Telecommunications Business Law permits up to two redials on analogue telephones, but the redials must be made within a total of three minutes.

The internal modem is approved by Japan Approvals Institute for Telecommunications Equipment.

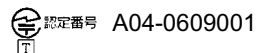

One of the labels is located on the module.

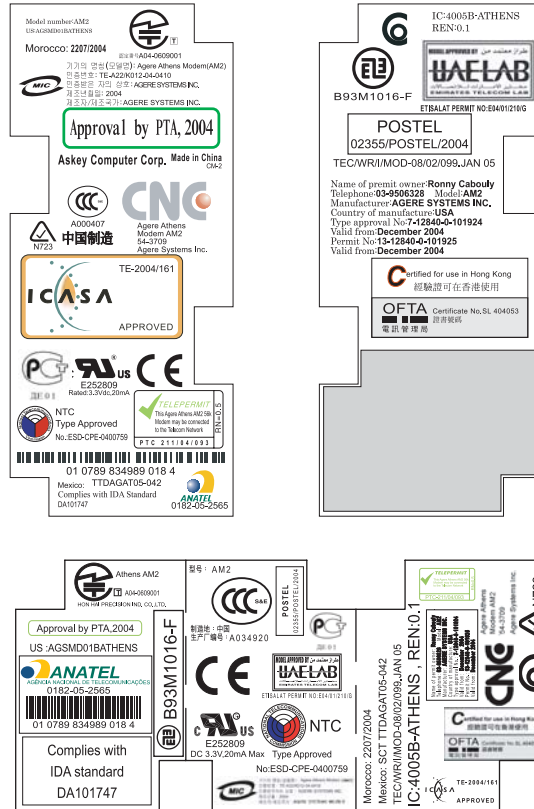

Pursuant to FCC CFR 47, Part 68:

When you are ready to install or use the modem, call your local telephone company and give them the following information:

- The telephone number of the line to which you will connect the modem
- The registration number that is located on the device

The FCC registration number of the modem will be found on either the device which is to be installed, or, if already installed, on the bottom of the computer outside of the main system label.

- The Ringer Equivalence Number (REN) of the modem, which can vary. For the REN of your modem, refer to your modem’s label.

The modem connects to the telephone line by means of a standard jack called the USOC RJ11C.

Type of service

Your modem is designed to be used on standard-device telephone lines. Connection to telephone company-provided coin service (central office implemented systems) is prohibited. Connection to party lines service is subject to state tariffs. If you have any questions about your telephone line, such as how many pieces of equipment you can connect to it, the telephone company will provide this information upon request.

Telephone company procedures

The goal of the telephone company is to provide you with the best service it can. In order to do this, it may occasionally be necessary for them to make changes in their equipment, operations, or procedures. If these changes might affect your service or the operation of your equipment, the telephone company will give you notice in writing to allow you to make any changes necessary to maintain uninterrupted service.

If problems arise

If any of your telephone equipment is not operating properly, you should immediately remove it from your telephone line, as it may cause harm to the telephone network. If the telephone company notes a problem, they may temporarily discontinue service. When practical, they will notify you in advance of this disconnection. If advance notice is not feasible, you will be notified as soon as possible. When you are notified, you will be given the opportunity to correct the problem and informed of your right to file a complaint with the FCC. In the event repairs are ever needed on your modem, they should be performed by TOSHIBA Corporation or an authorized representative of TOSHIBA Corporation.

Disconnection

If you should ever decide to permanently disconnect your modem from its present line, please call the telephone company and let them know of this change.

Fax branding

The Telephone Consumer Protection Act of 1991 makes it unlawful for any person to use a computer or other electronic device to send any message via a telephone fax machine unless such message clearly contains in a margin at the top or bottom of each transmitted page or on the first page of the transmission, the date and time it is sent and an identification of the business, other entity or individual sending the message and the telephone number of the sending machine or such business, other entity or individual. In order to program this information into your fax modem, you should complete the setup of your fax software before sending messages.

Instructions for IC CS-03 certified equipment

1. The Industry Canada label identifies certified equipment. This certification means that the equipment meets certain telecommunications network protective, operational and safety requirements as prescribed in the appropriate Terminal Equipment Technical Requirements document(s). The Department does not guarantee the equipment will operate to the user's satisfaction.
Before installing this equipment, users should ensure that it is permissible to be connected to the facilities of the local telecommunications company. The equipment must also be installed using an acceptable method of connection.
The customer should be aware that compliance with the above conditions may not prevent degradation of service in some situations. Repairs to certified equipment should be coordinated by a representative designated by the supplier. Any repairs or alterations made by the user to this equipment, or equipment malfunctions, may give the telecommunications company cause to request the user to disconnect the equipment.
Users should ensure for their own protection that the electrical ground connections of the power utility, telephone lines and internal metallic water pipe systems, if present, are connected together. This precaution may be particularly important in rural areas.



Users should not attempt to make such connections themselves, but should contact the appropriate electric inspection authority, or electrician, as appropriate.

2. The user manual of analog equipment must contain the equipment's Ringer Equivalence Number (REN) and an explanation notice similar to the following:
The Ringer Equivalence Number (REN) of the modem, which can vary. For the REN of your modem, refer to your modem's label.



The Ringer Equivalence Number (REN) assigned to each terminal device provides an indication of the maximum number of terminals allowed to be connected to a telephone interface. The termination on an interface may consist of any combination of devices subject only to the requirement that the sum of the Ringer Equivalence Numbers of all the devices does not exceed 5.

3. The standard connecting arrangement (telephone jack type) for this equipment is jack type(s): USOC RJ11C.
The IC registration number of the modem is shown below.

Canada: 4005B-ATHENS

Notes for Users in Australia and New Zealand

Modem warning notice for Australia

Modems connected to the Australian telecoms network must have a valid Austel permit. This modem has been designed to specifically configure to ensure compliance with Austel standards when the country/region selection is set to Australia. The use of other country/region setting while the modem is attached to the Australian PSTN would result in you modem being operated in a non-compliant manner. To verify that the country/region is correctly set, enter the command AT1 which displays the currently active setting.

To set the country/region permanently to Australia, enter the following command sequence:

```
AT%TE=1
ATS133=1
AT&F
AT&W
AT%TE=0
ATZ
```

Failure to set the modem to the Australia country/region setting as shown above will result in the modem being operated in a non-compliant manner. Consequently, there would be no permit in force for this equipment and the Telecoms Act 1991 prescribes a penalty of \$12,000 for the connection of non-permitted equipment.

Notes for use of this device in New Zealand

- The grant of a Telepermit for a device in no way indicates Telecom acceptance of responsibility for the correct operation of that device under all operating conditions. In particular the higher speeds at which this modem is capable of operating depend on a specific network implementation which is only one of many ways of delivering high quality voice telephony to customers. Failure to operate should not be reported as a fault to Telecom.
- In addition to satisfactory line conditions a modem can only work properly if:
 - a/ it is compatible with the modem at the other end of the call and.
 - b/ the application using the modem is compatible with the application at the other end of the call - e.g., accessing the Internet requires suitable software in addition to a modem.
- This equipment shall not be used in any manner which could constitute a nuisance to other Telecom customers.

- Some parameters required for compliance with Telecom's PTC Specifications are dependent on the equipment (PC) associated with this modem. The associated equipment shall be set to operate within the following limits for compliance with Telecom Specifications:
 - a/ There shall be no more than 10 call attempts to the same number within any 30 minute period for any single manual call initiation, and
 - b/ The equipment shall go on-hook for a period of not less than 30 seconds between the end of one attempt and the beginning of the next.
 - c/ Automatic calls to different numbers shall be not less than 5 seconds apart.
- Immediately disconnect this equipment should it become physically damaged, and arrange for its disposal or repair.
- The correct settings for use with this modem in New Zealand are as follows:
 - ATB0 (CCITT operation)
 - AT&G2 (1800 Hz guard tone)
 - AT&P1 (Decadic dialing make-break ratio =33%/67%)
 - ATS0=0 (not auto answer)
 - ATS6=4 (Blind dial delay)
 - ATS7=less than 90 (Time to wait to carrier after dialing)
 - ATS10=less than 150 (loss of carrier to hangup delay, factory default of 15 recommended)
 - ATS11=90 (DTMF dialing on/off duration=90 ms)
 - ATX2 (Dial tone detect, but not (U.S.A.) call progress detect)
- When used in the Auto Answer mode, the S0 register must be set with a value of 3 or 4. This ensures:
 - a person calling your modem will hear a short burst of ringing before the modem answers. This confirms that the call has been successfully switched through the network.
 - caller identification information (which occurs between the first and second ring cadences) is not destroyed.
- The preferred method of dialing is to use DTMF tones (ATDT...) as this is faster and more reliable than pulse (decadic) dialing. If for some reason you must use decadic dialing, your communications program must be set up to record numbers using the following translation table as this modem does not implement the New Zealand "Reverse Dialing" standard.
 - Number to be dialed: 0 1 2 3 4 5 6 7 8 9
 - Number to program into computer: 0 9 8 7 6 5 4 3 2 1
 - Note that where DTMF dialing is used, the numbers should be entered normally.

- The transmit level from this device is set at a fixed level and because of this there may be circumstances where the performance is less than optimal. Before reporting such occurrences as faults, please check the line with a standard Telepermitted telephone, and only report a fault if the phone performance is impaired.
- It is recommended that this equipment be disconnected from the Telecom line during electrical storms.
- When relocating the equipment, always disconnect the Telecom line connection before the power connection, and reconnect the power first.
- This equipment may not be compatible with Telecom Distinctive Alert cadences and services such as FaxAbility.

NOTE THAT FAULT CALLOUTS CAUSED BY ANY OF THE ABOVE CAUSES MAY INCUR A CHARGE FROM TELECOM

General conditions

As required by PTC 100, please ensure that this office is advised of any changes to the specifications of these products which might affect compliance with the relevant PTC Specifications.

The grant of this Telepermit is specific to the above products with the marketing description as stated on the Telepermit label artwork. The Telepermit may not be assigned to other parties or other products without Telecom approval.

A Telepermit artwork for each device is included from which you may prepare any number of Telepermit labels subject to the general instructions on format, size and color on the attached sheet.

The Telepermit label must be displayed on the product at all times as proof to purchasers and service personnel that the product is able to be legitimately connected to the Telecom network.

The Telepermit label may also be shown on the packaging of the product and in the sales literature, as required in PTC 100.

The charge for a Telepermit assessment is \$337.50. An additional charge of \$337.50 is payable where an assessment is based on reports against non-Telecom New Zealand Specifications. \$112.50 is charged for each variation when submitted at the same time as the original.

An invoice for \$NZ1237.50 will be sent under separate cover.

Following information is only for EU-member states:



The use of the symbol indicates that this product may not be treated as household waste. By ensuring this product is disposed of correctly, you will help prevent potential negative consequences for the environment and human health, which could otherwise be caused by inappropriate waste handling of this product. For more detailed information about recycling of this product, please contact your local city office, your household waste disposal service or the shop where you purchased the product.

Optical disc drive safety instructions



Be sure to check the international precautions at the end of this section.

TEAC

DVD-ROM drive DV-28E



- The DVD-ROM drive DV-28E employs a laser system. To ensure proper use of this product, please read this instruction manual carefully and retain for future reference. Should the unit ever require maintenance, contact an authorized service location.
- Use of controls, adjustments or the performance of procedures other than those specified may result in hazardous radiation exposure.
- To prevent direct exposure to the laser beam, do not try to open the enclosure.

Location of the required label

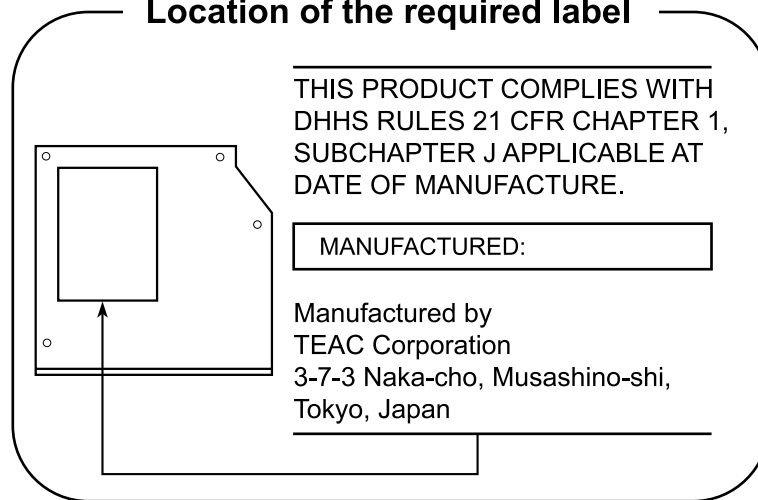

Panasonic Communications

DVD-ROM & CD-R/RW drive UJDA770



- The DVD-ROM & CD-R/RW drive UJDA770 employs a laser system. To ensure proper use of this product, please read this instruction manual carefully and retain for future reference. Should the unit ever require maintenance, contact an authorized service location.
- Use of controls, adjustments or the performance of procedures other than those specified may result in hazardous radiation exposure.
- To prevent direct exposure to the laser beam, do not try to open the enclosure.

Location of the required label

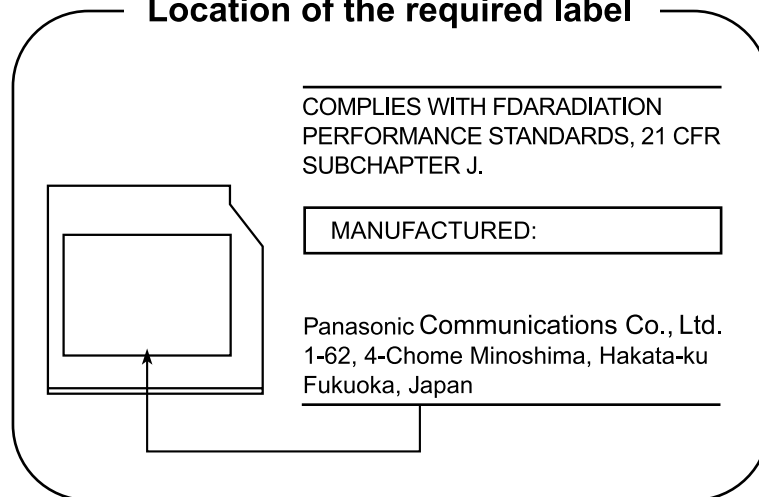

TEAC**DVD-ROM & CD-R/RW drive DW-224E**

- *The DVD-ROM & CD-R/RW drive DW-224E employs a laser system. To ensure proper use of this product, please read this instruction manual carefully and retain for future reference. Should the unit ever require maintenance, contact an authorized service location.*
- *Use of controls, adjustments or the performance of procedures other than those specified may result in hazardous radiation exposure.*
- *To prevent direct exposure to the laser beam, do not try to open the enclosure.*

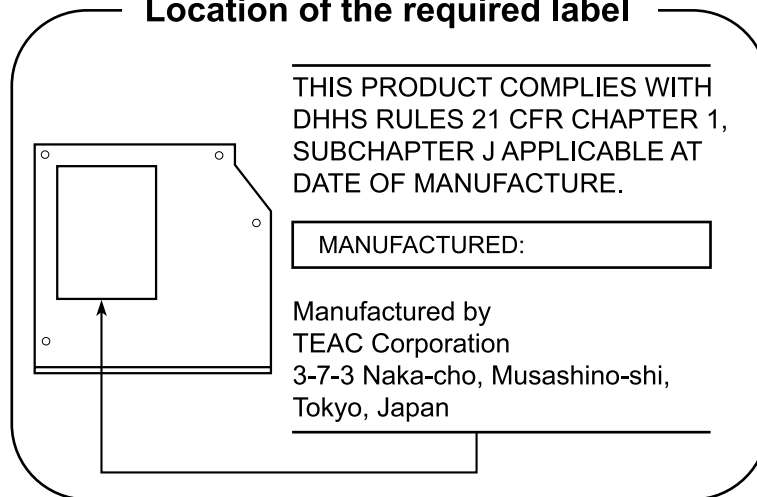
Location of the required label

Panasonic Communications

DVD Super Multi with Double Layer Recording UJ-841



- The DVD Super Multi drive with Double Layer Recording model employs a laser system. To ensure proper use of this product, please read this instruction manual carefully and retain for future reference. Should the unit ever require maintenance, contact an authorized service location.
- Use of controls, adjustments or the performance of procedures other than those specified may result in hazardous radiation exposure.
- To prevent direct exposure to the laser beam, do not try to open the enclosure.

Location of the required label

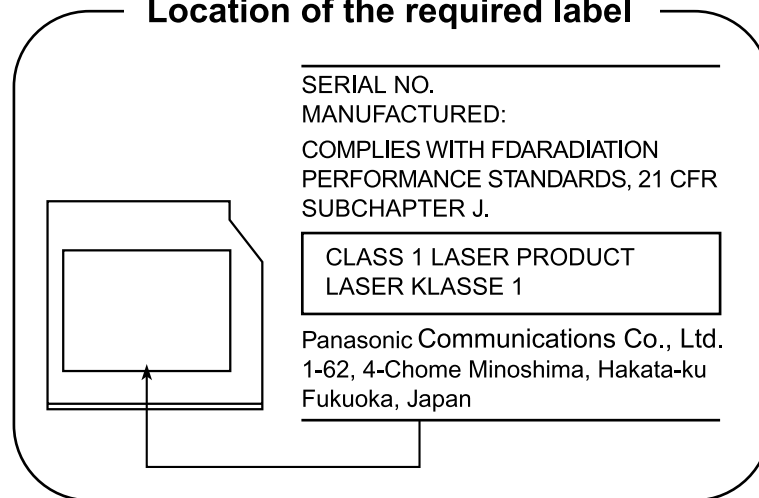

Pioneer

DVD Super Multi with Double Layer Recording DVR-K16



- The DVD Super Multi drive with Double Layer Recording model employs a laser system. To ensure proper use of this product, please read this instruction manual carefully and retain for future reference. Should the unit ever require maintenance, contact an authorized service location.
- Use of controls, adjustments or the performance of procedures other than those specified may result in hazardous radiation exposure.
- To prevent direct exposure to the laser beam, do not try to open the enclosure.

Location of the required label

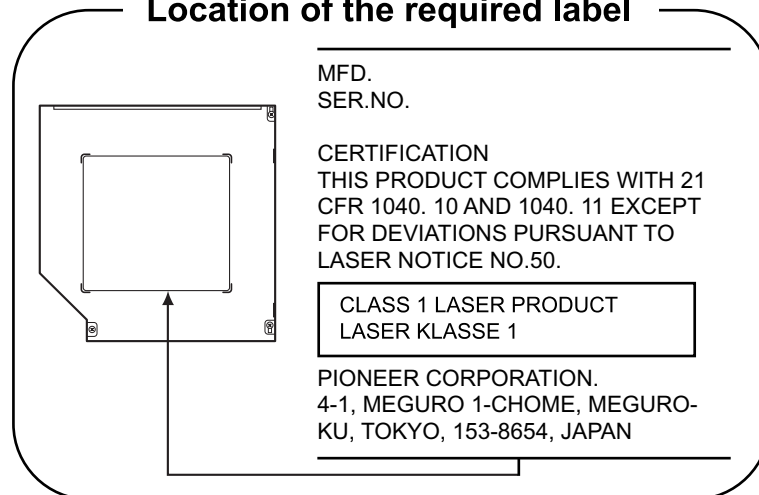

International precautions

CLASS 1 LASER PRODUCT
LASER KLASSE 1 PRODUKT
TO EN 60825-1
クラス1 レーザ 製品

CAUTION: This appliance contains a laser system and is classified as a "CLASS 1 LASER PRODUCT." To use this model properly, read the instruction manual carefully and keep this manual for your future reference. In case of any trouble with this model, please contact your nearest "AUTHORIZED service station." To prevent direct exposure to the laser beam, do not try to open the enclosure.

CLASS 1 LASER PRODUCT
LASERSCHUTZKLASSE 1
PRODUKT
TOEN60825

VORSICHT: Dieses Gerät enthält ein Laser-System und ist als "LASERSCHUTZKLASSE 1 PRODUKT" klassifiziert. Für den richtigen Gebrauch dieses Modells lesen Sie bitte die Bedienungsanleitung sorgfältig durch und bewahren diese bitte als Referenz auf. Falls Probleme mit diesem Modell auftreten, benachrichtigen Sie bitte die nächste "autorisierte Service-Vertretung". Um einen direkten Kontakt mit dem Laserstrahl zu vermeiden darf das Gerät nicht geöffnet werden.

ADVERSEL: USYNLIG
LASERSTRÅLING VED
ÅBNING, NÅR
SIKKERHEDSAF-BRYDER
ER UDE AF FUNKTION.
UNDGÅ UDSÆTTSELSE
FOR STRÅLING

ADVARSEL: Denne mærkning er anbragt udvendigt på apparatet og indikerer, at apparatet arbejder med laserstråler af klasse 1, hvilket betyder, at der anvendes laserstråler af svageste klasse, og at man ikke på apparatets yderside kan bilve udsat for utilladelig kraftig stråling.

APPARATET BOR KUN ÅBNES AF
FAGFOLK MED SÆRLIGT KENDSKAB
TIL APPARATER MED
LASERSTRÅLER!

Indvendigt i apparatet er anbragt den her gengivne advarselsmærkning, som advarer imod at foretage sådanne indgreb i apparatet, at man kan komme til at udsatte sig for laserstråling.

OBS! Apparaten innehåller laserkomponent som avger laserstråining överstigande gränsen för laserklass 1.

VAROITUS. Suojakoteloä si saa avata. Laite sisältää laserdiodin, joka lähettää näkymätöntä silmilie vaarallista lasersäteilyä.

CAUTION: USE OF CONTROLS OR ADJUSTMENTS OR PERFORMANCE OF PROCEDURES OTHER THAN THOSE SPECIFIED IN THE OWNER'S MANUAL MAY RESULT IN HAZARDOUS RADIATION EXPOSURE.

VORSICHT: DIE VERWENDUNG VON ANDEREN STEURUNGEN ODER EINSTELLUNGEN ODER DAS DURCHFÜHREN VON ANDEREN VORGÄNGEN ALS IN DER BEDIENUNGSANLEITUNG BESCHRIEBEN KÖNNEN GEFÄHRLICHE STRAHLENEXPOSITIONEN ZUR FOLGE HABEN.

Preface

Congratulations on your purchase of the TECRA M7 computer. This powerful notebook computer provides excellent expansion capability, including multimedia devices, and it is designed to provide years of reliable, high-performance computing.

This manual tells how to set up and begin using your TECRA M7 computer. It also provides detailed information on configuring your computer, basic operations and care, using optional devices and troubleshooting.

If you are a new user of computers or if you're new to portable computing, first read over the [Getting Started](#) and [Features, Utilities and Options](#) chapters to familiarize yourself with the computer's features, components and accessory devices. Then read [Getting Started](#) for step-by-step instructions on setting up your computer.

If you are an experienced computer user, please continue reading the preface to learn how this manual is organized, then become acquainted with this manual by browsing through its pages. Be sure to look over the [Special features](#) section of the Introduction, to learn about features that are uncommon or unique to the computer and carefully read [HW Setup & BIOS Setup](#).

If you are going to install PC cards or connect external devices such as a monitor, be sure to read Chapter 3, [Features, Utilities and Options](#).

Conventions

This manual uses the following formats to describe, identify, and highlight terms and operating procedures.

Abbreviations

On first appearance, and whenever necessary for clarity, abbreviations are enclosed in parentheses following their definition. For example: Read Only Memory (ROM). Acronyms are also defined in the Glossary.

Icons

Icons identify ports, dials, and other parts of your computer. The indicator panel also uses icons to identify the components it is providing information on.

Keys

The keyboard keys are used in the text to describe many computer operations. A distinctive typeface identifies the key top symbols as they appear on the keyboard. For example, **Enter** identifies the Enter key.

Key operation

Some operations require you to simultaneously use two or more keys. We identify such operations by the key top symbols separated by a plus sign (+). For example, **Ctrl + C** means you must hold down **Ctrl** and at the same time press **C**. If three keys are used, hold down the first two and at the same time press the third.

ABC

When procedures require an action such as clicking an icon or entering text, the icon's name or the text you are to type in is represented in the type face you see to the left.

Display



ABC

Names of windows or icons or text generated by the computer that appear on its display screen are presented in the type face you see to the left.

Messages

Messages are used in this manual to bring important information to your attention. Each type of message is identified as shown below.



Pay attention! A caution informs you that improper use of equipment or failure to follow instructions may cause data loss or damage your equipment.



Please read. A note is a hint or advice that helps you make best use of your equipment.



Indicates a potentially hazardous situation, which could result in death or serious injury, if you do not follow instructions.

General Precautions

TOSHIBA computers are designed to optimize safety, minimize strain and withstand the rigors of portability. However, certain precautions should be observed to further reduce the risk of personal injury or damage to the computer.

Be certain to read the general precautions below and to note the cautions included in the text of the manual.

Creating a computer-friendly environment

Place the computer on a flat surface that is large enough for the computer and any other items you are using, such as a printer.

Leave enough space around the computer and other equipment to provide adequate ventilation. Otherwise, they may overheat.

To keep your computer in prime operating condition, protect your work area from:

- Dust, moisture, and direct sunlight.
- Equipment that generates a strong electromagnetic field, such as stereo speakers (other than speakers that are connected to the computer) or speakerphones.
- Rapid changes in temperature or humidity and sources of temperature change such as air conditioner vents or heaters.
- Extreme heat, cold, or humidity.
- Liquids and corrosive chemicals.

Stress injury

Carefully read the *Instruction Manual for Safety & Comfort*. It contains information on prevention of stress injuries to your hands and wrists that can be caused by extensive keyboard use. Chapter 1, [Getting Started](#), also includes information on work space design, posture and lighting that can help reduce physical stress.

Heat injury

- Avoid prolonged physical contact with the computer. If the computer is used for long periods, its surface can become very warm. While the temperature will not feel hot to the touch, if you maintain physical contact with the computer for a long time (if you rest the computer on your lap, or if you keep your hands on the palm rest, for example) your skin might suffer low-heat injury.
- If the computer has been used for a long time, avoid direct contact with the metal plate supporting the I/O ports. It can become hot.
- The surface of the AC adaptor can become hot when in use. This condition does not indicate a malfunction. If you need to transport the AC adaptor, disconnect it and let it cool before moving it.
- Do not lay the AC adaptor on a material that is sensitive to heat. The material could be damaged.

Pressure or impact damage

Do not apply heavy pressure to the computer or subject it to strong impact. Excessive pressure or impact can cause damage to computer components or otherwise cause malfunctions.

PC card overheating

Some PC cards can become hot with prolonged use. Overheating of a PC card can result in errors or instability in the PC card operation. Also be careful when you remove a PC card that has been used for a long time.

Mobile phones

Use of mobile phones can interfere with the audio system. Computer operation is not impaired but it is recommended that a distance of 30 cm be maintained between the computer and a mobile phone in use.

Instruction Manual for Safety & Comfort

All important information on the safe and proper use of this computer is described in the enclosed Instruction Manual for Safety & Comfort. Be sure to read it before using the computer.

Chapter 1

Getting Started

This chapter provides an equipment checklist, and basic information to start using your computer.



Some of the features described in this manual may not function properly if you use an operating system that was not preinstalled by TOSHIBA.

Equipment checklist

Carefully unpack your computer. Save the box and packing materials for future use.

Hardware

Check to make sure you have all the following items:

- TECRA M7 Portable Personal Computer
- AC adaptor and power cord (2-pin plug or 3-pin plug)
- USB floppy disk drive (Provided with some models)
- Battery pack (It is pre-installed in the computer)
- Slice Expansion Battery (Provided with some models)
- Tablet PC Pen
- Reserve Pen (Provided with some models)



- *The Tablet PC Pen is included in the accessory tray of the product when purchased together with spare pen tips and a tip removal tool.*
- *For some models, a Reserve Pen is also included in the accessory tray of the product when purchased.*

Documentation

- TECRA M7 Portable Personal Computer User's Manual
- Microsoft Windows XP manual package (Is preinstalled in some regions)
- Instruction Manual for Safety & Comfort
- End User License Agreement

If any of the items are missing or damaged, contact your dealer immediately.

Software

Microsoft® Windows XP Tablet PC Edition

- The following software is preinstalled:
 - Microsoft® Windows XP Tablet PC Edition
 - Microsoft Internet Explorer
 - TOSHIBA Utilities
 - TOSHIBA SD Memory Boot Utility
 - DVD Video Player
 - RecordNow! Basic for TOSHIBA
 - DLA for TOSHIBA
 - Recovery Disc Creator
 - TOSHIBA TouchPad On/Off Utility
 - TOSHIBA Power Saver
 - TOSHIBA Mobile Extension
 - TOSHIBA Assist
 - TOSHIBA ConfigFree
 - TOSHIBA Zooming Utility
 - TOSHIBA PC Diagnostic Tool
 - TOSHIBA Controls
 - TOSHIBA Mic Effect
 - TOSHIBA Password Utility
 - TOSHIBA Rotation Utility
 - TOSHIBA Accelerometer Utilities
 - TOSHIBA Tablet Access Code Logon Utility
 - Fingerprint utility
 - Online manual

Getting Started



- All users should be sure to read the section [Starting up for the first time](#).
- Be sure to read the enclosed *Instruction Manual for Safety & Comfort* for information on the safe and proper use of this computer. It is intended to help you be more comfortable and productive while using a notebook computer. By following the recommendations in it you may reduce your chance of developing a painful or disabling injury to your hand, arms, shoulders or neck.

This section provides basic information to start using your computer. It covers the following topics:

- Connecting the AC adaptor
- Opening the display
- Turning on the power
- Starting up for the first time
- Turning off the power
- Restarting the computer
- Creating recovery media
- Restoring the preinstalled software from the HDD



- Use a virus-check program and make sure it is updated regularly.
- Never format storage media without checking its content. Formatting destroys all stored data.
- It is a good idea to periodically back up the internal hard disk or other main storage device to external media. General storage media is not durable or stable over long periods of time and under certain conditions may result in data loss.
- Before you install a device or application, save any data in memory to the hard disk drive or other storage media. Failure to do so may result in the loss of data.

Operating the computer in Tablet mode



Change to "The TOSHIBA TECRA M7" computer can be used in two ways, as an ordinary laptop PC and as a Tablet PC. You can use the computer as Tablet PC, operated with the supplied Tablet PC Pen, by turning the LCD display panel through 180 degrees and closing it. This manual calls the use as an ordinary laptop PC "laptop mode", and the use as a Tablet PC "Tablet mode". Refer to [Changing to the Tablet mode](#) section in Chapter 4, *Operating Basics* for details on changing the mode.

When operating the computer in tablet mode, follow the instructions below.

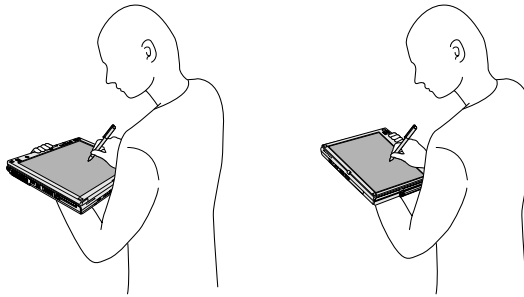

Figure 1-1 Operating the computer in tablet mode

- Hold the computer firmly on your forearm. Do not block the vent.
- Remove the AC adaptor from the computer when using it in tablet mode held in your forearm.
- Do not use the computer while walking or driving a car.
- Change to laptop mode and turn off the computer before carrying it. Do not carry the computer with power on or in stand by state. Do not carry the computer while the disk activity LED is glowing.
- Do not expose the computer to rapid temperature changes (such as would be the case if you brought the PC from a cold environment into a warm room). When rapid temperature changes are unavoidable, leave the computer for around two hours before turning it on to prevent the formation of condensation.
- Remove all external peripheral devices and their connection cables from the computer before carrying.
- Do not drop the computer or apply excessive impact to it. Do not leave the computer in a car or similar environment where it is exposed to direct sunlight.
- Do not put the computer in a bag when it is in tablet mode.

- The display panel works as a touch sensitive digitizer screen. However, the outer edges of the screen may be less sensitive. Please keep the Tablet PC Pen inside the display area when you use it near the edges of the display panel. The position of the pen may not be recognized if you move the Tablet PC Pen too fast towards the outer edge. Please be sure to slide the Tablet PC Pen slowly in areas near the edges of the screen.

Use the Tablet PC Pen in the areas enclosed by the dotted line as shown in the following figure.

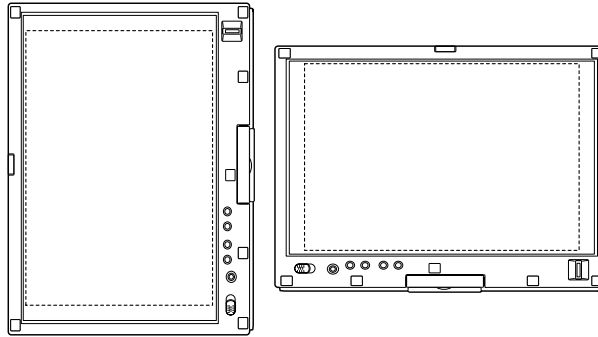

Figure 1-2 Use area of a Tablet PC Pen



Do not block the vent of the computer when holding it. If you continue to expose your skin to the hot air expelled from the vent for a long time, your skin might suffer low temperature injury.

Connecting the AC adaptor

Attach the AC adaptor when you need to charge the battery or you want to operate from AC power. It is also the fastest way to get started, because the battery pack will need to be charged before you can operate from battery power.

The AC adaptor can be connected to any power source supplying from 100 to 240 volts and 50 or 60 hertz. For details on using the AC adaptor to charge the battery pack, refer to Chapter 6, [Power and Power-Up Modes](#).



- *Always use the TOSHIBA AC adaptor that was provided with your PC and the TOSHIBA Battery Charger (that may have been provided with your PC), or use AC adaptors and battery chargers specified by TOSHIBA to avoid any risk of fire or other damage to the PC. Use of an incompatible AC adaptor or Battery Charger could cause fire or damage to the PC possibly resulting in serious injury. TOSHIBA assumes no liability for any damage caused by use of an incompatible adaptor or Battery Charger.*
- *Never plug the AC adaptor or Battery Charger into a power source that does not correspond to both the voltage and the frequency specified on the regulatory label of the unit. Failure to do so could result in a fire or electric shock, possibly resulting in serious injury.*
- *Always use or purchase power cables that comply with the legal voltage and frequency specifications and requirements in the country of use. Failure to do so could result in a fire or electric shock, possibly resulting in serious injury.*
- *The supplied power cord conforms to safety rules and regulations in the region the product is bought and should not be used outside this region. For use in other regions, please buy power cords that conform to safety rules and regulations in the particular region.*
- *Do not use a 3-pin to 2-pin conversion plug.*
- *When you connect the AC adaptor to the computer, always follow the steps in the exact order as described in the User's Manual. Connecting the power cable to a live electrical outlet should be the last step otherwise the adaptor DC output plug could hold an electrical charge and cause an electrical shock or minor bodily injury when touched. As a general safety precaution, avoid touching any metal parts.*
- *Never place your PC or AC adaptor on a wooden surface, furniture, or any other surface that could be marred by exposure to heat since the PC base and AC adaptor's surface increase in temperature during normal use.*
- *Always place your PC or AC adaptor on a flat and hard surface that is resistant to heat damage.*

Refer to the enclosed Instruction Manual for Safety & Comfort for detailed precautions and handling instructions.

1. Connect the power cord to the AC adaptor.

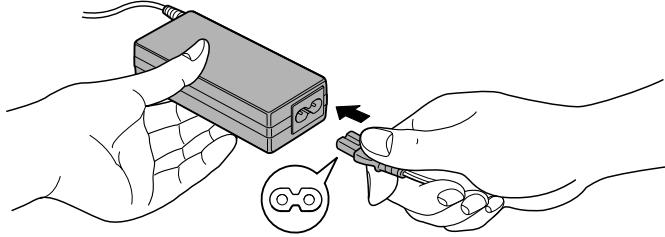

Figure 1-3 Connecting the power cord to the AC adaptor (2-pin plug)

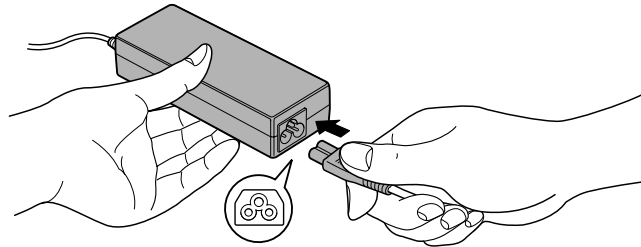

Figure 1-4 Connecting the power cord to the AC adaptor (3-pin plug)



Depending on the model, a 2-pin plug or 3-pin plug set of the above may be bundled.

2. Connect the AC adaptor's DC output plug to the DC IN 15V jack on the back of the computer.

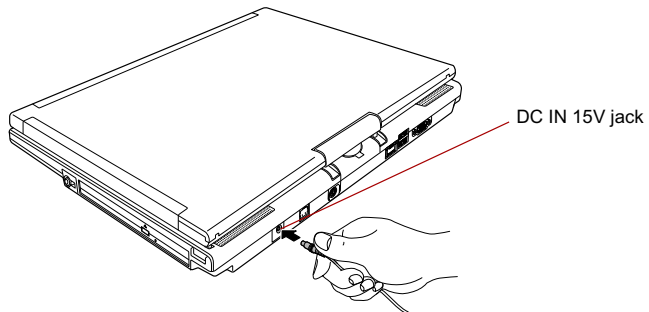

Figure 1-5 Connecting the adaptor to the computer

3. Plug the power cord into a live wall outlet. The **Battery** and **DC IN** indicators on the front of the computer should glow.

Opening the display

The computer's LCD display panel can be opened in a wide range of angles for optimal viewing.

1. Push the display latch on the front of the computer to unlatch the display panel.
2. While holding down the palm rest with one hand so that the main body is not raised, lift the panel slowly. Adjust the angle of the panel to provide optimal clarity.



Use reasonable care when opening and closing the LCD display panel. Opening it vigorously or slamming it shut could damage the computer.

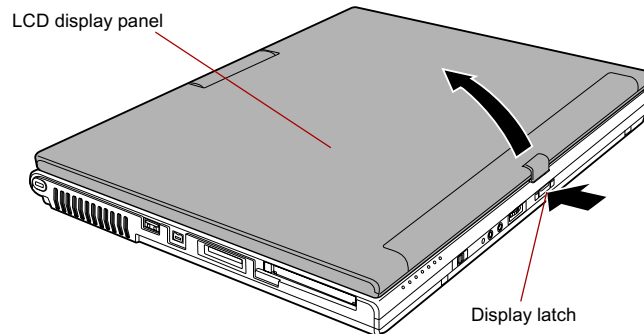

Figure 1-6 Opening the LCD display panel

Turning on the power

This section describes how to turn on the power.

The Power button LED indicates the status. Refer to the [Power indicators](#) section in Chapter 6, Power and Power-Up Modes.



- *After you turn on the power for the first time, do not turn it off until you have set up the operating system. Refer to the section [Starting up for the first time](#).*
- *If the USB floppy disk drive is connected, make sure it is empty. If a floppy disk is in the drive, press the eject button and remove the floppy disk.*

1. Open the computer's LCD display panel.

- Slide and hold the computer's power button.

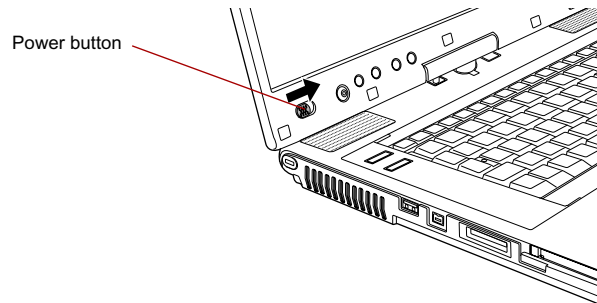

Figure 1-7 Turning on the power

Starting up for the first time

When you first turn on the power, the computer's initial screen is the Microsoft Windows XP Startup Screen Logo. Follow the on-screen directions for each screen. During setup, you can click the **Back** button to return to the previous screen.



Be sure to read the Windows End User License Agreement display carefully.

Turning off the power

The power can be turned off in one of the following modes: Shut down (Boot), Hibernation or Standby Mode.

Shut Down mode (Boot mode)

When you turn off the power in Shut Down mode no data is saved and the computer will boot to the operating system's main screen.

- If you have entered data, save it to the hard disk or to a storage media.
- Make sure all disk (disc) activity has stopped, then remove the CD/DVDs or floppy disk.



- *Make sure the hard disk drive indicator is off. If you turn off the power while a disk (disc) is being accessed, you can lose data or damage the disk.*
- *Never turn off the power while an application is running. Doing so could cause loss of data.*
- *Never turn off the power, disconnect an external storage device or remove storage media during data read/write. Doing so can cause data loss.*

- Click **start** then click **Turn Off Computer**. From the **Turn Off Computer** menu select **Turn Off**.

4. Turn off the power to any peripheral devices.



Do not turn the computer or devices back on immediately. Wait a moment to let all capacitors fully discharge.

Standby Mode

If you have to interrupt your work, you can turn off the power without exiting from your software. Data is maintained in the computer's main memory. When you turn on the power again, you can continue working right where you left off.



- *When the AC adaptor is connected, the computer will go into Standby Mode according to the settings in the TOSHIBA Power Saver.*
- *To restore operation from Standby Mode, slide the power button or press any key. The latter action only works on the internal keyboard if the Wake-up on Keyboard option is enabled in HW Setup.*
- *If the computer automatically enters Standby Mode while a network application is active, the application might not be restored when the computer wakes up from Standby.*
- *To prevent the computer from automatically entering Standby Mode, disable Standby in TOSHIBA Power Saver. That action, however, will nullify the computer's Energy Star compliance.*



- *Before entering Standby Mode, be sure to save your data.*
- *Do not install or remove a memory module while the computer is in Standby Mode. The computer or the module could be damaged.*
- *Do not remove the battery pack while the computer is in Standby Mode (unless the computer is connected to an AC power source). Data in memory will be lost.*
- *If you carry the computer on board an aircraft or into a hospital, be sure to shut down the computer in Hibernation Mode or in shutdown mode to avoid radio signal interference.*

Benefits of standby

The standby feature provides the following benefits:

- Restores the previous working environment more rapidly than does hibernation.
- Saves power by shutting down the system when the computer receives no input or hardware access for the duration set by the System Standby feature.
- You can use the panel power off feature.

Executing standby



You can also enable Standby by pressing **Fn + F3**. Refer to Chapter 5, [The Keyboard](#), for details.

You can enter Standby Mode in one of three ways:

1. Click **start**, click **Turn Off Computer** and click **Stand By**.
2. Close the computer's LCD display panel. This feature must be enabled. Refer to the Setup Actions tab in TOSHIBA Power Saver located within the Control application (open **Performance and Maintenance** and then open **TOSHIBA Power Saver**).
3. Slide the power button. This feature must be enabled. Refer to the Setup Actions tab in TOSHIBA Power Saver described in the Control application. Open **Performance and Maintenance** and open **TOSHIBA Power Saver**.

When you turn the power back on, you can continue where you left when you shut down the computer.



- *When the computer is shut down in Standby Mode, the power indicator will blink orange.*
- *If you are operating the computer on battery power, you can lengthen the operating time by shutting down in Hibernation Mode. Standby Mode consumes more power.*

Standby limitations

Standby will not function under the following conditions:

- Power is turned back on immediately after shutting down.
- Memory circuits are exposed to static electricity or electrical noise.

Hibernation Mode

The Hibernation Mode feature saves the contents of memory to the hard disk when the computer is turned off. The next time the computer is turned on, the previous state is restored. The Hibernation Mode feature does not save the status of any peripheral devices.



- *Save your data. While entering Hibernation Mode, the computer saves the contents of memory to the hard disk drive. However, for safety sake, it is best to save your data manually.*
- *Data will be lost if you remove the battery or disconnect the AC adaptor before the save is completed. Wait for the **HDD** indicator to go out.*
- *Do not install or remove a memory module while the computer is in Hibernation Mode. Data will be lost.*

Benefits of Hibernation Mode

The Hibernation Mode feature provides the following benefits:

- Saves data to the hard disk when the computer automatically shuts down because of a low battery.



For the computer to shut down in Hibernation Mode, this feature must be enabled in two places: the Hibernate tab in Power Options and Setup Actions tab in TOSHIBA Power Saver.

If you do not configure this feature, the computer will shut down in Standby Mode - if battery power becomes depleted, data saved in Standby Mode will be lost.

- You can return to your previous working environment immediately when you turn on the computer.
- Saves power by shutting down the system when the computer receives no input or hardware access for the duration set by the System hibernate feature.
- You can use the panel power off feature.

Starting Hibernation Mode



*You can also enable Hibernation Mode by pressing **Fn + F4**. Refer to Chapter 5, [The Keyboard](#), for details.*

To enter Hibernation Mode, follow the steps below.

1. Click **start**.
2. Select **Turn Off Computer**.
3. Open the **Turn Off Computer** dialog box.
4. Click **Hibernate**.

Automatic Hibernation

The computer will enter Hibernate mode automatically when you slide the power button or close the lid. First, however, make the appropriate settings according to the steps below.

1. Click **start** and open the **Control Panel**.
2. Open **Performance and Maintenance** and open **Power Options**.
3. Select the **Hibernate** tab in the **Power Options Properties**, select the **Enable hibernation** check box and click the **Apply** button.
4. Open **TOSHIBA Power Saver**.
5. Select the **Setup Actions** tab.
6. Enable the desired Hibernation settings for **When I press the power button** and **When I close the lid**.
7. Click the **OK** button.

Data save in Hibernation Mode

When you turn off the power in Hibernation Mode, the computer takes a moment to save current memory data to the hard disk. During this time, the **HDD** indicator will light.

After you turn off the computer, and the content of memory has been saved to the hard disk, turn off the power to any peripheral devices.



Do not turn the computer or devices back on immediately. Wait a moment to let all capacitors fully discharge.

Restarting the computer

Certain conditions require that you reset the system. For example, if:

- You change certain computer settings.
- An error occurs and the computer does not respond to your keyboard commands.
- There are three ways to reset the computer system:
 1. Click **start** then click **Turn off computer**. From the **Turn off computer** menu select **Restart**.
 2. Press **Ctrl + Alt + Del** to display the **Windows Task Manager**, then select **Shut Down** and **Restart**.
 3. Slide the power button and hold it down for five seconds. Wait 10 to 15 seconds, then turn the power on again by sliding the power button.

Create Optical Recovery Discs

A recovery image of your computer is stored on the hard disk. You may use this image to create CD or DVD recovery discs using the following steps:

1. Select either blank CDs or DVD media.
2. The application will allow you to choose a type of media to create recovery CDs/DVD including: CD-R, CD-RW, DVD-R, DVD-RW, DVD+R and DVD+RW.



Some media may not be compatible with the optical disc drive of your computer. Please verify your optical disc drive supports the blank media you choose.

3. Turn on your computer without a PC card storage device such as HDD to open Windows XP.
4. Insert the (first) blank media into the tray of the optical disc drive.
5. Double click the Recovery Disc Creator Launcher icon on the Windows XP desktop, or Select the application from **start** Menu.
6. After Recovery Disc Creator starts, select the type of media and the title you wish to copy to the media then click the **Burn** button.



If your optical disc drive can only write to CDs, select "CD" as the "Type" on Recovery Disc Creator. If your optical disc drive of your computer can write to either CD or DVDs, select the one you are using as the "Type" on Recovery Disc Creator.

Restoring the preinstalled software from the Recovery HDD

About 2.5GB of hard disk space is reserved for recovery partition.

When re-setting up your hard disk, do not change, delete or add partitions in a manner other than specified in the manual. Otherwise, space for software may be destroyed.

In addition, if you use a third-party partitioning program to reconfigure partitions on your hard disk, it may become impossible to re-setup your computer.



When sound mute is turned ON by the **Fn + Esc** key, turn OFF before starting restore. Refer to Chapter 5, [The Keyboard](#), for details.

1. Turn off your computer.
2. While holding down **0** (zero) key on the keyboard, turn on your computer.
3. A menu appears. Follow the on-screen instructions.

Restoring the preinstalled software from your creating Recovery Media

If preinstalled files are damaged, you can either use the Recovery Media you have created or the hard disk drive recovery to restore them. To restore the operating system and all preinstalled software, follow the steps below.



When sound is muted by the **Fn + Esc** key, turn it on before starting the restore procedure. Refer to Chapter 5, [The Keyboard](#), for details.



When you reinstall the Windows operating system, the hard disk will be reformatted and all data will be lost.

1. Load the Recovery Media in the optional optical disc drive and turn off the computer's power.
2. Hold down the **F12** key and turn on the power. When **In Touch with Tomorrow TOSHIBA** appears, release the **F12** key.
3. Use the left or right cursor key to select the CD-ROM icon in the display menu. For details, refer to the [Boot Priority](#) section in Chapter 7, [HW Setup & BIOS Setup](#).
4. A menu appears. Follow the on-screen instructions.

Chapter 2

The Grand Tour

This chapter identifies the various components of your computer. Become familiar with each component before you operate the computer.

Legal Footnote (Non-applicable Icons)*1

For more information on the Legal Footnote regarding Non-applicable Icons, please refer to the Legal Footnotes section in Appendix J. Click the *1.

Front with the display closed

The following figure the computer's front with its LCD display panel in the closed position.

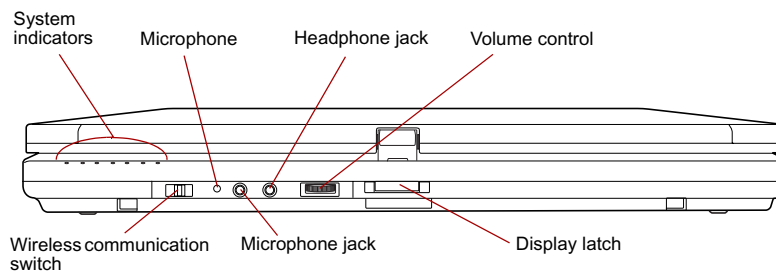





Figure 2-1 Front of the computer with LCD display panel closed

	System indicators	These LEDs let you monitor the status of various computer functions. Refer to the System indicators section for details.
Off On	Wireless communication switch	Slide this switch to the left to turn off Wireless LAN and Bluetooth functions. Slide it to the right to turn on the functions. All models are provided with a Wireless Communication switch although only some models are equipped with both Wireless LAN and Bluetooth functions.
	<ul style="list-style-type: none"> ■ Turn Wi-Fi® and Bluetooth functionalities off when near a person who may have a cardiac pacemaker implant or other medical electric device. Radio waves may affect pacemaker or medical device operation, possibly resulting in serious injury. Follow the instruction of your medical device when using any Wi-Fi or Bluetooth functionality. ■ Always turn off Wi-Fi or Bluetooth functionality if the PC is near automatic control equipment or appliances such as automatic doors or fire detectors. Radio waves can cause malfunction of such equipment, possibly resulting in serious injury. ■ Do not use the Wi-Fi or Bluetooth functionalities near a microwave oven or in areas subject to radio interference or magnetic fields. Interference from a microwave oven or other source can disrupt Wi-Fi or Bluetooth operation. 	
	Microphones	The built-in microphones let you record sound into your applications. Refer to the Sound System section in Chapter 4, Operating Basics.
	Microphone jack	A 3.5 mm mini microphone jack enables connection of a three-conductor mini jack for monaural microphone input.
	Headphone jack	A 3.5 mm mini headphone jack enables connection of stereo headphones.



Volume control

Use this dial to adjust the volume of the stereo speakers and the stereo headphones.
 Move the Volume control to the right to increase the volume and to the left to decrease the volume.
 Press the Volume control to Mute the sound. Press the Volume control again to turn Mute off. The mute icon will be displayed when the Volume control is pressed. The same function can be performed by pressing the **Fn + Esc** keys. Refer to the *Hot keys* section in Chapter 5 for details on the **Fn + Esc** keys.

Display latch

This latch secures the LCD panel in its closed position. Push the latch to open the display.

Left side

The following figure shows the computer's left side.

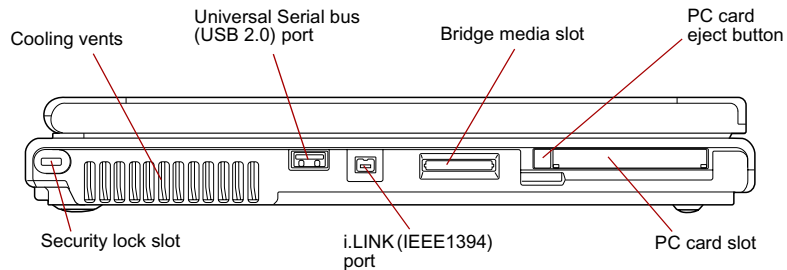

Figure 2-2 The left side of the computer



Security lock slot

A security cable attaches to this slot. The optional security cable anchors your computer to a desk or other large object to deter theft.

Cooling vents

Cooling vents help CPU keep from overheating.



Do not block the cooling vents. Keep foreign metal objects, such as screws, staples and paper clips, out of the cooling vents. Foreign metal objects can create a short circuit, which can cause damage and fire, possibly resulting in serious injury.



Universal Serial Bus (USB 2.0) port

The Universal Serial Bus port is on the left side. The port comply with the USB 2.0 standard.



Keep foreign metal objects, such as screws, staples and paper clips, out of the USB connectors. Foreign metal objects can create a short circuit, which can cause damage and fire, possibly resulting in serious injury.



Operation of all functions of all USB devices has not been confirmed. Some functions might not execute properly.



i.LINK (IEEE1394) port

This port allows you to connect an external device, such as a digital video camera for high-speed data transfer.



Bridge media slot

This slot lets you insert an SD card, Memory Stick (Pro), xD picture card, MultiMediaCard or SDIO card device. Refer to Chapter 3, [Features, Utilities and Options](#).



Keep foreign metal objects, such as screws, staples and paper clips, out of the Bridge Media Slot. Foreign metal objects can create a short circuit, which can cause damage and fire, possibly resulting in serious injury.



PC card slot

The PC card slot can accommodate a Type II card. The slot supports 16-bit PC cards and CardBus PC cards.

PC card eject button

This button is used to remove a PC card from the PC card slot.



Keep foreign metal objects, such as screws, staples and paper clips, out of the PC Card slot. Foreign metal objects can create a short circuit, which can cause damage and fire, possibly resulting in serious injury.

Right side

The following figure shows the computer's right side.

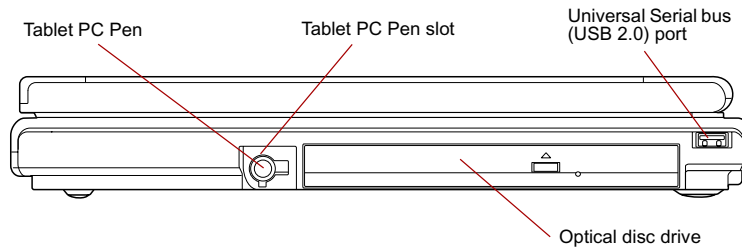



Figure 2-3 The right side of the computer

Tablet PC Pen slot	The Tablet PC Pen slot provides storage for the Tablet PC Pen.
Tablet PC Pen	The Tablet PC Pen is stored within the right side of the computer and enables direct data entry through the display screen. Refer to the Using the Tablet PC Pen and Reserve Pen section in Chapter 4, Operating Basics.
Optical disc drive	The computer is configured with a DVD-ROM drive, a DVD-ROM&CD-R/RW drive or a DVD Super Multi drive.
 Universal Serial Bus (USB 2.0) port	The Universal Serial Bus port is on the right side. Refer to Left side section, for details.

Back side

The following figure shows the computer's back side.

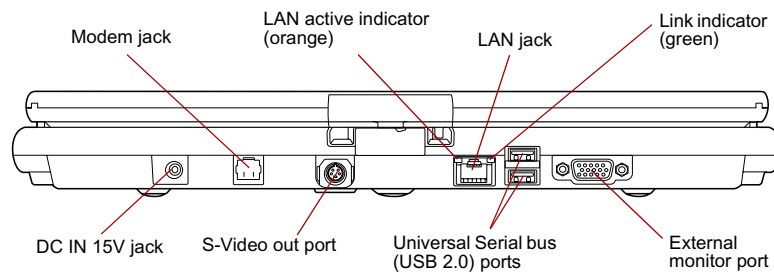
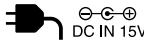



Figure 2-4 The back side of the computer

 DC IN 15V jack	The AC adaptor connects to this jack. Use only the model of AC adaptor that comes with the computer. Using the wrong adaptor can damage your computer.
 Modem jack	The modem jack lets you use a modular cable to connect the modem directly to a telephone line.



- Connection to any communication line other than an analog phone line could cause a PC system failure.
 - Connect the built-in modem only to ordinary analog phone lines.
 - Never connect the built-in modem to a digital line (ISDN).
 - Never connect the built-in modem to the digital connector on a public telephone or to a digital private branch exchange (PBX).
 - Never connect the built-in modem to a key telephone system for residences or offices.
- Never operate your PC on AC power during a thunderstorm. If you see lightning or hear thunder, immediately turn off the PC. An electric surge caused by the storm, may result in a system failure, loss of data or hardware damage.



S-Video out port

Plug an S-Video cable into this jack for S-Video. The S-Video cable carries video signal. Data output depends on the type of device connected to the S-Video cable.



LAN jack

This jack lets you connect to a LAN. The adaptor has built-in support for Ethernet LAN (10 megabits per second, 10BASE-T), Fast Ethernet LAN (100 megabits per second, 100BASE-TX) and Gigabit Ethernet LAN (1000 megabits per second, 1000BASE-T). The LAN has two indicators. Refer to Chapter 4, *Operating Basics*, for details.



- Do not connect any cable other than a LAN cable to the LAN jack. It could cause damage or malfunction.
- Do not connect the LAN cable to a power supply. It could cause damage or malfunction.

Link indicator (green)

This indicator glows green when the computer is connected to a LAN and the LAN is functioning properly.

LAN active indicator (orange)

This indicator glows orange when data is being exchanged between the computer and the LAN.



Universal Serial Bus (USB 2.0) ports

Two Universal Serial Bus ports are on the back side. Refer to *Left side* section, for details.



External monitor port

This external monitor port lets you connect an external video display. Analog VGA port supports VESA DDC2B compatible functions.

Underside

The following figure shows the underside of the computer. Make sure the display is closed before turning over your computer.

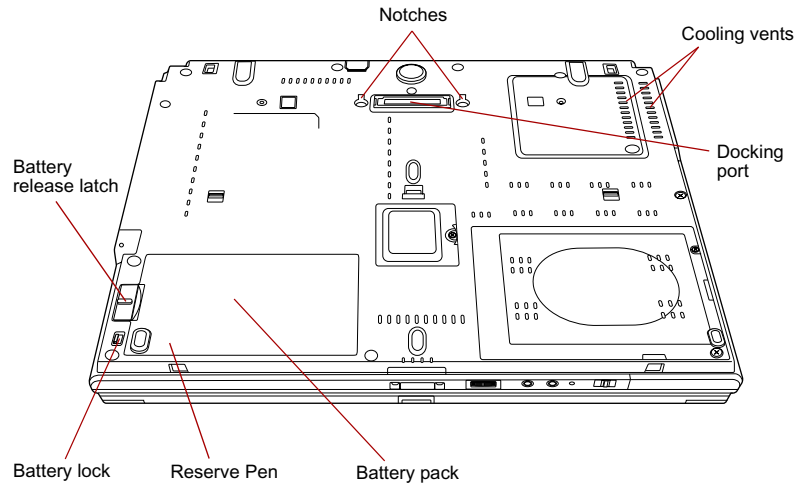

Figure 2-5 The underside of the computer

Notches Notches on the computer engage hooks on the TOSHIBA Express Port Replicator to ensure a secure connection.



Docking port This port enables connection of an optional TOSHIBA Express Port Replicator and a Slice Expansion Battery described in Chapter 3, [Features, Utilities and Options](#).



Keep foreign objects out of the docking port. A pin or similar object can damage the computer's circuitry. A plastic shutter protects the connector.

Battery pack The battery pack powers the computer when the AC adaptor is not connected. For detailed information on the battery pack, refer to Chapter 6, [Power and Power-Up Modes](#).



Battery lock Slide the battery lock to release the battery pack for removal.

Cooling vents The cooling vents is on the underside. Refer to [Left side](#) section, for details.



Battery release latch

Slide and hold this latch to release the battery pack for removal.
For detailed information on removing the battery pack, refer to Chapter 6, *Power and Power-Up Modes*.

Reserve Pen

The Reserve Pen is contained in the recess on the underside of the battery pack and enables data entry directly through display screen in addition to the main Tablet PC Pen. Refer to the *Using the Tablet PC Pen and Reserve Pen* section in Chapter 4, Operating Basics.

Front with the display open

This section shows the computer with the LCD display panel open. Refer to the appropriate illustration for details. To open the display, push the display latch on the front of the LCD display panel and lift up. Position the LCD display panel at a comfortable viewing angle.

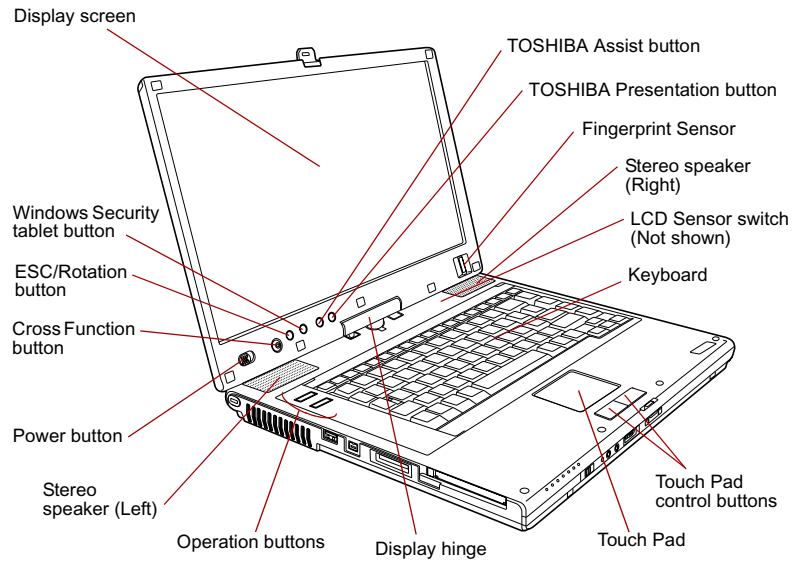







Figure 2-6 The front of the computer with the LCD panel open

Display hinge	The display hinge holds the LCD display panel at easy-to-view angles.	
Display screen	<p>The LCD screen displays high-contrast text and graphics. Refer to Display Controller and Modes section in Appendix B.</p> <p>When the computer operates on the AC adaptor the LCD screen's image will be somewhat brighter than when it operates on battery power. The lower brightness level is intended to save battery power.</p>	
Stereo speakers	The speakers emit sound generated by your software as well as audio alarms, such as low battery condition, generated by the system.	
Touch Pad	A Touch Pad located in the center of the palm rest is used to control the on-screen pointer and scrolling of windows. Refer to the Using the Touch Pad section in Chapter 4, Operating Basics.	
Touch Pad control buttons	Control buttons below the Touch Pad let you select menu items or manipulate text and graphics designated by the on-screen pointer.	
Keyboard	84 keys or 85 keys, compatible with IBM® enhanced keyboard, embedded numeric overlay, dedicated cursor control,  and  keys. Refer to Chapter 5, The Keyboard , for details.	
	Power button	Slide the power button to turn the computer's power on and off.
	Cross Function button	This button functions the same as the Enter key when tapped, or shows the menu screen when pressed for more than a second.
	ESC/Rotation button	This button functions the same as the ESC key when tapped, or changes the orientation of the screen when pressed for more than a second.
	Windows Security tablet button	This button functions the same as the Ctrl + Alt + Del keys to show Windows Task Manager.

TOSHIBA Assist button

Press this button to launch the TOSHIBA Assist utility (default) or some other predefined application.

When the computer is switched off, or is in standby or hibernation mode, press this button to start the computer and launch the assigned application.

You can specify the function of the TOSHIBA Assist button in the TOSHIBA Controls properties.

TOSHIBA Presentation button

Press this button to display the same image on both internal and external monitors, or to use multi-monitor display (Windows XP Only).

The default setting is "Presentation (Same Image 1024 × 768)" - this means the same image will be displayed on both internal and external monitors with a resolution of 1024 × 768 pixels.

When using the "Presentation (Different Image)" setting, you can use the internal and external monitors in wide screen mode (Windows XP only).

Pressing this button again changes to single display mode on the internal monitor only.

You can specify the function of the TOSHIBA Presentation button in the TOSHIBA Controls properties.

Fingerprint Sensor

This sensor enables you to enroll and recognize a fingerprint.

For detailed information on Fingerprint Sensor, refer to Chapter4, [Using the Fingerprint Sensor](#).

LCD Sensor switch

This switch senses when the computer's LCD display panel is closed or opened and activates the Panel Power Off/On feature. When you close the LCD display panel the computer enters Hibernation Mode and shuts down. When you open the computer's LCD display panel the computer starts in Hibernation Mode. Use the TOSHIBA Power Saver to enable or disable this feature. The default is "enabled".

Refer to the TOSHIBA Power Saver and Panel Power Off/On items in Chapter 3, [Special features](#), for details on settings.



Do not put a magnetic object close to the switch. The computer will automatically enter Hibernation Mode and shut down even if the Panel Power Off feature is disabled.

Operation buttons

This section describes the operation buttons.



Please do not press the buttons too strenuously.



1

Application 1

This button allows you to run applications and access utilities. An application and a function to assign can be configured individually.

When the computer is switched off, or is in standby or hibernation mode, press this button to start the computer and launch the assigned application.

This button settings can be changed only by administrator.



2

Application 2

This button allows you to run applications and access utilities. An application and a function to assign can be configured individually.

When the computer is switched off, or is in standby or hibernation mode, press this button to start the computer and launch the assigned application.

This button settings can be changed only by administrator.

System indicators

LEDs above icons, light when various computer operations are in progress.

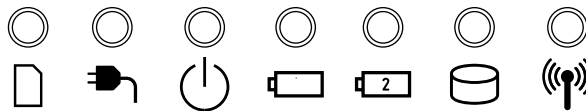

Figure 2-7 System indicators



Bridge Media

The **Bridge Media** indicator glows green when the computer is accessing the Bridge media slot.



DC IN

The **DC IN** indicator glows green when DC power is supplied from the AC power adaptor. If the adaptor's output voltage is abnormal or if the power supply malfunctions, this indicator flashes orange.

	Power	The Power indicator glows green when the computer is on. If you select stand by from the Turn off computer window, this indicator flashing (one second on, two seconds off) while the computer Standby mode.
	Battery	The Battery indicator shows the condition of the battery's charge: Green indicates full charge, orange indicates battery charging and flashing orange indicates a low battery charge. Refer to Chapter 6, Power and Power-Up Modes .
	2nd battery	The 2nd battery indicator shows the condition of the charge of a Slice Expansion Battery. Green means fully charged and orange means being charged. Refer to Chapter 6, Power and Power-Up Modes .
	HDD	The HDD indicator glows green when the computer is accessing the built-in Hard Disk Drive.
	Wireless communication	The Wireless communication indicator glows when the Bluetooth and wireless LAN functions are turned on. All models are provided with a Wireless Communication switch although only some models are equipped with both Wireless LAN and Bluetooth functions.

Keyboard indicators

The figures below show the positions of the keypad overlay indicators and the Caps Lock indicator.

When the Arrow mode indicator glows the keypad overlay lets you control the cursor.

When the Numeric mode indicator glows the keypad overlay lets you enter numbers.

When the Caps Lock indicator glows the keyboard is in all-caps mode.

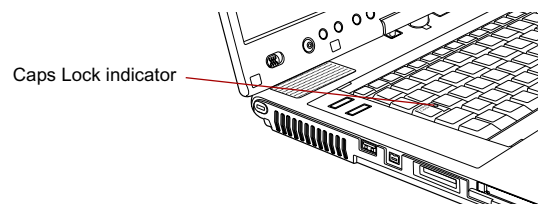

Figure 2-8 Caps Lock indicator

Caps Lock	This indicator glows green when the alphabet keys are locked in uppercase.
------------------	--

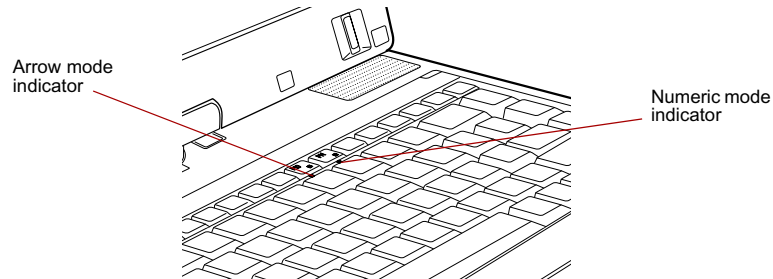

Figure 2-9 Keypad overlay indicators

**Arrow mode**

When the **Arrow mode** indicator lights green, you can use the keypad overlay (gray labeled keys) as cursor keys. Refer to the [Keypad overlay](#) section in Chapter 5, The Keyboard.

**Numeric mode**

You can use the keypad overlay (gray labeled keys) for numeric input when the **Numeric mode** indicator lights green. Refer to the [Keypad overlay](#) section in Chapter 5, The Keyboard.

Optical disc drives

The computer is installed with either a DVD-ROM, DVD-ROM&CD-R/RW or a DVD Super Multi drive. An ATAPI interface controller is used for CD/DVD-ROM operation. When the computer is accessing a CD/DVD, an indicator on the drive glows.

For information on loading and unloading discs refer to the [Using optical disc drives](#) section in Chapter 4, Operating Basics.

Region codes for DVD drives and media

DVD-ROM, DVD-ROM&CD-R/RW, DVD Super Multi drives and their associated media are manufactured according to the specifications of six marketing regions. When you purchase DVD-Video, make sure it matches your drive, otherwise it will not play properly.

Code	Region
1	Canada, United States
2	Japan, Europe, South Africa, Middle East
3	Southeast Asia, East Asia
4	Australia, New Zealand, Pacific Islands, Central America, South America, Caribbean

5	Russia, Indian Subcontinent, Africa, North Korea, Mongolia
6	China

Writable discs

This section describes the types of writable CD/DVD discs. Check the specifications of your drive to see the types of discs it can write. Use RecordNow! to write compact discs. Refer to Chapter 3, *Features, Utilities and Options*.

CDs

- CD-R discs can be written only once. The recorded data cannot be erased or changed.
- CD-RW discs including multi speed CD-RW discs, high-speed CD-RW discs and ultra-speed CD-RW discs can be recorded more than once.

DVDs

- DVD-R and DVD+R discs can be written only once. The recorded data cannot be erased or changed.
- DVD-RW, DVD+RW and DVD-RAM discs can be recorded more than once.

Formats

The drives support the following formats.

DVD-ROM drive

The drive supports the formats CD-ROM, DVD-ROM, DVD-Video, CD-DA, CD-Text, Photo CD™ (single/multi-session), CD-ROM Mode 1, Mode 2, CD-ROM XA Mode 2 (Form1, Form2), Enhanced CD (CD-EXTRA) and Addressing Method 2.

DVD-ROM&CD-R/RW drive

The drive supports the formats in addition to the DVD-ROM drive, and CD-R, CD-RW.

DVD Super Multi drive Double Layer

The drive supports the formats in addition to the DVD-ROM&CD-R/RW drive, and DVD-R, DVD-RW, DVD+R, DVD+RW, DVD-RAM, DVD-R DL (Format1), DVD+R DL.



Some types and formats of DVD-R DL and DVD+R DL discs may be unreadable.

DVD-ROM drive

The full-size DVD-ROM drive module lets you run either 12 cm (4.72") or 8 cm (3.15") CD/DVDs without using an adaptor.



The read speed is slower at the center of a disc and faster at the outer edge.

DVD read	8 speed (maximum)
CD read	24 speed (maximum)

DVD-ROM&CD-R/RW drive

The full-size DVD-ROM&CD-R/RW drive module lets you record data to rewritable CDs as well as run either 12 cm (4.72") or 8 cm (3.15") CD/DVDs without using an adaptor.



The read speed is slower at the center of a disc and faster at the outer edge.

DVD read	8 speed (maximum)
CD read	24 speed (maximum)
CD-R write	24 speed (maximum)
CD-RW write	24 speed (maximum, Ultra-speed media)

DVD Super Multi drive Double Layer

The full-size DVD Super Multi drive module lets you record data to rewritable CD/DVDs as well as run either 12 cm (4.72") or 8cm (3.15") CD/DVDs without using an adaptor.



The read speed is slower at the center of a disc and faster at the outer edge.

DVD read	8 speed (maximum)
DVD-R write	8 speed (maximum)
DVD-R DL write	2 speed (maximum)
DVD-RW write	4 speed (maximum)
DVD+R write	8 speed (maximum)
DVD+R DL write	2.4 speed (maximum)
DVD+RW write	4 speed (maximum)
DVD-RAM write	5 speed (maximum)
CD read	24 speed (maximum)
CD-R write	24 speed (maximum)
CD-RW write	10 speed (maximum, Ultra-speed media)

AC adaptor

The AC adaptor can automatically adjust to any voltage ranging from 100 to 240 volts and to a frequency of either 50 or 60 hertz, enabling you to use this computer in almost any country/region. The adaptor converts AC power to DC power and reduces the voltage supplied to this computer.

To recharge the battery, simply connect the AC adaptor to a power source and the computer. Refer to Chapter 6, [Power and Power-Up Modes](#) for details.

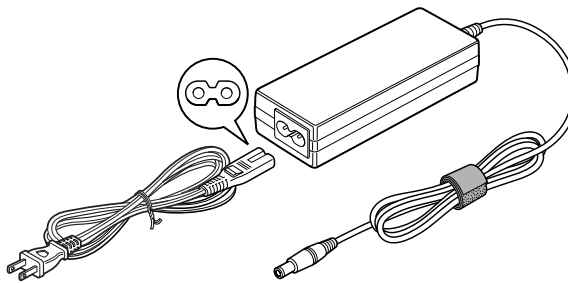

Figure 2-10 The AC adaptor (2-pin plug)

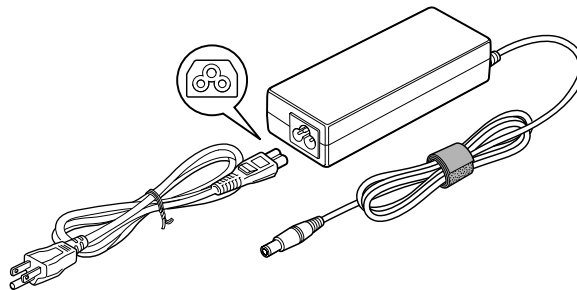

Figure 2-11 The AC adaptor (3-pin plug)



- Depending on the model, a 2-pin plug or 3-pin plug set of the above may be bundled.
- Do not use a 3-pin to 2-pin conversion plug.
- The supplied power cord conforms to safety rules and regulations in the region the product is bought and should not be used outside this region. For use in other regions, please buy power cords that conform to safety rules and regulations in the particular region.



Always use the TOSHIBA AC adaptor that was provided with your PC and the TOSHIBA Battery Charger (that may have been provided with your PC), or use AC adaptors and battery chargers specified by TOSHIBA to avoid any risk of fire or other damage to the PC. Use of an incompatible AC adaptor or Battery Charger could cause fire or damage to the PC possibly resulting in serious injury.

Chapter 3

Features, Utilities and Options

Features

The computer uses TOSHIBA's advanced Large Scale Integration (LSI), Complementary Metal-Oxide Semiconductor (CMOS) technology extensively to provide compact size, minimum weight, low power usage, and high reliability. This computer incorporates the following features and benefits:

Processor

Built-in	<p>The computer is equipped with one of the following Intel® processors.</p> <ul style="list-style-type: none">■ Intel® Core™ Duo Processor, which incorporates a 2MB level2 cache memory. It also supports Enhanced Intel® SpeedStep® Technology.■ Intel® Core™ Solo Processor, which incorporates a 2MB level2 cache memory. It also supports Enhanced Intel® SpeedStep® Technology.■ Intel® Celeron® M Processor, which incorporates a 1MB level2 cache memory.
-----------------	--



- *Some models in the range are equipped with Intel® Centrino® Duo Mobile Technology, which is based on three separate technologies of Intel® Core™ Duo processor, Intel® PRO/Wireless Network Connection, and Mobile Intel® 945 Express Chipset Family.*
- *In addition, some models in the range are equipped with carry Intel® Centrino® Mobile Technology, which is based on three separate technologies of Intel® Core™ Solo processor, Intel® PRO/Wireless Network Connection, and Mobile Intel® 945 Express Chipset Family.*

Legal Footnote (CPU)*2

For more information on the Legal Footnote regarding CPU, please refer to the Legal Footnotes section in Appendix J. Click the *2.

Memory

Slots	256, 512, 1,024 or 2,048 MB memory modules can be installed in the two memory slots for a maximum of 4,096 MB system memory.
Video RAM	<p>There are two different types of graphics controllers. The Video RAM specifications will differ depending on the type of graphics controller used in the computer.</p> <ul style="list-style-type: none"> ■ Intel internal graphics system model: Up to 128MB of main system memory may be allocated to this graphics controller for use as Video memory. ■ nVIDIA Quadro NVS 110M model: This graphics controller is equipped with 128MB of on-board video RAM (memory), and may use up to 128MB of main system memory as additional video memory for a combined total of up to 256MB of video memory.

Legal Footnote (Memory (Main System))*3

For more information on the Legal Footnote regarding Memory (Main System), please refer to the Legal Footnotes section in Appendix J. Click the *3.

Power

Battery pack	The computer is powered by one rechargeable lithium-ion battery pack.
Slice Expansion Battery	This battery pack increases your computer's operating time when main battery pack is also installed.

Legal Footnote (Battery Life)*4

For more information on the Legal Footnote regarding Battery Life, please refer to the Legal Footnotes section in Appendix J. Click the *4.

RTC battery	The internal RTC battery backs up the Real Time Clock (RTC) and calendar.
AC adaptor	<p>The AC adaptor provides power to the system and recharges the batteries when they are low. It comes with a detachable power cord which will either have a 2-pin or 3-pin plug enclosure.</p> <p>Because it is universal, it can receive a range of AC voltage from 100 to 240 volts; however, the output current varies among different models. Using the wrong model can damage your computer. Refer to the AC adaptor section in chapter 2, The Grand Tour.</p>

Disks

Hard disk drive	<p>Available in five sizes.</p> <ul style="list-style-type: none">■ 40.0 billion bytes (37.26 GB)■ 60.0 billion bytes (55.89 GB)■ 80.0 billion bytes (74.53 GB)■ 100.0 billion bytes (93.16 GB)■ 120.0 billion bytes (111.79 GB) <p>Part of the space in the hard disk drive is reserved as administration space.</p>
------------------------	---

Legal Footnote (Hard Disk Drive (HDD) Capacity)*5

For more information on the Legal Footnote regarding Hard Disk Drive (HDD) Capacity, please refer to the Legal Footnotes section in Appendix J. Click the *5.

Optical disc drive

Drive	<p>This computer is equipped with one of the following drive types. The type of drive varies according to model.</p> <ul style="list-style-type: none">■ DVD-ROM drive■ DVD-ROM & CD-R/RW drive■ DVD Super Multi drive Double Layer drive
--------------	---

Display

The computer's LCD display panel supports high-resolution video graphics. The LCD screen can be set at a wide range of viewing angles for maximum comfort and readability.

Built-in	14.1" TFT LCD screen, 16 million colors, with a resolution of 1440 horizontal × 900 vertical pixels WXGA+.
-----------------	--

Legal Footnote (LCD)*6

For more information on the Legal Footnote regarding LCD, please refer to the Legal Footnotes section in Appendix J. Click the *6.

Graphics controller	The graphics controller maximizes display performance. Refer to Display Controller and Modes section in Appendix B for more information.
----------------------------	--

Legal Footnote (Graphics Processor Unit ("GPU"))*7

For more information on the Legal Footnote regarding Graphics Processor Unit ("GPU"), please refer to the Legal Footnotes section in Appendix J. Click the *7.

Sound

Sound system	The Windows sound system compatible sound system provides output to internal speakers and input from one internal microphone as well as supports jacks for an external microphone and headphones.
---------------------	---

Communications

Modem	An internal modem provides capability for data and fax communication. It supports V.90 (V.92). Refer to V.90 section in Appendix E. The speed of data transfer and fax depends on analog telephone line conditions. It has a modem jack for connecting to a telephone line. It is preinstalled as a standard device in some markets. Both of V.90 and V.92 are supported only in USA and Canada. Only V.90 is available in other regions.
LAN	The computer has built-in support for Ethernet LAN (10 megabits per second, 10BASE-T), Fast Ethernet LAN (100 megabits per second, 100BASE-TX) and Gigabit Ethernet LAN (1000 megabits per second, 1000BASE-T). It is preinstalled as a standard device in some markets.
Bluetooth	Some computers in this series are equipped with Bluetooth functions. Bluetooth wireless technology eliminates the need for cables between electronic devices such as computers and printers. Bluetooth provides fast, reliable, and secure wireless communication in a small space.
Wireless LAN	Some computers in this series are equipped with a Wireless LAN card that is compatible with other LAN systems based on Direct Sequence Spread Spectrum/Orthogonal Frequency Division Multiplexing radio technology that complies with the IEEE 802.11 Standard (Revision A, B or G).

Legal Footnote (Wireless LAN)*8

For more information on the Legal Footnote regarding Wireless LAN, please refer to the Legal Footnotes section in Appendix J. Click the *8.

Special features

The following features are either unique to TOSHIBA computers or are advanced features, which make the computer more convenient to use.

Hot keys	Hot keys are specific key combinations that let you quickly change the system configuration directly from the keyboard without running a system program.
Display automatic power off	This feature automatically cuts off power to the computer's LCD display panel when there is no keyboard input for a specified time. Power is restored when any key is pressed. You can specify the time in the Monitor power off item of the Basic Setup tab in TOSHIBA Power Saver .
HDD automatic power off	This feature automatically cuts off power to the hard disk drive when it is not accessed for a specified time. Power is restored when the hard disk is accessed. You can specify the time in the HDD power off item of the Basic Setup tab in TOSHIBA Power Saver .
System automatic Standby/Hibernation	This feature automatically shuts down the system into either Standby Mode or Hibernation Mode when there is no input or hardware access for a specified time. You can specify the time and select either the System Standby or System Hibernation item of the Basic Setup tab in TOSHIBA Power Saver .
Keypad overlay	A ten-key pad is integrated into the keyboard. Refer to the Keypad overlay section in Chapter 5, The Keyboard, for instructions on using the keypad overlay.
Power on password	Two levels of password security, supervisor and user, are available to prevent unauthorized access to your computer.
Instant security	A hot key function blanks the LCD screen and disables the computer providing data security.
Intelligent power supply	A microprocessor in the computer's intelligent power supply detects the battery's charge and calculates the remaining battery capacity. It also protects electronic components from abnormal conditions, such as voltage overload from an AC adaptor. You can monitor remaining battery capacity by using the Battery remaining item in TOSHIBA Power Saver .

Battery save mode	This feature lets you save battery power. You can specify the Power Save Mode in the Profile item in TOSHIBA Power Saver .
Panel power on/off	This feature turns power to the computer off when the computer's LCD display panel is closed and turns it back on when the computer's LCD display panel is opened. You can specify the setting in the When I close the lid item of the Setup Actions tab in TOSHIBA Power Saver .
Low battery automatic hibernation	When battery power is exhausted to the point that computer operation cannot be continued, the system automatically enters Hibernation and shuts down. You can specify the setting in the Setup Actions tab in TOSHIBA Power Saver .
Heat dispersal	To protect from overheating, the CPU has an internal temperature sensor. If the computer's internal temperature rises to a certain level, the cooling fan is turned on or the processing speed is lowered. Use the Cooling Method item of the Basic Setup tab in TOSHIBA Power Saver .
Optical Drive Power	Use this to turn the power of the optical disc drive on or off. Clicking on the Optical Drive Power icon in the taskbar will turn the power to the optical disc drive on or off. If the Optical Drive Power is set to off, the disc tray will not open even if the eject button is pushed - in this instance the power to the drive can be turned on by again clicking the Optical Drive Power icon.
TOSHIBA HDD Protection	Using the acceleration sensor built in the computer, the TOSHIBA HDD Protection function detects vibrations and shocks, and automatically moves the hard disk drive's read/write head to a safe position to reduce the risk of damage that could be caused by head-to-disk contact. Refer to the Using the Hard Disk Drive (HDD) Protection section in Chapter 4, Operating Basics, for details.



The TOSHIBA HDD Protection function does not guarantee that the hard disk drive will not be damaged.

Hibernation	This feature lets you turn off the power without exiting from your software. The contents of main memory are saved to the hard disk so that when you next turn the power on again, you can continue working right where you left off. Refer to the Turning on the power section in Chapter 1, Getting Started, for details.
Standby	If you have to interrupt your work, you can turn off the power without exiting from your software. Data is maintained in the computer's main memory. When you turn on the power again, you can continue working right where you left off.

Utilities

This section describes preinstalled utilities and tells how to start them. For details on usage and operation, refer to each utility's online manual, help files or readme.txt files.

TOSHIBA Power Saver	To access this power savings management program, click start , click Control Panel , click Performance and Maintenance and click the TOSHIBA Power Saver icon.
HW Setup	This program lets you customize your hardware settings according to the way you work with your computer and the peripherals you use. To start the utility, to access this utility, click start , click Control Panel , click Printers and Other Hardware and click the TOSHIBA HWSetup icon.
TOSHIBA Controls	This utility have a section to let you do the following: <ul style="list-style-type: none"> ■ Buttons: Assign applications or functions to the 4 buttons (TOSHIBA Assist, TOSHIBA Presentation, Application1, Application2).

Fingerprint utility	<p>This product has a fingerprint utility installed for the purpose of enrolling and recognizing fingerprints. By enrolling the ID and password to the fingerprint authentication device, it is no longer necessary to input the password from the keyboard. Fingerprint feature enables you to:</p> <ul style="list-style-type: none"> ■ Logon to Windows and access a security-enabled homepage through IE (Internet Explorer). ■ Files and folders can be encrypted/decrypted and third party access to them prevented. ■ Disable the password-protected screen-saver when returning from power-saving (e.g., standby) mode. ■ Authentication of the User Password (and, if applicable, the HDD(Hard Disk Drive) Password) when booting up the computer (Power-on Security). ■ Single Sign-on feature
Fn-esse	<p>This Windows program lets you define your own “shortcut” keys to quickly launch applications and speed your work in Windows. To start the utility, click start, point to All Programs, point to TOSHIBA, point to Utilities and click Fn-esse.</p>
DVD Video Player	<p>The DVD Video Player is used to play DVD-Video. It has an on-screen interface and functions. Click start, point to All Programs, point to InterVideo WinDVD, then click InterVideo WinDVD.</p>
Bluetooth Stack for Windows by Toshiba	<p>This software enables communication between remote Bluetooth devices.</p>
	<p><i>Bluetooth cannot be used in models that do not have a Bluetooth module installed.</i></p>
TOSHIBA SD Memory Boot Utility	<p>The TOSHIBA SD memory boot utility allows you to create a bootable SD memory card to start the system. You can access the TOSHIBA SD Memory Boot Utility from the menu bar by clicking start, point to All Programs, point to TOSHIBA, point to Utilities and click SD Memory Boot Utility.</p>
TOSHIBA Zooming Utility	<p>This utility allows you to enlarge or reduce the icon size on the desktop or the application window.</p>

RecordNow! Basic for TOSHIBA	You can create CD/DVDs in several formats including audio CDs that can be played on a standard stereo CD player and data CD/DVDs to store the files and folders on your hard disk drive. This software can be used on models equipped with a DVD-ROM & CD-R/RW drive or a DVD Super Multi drive.
TOSHIBA Assist	TOSHIBA Assist is a graphical user interface that provides easy access to help and services. It is the default function launched by the TOSHIBA Assist button.
TOSHIBA PC Diagnostic Tool	TOSHIBA PC Diagnostic Tool displays the basic information on the computer's configuration and allows some of the built-in devices functionality to be tested. To start TOSHIBA PC Diagnostic Tool, click start , point to All Programs , point to TOSHIBA , point to Utilities and click PC Diagnostic Tool .
TOSHIBA Mobile Extension	This utility enhances the function of your computer when docking to an optional TOSHIBA Express Port Replicator. To access the utility, select TOSHIBA Mobile Extension from the TOSHIBA Assist application.
TOSHIBA ConfigFree	TOSHIBA ConfigFree is a suite of utilities to allow easy control of communication devices and network connections. TOSHIBA ConfigFree also allows you to find communication problems and create profiles for easy switching between locations and communication networks. To start ConfigFree, click start , point to All Programs , point to TOSHIBA , point to Networking and click ConfigFree .
TOSHIBA TouchPad On/Off Utility	This utility allows you to disable/enable the Touch Pad using the Fn + F9 Hot key.
TOSHIBA Mic Effect	The TOSHIBA Mic Effect utility provides you with Echo Canceller and Microphone Array functions. For more instructions for this software, click start , point to All Programs , point to TOSHIBA , point to Utilities and click TOSHIBA Mic Effect Help .
TOSHIBA Password Utility	This utility lets you set a password that restricts access to the computer.
TOSHIBA Accessibility	This utility lets you make the Fn key sticky, that is, you can press it once, release it, and they press an " F number " key. The Fn key remains active until another key is pressed.

DLA for TOSHIBA	DLA (Drive Letter Access) is the packet writing software which provides the function to write files and/or folders to DVD-RW, CD-RW and DVD+RW discs via a drive letter like a floppy disk or other removable disks.
TOSHIBA Hotkey Utility for Display Devices	This utility allows you to select the display device as well as change the display resolution on that device. Press the Fn + F5 Hot key to change the active display device and press the Fn + Space Hot key to change the display resolution.
TOSHIBA SD Memory Card Format	The TOSHIBA SD Memory Card Format utility allows you to format an SD memory card by the SD standard format.
CD/DVD Drive Acoustic Silencer	This utility allows you to configure the read speed of the CD drive. You can either configure Normal Mode, which operates the drive at its maximum speed for quick data access, or Quiet Mode which runs it at single speed for CD audio play back and which lessens operational noise. This utility has no effect when access DVD media.
TOSHIBA Accelerometer Utilities	When TOSHIBA Accelerometer Utilities is enabled, you can invoke the Start menu, switch active windows or launch predefined applications by shaking the computer vertically or horizontally, or by tilting it. You can start TOSHIBA Accelerometer Utilities by clicking start , click All Programs , click TOSHIBA , click Tablet PC and Setup for TOSHIBA Accelerometer Utilities . The Setting of TOSHIBA Accelerometer Utilities screen appears.

TOSHIBA Tablet Access Code Logon Utility	If a Windows password has been set, you can logon to the operating system by entering a handwriting signature into the dialog box using the Tablet PC Pen when prompted.
TOSHIBA Rotation Utility	<p>This utility controls the screen orientation setting for both PC mode and Tablet mode.</p> <p>You can set four types of orientation setting:</p> <ul style="list-style-type: none">■ Primary landscape■ Primary portrait■ Secondary landscape■ Secondary portrait <p>The default setting of PC mode is Primary Landscape while that for Tablet mode is Primary Portrait.</p> <p>To start TOSHIBA Rotation Utility, Click start, click All Programs, click TOSHIBA, click Tablet PC and Rotation Utility.</p>

Optional devices

Optional devices can expand the computer's capabilities and its versatility. This section describes connection or installation of the following devices.

Cards/memory

- PC card
- Bridge media slot
 - SD card (SD memory card, SDIO card)
 - Memory Stick/Memory Stick Pro
 - xD picture card
 - MultiMediaCard
- Memory expansion

Power devices

- Battery Pack
- Universal AC Adaptor
- Slice Expansion Battery
- Battery Charger

Peripheral devices

- USB FDD Kit
- Tablet PC Pen
- Reserve pen
- External monitor
- TV
- i.LINK (IEEE1394)
- TOSHIBA Express Port Replicator
- Bluetooth USB Adaptor
- Wireless Optical Mouse with Bluetooth Technology
- Wireless Stereo Headset with Bluetooth Technology

Other

- Security lock

PC card

The computer is equipped with a PC card slot that can accommodate a Type II card. Any PC card that meets industry standards (manufactured by TOSHIBA or other vendor) can be installed. The slot supports 16-bit PC cards, including PC card 16's multifunction card and CardBus PC cards.

CardBus supports the new standard of 32-bit PC cards. The bus provides superior performance for the greater demands of multimedia data transmission.



PC cards can sometimes become hot during PC operation. Before you remove a PC card always wait for it to cool. You could get burned removing a hot PC card.

Inserting a PC card

Windows hot-install feature lets you insert PC cards while the computer's power is on.



Do not insert a PC card while the computer is in Standby or Hibernation Mode. Some cards might not work properly.

To insert a PC card, follow the steps below:

1. Insert a PC card in the PC card slot.

2. Press gently to ensure a firm connection.

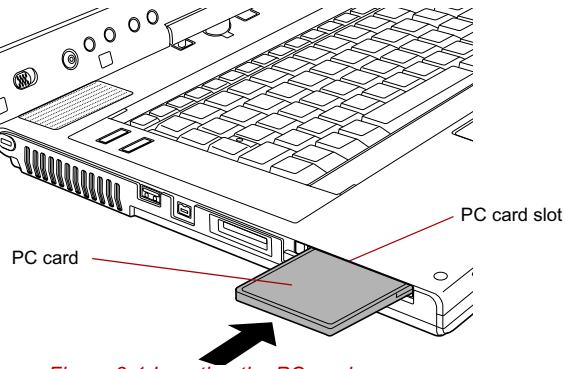

Figure 3-1 Inserting the PC card

3. After inserting the PC card, refer to the PC card's documentation and check the configuration in Windows to make sure it is appropriate for your PC card.

Removing a PC card

To remove the PC card, follow the steps below.

1. Open the **Safely Remove Hardware** icon on the Task Bar.
2. Point to **PC card** and click.
3. Press the PC card eject button to extend it.



If the PC card is not inserted all the way, the eject button may not cause it to pop out sufficiently to allow it to be grasped. Be sure to push the PC card firmly into the computer and slide the eject button again.

4. Press the extended eject button to pop the card out slightly.
5. Grasp the PC card and draw it out.

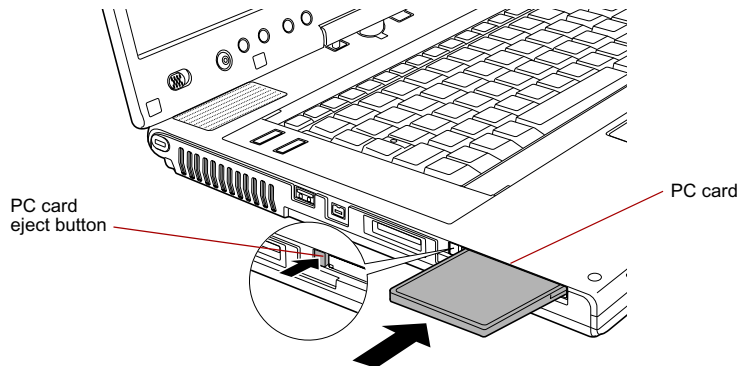

Figure 3-2 Removing the PC card

Bridge media slot

This slot lets you insert SD memory card, SDIO card, Memory Stick (Pro), xD picture card or MultiMediaCard.



This Bridge media slot supports the following cards.

- SD card (SD memory card, SDIO card)
- Memory Stick
- Memory Stick PRO
- xD picture card
- MultiMediaCard

Precautions on using cards.

Please note that not all cards have been tested and verified to work correctly. Therefore, it is not possible to guarantee that all cards will operate properly.

Media care

Observe the following precautions when handling the card.

Card care

- Do not twist or bend cards.
- Do not expose cards to liquids or store in humid areas or lay media close to containers of liquid.
- Do not touch the metal part of a card or expose it to liquids or let it get dirty.
- After using card, return it to its case.
- The card is designed so that it can be inserted only one way. Do not try to force the card into the slot.
- Do not leave a card partially inserted in the slot. Press the card until you hear it click into place.

Memory card care

- Set the write-protect switch to the lock position, if you do not want to record data.
- Memory cards are consumable items, so make sure you back up important data.
- Do not write to an SD card if the battery power is low. Low power could affect writing accuracy.
- Do not remove an SD card while read/write is in progress.



For more details on using memory cards, see manuals accompanying the cards.

SD card

Set the SD-card type SD memory cards and Bluetooth® SDIO cards in the Bridge Media slot.



Keep foreign objects out of the Bridge media slot. Never allow metal objects, such as screws, staples and paper clips, to enter the PC or keyboard. Foreign metal objects can create a short circuit, which can cause PC damage and fire, possibly resulting in serious injury.

Inserting an SD card

To insert an SD card, follow the steps below.

1. Insert an SD card in the Bridge media slot.
2. Press gently to ensure a firm connection.

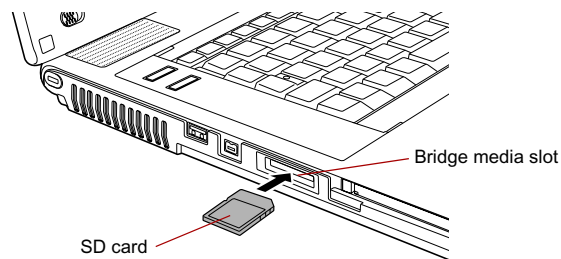

Figure 3-3 Inserting an SD card



- *Make sure the SD card is oriented properly before you insert it.*
- *Do not turn the computer off or switch to Standby Mode or Hibernate Mode while files are being copied - doing so may cause data to be lost.*

Removing an SD card

To remove an SD card, follow the steps below.

1. Open the **Safely Remove Hardware** icon on the Task Bar.
2. Point to **SD card** and click.
3. Push in the card and release it to pop the card out slightly.
4. Grasp the card and remove it.

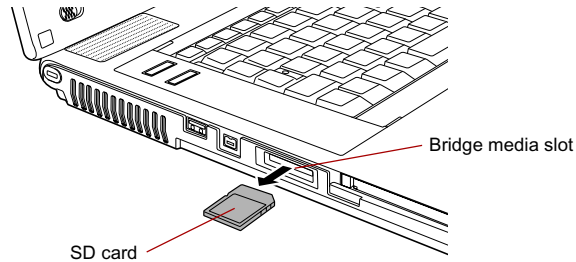

Figure 3-4 Removing an SD card



- Make sure the **Bridge media slot** indicator is out before you remove the SD card or turn off the computer's power. If you remove the SD card or turn off the power while the computer is accessing the SD card you may lose data or damage the card.
- Do not remove an SD card while the computer is in Standby or Hibernation mode. The computer could become unstable or data in the SD card could be lost.

SD memory card

SD cards let you easily transfer data from devices, such as digital cameras and Personal Digital Assistants, that use SD card flash-memory. The cards have a high level of security and copy protection features.



SD memory cards comply with SDMI (Secure Digital Music Initiative), which is a technology adopted to prevent unlawful copy or playback of digital music. For this reason, you cannot copy or playback protected material on another computer or other device. You may not use the reproduction of any copyrighted material except for your personal enjoyment.

Formatting an SD card

SD memory cards are sold already formatted in conformity to specific standards. If you format the SD card again, be sure to format it with the TOSHIBA SD Memory Card Format utility, not with the format commands provided within Windows.

In order to run TOSHIBA SD Memory Card Format, click **start**, point to **All Programs**, point to **TOSHIBA**, point to **Utilities** and click **SD Memory Card Format**.

The TOSHIBA SD Memory Card Format utility does not format the protected area of the SD memory card. Should you need to format all areas of the memory card, including the protected area, you will need to obtain an appropriate application that applies the copy protection system.

SDIO card

Add the Bluetooth® wireless communication function to a computer with the SDIO card.

Memory Stick/Memory Stick Pro

The computer is equipped with a Bridge media slot that can accommodate Memory Stick/Memory Stick Pro flash memory cards with various memory capacities. Memory Stick let you easily transfer data from devices, such as digital cameras and Personal Digital Assistants, that use Memory Stick technology.



Keep foreign objects out of the Bridge media slot. Never allow metal objects, such as screws, staples and paper clips, to enter the PC or keyboard. Foreign metal objects can create a short circuit, which can cause PC damage and fire, possibly resulting in serious injury.



- *The slot does not support Magic Gate functions.*
- *Memory Stick Duo/PRO Duo and the Memory Stick adaptor are not compatible with the Bridge media slot. Do not insert Memory Stick Duo/PRO Duo into the slot. Data may be lost or damaged if you use any card other than those supported.*

Write protection

Memory Stick can be write protected to safeguard your data. To write-protect a Memory Stick, slide the lock on the back of the Memory Stick to the lock position.

Inserting a Memory Stick

To insert a Memory Stick, follow the steps below.

1. Insert the Memory Stick into the Bridge media slot.

2. Press gently to ensure a firm connection.

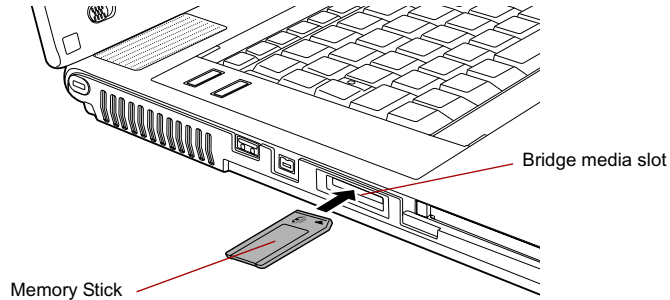

Figure 3-5 Inserting a Memory Stick

Removing a Memory Stick

To remove a Memory Stick, follow the steps below.

1. Open the **Safely Remove Hardware** icon on the Task Bar.
2. Point to **Memory Stick** and click.
3. Push in the card and release it to pop the card out slightly.
4. Grasp the card and remove it.



- Make sure the **Bridge media slot** indicator is out before you remove the Memory Stick or turn off the computer's power. If you remove the Memory Stick or turn off the power while the computer is accessing the Memory Stick you may lose data or damage the card.
- Do not remove a Memory Stick while the computer is in Standby or Hibernation mode. The computer could become unstable or data in the Memory Stick could be lost.

xD picture card

The computer is equipped with a Bridge media slot that can accommodate xD picture cards with various memory capacities. The xD picture card let you easily transfer data from devices, such as digital cameras that use xD picture card flash-memory.



- Keep foreign objects out of the Bridge media slot. Never allow metal objects, such as screws, staples and paper clips, to enter the PC or keyboard. Foreign metal objects can create a short circuit, which can cause PC damage and fire, possibly resulting in serious injury.

Inserting an xD picture card

To insert an xD picture card, follow the steps below.

1. Insert the xD picture card into the Bridge media slot.
2. Press gently to ensure a firm connection.

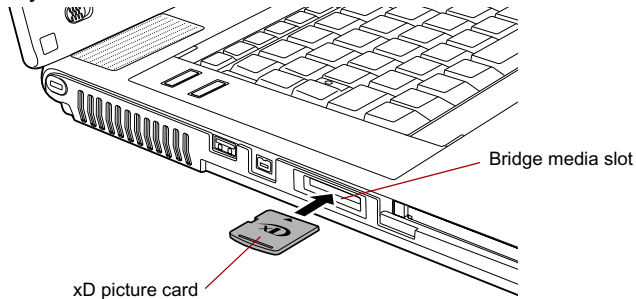

Figure 3-6 Inserting an xD picture card

Removing an xD picture card

To remove an xD picture card, follow the steps below.

1. Open the **Safely Remove Hardware** icon on the Task Bar.
2. Point to **xD picture card** and click.
3. Push in the card and release it to pop the card out slightly.
4. Grasp the card and remove it.



- *Make sure the **Bridge media slot** indicator is out before you remove the xD picture card or turn off the computer's power. If you remove the xD picture card or turn off the power while the computer is accessing the xD picture card you may lose data or damage the card.*
- *Do not remove an xD picture card while the computer is in Standby or Hibernation mode. The computer could become unstable or data in the xD picture card could be lost.*

MultiMediaCard

The computer is equipped with the Bridge media slot that can accommodate MultiMediaCard flash memory technology with various memory capacities. MultiMediaCards let you easily transfer data from devices, such as digital cameras and Personal Digital Assistants, that use MultiMediaCard flash-memory. The cards have a high level of security and copy protection features.



Keep foreign objects out of the Bridge media slot. Never allow metal objects, such as screws, staples and paper clips, to enter the PC or keyboard. Foreign metal objects can create a short circuit, which can cause PC damage and fire, possibly resulting in serious injury.



MultiMediaCards comply with SDMI (Secure Digital Music Initiative), which is a technology adopted to prevent unlawful copy or playback of digital music. For this reason, you cannot copy or playback protected material on another computer or other device. You may not use the reproduction of any copyrighted material except for your personal enjoyment.

Inserting a MultiMediaCard

To insert a MultiMediaCard, follow the steps below.

1. Insert the MultiMediaCard into the Bridge media slot.
2. Press gently to ensure a firm connection.

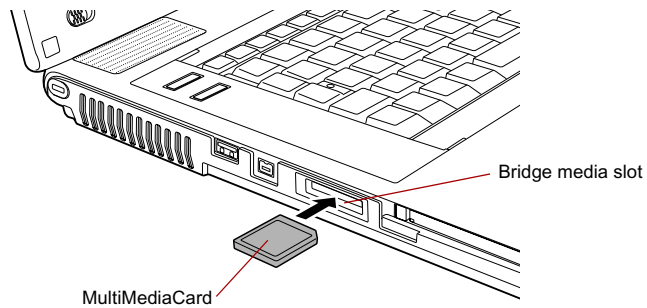

Figure 3-7 Inserting a MultiMediaCard



Make sure the MultiMediaCard is oriented properly before you insert it.

Removing a MultiMediaCard

To remove a MultiMediaCard, follow the steps below.

1. Open the **Safely Remove Hardware** icon on the Task Bar.
2. Point to **MultiMediaCard** and click.
3. Push in the card and release it to pop the card out slightly.
4. Grasp the card and remove it.

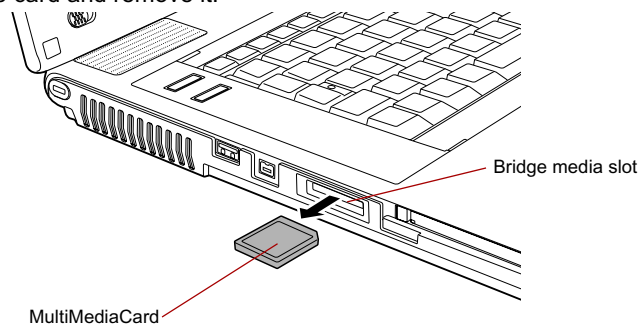

Figure 3-8 Removing a MultiMediaCard



- Make sure the **Bridge media slot** indicator is out before you remove the MultiMediaCard or turn off the computer's power. If you remove the MultiMediaCard or turn off the power while the computer is accessing the MultiMediaCard you may lose data or damage the card.
- Do not remove a MultiMediaCard while the computer is in Standby or Hibernation mode. The computer could become unstable or data in the MultiMediaCard could be lost.

Memory expansion

You can install additional memory in the computer's memory module slot to increase the amount of RAM. This section describes how to install and remove a memory module.



- Place a mat beneath the computer to prevent scratching or damaging the computer's lid when installing/replacing the memory module. Avoid mats made of materials that generate static electricity.
- When you install or remove a memory module, ensure that you do not touch any other internal areas of the computer.



- Use only memory modules approved by TOSHIBA.
- Do not try to install or remove a memory module under the following conditions as you can damage the computer and/or the module, and you risk losing data:
 - a. The computer is turned on.
 - b. The computer was shut down using either Standby Mode or Hibernation mode.
 - c. Wake-up on LAN is enabled.
 - d. Wake-up on Wireless LAN is enabled.
- Be careful not to let screws or other foreign matter fall into the computer. It could cause malfunction or electric shock.
- Expansion memory is a precision electronic component that may be fatally damaged by static electricity. Since the human body can carry static electricity, it is important that you discharge yourself before touching or installing any expansion memory modules. To discharge your body's static electricity, simply touch any metal close to you with bare hands.

If you install a memory module that is not compatible with the computer, the power LED will flash (on for 0.5 seconds, off for 0.5 seconds) in the following ways;

If there is only an error in Slot A: repeatedly flashes orange twice, then green.

If there is only an error in Slot B: repeatedly flashes orange, then green twice.

If there is an error in Slot A and in Slot B: repeatedly flashes orange twice, then green twice.

In all instances you should shut down the computer and remove the incompatible module(s).



Use a point size 1 Phillips screwdriver to remove and fasten the screws. Use of an incorrect screwdriver can damage the screw heads.

Installing a memory module

There are slots for two memory modules. The procedures are the same for installing either module.

1. Set the computer to boot mode and turn the computer's power off. Make sure the **Power** indicator is off. Refer to the [Turning on the power](#) section in Chapter 1, Getting Started.
2. Remove AC adaptor and all cables connected to the computer.
3. Turn the computer upside down and remove the battery pack. Refer to [Replacing the battery pack](#) section in Chapter 6, Power and Power-Up Modes, for details.
4. Turn your computer over.
5. Push the display latch on the front of the computer and open the LCD display panel.
6. Remove the 2 keyboard braces at the top and bottom of the keyboard. Slip your finger under a notch at the end of the keyboard braces and lift up to release latches and remove the keyboard braces.

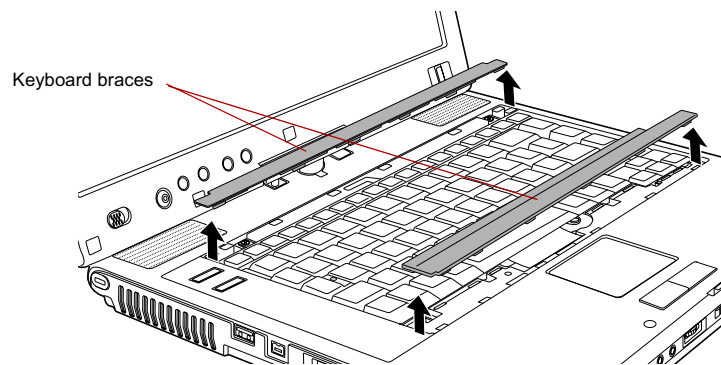

Figure 3-9 Removing the keyboard braces

7. Remove two screws securing the keyboard.



Use a point size 1 Phillips screwdriver.

8. Open the latch which holds the keyboard in place, then lift the back of the keyboard toward you, and lay it face down on the palm rest.



■ When you move the keyboard forward, do not touch the keys. Doing so could cause misalignment. Hold the keyboard by the sides and lay it gently on the palm rest.

■ The keyboard is connected to the computer by a keyboard ribbon cable. Be careful not to apply tension to this cable when you lift up the keyboard. Do not try to disconnect this cable.

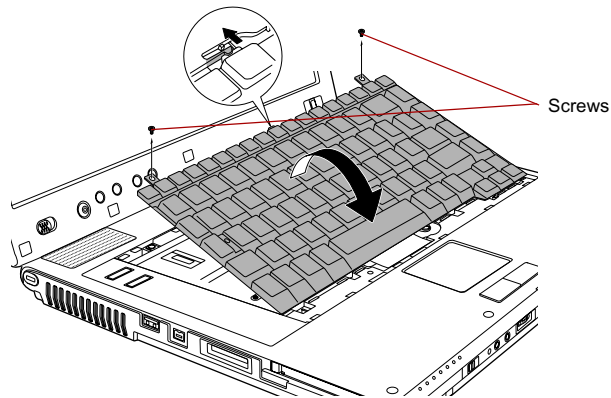

Figure 3-10 Removing two screws and rotate the keyboard

9. Remove the two screws and take off the memory module cover.

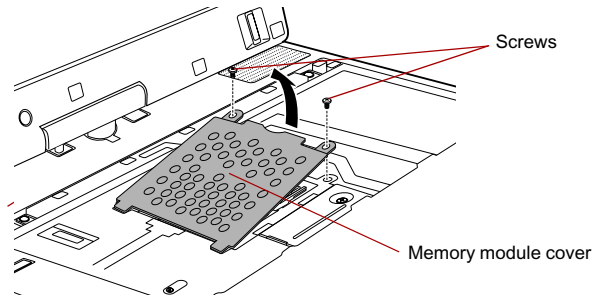

Figure 3-11 Removing the memory module cover



■ Do not touch the connectors on the memory module or on the computer. Debris on the connectors may cause memory access problems.

■ The memory module cover will be hot after using the computer for long periods of time. Exercise caution when removing.



The slot A is reserved for main memory. Use the slot B for expanded memory. If only one card is installed, use the slot A.

10. Fit the memory module's connectors into the socket at about a 45 degree angle and push the module down until latches on either side snap into place.
Align the notch of the memory module with that of the memory slot and gently insert the module into the slot.

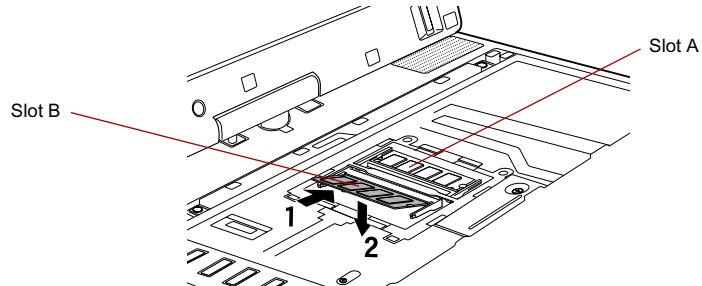

Figure 3-12 Installing the memory module

11. Screw in the two screws and replace the memory module cover.

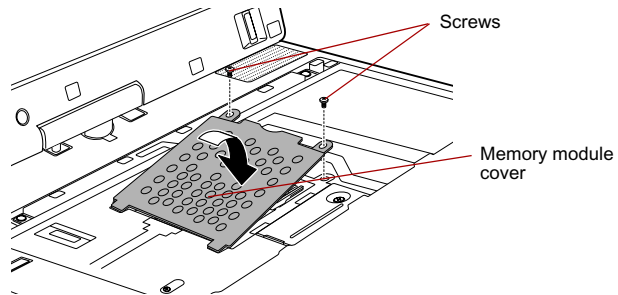

Figure 3-13 Seating the memory module cover

- Tuck the keyboard ribbon cable into the groove under the palm rest.

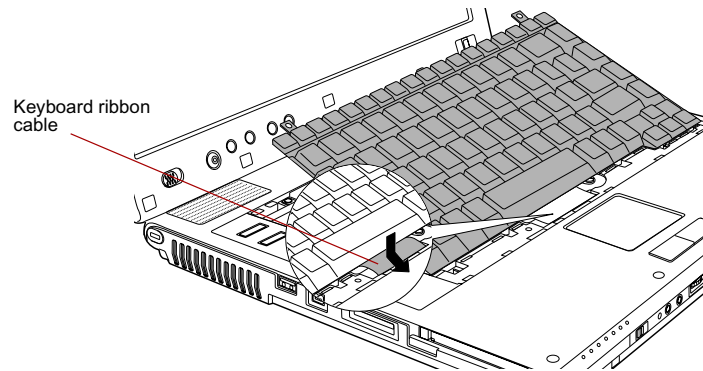

Figure 3-14 Tuck the keyboard ribbon cable



Do not bend the keyboard ribbon cable.

- Insert the tabs on the front of the keyboard into the corresponding notches on the computer and place the keyboard down.



When seating the keyboard, be sure to connect the circuit board if the keyboard ribbon cable was pulled out while you were removing the keyboard.

- Screw the two screws and secure the keyboard.



Be sure to use all two screws removed in step 7. Make sure no screw was dropped into the computer. Make sure no foreign matter can be found.

- Set the keyboard braces into its groove and press down to secure the latches.
- Install the battery pack. Refer to [Replacing the battery pack](#) section in Chapter 6, Power and Power-Up Modes, for details.
- Turn your computer over.
- Turn the power on and make sure the added memory is recognized. Click **start**, click **Control Panel**, click **Performance and Maintenance** and select the **System** icon. Open **System Properties** window and click **General** tab.

Removing a memory module

To remove the memory module, make sure the computer is in boot mode then:

- Set the computer to boot mode and turn the computer's power off. Make sure the **Power** indicator is off.
- Remove AC adaptor and all cables connected to the computer.

3. Turn the computer upside down and remove the battery pack. Refer to [Replacing the battery pack](#) section in Chapter 6, Power and Power-Up Modes, for details.
4. Follow steps 4 through 9 in Installing memory module to remove the memory module cover.
5. Push the latches to the outside to release the memory module. A spring will force one end of the memory module up.
6. Grasp the sides of the module and pull it out.



- *If you use the computer for a long time, the memory modules and the circuits locating close to the memory modules will become hot. In this case, let them cool to room temperature before you replace them. Or you will get burnt if you touch any of them.*
- *Do not touch the connectors on the memory module or on the computer. Debris on the connectors may cause memory access problems.*

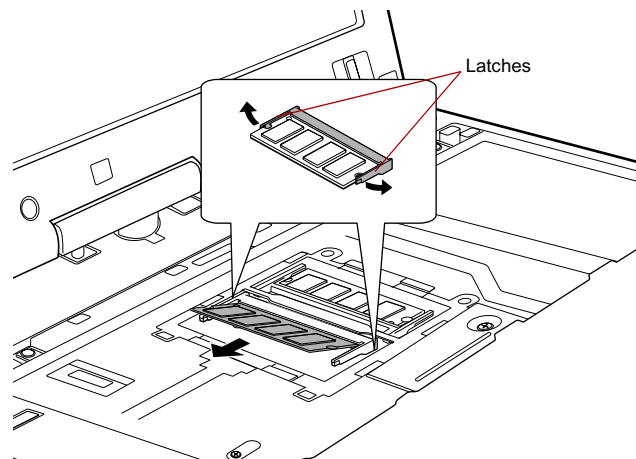

Figure 3-15 Removing the memory module

7. Rotate the keyboard back into place and secure the keyboard brace as described in the previous section.
8. Install the battery pack. Refer to [Replacing the battery pack](#) section in Chapter 6, Power and Power-Up Modes, for details.
9. Turn your computer over.

Battery Pack

You can increase the portability of the computer with additional battery packs. If you're away from an AC power source and your battery runs low, you can replace it with a freshly charged battery. Refer to Chapter 6, [Power and Power-Up Modes](#).

Universal AC Adaptor

If you frequently transport the computer between different sites such as your home and office, purchasing an AC adaptor for each location will reduce the weight and bulk of your carrying load.

Slice Expansion Battery

This battery pack increases your computer's operating time when a main battery pack is also installed. For details on using the battery pack, follow the steps below.

Connecting the Slice Expansion Battery

Follow the steps below to connect the Slice Expansion Battery to the computer



When handling Slice Expansion Battery, be careful not to short circuit the terminals. Also do not drop, hit or otherwise apply impact; do not scratch or break the casing and do not twist or bend the latches of it.

1. Be sure the computer's power is off and all cables are disconnected.
2. Lay the computer upside down.
3. Remove the protective cap from the Slice Expansion Battery.
4. Open the latches on the Slice Expansion Battery (1).
5. Fit the battery's tab into the groove on the underside of the computer (2).
6. Connect the battery's connector to the docking port (3).
7. Close the latches to secure the Slice Expansion Battery to the computer (4).

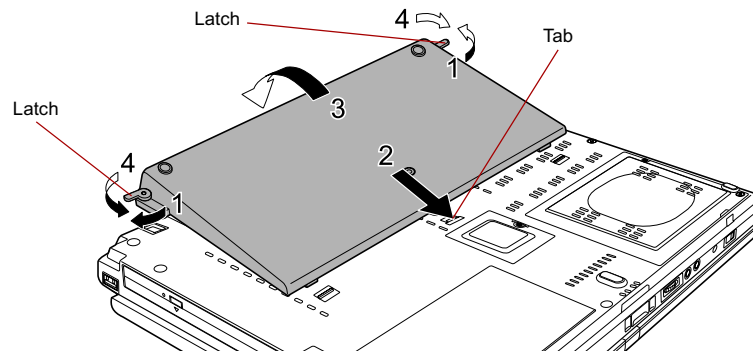

Figure 3-16 Securing the latches

Disconnecting the Slice Expansion Battery

Follow the steps below to disconnect the Slice Expansion Battery to the computer.

1. Save your work.
2. Turn the computer's power off. Make sure the **Power** indicator is off.
3. Remove all cables connected to the computer.
4. Lay the computer upside down.
5. Push the release latches in the direction of the arrows (1).
6. Lift off the Slice Expansion Battery (2).

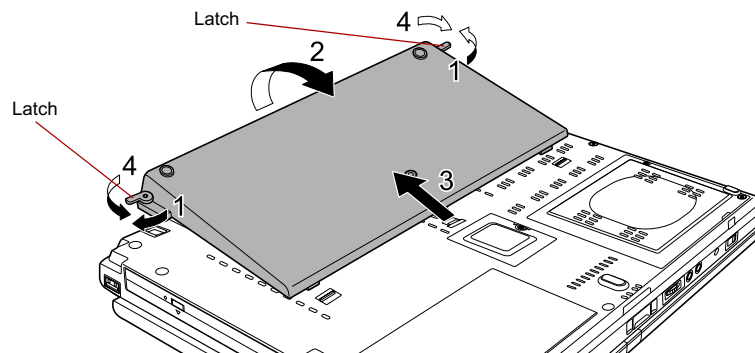

Figure 3-17 Removing the Slice Expansion Battery

7. Be sure to replace the protective cap before storing the Slice Expansion Battery.

Battery Charger

The battery charger provides a convenient way to charge battery packs without requiring the use of your computer. The battery charger holds up to two battery packs (lithium ion).

USB FDD Kit

The USB floppy disk drive accommodates 1.44-megabyte or 720-kilobyte floppy disks and connects to the USB port. It is supplied as standard with some models and as an option with others.

Connecting USB floppy disk drive

To connect the drive, plug the floppy disk drive's USB connector into a computer's USB port.



Make sure the connector is properly aligned with the socket. Do not try to force the connection, doing so can damage the connecting pins.

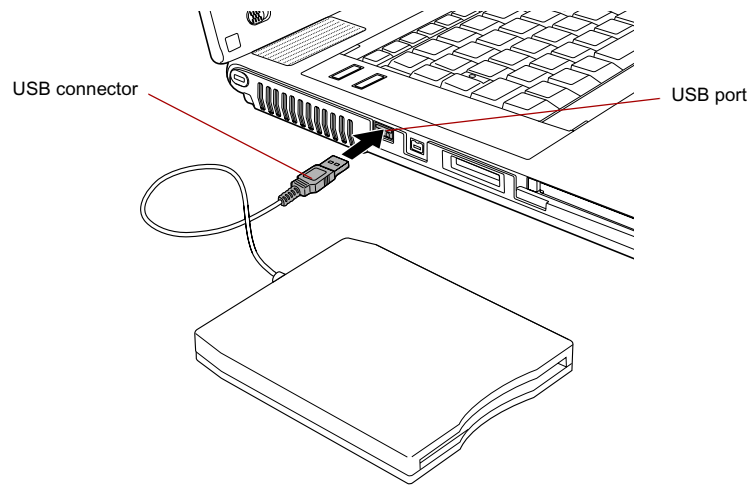

Figure 3-18 Connecting the USB floppy disk drive



If you connect the USB floppy disk drive after turning on the computer, it will take about 10 seconds for the computer to recognize the drive. Do not disconnect and reconnect before 10 seconds has elapsed.

Disconnecting USB floppy disk drive

When you have finished using the USB floppy disk drive, follow the procedures below to disconnect it:

1. Wait for the indicator light to go out to make sure all floppy disk activity has stopped.



If you disconnect the USB floppy disk drive or turn off the power while the computer is accessing the drive you may lose data or damage the floppy disk or the drive.

2. Click the **Safely Remove Hardware** icon on the Task Bar.
3. Click **USB floppy disk drive** device that you want remove.
4. Pull the floppy disk drive's USB connector out of the computer's USB port.

Tablet PC Pen

Use it as a spare to your computer. Spare pen tip and draw-out tool are included. Refer to Chapter 4, *Operating Basics*, for the detailed usage.

Reserve Pen

Supplied pen uses a pen instead of Supplied pen at the time of loss or breakage. Refer to Chapter 4, *Operating Basics*, for the detailed usage.

External monitor

An external analog monitor can be connected to the external monitor port on the computer. To connect a monitor, follow the steps below.

1. Turn the computer's power off.
2. Connect the monitor cable to the external monitor port and tighten the screws on the left and right hand side.

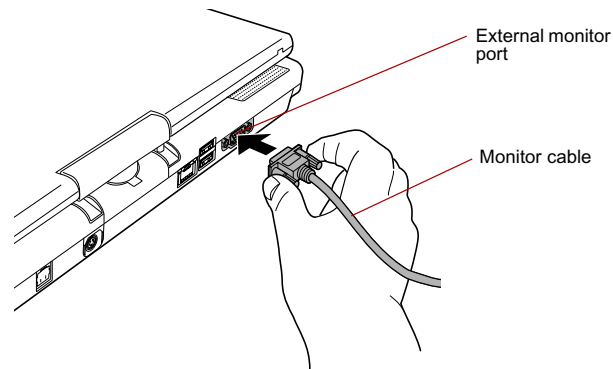

Figure 3-19 Connecting the monitor cable to the external monitor port

3. Turn the monitor's power on.
4. Turn the computer's power on.

When you turn on the power, the computer automatically recognizes the monitor and determines whether it is color or monochrome.

However, the Windows Desktop appears on a display device that you used last time to shut down your computer, if the display device exists when you turn on the power.

To change the display settings, press **Fn + F5**. If you disconnect the external monitor before you turn the computer's power off, be sure to press **Fn + F5** to switch to the internal display. Refer to Chapter 5, *The Keyboard*, for details on using hot keys to change the display setting.

TV

You can connect a television set to the S-Video out port on the computer. Follow the steps below.

As an example, this is the setup method for the TOSHIBA Assist button. Buttons other than the TOSHIBA Assist button can also be re-assigned.

Using the TOSHIBA Assist button

1. Connect the TV adaptor cable's S-Video plug to the S-Video out port on the computer.

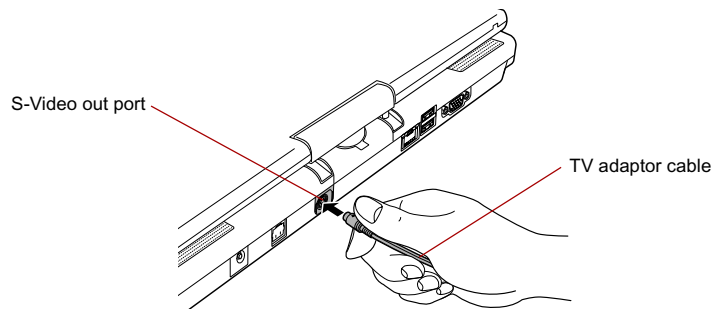

Figure 3-20 Connecting the TV adaptor cable to the S-Video out port

2. Connect the TV adaptor cable's S-Video plug to the S-Video out port on the TV.
3. Press the TOSHIBA Assist button.

You can use the hot keys **Fn + F5** to change the display device. Refer to Chapter 5, [The Keyboard](#).

To use "TV OUT" function by "TOSHIBA Assist button", it is necessary to change the settings of "TOSHIBA Assist button" in advance.

To open "TOSHIBA Controls" properties, click **start**, click **Control Panel**, click **Printers and Other Hardware**, select "TOSHIBA Controls", and set "TV OUT" to "TOSHIBA Assist button" on "Buttons" tab.



If a television is connected to the computer, set the TV type in Display Properties. Follow the steps below.

nVIDIA Quadro NVS 110M model

- a. Click **start** and click **Control Panel**.
- b. Click **Appearance and Themes** and click the **Display** to open the Display Properties window.
- c. Click the **Settings** tab and click the **Advanced** button.
- d. Click the **Quadro NVS 110M** tab, click **Device Settings** and click **Select TV format**.
- e. Select **Advanced** and select **TV Settings** in the TV Settings window.
- f. Select the **Signal format** box and select the format that your TV supports.

Intel internal graphics system model

- a. Click **start** and click **Control Panel**.
- b. Click **Appearance and Themes** and click the **Display** to open the Display Properties window.
- c. Click the **Settings** tab and click the **Advanced** button.
- d. Click the **Intel® Graphics Media Accelerator Driver for Mobile** tab, click **Graphics Properties...** button.
- e. Select **Television** in the **Display Device** tab.
- f. Select the TV format from the Video Standard pull down menu in the **Display Setting** tab.

Changing the resolution

If you want to change the resolution, follow the steps below.

1. Open **Display properties** and select the **Settings** tab.
2. Select **Advanced**.
3. Select the **Adapter** tab, then select **List all modes**.
4. Select a resolution from the menu.

Displaying movies on a TV or CRT

This section describes how to set up your system to display movies simultaneously on your computer's internal LCD and on an external TV or CRT monitor. Please use the following settings if your computer is equipped with the Quadro NVS 110M video card.

Follow the steps below.

1. Open the **Control Panel** and click **Appearance and Themes**.
2. Click **Display**.
3. Select the **Settings** tab and click **Advanced button**.

4. Select the **Quadro NVS 110M** tab.
 - a. Click the **Quadro NVS 110M** button.
 - b. Click **Full Screen Video** in the small menu.
 - c. From the **Full screen** device drop down menu, select **Primary display** or **Secondary display** to enable movie display on an external TV or CRT monitor.

Primary Device: Movies will be displayed full screen on the computer's internal LCD and in a window on the TV or CRT monitor.

Secondary Device: Movies will be displayed full screen on the TV or CRT monitor and in a window on the computer's internal LCD.

Disable: Movies will not be displayed on a TV or CRT monitor.



Even if the above does not set up, there are some as which the movies is simultaneously displayed depending on the type of the movies.

- d. Click **OK**.
- e. Click **OK** in the **Display Properties** screen.

i.LINK (IEEE1394)

i.LINK (IEEE1394) is used for high-speed data transfer for a range of compatible devices such as:

- Digital video cameras
- Hard disk drives
- MO drives
- Writable optical disc drives



i.LINK uses a four-pin connector, which does not carry any electric current. External devices will need their own power supply to operate.

Precautions

- Make a back-up of your data before transferring it to the computer. There is a possibility that the original data will be damaged. There is a particular risk that some frames will be deleted in the case of digital video transfer. TOSHIBA assumes no liability for such loss of data.
- Do not transfer data in areas where static electricity is easily generated or in areas subjected to electronic noise. Data can be destroyed.
- If you are transferring data through an IEEE1394 hub, do not connect or disconnect other devices from the hub during data transfer. There is a likelihood that data will be damaged. Connect all devices to the hub before you turn on the computer's power.
- You may not use any copyrighted video or music data copied from a video camera except for your personal enjoyment.
- If you connect/disconnect an i.LINK device to/from another i.LINK device that is currently exchanging data with the computer, data frames might be dropped.

- Make sure data transfer has ended or turn off the computer, before you:
 - Connect/disconnect an i.LINK device to/from the computer.
 - Connect/disconnect an i.LINK device to/from another i.LINK device that is connected to the computer.

Connecting

1. Make sure the connectors are properly aligned and plug the i.LINK (IEEE1394) cable into the computer.

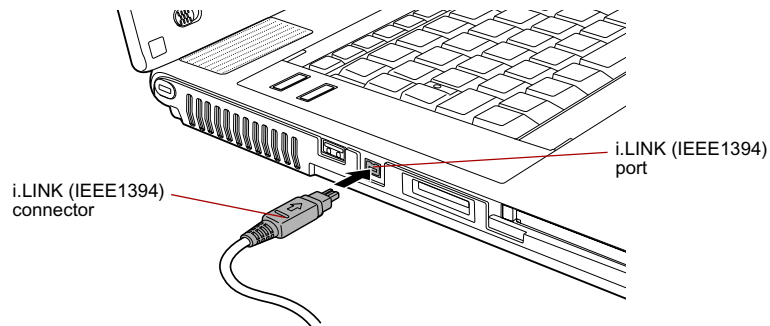

Figure 3-21 Connecting the i.LINK (IEEE1394) cable into the computer

2. Plug the other end of the cable into the device.

Note the following when you use i.LINK:

- You may need to install drivers for your i.LINK devices.
- Not all i.LINK devices have been tested. Therefore, compatibility with all i.LINK devices cannot be guaranteed.
- Some devices might not support standby or automatic off functions.
- Do not connect or disconnect an i.LINK device while it is using an application or when the computer is automatically shutting it down to save power. Data might be destroyed.

Disconnecting

1. Open the **Safely Remove Hardware** icon on the Task Bar.
2. Point to **i.LINK (IEEE1394) device** and click.
3. Disconnect the cable from the computer then from the i.LINK device.



Refer also to the documentation that came with your i.LINK device.

TOSHIBA Express Port Replicator

In addition to the ports available on the computer, the TOSHIBA Express Port Replicator. The TOSHIBA Express Port Replicator connects directly to the docking interface on the underside of the computer. The AC adaptor connects the TOSHIBA Express Port Replicator to a power source.



The computer must be configured properly before connecting to a LAN. Logging onto a LAN using the computer's default settings could cause a malfunction in LAN operation. Check with your LAN administrator regarding set-up procedures.



- You must connect the AC adaptor before you connect to a TOSHIBA Express Port Replicator.
- When a TOSHIBA Express Port Replicator is connected to the computer, you can not use the following computer's ports: LAN jack and External monitor port.
- When connecting an AC Adaptor to the TOSHIBA Express Port Replicator, use only the AC Adaptor included with TOSHIBA Express Port Replicator. Do not use the computer's AC Adaptor.

The following ports and accessories are available on the TOSHIBA Express Port Replicator.

- RJ45 LAN jack
- External monitor port
- DC IN 15V jack
- Security lock slot
- Universal Serial Bus 2.0 port (four)
- DVI port (This port is not supported by the computer)



- As the port operation of all DVI (Digital Visual Interface) monitors has not been confirmed, some DVI monitors may not function properly.
- Set the TOSHIBA Express Port Replicator's Slide Adjuster to SLIDE position #6 when connecting this computer to the TOSHIBA Express Port Replicator. Refer to the TOSHIBA Express Port Replicator User's Manual for more details on connection methods.

Bluetooth USB Adaptor

When connected to one of the computer's USB ports, the Bluetooth USB adaptor allows wireless communications to be carried out with Bluetooth-compatible equipment.

Wireless Optical Mouse with Bluetooth Technology

The Wireless optical mouse with Bluetooth Technology is an optical mouse that is compatible with the Bluetooth wireless standard.

Wireless Stereo Headset with Bluetooth Technology

The Bluetooth Wireless Stereo Headset provides stereo headphones that are compatible with the Bluetooth wireless standard.

Security lock

Security locks enable you to anchor your computer and optional TOSHIBA Express Port Replicator to a desk or other heavy object to help prevent unauthorized removal of the computer or TOSHIBA Express Port Replicator.

The computer has a security lock slot on the left side. Attach one end of a cable to a desk and the other end to the security lock slot.

1. Turn the computer so the left side faces you.
2. Align the holes for the security lock and attach the lock.

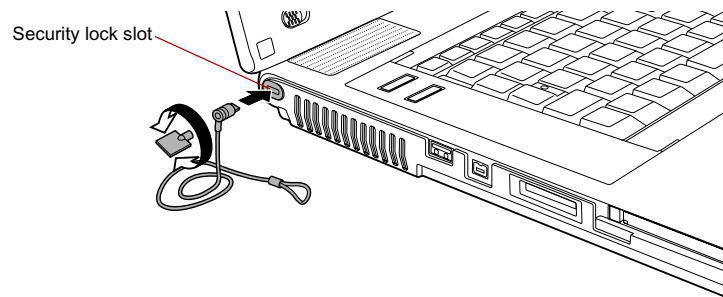

Figure 3-22 Security lock

Options

You can add a number of options to make your computer even more powerful and convenient to use.

You can buy the following options from TOSHIBA dealer.

DDR2-533 Memory Kit	A 256, 512 or 1,024 MB memory module (DDR2-533) can easily be installed in the computer.
DDR2-667 Memory Kit	A 256, 512, 1,024 or 2,048 MB memory module (DDR2-667) can easily be installed in the computer.
USB FDD Kit	The USB floppy disk drive accommodates either 3 1/2" 1.44-megabyte or 720-kilobyte floppy disks through connection to a USB port. Please note that you cannot format 720-kilobyte floppy disks under Windows XP, but you are able to use disks that have been previously formatted.
Universal AC Adaptor	If you use your computer at more than one site frequently, it may be convenient to purchase an additional AC adaptor for each site so you will not have to carry the adaptor with you.
Battery Pack	An additional battery pack can be purchased from your TOSHIBA dealer. Use it as a spare or replacement.
Slice Expansion Battery	This battery pack increases your computer's operating time when a main battery pack is also installed. It is connectable to the Docking Port of the computer.
Battery Charger	The battery charger lets you charge extra batteries outside the computer.
TOSHIBA Express Port Replicator	The TOSHIBA Express Port Replicator provides the ports available on the computer in addition to a digital visual interface (DVI) port*, External monitor port, four Universal Serial Bus ports (USB 2.0) and a LAN jack. *This computer is not supported.
Tablet PC Pen	Additional Tablet PC Pens can be purchased from your TOSHIBA dealer for use as spare items (spare pen tips and a tip draw-out tool are included).
Reserve Pen	Additional Reserve Pens can be purchased from your TOSHIBA dealer for use in the event the main pen becomes lost or damaged. The Reserve Pen is stored inside the computer.

Bluetooth USB Adaptor	When connected to one of the computer's USB ports, the Bluetooth USB adaptor allows wireless communications to be carried out with Bluetooth-compatible equipment.
Wireless Optical Mouse with Bluetooth Technology	The Bluetooth Wireless Mouse is an optical mouse that is compatible with the Bluetooth wireless standard.
Wireless Stereo Headset with Bluetooth Technology	The Bluetooth Wireless Stereo Headset provides stereo headphones that are compatible with the Bluetooth wireless standard.

Chapter 4

Operating Basics

This chapter describes the basic operations of your computer and precautions when using it, as well as the handling of CD/DVD.

Using the Touch Pad

To use the Touch Pad, simply touch and move your fingertip across it in the direction you want the on-screen pointer to go.

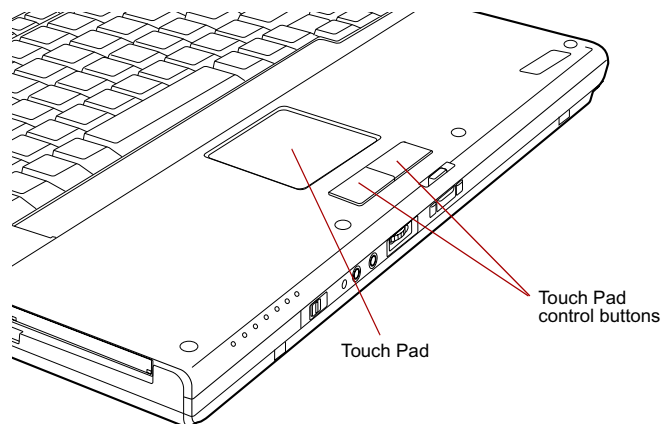

Figure 4-1 Touch Pad and Touch Pad control buttons

Two buttons below the Touch Pad are used like the buttons on a mouse pointer. Press the left button to select a menu item or to manipulate text or graphics designated by the pointer. Press the right button to display a menu or other function depending on the software you are using.



You can also tap the Touch Pad to perform functions similar to those of the left button.

Click: Tap once

Double-click: Tap twice

Drag and drop: Tap to select the material you want to move. Leave your finger on the Touch Pad after the second tap and move the material.

Using the Tablet PC Pen and Reserve Pen

You can use the Tablet PC Pen to execute actions and enter data. Hold the Tablet PC Pen in a natural position and tap, press or trace on the screen lightly. Before you begin using your computer for the first time, you will need to calibrate the Tablet PC Pen. Refer to the [Pointing device](#) section in Chapter 8, Troubleshooting.

Some computers in this series are equipped with a Reserve Pen.

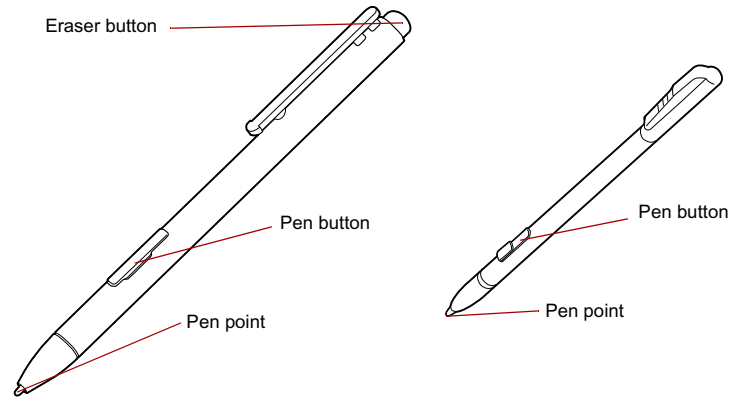

Figure 4-2 The Tablet PC Pen (left) and Reserve Pen (right)

Eraser button	You can use this button as an eraser when using a graphics software application. Text based software application enable you to select and delete characters with a one-touch action.
Pen button	Provides the some function as clicking the right Touch Pad control button.
Pen point	Provides the some function as clicking the left Touch Pad control button.



Observe the following precautions on the handling of the Tablet PC Pen.

- Do not tap or press the Tablet PC Pen forcefully against the display as this could damage the Tablet PC Pen and the screen itself.
- Avoid using or keeping the Tablet PC Pen in areas where the temperature can change rapidly or in places, such as a car, where the Tablet PC Pen is exposed to direct sunlight. Store the Tablet PC Pen without any pressure being applied to the buttons as this may cause a malfunction or characteristic deterioration.
- The Tablet PC Pen is composed of precision parts. Do not drop the Tablet PC Pen. Strong impact causes a malfunction or characteristic deterioration.
- Do not apply excessive force to the Tablet PC Pen point and the side switch. Excessive force applied to these parts causes short life or characteristic deterioration (Allowable force to pen point, Eraser button, Pen button: less than 1 kg, for less than 30 seconds).
- Avoid water entering the Tablet PC Pen or condensation forming within it as either condition will cause a malfunction.
- Do not disassemble the Tablet PC Pen. It causes maladjustment or short life.
- Do not stain the Tablet PC Pen with cosmetics or chemicals as this will cause a deterioration in appearance. Use a glass wiping cloth or dry cloth to clean the Tablet PC Pen. Do not use volatile liquids such as alcohol, thinner or petroleum benzine to clean the Tablet PC Pen.
- Do not apply excessive force to the Tablet PC Pen point as a bent or deformed pen point will cause a malfunction.
- Keep the small parts of the Tablet PC Pen, such as the pen point or the knob of the side switch, away from infants and small children to prevent them from swallowing them.
- Do not use a ball point pen instead of the Tablet PC Pen delivered with the product.
- Do not use a broken pen tip.
- The lead cannot be replaced if it is worn (use the Reserve Pen only).



TOSHIBA is not liable for any problems arising on the products due to the use of the Tablet PC Pen in an environment where the above conditions are not satisfied or because of its use by unspecified number of users.

Removing the Tablet PC Pen

Remove the Tablet PC Pen as described below.

1. Gently push the Tablet PC Pen towards the middle of the computer. The pen will then protrude slightly from the side.

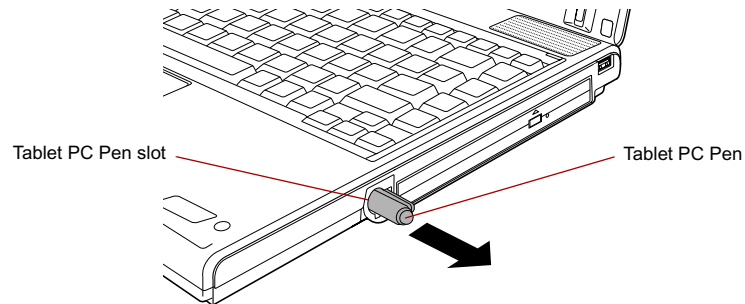

Figure 4-3 Removing the Tablet PC Pen

2. Pull the Tablet PC Pen to remove it from the Tablet PC Pen slot.

Inserting the Tablet PC Pen

The Tablet PC Pen is included in the accessory tray when purchased. Remove the Tablet PC Pen from the carton and install it to the computer as follows:

1. The Tablet PC Pen and the Reserve Pen are different in shape.



The Tablet PC Pen and the Reserve Pen are different in shape. Do not insert the Reserve Pen into the Tablet PC Pen slot.

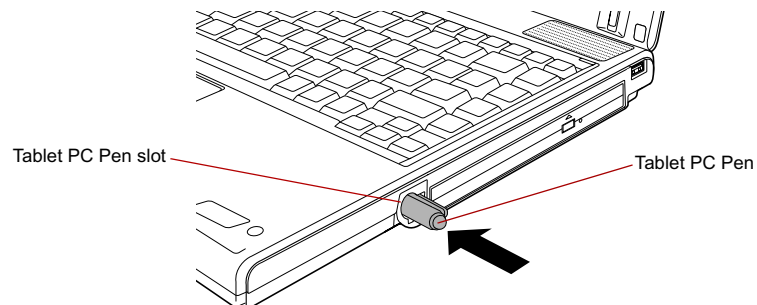

Figure 4-4 Inserting the Tablet PC Pen

Pen actions

You can use the Tablet PC Pen to enter data, start programs, move objects and execute other actions.

Single tap

Lightly tap the tip of the Tablet PC Pen on an object and lift it immediately to execute an action. A single tap is similar to clicking the left touch pad control button.

Double tap

Lightly tap the tip of the Tablet PC Pen twice on an object and lift it immediately to execute an action. A double-tap is similar to double-clicking the left touch pad control button.

Press and hold

Touch the tip of the Tablet PC Pen to the display screen and hold it there to display a pop-up menu or other action. Press and hold is similar to clicking the right touch pad control button.

Drag

Touch the Tablet PC Pen to the screen. Without lifting the Tablet PC Pen, drag it across the screen to select text or objects.

Drag and drop

Touch the Tablet PC Pen to the screen to select an object. Without lifting the Tablet PC Pen, drag it across the screen. Lift the Tablet PC Pen to drop the object to a new location.

Replacing the pen tip

1. To replace the pen tip, pinch the tip with a draw-out tool and pull it out.

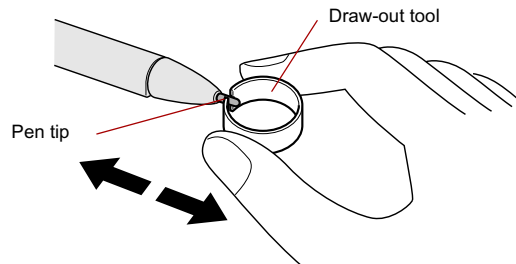

Figure 4-5 Replacing the pen tip

2. Insert a new tip into the Tablet PC Pen, flat end first, and press it to seat it securely.



- A short and worn pen point is difficult to pull out. Replace the pen point with a refill before it becomes too short to remove.
- It is recommended that you keep another pen set as a spare. You can buy replacement pen sets from your TOSHIBA authorized dealer.



Do not continue to use a broken pen tip as this may result in scratching of the LCD display panel. When the pen tip breaks replace it with one of the refills delivered with the Tablet PC Pen. When these refills have run out, you can purchase a new pen set from a TOSHIBA authorized dealer.

Removing the Reserve Pen

To remove the Reserve Pen case, follow the steps below.

1. Save your work.
2. Turn the computer's power off. Make sure the Power indicator is off.
3. Remove all cables connected to the computer.
4. Close the LCD display panel and turn the computer upside down.
5. Remove the battery pack.
6. Remove the Reserve Pen from the pen holder.

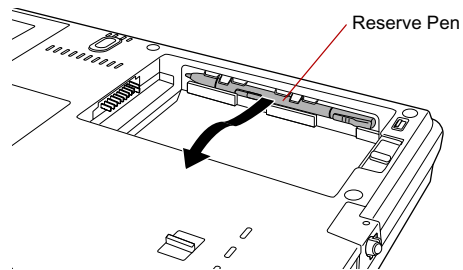

Figure 4-6 Removing the Reserve Pen

7. Reinstall the battery pack.



Refer to the [Replacing the battery pack](#) section in Chapter 6, Power and Power-Up Modes for more information on how to remove and reinstall the battery pack.

Inserting the Reserve Pen

1. Remove the battery pack.
2. Gently push the Reserve Pen into the pen holder to insert it.

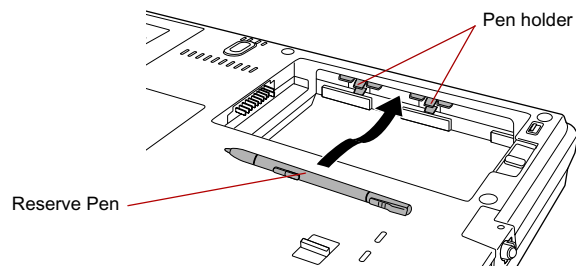

Figure 4-7 Inserting the Reserve Pen

3. Reinstall the battery pack.



Refer to the [Replacing the battery pack](#) section in Chapter 6, Power and Power-Up Modes for more information on how to remove and reinstall the battery pack.

Changing to the Tablet mode

To change from laptop mode to the Tablet mode, follow the instructions below.

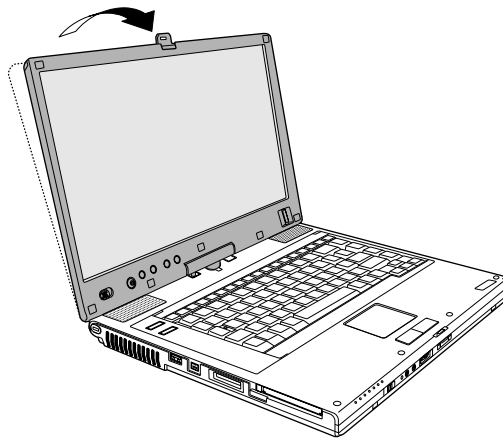

Figure 4-8 Changing to the Tablet mode (1)



- Place the computer on a stable, flat surface such as a desktop and rotate the LCD display panel slowly, holding the panel at its lower part. The LCD display panel is designed not to rotate more than 180 degrees. Rotating the LCD display panel more than 180 degrees with an excessive force will damage the panel and the computer.
- To change from Laptop Mode to Tablet Mode you must rotate the display panel 180 degrees clockwise.



Tablet mode icon Turn the LCD display panel to the direction indicated by the Tablet mode icon.



To change from Tablet Mode to Laptop Mode you must rotate the display panel 180 degrees counter-clockwise.



Laptop mode icon Turn the LCD display panel to the direction indicated by the laptop mode icon.

1. Open the LCD display panel to the upright position. Check that the angle of the keyboard and the LCD display panel is 90 degrees.
2. Rotate the LCD display panel clockwise slowly.



- When rotating LCD screen of your computer, be sure to slowly turn the screen in the proper direction, and not apply excessive force or speed.
- Do not attempt to rotate the LCD display panel past the maximum rotation point. Forcing the LCD display panel past the maximum rotation point will damage the LCD display panel.

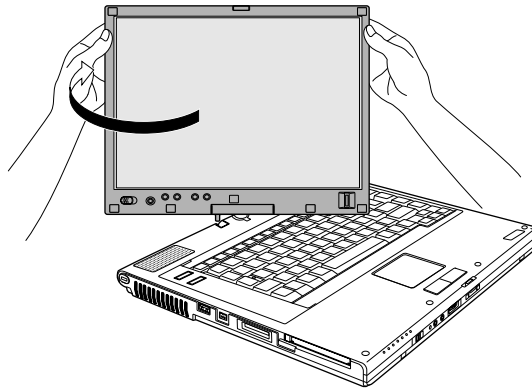

Figure 4-9 Changing to the Tablet mode (2)

3. Turn the display latch 180 degrees to its down position.
4. Close the LCD display panel slowly with display surface facing upwards.

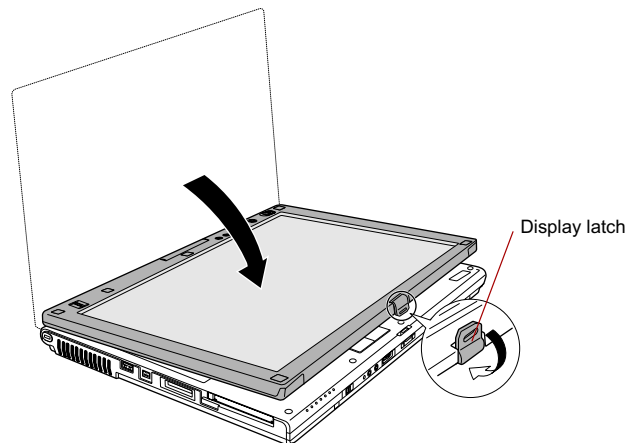

Figure 4-10 Changing to the Tablet mode (3)

5. Insert the display latch in the slit.

6. Press the LCD display panel downward softly.

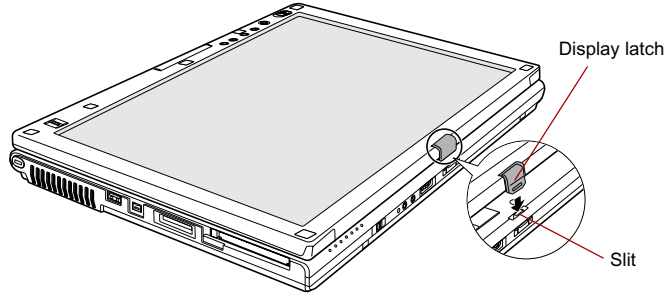

Figure 4-11 Changing to the Tablet mode (4)

Changing the screen orientation

The orientation of the computer screen can be changed to one of the following four display modes:

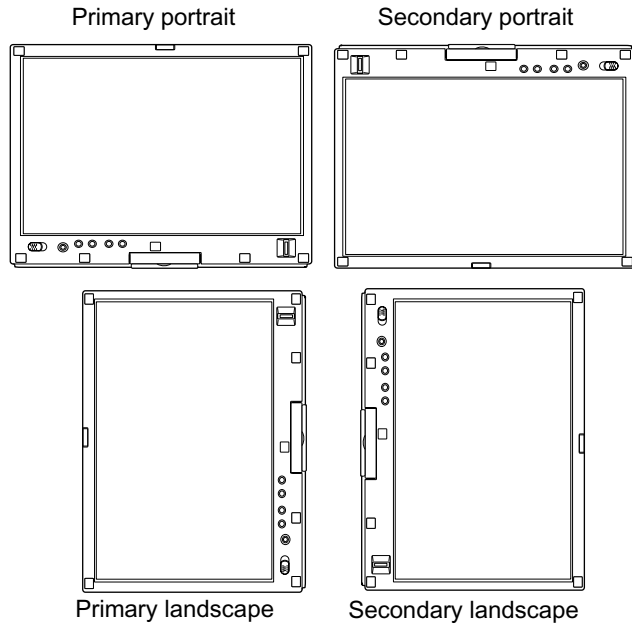

Figure 4-12 Four display modes



- *Execute the following applications on Primary landscape:*
 - 3D game software
 - 3D screen saver
 - Playback of a motion picture as would be the case using DVD-Video playback on the computer connected to an external DVD-ROM Drive.
- *The screen cannot automatically rotate in the following cases. You should first quit the running application and then rotate the screen:*
 - Running of an application that changes the screen resolution dynamically, such as a game that is running in full-screen mode.
 - DOS prompt in full-screen mode.
 - Running of 3D screen saver.



- *Do not play 3D game software or replay DVD-Video in a display mode other than Primary landscape. An abnormality will appear on the Windows screen display when you replay a DVD-Video in a mode other than Primary landscape because DVD playback software can boot only in the Primary landscape mode.*
- *An abnormality will appear on the Windows screen display when you change from Tablet Mode to Laptop Mode while a 3D screen saver is running. In this case, press any key while in Laptop Mode to deactivate the 3D screen saver.*

Method 1: Changing the screen orientation using TOSHIBA Accelerometer Utilities and TOSHIBA Rotation Utility

When the TOSHIBA Accelerometer Utilities and TOSHIBA Rotation Utility are running, changes in the orientation of the top and bottom of the screen is automatically recognized by pressing ESC/Rotation button for more than a second.

Method 2: Changing the screen orientation using Cross Function Button

1. Press the Cross Function Button for more than one second. The TOSHIBA Tablet Menu will appear.
2. Select the **Internal Monitor icon** in **Toshiba Shortcut** using the Cross Function Button and then press then Cross Function Button.
3. Select the rotation angle using Cross Function Button and then press the Cross Function Button.

Method 3: Changing the screen orientation using Task Bar

1. Right click "Change tablet and pen settings" icon in the Task Bar. Click "Change screen orientation" from the menu.
The screen orientation is set to change in the following order when purchased.

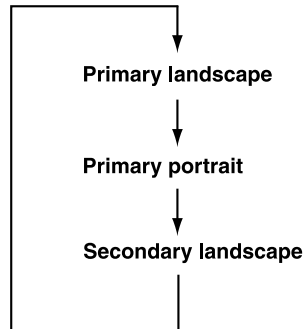

You can change the above sequence through the following procedure:

1. Double click **Change tablet and pen settings** icon in the Task Bar.
2. Click **Change** button in **Display** tab.
3. Select "changing the screen" from the Screen Orientation pull down menu and change the screen.



You can set the orientation of the desktop screen just after rotating the display from [Start]-[All Programs]-[TOSHIBA]-[Tablet PC]-[TOSHIBA Rotation Utility].

Using Accelerometer Utilities



When you shake the computer:

- Do not shake the computer too strongly as this may cause the computer to be dropped or hit those people or items around you.
- Avoid using the computer in crowded places (e.g. in commuter trains or in busy streets).
- This may cause injury to children or adults, or damage to the computer.



When the TOSHIBA HDD protection function is turned on and the Tilt function (function to start applications, etc. by waving the computer vertically or horizontally) is used, the TOSHIBA HDD protection message may be displayed on the screen. Turn off the TOSHIBA HDD protection function in order to stop such messages from displaying.

It is safer if you hold the computer with both hands horizontally as shown in the below example.

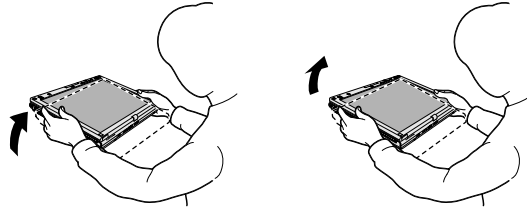

The computer is shaken horizontally.

The computer is shaken perpendicularly.

Figure 4-13 Shake the computer

Changing to the laptop mode

To change the operating mode to the Laptop Mode, follow the instructions below.

1. Press the Display latch and raise the display to the upright position carefully.
2. Rotate the display counter-clockwise slowly.
3. Turn the display latch toward you ready for the next closing of the display.

Using the Fingerprint Sensor

This product has a fingerprint utility installed for the purpose of enrolling and recognizing fingerprints. By enrolling the ID and password onto the fingerprint authentication feature, it is no longer necessary to input the password from the keyboard. Fingerprint feature enables you to:

- Logon to Windows and access a security-enabled homepage through IE (Internet Explorer).
- Files and folders can be encrypted/decrypted and third party access to them prevented.
- Disable the password-protected screen-saver when returning from power-saving (e.g., standby) mode.
- Authentication of the User Password (and, if applicable, the HDD(Hard Disk Drive) Password) when booting up the computer (Power-on Security).
- Single Sign-on feature

How to Swipe the Finger

Using the following steps when swiping fingers for fingerprint registration or authentication will help to minimize authentication failures:

Align the first joint of the finger to the center of the sensor. Lightly touch the sensor and swipe finger levelly towards you when in portrait mode, and sideways when in either landscape mode or Laptop mode.

While lightly touching the sensor, swipe the finger towards you when in portrait mode, and sideways when in either landscape mode or Laptop mode until the sensor surface becomes visible.

The following illustrations show the recommended way to swipe your finger over the fingerprint sensor.

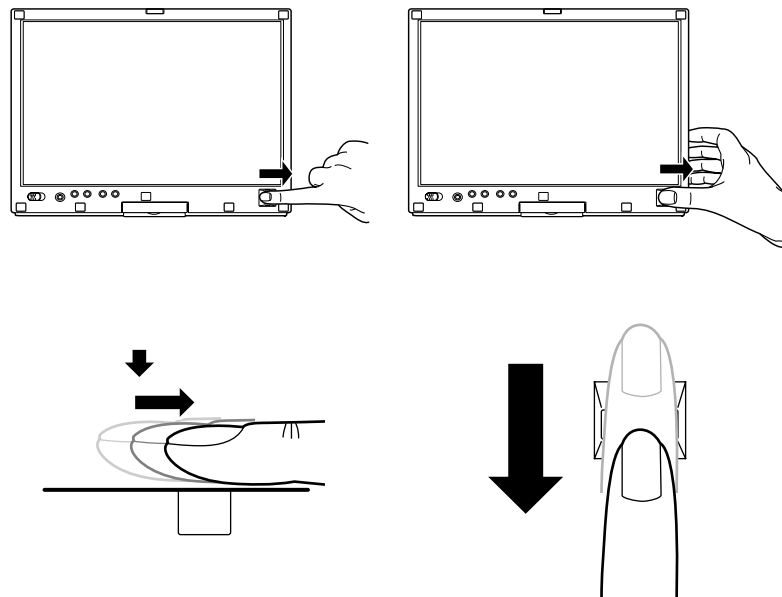

Figure 4-14 Swipe the finger



- **Avoid swiping with the finger stiff or pressed-on too hard**

Fingerprint reading may fail if the center of the fingerprint is not touching on the sensor, or when finger is swiped while pressing hard. Make sure that the center of the fingerprint is touching the sensor before swiping.

- **Always confirm the center of the fingerprint whirl so that it is swiped along the centerline of the sensor.**

- **When fingerprint reading is not successful**

There is a possibility of authentication failures if the finger is swiped too quickly or too slowly. Follow the onscreen instructions to adjust the speed of the swipe.

Points to note about the Fingerprint Sensor

Failure to follow these guidelines might result in (1) damage to the sensor or cause sensor failure, (2) finger recognition problems, or lower finger recognition success rate.

- Do not scratch or poke the sensor with your nails or any hard or sharp objects.
- Do not press the sensor strongly.
- Do not touch the sensor with a wet finger or any wet objects. Keep sensor surface dry and free of water vapor.
- Do not touch the sensor with a soiled finger. Minute foreign particles on a soiled or dirty finger may scratch the sensor.
- Do not paste stickers or write on the sensor.
- Do not touch the sensor with a finger or any object that has a build-up of static electricity on it.

Observe the following before you place your finger on the sensor whether for fingerprint enrollment/registration or recognition.

- Wash and dry your hands thoroughly.
- Remove static electricity from your fingers by touching any metal surface. Static electricity is a common cause of sensor failures, especially when the weather is dry.
- Clean the sensor with a lint-free cloth. Do not use detergent to clean the sensor.
- Avoid the following finger conditions for enrollment or recognition as they may result in fingerprint enrollment errors or a drop in the fingerprint recognition success rate
 - Soaked or swollen finger (e.g. after taking bath)
 - Injured finger
 - Wet finger
 - Soiled or oily finger
 - Extremely dry skin condition on finger

Observe the following to improve the fingerprint recognition success rate.

- Enroll two or more fingers.
- Enroll additional fingers if recognition failure occurs often using enrolled fingers.
- Check your finger condition. Changed conditions, such as injured, rough, extremely dry, wet, soiled, dirty, oily, soaked, swollen fingers, may lower the recognition success rate. Also if the fingerprint is worn down or the finger becomes thinner or fatter, the recognition success rate may be lowered.
- The fingerprint for each finger is different and unique. Please ensure that only the registered or enrolled fingerprint or fingerprints are used for identification.
- Check sliding position and speed (see the drawing and information on the following pages).

How to Delete the Fingerprint Data

Saved fingerprint data is stored in non-volatile memory inside the fingerprint sensor. If you hand over the computer to others, or dispose of it, it is recommended that you perform the following operations.

1. Click **start**, point to **All Programs**, point to **Protector Suite QL** and click **Control Center**.
2. The **Protector Suite Software** screen is displayed.
3. Click **Fingerprints** and click **Delete**.
4. Click **Settings** and click **Fingerprint Storage Inspector**.
5. The **Fingerprint Storage Inspector** screen is displayed. If other fingerprint data is still displayed on the list, select all fingerprint data and click **Remove**.
6. Check whether all fingerprint data was deleted on the **fingerprint Storage inspector** screen.

Fingerprint Sensor Limitations

- The fingerprint sensor compares and analyzes the unique characteristics in a fingerprint.
- A warning message will be displayed when recognition is abnormal or recognition is not successful within a fixed duration.
- The recognition success rate may differ from user to user.
- Toshiba does not guarantee that this fingerprint recognition technology will be error-free.
- Toshiba does not guarantee that the fingerprint sensor will recognize the enrolled user or accurately screen out unauthorized users at all times. Toshiba is not liable for any failure or damage that might arise out of the use of this fingerprint recognition software or utility.

Points to note about the Fingerprint Utility



Backups for saved fingerprint data and saved information in the PasswordBank can be performed in Import or Export User Data under Fingerprint Software Management. However, encrypted files cannot be backed within Mysafe using this function. Instead it is recommended that you backup encrypted files to external media using standard methods such as the file copy process within Windows XP.

If Windows XP's file encryption function EFS (Encryption File System) is used to encrypt a file, the file cannot be further encrypted using the encryption function of this software.

If the fingerprint sensor and Trusted Platform Module (TPM) security are used as identification devices, install and configure the Infineon TPM Professional package first before configuring the fingerprint utility. Please refer to the **TPM (Trusted Platform Module) Installation Guide** for the installation and configuration methods for TPM.

In the help file, it is stated that this software's PasswordBank function can be used for the Internet and general applications. However, the Internet PasswordBank function in the fingerprint utility provided in this computer can only be used with IE (Internet Explorer).

Set Up Procedure

Please use the following procedure when first using fingerprint authentication.

Fingerprint Registration

Enroll the required authentication data using the "User Enrollment" Wizard.



- *The fingerprint authentication uses the same Windows logon ID and password. If the Windows logon password has not been setup, please do so before registration.*
- *Up to 21 fingerprint patterns can be registered on this sensor.*

1. Click **start**, point to **All Programs**, point to **Protector Suite QL** and click **User Enrollment Wizard**.



You can also start User Enrollment Wizard using the following method.

- *Click the Protector Suite QL icon in the Task Bar.*
- *Swipe your finger across the Fingerprint Sensor.*

2. Click **Next**.
3. The **User's Password** screen is displayed. Ensure the same Windows logon username is displayed before entering a password into the **Enter your password** field. Click **Next**.
4. The **Hints for Fingerprint Enrollment** screen is displayed. Confirm the message and that there is a checkmark in **Run Interactive Tutorial**, and click **Next**.
5. The **Correct Swipe Procedure** screen is displayed. Confirm the message and click **Next**.
6. The **Scanning Practice** screen is displayed. You can practice swiping your finger and when you have finished practicing swiping your finger, click **Next**.
7. The **User's Fingers** screen is displayed. Based on the illustration, select the finger to be recognized, and then click **Next**. Previously enrolled fingerprints would have green check marks. The fingerprint being enrolled now would have a red check mark. If any of the previously enrolled fingerprints is selected again, the latest information will be enrolled and previous information over-written.
8. The **Advanced Security** screen is displayed. Select whether to enable the security function, and click **Next**.
9. The **Finalization** screen is displayed. Click **Finish**. This completes the fingerprint registration process.

Window Logon via Fingerprint Authentication

In place of the usual Windows logon by ID and password, fingerprint authentication also allows logon to Windows.

This is useful especially when many users are using the same computer as it allows the user selection screen to be skipped.

Fingerprint Authentication Procedure

1. Start up the computer.
2. The **Logon Authorization** screen is displayed. Choose any of the enrolled fingers and swipe the fingerprint on the sensor.
If authentication is successful, the user will be logged on to Windows.



If the fingerprint authentication fails, please logon using the Windows logon password.

Please logon using the Windows logon password if the fingerprint authentication failed for three consecutive tries. To logon using the Windows logon password, enter the Windows logon password at the "Welcome" screen as normal.

A warning message will be displayed when authentication is abnormal or authentication is not successful within a fixed duration.

Fingerprint Power-on Security

General

The fingerprint authentication system can be used to replace the keyboard-based User/BIOS Password authentication system when booting up.

If you do not want to use the fingerprint authentication system for password authentication when booting up, but prefer to use the keyboard-based system instead, press the **BkSP** (backspace) key or the ESC/Rotation button when the Fingerprint Power-on Security screen is displayed. This will switch the password input screen to the keyboard-based one.



- *It is necessary to register the User Password before using the Fingerprint Power-on Security and its extended function, the Fingerprint Single Sign-on Feature. Please use TOSHIBA Password Utility to register the User Password.*
- *If you fail fingerprint authentication more than five times, you must enter the User Password or Supervisor Password manually to start the computer.*
- *When swiping, please do it slowly and at a constant speed. If this does not improve the authentication rate, please adjust the speed.*
- *If there are any changes in the environment or settings related to authorization, you will be required to provide authorization information such as a User Password (and, if applicable, the HDD(Hard Disk Drive) password).*

How to Enable Fingerprint Power-on Security Settings

It is necessary to first enroll your fingerprint with the Protector Suite QL application prior to enabling and configuring the Fingerprint Power-on Security System. Check that your fingerprint is enrolled before configuring the settings. Refer to the Manual for Fingerprint Registration/Enrollment instructions.

1. Swipe your finger across the Fingerprint Sensor.
2. MENU appears in the lower right corner of the screen. Swipe (*) your finger on the Fingerprint Sensor, and select Control Center from the MENU items.

(*). It is recommended that the keyboard cursor keys (movement) and enter key (selection) or the directional pad be used when selecting an Item from the Menu in laptop or landscape modes.

3. **The Fingerprint Software Management** screen is displayed. Click **Settings** and click **Power-on Security**.
4. **The Power-on Security** screen is displayed. Place a checkmark in Replace the power-on and hard drive passwords with the fingerprint reader and click **OK**.

Fingerprint Single Sign-on Feature

General

This is a feature that allows the user to complete the authentication for both the User/BIOS Password (and, if applicable, the HDD(Hard Disk Drive) Password) and logging onto Windows using only one fingerprint authentication when booting up. It is necessary to register the User/BIOS Password and Windows Logon Password before using the Fingerprint Power-on Security and this Fingerprint Single Sign-on Feature. Please use the TOSHIBA Password Utility to register your User/BIOS Password. If Windows Logon is not the default for your system, see Manual to register your Windows Logon Password.

Only one fingerprint authentication is required to replace the User/BIOS Password (and, if applicable, the HDD(Hard Disk Drive) Password) and the Windows Logon Password.

How to Enable Fingerprint Single Sign-on Feature

It is necessary to first enroll your fingerprint with the Protector Suite QL application prior to enabling and configuring the How to Enable Fingerprint Single Sign-on Feature. Check that the fingerprint is enrolled before configuring the settings. Refer to the Manual for Fingerprint Registration/Enrollment instructions.

1. Swipe your finger across the Fingerprint Sensor.
2. MENU appears in the lower right corner of the screen. Swipe (*) your finger on the Fingerprint Sensor, and select Control Center from the MENU items.

(*). It is recommended that the keyboard cursor keys (movement) and enter key (selection) or the directional pad be used when selecting an Item from the Menu in laptop or landscape modes.

3. **The Fingerprint Software Management** screen is displayed. Click **Settings** and click **System Settings**.
4. The **Protector Suite Settings** screen is displayed. Place a checkmark in Allow power-on security single sign-on within Enable logon support and click **OK**.

Fingerprint utility limitations

TOSHIBA does not guarantee that the Fingerprint utility technology will be completely secure or error-free. TOSHIBA does not guarantee that the Fingerprint utility will accurately screen out unauthorized users at all times. TOSHIBA is not liable for any failure or damage that might arise out of the use of the fingerprint software or utility.

Using optical disc drives

The full-size drive provides high-performance execution of CD/DVD-ROM-based programs. You can run either 12 cm (4.72") or 8 cm (3.15") CD/DVDs without an adaptor. An ATAPI interface controller is used for CD/DVD-ROM operation. When the computer is accessing a CD/DVD-ROM, an indicator on the drive glows.



Use the WinDVD application to view DVD-Video discs.

If you have a DVD-ROM&CD-R/RW drive, refer also to the [Writing CDs on DVD-ROM&CD-R/RW drive](#) section for precautions on writing to CDs.

If you have a DVD Super Multi drive, refer also to the [Writing CD/DVDs on DVD Super Multi drive](#) section for precautions on writing to CDs/DVDs.



*When the power of the optical disc drive is off, pressing the **Fn + Tab** keys will turn the power of the optical disc drive on. Furthermore, it is possible to set it to turn the power of the optical disc drive on and eject the tray at the same time.*

Loading discs

To load CD/DVDs, follow the steps below.

1. When the computer's power is on, press the eject button to open the disc tray slightly.

2. Grasp the disc tray gently and pull until it is fully opened.

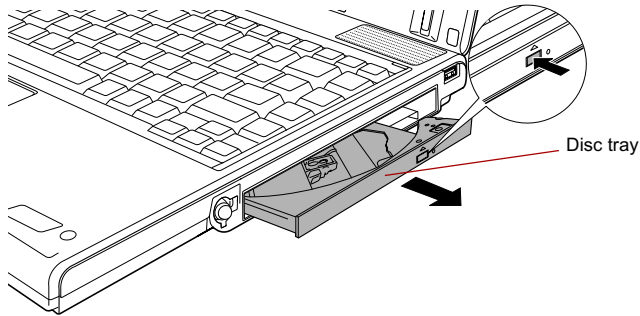

Figure 4-15 Pressing the eject button and pulling the disc tray open

3. Lay the CD/DVD, label side up, in the disc tray.

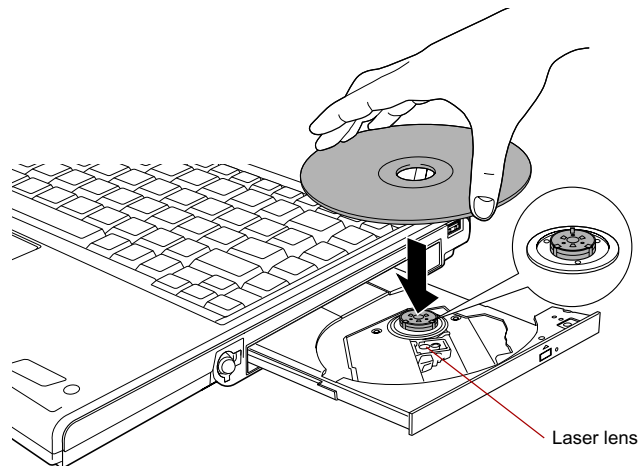

Figure 4-16 Inserting a CD/DVD



When the disc tray is fully opened, the edge of the computer will extend slightly over the CD/DVD tray. Therefore, you will need to turn the CD/DVD at an angle when you place it in the disc tray. After seating the CD/DVD, however, make sure it lies flat.



- Do not touch the laser lens or any portion of its surrounding casing as this could cause misalignment.
- Prevent foreign objects from entering the drive. Check the surface of the disc tray, especially the area behind the front edge of the disc tray, to make sure there are no such objects before closing the drive.

4. Press gently at the center of the CD/DVD until you feel it click into place. The CD/DVD should lie below the top of the spindle, flush with the spindle base.
5. Push the center of the disc tray to close it. Press gently until it locks into place.



If the CD/DVD is not seated properly when the disc tray is closed, the CD/DVD might be damaged. Also, the disc tray might not open fully when you press the eject button.

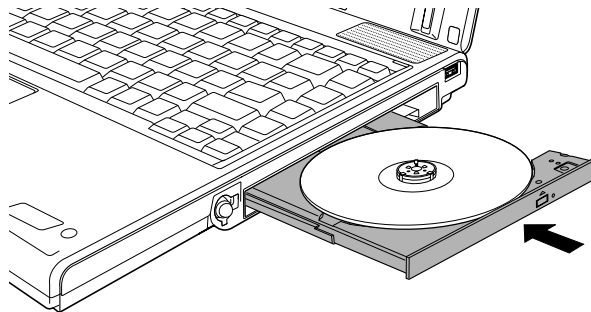

Figure 4-17 Closing the CD/DVD disc tray

Removing discs

To remove the CD/DVD, follow the steps below.



Do not press the eject button while the computer is accessing the media drive. Wait for the optical disc drive indicator to go out before you open the disc tray. Also, if the CD/DVD is spinning when you open the disc tray, wait for it to stop before you remove it.

1. To pop the disc tray partially open, press the eject button. Gently pull the disc tray out until it is fully opened.



When the disc tray pops open slightly, wait a moment to make sure the CD/DVD has stopped spinning before pulling the disc tray fully open.

2. The CD/DVD extends slightly over the sides of the disc tray so you can grasp it. Gently lift out the CD/DVD.

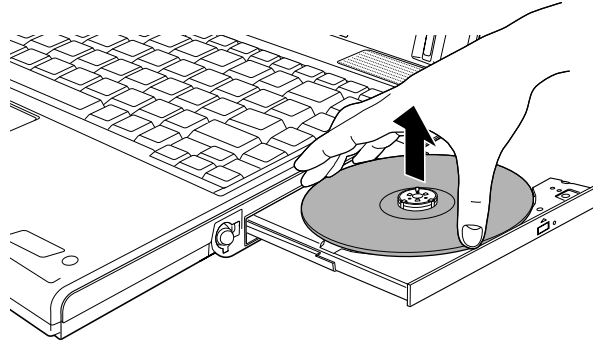

Figure 4-18 Removing a CD/DVD

3. Push the center of the disc tray to close it. Press gently until it locks into place.

How to remove CD/DVD when the disc tray will not open

Pressing the eject button will not open the disc tray when the computer power is off. If the power is off, you can open the disc tray by inserting a slender object (about 15 mm) such as a straightened paper clip into the eject hole near the eject button.

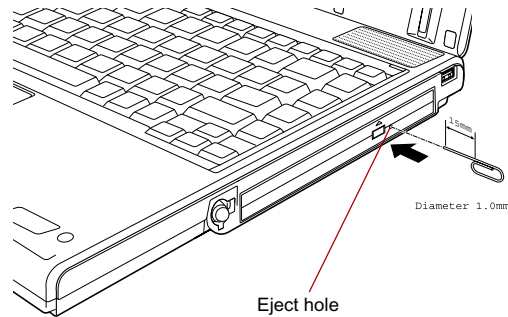

Figure 4-19 Manual release with the eject hole



Turn off the power before you use the eject hole. If the CD/DVD is spinning when you open the disc tray, the CD/DVD could fly off the spindle and cause injury.

Writing CDs on DVD-ROM&CD-R/RW drive

Depending on the type of drive installed, you may be able to write CDs. The DVD-ROM&CD-R/RW drive lets you write as well as read CD-ROMs. Observe the precautions in this section to ensure the best performance for writing CDs. For information on loading and unloading CDs refer to the [Using optical disc drives](#) section.



- Refer to the [Writable discs](#), Chapter 2 for the details about the types of writable CD/DVD discs.
- Do not turn off the power of the optical disc drive while the computer is accessing the drive. If you turn off the power, you may lose data.
- When the power of the optical disc drive is off, the disc tray will not open even if the eject button is pushed. Use the Optical Drive Power to turn the power of the optical disc drive on. Refer to Chapter 3, [Special features](#).



When writing to media using an optical drive, always connect the AC adaptor to a power plug socket or power source to ensure maximum performance. If data is written powered by the batteries, writing may sometimes fail due to low battery power and data loss may occur.

Before writing or rewriting

Please observe the following points when you write or rewrite the data.

- We recommend the following manufacturers of CD-R and CD-RW media. Media quality can affect write or rewrite success rates.

CD-R:

TAIYO YUDEN CO., LTD.
MITSUBISHI CHEMICAL CORPORATION
RICOH Co., Ltd.

Multi-Speed and High-Speed CD-RW:

MITSUBISHI CHEMICAL CORPORATION
RICOH Co., Ltd.

Ultra-Speed CD-RW:

MITSUBISHI CHEMICAL CORPORATION

TOSHIBA has confirmed the operation of CD-R and CD-RW media of the manufacturers above. Operation of other media cannot be guaranteed.

- The actual number of rewrites to CD-RW media is affected by the quality of the disc and the way it is used.
- Be sure to connect the AC adaptor when you write or rewrite.
- Be sure to close all other software programs except the writing software.
- Do not run software such as a screen saver which can put a heavy load on the CPU.
- Operate the computer at full power. Do not use power-saving features.
- Do not write while virus check software is running. Wait for it to finish, then disable virus detection programs including any software that checks files automatically in the background.
- Do not use hard disk utilities, including those intended to enhance hard disk drive access speeds. They may cause unstable operation and damage data.
- Write from the computer's hard disk drive to the CD. Do not try to write from shared devices such as a LAN server or any other network device.
- Writing with software other than Sonic RecordNow! has not been confirmed. Therefore, operation with other software cannot be guaranteed.

When writing or rewriting

Note the following when you write or rewrite a CD-R or CD-RW.

- Always copy data from the hard disk drive to the optical disc. Do not use cut-and-paste as the original data will be lost if there is a write error.
- Do not perform any of the following actions:
 - Change users in the Windows XP operating system.
 - Operate the computer for any other function, including use of a mouse or Touch Pad, closing/opening the LCD panel.
 - Start a communication application such as a modem.
 - Apply impact or vibration to the computer.
 - Install, remove or connect external devices, including the following: PC card, SD card, Memory Stick/Memory Stick Pro, xD picture card, MultiMediaCard, USB devices, external monitor, i.LINK devices and optical digital devices.
 - Open the optical disc drive.
- If the media is poor in quality, dirty or damaged, writing or rewriting errors may occur.
- Set the computer on a level surface and avoid places subject to vibration such as airplanes, trains or cars. Do not use an unstable surface such as a stand.
- Keep mobile phones and other wireless communication devices away from the computer.

Writing CD/DVDs on DVD Super Multi drive

You can use the DVD Super Multi drive to write data to either CD-R/RW or DVD-R/-R DL/-RW/+R/+R DL/+RW/-RAM discs. The following applications for writing are provided: RecordNow!, and DLA licensed by Sonic Solutions.



- Refer to the [Writable discs](#), Chapter 2 for the details about the types of writable CD/DVD discs.
- Do not turn off the power of the while the computer is accessing the drive. If you turn off the power, you may lose data.
- When the power of the optical disc drive is off, the disc tray will not open even if the eject button is pushed. Use the Optical Drive Power icon to turn the power to the drive on. Refer to Chapter 3, [Special features](#).



When writing to media using an optical drive, always connect the AC adaptor to a power plug socket or power source to ensure maximum performance. If data is written powered by the batteries, writing may sometimes fail due to low battery power and data loss may occur.

Important message

Before you write or rewrite to CD-R/RW or DVD-R/-R DL/-RW/+R/+R DL/+RW/-RAM discs, read and follow all setup and operating instructions in this section. If you fail to do so, the DVD Super Multi drive may not function properly, and you may fail to write or rewrite, lose data or incur other damage.

Disclaimer

TOSHIBA does not bear responsibility for the following:

- Damage to any CD-R/RW or DVD-R/-R DL/-RW/+R/+R DL/+RW/-RAM disc that may be caused by writing or rewriting with this product.
- Any change or loss of the recorded contents of CD-R/RW or DVD-R/-R DL/-RW/+R/+R DL/+RW/-RAM disc that may be caused by writing or rewriting with this product, or for any business profit loss or business interruption that may be caused by the change or loss of the recorded contents.
- Damage that may be caused by using third party equipment or software.

Given the technological limitations of current optical disc writing drives, you may experience unexpected writing or rewriting errors due to disc quality or problems with hardware devices. Also, it is a good idea to make two or more copies of important data, in case of undesired change or loss of the recorded contents.

Before writing or rewriting

- Based on TOSHIBA's limited compatibility testing, we suggest the following manufacturers of CD-R/RW and DVD-R/-R DL/+R/+R DL/-RW/+RW/-RAM disc. However, in no event does TOSHIBA guarantee the operation, quality or performance of any disc. Disc quality can affect write or rewrite success rates.

CD-R:

TAIYO YUDEN CO., LTD.
MITSUBISHI CHEMICAL CORPORATION
RICOH Co., Ltd.

CD-RW: (Multi-Speed and High-Speed)

MITSUBISHI CHEMICAL CORPORATION
RICOH Co., Ltd.

CD-RW: (Ultra-Speed)

MITSUBISHI CHEMICAL CORPORATION

DVD-R:

DVD Specifications for Recordable Disc for General Version 2.0
TAIYO YUDEN CO., LTD.
Matsushita Electric Industrial Co., Ltd.

DVD-R DL: (Dual Layer supported model only)

MITSUBISHI CHEMICAL CORPORATION

DVD+R:

MITSUBISHI CHEMICAL CORPORATION
RICOH Co., Ltd.

DVD+R DL: (Double Layer supported model only)

MITSUBISHI CHEMICAL CORPORATION

DVD-RW:

DVD Specifications for Recordable Disc for Version 1.1 or version 1.2
VICTOR COMPANY OF JAPAN.LIMITED
MITSUBISHI CHEMICAL CORPORATION

DVD+RW:

MITSUBISHI CHEMICAL CORPORATION
RICOH Co., Ltd.

DVD-RAM:

**DVD Specifications for DVD-RAM Disc for Version 2.0, Version 2.1
or Version 2.2**
Hitachi Maxell Ltd.



- *This drive cannot use discs that allow writing faster than 8 speed (DVD-R, DVD+R), 4 speed (DVD-RW, DVD+RW), 5 speed (DVD-RAM), 2.4 speed (DVD+R DL, Double Layer supported model only), 2 speed (DVD-R DL, Dual Layer supported model only).*
- *2.6GB and 5.2GB DVD-RAM media cannot be read from or written to.*
- *DISC created in DVD-R DL format4 (Layer Jump Recording) cannot be read.*
- If the disc is poor in quality, dirty or damaged, writing or rewriting errors may occur. Be careful to check the disc for dirt or damage before you use it.
- The actual number of rewrites to CD-RW, DVD-RW, DVD+RW or DVD-RAM is affected by the quality of the disc and the way it is used.
- There are two types of DVD-R discs: authoring and general use discs. Do not use authoring discs. Only general use discs can be written to by a computer drive.
- You can use DVD-RAM discs that can be removed from a cartridge and DVD-RAM discs designed without a cartridge.
- Other DVD-ROM drives for computers or other DVD players may not be able to read DVD-R/-R DL/-RW or DVD+R/+R DL/+RW discs.
- Data written to a CD-R/DVD-R/-R DL/DVD+R/+R DL disc cannot be deleted either in whole or in part.
- Data deleted (erased) from a CD-RW, DVD-RW, DVD+RW and DVD-RAM disc cannot be recovered. Check the content of the disc carefully before you delete it. If multiple drives that can write data to discs are connected, be careful not to delete data from the wrong drive.
- In writing to a DVD-R/-R DL/-RW, DVD+R/+R DL/+RW or DVD-RAM disc, some disc space is required for file management, so you may not be able to write the full capacity of the disc.
- Since the disc is based on the DVD standard, it might be filled with dummy data if the written data is less than about 1 GB. Even if you write only a small amount of data, it might take time to fill in the dummy data.
- DVD-RAM formatted by FAT32 cannot be read in Windows 2000 without DVD-RAM Driver Software.
- When multiple drives that can write data to discs are connected, be careful not to write to the wrong drive.
- Be sure to connect the AC adaptor before you write or rewrite.

- Before you enter standby/Hibernation Mode, be sure to finish DVD-RAM writing. Writing is finished if you can eject DVD-RAM media.
- Be sure to close all other software programs except the writing software.
- Do not run software such as a screen saver, which can put a heavy load on the CPU.
- Operate the computer in full-power mode. Do not use power-saving features.
- Do not write while virus check software is running. Wait for it to finish and then disable virus detection programs including any software that checks files automatically in the background.
- Do not use hard disk utilities, including those intended to enhance hard disk drive access speed. They may cause unstable operation and data damage.
- CD-RW (Ultra Speed +) media is not supported. If used, data may be lost or damaged.
- Write from the computer's hard disk drive to the CD/DVD. Do not try to write from shared devices such as a LAN server or any other network device.
- Writing with software other than RecordNow! and DLA for TOSHIBA are not recommended.

When writing or rewriting

Please observe/consider the following when you write or rewrite to a CD-R/RW, DVD-R/-R DL/-RW/-RAM or DVD+R/+R DL/+RW disc.

- Do not perform any of the following actions when writing or rewriting:
 - Change users in the Windows XP operating system.
 - Operate the computer for any other function, including using a mouse or Touch Pad or closing/opening the LCD panel.
 - Start a communication application such as a modem.
 - Apply impact or vibration to the computer.
 - Install, remove or connect external devices, including the following: PC card, SD card, Memory Stick/Memory Stick Pro, xD picture card, MultiMediaCard, USB devices, external monitor, i.LINK devices and optical digital devices.
 - Use the Audio/Video control button to reproduce music or voice.
 - Open the optical disc drive.
- Do not use shut down/log off and standby/hibernation while writing or rewriting.
- Make sure writing or rewriting is completed before going into standby/hibernation. Writing is completed if you can open the DVD-ROM&CD-R/RW or DVD Super Multi drive tray.
- Set the computer on a level surface and avoid places subject to vibration such as airplanes, trains, or cars. Do not use an unstable surface such as a stand.

- Keep mobile phones and other wireless communication devices away from the computer.
- Always copy data from the hard disk drive to the optical disc. Do not use cut-and-paste. The original data will be lost if there is a write error.



Discs created in DVD-R DL format4 (Layer Jump Recording) cannot be read.

RecordNow! Basic for TOSHIBA

Note the following limitations when you use RecordNow!:

- DVD-Video cannot be created using RecordNow!.
- DVD-Audio cannot be created using RecordNow!.
- You cannot use RecordNow!'s "Audio CD for Car or Home CD Player" function to record music to DVD-R/-R DL/-RW or DVD+R/+R DL/+RW discs.
- Do not use the "Exact Copy" function of RecordNow! to copy DVD-Video and DVD-ROM with copyright protection.
- DVD-RAM disc cannot be backed up with the "Exact Copy" function of RecordNow!.
- You cannot back up a CD-ROM or CD-R/RW to DVD-R/-R DL/-RW or DVD+R/+R DL/+RW using the "Exact Copy" function of RecordNow!.
- You cannot back up DVD-ROM, DVD-Video, DVD-R/-R DL/-RW or DVD+R/+R DL/+RW to CD-R/RW using the "Exact Copy" function of RecordNow!.
- RecordNow! cannot record in packet format.
- You might not be able to use the "Exact Copy" function of RecordNow! to back up a DVD-R/-R DL/-RW or DVD+R/+R DL/+RW disc that was made with other software on a different DVD-R/-R DL/-RW or DVD+R/+R DL/+RW recorder.
- If you add data to a DVD-R and DVD+R disc that you have already recorded to, you might not be able to read the added data under some circumstances. It cannot be read in 16-bit operating systems, such as Windows 98SE and Windows Me. In Windows NT4, you will need Service Pack 6 or later to read added data while in Windows 2000, you will need Service Pack 2 or later to read it. Some DVD-ROM and DVD-ROM&CD-R/RW drives cannot read added data regardless of the operating system.
- RecordNow! does not support recording to DVD-RAM discs. To record to a DVD-RAM disc, use Explorer or a similar utility.
- When you back up a DVD disc, be sure the source drive supports recording to DVD-R/-R DL/-RW or DVD+R/+R DL/+RW discs. If the source drive does not support recording to DVD-R/-R DL/-RW or DVD+R/+R DL/+RW discs, it might not be backed up correctly.
- When you back up a DVD-R, DVD-RW, DVD+R or DVD+RW, be sure to use the same type of disc.
- You cannot partially delete any data written to a CD-RW, DVD-RW or DVD+RW disc.

Data Verification

To verify that data is written or rewritten correctly, follow the steps below before you write or rewrite a Data CD/DVD.

1. Click the **Options** button () on the RecordNow! Console to open the Options panels.
2. Select Data from the left-hand menu.
3. Mark the Verify data written to the disc after burning check box in the Data Options.
4. Click the **OK** button.

DLA for TOSHIBA

Note the following limitations when you use DLA:

- This software supports only rewritable discs (DVD+RW, DVD-RW, and CD-RW). It does not support DVD+R/+R DL, DVD-R/-R DL, and CD-R discs that are not rewritable.
- DLA does not support formatting and writing to a DVD-RAM disc - these functions are performed by DVD-RAM Driver Software. Even if the DLA Format menu appears when inserting a DVD-RAM disc and right-clicking the drive icon in Windows Explorer, you should use the "DVDForm" command to format this disc. You can run "DVDForm" by clicking the Start button on the taskbar to display the Start menu and then selecting "All Programs", "DVD-RAM", "DVD-RAM Driver" and "DVDForm" sequentially.
- Do not use any discs that have been formatted with packet writing software other than DLA. Similarly, do not use any discs that have been formatted with DLA with any packet writing software other than DLA. When using a disc you are not familiar with, format it by selecting "Full Format" before using it.
- Do not use the cut-and-paste function for files and folders. A file or folder that has been cut may be lost if writing fails due to an error on the disc.
- When writing any setup files for an application to a disc formatted by DLA, and attempting to start Setup from this disc, an error may occur. In this case, please copy the files to your hard disk and then run Setup from there.

Media care

This section provides tips on protecting data stored on your CD/DVDs and floppy disks.

Handle your media with care. The following simple precautions will increase the lifetime of your media and protect the data stored on them:

CD/DVDs

1. Store your CD/DVDs in the container they came in to protect them and keep them clean.
2. Do not bend the CD/DVD.
3. Do not write on, apply a sticker to, or otherwise mar the surface of the CD/DVD that contains data.
4. Hold the CD/DVD by its outside edge or the edge on the center hole. Fingerprints on the surface can prevent the drive from properly reading data.
5. Do not expose to direct sunlight, extreme heat or cold. Do not place heavy objects on your CD/DVDs.
6. If your CD/DVDs become dusty or dirty, wipe them with a clean dry cloth. Wipe from the center out, do not wipe in a circular direction around the CD/DVD. If necessary, use a cloth dampened in water or a neutral cleaner. Do not use benzine, thinner or similar cleaner.

Floppy disks

1. Store your floppy disks in the container they came in to protect them and keep them clean. If a floppy disk is dirty, do not use cleaning fluid. Clean it with a soft damp cloth.
2. Never open the shutter or touch the magnetic surface of your floppy disk. You could permanently damage it and lose data.
3. Always handle floppy disks with care, to prevent the loss of stored data. Always apply the floppy disk label in the correct location. Never apply a new label on top of an existing one. The label could come loose and damage the floppy drive.
4. Never use a pencil for writing on a floppy disk label. Pencil lead dust could cause a system malfunction. Always use a felt-tipped pen. When writing a title on a label, first write on the label, then apply the label to the floppy disk.
5. Never put a floppy disk in a location where water or other liquid may contact it or where it is excessively damp. It could cause data loss. Never use a wet or damp floppy disk. It could damage the floppy disk drive or other devices.
6. Data may be lost if the floppy disk is twisted; bent; or exposed to direct sunlight, extreme heat or cold.
7. Do not place heavy objects on your floppy disks.
8. Do not eat, smoke, or use erasers near your floppy disks. Foreign particles inside the floppy disk's jacket can damage the magnetic surface.

9. Magnetic energy can destroy the data on your floppy disks. Keep your floppy disks away from speakers, radios, television sets and other sources of magnetic fields.

Sound System

This section describes audio controls including sound levels.

Volume Control

The Volume Control utility lets you control the audio volume in Windows for both playback and recording.

- To launch Volume Control for playback, click **start**, point to **All Programs**, point to **Accessories**, point to **Entertainment** and click **Volume Control**.
- To launch Recording Control, click **Options**, point to **Properties**, select **Realtek HD Audio input** and click **OK**.
- To view details of the Volume Control, click **Help** on the Volume Control.

Microphone level

To change the microphone gain, follow the steps below.

1. Click **start**, point to **All Programs**, point to **Accessories**, point to **Entertainment** and click **Volume Control**.
2. Click **Options** and point to **Properties**.
3. Select **Mic Volume** and click **OK**.
4. Click **Options** and select **Advanced Controls**.
5. Click **Advanced**.
6. Check the **Microphone Boost** checkbox.

TOSHIBA Mic Effect

TOSHIBA Mic Effect provides you with a hands-free environment for holding mutual communication via the Internet Protocol or Local Area Network. If you wish to communicate with someone on your computer, you can use a messenger application. However, with such an application, you would hear your own voice returning to you as echo during the communication if you did not use a headset system or headphone. TOSHIBA Mic Effect will reduce these echoes generated on your computer.

TOSHIBA Mic Effect also provides you the Microphone Array. The Microphone Array function eliminates sounds and noise originating outside the range by specifying the target range and direction of the microphone input.

For more instructions for this software, click **start**, point to **All Programs**, point to **TOSHIBA**, point to **Utilities** and click **TOSHIBA Mic Effect Help**.

Modem

This section describes how to connect and disconnect the internal modem to and from a telephone jack.

Click the icon with the secondary mouse button to display the properties menu on the screen.



- *Connection to any communication line other than an analog phone line could cause a PC system failure.*
 - *Connect the built-in modem only to ordinary analog phone lines.*
 - *Never connect the built-in modem to a digital line (ISDN).*
 - *Never connect the built-in modem to the digital connector on a public telephone or to a digital private branch exchange (PBX).*
 - *Never connect the built-in modem to a key telephone system for residences or offices.*
- *Never operate your PC on AC power during a thunderstorm. If you see lightning or hear thunder, immediately turn off the PC. An electric surge caused by the storm, may result in a system failure, loss of data or hardware damage.*

Region selection

Telecommunication regulations vary from one region to another, so you will need to make sure the internal modem's settings are correct for the region in which it will be used.



The built-in modem can be used only in specified countries and regions. Using the modem in an area not specified for use may cause a system failure. Check the specified areas carefully before using it.

To select a region, follow the steps below.

1. Click **start**, point to **All Programs**, point to **TOSHIBA**, point to **Networking** and click **Modem Region Select**.



Do not use the Country/Region Select function in the Modem setup utility in the Control Panel if the function is available. If you change the Country/Region in the Control Panel, the change may not take effect.

2. The Region Selection icon will appear in the Windows Task Bar.
3. Click the icon with the primary mouse button to display a list of regions that the modem supports. A sub menu for telephony location information will also be displayed. A check will appear next to the currently selected region and telephony location.
4. Select a region from the region menu or a telephony location from the sub-menu.
 - When you click a region it becomes the modem's region selection, and the New Location for telephony will be set automatically.

- When you select a telephony location, the corresponding region is automatically selected and it becomes the modem's current region setting.

Properties menu

Click the icon with the secondary mouse button to display properties menu on the screen.

Setting

You can enable or disable the following settings:

AutoRun Mode

The Region Select utility starts automatically when you start up the operating system.

Open the Dialing Properties dialog box after selecting region.

The dialing properties dialog box will be displayed automatically after you select the region.

Location list for region selection.

A submenu appears displaying location information for telephony.

Open dialog box, if the modem and Telephony Current Location region code do not match.

A warning dialog box is displayed if current settings for region code and telephony location are incorrect.

Modem Selection

If the computer cannot recognize the internal modem, a dialog box is displayed. Select the COM port for your modem to use.

Dialing Properties

Select this item to display the dialing properties.



If you are using the computer in Japan, the Telecommunications Business Law requires that you select Japan region mode. It is illegal to use the modem in Japan with any other selection.

Connecting

To connect the modular cable, follow the steps below.



The modular cable that comes with the computer must be used to connect the modem. Connect the end of the modular cable with the core to the computer.



■ *Connection to any communication line other than an analog phone line could cause a PC system failure.*

■ *Connect the built-in modem only to ordinary analog phone lines.*

■ *Never connect the built-in modem to a digital line (ISDN).*

■ *Never connect the built-in modem to the digital connector on a public telephone or to a digital private branch exchange (PBX).*

■ *Never connect the built-in modem to a key telephone system for residences or offices.*

■ *Never operate your PC on AC power during a thunderstorm. If you see lightning or hear thunder, immediately turn off the PC. An electric surge caused by the storm, may result in a system failure, loss of data or hardware damage.*

1. Plug one end of the modular cable into the computer's modem jack.
2. Plug the other end of the modular cable into a telephone jack.

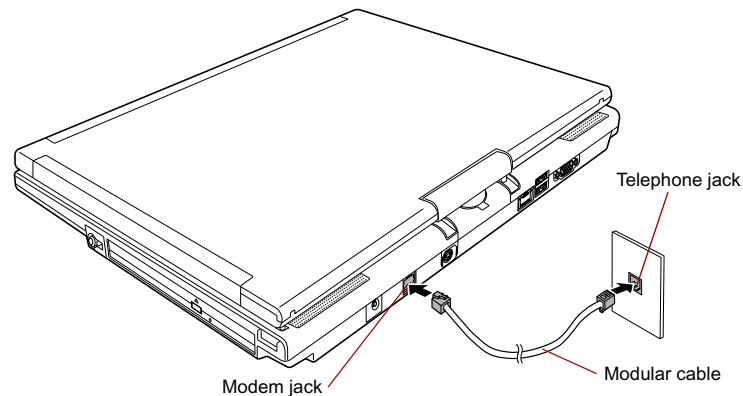

Figure 4-20 Connecting the internal modem



Do not pull on the cable or move the computer while the cable is connected.



If you use a storage device such as an optical drive or hard disk drive connected to a 16-bit PC card, you might experience the following modem problems:

- *Modem speed is slow or communication is interrupted.*
- *Skips may occur in sound.*

Disconnecting

To disconnect the internal modular cable, follow the steps below.

1. Pinch the lever on the connector in the telephone jack and pull out the connector.
2. Disconnect the cable from the computer's modem jack in the same manner.

Wireless communications

The computer's wireless communication function supports both Wireless LAN and Bluetooth devices.

All models are provided with a Wireless communication switch. Some models are equipped with both Wireless LAN and Bluetooth functions.

Wireless LAN

The Wireless LAN is compatible with other LAN systems based on Direct Sequence Spread Spectrum / Orthogonal Frequency Division Multiplexing radio technology that complies with the IEEE802.11 Wireless LAN standard (Revision A, B or G).



Do not install or remove an optional memory module while Wake-up on Wireless LAN is enabled.



- *The Wake-up on Wireless LAN function consumes power even when the system is off. Leave the AC adaptor connected while using this feature.*
- *The Wake-up on Wireless LAN function is effective only when it is connected with an Access Point. This function becomes invalid when the connection is broken.*

- Theoretical maximum speed: 54Mbps (IEEE802.11a, 802.11g)
- Theoretical maximum speed: 11Mbps (IEEE802.11b)
- Frequency Channel Selection (Revision A: 5 GHz, Revision B/G: 2.4 GHz)
- Roaming over multiple channels
- Card Power Management
- Wired Equivalent Privacy (WEP) data encryption, based on 152 bit encryption algorithm (Atheros module type).

- Wired Equivalent Privacy (WEP) data encryption, based on 128 bit encryption algorithm (Intel module type).
- Wi-Fi Protected Access (WPA).
- Advanced Encryption Standard (AES) data encryption.
- Wake-up on Wireless LAN (Intel module type).



- *The values shown above are the theoretical maximums for Wireless LAN standards. The actual values may differ.*
- *The transmission speed over the wireless LAN, and the distance over which the wireless LAN can reach, may vary depending on surrounding electromagnetic environment, obstacles, access point design and configuration, client design and software/hardware configurations. The transmission rate described is the theoretical maximum speed as specified under the appropriate standard - the actual transmission speed will be lower than the theoretical maximum speed.*

Setting

1. Please make sure that the **Wireless Communication Switch** is turned on.
2. Click **start** and select **Connect to -> Wireless Network Connection**.
3. Select **Set up a wireless network for a home or small office**.
4. Follow the wizard. You will need the name of the wireless network together with security settings. Consult the documentation accompanied with your router or ask your wireless network administrator for the settings.

Security

- TOSHIBA strongly recommend that you enable WEP (encryption) functionality, otherwise your computer will be open to illegal access by an outsider using a wireless connection. If this occurs, the outsider may illegally access your system, eavesdrop, or cause the loss or destruction of stored data.
- TOSHIBA is not liable for the loss of data due to eavesdropping or illegal access through the wireless LAN and the damage thereof.

Bluetooth wireless technology

Bluetooth[®] wireless technology eliminates the need for cables between electronic devices such as desktop computers, printers and mobile phones. You cannot use the built-in Bluetooth functions and an optional Bluetooth SD card simultaneously.

Bluetooth wireless technology has the following features:

Worldwide operation

The Bluetooth radio transmitter and receiver operate in the 2.4 GHz band, which is license-free and compatible with radio systems in most countries in the world.

Radio links

You can easily establish links between two or more devices. The link is maintained even if the devices are not within line of sight.

Security

Two advanced security mechanisms ensure a high level of security:

- Authentication prevents access to critical data and makes it impossible to falsify the origin of a message.
- Encryption prevents eavesdropping and maintains link privacy.

Bluetooth® Stack for Windows® by TOSHIBA

Please note that this software is specifically designed for the following operating systems:

- Microsoft® Windows® 2000 Professional
- Microsoft® Windows® XP

Detailed information regarding the use with these operating systems is listed below. Please refer also to the electronic information which is included with each software.



This Bluetooth® Stack is based on the Bluetooth® Version 1.1/1.2/2.0+EDR specification. TOSHIBA cannot confirm compatibility between any PC products and/or other electronic devices that use Bluetooth® other than TOSHIBA mobile computers.

Release Notes related to the Bluetooth® Stack for Windows® by TOSHIBA

1. Install:
When installing the Bluetooth® Stack for Windows® by TOSHIBA software under Windows 2000 or Windows XP, please be aware that it is not digitally signed.
2. Fax application software:
There is some fax application software that you cannot use on this Bluetooth® Stack.
3. Multi User:
On Windows XP, the use of Bluetooth is not supported in a multi-user environment. This means that, when you use Bluetooth, other users logged onto the same computer will not be able to use its Bluetooth functionality.

Product Support:

The latest information regarding Operating System support, Language Support or available upgrades can be found on our web site <http://www.toshiba-europe.com/computers/tnt/bluetooth.htm> in Europe or www.pcsupport.toshiba.com in the United States.

Wireless communication switch

You can enable or disable Wireless LAN and Bluetooth functions, with the on/off switch. No transmissions are sent or received when the switch is off. Slide the switch to the right to turn it on and to the left to turn it off.



- *Do not use the Wireless LAN (Wi-Fi) or Bluetooth functionalities near a microwave oven or in areas subject to radio interference or magnetic fields. Interference from a microwave oven or other source can disrupt Wi-Fi or Bluetooth operation.*
- *Turn Wi-Fi and Bluetooth functionalities off when near a person who may have a cardiac pacemaker implant or other medical electric device. Radio waves may affect pacemaker or medical device operation, possibly resulting in serious injury. Follow the instruction of your medical device when using any Wi-Fi or Bluetooth functionality.*
- *Always turn off Wi-Fi or Bluetooth functionality if the PC is near automatic control equipment or appliances such as automatic doors or fire detectors. Radio waves can cause malfunction of such equipment, possibly resulting in serious injury.*

Wireless communication Indicator

The wireless communication indicator indicates the status of the wireless communication functions.

Indicator status	Indication
Indicator off	Wireless communication switch is set to off. Automatic power down because of overheating. Power malfunction.
Indicator glows	Wireless communication switch is on. Wireless LAN or Bluetooth is turned on by an application.

If you used the Task Bar to disable the wireless LAN, restart the computer or perform the following procedure to re-enable it : **start, Control Panel, System, Hardware, Device Manager, Network adapters, Intel® PRO/Wireless 3945BG/3945ABG Network Connection or Atheros AR5006EG/AR5006EX Wireless Network Adapter and enable.**

LAN

The computer has built-in support for Ethernet LAN (10 megabits per second, 10BASE-T), Fast Ethernet LAN (100 megabits per second, 100BASE-TX) and Gigabit Ethernet LAN (1000 megabits per second, 1000BASE-T).

This section describes how to connect/disconnect to a LAN.



Do not install or remove an optional memory module while Wake-up on LAN is enabled.



- *The Wake-up on LAN function consumes power even when the system is off. Leave the AC adaptor connected while using this feature.*
- *The Link speed (10/100/1000 megabits per second) changes automatically depending on the network conditions (connected device, cable or noise and so on).*

LAN cable types



The computer must be configured properly before connecting to a LAN. Logging onto a LAN using the computer's default settings could cause a malfunction in LAN operation. Check with your LAN administrator regarding set-up procedures.

If you are using Gigabit Ethernet LAN (1000 megabits per second, 1000BASE-T), be sure to connect with a CAT5E cable or higher. You cannot use a CAT3 or CAT5 cable.

If you are using Fast Ethernet LAN (100 megabits per second, 100BASE-TX), be sure to connect with a CAT5 cable or higher. You cannot use a CAT3 cable.

If you are using Ethernet LAN (10 megabits per second, 10BASE-T), you can connect with a CAT3 or higher cable.

Connecting LAN cable

To connect the LAN cable, follow the steps below.



- *Connect the AC adaptor before connecting the LAN cable. The AC adaptor must remain connected during LAN use. If you disconnect the AC Adaptor while the computer is accessing a LAN, the system may hang up.*
- *Do not connect any other cable to the LAN jack except the LAN cable. Otherwise, malfunctions or damage may occur.*
- *Do not connect any power supplying device to the LAN cable that is connected to the LAN jack. Otherwise, malfunctions or damage may occur.*

1. Turn off the power to the computer and to all external devices connected to the computer.
2. Plug one end of the cable into the LAN jack. Press gently until you hear the latch click into place.

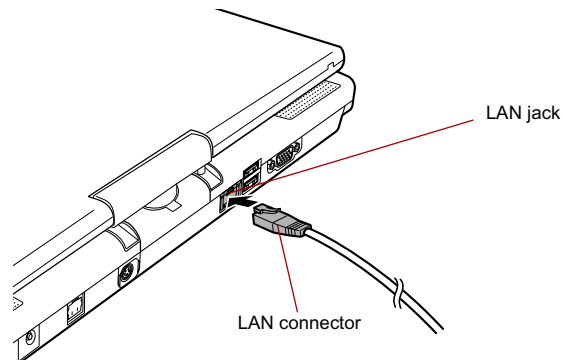

Figure 4-21 Connecting the LAN cable

3. Plug the other end of the cable into a LAN hub connector. Check with your LAN administrator before connecting to a hub.



When the computer is exchanging data with the LAN, the **LAN Active** indicator glows orange. When the computer is connected to a LAN hub but is not exchanging data, the **Link** indicator glows green.

Disconnecting LAN cable

To disconnect the LAN cable, follow the steps below.



Make sure the **LAN Active** indicator (orange LED) is out before you disconnect the computer from the LAN.

1. Pinch the lever on the connector in the computer's LAN jack and pull out the connector.
2. Disconnect the cable from the LAN hub in the same manner. Check with your LAN administrator before disconnecting from the hub.

Cleaning the computer

To help ensure long, trouble-free operation, keep the computer free of dust and use care with liquids around the computer.

- Be careful not to spill liquids into the computer. If the computer does get wet, turn the power off immediately and let the computer dry completely before you turn it on again.
- Clean the computer using a slightly damp (with water) cloth. You can use glass cleaner on the LCD display screen. Spray a small amount of cleaner on a soft, clean cloth and wipe the screen gently with the cloth.



Never spray cleaner directly onto the computer or let liquid run into any part of it. Never use harsh or caustic chemical products to clean the computer.

Moving the computer

The computer is designed for rugged durability. However, a few simple precautions taken when moving the computer will help ensure trouble-free operation.

- Before moving the computer, it is recommended that you change the function of the TOSHIBA HDD Protection. Refer to the section, [Using the Hard Disk Drive \(HDD\) Protection](#), in this chapter.
- Make sure all disk activity has ended before moving the computer. Check the **HDD** indicator on the computer.
- If a CD/DVD is in the drives, remove it. Also make sure the disc tray is securely closed.
- Turn off the power to the computer.
- Disconnect the AC adaptor and all peripherals before moving the computer.
- Close the LCD display panel. Do not pick up the computer by its display panel.
- Before carrying your computer, shut down the computer, disconnect the power cable and wait until the PC cools down. Failure to follow this instruction could result in minor injury.
- Always turn off the power when you move the computer. If the power button has a lock, set it to the lock position. Also be careful not to subject the computer to impact. Failure to follow this instruction could result in damage to computer, computer failure or loss of data.
- Never transport your computer with PC cards installed. This could cause damage to your computer and/or PC card, resulting in product failure.
- Use a carrying case when transporting the computer.
- When carrying your computer, be sure to hold it securely so that it does not fall or hit anything.
- Do not carry your computer by holding any protruding areas.

Using the Hard Disk Drive (HDD) Protection

This computer has a function for reducing the risk of damage on the hard disk drive.

Using an acceleration sensor built into the computer, TOSHIBA HDD Protection detects vibration shocks and similar signs of movement of the computer, and automatically moves the Hard Disk Drive head to a safe position to reduce the risk of damage that could be caused by head-to-disk contact.



- This function does not guarantee that the hard disk drive will not be damaged.
- The secondary hard disk drive is not supported by the TOSHIBA HDD protection function.

When vibration is detected, the following message is displayed, and the icon in the notification area of the taskbar is changed to the protection state. This message is displayed until the OK button is pressed or 30 seconds pass. When vibration subsides, the icon returns to the normal state.



Figure 4-22 TOSHIBA HDD Protection Message

Taskbar Icon

State	Icon	Description
Normal		TOSHIBA HDD Protection is enabled.
Protection		TOSHIBA HDD Protection is active. The hard disk drive head is in a safe position.
OFF		TOSHIBA HDD Protection is disabled.

TOSHIBA HDD Protection Properties

You can change the TOSHIBA HDD Protection settings by using the TOSHIBA HDD Protection Properties window. To open the window, click **start**, point to **All Programs**, point to **TOSHIBA**, point to **Utilities** and click **HDD Protection Setting**. The window can also be started from the icon on the Taskbar or from the Control Panel.

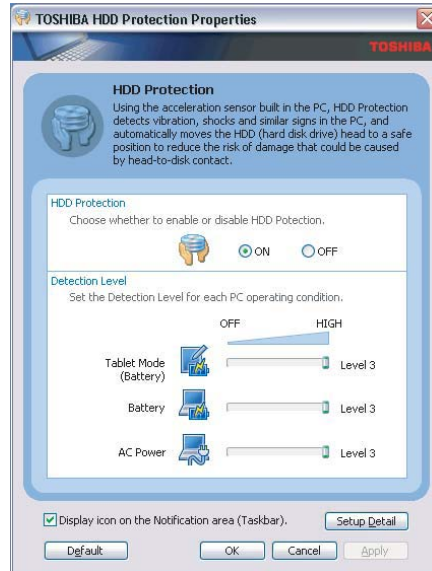

Figure 4-23 TOSHIBA HDD Protection Properties

HDD Protection

You can choose whether to enable or disable TOSHIBA HDD Protection.

Detection Level

This function can be set to four levels. The sensitivity levels in which vibrations, impacts and their similar signs are detected can be set to OFF, 1, 2 and 3 in ascending order. Level 3 is recommended for better protection of the computer. However, when the computer is used in a mobile environment or in other unstable conditions, setting the detection level to 3 could result in frequent execution of TOSHIBA HDD Protection, which will slow Hard Disk Drive reading and writing. Set a lower detection level when the speed of Hard Disk Drive reading and writing is a priority.

Different detection levels can be set depending on whether the computer is used as handheld or mobile usages, or whether it is used in a stable environment such as on a table in the workplace or at home. By setting different detection levels for the computer depending on whether it runs with the AC power (desktop) or with batteries (handheld or mobile usage), the detection level automatically switches according to the power connection mode.

Details

To open the Details window, click the Setup Detail button in the TOSHIBA HDD Protection Properties window.



Figure 4-24 Details

Detection Level Amplification

When the AC adaptor is disconnected or the lid is closed, HDD Detection assumes that the computer will be carried and sets the detection level to the maximum for 10 seconds.

TOSHIBA HDD Protection Message

Specify whether to display a message when TOSHIBA HDD Protection is active.



- *This function does not work when the computer is starting, in standby, in hibernation, in transition to hibernation, recovering from hibernation, or powered off. Be sure to not subject the computer to vibration or impact while the function is disabled.*
- *This function only operates with Windows® XP.*

Heat dispersal

To protect from overheating, the CPU has an internal temperature sensor. If the computer's internal temperature rises to a certain level, the cooling fan is turned on or the processing speed is lowered. You can select whether to control the CPU temperature by turning on the fan first, then if necessary, lowering the CPU speed. Or, by lowering the CPU speed first, then if necessary, turning on the fan. Use the Cooling Method item of the Basic Setup tab in TOSHIBA Power Saver.

When the CPU temperature falls to a normal range, the fan is turned off and the CPU operation returns to standard speed.



If the CPU temperature reaches an unacceptably high level with either setting, the system automatically shuts down to prevent damage. Data in memory will be lost.

Chapter 5

The Keyboard

The computer's keyboard layouts are compatible with a 101/102-key enhanced keyboard. By pressing some keys in combination, all the 101/102-key keyboard functions can be executed on the computer.

The number of keys on your keyboard depends on which country/region's keyboard layout your computer is configured with. Keyboards for numerous languages are available.

There are six types of keys: typewriter keys, function keys, soft keys, Hot keys, Windows special keys and keypad overlay.

Typewriter keys

The typewriter keys produce the upper- and lower-case letters, numbers, punctuation marks, and special symbols that appear on the screen.

There are some differences, however, between using a typewriter and using a computer keyboard:

- Letters and numbers produced in computer text vary in width. Spaces, which are created by a "space character," may also vary depending on line justification and other factors.
- The lowercase l (el) and the number 1 (one) are not interchangeable on computers as they are on a typewriter.
- The uppercase O (oh) and the 0 (zero) are not interchangeable.
- The **Caps Lock** function key locks only the alphabetic characters in uppercase while the shift lock on a typewriter places all keys in the shifted position.
- The **Shift** keys, the **Tab** key, and the **BkSp** (backspace) key perform the same function as their typewriter counterparts but also have special computer functions.



Never remove the key caps on your keyboard. Doing so could cause damage to the parts under the key caps.

Function keys: F1 ... F12

The function keys (not to be confused with **Fn**) are the 12 keys at the top of your keyboard. These keys function differently from other keys.



F1 through **F12** are called function keys because they execute programmed functions when pressed. Used in combination with the **Fn** key, keys marked with icons execute specific functions on the computer. Refer to the section, [Soft keys: Fn key combinations](#), in this chapter. The function executed by individual keys depends on the software you are using.

Soft keys: Fn key combinations

The **Fn** (function) is unique to TOSHIBA computers and is used in combination with other keys to form soft keys. Soft keys are key combinations that enable, disable or configure specific features.



Some software may disable or interfere with soft-key operations. Soft-key settings are not restored by the Standby feature.

Emulating keys on enhanced keyboard

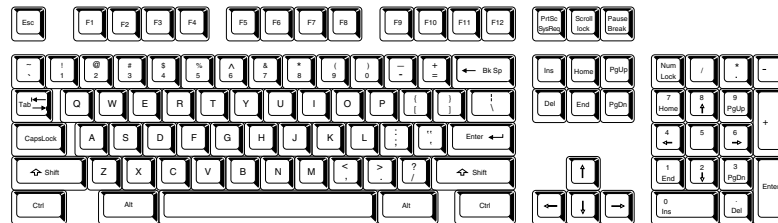
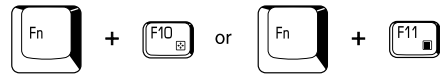

Figure 5-1 A 101-key enhanced keyboard layout

The keyboard is designed to provide all the features of the 101-key enhanced keyboard. The 101/102-key enhanced keyboard has a numeric keypad and scroll lock key. It also has additional **Enter** and **Ctrl** keys to the right of the main keyboard. Since the keyboard is smaller and has fewer keys, some of the enhanced keyboard functions must be simulated using two keys instead of one on the larger keyboard.

Your software may require you to use keys that the keyboard does not have. Pressing the **Fn** key and one of the following keys simulates the enhanced keyboard's functions.



Press **Fn + F10** or **Fn + F11** to access the integrated keypad. When activated, the keys with gray markings on the bottom edge become numeric keypad keys (**Fn + F11**) or cursor control keys (**Fn + F10**). Refer to the [Keypad overlay](#) section in this chapter for more information on how to operate these keys. The power on default for both settings is off.



Press **Fn + F12 (ScrLock)** to lock the cursor on a specific line. The power on default is off.

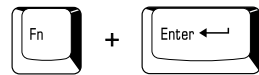

Press **Fn + Enter** to simulate **Enter** on the enhanced keyboard's numeric keypad.



Press **Fn + Ctrl** to simulate the enhanced keyboard's right **Ctrl** key.

Hot keys

Hot keys (**Fn + a function or Esc** key) let you enable or disable certain features of the computer.



Sound mute: Pressing **Fn + Esc** in a Windows environment turns sound on or off. When you press these hot keys, the current setting will change and be displayed as an icon. Pressing the Volume control dial turns Mute off. Refer to the [Right side](#) section in Chapter 2 for details.



Instant security: Press **Fn + F1** to blank the screen to prevent others from accessing your data. To restore the screen and original settings, press any key or press the Touch Pad. If a screensaver password is registered, a dialog box will appear. Enter the screensaver password and click **OK**. If no password is set, the screen will be restored when you press any key or press the Touch Pad.

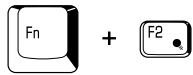

Power save mode: Pressing **Fn + F2** changes the power save mode.

If you press **Fn + F2** in a Windows environment, the settings dialog box for the Power Save Mode will be displayed. Continue holding down **Fn**, and release and press **F2** again to toggle between the settings. Release both **Fn** and **F2** to put the new setting into effect. You can also change this setting through the Profile options in TOSHIBA Power Saver.

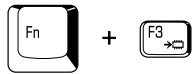

Standby: When you press **Fn + F3**, the computer enters the Standby Mode. Before entering Standby, a dialog box appears asking for your confirmation. This dialog box will not be displayed in the future if you click the check box.

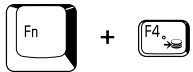

Hibernation: When you press **Fn + F4**, the computer enters the Hibernation Mode. Before entering Hibernation, a dialog box appears asking for your confirmation. This dialog box will not be displayed in the future if you click the check box.

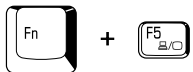

Display selection: Press **Fn + F5** to change the active display device. When you press these hot keys, a dialog box appears. Only selectable devices will be displayed. Hold down **Fn** and press **F5** again to change the device. When you release **Fn** and **F5**, the selected device will change. If you hold down these hot keys for five seconds the selection will return to the internal **LCD**.



Internal LCD screen Brightness: Pressing **Fn + F6** decreases the LCD screen brightness in decrements. When you press these hot keys, the current setting will be displayed for two seconds by an icon. You can also change this setting through the Screen brightness item of the Basic Setup tab in TOSHIBA Power Saver.



Internal LCD screen Brightness: Pressing **Fn + F7** increases the LCD screen brightness in increments. When you press these hot keys, the current setting will be displayed for two seconds by a pop-up icon. You can also change this setting through the Screen brightness item of the Basic Setup tab in TOSHIBA Power Saver.



- *The brightness level is always set at the maximum value for about 18 seconds, when the internal LCD screen turns on.*
- *LCD screen clarity increases with the brightness level.*

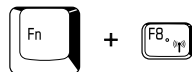

Wireless setting: If your computer has both Bluetooth and Wireless LAN functions, you can press **Fn + F8** to select which type of wireless communication you want to use. When you press these hot keys, a dialog box will appear. Continue holding down **Fn** and press **F8** to change the setting. If wireless communication is turned off, **Disabled Wireless Communication Switch** will be displayed.



If no wireless communication device is installed, no dialog box will appear.



Touch Pad: Pressing **Fn + F9** in a Windows environment enables or disables the Touch Pad function. When you press these hot keys, the current setting will change and be displayed as an icon.

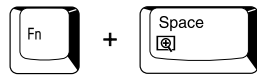

LCD screen resolution selection: Press **Fn + Space** keys to change the display resolution. Each time when you press these hot keys, the LCD screen resolution changes as follows: The available resolution depends on the model. With WXGA+, you can change the resolution between 800 × 600 and 1440 × 900 pixels.



Optical Drive Power: Press the **Fn + Tab** keys to turn the power of the optical disc drive on or eject the disc tray. A dialog box is displayed when this hotkey is pressed. To choose between the functions, press the **Tab** key while holding down the **Fn** key. The chosen function is executed when the **Fn + Tab** keys are released.



TOSHIBA Zooming Utility (reduce): To reduce the icon size on the desktop or the application window, press the **1** key while holding down the **Fn** key.

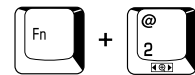

TOSHIBA Zooming Utility (enlarge): To enlarge the icon size on the desktop or the application window, press the **2** key while holding down the **Fn** key.

Fn Sticky key

You can use the TOSHIBA Accessibility Utility to make the **Fn** key sticky, that is, you can press it once, release it, and then press an "**F number**" key. To start the TOSHIBA Accessibility Utility, click **start**, point to **All Programs**, point to **TOSHIBA**, point to **Utilities** and click **Accessibility**.

Windows special keys

The keyboard provides two keys that have special functions in Windows: Windows logo key activates the **start** menu and the other, the application key, has the same function as the secondary mouse button.



This key activates the Windows **start** menu.



This key has the same function as the secondary mouse button.

Keypad overlay

Your computer's keyboard does not have an independent numeric keypad, but its numeric keypad overlay functions like one.

The keys in the center of the keyboard with gray letters make up the numeric keypad overlay. The overlay provides the same functions as the numeric keypad on the 101/102-key enhanced keyboard.

Turning on the overlays

The numeric keypad overlay can be used for numeric data input or cursor and page control.

Arrow mode

To turn on the Arrow mode, press **Fn + F10**. The Arrow mode indicator lights. Now try cursor and page control using the keys. Press **Fn + F10** again to turn off the overlay.

Numeric mode

To turn on the Numeric mode, press **Fn + F11**. The Numeric mode indicator lights. Now try numeric data entry using the keys. Press **Fn + F11** again to turn off the overlay.

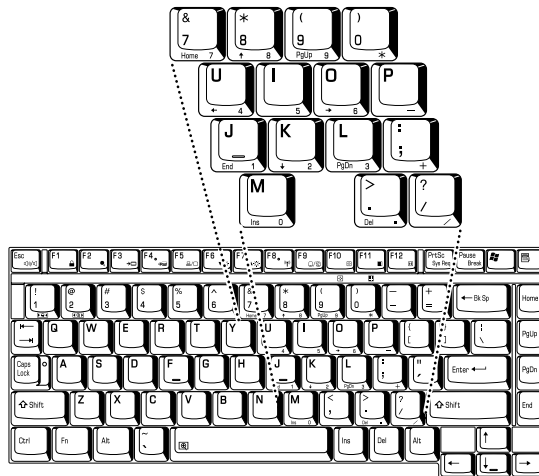

Figure 5-2 The numeric keypad overlay

Temporarily using normal keyboard (overlay on)

While using the overlay, you can temporarily access the normal keyboard without turning off the overlay:

1. Hold **Fn** and press any other key. All keys will operate as if the overlay was off.
2. Type upper-case characters by holding **Fn + Shift** and pressing a character key.
3. Release **Fn** to continue using the overlay.

Temporarily using overlay (overlay off)

While using the normal keyboard, you can temporarily use the keypad overlay without turning it on:

1. Press and hold down **Fn**.
2. Check the keyboard indicators. Pressing **Fn** turns on the most recently used overlay. If the Numeric mode indicator lights, you can use the overlay for numeric entry. If the Arrow mode indicator lights, you can use the overlay for cursor and page control.
3. Release **Fn** to return to normal keyboard operation.

Temporarily changing modes

If the computer is in **Numeric mode**, you can switch temporarily to **Arrow mode** by pressing a shift key.

If the computer is in **Arrow mode**, you can switch temporarily to **Numeric mode** by pressing a shift key.

Generating ASCII characters

Not all ASCII characters can be generated using normal keyboard operation. But, you can generate these characters using their ASCII codes.

With the overlay on:

1. Hold down **Alt**.
2. Using the overlay keys, type the ASCII code.
3. Release **Alt**, and the ASCII character appears on the display screen.

With the overlay off:

1. Hold down **Alt + Fn**.
2. Using the overlay keys, type the ASCII code.
3. Release **Alt + Fn**, and the ASCII character appears on the display screen.

Chapter 6

Power and Power-Up Modes

The computer's power resources include the AC adaptor, battery pack and internal batteries. This chapter gives details on making the most effective use of these resources including charging and changing batteries, tips for saving battery power, and power up modes.

Power conditions

The computer's operating capability and battery charge status are affected by the power conditions: whether an AC adaptor is connected, whether a battery pack is installed and what the charge level is for the battery.

Table 6-1 Power conditions

		Power on	Power off (no operation)
AC adaptor connected	Main Battery fully charged	<ul style="list-style-type: none"> Operates No charge LED: Battery green DC IN green 	<ul style="list-style-type: none"> No charge LED: Battery green DC IN green
	Main Battery partially charged or no charge	<ul style="list-style-type: none"> Operates Charge*₁ LED: Battery orange DC IN green 	<ul style="list-style-type: none"> Quick charge*₁ LED: Battery orange DC IN green
	No Main battery installed	<ul style="list-style-type: none"> Operates No charge LED: Battery off DC IN green 	<ul style="list-style-type: none"> No charge LED: Battery off DC IN green

Table 6-1 Power conditions continued

		Power on	Power off (no operation)
AC adaptor connected	2nd battery fully charged	<ul style="list-style-type: none"> Operates No charge LED: 2nd battery green DC IN green 	<ul style="list-style-type: none"> No charge LED: 2nd battery green DC IN green
	2nd battery partially charged or no charge	<ul style="list-style-type: none"> Operates Charge*₂ LED: 2nd battery orange DC IN green 	<ul style="list-style-type: none"> Quick charge*₂ LED: 2nd battery orange DC IN green
	No 2nd battery installed	<ul style="list-style-type: none"> Operates No charge LED: 2nd battery off DC IN green 	<ul style="list-style-type: none"> No charge LED: 2nd battery off DC IN green
AC adaptor not connected	Main battery charge is above low battery trigger point	<ul style="list-style-type: none"> Operates LED: Battery off DC IN off 	
	Main battery charge is below low battery trigger point	<ul style="list-style-type: none"> Operates LED: Battery flashes orange DC IN off 	
	Main battery charge is exhausted	Computer shuts down * ₃	
	No main battery installed	<ul style="list-style-type: none"> No operation *₄ LED: Battery off DC IN off 	

Table 6-1 Power conditions continued

		Power on	Power off (no operation)
AC adaptor not connected	2nd battery charge is above low battery trigger point	<ul style="list-style-type: none"> Operates LED: 2nd battery off DC IN off 	
	2nd battery charge is below low battery trigger point	<ul style="list-style-type: none"> Operates LED: 2nd battery flashes orange DC IN off 	
	2nd battery charge is exhausted	Computer shuts down *3	
	No 2nd battery is installed	<ul style="list-style-type: none"> No operation *5 LED: 2nd battery off DC IN off 	

*1 When the Slice Expansion battery is not charging.

*2 When the main battery is not charging.

*3 For the computer to shut down in hibernation mode, the hibernation feature must be enabled in two places in TOSHIBA Power Saver: the Hibernate window and the Battery Alarm item of the Alarm window. If a main battery and a Slice Expansion battery are installed, the computer does not shut down until the charge in both batteries is exhausted.

*4 When no Slice Expansion battery is installed.

*5 When no main battery is installed.



When batteries are charged, the main battery is charged first. When it is fully charged, the Slice Expansion battery is charged.

Power indicators

As shown in the above table, the **Battery**, **2nd battery**, **DC IN** and **Power** indicators on the system indicator alert you to the computer's operating capability and battery charge status.

Battery indicator

Check the **Battery** indicator to determine the status of the main battery and the **2nd battery** indicator to determine the status of the Slice Expansion battery. The following indicator lights indicate the battery status:

Flashing orange	The battery charge is low. The AC adaptor must be connected to recharge the battery.
Orange	Indicates the AC adaptor is connected and charging the battery.
Green	Indicates the AC adaptor is connected and the battery is fully charged.
No light	Under any other conditions, the indicator does not light.



*If the battery pack becomes too hot while it is being charged, the charge will stop and the **Battery** indicator will go out. When the battery pack's temperature falls to a normal range, charge will resume. This occurs whether the computer's power is on or off.*

DC IN indicator

Check the **DC IN** indicator to determine the power status with the AC adaptor connected:

Green	Indicates the AC adaptor is connected and supplying proper power to the computer.
Flashing orange	Indicates a problem with the power supply. Plug the AC adaptor into another power outlet. If it still does not operate properly, contact your dealer.
No light	Under any other conditions, the indicator does not light.

Power indicator

Check the **Power** indicator to determine the power status:

Green	Indicates power is being supplied to the computer and the computer is turned on.
Blinking orange	Indicates power is being supplied to the computer while the computer is in Standby Mode. The indicator turns on for one second and off for two seconds.
No light	Under any other conditions, the indicator does not light.

Battery types

The computer has three types of batteries:

- Battery pack
- Slice Expansion Battery (Provided with some models, or option)
- Real Time Clock (RTC) battery

Battery pack

When the AC adaptor is not connected, the computer's main power source is a removable lithium ion battery pack, also referred to in this manual as the main battery. You can purchase additional battery packs for extended use of the computer away from an AC power source.

Do not change the battery pack while the AC adaptor is connected.

Before you remove the battery pack, save your data and shut down the computer, or set the computer to Hibernation Mode. While entering Hibernation Mode, the computer saves the contents of memory to the hard disk drive. However, for safety sake, it is best to save your data manually.



- *The battery pack is a lithium ion battery, which can explode if not properly replaced, used, handled or disposed of. Dispose of the battery as required by local ordinances or regulations. Use only batteries recommended by TOSHIBA as replacements.*
- *Always use the battery pack supplied as an accessory or an equivalent battery pack specified in the User's Manual. Other battery packs have different voltage and terminal polarities. Use of non-conforming battery packs could generate smoke or cause fire or rupture, possibly resulting in serious injury.*
- *Always dispose of used battery packs in compliance with all applicable laws and regulations. Put insulating tape, such as cellophane tape, on the electrode during transportation to avoid a possible short circuit, fire or electric shock. Failure to do so could possibly result in serious injury.*

■ *Do not remove the battery pack while the computer is in Standby Mode. Data is stored in RAM, so if the computer loses power it will be lost. When the computer is powered off in Standby Mode, and the AC adaptor is not connected, the battery pack supplies power to maintain data and programs in memory. If the battery pack is completely discharged, Standby Mode will not function and the computer loses all data in memory.*

To ensure that the battery pack maintains its maximum capacity, operate the computer on battery power at least once a month until the battery pack is fully discharged. Refer to [Extending battery life](#) in this chapter for procedures. If the computer is continuously operated on AC power through an AC adaptor for an extended period, more than a month, the battery may fail to retain a charge. It may not function efficiently over the expected life of the battery and the **Battery** indicator may not indicate a low-battery condition.

Slice Expansion Battery (Provided with some models, or option)

The Slice Expansion Battery is included with some models, or can be purchased separately as an optional accessory.

For detailed information on this battery, refer to [Slice Expansion Battery](#) section in Chapter 3.



The Slice Expansion Battery is a lithium ion battery, which can explode if not properly replaced, used, handled or disposed of. Dispose of the battery as required by local ordinances or regulations. Use only batteries recommended by TOSHIBA as replacements.

Real Time Clock (RTC) battery

The Real Time Clock (RTC) battery provides power for the internal real time clock and calendar. It also maintains the system configuration.

If the RTC battery becomes completely discharged, the system loses this data and the real time clock and calendar stop working. The following message appears when you turn on the power:



```
**** RTC battery is low or CMOS checksum is
inconsistent ****
Press [F1] key to set Date/Time.
```

You can change the Real Time Clock settings by pressing the **F1** key. Refer to Chapter 8 [Troubleshooting](#) for detail.



The computer's RTC battery is a Ni-MH battery and should be replaced only by your dealer or by a TOSHIBA service representative. The battery can explode if not properly replaced, used, handled or disposed of. Dispose of the battery as required by local ordinances or regulations.



The RTC battery does not charge while the computer is turned off even if the AC adapter is attached.

Care and use of the battery pack

The battery pack is a vital component of portable computing. Taking proper care of it will help ensure longer operating time on battery power as well as a longer life for your battery pack. Follow the instructions in this section carefully to ensure safe operation and maximum performance.

Refer to the enclosed Instruction Manual for Safety & Comfort for detailed precautions and handling instructions.



- *Make sure the battery is securely installed in the computer before attempting to charge the battery pack. Improper installation could generate smoke or fire, or cause the battery pack to rupture.*
- *Keep the battery pack out of reach of infants and children. It can cause injury.*



- *Use only battery packs recommended by TOSHIBA as replacements.*
- *Charge the battery pack only in an ambient temperature between 5 and 35 degrees Celsius. Otherwise, the electrolyte solution might leak, battery pack performance might deteriorate and the battery life might be shortened.*
- *Never install or remove the battery pack without first turning off the power and disconnecting the AC adaptor. Never remove the battery pack while the computer is in Standby Mode. Data will be lost.*



- *Never remove the battery pack while the Wake-up on LAN function is enabled. Data will be lost. Before you remove a battery pack, disable the Wake-up on LAN function.*
- *Never remove the battery pack while the Wake-up on Wireless LAN function is enabled. Data will be lost. Before you remove a battery pack, disable the Wake-up on Wireless LAN function.*
- *To ensure the battery pack maintains maximum capacity, operate the computer on battery power once a week until the battery pack is fully discharged. Refer to the section [Extending battery life](#) in this chapter for procedures. If the computer is continuously operated on AC power for an extended period, more than a week, the battery might fail to retain a charge. It might not function efficiently over the expected life of the battery pack and the **Battery** indicator might not indicate a low-battery condition.*
- *After the battery pack is charged, avoid leaving the AC adaptor connected and the computer turned off for more than a few hours at a time. Continuing to charge a fully-charged battery pack can damage the battery.*

Charging the batteries

When the power in the battery pack becomes low, the **Battery** indicator flashes orange indicating that only a few minutes of battery power remain. If you continue to use the computer while the **Battery** indicator flashes, the computer enables Hibernation Mode (so you don't lose data) and automatically turns off.



The computer enters Hibernation mode only if Hibernation is enabled in two places: the Hibernation tab in Power Options and Setup Actions tab in TOSHIBA Power Saver.

You must recharge a battery pack when it becomes discharged.

Procedures

To recharge a battery pack while it is installed in the computer, connect the AC adaptor to the DC IN 15V jack and plug the other end into a working outlet.

The **Battery** indicator glows orange when the battery is being charged.



Use only the computer connected to an AC power source or the optional TOSHIBA Battery charger to charge the battery pack. Never attempt to charge the battery pack with any other charger.

Time

The following table shows the approximate time required to fully charge a discharged battery.

Charging time (hours)

Battery type	Power on	Power off
Battery pack (4700mAh)	about 3.0 to 13.0	about 3.0
Slice Expansion Battery (4000mAh)	about 3.0 to 9.5	about 3.0
RTC battery	8	Doesn't charge



The charging time when the computer is on is affected by ambient temperature, the temperature of the computer and how you use the computer. If you make heavy use of external devices, for example, the battery might scarcely charge at all during operation. Refer also to the section [Maximizing battery operating time](#).

Battery charging notice

The battery may not charge right away under the following conditions:

- The battery is extremely hot or cold. If the battery is extremely hot, it might not charge at all. To ensure the battery charges to its full capacity, charge the battery at room temperature of 10° to 30°C (50° to 88°F).

- The battery is nearly completely discharged. Leave the AC adaptor connected for a few minutes and the battery should begin charging.

The **Battery** indicator may show a rapid decrease in battery operating time when you try to charge a battery under the following conditions:

- The battery has not been used for a long time.
- The battery has completely discharged and been left in the computer for a long time.
- A cool battery is installed in a warm computer.

In such case, follow the steps below.

1. Fully discharge the battery by leaving it in the computer with the power on until the power automatically shuts off.
2. Connect the AC adaptor to the DC IN 15V jack of the computer, and the AC adaptor into power outlet.
3. Charge the battery until the **Battery** indicator glows green.

Repeat these steps two or three times until the battery recovers normal capacity.



Leaving the AC adaptor connected will shorten battery life. At least once a month, run the computer on battery power until the battery is fully discharged, then recharge the battery.

Monitoring battery capacity

Remaining battery power can be monitored in TOSHIBA Power Saver.



- *Wait at least 16 seconds after turning on the computer before trying to monitor the remaining operating time. The computer needs this time to check the battery's remaining capacity and to calculate the remaining operating time, based on the current power consumption rate and remaining battery capacity. The actual remaining operating time may differ slightly from the calculated time.*
- *With repeated discharges and recharges, the battery's capacity will gradually decrease. Therefore, an often used, older battery will not operate for as long as a new battery even when both are fully charged. In this case, TOSHIBA Power Saver will indicate a 100% charge for both the old and new battery, but the displayed estimated time remaining will be shorter for the older battery.*

Maximizing battery operating time

A battery's usefulness depends on how long it can supply power on a single charge.

How long the charge lasts in a battery depends on:

- How you configure the computer (for example, whether you enable battery-power saving options). The computer provides a battery save mode, which can be set in TOSHIBA Power Saver, to conserve battery power. This mode has the following options:
 - CPU Processing speed

- Screen brightness
- Cooling Method
- System standby
- System Hibernation
- Monitor Power off
- HDD Power off
- How often and how long you use the hard disk, optical disc and the floppy disk drive.
- How much charge the battery contained to begin with.
- How you use optional devices, such as a PC card, to which the battery supplies power.
- Enabling Standby Mode conserves battery power if you are frequently turning the computer off and on.
- Where you store your programs and data.
- Closing the LCD display panel when you are not using the keyboard saves power.
- Operating time decreases at low temperatures.
- The condition of the battery terminals. Make sure the battery terminals stay clean by wiping them with a clean dry cloth before installing the battery pack.

Retaining data with power off

When you turn off your computer with fully charged batteries, the batteries retain data for the following approximate time periods:

Retention time

Battery type	State and Retention Time
Battery pack (4700mAh)	about 5 days (Standby Mode) about 60 days (Boot mode)
Slice Expansion Battery (4000mAh)	about 5 days (Standby Mode) about 50 days (Boot mode)
RTC battery	30 days

Extending battery life

To maximize the life of your battery pack:

- At least once a month, disconnect the computer from a power source and operate it on battery power until the battery pack fully discharges. Before doing so, follow the steps below.
 1. Turn off the computer's power.
 2. Disconnect the AC adaptor and turn on the computer's power. If it does not turn on go to step 4.

3. Operate the computer on battery power for five minutes. If the battery pack has at least five minutes of operating time, continue operating until the battery pack is fully discharged. If the **Battery** indicator flashes or there is some other warning to indicate a low battery, go to step 4.
4. Connect the AC adaptor to the computer and the power cord to a power outlet. The **DC IN** indicator should glow green, and the **Battery** indicator should glow orange to indicate that the battery pack is being charged. If the **DC IN** indicator does not glow, power is not being supplied. Check the connections for the AC adaptor and power cord.
5. Charge the battery pack until the **Battery** indicator glows green.

- If you have extra battery packs, rotate their use.
- If you will not be using the system for an extended period, more than one month, remove the battery pack.
- Disconnect the AC adaptor when the battery is fully charged. Overcharging makes the battery hot and shortens life.
- If you are not going to use the computer for more than eight hours, disconnect the AC adaptor.
- Store spare battery packs in a cool dry place out of direct sunlight.

Replacing the battery pack

The battery pack is classified as a consumable item.

The operating life of the battery pack will gradually reduce through repeated charging and discharging. It will need to be replaced when it reaches the end of its operating life.

You might also replace a discharged battery pack with a charged spare when you are operating your computer away from an AC power source. This section explains how to remove and install the battery pack.

To remove a discharged battery pack, follow the steps below.



- *Do not remove the battery pack while the computer is in Standby Mode. Data is stored in RAM, so if the computer loses power it will be lost.*
- *In Hibernation Mode, data will be lost if you remove the battery pack or disconnect the AC adaptor before the save is completed. Wait for the **HDD** indicator to go out.*
- *Do not touch the battery release latch while holding the computer or the battery pack might fall out due to the unintentional release of the battery release latch and cause injuries.*

1. Save your work.
2. Turn the computer's power off. Make sure the **Power** indicator is off.
3. Remove all cables connected to the computer.
4. Close the LCD display panel and turn the computer upside down.

- Slide the battery safety lock towards the release (🔒) position to make the battery release latch movable.

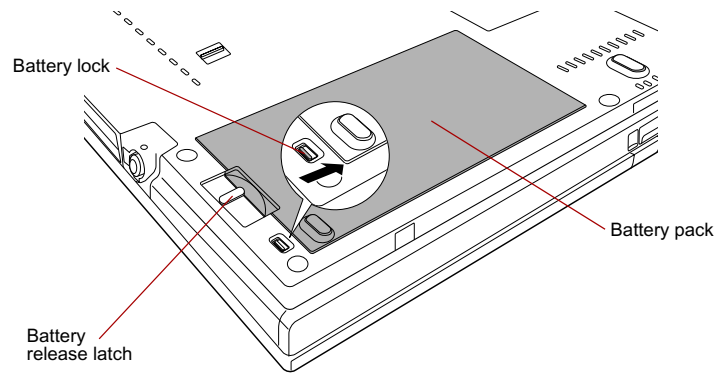

Figure 6-1 Releasing the battery pack (1)

- Slide the battery release latch (1) to free the battery pack for removal (2), then slide out the battery pack.

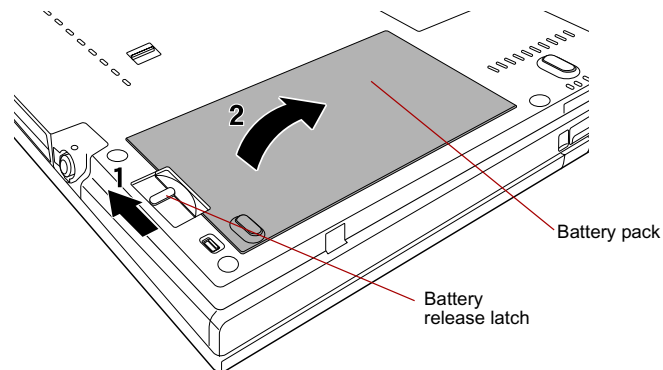



Figure 6-2 Releasing the battery pack (2)

To install a battery pack, follow the steps below.



Do not touch the battery release latch while holding the computer. Or you may get injured by the dropped battery pack by unintentional release of the battery release latch.

- Insert the battery pack (1).

8. Make sure that the battery pack is securely in place and the battery lock (2) is in the lock position ().

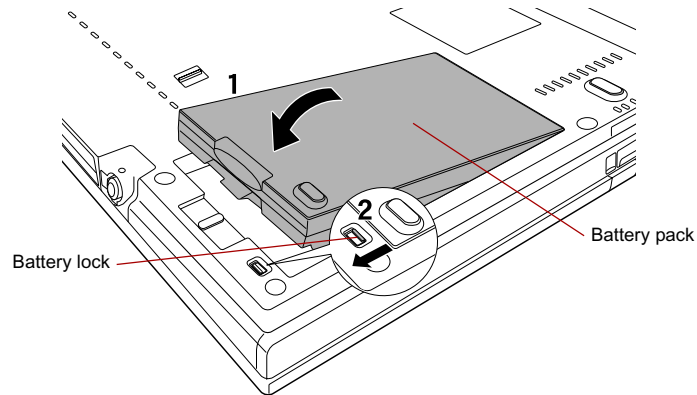

Figure 6-3 Securing the battery pack

9. Return your computer to the upright position.

TOSHIBA Password Utility

The TOSHIBA Password Utility provides two levels of password security: User and Supervisor.



Passwords set in the TOSHIBA Password Utility are different from the Windows password.

User Password

To start the utility, point to or click the following items:

start -> All Programs -> TOSHIBA -> Utilities -> Password Utility

The User Password dialog box contains two main fields: **User Password** and **User Token**.

User authentication may be required to validate user rights when using "TOSHIBA Password Utility" to delete or change passwords, or create tokens, etc.

User Password field

■ **Set** (button)

Click this button to register a password of up to 50 characters. After a password is set, you will be prompted to enter it when you start the computer. Check "Set the same string simultaneously as the HDD User Password" when setting the HDD User Password.



■ After you set the password, a dialog box will be displayed asking whether you want to save it to a floppy disk or other media. If you forget the password, you can open the password file on another computer. Be sure to keep the media in a safe place.

■ When entering the character string to register the password, enter from the keyboard character by character and do not enter as ASCII code or copy-and-paste the character string. In addition, ensure that the registered password is correct by outputting the character string to the password file.

■ **Delete** (button)

Click this button to delete a registered password. Before you can delete a password, you must first enter the current password correctly or insert a proper token. Please use BIOS Setup to change or delete the HDD Passwords or to set the HDD Master Password.

■ **Change** (button)

Click this button to change a registered password. Before you can change a password, you must first enter the current password correctly or insert a proper token. Please use BIOS Setup to change or delete the HDD Passwords or to set the HDD Master Password.

■ **Owner String** (text box)

You can use this box to associate text with the password. After you enter text, click **Apply** or **OK**. When the computer is started, this text will be displayed together with the prompt asking you to enter a password.



■ If you forget your HDD User Password, TOSHIBA will NOT be able to assist you, and your HDD will be rendered COMPLETELY and PERMANENTLY INOPERABLE. TOSHIBA will NOT be held responsible for any loss of any data, any loss of use or access to your HDD, or for any other losses to you or any other person or organization that result from the loss of access to your HDD. If you can't accept this risk, don't register the HDD User Password.

■ When saving the HDD User Password shut down or restart the computer. If the computer is not shut down or restarted, the saved data may not be correctly reflected. For more information on shutting down or restarting the computer, refer to [Turning on the power](#) in Chapter 1.



Refer to [Starting and Ending the BIOS Setup Program](#) section in Chapter 7 for more information.

User Token field

- **Create** (button)

You can use an SD card token, instead of entering the password. After you have registered a password, insert an SD card in SD card slot and click **Create**. You can use an SD card of any capacity, but it must be formatted correctly.

If an unformatted card or one with an incompatible format is inserted, you will be prompted to format it with a tool named TOSHIBA SD Memory Card Format. To start the format tool, point to or click the following items:

start -> All Programs -> TOSHIBA -> Utilities -> SD Memory Card Format



When you format an SD Memory card, all data will be deleted. Be sure to save data on the card to other media before you format the card.

- **Disable** (button)

Click this button to invalidate the token. You cannot re-validate old tokens, but you can use the same SD cards to create new tokens.



After using the token created for authentication, do not leave it inserted in the SD card slot, ensure that the token is removed from the slot and stored in a safe location. If the token is left in the slot, there is a danger of theft or a third party using it for authentication and operating the user's computer (resulting in extraction, modification or deletion of data) when the user is not at their desk.

Supervisor Password

If you set a Supervisor Password, some functions might be restricted when a user logs on with the User Password. To set a Supervisor Password, execute the file TOSPU.EXE. The file is located at:

C:\Program Files\Toshiba\Windows Utilities\SVPWTool\TOSPU.EXE

This utility lets you do the following:

- Register, delete or change the Supervisor Password.
- Create or invalidate a Supervisor Password token.



This function in the TOSHIBA Password Utility lets you invalidate only supervisor tokens or all tokens, including user and supervisor tokens.

- Specify restrictions for general users.

Starting the computer by password

If you have already registered a password, there are three ways to start the computer:

- Insert an SD card token before you turn on the computer. The computer will start normally, without displaying a password prompt.
- Swipe your fingerprint on the sensor if you have already registered the fingerprint with the Fingerprint utility and enabled Fingerprint System Boot Authentication. If you would not like to swipe your finger or cannot authenticate the fingerprint for some reasons, push the **BkSp** key to skip the fingerprint authentication screen. You can try to swipe the fingerprint up to five times. If you failed fingerprint authentication five times, you must enter the password manually to start the computer.
- Log on with the Tablet PC Pen when in Tablet mode. Refer to [Tablet mode](#) section in this chapter.
- Enter the password manually.



The password is necessary only if the computer was Shutdown and Hibernation in boot mode.

It is not needed in Standby and Restart.

To enter a password manually, follow these steps:

1. Turn on the power as described in Chapter 1, [Getting Started](#). The following message will appear in the LCD:



Password=

2. Enter the Password.
3. Press **Enter**.



If you enter the password incorrectly three times in a row, the computer shuts off. In this case, you must turn the computer back on to retry password entry.

Tablet mode

Enter your password by tapping the on-screen keyboard using the Tablet PC Pen.

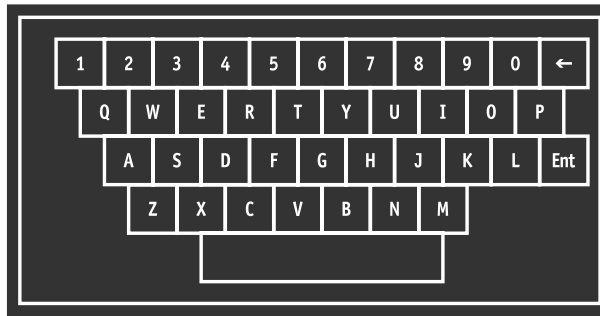

Figure 6-4 On-screen keyboard

- The beep sounds when tapping the on-screen keyboard with the Tablet PC Pen. An * (asterisk) is displayed after "Password =" and one character is input for every tapping.



Register your password to the computer in the laptop mode using the standard keyboard. Refer to [TOSHIBA Password Utility](#), in this chapter for the detail.

Power-up modes

The computer has the following power-up modes:

- **Boot:** Computer shuts down without saving data. Always save your work before you turn the computer off in boot mode.
- **Hibernation:** Data in memory is saved to the hard disk drive.
- **Standby:** Data is maintained in the computer's memory.



Refer also to the sections [Turning on the power](#) and [Turning off the power](#) in Chapter 1, *Getting Started*.

Windows utilities

You can configure various settings associated with both Standby Mode and Hibernation Mode within TOSHIBA Power Saver.

Hot keys

You can use hot keys **Fn + F3** to enter Standby Mode and **Fn + F4** to enter Hibernation. Refer to Chapter 5, [The Keyboard](#) for details.

Panel power on/off

You can set up your computer so that power turns off automatically when you close the display panel. When you open the panel, power will be turned on in Standby Mode or Hibernation Mode but not in boot mode.



If the panel power off function is enabled and you manually shut down Windows, do not close the computer's LCD display panel until the shut down process has been completed.

System Auto Off

This feature turns the system off automatically if it is not used for a set duration. The system shuts down in Standby Mode or Hibernation Mode in Windows.

Chapter 7

HW Setup & BIOS Setup

This chapter explains how to use TOSHIBA HW Setup program to configure your computer, and provides information on setting up the Execute-Disable Bit Capability and TPM.

Accessing HW Setup

To run HW Setup, click **start**, click **Control Panel**, click **Printers and Other Hardware** and select **TOSHIBA HWSetup**.

HW Setup window

The HW Setup window contains the following tabs: General, Display, Boot Priority, Keyboard, CPU, LAN, Device Config and USB.

There are also three buttons: **OK**, **Cancel** and **Apply**.

OK	Accepts your changes and closes the HW Setup window.
Cancel	Closes the window without accepting your changes.
Apply	Accepts all your changes without closing the HW Setup window.

General

This window displays the BIOS version and contains two buttons: **Default** and **About**.

Default	Return all HW Setup values to the factory settings.
About	Display the HW Setup version.

Setup

This field displays **BIOS Version** and date.

Display

This tab lets you customize your computer's display settings for either the internal LCD screen or an external monitor.

Power On Display

Lets you select the display to be used when the computer is booted (This setting is only available on Standard VGA mode and is not available on Windows Desktop properties).

Auto-Selected	Selects an external monitor if one is connected. Otherwise, it selects the internal LCD (Default).
LCD + Analog RGB	Selects both the internal LCD and external monitor for simultaneous display.
System LCD Only	Selects the internal LCD even if the external monitor is connected.



If the connected external monitor does not support the computer's current video mode, selecting the LCD + Analog RGB mode will not display any image on the external monitor.

When Windows starts up, the screen will be displayed on the external monitor if it was connected when the notebook was previously switched off and is still connected when the computer is switched on. Otherwise, the screen will be displayed on the internal LCD.

Boot Priority

Boot Priority Options

This option sets the priority for booting the computer. Select from the following settings:

HDD -> FDD -> CD-ROM -> LAN	The computer looks for bootable files in the following order: HDD, floppy disk drive*1, CD-ROM*2 and LAN (Default).
FDD -> HDD -> CD-ROM -> LAN	The computer looks for bootable files in the following order: floppy disk drive*1, HDD, CD-ROM*2 and LAN.
HDD -> CD-ROM -> LAN -> FDD	The computer looks for bootable files in the following order: HDD, CD-ROM*2, LAN and floppy disk drive*1.
FDD -> CD-ROM -> LAN -> HDD	The computer looks for bootable files in the following order: floppy disk drive*1, CD-ROM*2, LAN and HDD.
CD-ROM -> LAN -> HDD -> FDD	The computer looks for bootable files in the following order: CD-ROM*2, LAN, HDD, floppy disk drive*1.
CD-ROM -> LAN -> FDD -> HDD	The computer looks for bootable files in the following order: CD-ROM*2, LAN, floppy disk drive*1 and HDD.

You can override the settings and manually select a boot device by pressing one of the following keys while the computer is booting:

U	Selects the USB floppy disk drive.
N	Selects the network.
1	Selects the built-in HDD.
C	Selects the CD-ROM*2.
M	Selects the USB Memory.

*1 The floppy disk drive will be used to start the computer when there is a bootable disk contained in the external drive. If SD memory is installed as well, the external floppy disk drive will be checked first, followed by the SD memory device itself.

*2 The optical disc drive will be used to start the computer when there is a bootable disk contained in the drive.

To change the boot drive, follow the steps below.

1. Hold down **F12** and boot the computer.
2. The following menu will be displayed with the following icons: Built-in HDD, CD-ROM, FDD (or SD memory card), Network (LAN), USB Memory boot.



A bar will appear only under the selected device.

3. Use the left/right cursor keys to highlight the boot device you want and press **Enter**.



- *If only a Supervisor Password has been set, the following should be noted:*
 - *The boot device menu will appear when the 'Able to run HW Setup' option has been configured.*
 - *The boot device menu will not appear when the 'Unable to run HW Setup' option has been configured.*
- *If both a Supervisor Password and a User Password are set, the following should be noted:*
 - *The boot device menu will appear when you use either the Supervisor Password or the User Password to start the computer, and the 'Able to run HW Setup' option has been configured.*
 - *The boot device menu will not appear when you use the User Password to start the computer and the 'Unable to run HW Setup' option has been configured.*
 - *The boot device menu will appear when you use the Supervisor Password to start the computer, even if the 'Unable to run HW Setup' option has been configured.*

The boot device selection methods described above will not change the boot priority settings that have been configured in HW Setup. In addition, if you press a key other than one of those listed, or if the selected device is not installed, the system will continue to boot according to the current and available settings in HW Setup.

HDD Priority Options

If more than one HDD is installed in the computer, this option lets you set the priority for HDD detection. If the first detected HDD has a boot command, the system will boot from the HDD.

Built-in HDD -> USB (Default)	The priority is set as Built-in HDD -> USB.
---	---

USB -> Built-in HDD	The priority is set as USB -> Built-in HDD.
-------------------------------	---



- If a boot command is not found on the first detected *HDD*, the system will not boot from the other *HDD*. It will search the next device in the boot priority for a boot command.
- Some modules may not be displayed.

Network Boot Protocol

This feature sets the protocol to remotely boot from the network.



Network Boot Protocol is not displayed for Gigabit Ethernet LAN.

- [PXE] Sets PXE as the protocol (Default).
- [RPL] Sets RPL as the protocol.

USB Memory BIOS Support Type

Set the type of the USB memory as a startup device.

HDD	Set the type of the USB memory to be equivalent to the HDD (Default). * Based on the [HDD] order in the [Boot Priority Options] item. The order with respect to the other HDD can be set in the [HDD Priority Options] item.
FDD	Set the type of the USB memory to be equivalent to the FDD. * Based on the [FDD] order in the [Boot Priority Options] item.

Keyboard

Wake-up on Keyboard

When this feature is enabled and the computer is in Standby Mode, you can turn on the computer by pressing any key. It is effective only for the internal keyboard and only when the computer is in Standby Mode.

Enabled	Enables the Wake-up on Keyboard function.
Disabled	Disables the Wake-up on Keyboard function (Default).

CPU

This function lets you set the CPU operating mode.



This option is displayed only for models with an Intel® Core™ Duo processor and Intel® Core™ Solo processor.

Dynamic CPU Frequency Mode

This option lets you choose from the following settings:

Dynamically Switchable	CPU power consumption and clock speed automatic switching function is enabled. When the computer is in use, CPU operation is automatically switched when necessary (Default).
Always High	CPU power consumption and clock speed automatic switching function is disabled. The CPU always runs at its fastest speed.
Always Low	CPU power consumption and clock speed automatic switching function is disabled. The CPU always runs at low power consumption and low speed.

LAN

Wake-up on LAN

This feature lets the computer's power be turned on when it receives a wake-up signal from the LAN.

Enabled	Enables Wake-up on LAN.
Disabled	Disables Wake-up on LAN (Default).



Do not install or remove an optional memory module while Wake-up on LAN is enabled.



The Wake-up on LAN function consumes power even when the system is off. Leave the AC adaptor connected while using this feature.

Built-in LAN

This feature enables or disables the Built-in LAN.

Enabled	Enables Built-in LAN functions (Default).
Disabled	Disables Built-in LAN functions.

Device Config

Device Configuration

This option lets you set the device configuration.

All Devices	BIOS sets all devices.
Setup by OS	Operating system sets devices that it can control (Default).

USB

USB KB/Mouse Legacy Emulation

Use this option to enable or disable USB keyboard/mouse legacy emulation. If your operating system does not support USB, you can still use a USB mouse and keyboard by setting the **USB KB/Mouse Legacy Emulation** item to **Enabled**.

Enabled	Enables the USB KB/Mouse Legacy Emulation function (Default).
Disabled	Disables the USB KB/Mouse Legacy Emulation function.

USB-FDD Legacy Emulation

Use this option to enable or disable USB floppy disk drive legacy emulation. If your operating system does not support USB, you can still use a USB floppy disk drive by setting the **USB-FDD Legacy Emulation** item to **Enabled**.

Enabled	Enables the USB floppy disk drive legacy emulation function (Default).
Disabled	Disables the USB floppy disk drive legacy emulation function.

BIOS Setup Program

Settings for some features are carried out in the BIOS setup program.



Notes before using the BIOS Setup

- *In most cases, changes to the system's configuration should be made within Windows by using applications such as **TOSHIBA HW Setup**, **TOSHIBA Password Utility**, **TOSHIBA Power Saver**, **Windows Device Manager** and so forth. If you make changes to the configuration through the BIOS setup program, please be aware that the configuration set through the Windows applications will take priority.*
- *Changes to the settings within the BIOS setup program will not be erased even if the power supply is switched off and the main battery removed. However, if the built-in Real Time Clock (RTC) battery runs out of power, most of the settings will revert back to their default values. However, please note that the following items will not be affected in this instance:*
 - Password
 - Hard Disk Drive Password
 - Security controller

Starting and Ending the BIOS Setup Program

Starting the BIOS Setup Program

1. Switch on your computer while pressing the **Esc** key.
If "**password =**" is displayed, enter either the Supervisor Password, if one is set, or the User Password and press the **Enter** key.
Please refer to Chapter 6, the *TOSHIBA Password Utility*, for details about the User Password.
The "**Check system. Then press [F1] key.**" message is displayed.
2. Press the **F1** key.
The BIOS setup program will start up.



Please refer to the operating instructions displayed in the settings screen.

Ending the BIOS Setup Program

Save the changes and end the program.

1. Press the **End** Key.
The "**Are you sure? (Y/N) The changes you made will cause the system to reboot.**" message is displayed.
2. Press the **Y** key.
The configured settings are saved and the BIOS setup program ends.
The computer may reboot depending on the settings that were modified.

Ending the BIOS Setup Program Halfway

The configuration settings can be terminated halfway without saving any of the changes made.

1. Press the **Esc** key.
The "Exit without saving? (Y/N)" message is displayed.
2. Press the **Y** key.
The BIOS setup program will end.

Core Multi - Processing

The Core Multi-Processing sets the CPU operating mode.



This option is displayed only on models with an Intel® Core™ Duo processor.

Enabled is Dual Core mode.

Disabled is Single Core mode.

Enabled	Enables Core Multi - Processing functions (Default).
Disabled	Disables Core Multi - Processing functions.

Virtualization Technology

Virtualization Technology sets enable or disable of the Intel Virtualization Technology installed in the CPU.

Intel Virtualization Technology is the technique that allows one machine to operate as multiple virtual machines.



The Virtualization Technology is supported with some models.

The Disabled command does not allow use of the Intel Virtualization Technology.

The Enabled command allows use of the Intel Virtualization Technology.

Enabled	Enables Virtualization Technology.
Disabled	Disables Virtualization Technology (Default).

Enhanced C-States

This feature enables or disables the Enhanced C-States.



This option is displayed only on models with an Intel® Core™ Duo processor and Intel® Core™ Solo processor.

Enabled	This lowers the power consumption (Default).
Disabled	This does not lower the power consumption.

Execute-Disable Bit Capability

This setting, which is displayed on the first page of the setup screen, configures the Execute-Disable Bit function of the CPU. This function is specific to Intel processors and, when activated, helps to reduce security threats to the computer by preventing certain classes of malicious 'buffer overflow' attacks when combined with a supporting operating system such as Windows XP.

Available	Makes the processor's Execute-Disable Bit Capability available for use.
Not Available	Disables the processor's Execute-Disable Bit Capability so that it is not available for use. (Default).



*System configuration changes, other than changes to this setting, should be made within Windows by using applications such as **TOSHIBA HW Setup**, **TOSHIBA Password Utility**, **TOSHIBA Power Saver**, **Windows Device Manager** and so forth.*

Security controller

The security controller settings are available in **SYSTEM SETUP (2/2)**.

TPM

This setting enables or disables the security controller known as TPM (Trusted Platform Module).

Enabled	Enables the TPM.
Disabled	Disables the TPM (Default).

Clear TPM Owner

This setting is used to erase the data in TPM when disposing of the computer or when the owner of the computer changes, etc. Once this operation is carried out, the TPM configuration settings are erased, such that the encrypted data can no longer be decrypted and the files can no longer be read. Please backup or delete the data as necessary before carrying out this operation.

The operating procedure is as follows:

1. Move the cursor to the **Clear TPM Owner** setting and press the **Space** key or **BkSp** key.
2. A message is displayed. Press the **Y**, **E**, **S**, and **Enter** keys and the TPM information is erased.
3. The TPM setting changes from being displayed as **Enable** to **Disabled**, and the setting is no longer displayed.



- *System configuration changes other than changes to this setting should be made in Windows using **TOSHIBA HW Setup, TOSHIBA Password Utility, TOSHIBA Power Saver, Device Manager, etc.***
- *When using TPM, please install the **Infineon TPM Installation Guide** from the **TOSHIBA Application Installer**. Please ensure that the user reads the **Infineon TPM Installation Guide** as it contains usage information and notes on using TPM.*

Diagnostic Mode

Set whether the BIOS Setup Diagnostic test is enabled.

Disabled	The Diagnostic test is disabled (Default).
Enabled	The Diagnostic test is enabled.

Chapter 8

Troubleshooting

TOSHIBA designed the computer for durability. However, should problems occur, following the procedures in this chapter can help to determine the cause.

All readers should become familiar with this chapter. Knowing what might go wrong can help prevent problems from occurring.

Problem solving process

Resolving problems will be much easier if you observe the following guidelines:

- Stop immediately when you recognize a problem exists. Further action may result in data loss or damage. You may destroy valuable problem-related information that can help solve the problem.
- Observe what is happening. Write down what the system is doing and what actions you performed immediately before the problem occurred. If you have a printer attached, print a copy of the screen using **PrtSc**.

The questions and procedures offered in this chapter are meant as a guide, they are not definitive problem solving techniques. Many problems can be solved simply, but a few may require help from your dealer. If you find you need to consult your dealer or others, be prepared to describe the problem in as much detail as possible.

Preliminary checklist

Consider the simplest solution first. The items in this checklist are easy to fix and yet can cause what appears to be a serious problem.

- Make sure you turn on all peripheral devices before you turn on the computer. This includes your printer and any other external device you are using.
- Before you attach an external device, turn the computer off. When you turn the computer back on it recognizes the new device.
- Make sure all options are set properly in the setup program.
- Check all cables. Are they correctly and firmly attached? Loose cables can cause signal errors.
- Inspect all connecting cables for loose wires and all connectors for loose pins.
- Check that your floppy disk or CD/DVD-ROM is correctly inserted and that the floppy disk's write protect tab is correctly set.

Make notes of your observations and keep them in a permanent error log. This will help you describe your problems to your dealer. If a problem recurs, the log will help you identify the problem faster.

Analyzing the problem

Sometimes the system gives clues that can help you identify why it is malfunctioning. Keep the following questions in mind:

- Which part of the system is not operating properly: keyboard, floppy disk drives, hard disk drive, optical disc drive, display. Each device produces different symptoms.
- Is the operating system configuration set properly? Check the configuration options.
- What appears on the display screen? Does it display any messages or random characters? If you have a printer attached, print a copy of the screen using **PrtSc**. Look up the messages in the software and operating system documentation. Check that all connecting cables are correctly and firmly attached. Loose cables can cause erroneous or intermittent signals.
- Do any indicators light? Which ones? What color are they? Do they stay on or blink? Write down what you see.
- Do you hear any beeps? How many? Are they long or short? Are they high pitched or low? Is the computer making any unusual noises? Write down what you hear.

Record your observations so you can describe them to your dealer.

Software	<p>The problems may be caused by your software or disk. If you cannot load a software package, the media may be damaged or the program might be corrupted. Try loading another copy of the software.</p> <p>If an error message appears while you are using a software package, check the software documentation. These documents usually include a problem solving section or a summary of error messages.</p> <p>Next, check any error messages in the operating system documentation.</p>
Hardware	<p>If you cannot find a software problem, check your hardware. First run through the items in the preliminary checklist above. If you still cannot correct the problem, try to identify the source. The next section provides checklists for individual components and peripherals.</p>



Before using a peripheral device or application software that is not an authorized Toshiba part or product, make sure the device or software can be used with your PC. Use of incompatible devices may cause injury or may damage your PC.

Hardware and system checklist

This section discusses problems caused by your computer's hardware or attached peripherals. Basic problems may occur in the following areas:

- | | |
|---------------------------------|----------------------------|
| ■ System start-up | ■ xD picture card |
| ■ Self test | ■ MultiMediaCard |
| ■ Power | ■ Pointing Device |
| ■ Password | ■ Fingerprint Sensor |
| ■ Keyboard | ■ USB device |
| ■ Internal LCD display panel | ■ Memory expansion |
| ■ Hard disk drive | ■ Sound system |
| ■ DVD-ROM | ■ External monitor |
| ■ DVD-ROM&CD-R/RW drive | ■ TV output signal |
| ■ DVD Super Multi drive | ■ i.LINK (IEEE1394) device |
| ■ USB floppy disk drive | ■ Modem |
| ■ PC card | ■ LAN |
| ■ SD card | ■ Wireless LAN |
| ■ Memory Stick/Memory Stick Pro | ■ Bluetooth |

System start-up

When the computer does not start properly, check the following items:

- Self Test
- Power Sources
- Power-on Password

Self test

When the computer starts up, the self test will be run automatically, and the following will be displayed:



In Touch with Tomorrow
TOSHIBA

This message remains on the screen for a few seconds.

If the self test is successful, the computer tries to load the operating system, depending on how the Boot Priority is set in the TOSHIBA HW Setup program.

If any of the following conditions are present, the self test failed:

- The computer stops and does not proceed to display information or messages except the TOSHIBA logo.
- Random characters appear on the screen, and the system does not function normally.
- The screen displays an error message.

Turn off the computer and check all cable connections. If the test fails again, contact your dealer.

Power

When the computer is not plugged into an AC outlet, the battery pack is the primary power source. However, your computer has a number of other power resources, including an intelligent power supply and a Real Time Clock battery. These resources are interrelated and any one could affect apparent power problems. This section provides checklists for AC power and the battery. If you cannot resolve a problem after following them, the cause could lie with another power resource. In such case, contact your dealer.

Overheating power down

If the computer's internal temperature becomes too high, the computer will automatically enter Hibernation or Standby Mode and shut down.

Problem	Procedure
Computer shuts down and DC IN indicator blinks orange	Leave the computer off until the DC IN indicator stops blinking.



*It is recommended to leave the computer off until the interior reaches room temperature even though the **DC IN** indicator stops blinking.*

If the computer has reached room temperature and still does not start, or if it starts but shuts down quickly contact your dealer.

Computer shuts down and its DC IN indicator is flashing green	Indicates a problem with the heat dispersal system. Please contact your dealer.
--	---

AC power

If you have trouble turning on the computer with the AC adaptor connected, check the **DC IN** indicator. Refer to Chapter 6, [Power and Power-Up Modes](#) for more information.

Problem	Procedure
AC adaptor doesn't power the computer (DC IN indicator does not glow green)	<p>Check the connections. Make sure the cord is firmly connected to the computer and a power outlet.</p> <p>Check the condition of the cord and terminals. If the cord is frayed or damaged, replace it. If the terminals are soiled, wipe them with cotton or a clean cloth.</p> <p>If the AC adaptor still does not power the computer, contact your dealer.</p>

Battery

If you suspect a problem with the battery, check the **DC IN** indicator as well as the **Battery** indicator. For information on indicators and battery operation see Chapter 6, [Power and Power-Up Modes](#).

Problem	Procedure
Battery doesn't power the computer	The battery may be discharged. Connect the AC adaptor to charge the battery.

Problem	Procedure
Battery doesn't charge when the AC adaptor is attached (Battery indicator does not glow orange.)	<p>If the battery is completely discharged, it will not begin charging immediately. Wait a few minutes.</p> <p>If the battery still does not charge, make sure the outlet of the AC adaptor is supplying power. Test it by plugging in an appliance.</p> <hr/> <p>Check whether the battery is hot or cold to the touch. If the battery is too hot or too cold, it will not charge properly. Let it reach room temperature.</p> <hr/> <p>Unplug the AC adaptor and remove the battery to make sure the terminals are clean. If necessary wipe them with a soft dry cloth dipped in alcohol. Connect the AC adaptor and replace the battery. Make sure it is securely seated.</p> <p>Check the Battery indicator. If it does not glow, let the computer charge the battery for at least 20 minutes. If the Battery indicator glows after 20 minutes, let the battery continue to charge at least another 20 minutes before turning on the computer.</p> <p>If the indicator still does not glow, the battery may be at the end of its operating life. Replace it.</p> <p>If you do not think the battery is at the end of its operating life, see your dealer.</p>
Battery doesn't power the computer as long as expected	<p>If you frequently recharge a partially charged battery, the battery might not charge to its full potential. Fully discharge the battery, then try to charge it again.</p> <hr/> <p>Check the power consumption settings in TOSHIBA Power Saver. Consider using a power saving mode.</p>

Real Time Clock

Problem	Procedure
The following message is Displayed on the LCD screen: RTC battery is low or CMOS checksum is inconsistent. Press [F1] key to set Date/Time.	The charge in the RTC battery has run out - you will need to set the date and time in the BIOS setup using the following steps: <ol style="list-style-type: none"> 1. Press F1 key. BIOS setup will boot up. 2. Set the date in System Date. 3. Set the time in System Time. 4. Press End key. Confirmation message will appear. 5. Press Y key. BIOS setup will terminate and the computer will be rebooted.

Password

Problem	Procedure
Cannot enter password	Refer to the TOSHIBA Password Utility section in Chapter 6, Power and Power-Up Modes.

Keyboard

Keyboard problems can be caused by your setup configuration. For more information refer to Chapter 5, [The Keyboard](#).

Problem	Procedure
Some letter keys produce numbers	Check that the numeric keypad overlay is not selected. Press Fn + F11 and try typing again.
Output to screen is garbled	Make sure the software you are using is not remapping the keyboard. Remapping involves reassigning the meaning of each key. See your software's documentation. If you are still unable to use the keyboard, consult your dealer.

Internal LCD display panel

Apparent LCD problems may be related to the computer's setup. Refer to Chapter 7, *HW Setup & BIOS Setup*, for more information.

Problem	Procedure
No display	Press hotkeys Fn + F5 to change the display priority, to make sure it is not set for an external monitor.
Markings appear on the LCD screen.	The marks may have come from contact with the keyboard or Touch Pad. Try wiping the LCD screen gently with a clean dry cloth. If markings remain, use a good quality LCD screen cleaner, taking care to ensure you let the LCD screen dry before closing it.
Problems above remain unresolved or other problems occur	Refer to your software's documentation to determine if the software is causing the difficulty. Run the diagnostic test. Contact your dealer if the problems continue.

Hard disk drive

Problem	Procedure
Computer does not boot from hard disk drive	Check if a floppy disk is in the floppy disk drive or a CD-ROM is in the optical disc drive. Remove any floppy disk and/or CD-ROM and check the Boot priority. Refer to the <i>Boot Priority</i> section in Chapter 7, <i>HW Setup & BIOS Setup</i> . There may be a problem with your operating system files. Refer to your operating system documentation.
Slow performance	Your files may be fragmented. Run Disk Defragmenter to check the condition of your files and disk. Refer to your operating system's documentation or online HELP for information on running the Disk Defragmenter. As a last resort, reformat the hard disk. Then, reload the operating system and other files. If problems persist, contact your dealer.

DVD-ROM drive

For more information, refer to Chapter 4, [Operating Basics](#).

Problem	Procedure
<p>You cannot access a CD/DVD in the drive</p>	<p>Make sure the drive's disc tray is securely closed. Press gently until it clicks into place.</p> <hr/> <p>Check whether the drive power is on. If the power is off, click on the Optical Drive Power icon in the task tray and turn on the power.</p> <hr/> <p>Open the disc tray and make sure the CD/DVD is properly seated. It should lie flat with the label facing up.</p> <hr/> <p>A foreign object in the disc tray could block laser light from reading the CD/DVD. Make sure there is no obstruction. Remove any foreign object.</p> <hr/> <p>Check whether the CD/DVD is dirty. If it is, wipe it with a clean cloth dipped in water or a neutral cleaner. Refer to the Media care section in Chapter 4 for details on cleaning.</p>
<p>Some CD/DVDs run correctly, but others do not</p>	<p>The software or hardware configuration may be causing a problem. Make sure the hardware configuration matches your software's needs. Check the CD/DVD's documentation.</p> <hr/> <p>Check the type of CD/DVD you are using. The drive supports:</p> <p>DVD-ROM: DVD-ROM, DVD-Video</p> <p>CD-ROM: CD-DA, CD-Text, Photo CD™ (single/multi-session), CD-ROM Mode 1, Mode 2, CD-ROM XA Mode 2 (Form1, Form2), Enhanced CD (CD-EXTRA), Addressing Method 2</p> <hr/> <p>Check the region code on the DVD. It must match that on the DVD-ROM drive. Region codes are listed in the Optical disc drives section in Chapter 2, The Grand Tour.</p> <p>If problems persist, contact your dealer.</p>

DVD-ROM&CD-R/RW drive

For more information, refer to Chapter 4, [Operating Basics](#).

Problem	Procedure
You cannot access a CD/DVD in the drive	<p>Make sure the drive's disc tray is securely closed. Press gently until it clicks into place.</p> <hr/> <p>Check whether the drive power is on. If the power is off, click on the Optical Drive Power icon in the task tray and turn on the power.</p> <hr/> <p>Open the disc tray and make sure the CD/DVD is properly seated. It should lie flat with the label facing up.</p> <hr/> <p>A foreign object in the disc tray could block laser light from reading the CD/DVD. Make sure there is no obstruction. Remove any foreign object.</p> <hr/> <p>Check whether the CD/DVD is dirty. If it is, wipe it with a clean cloth dipped in water or a neutral cleaner. Refer to the Media care section in Chapter 4 for details on cleaning.</p>
Some CD/DVDs run correctly, but others do not	<p>The software or hardware configuration may be causing a problem. Make sure the hardware configuration matches your software's needs. Check the CD/DVD's documentation.</p> <hr/> <p>Check the type of CD/DVD you are using. The drive supports:</p> <p>DVD-ROM: DVD-ROM, DVD-Video</p> <p>CD-ROM: CD-DA, CD-Text, Photo CD™ (single/multi-session), CD-ROM Mode 1, Mode 2, CD-ROM XA Mode 2 (Form1, Form2), Enhanced CD (CD-EXTRA), Addressing Method 2</p> <p>Recordable CD: CD-R, CD-RW</p> <hr/> <p>Check the region code on the DVD. It must match that on the DVD-ROM&CD-R/RW drive. Region codes are listed in the Optical disc drives section in Chapter 2, The Grand Tour.</p>

Problem	Procedure
Cannot write correctly	<p>If you have trouble writing, make sure you are observing the following precautions:</p> <ul style="list-style-type: none"> ■ Use only media recommended by TOSHIBA. ■ Do not use the mouse or keyboard during writing. ■ Use only the software supplied with the computer for recording. ■ Do not run or start other software during writing. ■ Do not jar the computer during writing. ■ Do not connect/disconnect external devices or install/remove internal cards during writing. <p>If problems persist, contact your dealer.</p>

DVD Super Multi drive

For more information, refer to Chapter 4, *Operating Basics*.

Problem	Procedure
You cannot access a CD/DVD in the drive	<p>Make sure the drive's disc tray is securely closed. Press gently until it clicks into place.</p> <hr/> <p>Check whether the drive power is on. If the power is off, click on the Optical Drive Power icon in the task tray and turn on the power.</p> <hr/> <p>Open the disc tray and make sure the CD/DVD is properly seated. It should lie flat with the label facing up.</p> <hr/> <p>A foreign object in the disc tray could block laser light from reading the CD/DVD. Make sure there is no obstruction. Remove any foreign object.</p> <hr/> <p>Check whether the CD/DVD is dirty. If it is, wipe it with a clean cloth dipped in water or a neutral cleaner. Refer to the <i>Media care</i> section in Chapter 4 for details on cleaning.</p>
Some CD/DVDs run correctly, but others do not	<p>The software or hardware configuration may be causing a problem. Make sure the hardware configuration matches your software's needs. Check the CD/DVD's documentation.</p>

Check the type of CD/DVD you are using. The drive supports:

DVD-ROM: DVD-ROM, DVD-Video

CD-ROM: CD-DA, CD-Text, Photo CD™ (single/multi-session), CD-ROM Mode 1, Mode 2, CD-ROM XA Mode 2 (Form1, Form2), Enhanced CD (CD-EXTRA), Addressing Method 2

Recordable DVD: DVD-R/R DL, DVD+R/+R DL, DVD-RW, DVD+RW, DVD-RAM

Check the region code on the DVD. It must match that on the DVD Super Multi drive. Region codes are listed in the [Optical disc drives](#) section in Chapter 2, The Grand Tour.

USB floppy disk drive

For more information, refer to Chapter 3, [Features, Utilities and Options](#).

Problem	Procedure
Drive does not operate	There may be a faulty cable connection. Check the connection to the computer and to the drive.
Some programs run correctly but others do not	The software or hardware configuration may be causing a problem. Make sure the hardware configuration matches your software needs.
You cannot access the external 3 1/2" floppy disk drive	Try another floppy disk. If you can access the floppy disk, the original floppy disk (not the drive) is probably causing the problem. If problems persist, contact your dealer.

PC card

Refer also to Chapter 3, [Features, Utilities and Options](#).

Problem	Procedure
PC card error occurs	Reseat the PC card to make sure it is firmly connected. Make sure the connection between the external device and the card is firm. Check the card's documentation. If problems persist, contact your dealer.

SD card

Refer also to Chapter 3, [Features, Utilities and Options](#).

Problem	Procedure
SD card error occurs	Reseat the SD card to make sure it is firmly connected. Check the card's documentation.
You cannot write to an SD memory card	Make sure the card is not write protected.
You cannot read a file	Make sure the target file is on the SD memory card inserted in the slot. If problems persist, contact your dealer.

Memory Stick/Memory Stick Pro

Refer also to Chapter 3, [Features, Utilities and Options](#).

Problem	Procedure
Memory Stick/Memory Stick Pro error occurs	Reseat the Memory Stick/Memory Stick Pro to make sure it is firmly connected. Check the card's documentation.
You cannot write to an Memory Stick/Memory Stick Pro	Make sure the Memory Stick/Memory Stick Pro is not write protected.
You cannot read a file	Make sure the target file is on the Memory Stick/Memory Stick Pro inserted in the slot. If problems persist, contact your dealer.

xD picture card

Refer also to Chapter 3, [Features, Utilities and Options](#).

Problem	Procedure
xD picture card error occurs	Reseat the xD picture card to make sure it is firmly connected. Check the card's documentation.
You cannot read a file	Make sure the target file is on the xD picture card inserted in the slot. If problems persist, contact your dealer.

MultiMediaCard

Refer also to Chapter 3, *Features, Utilities and Options*.

Problem	Procedure
MultiMediaCard error occurs	Reseat the MultiMediaCard to make sure it is firmly connected. Check the MultiMediaCard's documentation.
You cannot write to an MultiMediaCard	Make sure the MultiMediaCard is not write protected.
You cannot read a file	Make sure the target file is on the MultiMediaCard inserted in the slot. If problems persist, contact your dealer.

Pointing device

If you are using a USB mouse, also refer to the USB section in this chapter and to your mouse documentation.

Touch Pad

Problem	Procedure
On-screen pointer does not respond to Pad operation	The system might be busy. If the pointer is shaped as an hourglass, wait for it to return to its normal shape and try again to move it.
Double-tapping does not work	Try changing the double-click speed setting in the mouse control utility. <ol style="list-style-type: none"> 1. Click start, click Control Panel, click Printers and Other Hardware and select Mouse icon. 2. Click the Buttons tab. 3. Set the double-click speed as required and click OK.

Problem	Procedure
The mouse pointer moves too fast or too slow	<p>Try changing the speed setting in the mouse control utility.</p> <ol style="list-style-type: none"> 1. Click start, click Control Panel, click Printers and Other Hardware and select Mouse icon. 2. Click the Pointer Options tab. 3. Set the speed as required and click OK. <p>If problems persist, contact your dealer.</p>
The reaction of Touch pad is either too sensitive or not sensitive enough.	<p>Adjust the touch Sensitivity.</p> <ol style="list-style-type: none"> 1. Click start and open the Control Panel. 2. Click the Printers and Other Hardware icon. 3. Click the Mouse icon. 4. Click the Advanced tab. 5. Click the Advanced feature settings button. 6. Click Touch Pad tab. Click the Settings button in the Pointer speed and tapping settings. 7. Detailed Touch Pad setting is displayed. 8. Move the slide of adjust the pointer speed in relation to the standard Windows setting. Click the OK button. 9. Click the OK button on Advanced feature setting screen.

USB mouse

Problem	Procedure
On-screen pointer does not respond to mouse operation	<p>The system might be busy. If the pointer is shaped as an hourglass, wait for it to resume its normal shape and try again to move it.</p> <hr/> <p>Make sure the mouse is properly connected to the USB port.</p>
Double-clicking does not work	<p>Try changing the double-click speed setting in the mouse control utility.</p> <ol style="list-style-type: none"> 1. Click start, click Control Panel, click Printers and Other Hardware and select Mouse icon. 2. Click the Buttons tab. 3. Set the double-click speed as required and click OK.

Problem	Procedure
The mouse pointer moves too fast or too slow	<p>Try changing the speed setting in the mouse control utility.</p> <ol style="list-style-type: none"> 1. Click start, click Control Panel, click Printers and Other Hardware and select Mouse icon. 2. Click the Pointer Options tab. 3. Set the speed as required and click OK.
The mouse pointer moves erratically	<p>The mouse might be dirty. Refer to your mouse documentation for instructions on cleaning. If problems persist, contact your dealer.</p>

Fingerprint Sensor

Problem	Procedure
Reading of the fingerprint was not successful.	<p>Try again using the correct posture. Align your fingertip with the sensor as shown in the drawing and swipe. Refer to Using the Fingerprint Sensor in Chapter 4, Operating Basics.</p> <p>Try the recognition process again using another enrolled finger.</p>
The fingerprint cannot be read due to injuries to the finger.	<p>Try the recognition process again using another enrolled finger.</p> <p>If fingerprints from all the enrolled fingers cannot be read, please logon by using the keyboard to input the password for the time being.</p> <p>If problems persist, contact your dealer.</p>

USB device

Refer also to your USB device's documentation.

Problem	Procedure
USB device does not work	<p>Check for a firm cable connection between the USB ports on the computer and the USB device.</p> <hr/> <p>Make sure the USB device drivers are properly installed. Refer to your Windows XP documentation for information on checking the drivers.</p> <hr/> <p>If you are using an operating system that does not support USB, you can still use a USB mouse and/or USB keyboard. If these devices do not work, make sure the USB KB/Mouse Legacy Emulation item in HW Setup is set to Enabled.</p> <p>If problems persist, contact your dealer.</p>

Memory expansion

Refer also to Chapter 3, *Features, Utilities and Options*, for information on installing memory modules.

Problem	Procedure
<p>If there is a memory malfunction, the power LED flashes (on for 0.5 seconds, off for 0.5 seconds) in the following ways;</p> <p>If there is only an error in Slot A: repeatedly flashes orange twice, then green.</p> <p>If there is only an error in Slot B: repeatedly flashes orange, then green twice.</p> <p>If there is an error in Slot A and in Slot B: repeatedly flashes orange twice, then green twice.</p>	<p>Make sure the memory module installed in the memory slot is compatible with the computer.</p> <p>If an incompatible module has been installed, follow the steps below.</p> <ol style="list-style-type: none"> 1. Turn off the computer. 2. Disconnect the AC adaptor and all peripheral devices. 3. Remove the battery pack. 4. Remove the memory module. 5. Install the battery and/or connect the AC adaptor. 6. Turn on the power. <p>If problems persist, contact your dealer.</p>

Sound system

Refer also to documentation for your audio devices.

Problem	Procedure
No sound is heard	<p>Adjust the volume control dial.</p> <p>Check the software volume settings.</p> <p>Make sure the headphone connection is secure. If problems persist, contact your dealer.</p> <p>Check Windows Device Manager. Make sure the sound function is enabled and that settings for I/O address, Interrupt level and DMA are correct for your software and do not conflict with other hardware devices that you may have connected to the computer.</p>
Annoying sound is heard	<p>You may be experiencing feedback. Refer to Sound System in Chapter 4, Operating Basics. If problems persist, contact your dealer.</p>

External monitor

Refer also to Chapter 3, [Features, Utilities and Options](#), and to your monitor's documentation.

Problem	Procedure
Monitor does not turn on	<p>Make sure that the external monitor's power switch is on. Confirm that the external monitor's power cable is plugged into a working power outlet.</p>
No display	<p>Try adjusting the contrast and brightness controls on the external monitor.</p> <p>Press hot keys Fn + F5 to change the display priority and make sure it is not set for the internal LCD.</p>
Display error occurs	<p>Check that the cable connecting the external monitor to the computer is attached firmly. If problems persist, contact your dealer.</p>

TV output signal

Problem	Procedure
Display on TV is poor	Make sure the TV type is correct for your area: NTSC (US, JAPAN), PAL (Europe).
No display	<p>Try adjusting the contrast and brightness controls on the external monitor.</p> <p>Press hotkeys Fn + F5 to change the display. Refer to Chapter 5, <i>The Keyboard</i>.</p> <p>If problems persist, contact your dealer.</p>



If you turn the computer off into Standby Mode while the display is on TV, the computer will select either the internal LCD or an external computer CRT as the display device the next time is switched on.

i.LINK (IEEE1394) device

Problem	Procedure
i.LINK device does not function	<p>Make sure the cable is securely connected to the computer and to the device.</p> <p>Make sure the device's power is turned on.</p> <p>Reinstall the drivers. Open the Windows Control Panel and double-click the Add Hardware icon. Follow the on-screen directions.</p> <p>Restart Windows.</p> <p>If problems persist, contact your dealer.</p>

Modem

Refer to Appendix C, *AT Commands* and Appendix D, *S-registers*.

Problem	Procedure
Communication software can't initialize modem	Make sure the computer's internal modem settings are correct. Refer to <i>Phone and Modem Properties</i> in the Control Panel.
You can hear a dial tone but can't make a call	<p>If the call is going through a PBX machine, make sure the communication application's tone dial detection feature is disabled.</p> <p>You can also use the ATX command. Refer to Appendix C, <i>AT Commands</i>.</p>

Problem	Procedure
You place a call, but a connection can't be made	Make sure the settings are correct in your communications application.
After making a call you can't hear a ring	Make sure the tone or pulse selection in your communications application is set correctly. You can also use the ATD command. Refer to Appendix C, AT Commands .
Communication is cut off unexpectedly	The computer will automatically cut off communication when connection with the carrier is not successful for a set time interval. Try lengthening this time interval.
A CONNECT display is quickly replaced by NO CARRIER	Check the error control setting in your communications application. You can also use the AT\N command. Refer to Appendix C, AT Commands .
Character display becomes garbled during a communication session	In data transmission, make sure the parity bit and stop bit settings correspond with those of the remote computer. Check the flow control and communication protocol.
You cannot receive an incoming call	Check the rings before auto answer setting in your communications application. You can also use the ATS0 command. Refer to Appendix D, S-registers . If problems persist, contact your dealer.

LAN

Problem	Procedure
Cannot access LAN	Check for a firm cable connection between the LAN jack and the LAN hub.
Wake-up on LAN does not work	Make sure the AC adaptor is connected. The Wake-up on LAN function consumes power even when the system is off. If problems persist, consult your LAN administrator.

Wireless LAN

If the following procedures do not restore LAN access, consult your LAN administrator. For more information on wireless communication, refer to Chapter 4, *Operating Basics*.

Problem	Procedure
Cannot access Wireless LAN	Make sure the computer's wireless communication switch is set to on. If problems persist, contact your LAN administrator.

Bluetooth

For more information on wireless communication, refer to Chapter 4, *Operating Basics*.

Problem	Procedure
Cannot access Bluetooth device	Make sure the computer's wireless communication switch is set to on. Make sure the Bluetooth Manager is running and the power to the Bluetooth device is turned on. Make sure no optional Bluetooth PC card and Bluetooth SD card are installed in the computer. The built-in Bluetooth function and an optional Bluetooth PC card cannot operate simultaneously. If problems persist, contact your dealer.

Disposing of PC and PC batteries

- Discard this PC in accordance with applicable laws and regulations. For further information, contact your local government.
- This PC contains rechargeable batteries. After repeated use, the batteries will finally lose their ability to hold a charge and you will need to replace them. Under certain applicable laws and regulation, it may be illegal to dispose of old batteries by placing them in the trash.
- Please be kind to our shared environment. Check with your local government authority for details regarding where to recycle old batteries or how to dispose of them properly. This product contains mercury. Disposal of this material may be regulated due to environmental considerations. For disposal, reuse or recycling information, please contact your local government.

- If your hard disk or other storage media contains sensitive data, you should be aware that standard deletion procedures do not remove data from the media. These standard deletion procedures include:
 - Selecting Delete for a target file
 - Putting files in the Recycle Bin and emptying the Recycle Bin
 - Reformatting the media
 - Reinstalling an operating system from the recovery CD-ROM

The procedures above delete only the initial part of the data used for file management. This makes the file invisible to the operating system, but the data can still be read by specialized utilities. If you dispose of the PC, please delete all the data on its hard disk drive. Doing so prevents unauthorized use of such data. To ensure your data is not used for unauthorized purposes, you can:

- Physically destroy the hard disk drive
- Use a proven specialized utility to overwrite all data
- Take the hard disk drive to a professional deletion service

All data deletion costs will be borne by you.

TOSHIBA support

If you require any additional help using your computer or if you are having problems operating the computer, you may need to contact TOSHIBA for additional technical assistance.

Before you call

Some problems you experience may be related to software or the operating system, it is important to investigate other sources of assistance first. Before contacting TOSHIBA, try the following:

- Review troubleshooting sections in the documentation for software and peripheral devices.
- If a problem occurs when you are running software applications, consult the software documentation for troubleshooting suggestions. Call the software company's technical support for assistance.
- Consult the dealer you purchased your computer and/or software from. They are your best sources for current information and support.

Where to write

If you are still unable to solve the problem and suspect that it is hardware related, write to TOSHIBA at the nearest location listed below:

Outside of Europe	In Europe
<p>Australia TOSHIBA Australia Pty. Ltd. Information Systems Division 84-92 Talavera Road North Ryde N.S.W. 2113 Sydney</p>	<p>Germany & Austria TOSHIBA Europe (I.E.) GmbH Geschäftsbereich, Deutschland-Österreich Hammfelddamm 8, D-41460 Neuss, Germany</p>
<p>Canada TOSHIBA of Canada Ltd. 191 McNabb Street, Markham, Ontario L3R 8H2</p>	<p>France TOSHIBA Systèmes France S.A. 7, Rue Ampère B.P. 131, 92804 Puteaux Cedex</p>
<p>China TOSHIBA Personal Computer & Network (Shanghai) Co., Ltd. 43F, Hong Kong New World Tower, No. 300 Huaihai Zhong Road, Shanghai, P. R. China 200021</p>	<p>Netherlands TOSHIBA Information Systems, Benelux B.V. Rivium Boulevard 41 2909 LK Capelle a/d IJssel</p>
<p>Singapore TOSHIBA Singapore Pte. Ltd. 438B Alexandra Road #06-01 Alexandra Technopark Singapore 119968</p>	<p>Spain TOSHIBA Information Systems, ESPAÑA Parque Empresarial San Fernando Edificio Europa, 1ª Planta, Escalera A 28830 Madrid</p>

Outside of Europe	In Europe
<p>United States of America TOSHIBA America Information Systems, Inc. 9740 Irvine Boulevard Irvine, California 92618 USA</p>	<p>United Kingdom TOSHIBA Information Systems (U.K.) Ltd. TOSHIBA Court Weybridge Business Park Addlestone Road Weybridge, Surrey KT15 2UL</p>
	<p>The Rest of Europe TOSHIBA Europe (I.E.) GmbH Geschäftsbereich, Deutschland-Österreich Hammfelddamm 8, D-41460 Neuss, Germany</p>

Appendix A

Specifications

This appendix summarizes the computer's technical specifications.

Physical Dimensions

Size	348 (w) × 260 (d) × 39.9 (h) millimeters (not including parts that extend beyond the main body)
-------------	---

Refer to User's Manual about Weight.

Environmental Requirements

Conditions	Ambient temperature	Relative humidity
Operating	5°C (41°F) to 35°C (95°F)	20% to 80%
Non-operating	-20°C (-4°F) to 65°C (149°F)	10% to 90%
Thermal Gradient	20°C per hour maximum	
Wet-bulb temperature	26°C maximum	
Conditions	Altitude (from sea level)	
Operating	-60 to 3,000 meters	
Non-operating	-60 to 10,000 meters maximum	

Power Requirements

AC adaptor	100-240 volts AC 50 or 60 hertz (cycles per second)
Computer	15 VDC 5.0 amperes

Built-in Modem

Network control unit (NCU)	
Type of NCU	AA
Type of line	Telephone line (analog only)
Type of dialing	Pulse Tone
Control command	AT commands EIA-578 commands
Monitor function	Computer's speaker
Communication specifications	
Communication system	Data: Full duplex Fax: Half duplex
Communication protocol	Data ITU-T-Rec V.21/V.22/V.22bis/V.32 (Former CCITT) /V.32bis/V.34/V.90 Bell 103/212A Fax ITU-T-Rec V.17/V.29/V.27ter (Former CCITT) /V.21 ch2
Communication speed	Data transmission and reception 300/1200/2400/4800/7200/9600/12000/14400/16800/19200/21600/24000/26400/28800/31200/33600 bps Data reception only with V.90 28000/29333/30666/32000/33333/34666/36000/37333/38666/40000/41333/42666/44000/45333/46666/48000/49333/50666/52000/53333/54666/56000 bps Fax 2400/4800/7200/9600/12000/14400 bps

Network control unit (NCU)	
Transmitting level	-10 dBm
Receiving level	-10 to -40 dBm
Input/output impedance	600 ohms \pm 30%
Error correcting	MNP class 4 and ITU-T V.42
Data compression	MNP class 5 and ITU-T V.42bis
Power supply	+3.3V (supplied by computer)

Appendix B

Display Controller and Modes

Display controller

The display controller interprets software commands into hardware commands that turn particular parts on the screen on or off.



Because of the LCD's increased resolution, lines may appear broken in DOS mode.

The display controller also controls the video mode, which uses industry standard rules to govern the screen resolution and the maximum number of colors that can be displayed on screen.

Software written for a given video mode will run on any computer that supports the mode.

Video mode

Video mode settings are configured via the **Display Properties** dialog.

To open the **Display Properties** dialog, click on the **start** button, select **Control Panel**, and from the **Control Panel** click on **Appearance and Themes** and then click on **Display**, and when the **Display Properties** dialog appears, click on the **Settings** tab.

PowerMizer



The PowerMizer function is only available in nVIDIA models.

PowerMizer is a graphics processor installed on this computer. The performance of PowerMizer can be configured in three ways. To define the performance, select the menu options shown below:

Display Property -> Settings -> Advanced -> Quadro NVS 110M tab -> Quadro NVS 110M button -> nView Display Settings -> PowerMizer

The graphics processor offers three options, Maximum Power Savings, Balanced and Maximum Performance, in each of the AC power mode and battery power mode.

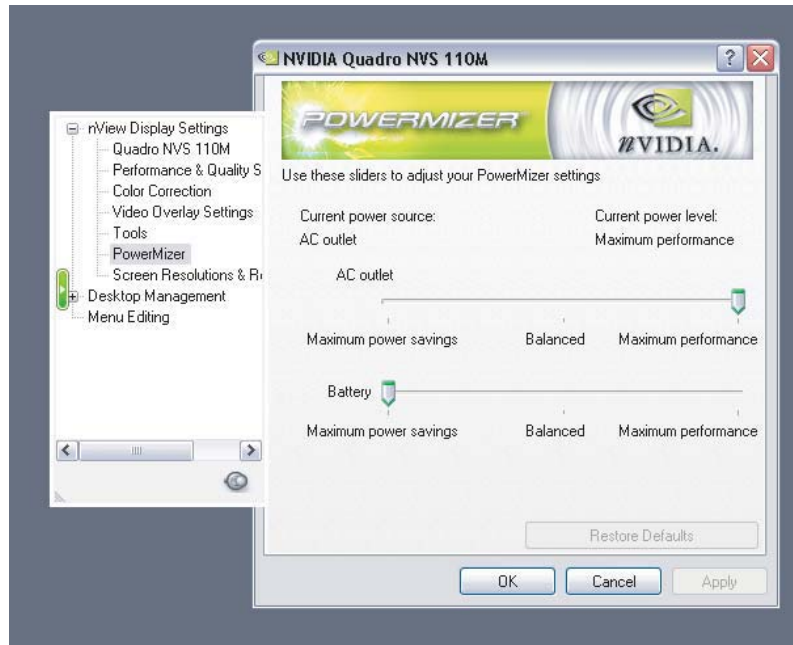

Figure B-1 (Multiple Monitors) and NVIDIA Quadro NVS 110M

Appendix C

AT Commands

In most cases, you will not need to type AT commands manually. However, there might be some occasions when you will need to do so.

This chapter describes AT commands for data mode. Fax and voice commands are taken care of by application software.

The format for entering AT commands is:

ATXn

where **X** is the AT command, and **n** is the specific value for that command. After you type in the command press **Enter**.

Any command issued is acknowledged with a response in either text or numeric values known as result codes.

All commands and command-values accepted by the modem are described in this section; any entry other than those listed results in an error.

+++ Escape sequence

The escape sequence allows the modem to exit data mode and enter on-line command mode. While in on-line command mode, you can communicate directly to your modem using AT commands. Once you finish, you can return to data mode using the ATO command.

A pause, the length of which is set by Escape Guard Time (S12), must be completed after an escape sequence is entered. This pause prevents the modem from interpreting the escape sequence as data.

The value of the escape sequence character may be changed using register S2.

A/ Repeat last command

This command repeats the last command string entered. Do not precede this command with an AT prefix or conclude it by pressing **Enter**.

A Answer command

This command instructs the modem to go off-hook and answer an incoming call.

Bn Communication standard setting

This command determines the communication standard CCITT or Bell.

- B0** Selects CCITT V.22 mode when the modem is at 1200 bps.
- B1** Selects Bell 212A when the modem is at 1200 bps (default).
- B15** Selects V.21 when the modem is at 300 bps.
- B16** Selects Bell 103J when the modem is at 300 bps (default).

Result Codes:

- OK** n=0,1,15,16
- ERROR** Otherwise

Dn Dial

This command instructs the modem to dial a telephone number. Enter **n** (the telephone number and any modifiers) after the ATD command.

Any digit or symbol (0-9, *, #, A, B, C, D) may be dialed as touch-tone digits. Characters such as spaces, hyphens, and parentheses do not count. They are ignored by the modem, but you may want to include them to make the number and modifiers easier to read.

The following may be used as phone number modifiers:

- P** Pulse dialing.
- T** Touch-tone dialing (default).
- ,** Pause during dialing. Pause for time specified in Register S8 before processing the next character in the dial string.
- W** Wait for dial tone. Modem waits for a second dial tone before processing the dial string.
- @** Wait for quiet answer. Wait for five seconds of silence after dialing the number. If silence is not detected, the modem sends a NO ANSWER result code back to the caller.
- !** Hook flash. Causes the modem to go on-hook for 0.5 seconds and then return to off-hook.
- ;** Return to command mode. Causes the modem to return to command mode after dialing a number, without disconnecting the call.
- S=n** Dial a telephone number previously stored using the **&Zn=X** command (See **&Zn=X** command for more information). The range is 0-3.

En Echo command

This command controls whether or not the characters entered from your computer keyboard are displayed on your monitor (echoed) while the modem is in command mode.

E0 Disables echo to the computer.
E1 Enables echo to the computer (default).
Result Codes:
OK n=0,1
ERROR Otherwise

Hn Hook control

This command instructs the modem to go on-hook to disconnect a call, or off-hook to make the phone line busy.

H0 Modem goes on-hook (default).
H1 Modem goes off-hook.
Result Codes:
OK n=0,1
ERROR Otherwise

In Request ID information

This command displays product information about the modem.

I0 Returns modem identity string and driver version number.
I3 Same as **I0**.
I9 Returns region ID in English.
Result Codes:
OK n=0,3,9
ERROR Otherwise

Ln Monitor speaker volume

This command sets speaker volume to low, medium, or high.

L0 Low volume.
L1 Low volume. (Same as **L0**)
L2 Medium volume (default).
L3 High volume.
Result Codes:
OK n=0,1,2,3
ERROR Otherwise

Mn Monitor speaker mode

This command turns the speaker on or off.

M0 The speaker is off.
M1 The speaker is on until the modem detects the carrier signal (default).
M2 The speaker is always on when modem is off-hook.
M3 Speaker is on until the carrier is detected, except when dialing.

Result Codes:
OK n=0,1,2,3
ERROR Otherwise

Nn Modulation handshake

This command controls whether or not the local modem performs a negotiated handshake at connection time with the remote modem when the communication speed of the two modems is different.

N0 When originating or answering, this is for handshake only at the communication standard specified by S37 and the ATB command.

N1 When originating or answering, begin the handshake at the communication standard specified by S37 and the ATB command (default).

During handshake, a lower transmission speed may be selected.

Result Codes:
OK n=0,1
ERROR Otherwise

On Return on-line to data mode

O0 Instructs the modem to exit on-line command mode and return to data mode (see AT escape sequence, +++).

O1 This command issues a retrain before returning to on-line data mode.

O3 This command issues a rate renegotiation before returning to on-line data mode.

Result Codes:
OK n=0,1,3
ERROR Otherwise

P Select pulse dialing

This command configures the modem for pulse (non touch-tone) dialing. Dialed digits are pulsed until a T command or dial modifier is received. Tone dial is the default setting.

Qn Result code control

Result codes are informational messages sent from the modem and displayed on your monitor. Basic result codes are **OK**, **CONNECT**, **RING**, **NO CARRIER**, and **ERROR**. The ATQ command allows the user to turn result codes on or off.

Q0 Enables modem to send result codes to the computer (default).

Q1 Disables modem from sending result codes to the computer.

Result Codes:
OK n=0,1
ERROR Otherwise

T Select tone dialing

This command instructs the modem to send DTMF tones while dialing. Dialed digits are tone dialed until a P command or dial modifier is received. This is the default setting.

Vn DCE response format

This command controls whether result codes (including call progress and negotiation progress messages) are displayed as words or their numeric equivalents.

- V0** Displays result codes as digits.
- V1** Displays result codes as text (default).

Result Codes:
OK n=0,1
ERROR Otherwise

Xn Result code selection, call progress monitoring

This command selects which result codes will be used by the modem.

Command	Dial tone detect	Busy signal detect	Supported Result Code
X0	Disable	Disable	OK, CONNECT, RING, NO CARRIER, ERROR
X1	Disable	Disable	OK, RING, NO CARRIER, ERROR, CONNECT <RATE>
X2	Enable	Disable	OK, RING, NO CARRIER, ERROR, NODIALTONE, CONNECT <RATE>
X3	Disable	Enable	OK, RING, NO CARRIER, ERROR, BUSY, CONNECT <RATE>, BLACKLISTED
X4 (default)	Enable	Enable	OK, RING, NO CARRIER, ERROR, NODIALTONE, BUSY, CONNECT <RATE>, DELAYED, BLACKLISTED, REORDER, WARBLE, CALL WAITING DETECTED
X5	Enable	Enable	OK, RING, NO CARRIER, ERROR, NODIALTONE, BUSY, CONNECT <RATE>, RRING, NO BONGTONE, DELAYED, BLACKLISTED, REORDER, WARBLE, CALL WAITING DETECTED

Dial tone detect

Disabled: The modem dials a call regardless of whether it detects a dial tone.

Enabled: The modem dials only upon detection of a dial tone, and disconnects the call if the dial tone is not detected within 10 seconds.

Busy tone detect

Disabled: The modem ignores any busy tones it receives.

Enabled: The modem monitors for busy tones.

Result Codes:

OK n=0,1,2,3,4,5

ERROR Otherwise

Zn Recall stored profile

The modem performs a soft reset and restores (recalls) the configuration profile according to the parameter supplied. If no parameter is specified, zero is assumed. Either Z0 or Z1 restores the profile.

Result Codes:

OK n=0,1

ERROR Otherwise

&Cn Data Carrier Detect (DCD) control

Data Carrier Detect is a signal from the modem to the computer indicating that a carrier signal is being received from a remote modem. DCD normally turns off when the modem no longer detects the carrier signal.

&C0 The state of the carrier from the remote modem is ignored. DCD circuit is always on.

&C1 DCD turns on when the remote modem's carrier signal is detected, and off when the carrier signal is not detected (default).

Result Codes:

OK n=0,1

ERROR Otherwise

&Dn DTR control

This command interprets how the modem responds to the state of the DTR signal and changes to the DTR signal.

&D0 Ignore. The modem ignores the true status of DTR and treats it as always on. This should only be used if your communication software does not provide DTR to the modem

&D1 If the DTR signal is not detected while in on-line data mode, the modem enters command mode, issues an **OK** result code, and remains connected.

&D2 If the DTR signal is not detected while in on-line data mode, the modem disconnects (default).

&D3 Reset on the on-to-off DTR transition.

Result Codes:

OK n=0,1,2,3

ERROR Otherwise

&F Load factory settings

This command loads the configuration stored and programmed at the factory. This operation replaces all of the command options and the S-register settings in the active configuration with factory values.

&F Recall factory setting as active configuration.

&Gn V.22bis guard tone control

This command determines which guard tone, if any, to transmit while transmitting in the high band (answer mode). This command is only used in V.22 and V.22bis mode. This option is not used in North America and is for international use only.

&G0 Guard tone disabled (default).

&G1 Sets guard tone to 550 Hz.

&G2 Sets guard tone to 1800 Hz.

Result Codes:

OK n=0,1,2

ERROR Otherwise

&Kn Local flow control selection

&K0 Disable flow control.

&K3 Enable CTS/RTS flow control (default).

&K4 Enable XON/XOFF flow control.

Result Codes:

OK n=0,3,4

ERROR Otherwise

&Pn Select Pulse Dial Make/Break Ratio (WW)

&P0 Selects 39% - 61% make/break ratio at 10 pulses per second.

&P1 Selects 33% - 67% make/break ratio at 10 pulses per second.

&P2 Selects 33% - 67% make/break ratio at 20 pulses per second.

Result Codes:

OK n=0,1,2

ERROR Otherwise

&Tn Self-test commands

These tests can help to isolate problems if you experience periodic data loss or random errors.

&T0 Abort. Stops any test in progress.

&T1 Local analog loop. This test verifies modem operation, as well as the connection between the modem and computer. Any data entered at the local DTE is modulated, then demodulated, and returned to the local DTE. To work properly, the modem must be off-line.

Result Codes:
OKn=0
CONNECTn=1
ERROROtherwise

&V Display Current Configuration

This command displays the current configuration of the modem. If nonvolatile memory is supported the stored profiles are displayed as well.

&V View profiles.

&W Store current configuration

Saves the current (active) configuration (profile), including S-Registers.

The current configuration comprises a list of storable parameters illustrated in the **&V** command. These settings are restored to the active configuration upon receiving a **Zn** command or at power up. Refer to the **&V** command.

&W Stores the current configuration.

&Zn=x Store telephone number

This command is used to store up to four dialing strings in the modem's nonvolatile memory for later dialing. The format for the command is **&Zn**="stored number" where n is the location 0-3 to which the number should be written. The dial string may contain up to 34 characters. The **ATDS=n** command dials using the string stored in location n.

Result Codes:
OK n=0, 1, 2, 3
ERROR Otherwise

\Nn Error control mode selection

This command determines the type of error control used by the modem when sending or receiving data.

\N0 Buffer mode. No error control.

\N1 Direct mode.

\N2 MNP or disconnect mode. The modem attempts to connect using MNP2-4 error control procedures. If this fails, the modem disconnects.

This is also known as MNP reliable mode.

\N3 V.42, MNP, or buffered (default).
 The modem attempts to connect in V.42 error control mode. If this fails, it attempts to connect in MNP mode. If this fails, it connects in buffer mode and continues operation. This is also known as V.42/MNP auto reliable mode (same as **&Q5**).

\N4 V.42 or disconnect. The modem attempts to connect in V.42 error control mode. If this fails, the modem disconnects.

\N5 V.42. MNP or buffered (same as **\N3**).

\N7 V.42. MNP or buffered (same as **\N3**).

Result Codes:
OK n=0,1,2,3,4,5,7
ERROR Otherwise

\Qn Local flow control selection

\Q0 Disable flow control.

\Q1 XON/XOFF software flow control.

\Q3 CTS/RTS to DTE (default).

Result Codes:
OK n=0,1,3
ERROR Otherwise

\Vn Protocol result code

\V0 Disable protocol result code appended to DCE speed.

\V1 Enable protocol result code appended to DCE speed (default).

Result Codes:
OK n=0,1
ERROR Otherwise

%B View numbers in blacklist

If blacklisting is in effect, this command displays the numbers for which the last call attempted in the past two hours failed. The **ERROR** result code appears in regions that do not require blacklisting.

%Cn Data compression control

This command determines the operation of V.42bis and MNP class 5 data compression. On-line changes do not take effect until a disconnect occurs first.

%C0 V.42bis/MNP 5 disabled. No data compression.

%C3 V.42bis/MNP 5 enabled. Data compression enabled (default).

Result Codes:
OK n=0,3
ERROR Otherwise

Appendix D

S-registers

S-registers contain the settings that determine how a number of functions of the internal modem operate. For example, how many times to let the telephone ring before the modem answers and how long to wait before it hangs up if a connection fails. You can also customize certain AT commands such as the escape sequence and command line termination.

The contents of the registers are changed automatically when you modify corresponding settings in your communication software. If you choose, however, you can display and edit the contents of the registers manually when the modem is in command mode. If the value is out of the acceptable range, then an error is generated.

This chapter describes the settings for each S-register.

S-register values

The format for displaying the value of an S-register is:

ATSn?

where **n** is the register number. After you type in the register press **Enter**.

The format for modifying the value of an S-register is:

ATSn=r

where **n** is the register number, and **r** is the new register value. After you type in the register and its new value press **Enter**.



Some registers vary from one country/region to another.

S0 Auto answer ring number

This register determines the number of rings the modem will count before automatically answering a call. Enter 0 (zero) if you do not want the modem to automatically answer at all. When disabled, the modem can only answer with an ATA command.

Range:0-255

Default:0

Units:rings

S1 Ring counter

This register is read only. The value of S1 is incremented with each ring. If no ring occurs over a six-second interval, this register is cleared.

Range:0-225

Default:0

Units:rings

S2 AT escape character (user defined)

This register determines the ASCII values used for an escape sequence. The default is the + character. The escape sequence allows the modem to exit data mode and enter command mode when on-line. Values greater than 127 disable the escape sequence.

Range:0-255, ASCII decimal

Default:43

Units:ASCII

S3 Command line termination character (user defined)

This register determines the ASCII values as the carriage return character. This character is used to end command lines and result codes.

Range:0-127, ASCII decimal

Default:13 (carriage return)

Units:ASCII

S4 Response formatting character (user defined)

This register determines the ASCII value used as the line feed character. The modem uses a line feed character in command mode when it responds to the computer.

Range:0-127, ASCII decimal

Default:10 (line feed)

Units:ASCII

S5 Command line editing character (user defined)

This register sets the character recognized as a backspace and pertains to asynchronous only. The modem will not recognize the backspace character if it is set to a value that is greater than 32 ASCII. This character can be used to edit a command line. When the echo command is enabled, the modem echoes back to the local DTE the backspace character, an ASCII space character, and a second backspace character. This means a total of three characters are transmitted each time the modem processes the backspace character.

Range:0-127, ASCII decimal

Default:8 (backspace)

Units:ASCII

S6 Wait before dialing

This register sets the length of time, in seconds, that the modem must wait (pause) after going off-hook before dialing the first digit of the telephone number. The modem always pauses for a minimum of two seconds, even if the value of S6 is less than two seconds. The wait for dial tone call progress feature (W dial modifier in the dial string) will override the value in register S6. This operation, however, may be affected by some ATX options according to country/region restrictions. In some countries/regions, S6 will set dial tone detect time.

Range:3-255

Default:3

Units:seconds

S7 Connection completion time-out

This register sets the time, in seconds, that the modem must wait before hanging up because carrier is not detected. The timer is started when the modem finishes dialing (originate), or goes off-hook (answer). In originate mode, the timer is reset upon detection of an answer tone if allowed by county restriction. The timer also specifies the wait for silence time for the @ dial modifier in seconds. S7 is not associated with the W dial modifier.

Range:1-255

Default:50

Units:seconds

S8 Comma pause time

This register sets the time, in seconds, that the modem must pause when it encounters a comma (,) in the dial command string. In some countries/regions, S8 will set both wait before dialing and comma pause time.

Range:0-255

Default:2

Units:seconds

S11 DTMF dialing speed

This register determines the dialing speed which is prefixed for each country/region.

Range:50-255

Default:95

Units:.001 seconds

S12 Escape guard time

This register sets the value (in 20 millisecond increments) for the required pause after the escape sequence.

Range:0-255

Default:50

Units:.02 seconds

S37 Dial line rate

S37 = 0 (default)	maximum modem speed
S37 = 1	reserved
S37 = 2	1200/75 bps
S37 = 3	300 bps
S37 = 4	reserved
S37 = 5	1200 bps
S37 = 6	2400 bps
S37 = 7	4800 bps
S37 = 8	7200 bps
S37 = 9	9600 bps
S37 = 10	12000 bps
S37 = 11	14400 bps
S37 = 12	16800 bps
S37 = 13	19200 bps
S37 = 14	21600 bps
S37 = 15	24000 bps
S37 = 16	26400 bps
S37 = 17	28800 bps
S37 = 18	31200 bps
S37 = 19	33600 bps

AT command set result codes

The following table shows the result codes.

The result code summary

Result Code	Numeric	Description
OK	0	Command executed
CONNECT	1	Modem connected to line
RING	2	A ring signal has been detected
NO CARRIER	3	Modem lost carrier signal, or does not detect carrier signal, or does not detect answer tone
ERROR	4	Invalid command
CONNECT 1200 EC* ₁	5	Connection at 1200 bps
NO DIAL TONE	6	No dial tone detected
BUSY	7	Busy signal detected
NO ANSWER	8	No quiet answer
CONNECT 2400 EC* ₁	10	Connection at 2400 bps
CONNECT 4800 EC* ₁	11	Connection at 4800 bps
CONNECT 9600 EC* ₁	12	Connection at 9600 bps
CONNECT 14400 EC* ₁	13	Connection at 14400 bps
CONNECT 19200 EC* ₁	14	Connection at 19200 bps
CONNECT 7200 EC* ₁	24	Connection at 7200 bps
CONNECT 12000 EC* ₁	25	Connection at 12000 bps
CONNECT 16800 EC* ₁	86	Connection at 16800 bps
CONNECT 300 EC* ₁	40	Connection at 300 bps
CONNECT 21600 EC* ₁	55	Connection at 21600 bps
CONNECT 24000 EC* ₁	56	Connection at 24000 bps
CONNECT 26400 EC* ₁	57	Connection at 26400 bps
CONNECT 28800 EC* ₁	58	Connection at 28800 bps
CONNECT 31200 EC* ₁	59	Connection at 31200 bps

CONNECT 33600 EC* ₁	60	Connection at 33600 bps
DELAYED* ₂	88	Delay is in effect for the dialed number
BLACKLISTED* ₂	89	Dialed number is blacklisted
BLACKLIST FULL* ₂	90	Blacklist is full

*1: EC only appears when the Extended Result Codes configuration option is enabled. EC is replaced by one of the following symbols, depending upon the error control method used:

V.42bis - V.42 error control and V.42bis data compression.

V.42 - V.42 error control only.

MNP 5 - MNP class 4 error control and MNP class 5 data compression.

MNP 4 - MNP class 4 error control only.

NoEC - No error control protocol.

*2: In some countries/regions, these result codes may not appear.

Appendix E

V.90

The TOSHIBA internal modem uses V.90 technology. The modem is capable of downstream speeds of 56kbps (kilobits per second) when connected to an Internet service provider that supports V.90. As with any modem, the actual throughput (speed of data transfer) depends on analog telephone line conditions, which can vary considerably. Therefore, many users will experience throughput in the range of 28-50kbps under normal telephone line conditions. Upstream data flows at the V.34 rate.



V.90 rates can be achieved only when one V.90-capable host modem is connected to another. The TOSHIBA Internal modem will select automatically V.34 if the remote modem lacks V.90 capability or if a combination of network and/or phone line conditions prevent V.90 connection.

V.90 mode

Function	Transmission speed
Data V.90	From 56kbps (maximum) to 28kbps (minimum) Reception only

Table E-1 Result codes for a V.90 connection

No.	Result code	Description
70	CONNECT 32000 EC*	Connection at 32000 bps
72	CONNECT 36000 EC*	Connection at 36000 bps
74	CONNECT 40000 EC*	Connection at 40000 bps
76	CONNECT 44000 EC*	Connection at 44000 bps
78	CONNECT 48000 EC*	Connection at 48000 bps
80	CONNECT 52000 EC*	Connection at 52000 bps
82	CONNECT 56000 EC*	Connection at 56000 bps
100	CONNECT 28000 EC*	Connection at 28000 bps
101	CONNECT 29333 EC*	Connection at 29333 bps
102	CONNECT 30666 EC*	Connection at 30666 bps
103	CONNECT 33333 EC*	Connection at 33333 bps
104	CONNECT 34666 EC*	Connection at 34666 bps
105	CONNECT 37333 EC*	Connection at 37333 bps
106	CONNECT 38666 EC*	Connection at 38666 bps
107	CONNECT 41333 EC*	Connection at 41333 bps
108	CONNECT 42666 EC*	Connection at 42666 bps
109	CONNECT 45333 EC*	Connection at 45333 bps
110	CONNECT 46666 EC*	Connection at 46666 bps
111	CONNECT 49333 EC*	Connection at 49333 bps
112	CONNECT 50666 EC*	Connection at 50666 bps
113	CONNECT 53333 EC*	Connection at 53333 bps
114	CONNECT 54666 EC*	Connection at 54666 bps

*EC stands for the Error Control method, which appears only when the extended result codes configuration option is enabled. EC is replaced by one of the following symbols, depending on the error control method used.

V42bis	V.42 error control and V.42bis data compression
V42	V.42 error control only
NoEC	No error control protocol

AT Command

-V90=*	V.90 Dial Line Rate -V90 sets the maximum V.90 downstream that the modem attempts to connect.
-V90=0	V.90 disabled
-V90=1	V.90 enabled: automatic speed selection - maximum modem speed (default)

Appendix F

Wireless LAN

Card Specifications

Form Factor	PCI Express Mini Card
Compatibility	<ul style="list-style-type: none">■ IEEE 802.11 Standard for Wireless LANs■ Wi-Fi (Wireless Fidelity) certified by the Wi-Fi Alliance. The 'Wi-Fi CERTIFIED' logo is a certification mark of the Wi-Fi Alliance.
Network Operating System	<ul style="list-style-type: none">■ Microsoft Windows® Networking
Media Access Protocol	<ul style="list-style-type: none">■ CSMA/CA (Collision Avoidance) with Acknowledgment (ACK)
Data Rate	<ul style="list-style-type: none">■ Theoretical maximum speed: 54Mbps (IEEE802.11a/IEEE802.11g: 11b/g, 11a/b/g combo type)■ Theoretical maximum speed: 11Mbps (IEEE802.11b)

Radio Characteristics

Radio Characteristics of Wireless LAN Cards may vary according to:

- Country/region where the product was purchased
- Type of product

Wireless communication is often subject to local radio regulations. Although Wireless LAN wireless networking products have been designed for operation in the license-free 2.4GHz and 5GHz band, local radio regulations may impose a number of limitations to the use of wireless communication equipment.



Refer to the sheet "Information to the User" for regulatory information that may apply in your country/region.

R-F Frequency	<ul style="list-style-type: none"> ■ Band 5GHz (5150-5850 MHz) (Revision A) ■ Band 2.4GHz (2400-2483.5 MHz) (Revision B, G)
Modulation Technique	<ul style="list-style-type: none"> ■ DSSS-CCK, DSSS-DQPSK, DSSS-DBPSK (Revision B) ■ OFDM-BPSK, OFDM-QPSK, OFDM-16QAM, OFDM-64QAM (Revision A, G)

The range of the wireless signal is related to the transmit rate of the wireless communication. Communications at lower transmit range may travel larger distances.

- The range of your wireless devices can be affected when the antennas are placed near metal surfaces and solid high-density materials.
- Range is also impacted due to "obstacles" in the signal path of the radio that may either absorb or reflect the radio signal.

Supported Frequency Sub-bands

Subject to the radio regulations that apply in the countries/regions, your Wireless LAN card may support a different set of 5 GHz/2.4 GHz channels. Consult your Authorized Wireless LAN or TOSHIBA Sales office for information about the radio regulations that apply in the countries/regions.

Wireless IEEE 802.11 Channels Sets (Revision B and G)

Frequency Range Channel ID	2400-2483.5 MHz
1	2412
2	2417
3	2422
4	2427
5	2432
6	2437
7	2442
8	2447
9	2452
10	2457 *1
11	2462
12	2467 *2
13	2472 *2

*1 Factory-set default channels

*2 Refer to the sheet *Approved Countries/Regions for use* for the countries/regions that in which these channels can be used. When installing Wireless LAN cards, the channel configuration is managed as follows:

- For wireless clients that operate in a Wireless LAN Infrastructure, the Wireless LAN card will automatically start operation at the channel identified by the Wireless LAN Access Point. When roaming between different access points the station can dynamically switch to another channel if required.

- For Wireless LAN cards installed in wireless clients that operating in a peer-to-peer mode, the card will use the default channel 10.
- In a Wireless LAN Access Point, the Wireless LAN card will use the factory-set default channel (printed in bold), unless the LAN Administrator selected a different channel when configuring the Wireless LAN Access Point device.

Wireless IEEE 802.11 Channels Sets (Revision A)

Frequency Range	5150-5850 MHz
Channel ID	
36	5180
40	5200
44	5220
48	5240
52	5260
56	5280
60	5300
64	5320
100	5500
104	5520
108	5540
112	5560
116	5580
120	5600
124	5620
128	5640
132	5660
136	5680
140	5700

149	5745
153	5765
157	5785
161	5805
165	5825

Appendix G

Bluetooth wireless technology Interoperability

Bluetooth® Cards from TOSHIBA are designed to be interoperable with any product with Bluetooth wireless technology that is based on Frequency Hopping Spread Spectrum (FHSS) radio technology, and is compliant to:

- Bluetooth Specification Ver2.0+EDR, as defined and approved by The Bluetooth Special Interest Group.
- Logo certification with Bluetooth wireless technology as defined by The Bluetooth Special interest Group.



- *Bluetooth wireless technology is a new innovative technology, and TOSHIBA has not confirmed compatibility of its Bluetooth® products with all computers and/or equipment using Bluetooth wireless technology other than TOSHIBA portable computers. Always use Bluetooth® Cards from TOSHIBA in order to enable wireless networks over two or more (up to a total of seven) TOSHIBA portable computers using these cards. Please contact TOSHIBA PC product support on Web site <http://www.toshiba-europe.com/computers/tnt/bluetooth.htm> in Europe or <http://www.pc.support.global.toshiba.com> in the United States for more information.*
- *When you use Bluetooth® Cards from TOSHIBA close to 2.4 GHz Wireless LAN devices, Bluetooth transmissions might slow down or cause errors. If you detect certain interference while you use Bluetooth® Cards from TOSHIBA, always change the frequency, move your computer to the area outside of the interference range of 2.4 GHz Wireless LAN devices (40 meters/43.74 yards or more) or stop transmitting from your computer. Please contact TOSHIBA PC product support on Web site <http://www.toshiba-europe.com/computers/tnt/bluetooth.htm> in Europe or <http://www.pc.support.global.toshiba.com> in the United States for more information.*
- *Bluetooth® and Wireless LAN devices operate within the same radio frequency range and may interfere with one another. If you use Bluetooth® and Wireless LAN devices simultaneously, you may occasionally experience a less than optimal network performance or even lose your network connection. If you should experience any such problem, immediately turn off either one of your Bluetooth® or Wireless LAN. Please contact TOSHIBA PC product support on web site <http://www.toshiba-europe.com/computers/tnt/bluetooth.htm> in Europe or <http://www.pc.support.global.toshiba.com> in the United States for more information.*

Bluetooth wireless technology and your Health

The products with Bluetooth wireless technology, like other radio devices, emit radio frequency electromagnetic energy. The level of energy emitted by devices with Bluetooth wireless technology however is far much less than the electromagnetic energy emitted by wireless devices like for example mobile phones.

Because products with Bluetooth wireless technology operate within the guidelines found in radio frequency safety standards and recommendations, TOSHIBA believes Bluetooth wireless technology is safe for use by consumers. These standards and recommendations reflect the consensus of the scientific community and result from deliberations of panels and committees of scientists who continually review and interpret the extensive research literature.

In some situations or environments, the use of Bluetooth wireless technology may be restricted by the proprietor of the building or responsible representatives of the organization. These situations may for example include:

- Using the equipment with Bluetooth wireless technology on board of airplanes, or
- In any other environment where the risk of interference to other devices or services is perceived or identified as harmful.

If you are uncertain of the policy that applies on the use of wireless devices in a specific organization or environment (e.g. airports), you are encouraged to ask for authorization to use the device with Bluetooth wireless technology prior to turning on the equipment.

Regulatory statements

General

This product complies with any mandatory product specification in any country/region where the product is sold. In addition, the product complies with the following.

European Union (EU) and EFTA

This equipment complies with the R&TTE directive 1999/5/EC and has been provided with the CE mark accordingly.

Canada - Industry Canada (IC)

This device complies with RSS 210 of Industry Canada.

Operation is subject to the following two conditions: (1) this device may not cause interference, and (2) this device must accept any interference, including interference that may cause undesired operation of this device.

L' utilisation de ce dispositif est autorisée seulement aux conditions suivantes: (1) il ne doit pas produire de brouillage et (2) l' utilisateur du dispositif doit être prêt à accepter tout brouillage radioélectrique reçu, même si ce brouillage est susceptible de compromettre le fonctionnement du dispositif.

The term "IC" before the equipment certification number only signifies that the Industry Canada technical specifications were met.

USA-Federal Communications Commission (FCC)

This equipment has been tested and found to comply with the limits for a Class B digital device, pursuant to Part 15 of FCC Rules. These limits are designed to provide reasonable protection against harmful interference in a residential installation. This equipment generates, uses, and can radiate radio frequency energy. If not installed and used in accordance with the instructions, it may cause harmful interference to radio communications. However, there is no guarantee that interference will not occur in a particular installation.

If this equipment does cause harmful interference to radio or television reception, which can be determined by tuning the equipment off and on, the user is encouraged to try and correct the interference by one or more of the following measures:

- Reorient or relocate the receiving antenna
- Increase the distance between the equipment and the receiver.
- Connect the equipment to outlet on a circuit different from that to which the receiver is connected.
- Consult the dealer or an experienced radio/TV technician for help.

TOSHIBA is not responsible for any radio or television interference caused by unauthorized modification of the devices included with this Bluetooth® Card from TOSHIBA, or the substitution or attachment of connecting cables and equipment other than specified by TOSHIBA.

The correction of interference caused by such unauthorized modification, substitution or attachment will be the responsibility of the user.

Caution: Exposure to Radio Frequency Radiation

The radiated output power of the Bluetooth® Card from TOSHIBA is far below the FCC radio frequency exposure limits. Nevertheless, the Bluetooth® Card from TOSHIBA shall be used in such a manner that the potential for human contact during normal operation is minimized. The antenna(s) used in this device are located at the upper edge of the LCD screen, and this device has been tested as portable device as defined in Section 2.1093 of FCC rules when the LCD screen is rotated 180 degree and covered the keyboard area. In addition, Bluetooth has been tested with Wireless LAN transceiver for co-location requirements. This device and its antenna(s) must not be co-located or operating in conjunction with any other antenna or transmitter. The installer of this radio equipment must ensure that the antenna is located or pointed such that it does not emit RF field in excess of Health Canada limits for the general population; consult Safety Code 6, obtainable from Health Canada's website www.hc-sc.gc.ca/rpb.

Taiwan

Article 12 Without permission granted by the DGT, any company, enterprise, or user is not allowed to change frequency, enhance transmitting power or alter original characteristic as well as performance to an approved low power radio-frequency devices.

Article 14 The low power radio-frequency devices shall not influence aircraft security and interfere legal communications; If found, the user shall cease operating immediately until no interference is achieved.

The said legal communications means radio communications is operated in compliance with the Telecommunications Act.

The low power radio-frequency devices must be susceptible with the interference from legal communications or ISM radio wave radiated devices.

Using Bluetooth® Card from TOSHIBA equipment in Japan

In Japan, the frequency bandwidth of 2,400 - 2,483.5 MHz for second generation low-power data communication systems such as this equipment overlaps that of mobile object identification systems (premises radio station and specified low-power radio station).

1. Sticker

Please put the following sticker on computer incorporating this product.

The frequency bandwidth of this equipment may operate within the same range as industrial devices, scientific devices, medical devices, microwave ovens, licensed radio stations and non-licensed specified low-power radio stations for mobile object identification systems (RFID) used in factory production lines (Other Radio Stations).

1. Before using this equipment, ensure that it does not interfere with any of the equipment listed above.
2. If this equipment causes RF interference to other radio stations, promptly change the frequency being used, change the location of use, or turn off the source of emissions.
3. Contact TOSHIBA Direct PC if you have problems with interference caused by this product to Other Radio Stations.

2. Indication

The indication shown below appears on this equipment.

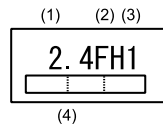

(1) 2.4 : This equipment uses a frequency of 2.4 GHz.

(2) FH : This equipment uses FH-SS modulation.

(3) 1: The interference range of this equipment is less than 10 m.

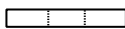
(4)  This equipment uses a frequency bandwidth from 2,400 MHz to 2,483.5 MHz.

It is impossible to avoid the band of mobile object identification systems.

3. TOSHIBA Direct PC

Monday - Friday: 10:00-17:00

Toll Free Tel : 0120-15-1048

Direct Dial: 03-3457-4850

FAX : 03-3457-4868

Device Authorization

This device obtains the Technical Conditions Compliance Approval, and it belongs to the device class of radio equipment of low-power data communication system radio station stipulated in the Telecommunications Business Law.

The Name of the radio equipment: EYXF3CS

JAPAN APPROVALS INSTITUTE FOR TELECOMMUNICATIONS
EQUIPMENT

Approval Number: D05-0074001

The following restrictions apply:

Do not disassemble or modify the device.

Do not install the embedded wireless module into other device.

Appendix H

AC Power Cord and Connectors

The power cord's AC input plug must be compatible with the various international AC power outlets and the cord must meet the standards for the country/region in which it is used. All cords must meet the following specifications:

Length:	Minimum 2 meters
Wire size:	Minimum 0.75 mm ²
Current rating:	Minimum 2.5 amperes
Voltage rating:	125 or 250 VAC (depending on country/region's power standards)

Certification agencies

U.S. and Canada:	UL listed and CSA certified No. 18 AWG, Type SVT or SPT-2		
Australia:	AS		
Japan:	DENANHO		
Europe:			
Austria:	OVE	Italy:	IMQ
Belgium:	CEBEC	The Netherlands:	KEMA
Denmark:	DEMKO	Norway:	NEMKO

Finland:	FIMKO	Sweden:	SEMKO
France:	LCIE	Switzerland:	SEV
Germany:	VDE	United Kingdom:	BSI

In Europe, two conductors power cord must be VDE type, H05VVH2-F or H03VVH2-F and for three conductors power cord must be VDE type, H05VV-F.

For the United States and Canada, two pin plug configuration must be a 2-15P (250V) or 1-15P (125V) and three pin plug configuration must be 6-15P (250V) or 5-15P (125V) as designated in the U.S. National Electrical code handbook and the Canadian Electrical Code Part II.

The following illustrations show the plug shapes for the U.S.A. and Canada, the United Kingdom, Australia and Europe.

USA

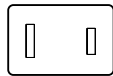

UL approved

Australia

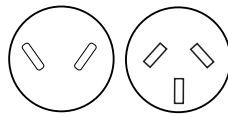

AS approved

Canada

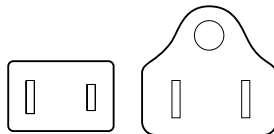

CSA approved

United Kingdom

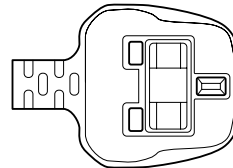

BS approved

Europe

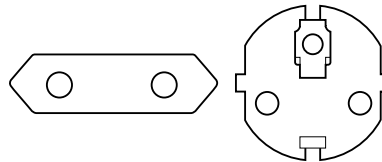

Approved by the appropriate agency

Appendix I

TOSHIBA Anti-theft Protection Timer

This feature allows you to set up a timer-activated BIOS password that will prevent unauthorised system access in the event of theft.

When the time limit is exceeded, you are required to provide the Password or fingerprint authentication for the BIOS and Hard Disk Drive to gain access to the system.

To set permissions and limits for the TOSHIBA Anti-theft Protection Timer please use the TOSHIBA Password Utility.

The settings can only be activated or modified by a user with supervisor authority. If the supervisor password is not set, click on the **Set** button in **Supervisor Password** from the supervisor tab in TOSHIBA Password Utility and set the password on the dialog screen that appears.

Then, click on the **Set** button in TOSHIBA Anti-theft Protection Timer.

Take the following action if the set limit is exceeded.

- If the Supervisor Password is registered but the User Password is not, enter the Supervisor Password to boot up the computer.
- If both the Supervisor Password and the User Password are registered, enter either the Supervisor Password, the User Password or the fingerprint authentication to boot up the computer.



- *The limit counts the number of days from the last time Windows is logged on till the next time the computer is booted up. The range can be set from 1 to 28 days.*
- *Authentication is required if the computer's clock is significantly modified.*
- *If the Supervisor Password is deleted, this function becomes disabled.*

Appendix J

Legal Footnotes

This chapter states the Legal Footnotes information applicable to TOSHIBA computers. In the text in this manual, *XX is used to show which Legal Footnotes description is related to TOSHIBA computers.

Description(s) related to this computer are marked with a blue *XX in this manual. Clicking on *XX will display the related description.

Non-applicable Icons*1

Certain notebook chassis are designed to accommodate all possible configurations for an entire product series. Therefore, please be aware that your selected model may not have all the features and specifications corresponding to all of the icons or switches shown on the notebook chassis.

CPU*2

Central Processing Unit ("CPU") Performance Legal Footnotes.

CPU performance in your computer product may vary from specifications under the following conditions:

- use of certain external peripheral products
- use of battery power instead of AC power
- use of certain multimedia, computer generated graphics or video applications
- use of standard telephone lines or low speed network connections
- use of complex modeling software, such as high end computer aided design applications
- use of several applications or functionalities simultaneously
- use of computer in areas with low air pressure (high altitude >1,000 meters or >3,280 feet above sea level)

- use of computer at temperatures outside the range of 5°C to 30°C (41°F to 86°F) or >25°C (77°F) at high altitude (all temperature references are approximate and may vary depending on the specific computer model - please refer to your PC documentation or visit the Toshiba website at www.pcsupport.toshiba.com for details).

CPU performance may also vary from specifications due to design configuration.

Under some conditions, your computer product may automatically shut-down. This is a normal protective feature designed to reduce the risk of lost data or damage to the product when used outside recommended conditions. To avoid risk of lost data, always make back-up copies of data by periodically storing it on an external storage medium. For optimum performance, use your computer product only under recommended conditions. Read additional restrictions in your product documentation. Contact Toshiba technical service and support, refer to [TOSHIBA support](#) section in Chapter 8 Troubleshooting for more information.

Memory (Main System)*3

Part of the main system memory may be used by the graphics system for graphics performance and therefore reduce the amount of main system memory available for other computing activities. The amount of main system memory allocated to support graphics may vary depending on the graphics system, applications utilized, system memory size and other factors. For PC's configured with 4 GB of system memory, the full system memory space for computing activities will be considerably less and will vary by model and system configuration.

Battery Life*4

Battery life may vary considerably depending on product model, configuration, applications, power management settings and features utilized, as well as the natural performance variations produced by the design of individual components. Published battery life numbers are achieved on select models and configurations tested by Toshiba at the time of publication. Recharge time varies depending on usage. Battery may not charge while computer is consuming full power.

After going through many charge and discharge cycles, the battery will lose its ability to perform at maximum capacity and will need to be replaced. This is a normal phenomenon for all batteries. To purchase a new battery pack, see the accessories information that is shipped with your computer.

Hard Disk Drive (HDD) Capacity*5

1 Gigabyte (GB) means $10^9 = 1,000,000,000$ bytes using powers of 10. The computer operating system, however, reports storage capacity using powers of 2 for the definition of $1 \text{ GB} = 2^{30} = 1,073,741,824$ bytes, and therefore shows less storage capacity. Available storage capacity will also be less if the product includes one or more pre-installed operating systems, such as Microsoft Windows and/or pre-installed software applications, or media content. Actual formatted capacity may vary.

LCD*6

Over a period of time, and depending on the usage of the computer, the brightness of the LCD screen will deteriorate. This is an intrinsic characteristic of LCD technology.

Maximum brightness is only available when operating in AC power mode. The screen will dim when the computer is operated on battery power and you may not be able to increase the brightness of the screen.

Graphics Processor Unit ("GPU")*7

Graphics processor unit ("GPU") performance may vary depending on product model, design configuration, applications, power management settings and features utilized. GPU performance is only optimized when operating in AC power mode and may decrease considerably when operating in battery power mode.

Wireless LAN*8

The transmission speed over the wireless LAN and the distance over which wireless LAN can reach may vary depending on surrounding electromagnetic environment, obstacles, access point design and configuration, and client design and software/hardware configurations.

[54Mbps is the theoretical maximum speed under the IEEE802.11 (a/b/g) standard.] The actual transmission speed will be lower than the theoretical maximum speed.

Copy Protection*9

Copy protection technology included in certain media may prevent or limit recording or viewing of the media.

Images*10

All images are simulated for purposes of illustration.

Glossary

The terms in this glossary cover topics related to this manual. Alternate naming is included for reference.

Abbreviations

AC: alternating current

AGP: accelerated graphics port

ANSI: American National Standards Institute

APM: advanced power manager

ASCII: American Standard Code for Information Interchange

BIOS: basic input output system

CD-ROM: Compact Disc-Read Only Memory

CD-RW: Compact Disc-ReWritable

CMOS: complementary metal-oxide semiconductor

CPU: central processing unit

CRT: cathode ray tube

DC: direct current

DDC: display data channel

DMA: direct memory access

DOS: disk operating system

DVD: digital versatile disc

DVD-R: Digital Versatile Disc-Recordable

DVD-RAM: Digital Versatile Disc-Random Access Memory

DVD-R DL: Digital Versatile Disc Recordable Dual Layer

DVD-ROM: Digital Versatile Disc-Read Only Memory

DVD-RW: Digital Versatile Disc-ReWritable

DVD+R DL: Digital Versatile Disc Recordable Double Layer

ECP: extended capabilities port

FDD: floppy disk drive

FIR: fast infrared

HDD: hard disk drive

IDE: integrated drive electronics

I/O: input/output

IrDA: Infrared Data Association

IRQ: interrupt request
KB: kilobyte
LCD: liquid crystal display
LED: light emitting diode
LSI: large scale integration
MB: megabyte
MS-DOS: Microsoft Disk Operating System
OCR: optical character recognition (reader)
PCB: printed circuit board
PCI: peripheral component interconnect
RAM: random access memory
RGB: red, green, and blue
ROM: read only memory
RTC: real time clock
SCSI: small computer system interface
SIO: serial input/output
SXGA+: super extended graphics array plus
TFT: thin-film transistor
UART: universal asynchronous receiver/transmitter
USB: Universal Serial Bus
UXGA: ultra extended graphics array
VESA: Video Electronic Standards Association
VGA: video graphics array
VRT: voltage reduction technology
WXGA: wide extended graphics array
XGA: extended graphics array

A

adaptor: A device that provides an interface between two dissimilar electronic devices. For example, the AC adaptor modifies the power from a wall outlet for use by the computer. This term also refers to the add-in circuit cards that control external devices, such as video monitors and magnetic tape devices.

allocate: To assign a space or function for a specific task.

alphanumeric: Keyboard characters including letters, numbers and other symbols, such as punctuation marks or mathematical symbols.

alternating current (AC): Electric current that reverses its direction of flow at regular intervals.

analog signal: A signal whose characteristics such as amplitude and frequency vary in proportion to (are an analog of) the value to be transmitted. Voice communications are analog signals.

ANSI: American National Standards Institute. An organization established to adopt and define standards for a variety of technical disciplines. For example, ANSI defined the ASCII standard and other information processing requirements.

antistatic: A material used to prevent the buildup of static electricity.

application: A group of programs that together are used for a specific task such as accounting, financial planning, spreadsheets, word processing and games.

ASCII: American Standard Code for Information Interchange. ASCII code is a set of 256 binary codes that represent the most commonly used letters, numbers, and symbols.

async: Short for asynchronous.

asynchronous: Lacking regular time relationship. As applied to computer communications, asynchronous refers to the method of transmitting data that does not require a steady stream of bits to be transmitted at regular time intervals.

B

backup: A duplicate copy of files kept as a spare in case the original is destroyed.

batch file: A file that can be executed from the system prompt containing a sequence of operating system commands or executable files.

binary: The base two number system composed of zeros and ones (off or on), used by most digital computers. The right-most digit of a binary number has a value of 1, the next a value of 2, then 4, 8, 16, and so on. For example, the binary number 101 has a value of 5. *See also* ASCII.

BIOS: Basic Input Output System. The firmware that controls data flow within the computer. *See also* firmware.

bit: Derived from "binary digit," the basic unit of information used by the computer. It is either zero or one. Eight bits is one byte. *See also* byte.

board: A circuit board. An internal card containing electronic components, called chips, which perform a specific function or increase the capabilities of the system.

boot: Short for bootstrap. A program that starts or restarts the computer. The program reads instructions from a storage device into the computer's memory.

bps: Bits per second. Typically used to describe the data transmission speed of a modem.

buffer: The portion of the computer's memory where data is temporarily stored. Buffers often compensate for differences in the rate of flow from one device to another.

bus: An interface for transmission of signals, data or electric power.

byte: The representation of a single character. A sequence of eight bits treated as a single unit; also the smallest addressable unit within the system.

C

cache memory: High speed memory which stores data that increases processor speed and data transfer rate. When the CPU reads data from main memory, it stores a copy of this data in cache memory. The next time the CPU needs that same data, it looks for it in the cache memory rather than the main memory, which saves time. The computer has two cache levels. Level one is incorporated into the processor and level two resides in external memory.

capacity: The amount of data that can be stored on a magnetic storage device such as a floppy disk or hard disk. It is usually described in terms of kilobytes (KB), where one KB = 1024 bytes and megabytes (MB), where one MB = 1024 KB.

card: Synonym for board. See board.

CardBus: An industry standard bus for 32-bit PC cards.

CD-ROM: A Compact Disc-Read Only Memory is a high capacity disc that can be read from but not written to. The CD-ROM drive uses a laser, rather than magnetic heads, to read data from the disc.

CD-R: A Compact Disc-Recordable disc can be written once and read many times. See also CD-ROM.

CD-RW: A Compact Disc-ReWritable disc can be rewritten many times. See also CD-ROM.

character: Any letter, number, punctuation mark, or symbol used by the computer. Also synonymous with byte.

chassis: The frame containing the computer.

chip: A small semiconductor containing computer logic and circuitry for processing, memory, input/output functions and controlling other chips.

CMOS: Complementary Metal-Oxide Semiconductor. An electronic circuit fabricated on a silicon wafer that requires very little power. Integrated circuits implemented in CMOS technology can be tightly packaged and are highly reliable.

cold start: Starting a computer that is currently off (turning on the power).

COM1, COM2, COM3 and COM4: The names assigned to the serial and communication ports.

commands: Instructions you enter at the terminal keyboard that direct the actions of the computer or its peripheral devices.

communications: The means by which a computer transmits and receives data to and from another computer or device. See parallel interface; serial interface.

compatibility: 1) The ability of one computer to accept and process data in the same manner as another computer without modifying the data or the media upon which it is being transferred.

2) the ability of one device to connect to or communicate with another system or component.

components: Elements or parts (of a system) which make up the whole (system).

computer program: A set of instructions written for a computer that enable it to achieve a desired result.

computer system: A combination of hardware, software, firmware, and peripheral components assembled to process data into useful information.

configuration: The specific components in your system (such as the terminal, printer, and disk drives) and the settings that define how your system works. You use the HW Setup program to control your system configuration.

control keys: A key or sequence of keys you enter from the keyboard to initiate a particular function within a program.

controller: Built-in hardware and software that controls the functions of a specific internal or peripheral device (e.g. keyboard controller).

co-processor: A circuit built into the processor that is dedicated to intensive math calculations.

CPS: Characters Per Second. Typically used to indicate the transmission speed of a printer.

CPU: Central Processing Unit. The portion of the computer that interprets and executes instructions.

CRT: Cathode Ray Tube. A vacuum tube in which beams projected on a fluorescent screen-producing luminous spots. An example is the television set.

cursor: A small, blinking rectangle or line that indicates the current position on the display screen.

D

data: Information that is factual, measurable or statistical that a computer can process, store, or retrieve.

data bits: A data communications parameter controlling the number of bits (binary digits) used to make up a byte. If data bits = 7 the computer can generate 128 unique characters. If data bits = 8 the computer can generate 256 unique characters.

DC: Direct Current. Electric current that flows in one direction. This type of power is usually supplied by batteries.

default: The parameter value automatically selected by the system when you or the program do not provide instructions. Also called a preset value.

delete: To remove data from a disk or other data storage device.
Synonymous with erase.

device driver: A program that controls communication between a specific peripheral device and the computer. The CONFIG.SYS file contains device drivers that MS-DOS loads when you turn the computer on.

dialog box: A window that accepts user input to make system settings or record other information.

disk drive: The device that randomly accesses information on a disk and copies it to the computer's memory. It also writes data from memory to the disk. To accomplish these tasks, the unit physically rotates the disk at high speed past a read-write head.

disk storage: Storing data on magnetic disk. Data is arranged on concentric tracks much like a phonograph record.

display: A CRT, LCD, or other image producing device used to view computer output.

documentation: The set of manuals and/or other instructions written for the users of a computer system or application. Computer system documentation typically includes procedural and tutorial information as well as system functions.

DOS: Disk Operating System. See operating system.

driver: A software program, generally part of the operating system, that controls a specific piece of hardware (frequently a peripheral device such as a printer or mouse).

DVD-R (+R, -R): A Digital Versatile Disc-Recordable disk can be written once and read many times. The DVD-R drive uses a laser to read data from the disc.

DVD-RAM: A Digital Versatile Disc-Random Access Memory is a high-capacity, high performance disc that lets you store large volumes of data. The DVD-ROM drive uses a laser to read data from the disc.

DVD-R DL: A disc having two layers on one side with the DVD-R storage capacity about 1.8 times larger than before. The DVD-RW drive uses a laser to read data from the disc.

DVD-ROM: A Digital Versatile Disc-Read Only Memory is a high capacity, high performance disc suitable for play back of video and other high-density files. The DVD-ROM drive uses a laser to read data from the disc.

DVD-RW (+RW, -RW): A Digital Versatile Disc-ReWritable disc can be rewritten many times.

DVD+R DL: A disc having two layers on one side with the DVD+R storage capacity about 1.8 times larger than before. The DVD-RW drive uses a laser to read data from the disc.

E

echo: To send back a reflection of the transmitted data to the sending device. You can display the information on the screen, or output it to the printer, or both. When a computer receives back data it transmitted to a CRT (or other peripheral device) and then retransmits the data to printer, the printer is said to echo the CRT.

erase: See delete.

escape: 1) A code (ASCII code 27), signaling the computer that what follows are commands; used with peripheral devices such as printers and modems.
2) A means of aborting the task currently in progress.

escape guard time: A time before and after an escape code is sent to the modem which distinguishes between escapes that are part of the transmitted data, and escapes that are intended as a command to the modem.

execute: To interpret and execute an instruction.

Extended Capability Port: An industry standard that provides a data buffer, switchable forward and reverse data transmission, and run length encoding (RLE) support.

F

fast infrared: An industry standard that enables cableless infrared serial data transfer at speeds of up to 4 Mbps.

file: A collection of related information; a file can contain data, programs, or both.

fingerprint sensor: The fingerprint sensor compares and analyzes the unique characteristics in a fingerprint.

firmware: A set of instructions built into the hardware which controls and directs a microprocessor's activities.

floppy disk: A removable disk that stores magnetically encoded data.

floppy disk drive (FDD): An electromechanical device that reads and writes to floppy disks.

Fn-esse: A TOSHIBA utility that lets you assign functions to hot keys.

folder: An icon in Windows used to store documents or other folders.

format: The process of readying a blank disk for its first use. Formatting establishes the structure of the disk that the operating system expects before it writes files or programs onto the disk.

function keys: The keys labeled **F1** through **F12** that tell the computer to perform certain functions.

G

gigabyte (GB): A unit of data storage equal to 1024 megabytes. See also megabyte.

graphics: Drawings, pictures, or other images, such as charts or graphs, to present information.

H

hard disk: A non-removable disk usually referred to as drive C. The factory installs this disk and only a trained engineer can remove it for servicing. Also called fixed disk.

hard disk drive (HDD): An electromechanical device that reads and writes a hard disk. See *also* hard disk.

hardware: The physical electronic and mechanical components of a computer system: typically, the computer itself, external disk drives, etc. See *also* software and firmware.

hertz: A unit of wave frequency that equals one cycle per second.

hexadecimal: The base 16 numbering system composed of the digits 0 through 9 and the letters A, B, C, D, E, and F.

host computer: The computer that controls, regulates, and transmits information to a device or another computer.

hot key: The computer's feature in which certain keys in combination with the extended function key, **Fn**, can be used to set system parameters, such as speaker volume.

HW Setup: A TOSHIBA utility that lets you set the parameters for various hardware components.

I

icon: A small graphic image displayed on the screen or in the indicator panel. In Windows, an icon represents an object that the user can manipulate.

i.LINK (IEEE1394): This port enables high-speed data transfer directly from external devices such as digital video cameras.

infrared port: A cableless communications port capable of using infrared signals to send serial data.

input: The data or instructions you provide to a computer, communication device or other peripheral device from the keyboard or external or internal storage devices. The data sent (or output) by the sending computer is input for the receiving computer.

instruction: Statements or commands that specify how to perform a particular task.

interface: 1) Hardware and/or software components of a system used specifically to connect one system or device to another.
2) To physically connect one system or device to another to exchange information.
3) The point of contact between user, the computer, and the program, for example, the keyboard or a menu.

interrupt request: A signal that gives a component access to the processor.

I/O: Input/output. Refers to acceptance and transfer of data to and from a computer.

I/O devices: Equipment used to communicate with the computer and transfer data to and from it.

IrDA 1.1: An industry standard that enables cableless infrared serial data transfer at speeds of up to 4 Mbps.

J

jumper: A small clip or wire that allows you to change the hardware characteristics by electrically connecting two points of a circuit.

K

K: Taken from the Greek word kilo, meaning 1000; often used as equivalent to 1024, or 2 raised to the 10th power. *See also* byte and kilobyte.

KB: *See* kilobyte.

keyboard: An input device containing switches that are activated by manually pressing marked keys. Each keystroke activates a switch that transmits a specific code to the computer. For each key, the transmitted code is, in turn, representative of the (ASCII) character marked on the key.

kilobyte (KB): A unit of data storage equal to 1024 bytes. *See also* byte and megabyte.

L

level 2 cache: *See* cache.

Light Emitting Diode (LED): A semiconductor device that emits light when a current is applied.

Liquid Crystal Display (LCD): Liquid crystal sealed between two sheets of glass coated with transparent conducting material. The viewing-side coating is etched into character forming segments with leads that extend to the edge of the glass. Applying a voltage between the glass sheets alters the brightness of the liquid crystal.

LSI: Large Scale Integration.

- 1) A technology that allows the inclusion of up to 100,000 simple logic gates on a single chip.
- 2) An integrated circuit that uses large scale integration.

M

main board: *See* motherboard.

megabyte (MB): A unit of data storage equal to 1024 kilobytes. *See also* kilobyte.

megahertz: A unit of wave frequency that equals 1 million cycles per second. *See also* hertz.

menu: A software interface that displays a list of options on the screen. Also called a screen.

microprocessor: A hardware component contained in a single integrated circuit that carries out instructions. Also called the central processing unit (CPU), one of the main parts of the computer.

mode: A method of operation, for example, the boot mode, Standby Mode or the Hibernation Mode.

modem: Derived from modulator/demodulator, a device that converts (modulates) digital data for transmission over telephone lines and then converts modulated data (demodulates) to digital format where received.

monitor: A device that uses rows and columns of pixels to display alphanumeric characters or graphic images. *See also* CRT.

motherboard: A name sometimes used to refer to the main printed circuit board in processing equipment. It usually contains integrated circuits that perform the processor's basic functions and provides connectors for adding other boards that perform special functions. Sometimes called a main board.

MP3: An audio compression standard that enables high-quality transmission and real-time playback of sound files.

N

non-system disk: A formatted floppy disk you can use to store programs and data but you cannot use to start the computer. *See* system disk.

nonvolatile memory: Memory, usually read-only (ROM), that is capable of permanently storing information. Turning the computer's power off does not alter data stored in nonvolatile memory.

numeric keypad overlay: A feature that allows you to use certain keys on the keyboard to perform numeric entry, or to control cursor and page movement.

O

OCR: Optical Character Recognition (reader). A technique or device that uses laser or visible light to identify characters and input them into a storage device.

online state: A functional state of a peripheral device when it is ready to receive or transmit data.

operating system: A group of programs that controls the basic operation of a computer. Operating system functions include interpreting programs, creating data files, and controlling the transmission and receipt (input/output) of data to and from memory and peripheral devices.

output: The results of a computer operation. Output commonly indicates data.
1) printed on paper, 2) displayed at a terminal, 3) sent through the serial port of internal modem, or 4) stored on some magnetic media.

P

parallel interface: Refers to a type of information exchange that transmits information one byte (8 bits) at a time. *See also* serial interface.

parity: 1) The symmetrical relationship between two parameter values (integers) both of which are either on or off; odd or even; 0 or 1.
2) In serial communications, an error detection bit that is added to a group of data bits making the sum of the bits even or odd. Parity can be set to none, odd, or even.

password: A unique string of characters used to identify a specific user. The computer provides various levels of password protection such as user, supervisor and eject.

pel: The smallest area of the display that can be addressed by software. Equal in size to a pixel or group of pixels. *See* pixel.

peripheral component interconnect: An industry standard 32-bit bus.

peripheral device: An I/O device that is external to the central processor and/or main memory such as a printer or a mouse.

pixel: A picture element. The smallest dot that can be made on a display or printer. Also called a pel.

plug and play: A capability with Windows that enables the system to automatically recognize connections of external devices and make the necessary configurations in the computer.

port: The electrical connection through which the computer sends and receives data to and from devices or other computers.

Power Saver: A TOSHIBA utility that lets you set the parameters for various power-saving functions.

printed circuit board (PCB): A hardware component of a processor to which integrated circuits and other components are attached. The board itself is typically flat and rectangular, and constructed of fiberglass, to form the attachment surface.

program: A set of instructions a computer can execute that enables it to achieve a desired result. *See also* application.

prompt: A message the computer provides indicating it is ready for or requires information or an action from you.

R

Radio frequency interference (RFI) shield: A metal shield enclosing the printed circuit boards of the printer or computer to prevent radio and TV interference. All computer equipment generates radio frequency signals. The FCC regulates the amount of signals a computing device can allow past its shielding. A Class A device is sufficient for office use. Class B provides a more stringent classification for home equipment use. TOSHIBA portable computers comply with Class B computing device regulations.

Random Access Memory (RAM): High speed memory within the computer circuitry that can be read or written to.

restart: Resetting a computer without turning it off (also called "warm boot" or "soft reset"). See *also* boot.

RGB: Red, green, and blue. A device that uses three input signals, each activating an electron gun for a primary additive color (red, green, and blue) or port for using such a device. See *also* CRT.

RJ11: A modular telephone jack.

RJ45: A modular LAN jack.

ROM: Read Only Memory: A nonvolatile memory chip manufactured to contain information that controls the computer's basic operation. You cannot access or change information stored in ROM.

S

SCSI: Small Computer System Interface is an industry standard interface for connection of a variety of peripheral devices.

SD card: Secure Digital cards are flash memory widely used in a variety of digital devices such as digital cameras and Personal Digital Assistants.

serial communications: A communications technique that uses as few as two interconnecting wires to send bits one after another.

serial interface: Refers to a type of information exchange that transmits information sequentially, one bit at a time. Contrast: Parallel interface.

SIO: Serial Input/Output. The electronic methodology used in serial data transmission.

soft key: Key combinations that emulate keys on the IBM keyboard, change some configuration options, stop program execution, and access the numeric keypad overlay.

software: The set of programs, procedures and related documentation associated with a computer system. Specifically refers to computer programs that direct and control the computer system's activities. See *also* hardware.

stop bit: One or more bits of a byte that follow the transmitted character or group codes in asynchronous serial communications.

subpixel: Three elements, one red, one green and blue (RGB), that make up a pixel on the color LCD. The computer sets subpixels independently, each may emit a different degree of brightness. See *also* pixel.

synchronous: Having a constant time interval between successive bits, characters or events.

system disk: A disk that has been formatted with an operating system. For MS-DOS the operating system is contained in two hidden files and the COMMAND.COM file. You can boot a computer using a system disk. Also called an operating system disk.

T

terminal: A typewriter-like keyboard and CRT display screen connected to the computer for data input/output.

TFT display: A liquid crystal display (LCD) made from an array of liquid crystal cells using active-matrix technology with thin film transistor (TFT) to drive each cell.

Touch Pad: A pointing device integrated into the TOSHIBA computer palm rest.

TTL: Transistor-transistor logic. A logic circuit design that uses switching transistors for gates and storage.

U

Universal Serial Bus: This serial interface lets you communicate with several devices connected in a chain to a single port on the computer.

V

VGA: Video Graphics Array is an industry standard video adaptor that lets you run any popular software.

volatile memory: Random access memory (RAM) that stores information as long as power is supplied to the computer.

W

warm start: Restarting or resetting a computer without turning it off.

window: A portion of the screen that can display its own application, document or dialog box. Often used to mean a Microsoft Windows window.

Wireless LAN: Local Area Network (LAN) through wireless communication.

write protection: A method for protecting a floppy disk from accidental erasure.

Index

A

- AC adaptor 3-3
 - additional 3-28, 3-38
 - connecting 1-6
- ASCII characters 5-9

B

- Battery
 - charging 6-8
 - extending life 6-10
 - indicator 2-12, 6-4
 - location 2-7
 - monitoring capacity 6-9
 - real time clock 3-3, 6-6
 - save mode 3-7
 - types 6-5
- Battery charger 3-29, 3-38
- Battery pack 2-7, 3-2
 - additional 3-27
 - replacing 6-11
- BIOS Setup 7-8
- Bluetooth 3-5, 4-37
 - Bluetooth Stack for Windows by Toshiba 3-9
 - problems 8-21
 - Wireless Optical Mouse with Bluetooth Technology 3-37
 - Wireless Stereo Headset with Bluetooth Technology 3-37
- Boot Priority 7-3
- Bridge media slot 2-4
 - indicator 2-11
 - using 3-15

C

- Cache memory 3-1
- Cleaning the computer 4-42
- Cooling vents 2-3, 2-7

D

- DC IN indicator 2-11, 6-4
- Display 3-4
 - automatic power off 3-6
 - brightness decrease 5-5
 - brightness increase 5-5
 - controller B-1
 - hinge 2-9
 - opening 1-8
 - screen 2-9
- DLA for TOSHIBA 3-11, 4-30
- Docking port 2-7
- Documentation list 1-2
- DVD Super Multi drive
 - problems 8-11
 - using 4-19
 - writing 4-25
- DVD-ROM drive
 - problems 8-9
 - using 4-19
- DVD-ROM&CD-R/RW drive
 - problems 8-10
 - using 4-19
 - writing 4-23

E

- Equipment checklist 1-1
- External monitor 2-6, 3-31
 - problems 8-18

F

Fingerprint Sensor
 location 2-8
 problems 8-16
 using 4-12

Floppy disk care 4-31

Fn + Ctrl (enhanced keyboard simulation)
 5-3

Fn + Enter 5-3

Fn + Esc (sound mute) 5-3

Fn + F1 (instant security) 5-4

Fn + F10 (Arrow mode) 5-3

Fn + F11 (Numeric mode) 5-3

Fn + F12 (ScrLock) 5-3

Fn + F2 (power save mode) 5-4

Fn + F3 (standby) 5-4

Fn + F4 (hibernation) 5-4

Fn + F5 (display selection) 5-4

Fn + F6 (internal LCD screen brightness
 decreases) 5-5

Fn + F7 (internal LCD screen brightness in-
 creases) 5-5

Fn + F8 (wireless setting) 5-5

Fn + F9 (Touch Pad) 5-5

Fn + space (LCD screen resolution selec-
 tion) 5-6

Fn + Tab (Optical disc drive power) 5-6

Fn-esse 3-9

Function keys 5-2

G

Graphics controller 3-4

H

Hard disk drive 3-3
 automatic power off 3-6

HDD indicator 2-12

Heat dispersal 3-7, 4-45

Hibernation 3-8, 5-4

Hot keys 3-6
 display selection 5-4
 instant security 5-4
 Internal LCD screen brightness de-
 crease 5-5
 Internal LCD screen brightness in-
 crease 5-5

power save mode 5-4
 sound mute 5-3
 standby 5-4
 wireless setting 5-5

HW Setup 3-8

accessing 7-1

Boot priority 7-3

CPU 7-6

device config 7-7

display 7-2

general 7-2

keyboard 7-5

LAN 7-6

USB 7-7

window 7-1

I

i.LINK 2-4, 3-34
 connecting 3-35
 disconnecting 3-35
 precautions 3-34
 problems 8-19

Indicators 2-11, 6-4

K

Keyboard 5-1
 emulating enhanced keyboard 5-2

Fn Sticky key 5-6

Function keys F1...F12 5-2

Hot keys 5-3
 problems 8-7
 typewriter keys 5-1
 Windows special keys 5-7

Keypad overlay 3-6, 5-7
 Arrow mode 5-7
 Numeric mode 5-8
 temporarily using normal keyboard
 (overlay on) 5-8
 temporarily using overlay (overlay off)
 5-8
 turning on the overlays 5-7

L

LAN 3-5, 4-40
 cable types 4-40
 connecting 4-40
 disconnecting 4-41

jack 2-6
LAN active indicator 2-6
Link indicator 2-6
problems 8-20

M

Media care 3-15, 4-31
 Card care 3-15
 CD/DVDs 4-31
 floppy disks 4-31
 Memory card care 3-15
Memory 3-2
 expansion 3-22, 3-38
 installing 3-23
 problems 8-17
 removing 3-26
Memory Stick/Memory Stick Pro 3-18
 inserting 3-18
 problems 8-13
 removing 3-19
Modem 3-5, 4-33
 connecting 4-35
 disconnecting 4-36
 jack 2-5
 problems 8-19
 properties menu 4-34
 region selection 4-33
Moving the computer 4-42
MultiMediaCard 3-20
 inserting 3-21
 problems 8-14
 removing 3-21

P

Password
 power on 3-6
 problems 8-7
 starting the computer by 6-16
 Supervisor 6-15
 user 6-13
PC card 3-13
 inserting 3-13
 location of slot 2-3
 problems 8-12
 removing 3-14
Pointing Device
 Reserve Pen 4-2

Tablet PC Pen 4-2
Touch Pad 2-9, 4-1
Touch Pad control buttons 2-9, 4-1
Touch Pad location 2-8
 using 4-1

Power

 button location 2-8
 conditions 6-1
 hibernation mode 1-11
 indicators 6-4
 panel on/off 3-7, 6-18
 shut down mode (boot mode) 1-9
 standby mode 1-10
 system auto off 6-18
 turning off 1-9
 turning on 1-8

Problems

 AC power 8-5
 Analyzing symptoms 8-2
 Battery 8-5
 Bluetooth 8-21
 DVD Super Multi drive 8-11
 DVD-ROM drive 8-9
 DVD-ROM&CD-R/RW drive 8-10
 External monitor 8-18
 Fingerprint Sensor 8-16
 Hard disk drive 8-8
 Hardware and system checklist 8-3
 i.LINK (IEEE1394) device 8-19
 Internal LCD display panel 8-8
 Keyboard 8-7
 LAN 8-20
 Memory expansion 8-17
 Memory Stick/Memory Stick Pro 8-13
 Modem 8-19
 MultiMediaCard 8-14
 Overheating power down 8-4
 Password 8-7
 PC card 8-12
 Pointing device 8-14
 Power 8-4
 Real Time Clock 8-7
 SD card 8-13
 Self test 8-4
 Sound system 8-18
 System start-up 8-3
 TOSHIBA support 8-22

- Touch Pad 8-14
- TV output signal 8-19
- USB device 8-17
- USB floppy disk drive 8-12
- USB mouse 8-15
- Wireless LAN 8-21
- xD picture card 8-13

Processor 3-1

R

- RecordNow! 3-10, 4-29
- Recovery HDD 1-14
- Recovery Media 1-14
- Restarting the computer 1-13

S

- SD card 3-16
 - formatting 3-18
 - inserting 3-16
 - problems 8-13
 - removing 3-17
- SD memory card 3-17
- SDIO card 3-18
- Security lock 3-37
 - location 2-3
- Slice Expansion Battery 3-38, 6-6
- Soft keys
 - enhanced keyboard 5-2
 - Enter 5-3
 - right Ctrl key 5-3
 - ScrLock 5-3
- Sound system 4-32
 - headphone jack 2-2
 - microphone jack 2-2
 - microphones 2-2
 - mute hot keys 5-3
 - problems 8-18
 - Stereo speakers 2-9
 - volume control 2-3
- Standby 3-8
 - setting 1-10
 - System automatic 3-6

T

- TOSHIBA Assist 3-10
- TOSHIBA ConfigFree 3-10
- TOSHIBA Controls 3-8

- TOSHIBA Express Port Replicator 3-36, 3-38
- TOSHIBA HDD Protection 3-7
- TOSHIBA Mic Effect 3-10
- TOSHIBA Mobile Extension 3-10
- TOSHIBA PC Diagnostic Tool 3-10
- TOSHIBA Power Saver 3-8
- TOSHIBA SD Memory Boot Utility 3-9
- TOSHIBA Zooming Utility 3-9
- Touch Pad 8-14
- TV 3-32

U

- USB device
 - problems 8-17
- USB floppy disk drive
 - problems 8-12

V

- Video RAM 3-2
- Volume control 2-3

W

- Wireless communication 4-36
 - indicator 2-12, 4-39
- Wireless communication switch 2-2, 4-39
- Wireless LAN 3-5, 4-36
 - problems 8-21

X

- xD picture card 3-19
 - inserting 3-20
 - problems 8-13
 - removing 3-20