

# 1 Assembling your Dyson

**DC  
04**

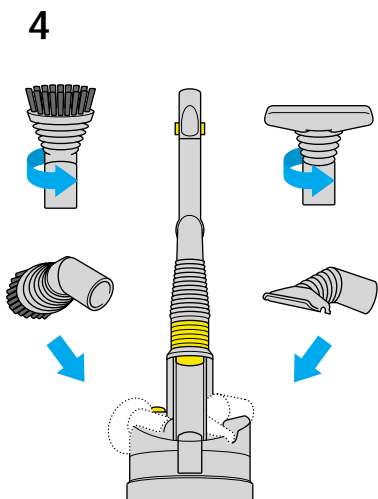

Twist tools before locating.

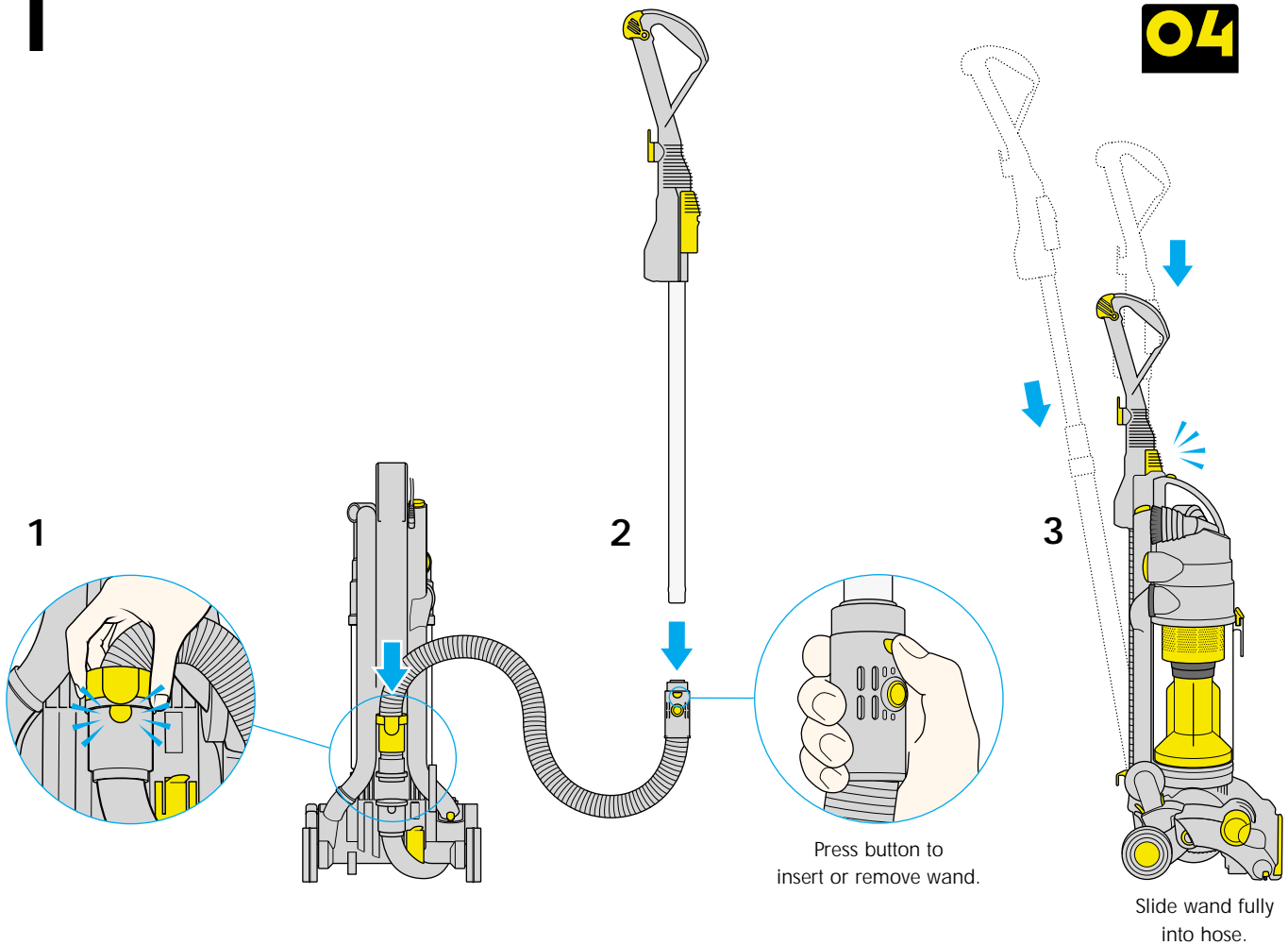
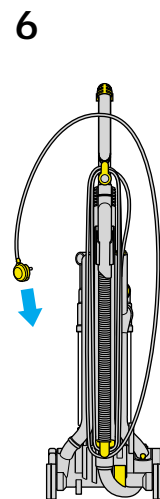
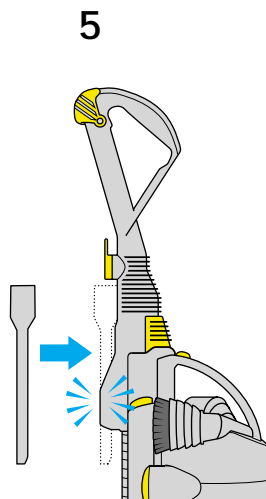

Wind cable around cable winder, in an anti-clockwise direction.

**dyson**  
USER GUIDE

IMPORTANT SAFETY INSTRUCTIONS  
Please read carefully before use



# 2 Operating your Dyson

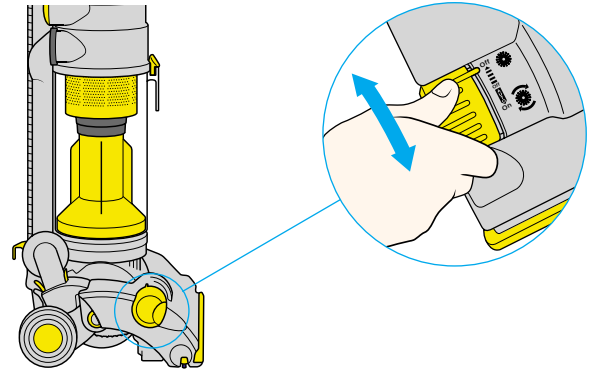
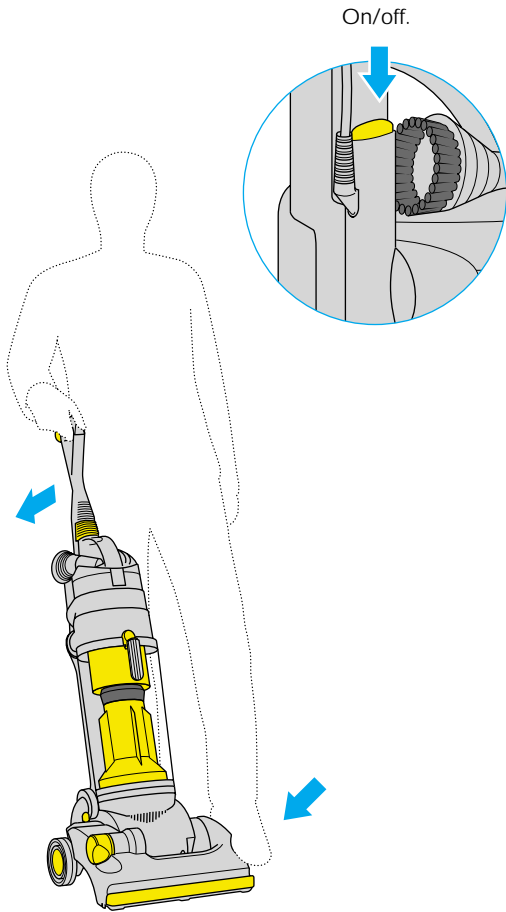

- For hard floors and delicate rugs (Brushbar OFF)  
Select manually and return to start position when finished.
- Start position (Brushbar OFF)
- For carpet cleaning (Brushbar ON)  
Selected automatically from start position.

**SAFETY ALERT**

Ratchet noise warns if brushbar is obstructed.  
Turn off cleaner, unplug from mains and clear obstruction.

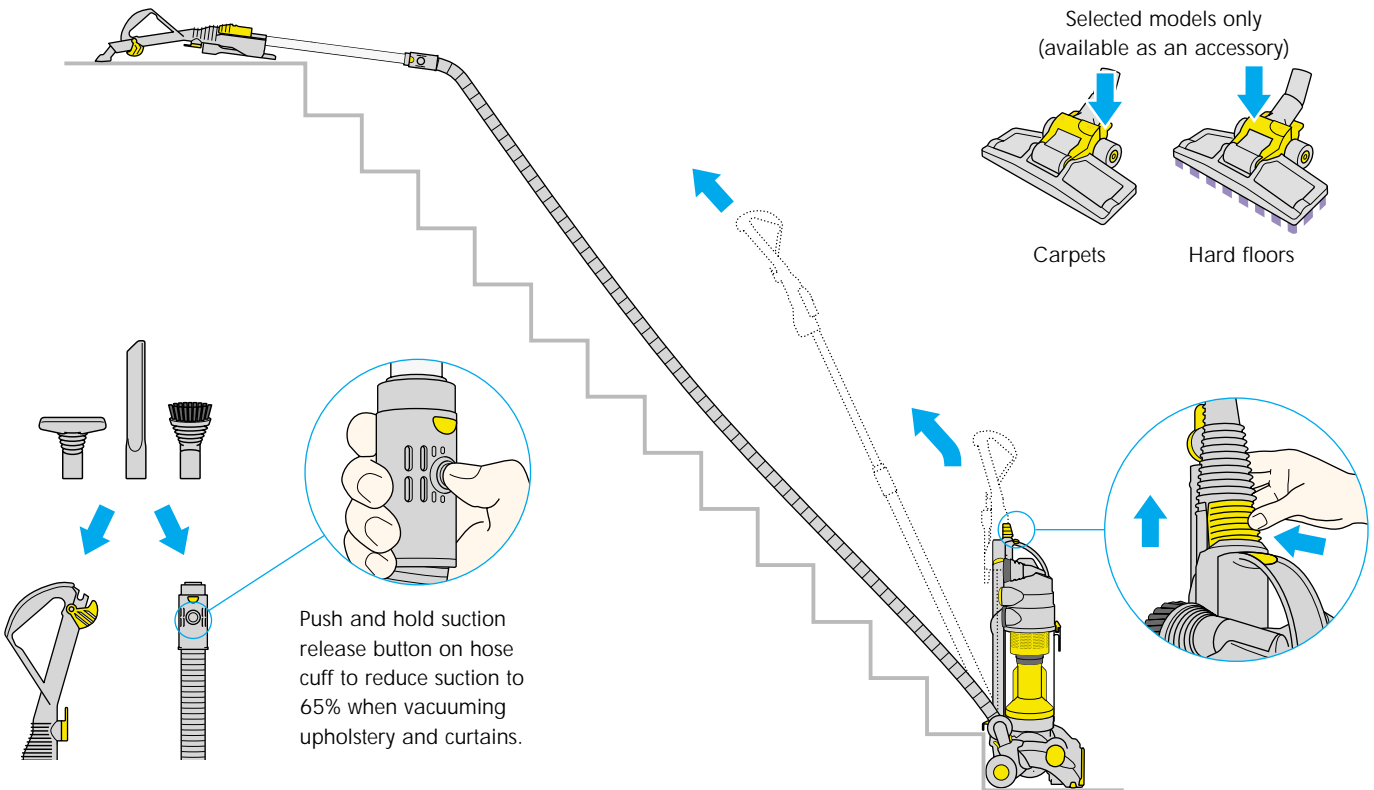

Push and hold suction release button on hose cuff to reduce suction to 65% when vacuuming upholstery and curtains.

**⚠** Always work above the cleaner on the stairs. Unplug the cleaner when not in use. Turn the cleaner off before unplugging from the mains.

# 3 Washing your pre-motor filter

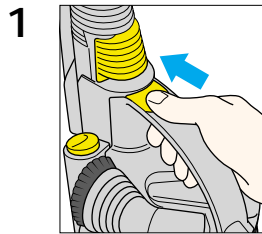
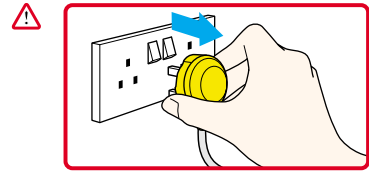

1 Remove clear bin™.

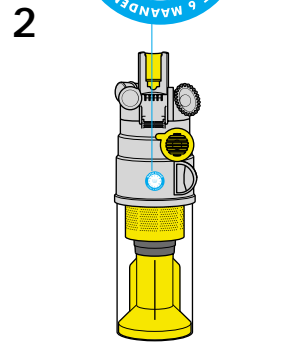

2

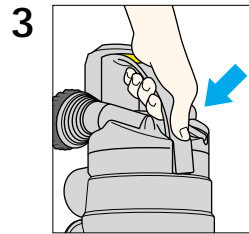

3

Press catch to release pre-motor filter.

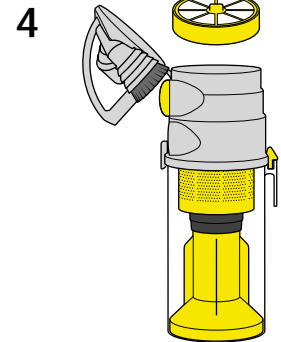

4

Circle your two 6 monthly washes



5

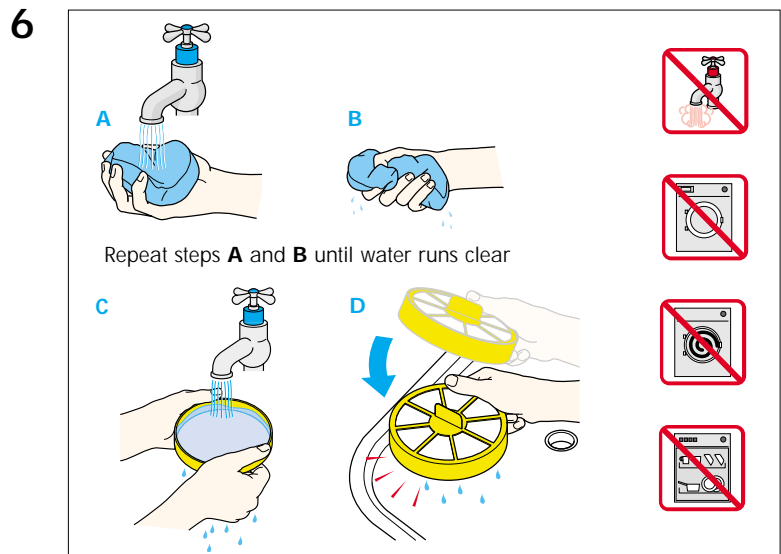

6

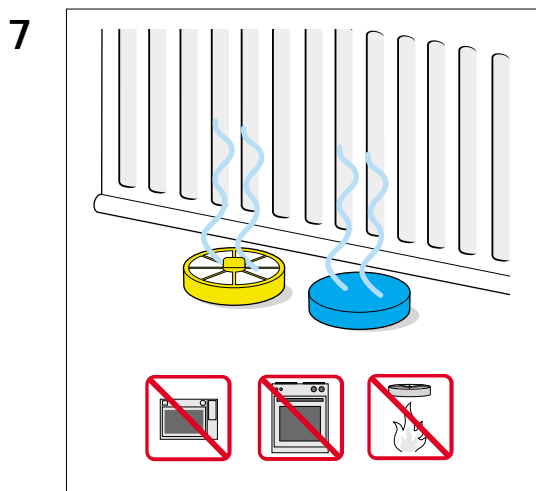

7

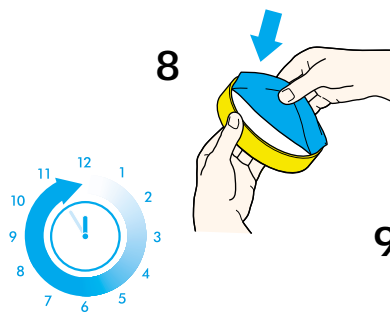

8

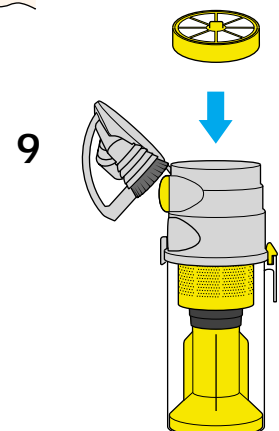

9

 Allow 12 hours for filter to dry. Make sure it is completely dry before replacing in the machine.

# 4

## Emptying your clear bin™

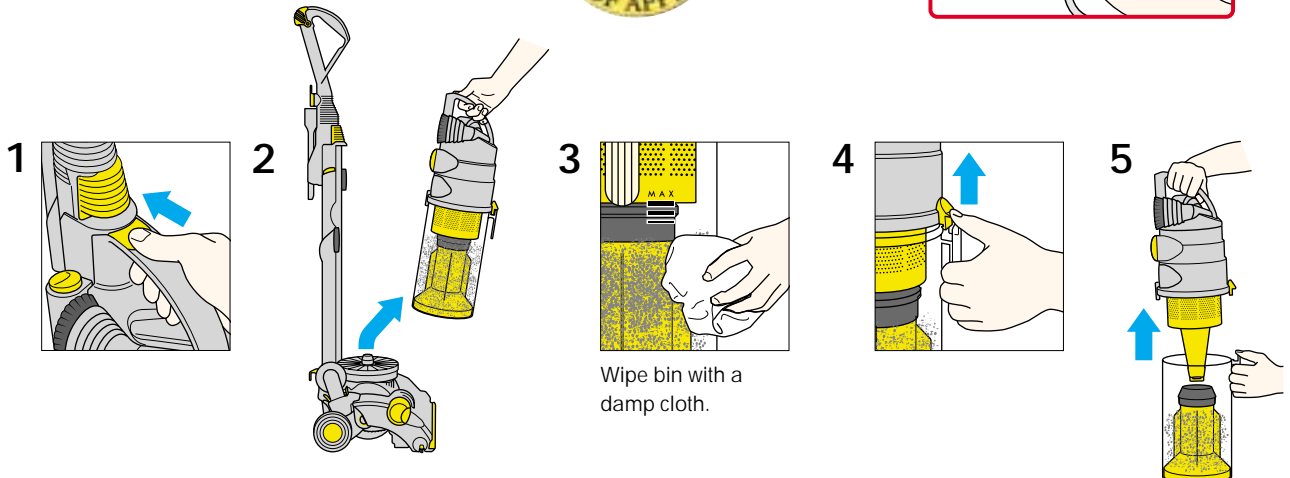
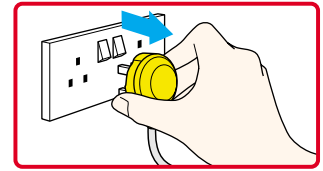

## 6

Empty into a plastic bag (recommended for asthma/allergy sufferers)...

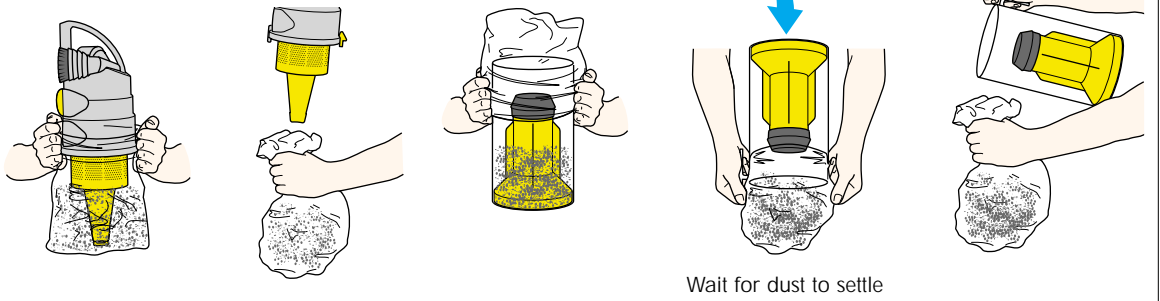

Wait for dust to settle

...or directly into a dustbin.

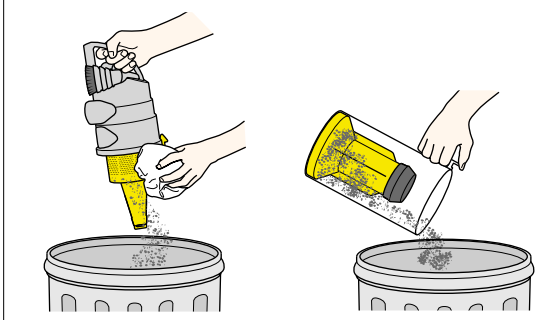

## 7

### Optional



You may rinse the clear bin™ with water.

Do not use detergents.

Do not immerse the whole cleaner in water.

Do not remove bin inner or cone seals.

Ensure completely dry before replacing.

## 8

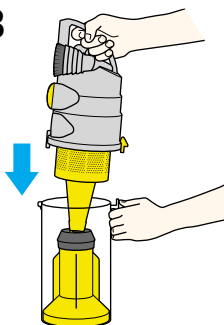

## 9

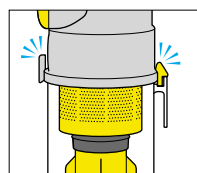

## 10

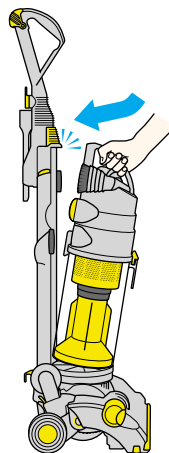

The British Allergy Foundation considers that this product may in proper use reduce exposure to both House Dust Mite (Der p 1) and Cat Allergen (Fel d 1). It is strongly recommended that a sensitive person should take care when emptying the clear bin™. We recommend the manufacturers' emptying instructions should be strictly followed.

Assessment carried out by BAF indicate that an individual's exposure can be reduced but this does not mean that an individual's allergic symptoms will necessarily diminish. BAF's opinion applies only to the products and allergen stated. The product should be used only for its intended purpose and strictly in accordance with the manufacturers' instructions at all times.

Exposure to allergen can be dangerous. If you believe that you may suffer from an allergy you should seek medical advice. The British Allergy Foundation is a national charity (Charity Reg. No. 1003726) founded in 1991 with the aim of improving awareness, prevention and treatment of allergy.

The Foundation continually strives to help sufferers to help themselves, often seeking to avoid or reduce exposure to relevant allergens. The Seal of Approval scheme forms a part of this initiative.

# 5 Finding and clearing blockages

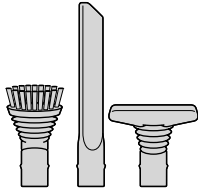
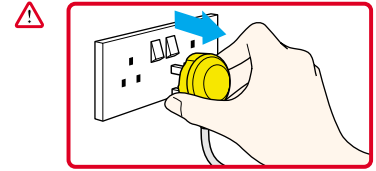

Check that tools are clear.

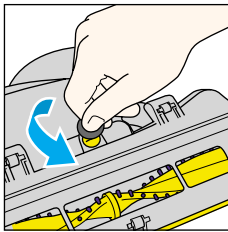

Undo fasteners using a coin and remove soleplate.

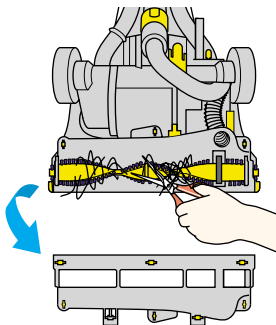

Clear the brushbar obstruction. Carefully cut away any threads from the brushbar.

 Please note that clearing blockages is not covered under your cleaner's guarantee.

Turn power off and unplug before attempting to clear any obstruction or change the belt.

Should any part of your machine become blocked it may over-heat and stop due to the thermal cut-out being triggered. Unplug from mains and leave to cool down.

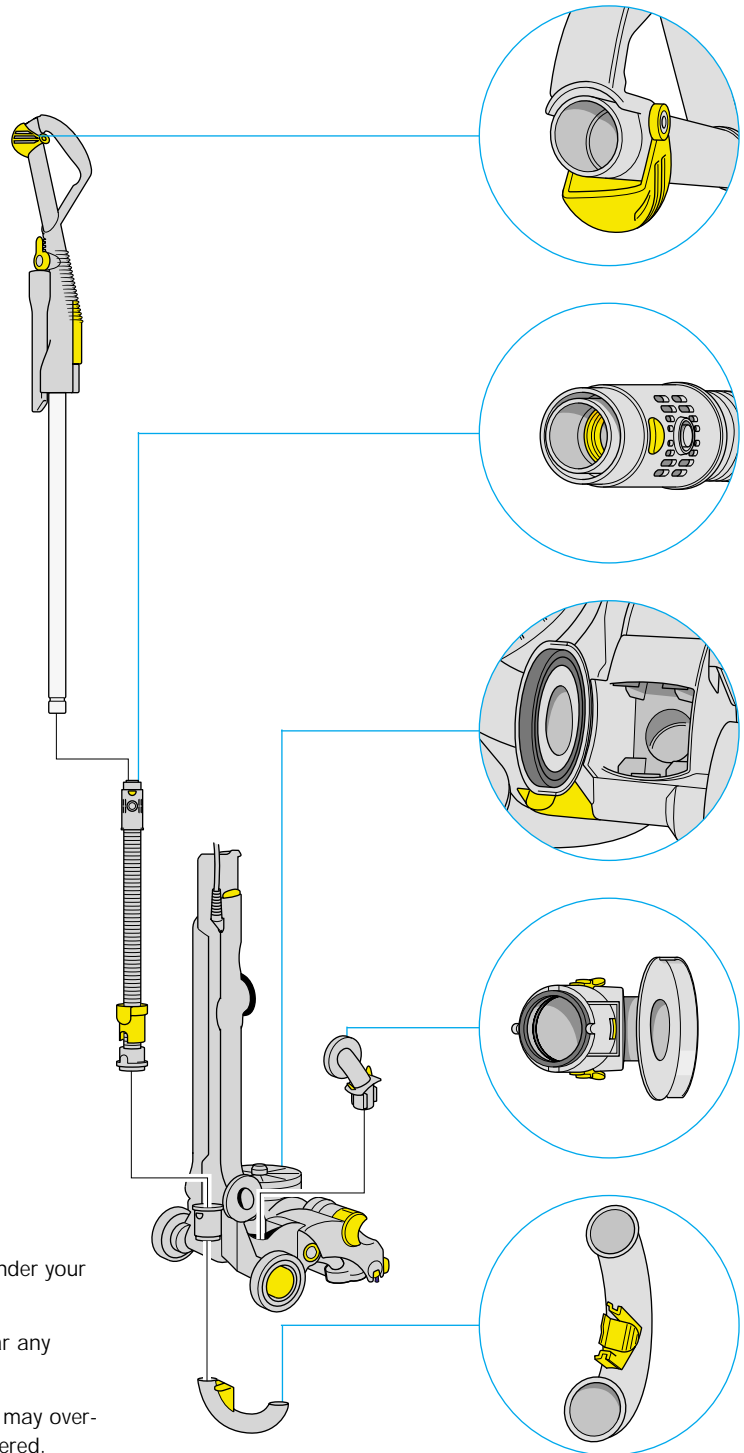

# 6 Dyson Customer Care



- UK** **08705 275 104** 7 days a week 8am - 8pm  
Dyson Ltd, Tetbury Hill, Malmesbury, Wiltshire SN16 0RP. e-mail: service@dyson.com
- IE** **(01) 475 7109** Dyson ROI, Unit 2 Baldonnell Business Park, Naas Road, Co. Dublin
- AU** **1800 239766** Dyson Appliances (Aust.) Pty. Ltd., Unit 8, 7-11 Parraweena Road, Taren Point, Sydney 22 29
- NZ** **0800 397 667** Avery Robinson Ltd., PO Box 18-057, Glen Innes, Auckland

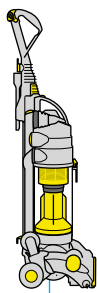

Note your Serial number

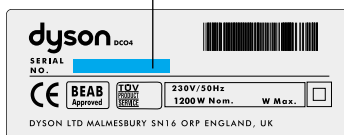

Every new Dyson domestic vacuum cleaner comes with a 2 year guarantee (for the UK there is an option to purchase an extended warranty for a further 3 years).

If you have a query about your Dyson, just call the Dyson Customer Helpline, with your serial number and details of where/when you bought the cleaner.

Most queries can be solved over the telephone by one of our factory-trained Helpline staff.

If your cleaner needs attention from our engineers, we aim to have it repaired and tested within 3 working days.

## Important

- Check that your electricity supply corresponds to that shown on the rating plate. The appliance must only be used as rated.
- If the supply cable of the appliance is damaged, disconnect the appliance from the socket outlet immediately. The supply cable must be replaced only by Dyson Ltd. or their appointed agent, as special purpose tools and service techniques are required.
- Do not use the cleaner if the cable or plug are damaged or if the cleaner has been damaged, dropped or has come into contact with water or any other liquid. In these cases, contact the Helpline.
- When vacuuming, certain carpets may generate small static charges in the clear bin. These are entirely harmless and are not associated with the mains supply. To minimise any effect from this, do not put your hand or insert any object into the clear bin unless you have first emptied it and rinsed it out with cold water.
- Do not continue to use the cleaner if any part appears to be faulty, missing or damaged.
- Do not carry out any maintenance work

other than that shown in this manual or advised by the Helpline, and do not put anything into the openings or moving parts of the machine.

- Only use parts produced or recommended by Dyson; failure to do so could invalidate your guarantee.

**European conformity information:** a sample of this product has been tested and found to be in conformity with the following European Directives: 73/23/EEC Low voltage (safety) Directive, 93/68/EEC CE Marking Directive and 89/336/EEC EMC Directive.

## For your safety



Do not pull on supply cable.



Do not use cleaner above you on the stairs.



Do not use cleaner near naked flames.



Do not leave cleaner near heat sources.



Do not place hands under brushbar when in use.

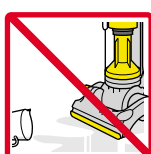

Do not use cleaner to pick up water or any other liquid.



Do not run over supply cable.

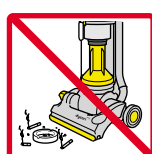

Do not use cleaner to pick up burning objects of any kind.

This product is protected by the following Intellectual Property Rights:

US 4593429, US 4853011, US 4826515,  
US 5078761, US 5160356, US 5558697,  
US 5853440, US 5893936, CA 1182613,  
CA 1241158, CA 2056161, AU 637272,  
AU 669539, AU 691710, AU 697029,  
EP 0489565, EP 0636338, EP 0647114,  
EP 0800359, EP 0800360, EP 0799094,  
WO 94/00046, WO 96/19936,  
WO 96/19937, WO 98/02080,  
WO 99/27834, WO 99/29223,  
WO 99/49978, WO 00/04816,  
WO 00/21425, WO 00/21427,  
WO 00/21424, WO 00/17980,  
GB 2342283, GB 2341907, GB 2342282.

Design Registrations: GB 2076926,  
GB 2074319.

Equivalent patents, registered designs and applications exist in other countries.