

DOCKING DIGITAL MUSIC SYSTEM WITH WIRELESS SPEAKERS FOR iPod AND iPhone



USER'S MANUAL

EAP-850

(iPod/iPhone Not Included)

PLEASE READ THIS USER MANUAL COMPLETELY BEFORE OPERATING THIS UNIT
AND RETAIN THIS BOOKLET FOR FUTURE REFERENCE.

IMPORTANT SAFETY INSTRUCTIONS

When used in the directed manner, this unit has been designed and manufactured to ensure your personal safety. However, improper use can result in potential electrical shock or fire hazards. Please read all safety and operating instructions carefully before installation and use, and keep these instructions handy for future reference. Take special note of all warnings listed in these instructions and on the unit.

1. Read these instructions – All the safety and operating instructions should be read before the appliance is operated.
2. Keep these instructions – The safety and operating instructions should be kept for future reference.
3. Heed all warnings – All warnings on the appliance and in the operating instructions should be adhered to.
4. Follow all instructions – All operation and use instructions should be followed.
5. Do not use this apparatus near water – The appliance should not be used near water; for example, near a bath tub, washbowl, kitchen sink, laundry tub, in a wet basement, or near a swimming pool.
6. Clean only with dry cloth – The appliance should be cleaned only as recommended by the manufacturer.
7. Do not block any ventilation openings. Install in accordance with the manufacturer's instructions. The appliance should be situated so that its location or position does not interfere with its proper ventilation. For example, the appliance should not be situated on a bed, sofa, rug, or similar surface that may block the ventilation openings; or placed in a built-in installation, such as a bookcase or cabinet that may impede the flow of air through the ventilation openings.
8. Do not install near any heat sources such as radiators, heat registers, stoves, or other apparatus (including amplifiers) that produce heat.
9. Protect the power cord from being walked on or pinched particularly at plugs, convenience receptacles, and the point where they exit from the apparatus.
10. The system has an AC plug and will only fit into matching AC outlets. This is a safety feature to reduce the possibility of electric shock. If the plug will not fit in your AC outlets, you should have the outlet changed by qualified licensed electrician. Do not use an adaptor to make the plug fit into your outlet. This defeats the safety feature and could expose you to electric shock.
11. Only use attachments / accessories specified by the manufacturer.
12. Unplug this apparatus during lightning storms or when unused for long periods of time.
13. Refer all servicing to qualified service personnel. Servicing is required when the apparatus has been damaged in any way, such as power-supply cord or plug is damaged, liquid has been spilled or objects have fallen into the apparatus, the apparatus has been exposed to rain or moisture, does not operate normally, or has been dropped.
14. This appliance shall not be exposed to dripping or splashing water and that no object filled with liquids such as vases shall be placed on the apparatus.
15. Power Sources – The appliance should be connected to a power supply only of the type described in the operating instructions or as marked on the appliance. Do not overload wall outlet.
16. Danger of explosion if battery is incorrectly replaced. Replace only with the same or equivalent type.
17. There is a high energy rechargeable battery inside the speaker box, do not throw it into fire to avoid danger of explosion.
18. Do not charge the internal rechargeable battery longer than specified to prevent danger of fire. Overcharging rechargeable batteries may shorten their

- life span.
19. Do not attempt to dismantle, open or repair this product yourself. If a fault occurs, seek advice from your local qualified service technician or contact the distributor via the telephone number at the back of this instruction manual.
 20. Caution marking and nameplate are located on bottom of product.

IMPORTANT NOTES

Avoid installing the unit in locations described below:

- Places exposed to direct sunlight or close to heat radiating appliances such as electric heaters.
- Places subject to constant vibration.

Dusty, humid or moist places.

PRODUCT FEATURES

This iPod/iPhone Docking Music System with incorporates the following features:

- Play and Charge your iPod nano, iPod touch, iPod classic, iPod video and iPhone.
- 2.4GHz Wireless speakers
- Up to 30 meters operating range
- Play music from your computer
- Wireless charging for the speakers built-in batteries
- Auxiliary input jack
- Digital volume control
- Remote Control

LOCATION OF CONTROLS

DOCKING BASE & SPEAKERS

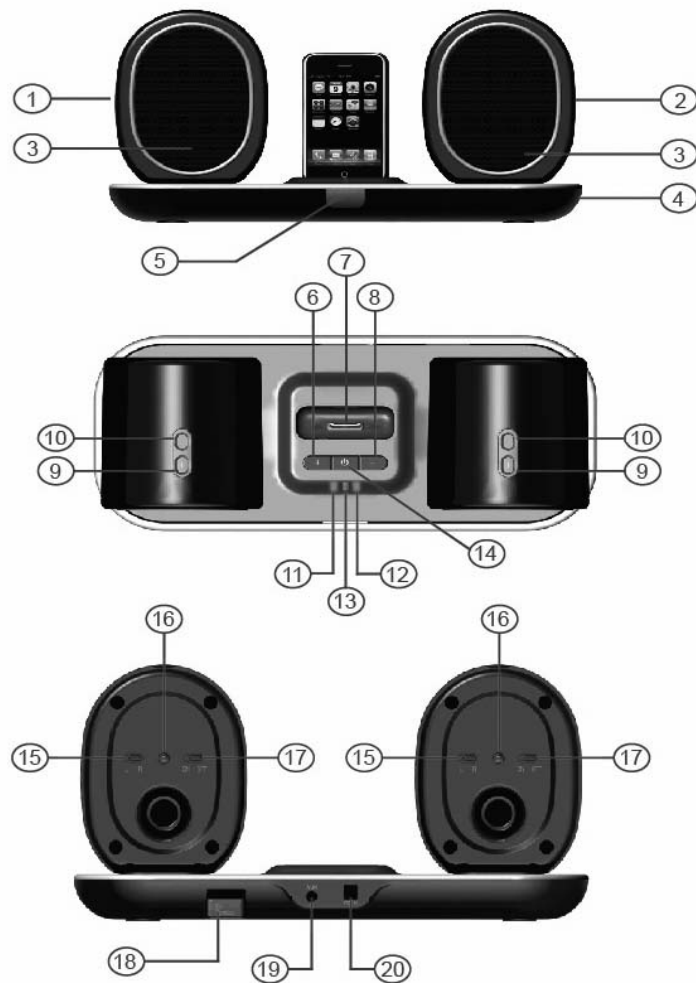





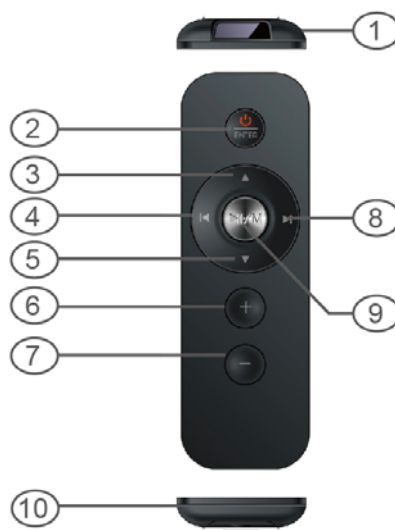

1. Left Satellite Speaker
2. Right Satellite Speaker
3. Speaker Status Indicator
4. Docking Base
5. Remote Infrared Sensor
6. Volume Down (-) Button
7. iPod/iPhone Docking Connector
8. Volume Up (+) Button
9. Speaker Volume Up (+) Button
10. Speaker Volume Down (-) Button
11. Battery Charging Indicator for Left Speaker
12. Battery Charging Indicator for Right Speaker
13. Docking Base Power Indicator

14. Docking Base Power On/Standby  Button
15. Speaker Power Switch
16. Speaker Link Button
17. Speaker Channel Selector
18. USB Transmitter Port
19. AUX IN Jack
20. DC IN Jack

REMOTE CONTROL



1. Infrared Transmitter
2. Power ON/Standby  Button; iPod/iPhone Menu Enter Button
3. iPod/iPhone Menu Scroll Up  Button
4. iPod/iPhone Skip Backward  button
5. iPod /iPhone Menu Scroll Down  button
6. Volume+ Button
7. Volume- Button
8. iPod/iPhone Skip Forward  button
9. iPod/iPhone Play/Pause  Button; Menu Button
10. Battery Compartment

USB TRANSMITTER

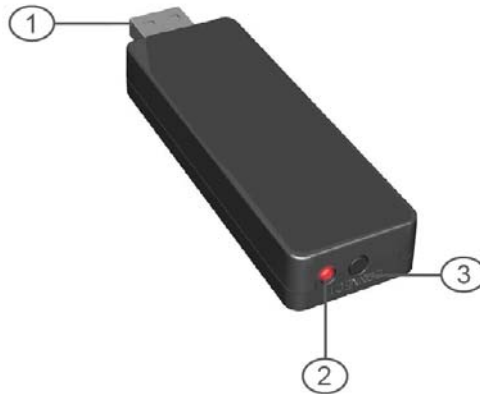

1. USB connector
2. Indicator of transmitter
3. Transmitter Link button

LED INDICATIONS

LED Position	Discription	LED Status
Power Indicator (Docking Base)	No Power	LED Off
	Power on	Solid Blue
	Standby	Solid Red
Speaker Battery Charging Indicator (Docking Base)	No charging	LED Off
	Charging	Flashing Blue
	Charging Finished	Solid Blue
Speaker Status Indicator (Speaker Box)	Speaker Power Off	LED Off
	Linking	Rapid Flashing Blue
	Not linked	Slow Flashing Blue
	Linked	Solid Blue
	Low Battery	Solid Red
USB Transmitter Indicator	No Power	Red LED off
	Linking	Rapid Flashing Red
	Transmit Standby	Slow Flashing Red
	Transmitting	Solid Red

INSTALLATION

CONNECTING THE AC POWER

An AC-DC Adaptor with 7.5V DC 2400mA output (included) is required for operating the main unit. Plug the AC-DC Adaptor into the unit and into an AC outlet:

- 1.) Firmly and securely insert the DC plug of the adaptor into the DC Jack on the back of the unit
- 2.) Plug the Adaptor plug into an outlet rated at 120V ~ 60Hz.

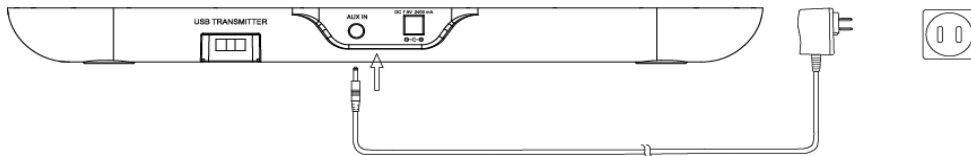

NOTE: This speakers are not magnetically shielded and may cause color distortion on the screen of some TVs or video monitors. To avoid this, you may need to move the speakers further away from the TV or monitor if unnatural color shifts or image distortion occurs.

POWER OF INDIVIDUAL SPEAKER

Each speaker has a built-in rechargeable lithium battery for independent playback. Before the first use, we recommend to charge each speaker battery for 12 hours. Switch off the speaker power and place it on the recessed charging area of the powered Docking Base, charging will start automatically. The charging LED indicator will be flashing blue while the speaker is charging and will switch to solid blue when charged.

REMOTE CONTROL

The remote control operates on one CR2025 battery (included). To activate the remote control, remove the insulation tab inserted in the battery compartment. When the operation of the remote control becomes intermittent or unsatisfactory, replace the original battery with a new 3-volt lithium CR2025 battery.

- 1.) Slide out the battery holder from the remote control case.
- 2.) Replace the 3V CR2025 battery. Be sure the battery is installed correctly. The

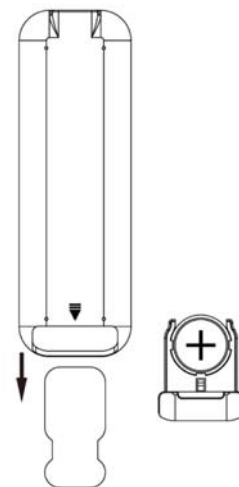

remote will not work if the battery is installed with the wrong polarity.

CAUTION: Danger of explosion if the battery is replaced incorrectly. Replace only with the same type battery.

3.) Insert the battery holder back into the battery slot.

NOTE: Only use a well-known brand of cell battery to ensure the longest life and best performance.

GETTING START

Note: Before first use, please charge the satellite speakers for at least 12 hours because the batteries may not fully charged, even though the LED lights.

You must follow the “**Linking**” process below to link the transmitter with satellite speakers prior using this wireless music system.

1. Plug the USB Transmitter into the USB port of the docking base.
2. Press the POWER ON/STANDBY  button on the docking base or press and hold it on the remote control to turn on Docking Base, the Power LED indicator will change from red to blue.
3. Turn the left satellite speaker power to ON and switch the speaker channel setting to “Left”, the speaker status LED will be flashing blue.
4. Press and hold the Link button located on the back of the speaker box for about 3 seconds and then release it. The speaker status LED will rapidly flash blue.
5. Now press the link button on the USB transmitter for 3 seconds, and then release it. The LED on the Transmitter rapidly flashes red during the linking process between the transmitter and the speaker.
6. When the speaker and transmitter successfully link, the LED on the speaker will light solid blue and the LED on the transmitter will slowly flash red. The transmitter LED will light solid red when music is transmitting from the docking base or from your computer.
7. Turn the right satellite speaker power to ON and switch the speaker channel setting to “Right”. Repeat above step 3 - 6 to link the right speaker with the transmitter.
8. When both speakers are successfully linked, you will be able to hear the sound coming from the speakers when playing music.

Note: If you redo linking process during music playback, a beeping tone will come out from the speaker for about 15 seconds after you press and hold the link button of the speaker. A continue tone will be heard if you and then press and hold the link button of the transmitter within this period.



LISTENING TO iPod/iPhone

CONNECTING

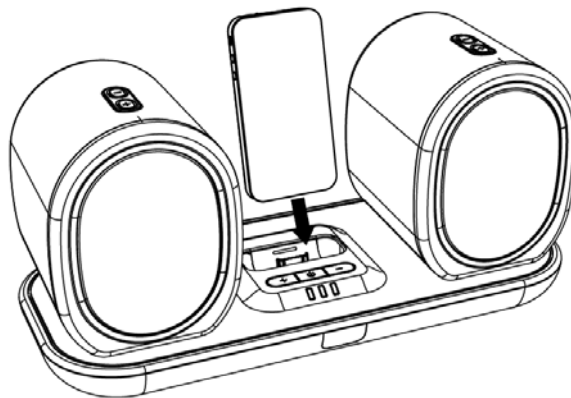
- 1.) Use the adapter included with your iPod and insert it into the docking area. No adaptor is required if you use an iPhone. Your iPod / iPhone can now be inserted into the docking port by placing the connector on the bottom of the iPod onto the connector in the docking bay.



Note: Please be careful when placing the iPod / iPhone into the docking bay to avoid damaging the 30-pin connector on the iPod/iPhone or on the docking system.

- 2.) Press the POWER ON/STANDBY  button on the docking base or press and hold it on the remote control to turn on the unit.
- 3.) The iPod/iPhone will start playing automatically and start charging immediately. You can also start playing the iPod/iPhone by tapping the iPod/iPhone PLAY/PAUSE  button when the unit is in a different mode.
- 4.) Tap the iPod/iPhone PLAY/PAUSE  button to pause or resume iPod playback.
- 5.) Adjust the sound level by pressing the VOLUME +/- buttons. You should now be able to take the speakers freely from room to room without interruption (Operating distance is subject to your surroundings and interior walls. Up to 30meter range in open/ unobstructed areas without any surrounding interference).

Note: The volume level cannot be adjusted using the volume control on your iPod/iPhone after being docked.

- 6.) The iPod/iPhone will charge in all modes including during playback.

iPod/iPhone playback control:

- Tap the iPod/iPhone PLAY/PAUSE  button to pause or resume the

iPod/iPhone playback;

- Press the SKIP ◀◀ or ▶▶ buttons to skip to the next or previous song;
- Press and hold the SKIP ◀◀ or ▶▶ buttons for fast-forwarding or fast-rewinding during playback.
- Press and hold the PLAY/PAUSE ▶▶ / M button for 3 seconds to control iPod / iPhone screen menu.
- Tap the ENTER button to enter iPod/iPhone menu selection.
- Press the ▲/▼ buttons to scroll iPod/iPhone menu up/down

Note:

1. The remote control only turns on and off the Docking Base. The left and right satellite speakers must be turned on/off manually using the power switch located on back of each speaker box.
2. The volume of satellite speakers are default set to maximum when the speaker power is on.

PLAYING MUSIC FROM YOUR COMPUTER

To play music from a Windows or Mac OS X based personal computers.

NOTE:

1. The volume of satellite speakers are default set to maximum when the speaker power is on.
2. When you playing music from your computer, the volume control on Docking Base and remote control will not work. Please use the volume control on your computer or the volume buttons on the wireless speakers to control the sound level.

Windows Based Computer (for Windows XP or above)

- 1.) Remove the USB Transmitter from the back of the Docking Base and plug it into the USB port of your computer. The computer reports “Found New Hardware” the first time the USB port is accessed. Wait for the computer to automatically search and install the necessary device drivers for the USB Transmitter. Once installed, the PC will show “Your new hardware is installed and ready to use” when the device drivers have been properly installed.
- 2.) Go to your computer control panel and set the default audio sound playback device to the “SYNIC Wireless Audio”.
- 3.) Fully charge and place the two speakers within wireless range of the transmitter that is plugged into the USB port of your computer.
- 4.) Link the wireless speakers by following linking instructions mentioned in the “Getting Start” section of the manual. Now you can play music from your PC

and listen to it through your wireless speaker system.

- 5.) Open the music player program on your computer, and adjust the volume of the player program to a low level.
- 6.) Click the play button, and slowly increase the volume level of your player program to adjust the sound level.
- 7.) Press the Volume+/- button on speaker boxes to control the sound level if necessary.

Mac Based Computer (for Mac OS X)

- 1.) Remove the USB Transmitter from the back of the Docking Base and plug it into the USB port of your Mac.
- 2.) Go to your computer system preferences and set sound output to "SYNIC Wireless Audio" USB device
- 3.) Fully charge and place the two speakers within wireless range of the transmitter that is plugged into the USB port of your computer.
- 4.) Link the wireless speakers by following linking instructions mentioned in the "Getting Start" section of the manual. Now you can play music from your Mac and listen to it through your wireless speaker system.
- 5.) Open the music player program on your computer, and adjust the volume of the player program to a low level.
- 6.) Click the play button, and slowly increase the volume level of your player program to adjust the sound level.
- 7.) Press the Volume+/- button on speaker boxes to control the sound level if necessary.

SPEAKER BATTERY RECHARGING

When you remove the speakers from the Docking Base and listen to music wirelessly, the built-in rechargeable lithium batteries will eventually reach a low power condition. The speaker status LED will change from blue to red before it goes off, so please charge you speaker battery immediately when the LED turns red.

1. Position the two speakers onto the recessed charging area located on the Docking Base. Each speaker has it's own charging bay.
2. The Docking Base LED for each speaker will flash blue, indicating that the speaker battery is being charged.
3. The Docking Base LED for each speaker will turn solid blue after charging for about 4 - 5 hours or once the battery is fully recharged.

Note: 1. To allow the speakers to charge to maximum capacity, the sound

level will be reduced to about 80% automatically if you use the speakers with the docking base while charging them. Press the volume control of docking base to increase the sound level if necessary after charging.

2. Please manually turn the speaker box volume down if you use the speakers with computer while charging them. Charging time will vary if you are listening to music while charging the speakers. We recommend you switch off the speaker power during the charging process or until the speaker batteries are fully charged.
3. To prolong the life of a rechargeable battery, it is recommended to completely discharge it before fully charging it again.
4. Rechargeable batteries need to be cycled for maximum performance and longer battery life. If you don't use the player that often, be sure to recharge the battery at least once a month in order to keep the internal battery working properly.

AUXILIARY INPUT

This unit provides an auxiliary audio signal input jack for connecting external audio devices like MP3 players, CD players and older, non-dockable iPods (except iPod shuffle 3rd gen) and listen to your external source through the speakers of this system.

1. Plug the USB transmitter into connector on the back of the Docking Base and link the wireless speakers by following linking instruction mentioned in "Getting Start" section.
2. Use an audio cable (included) with one 3.5 mm stereo plug on each end of the cable.
3. Plug one end into the Aux-in jack on the main unit and the other end of the cable into the Line-out Jack or Headphone Jack of your external audio device.
4. Turn on the external audio device.
5. The volume level can now be controlled through the main unit. Operate all other functions on the auxiliary device as usual.

Note:

- (1). Aux In will automatically cut off the iPod/iPhone audio when 3.5mm Jack plugged in. Please turn off iPod/iPhone when you using Aux In function.
- (2) If you connected the Line Out Jack of your external device then you only need to adjust the volume control of this system. If you connected the Headphone Jack of your external device then you may need to adjust both the volume control of your external device and the volume control of this system to find the most desirable volume setting.
- (3) Press the POWER  button to turning off the system when you finish

listening. Don't forget to switch off the power of your external device as well.

RESETTING

If the system does not respond or has intermittent operation, you may have experienced an electrostatic discharge (ESD) or a power surge that triggered the internal computer to shut down automatically. If this occurs, simply disconnect the main power and turn the power switch on rear of the speaker boxes to the OFF position. Wait one minute and reconnect the main power and turn the speaker boxes back ON again.

CARE AND MAINTENANCE

1. Avoid operating your unit under direct sunlight or in hot, humid or dusty places.
2. Keep your unit away from heating appliances and sources of electrical noise such as fluorescent lamps or motors.
3. For better Clock Display clarity, avoid operating the unit under direct sunlight or in strong room illumination.
4. Unplug the unit from the electrical power outlet immediately in case of malfunction.

CLEANING THE UNIT

- To prevent fire or shock hazard, disconnect your unit from the AC power source when cleaning.
- The finish on the unit may be cleaned with a dust cloth and cared for as other furniture, Use caution when cleaning and wiping the plastic parts.
- If the cabinet becomes dusty wipe it with a soft dry dust cloth. Do not use any wax or polish sprays on the cabinet.
- If the front panel becomes dirty or smudged with fingerprints it may be cleaned with a soft cloth slightly dampened with a mild soap and water solution. Never use abrasive cloths or polishes as these will damage the finish of your unit.

CAUTION: Never allow any water or other liquids to get inside the unit while cleaning.

TROUBLESHOOTING GUIDE

Symptom	Possible Problem	Solution
The unit does not respond (no power).	AC Adaptor is not plugged into a wall outlet or the connector is not plugged into the power supply jack on the back of the unit.	Plug the AC adaptor into a wall outlet and plug the connector into the supply jack on the unit.
	Wall outlet is not functioning.	Plug another device into the same outlet to confirm the outlet is working.
No Sound	Speaker batteries are dead	Recharge the speaker batteries
	Wireless speaker is not linked with the transmitter	Firmly plug the USB transmitter into USB port of the Docking Base. Go through "Linking" process to link the speakers.
	Speaker placement out of range	Relocate the speaker within wireless operating range
	Computer USB port not work	Try another USB port of computer or try another computer.
	Computer not select "SYNIC Wireless Audio" as audio output device	Follow "PLAYING MUSIC IN YOUR COMPUTER" section instruction in this manual to set it.
	Volume set too low	Press the Volume+ button to turn the sound level up.
iPod/iPhone does not respond to the speaker system.	iPod/iPhone is not installed properly.	Remove your iPod/iPhone from the dock and check for obstruction on the connectors in the dock and on your iPod/iPhone. Then reseal it on the dock.
	Your iPod/iPhone is locked up.	Please make sure that your iPod/iPhone is working properly before docking into the unit. Please refer to your iPod/iPhone manual for info on resetting the iPod/iPhone.
iPod/iPhone does not charge.	iPod/iPhone is not installed properly.	Remove your iPod/iPhone from the dock and check for obstruction on the connectors in the dock and on your iPod/iPhone. Then reseal it in the dock.
	iPod/iPhone is locked up/frozen. iPod/iPhone battery has problem.	Please make sure your iPod/iPhone is working properly before docking into the unit. Please refer to your iPod/iPhone manual for details on resetting.
Sound is distorted.	Volume level is set too high.	Decrease the volume.
	Sound source is distorted.	If the iPod/iPhone original sound source is of poor quality, distortion and noise are easily noticed with high-power speakers. Try a different audio source such as a music CD. If you are using an external sound source like older generation of iPod, try reducing the output volume on the device itself. Also try turning bass boost OFF or change the EQ setting.
Unit gets warm after extended play at high	This is normal.	Turn the unit off for a period of time or lower volume.

SPECIFICATIONS

Power Requirement

Main unit AC-DC adaptor Input: AC 120V, 60Hz
Output: DC7.5V / 2400mA

Wireless Speaker Built-in DC 3.7V, 1000mA
rechargeable lithium Battery

Remote Control 1 x 3V CR2025 Lithium Battery

Working Frequency Band: 2.406-2.472GHz

“Made for iPod” and “Made for iPhone” mean that an electronic accessory has been designed to connect specifically to iPod and iPhone, respectively, and has been certified by the developer to meet Apple performance standards. Apple is not responsible for the operation of this device or its compliance with safety and regulatory standards.

iPhone, iPod, iPod classic, iPod nano, iPod shuffle, and iPod touch are trademarks of Apple Inc., registered in the U.S. and other countries.

If at any time in the future you should need to dispose of this product Please note that: Waste electrical products should not be disposed of with household waste. Please recycle where facilities exist. Check with your Local Authority or retailer for recycling advice.

(Waste Electrical and Electronic Equipment Directive)



FCC Warning:

Changes or modifications not expressly approved by the party responsible for compliance could void the user's authority to operate the equipment.

FCC Radiation Exposure Statement

The antennas used for this transmitter must be installed to provide a separation distance of at least 20cm from all persons and must not be co-located or operating in conjunction with any other antenna or transmitter.

CE0678