

bēmⁱ
WIRELESS

sunrise speaker

USER GUIDE

Contents

English	Page 4
Canadian Français	Page 23
Español	Page 43

Meet the Sunrise Speaker

To begin, take a moment to familiarize yourself with your Sunrise Speaker's controls and features.

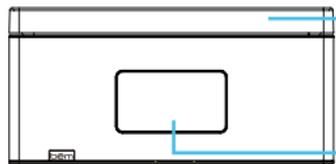

Light
Press down on light to Snooze / Play / Pause / Answer, tap the Light On/Off button to change brightness

LCD Display

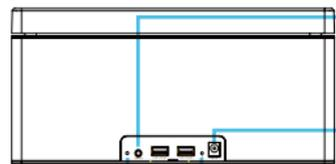

Aux Input
Use the included Aux Cable to play audio from any device with a headphone output

DC Input
Connect the Power Adapter here

Bluetooth Indicator

USB Ports
For charging your smartphone or tablet

FM Antenna

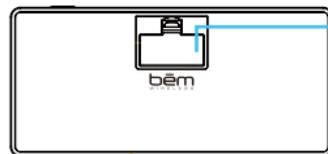

Backup Battery Compartment
Insert 2x AAA batteries to maintain your clock and alarm setting in case of a power outage

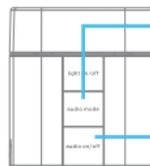

Audio Mode
Cycles through Bluetooth, Nature Sounds, FM Radio, Aux Input

Audio On/Off



Remote x 1

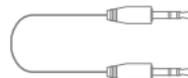

Aux Cable x 1

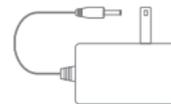

Power Adapter x 1

If any of these were missing or damaged, please visit bemwireless.com to obtain a replacement.

Product Interface: Remote

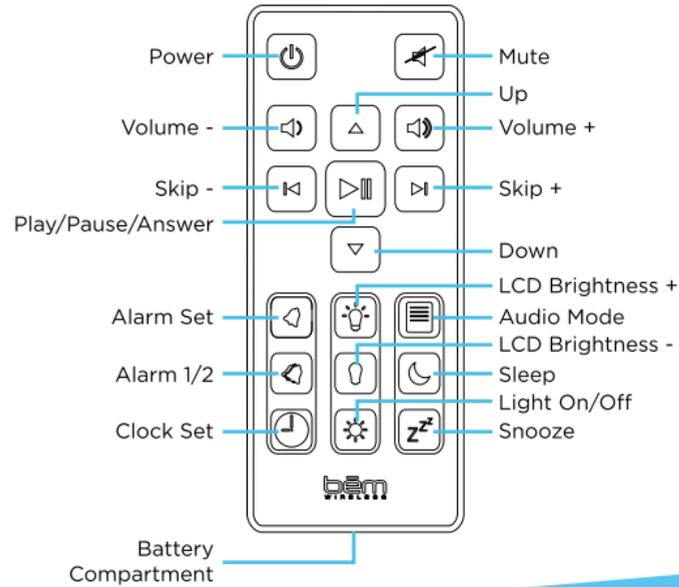

Product Interface: LCD Screen

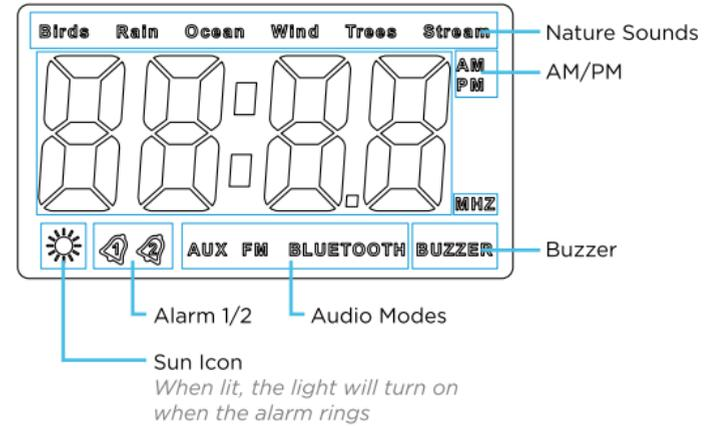

Getting Started

Step 1: First Things First

Remove the plastic insert from the remote's battery compartment. Next, place 2x AAA batteries into the backup battery compartment on the bottom of the speaker to maintain your clock and alarm setting in case of a power outage.

Step 2: Power Up

Connect your Sunrise Speaker to an outlet using the included power adapter, the LCD panel will then light up.

Touch the "Audio On/Off" button on the side of the speaker, or press the  button on the remote to turn on the speaker.

Step 3: Audio Modes

Touch the "Audio Mode" button on the side of the speaker or press the "Audio Mode" button on the remote to switch between the following play modes (Bluetooth is the default play mode when the speaker is powered on for the first time):

AUX Mode: Your Sunrise Speaker can be connected to any device that has a standard 3.5mm headphone jack by using the included aux cable. Please note the play/pause button only operates when connected via Bluetooth.

FM mode: Play FM radio. Store up to 20 of your favorite stations.

See "Saving Radio Station Presets" for more information

Bluetooth Mode: Play audio wirelessly from a connected Bluetooth device

- When the Sunrise Speaker enters Bluetooth mode, the Bluetooth icon will light up and you will hear a tone confirming that the unit is currently in Bluetooth pairing mode. Go to the Bluetooth settings on your mobile phone, tablet or computer and select the device named "Sunrise". A tone will sound to confirm the device has paired successfully. From now on, this device will connect automatically with the Sunrise Speaker.
- Holding the  button for 5 seconds will disconnect the connected device and enter pairing mode for a new device.

Natural Sound Mode: Play one of 6 built-in recordings.

1. Press "Audio Mode" to switch to natural sound play mode
2. Use to  /  select the sound you want to play, and the selected icon will appear on the screen
3. The selected music will start playing immediately

The speaker will remember the most recent play mode each time it is turned on

Getting Started (cont.)

Step 4: Set the Clock

1. Hold the  button on the remote to shift between 12 and 24 hour time. (the AM/PM icon will light up under 12 hour mode)
2. Press  and the hours will blink on the LCD screen, use  /  to adjust the hour
3. Press  again and minutes will blink on the LCD screen, use  /  to adjust the minute
4. Press  a 3rd time to confirm and finish the setting

Step 5: Set the Alarm

The Sunrise Speaker features dual alarms that can be easily set by using the remote control.

Step 1: Choose your alarm

1. Press  on the remote once and the LCD display will show the Alarm 1 icon, which means Alarm 1 is active
2. Press  again and the LCD display will switch to showing the Alarm 2 icon and remove Alarm 1
3. Press  again and the LCD screen will display both alarm 1 and alarm 2 icons to activate both alarms
4. Press  a 4th time to remove both alarms

Step 2: Set alarm time and mode

You can set the alarm time and sound mode of the activated alarm by doing the following: (The alarm setting cannot be operated if alarm 1 and 2 are both activated or off at the same time)

1. Press , hours will blink on the LCD display, use  /  to adjust hour;
2. Press  a 2nd time, the minutes will blink on the LCD display, use  /  to adjust the minutes
3. Press  a 3rd time, the sun icon on the will flash on the LCD display, use  /  to shift between having the light on or off while alarm rings
4. Press  a the 4th time, use  /  to set the alarm as one of 6 nature sounds, FM radio, buzzer, or off
5. Press  a 5th time to confirm and finish the setting

Each alarm will last 2 minutes. Tap any button on the side of the speaker silence the alarm.

Using the Snooze Function

Press down on the top of the speaker or press  on the remote to postpone the alarm for 9 minutes.

(The snooze function only works after the alarm has started to ring)

Operation Details

Using the Sleep Function

(The sleep function only works when the speaker is turned on)

1. Press  on the remote to activate the auto-off function, the current auto-off time will appear on the LCD display
2. Press  again to change the auto-off time: 15min > 30min > 45min > 60min > OFF
3. The display will revert to clock mode automatically 3 seconds after you finish this setting

The LED light will slowly dim and go off 2 minutes before the speaker turns off.

Saving Radio Station Presets

Press "Audio Mode" on the speaker to switch to FM mode. The FM icon will light up on the display and the speaker will automatically switch to the most recently played radio station.

In FM mode, use  /  to adjust the frequency, use  /  to switch between saved channels.

The Sunrise can store up to 20 radio station presets

1. Adjust to the radio station you want to save
2. Hold  (on the speaker or remote) until "P XX" flashes on screen, where "XX" is a number from 01-20, representing the preset you are currently at

3. Use  /  to select a preset from 1 to 20
4. Press  (on the speaker or remote) to save the current radio station to selected preset number, it will replace any station previously saved under this preset

Speakerphone

After pairing your mobile phone to the Sunrise Speaker via Bluetooth, the speaker phone function can be used.

- Make a Call: Calls will automatically transfer to the speakerphone. If not, tap the  button.
- Answer a Call: Tap  to answer the incoming call
- End a Call : Tap  during the call to end the call
- Reject a Call: Hold  to reject the incoming call
- Redial the Last Number: Double tap  to call the most recently dialed number.

Both the  button on the speaker and remote work with this function.

Mute the Speaker

Press  on the remote to mute the speaker.

Please note that this function will mute the speaker only. If you are in a phone call, the microphone will still be active when the speaker is muted.

Operation Details (cont.)

Adjust the Volume Level

Use the volume buttons on the remote to adjust the playback volume. The volume level can also be adjusted from the connected device.

Night Light

The LED night light is available whenever the Sunrise Speaker is powered on.

Press the "Light On/Off" button on the speaker or  button on the remote to turn the light on and adjust its brightness.

Screen Dimmer

Use the  buttons on the remote to change the display brightness

Troubleshooting

Issue: Pairing is unsuccessfully after multiple attempts

Solution:

- Check if the Bluetooth indicator light is on. If the indicator light is off, press the power button to turn the unit on. If the Bluetooth indicator light still doesn't come on after pressing the power button, please charge the unit.
- Check for other nearby Bluetooth devices that may interfere with pairing and turn devices off.
- Power off, then power on the unit to restart the Bluetooth function on the speaker or your Bluetooth device.
- Unplug any cables plugged into the AUX IN port. Restart all devices and then attempt pairing again.

Issue: Interference or static during playback

Solution:

- Avoid connecting to the speaker through concrete or other building structures that may interfere with the signal.
- Please check if the battery level of your Bluetooth device and charge if necessary.

For more troubleshooting help go to bemwireless.com

Maintenance

Please follow the instructions below for cleaning your Sunrise Speaker

- Power off the unit and unplug the power adapter from wall outlet
- Use a soft, dry, lint-free cloth and wipe gently
- Do not use alcohol, benzene, thinners or other chemical detergents as these can cause the casing to be warped or discolored

For questions, comments or to purchase more bem wireless products go to **bemwireless.com**

Storage

- Power off the Sunrise Speaker If the unit will not be used for an extended period of time.
- Do not set the unit in a damp environment, high temperatures or in direct sunlight.

Technical Specifications

Note: All specifications are subject to change without notice

Product Name : Sunrise

Model Number : HL2501

Power Supply: 12V,2A

Output power: 5W X 2

USB charging output: 5V,1A x 2

Bluetooth V4.0+EDR , profile Supported: A2DP, AVRCP

Bluetooth working range: Approximately 25ft, 8m

FM frequency : 87.5MHz-108MHz

LED Power :1W

Color temperature: 5200K±300K

Working atmosphere: 0°C-40°C / 20%-90%RH

FCC Statement

1. This device complies with Part 15 of the FCC Rules. Operation is subject to the following two conditions:

1. This device may not cause harmful interference.
2. This device must accept any interference received, including interference that may cause undesired operation.

2. Changes or modifications not approved by the party responsible for compliance could void the user's authority to operate the equipment.

NOTE: This equipment has been tested and found to comply with the limits for a Class B digital device, pursuant to Part 15 of the FCC Rules. These limits are designed to provide reasonable protection against harmful interference in a residential installation.

This equipment generates uses and can radiate radio frequency energy and, if not installed and used in accordance with the instructions, may cause harmful interference to radio communications. However, there is no guarantee that interference will not occur in a particular installation. If this equipment does cause harmful interference to radio or television reception, which can be determined by turning the equipment off and on, the user is encouraged to try to correct the interference by one or more of the following measures:

- Reorient or relocate the receiving antenna.
- Increase the separation between the equipment and receiver.
- Connect the equipment into an outlet on a circuit different from that to which the receiver is connected.
- Consult the dealer or an experienced radio/TV technician for help

FCC Radiation Exposure Statement

This equipment complies with FCC radiation exposure limits set forth for an uncontrolled environment. This equipment should be installed and operated with minimum distance 20cm between the radiator & your body.

CE2200

bēm wireless
<http://bemwireless.com/>
bēm wireless LLC.
1725 Kilkenny Ct.
Woodstock, IL. USA
Made in China

Safety Instructions

This product has been designed with safety in mind; to ensure accident free operation, please follow the guidelines listed below:

- Always position the unit on a stable and level surfaces. Unstable surface can cause the unit to topple and fall, resulting in possible damage or injury
- Do not drop, unpack, open, beat, curve, prink and burn the unit
- Avoid using the unit nearby basins or sinks where it may come in contact with water
- Do not place water-filled containers on the top of the unit (such as vases, glasses, or pots), and avoid placing candles on the speaker
- Protect the unit from any heating devices (such as radiator, heating installations, or stoves)
- In the event of damage to the unit, repairs should be performed by maintenance personnel
- Before cleaning the unit, turn off the unit and unplug the power cable from the outlet
- Set the volume properly to prevent damage to the unit and to protect your hearing



Correct Disposal of this product. This marking indicates that this product should not be disposed with other household wastes throughout the EU. To prevent possible harm to the environment or human health from uncontrolled waste disposal, recycle it responsibly to promote the sustainable reuse of material resources. To return your used device, please use the return and collection systems or contact the retailer where the product was purchased. They can take this product for environmentally safe recycling.

IC ID STATEMENT

- English: "

This device complies with Industry Canada licence-exempt RSS standard(s). Operation is subject to the following two conditions: (1) this device may not cause interference, and (2) this device must accept any interference, including interference that may cause undesired operation of the device."

This equipment should be installed and operated with a minimum distance of 20 cm between the radiator and your body.

- French:"

Le présent appareil est conforme aux CNR d'Industrie Canada applicables aux appareils radio exempts de licence.

L'exploitation est autorisée aux deux conditions suivantes :

- (1) l'appareil ne doit pas produire de brouillage, et
- (2) l'utilisateur de l'appareil doit accepter tout brouillage radioélectrique subi, même si le brouillage est susceptible d'en compromettre le fonctionnement."

Cet équipement doit être installé et utilisé à une distance minimale de 20 cm entre le radiateur et votre corps.