

Rhein Tech Laboratories
360 Herndon Parkway
Suite 1400
Herndon, VA 20170
<http://www.rheintech.com>

Report #: 2004210
FCC ID: ATH2424110
Model: 242-41xx
Standards: FCC Part 90 & IC RSS-119
Date: December 13, 2004

APPENDIX J: USER'S MANUAL

Please refer to the Operator's Manual.

OPERATING MANUAL

4100 *Series*

DIGITAL/ANALOG PORTABLE RADIO

4100 SERIES PORTABLE RADIO

- APCO Project 25
 - Conventional
 - Trunked
- SMARTNET[®] /
SmartZone[®]
- Analog (FM)
Conventional

VHF

UHF

700/800 MHz

Part No. 242-41xx-xxx



Part Number 002-4100-xxxx
December 2004



4100 SERIES PORTABLE OPERATING MANUAL

- APCO PROJECT 25 CONVENTIONAL
- APCO PROJECT 25 TRUNKED
- SMARTNET[®]/SmartZone[®]
- ANALOG (FM) CONVENTIONAL
- VHF/UHF/800 MHz

Copyright© 2004 by the E.F. Johnson Company

The E.F. Johnson Company, which was founded in 1923, provides wireless communication systems solutions for public safety, government, and commercial customers. The company designs, manufactures, and markets conventional and trunked radio systems, mobile and portable subscriber radios, repeaters, and Project 25 digital radio products. EFJohnson is a wholly owned subsidiary of EFJ, Inc.

Viking Head/EFJohnson logo, PCConfigure[™], and Call Guard[®] are trademarks of the E.F. Johnson Company. SMARTNET[®], SmartZone[®], SecureNet[™], Call Alert[™], Enhanced Private Conversation[™], and Private Conversation II[™] are trademarks of Motorola, Inc. All other company and/or product names used in this manual are trademarks and/or registered trademarks of their respective manufacturer. The IMBE[™] voice coding technology embodied in this product is protected by intellectual property rights including patent rights of Digital Voice Systems, Inc.

LAND MOBILE PRODUCT WARRANTY - The manufacturer's warranty statement for this product is available from your product supplier or from E.F. Johnson Company, 1440 Corporate Drive, Irving, TX 75038-2401. Phone toll free 1-800-328-3911.

Information in this manual is subject to change without notice.

TABLE OF CONTENTS

SAFETY INFORMATION		4 RADIO-WIDE FEATURES	
•	Federal Communications Commission Regulations	4.1	Option Switches
•	Compliance with RF Exposure Standards	4.2	Menu Mode
•	RF Exposure Compliance and Control Guidelines and Operating Instructions	4.3	Time-Out Timer
•	Contact Information	4.4	Home Zone/Channel Select
•	Electromagnetic Interference	4.5	Power Output Select
•	Usage Compatibility	4.6	Alert Tone Select
•	Battery Disposal	4.7	Surveillance Mode
		4.8	Scanning
			Introduction
			Priority Scanning
			Radio Wide Scanning
			Scan Hold Time
			Transmitting in the Scan Mode
			Nuisance Channel Add/Delete
1 FEATURES		4.9	Scan Lists
1.1	General Features		Priority Scan Lists
1.2	Conventional Features		Radio Wide Scan Lists
1.3	SMARTNET/SmartZone Features		
1.4	Project 25 Trunked Features		
2 CONTROLS AND DISPLAY		5 CONVENTIONAL MODE FEATURES	
2.1	Front Panel Controls	5.1	Introduction
2.2	Top Panel Controls	5.2	Monitoring Before Transmitting
2.3	Side Controls	5.3	Monitor Mode
2.4	Display	5.4	Busy Channel Lockout
		5.5	Call Guard Squelch
			Introduction
			Call Guard Squelch Enable/Disable
			Tone Call Guard Squelch
			Digital Call Guard Squelch
			Selective Squelch Code Select
3 GENERAL OPERATION		5.6	Penalty Timer
3.1	Turning Power On and Setting Volume	5.7	Conversation Timer
	Power Up	5.8	Repeater Talk-Around
	Standard and Soft Power Down	5.9	Displaying Transmit/Receive Frequency
	Setting Volume Level	5.10	Emergency Alarm and Call
3.2	Power-Up Password		Introduction
	General		Emergency Alarms
	Password Features		Emergency Calls
3.3	Zone and Channel Select		Emergency Man-Down Feature
3.4	Low Battery Indication	5.11	Conventional Mode Scanning
	General		General
	Battery Charging		Transmitting in Scan Mode
3.5	Backlight		Priority Channel Sampling
3.6	Keypad Lock	5.12	Standard Conventional Calls
3.7	Setting Squelch	5.13	DTMF/ANI Signaling
3.8	Transmit Disable	5.14	Single Tone Encoder
3.9	Radio Operating Modes	5.15	MDC1200 Compatibility
	General		
	Conventional Mode		
	SMARTNET/SmartZone Mode		
	P25 Trunked Mode		
	Systems, Channels, and Zones		

5.16	Clone Mode	34	Emergency Alarms	48
	General	34	Emergency Calls	48
	Wireless Cloning	34	Emergency Man-Down Feature	49
	Cloning Procedure	34	6.11 Failsoft Operation	49
5.17	Project 25 Mode Features	35	6.12 SMARTNET/Smartzone/P25 Trunked Scanning Features	49
	Unit ID Code	35	General	49
	Group ID Code	35	Priority Talk Group Sampling	49
	Network Access Code	35	6.13 Dynamic Regrouping	50
	P25 Group Calls	35	6.14 SmartZone and P25 Trunked Unique Features	50
	P25 Unit Calls	35	Introduction	50
	P25 Conventional Telephone Calls	36	Busy Override	50
	Call Alert	37	Site Trunking	50
	Messaging	38	Determining Current Site and Searching For New Site	51
	Status Messaging	38	Locking/Unlocking a Site	51
	P25 Packet Data	38	ZoneFail Site Lock	51
5.18	Keypad Programming	38	P25 Wide Area Scan	51
	Introduction	38		
	Menu Description	39		
	Zone Password	39		
	Zone Change Parameter	39		
	Channel Change Parameter	40		
	System Parameters	40		
	Channel Parameters	40		
6	SMARTNET/SMARTZONE/P25 TRUNKED FEATURES		7 MISCELLANEOUS	
6.1	Introduction	42	7.1 Supervisory Tones	53
6.2	Analog and Digital Operation	42	7.2 Error Messages	54
6.3	Viewing Unit ID	42	7.3 System Operator Programming	55
6.4	Standard Group Calls	42	7.4 Speaking Into Microphone	56
	Introduction	42	7.5 Operation At Extended Range	56
	Placing a Standard Group Call	42	7.6 Licensing	56
	Receiving a Standard Group Call	42	7.7 Radio Service	56
6.5	Private (Unit-To-Unit) Calls	43		
	General	43		
	Placing an Enhanced Private Conversation Call	43		
	Placing a Standard Private Conversation Call	44		
	Receiving a Private Call (All Types)	45		
6.6	Telephone Calls	45	8 DETERMINING AVAILABLE OPTIONS	
	General	45	8.1 General	57
	Placing a Telephone Call	45	8.2 Upgrading A Radio With New Options	57
	Answering a Telephone Call	46	8.3 Using PCConfigure To Determine Options	57
6.7	Call Alert	46		
	General	46		
	Answering a Page	46		
	Initiating a Page	47		
6.8	Messaging	47	9 PASSWORD DESCRIPTION	
6.9	Sending Status Conditions	47	9.1 New Password Enhancements	59
6.10	Emergency Alarm and Call	47	Introduction	59
	Introduction	47	9.2 Programming Passwords	59
			General	59
			Lost Passwords	59
			Changing Password	59
			Password Entry Procedure	59
			9.3 Password Description	60
			User (Power-On) Passwords	60
			Download/Upload Passwords	60
			Master Password	60
			9.4 Zone Password	60

**10 SECURE COMMUNICATION
(ENCRYPTION)**

10.1 General 61
 Introduction..... 61
 Encryption Algorithms 61
 Encryption Available With Various Channel Types
 61
 FIPS and Non-FIPS Modes..... 61
 10.2 Encryption Keys 62
 Introduction..... 62
 Key and Algorithm IDs..... 62
 PID/SLN Key Management Modes 62
 Maintaining Keys in Memory..... 63
 Encryption Key Select 63
 Encryption Key Erase..... 63
 Encryption Icon Operation 63
 10.3 Clear/Secure Strapping 63
 Transmit Mode Options 63
 Receive Mode Options..... 64
 Talk Group Encryption Override 64
 10.4 OTAR (Over-The-Air Rekeying) 64
 Introduction..... 64
 Encryption Key Types 65

Keysets..... 65
 Crypto Groups 65
 Key Management Facility 65
 Message Number Period (MNP) 66
 Definitions 66
 10.5 Radio Setup For Encryption 68
 General Encryption Setup 68
 Additional Setup For OTAR 69
 10.6 Radio OTAR Capabilities..... 69
 SEM 4100/53xx, Standard 41xx 69
 UCM Equipped 4100..... 70
 OTAR Option Switches..... 70

INDEX..... 74

RF ENERGY EXPOSURE AWARENESS AND CONTROL INFORMATION, AND OPERATIONAL INSTRUCTIONS FOR FCC OCCUPATIONAL USE REQUIREMENTS

Before Using Your Portable Two-Way Radio, Read This Important RF Energy Awareness And Control Information And Operational Instructions To Ensure Compliance With The FCC's RF Exposure Guidelines.

NOTICE: This radio is intended for use in occupational/controlled conditions where users have full knowledge of their exposure and can exercise control over their exposure to meet FCC limits. This radio device is NOT authorized for general population, consumer, or any other use.

This two-way radio uses electromagnetic energy in the radio frequency (RF) spectrum to provide communications between two or more users over a distance. It uses radio frequency (RF) energy or radio waves to send and receive calls. RF energy is one form of electromagnetic energy. Other forms include, but are not limited to, electric power, sunlight and x-rays. RF energy, however, should not be confused with these other forms of electromagnetic energy, which when used improperly can cause biological damage. Very high levels of x-rays, for example, can damage tissues and genetic material.

Experts in science, engineering, medicine, health and industry work with organizations to develop standards for exposure to RF energy. These standards provide recommended levels of RF exposure for both workers and the general public. These recommended RF exposure levels include substantial margins of protection. All two-way radios marketed in North America are designed, manufactured and tested to ensure they meet government established RF exposure levels. In addition, manufacturers also recommend specific operating instructions to users of two-way radios. These instructions are important because they inform users about RF energy exposure and provide simple procedures on how to control it. Please refer to the following web sites for more information on what RF energy exposure is and how to control your exposure to assure compliance with established RF exposure limits.

- <http://www.fcc.gov/oet/rfsafety/ef-faqs.html>
- <http://www.osha.gov/SLTC/radiofrequencyradiation/index.html>

FEDERAL COMMUNICATIONS COMMISSION REGULATIONS

The FCC rules require manufacturers to comply with the FCC RF energy exposure limits for portable two-way radios before they can be marketed in the U.S. When two-way radios are used as a consequence of employment, the FCC requires users to be fully aware of and able to control their exposure to meet occupational requirements. Exposure awareness can be facilitated by the use of a product label directing users to specific user awareness information. Your EFJohnson two-way radio has a RF exposure product label. Also, your EFJohnson user manual, or product manual, or separate safety booklet includes information and operating instructions required to control your RF exposure and to satisfy compliance requirements.

COMPLIANCE WITH RF EXPOSURE STANDARDS

Your EFJohnson two-way radio is designed and tested to comply with a number of national and international standards and guidelines (listed below) for human exposure to radio frequency electromagnetic energy. This radio complies with the IEEE and ICNIRP exposure limits for occupational/controlled RF exposure environment at operating duty factors of up to 50% transmitting and is authorized by the FCC for occupational use only. In terms of measuring RF energy for compliance with the FCC exposure guidelines, your radio radiates measurable RF energy only while it is transmitting (during talking), not when it is receiving (listening) or in standby mode.

NOTE: The approved batteries supplied with this radio are rated for a 5-5-90 duty factor (5% talk-5% listen - 90% standby), even though this radio complies with the FCC occupational RF exposure limits and may operate at duty factors of up to 50% talk.

Your EFJohnson two-way radio complies with the following RF energy exposure standards and guidelines:

- United States Federal Communications Commission, Code of Federal Regulations; 47 CFR §§ 1.1307, 1.1310, 2.1091 and 2.1093
- American National Standards Institute (ANSI) / Institute of Electrical and Electronic Engineers (IEEE) C95. 1-1992

- Institute of Electrical and Electronic Engineers (IEEE) C95.1-1999 Edition

RF EXPOSURE COMPLIANCE AND CONTROL GUIDELINES AND OPERATING INSTRUCTIONS

To control your exposure and ensure compliance with the occupational/controlled environment exposure limits, always adhere to the following procedures.

Guidelines:

- Do not remove the RF Exposure Label from the device.
- User awareness instructions should accompany the device when it is transferred to other users.
- Do not use this device if the operational requirements described herein are not met.

Operating Instructions:

- Transmit no more than the rated duty factor of 50% of the time. To transmit (talk), push the Push-To-Talk (PTT) button. To receive calls, release the PTT button. Transmitting 50% of the time, or less, is important because this radio generates measurable RF energy exposure only when transmitting (in terms of measuring for standards compliance).
- Hold the radio in a vertical position in front of face with the microphone (and the other parts of the radio, including the antenna) at least one inch (2.5 cm) away from the nose. Keeping the radio at the proper distance is important because RF exposures decrease with distance from the antenna. The antenna should be kept away from eyes.
- When worn on the body, always place the radio in an EFJohnson approved clip, holder, holster, case, or body harness for this product. Using approved body-worn accessories is important because the use of EFJohnson or other manufacturer's non-approved accessories may result in exposure levels which exceed the FCC's occupational/controlled environment RF exposure limits.
- If you are not using a body-worn accessory and are not using the radio in the intended use position in front of the face, then ensure the antenna and the radio are kept at least one inch (2.5 cm) from the body when transmitting. Keeping the radio at the proper distance is important because RF exposures decrease with increasing distance from the antenna.
- Use only EFJohnson approved supplied or replacement antennas, batteries, and accessories. Use of non-

EFJohnson approved antennas, batteries, and accessories may exceed the FCC RF exposure guidelines.

- For a list of EFJohnson approved accessories, see the service manual or marketing accessory lists or contact the E.F. Johnson Company

CONTACT INFORMATION

Toll-Free: 1-800-328-3911

FAX: 972-818-0639

E-Mail: customerservice@efjohnson.com. You can also e-mail a person directly if you know their first initial/last name (example: jsmith@efjohnson.com).

You may also contact the Customer Service Department by mail. Please include all information that may be helpful in solving your problem. The mailing address is as follows:

E.F. Johnson Company
Customer Service Department
1440 Corporate Drive
Irving, TX 75038-2401

ELECTROMAGNETIC INTERFERENCE

This device complies with Part 15 of the FCC rules. Operation is subject to the condition that this device does not cause harmful interference. In addition, changes or modification to this equipment not expressly approved by the E.F. Johnson Company could void the user's authority to operate this equipment (FCC Rules, 47CFR Part 15.19).

USAGE COMPATIBILITY

DO NOT operate it in areas that are sensitive to RF energy such as aircraft, hospitals, blasting sites, and fuel storage sites. Areas with potentially flammable atmospheres are usually, but not always, clearly posted. These may include gas stations, fuel and chemical storage and transfer stations, below deck on boats, and areas where the air contains flammable chemicals or particles such as grain dust or metal powders.

BATTERY DISPOSAL

Dispose of the nickel metal-hydride (NiMH) battery used by this radio in accordance with local regulations. DO NOT dispose of it in fire because it can explode. Also, do not short the terminals because it may become very hot.

SECTION 1 FEATURES

NOTE: The availability of many of the following features is controlled by factory coding of your radio, installed options, firmware version, and field programming. Refer to Section 8 for more information.

1.1 GENERAL FEATURES

- The following operating modes are programmable:
 - Conventional analog
 - Conventional Project 25 (digital)
 - Trunked Project 25 (digital)
 - SMARTNET™/SmartZone® trunked (analog or digital)
- Up to 32 zones with 16 channels each (512 channels total) are standard.
- Large graphic display with backlight
- 16-position channel select switch
- 3-position rotary option switch
- Up to 9 (limited keypad) or 21 (DTMF keypad) programmable option switches
- Each option button programmable with a different function for each operating mode (Conventional, SMARTNET/SmartZone, Trunked P25)
- Menu mode
- AES 256-bit FIPS 140-2 approved encryption available on P25/digital channels
- DES/DES-XL 64-bit encryption available on analog channels, DES-OFB on digital channels (see Section 10).
- Emergency calls for high priority system access
- Priority (standard) and Radio Wide scan modes with user programmable scan lists
- User selectable high and low power output
- Surveillance mode
- Time-out timer
- Keypad lock to prevent accidental key presses
- Power up password to prevent unauthorized use.
- Programmable and user adjustable tone volume
- Programmable minimum volume level
- Soft power down to prevent accidental power off
- Operates on both wide and narrow band channels

1.2 CONVENTIONAL FEATURES

- Up to 512 channels or talk groups programmable
- Repeater talk-around

- Carrier or Call Guard® (CTCSS/DCS) controlled squelch on analog channels, NAC and talk group IDs on P25 channels.
- Normal/selective squelch selectable by option switch or menu
- Monitor mode selectable by option switch or menu
- Penalty and conversation timers
- Dual priority channel sampling when scanning (analog and digital channels)
- Busy channel lockout (transmit disable on busy)
- Unit calls on P25 channels
- Telephone calls on P25 channels with over dial.
- Cloning capability (wireless or using cable)
- Emergency alarms and calls to alert a dispatcher of an emergency condition.
- Single tone encoder controllable by user on analog channels
- ANI (Automatic Number Identification) on analog channels
- MDC1200 ANI and Emergency Alert support.
- Call Alert™ on P25 channels (send and receive pages).
- Predefined messages (up to 16) can be sent to a dispatcher (P25 mode only)
- Predefined status conditions (up to 8) can be sent to a dispatcher (P25 mode only)
- OTAR (Over-The-Air-Rekeying) compatible (P25 channels only).
- Keypad programming with password access (Federal Government users only)

1.3 SMARTNET/SMARTZONE FEATURES

- Up to 512 talk groups programmable (channels select talk groups)
- Group, Enhanced Private Conversation™, standard Private Conversation, and Telephone calls
- Emergency alarms to alert a dispatcher of emergency conditions
- Emergency calls for high priority system access
- Failsafe operation on a predefined conventional channel if trunked system fails
- Priority group calls detected while listening to other group calls when scanning
- Call Alert™ (send and receive pages)
- Predefined messages (up to 16) can be sent to a dispatcher

- Predefined status conditions (up to 8) can be sent to a dispatcher
- Dynamic regrouping (dispatcher can automatically gather users on a channel to receive a message)
- Roaming (SmartZone only)

1.4 PROJECT 25 TRUNKED FEATURES

- Up to 512 talk groups programmable (channels select talk groups)
- Group and Unit Calls
- Telephone calls with over dial
- Emergency alarms to alert a dispatcher of emergency conditions

- Emergency calls for high priority system access
- Failsoft operation on a predefined conventional channel if trunked system fails
- Priority group calls detected while listening to other group calls when scanning
- Call Alert™ (send and receive pages)
- Predefined status conditions (up to 8) can be sent to a dispatcher
- Dynamic regrouping (dispatcher can automatically gather users on a channel to receive a message)
- Roaming

SECTION 2 CONTROLS AND DISPLAY

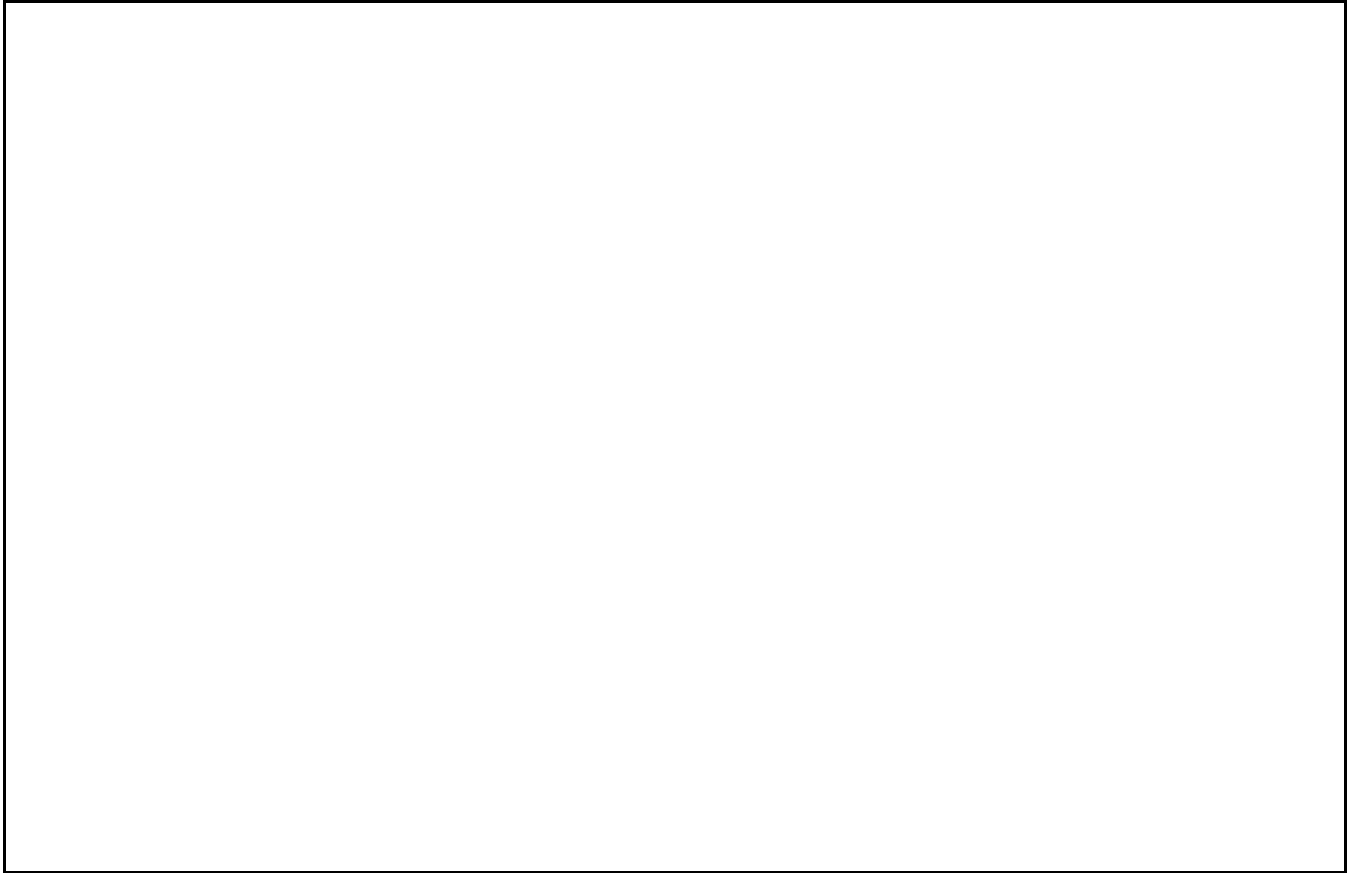

Figure 2-1 Front Panel Controls

2.1 FRONT PANEL CONTROLS

NOTE: The location of these controls is shown in Figure 2-1.

Microphone - The microphone is located behind the small opening shown in Figure 2-1. For best results, hold the radio 2-3 inches from your mouth and speak at a normal conversational level. Do not shout since it distorts your voice and does not increase range.

Display - This is a graphical LCD (Liquid Crystal Display). The display backlight can be programmed to turn on when any key is pressed or when the Backlight option switch is pressed or menu parameter selected (see Section 3.5).

Up/Down Switch - Selects zones when multiple zones are programmed (see Section 3.3). Pressing the upper part of the switch selects the next higher number and pressing the lower part selects the next lower number. This control also provides up/down select in the menu mode and in other modes when up/down select is required.

F1 - In menu mode (see Section 4.2), functions as a step back and exit switch. If menu mode is not used, it is a programmable option switch.

F2 - Selects the menu mode when that mode is enabled by programming. Also functions as an Enter or Select switch in the menu and other modes. If menu mode is not used, it is a programmable option switch.

F3, F4 - Programmable option switches.

DTMF Keypad - The full keypad DTMF models include the 12 keys required to dial telephone and unit ID numbers.

Speaker - The radio speaker is located near the bottom of the front panel. When a speaker/microphone is used, it is automatically detected when the Opt Sel 1 line of the accessory connector is pulled low. The logic then automatically disables the internal speaker.

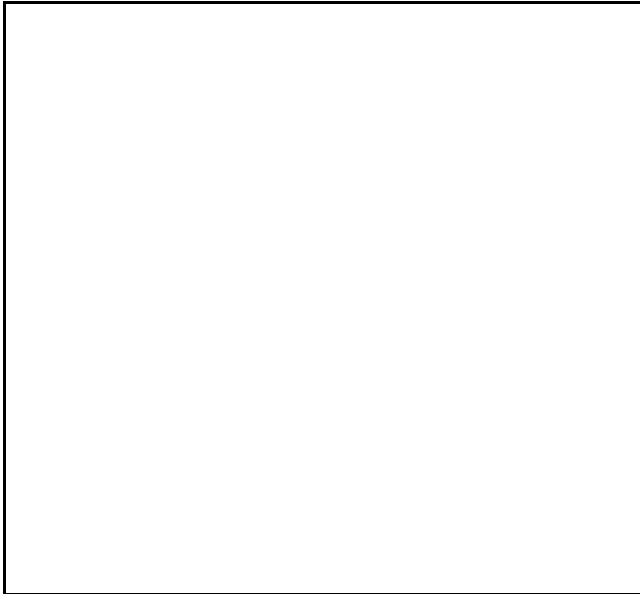

Figure 2-2 Top Panel Controls

2.2 TOP PANEL CONTROLS

Multi-Function Indicator - Indicates the following conditions:

Steady Red - Transmitter keyed.

Flashing Red - Low battery in receive mode.

Steady Green - Carrier detected in receive mode.

NOTE: This indicator is disabled if the Surveillance mode is programmed (see Section 4.7).

On-Off/Volume - Turning the knob clockwise turns power on and sets the volume level. Turning it counterclockwise to the detent turns power off. The minimum volume level can be set by programming. Soft power down can be programmed as described in Section 3.1.2, and the volume control can be disabled as described in Section 3.1.3.

Channel Switch - This 16-position switch selects up to 16 channels in the current zone. Additional zones can be programmed to allow up to 512 channels to be selected by this switch. This control can be disabled as described in Section 3.3.

Rotary Option Switch - This is a three-position switch that can be programmed to control various options. The “A” position is “on” and the “B” and “C” positions are “off” (see Section 4.1). When this switch is programmed to select zones, “A” selects Zone 1, “B” Zone 2, and “C” Zone 3 if applicable.

Antenna Connector - Connection point for the antenna. Make sure the antenna is tight before using the radio.

Emergency Switch - This switch or some other option switch can be programmed as an Emergency switch to alert a dispatcher of an emergency condition. Refer to Sections 5.10 and 6.10 for more information. This switch can also be programmed for other functions.

2.3 SIDE CONTROLS

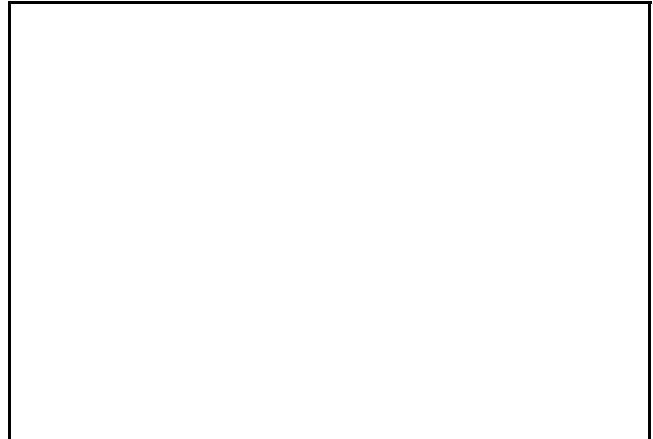



Figure 2-3 Side Controls and Jacks

PTT (Push-To-Talk) Switch - This switch is pressed to turn the transmitter on to transmit a message. It is then released to listen. Transmitting is indicated when the top panel indicator is constant red or  is displayed (surveillance mode only, see Section 4.7).

Option Switches 1, 2, and 3 - Each of these switches can be programmed to control a specific function (see Section 4.1). In addition, they can be programmed for

soft power down (see Section 3.1.2). These switches can also be temporarily disabled by the keypad lock feature (see Section 3.6) or permanently disabled.

Battery - To remove the battery, press the release button on the bottom and pivot the bottom of the battery outward.

Accessory Connector - Connection point for optional accessories such as a speaker/microphone or earphone. It is also the connection point for the computer when programming the radio or for data equipment when the P25 Packet Data feature is used (see Section 5.17.10).

2.4 DISPLAY

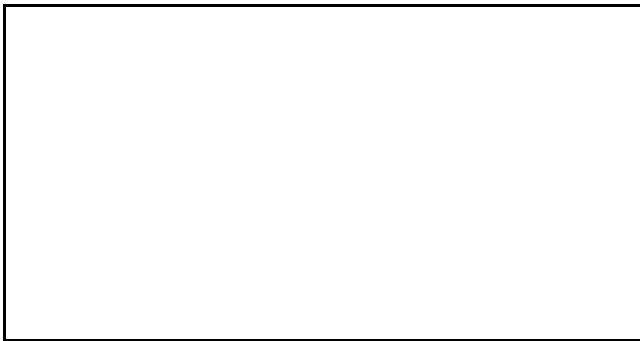







Figure 2-4 Graphical Display

The front panel display is shown above. Icons are typically shown in the upper part of the display and text messages in the lower part. The icons are as follows:

 - When the scan or the scan list edit mode is enabled, indicates that the displayed channel is in the scan list and scanned (see Section 4.8).

 - When the scan or the scan list edit mode is enabled, indicates that the displayed channel is a priority channel. If dual priority is used,  indicates that it is a second priority channel.

 - Low battery indication (see Section 3.4).

 - Voice encryption is enabled or an encrypted call is being received. This indication flashes when an encrypted call is received on a digital channel (see Section 10.2.7).

 - Priority or radio wide scanning is enabled (see Section 4.8).

 - In the surveillance mode only, indicates that the transmitter is keyed (see Section 4.7). This icon is displayed in place of the preceding scan mode icon when applicable. They do not conflict because the scan icon is not displayed in the transmit mode.

 - Repeater talk-around is enabled (see Section 5.8).

 - The Monitor mode is enabled by the Monitor option switch or menu parameter (see Section 5.3). The radio can also be programmed so this icon is displayed when the Normal mode is selected by the Normal/Selective function (see Section 5.5.2).*

 - Keypad programming or another mode is enabled which allows the user to edit radio parameters.

 - An interconnect (telephone) call is in progress (see Section 6.6).

 - A Project 25 or SMARTNET/SmartZone private (unit-to-unit) call is in progress.

SECTION 3 GENERAL OPERATION

3.1 TURNING POWER ON AND SETTING VOLUME

3.1.1 POWER UP

Power is turned on and off by the top panel On-Off/Volume switch. When power is initially turned on, the following events occur:

- The software version number is displayed.
- A self test is performed.
- The currently selected zone is displayed.
- If a conventional P25 channel is selected, the Individual ID of the radio is displayed.
- If a SMARTNET/SmartZone or P25 Trunked channel is selected, the Unit ID of the radio is displayed.
- A tone sounds (if tones are enabled)
- The selected channel alias is displayed continuously when power-up is complete.

Programming determines if the radio powers up on the last selected zone or the pre-programmed home zone. Refer to Section 3.3 for information on the channel that is selected. The minimum volume level may be set by programming. This can prevent missed messages resulting from inadvertently turning the volume to an inaudible level.

3.1.2 STANDARD AND SOFT POWER DOWN

To turn power off, rotate the On-Off/Volume control counterclockwise until a click occurs. Power may remain on for an instant after turn-off occurs.

A soft power down feature can be programmed to prevent radio power from being turned off by accidentally turning the on-off/volume control. Any side button can be programmed for this function in addition to its normal function. Then for power to turn off, this button must be pressed during or after power is turned off in the normal manner using the knob (there is no time out).

3.1.3 SETTING VOLUME LEVEL

The volume level is adjusted by the top panel volume control knob or by option buttons programmed

for the Up/Down volume function. When the buttons are used, the volume control function of the knob is disabled (it is still used to switch power). Volume buttons may be used instead of the knob, for example, if accidental turning of the volume knob is a problem.

When the volume control buttons are used, the number of steps (ticks) required to change the volume from the minimum level to maximum level is programmable for 1-50. For example, if “20” is programmed, there are 20 adjustment steps from minimum to maximum volume. Only one volume control button can be programmed if desired and wrap-around then occurs after the maximum or minimum level is selected.

The radio can also be programmed so that volume control is also be disabled by the Keypad Lock feature. Refer to Section 3.6 for more information.

The relative volume level can be determined by the position of the index on the volume knob or by a reference signal as follows:

- If a key press tone is enabled, a short tone sounds when a key is pressed.
- If a conventional channel is selected and the Monitor option switch or menu parameter is programmed, pressing that switch unquelsches the receiver and either voice or background noise is heard (see Section 5.3). If a SMARTNET/SmartZone or P25 Trunked channel is selected, the receiver cannot be manually unquelsched.

3.2 POWER-UP PASSWORD

3.2.1 GENERAL

The power-up password feature prevents unauthorized use of the radio by locking the keypad on power up until the proper password is entered. This feature is enabled or disabled by programming.

When it is enabled, “ENTER PSWD” is briefly displayed when power is turned on. The eight-digit

numeric password must be then be entered as follows. If an incorrect password is entered, “INCORRECT” is displayed and it must be re-entered.

DTMF Keypad Models - Enter the password using the 1-8 keys and then press the Enter (F2) key when finished. If a mistake is made, the last digit can be erased by pressing the F1 (Clear) key.

Limited Keypad Models - Select the proper number for each position by pressing the Up/Down switch. When the proper number for a position is displayed, select it and move on to the next position by pressing the F2 (Enter) key. If the password is less than eight digits, press F2 twice after the last digit.

3.2.2 PASSWORD FEATURES

An enhanced password scheme allows up to four power-on (user) passwords, download and upload passwords, and a master password to be programmed.

The current User password can be changed if the “Set User Password” option switch or menu parameter is programmed. Selecting this function displays prompts for entering and confirming a new password. It is recommended that a number key not be used for this function because the password mode is exited if that key is pressed to enter a number. Refer to Section 9 for more information on passwords.

3.3 ZONE AND CHANNEL SELECT

The selected zone and channel are selected and displayed as follows. For more information on zones and channels, refer to Section 3.9.5.

Zone Select

The front panel Up/Down switch briefly displays and changes the alias of the current zone. When not in special modes such as the menu mode, pressing either the top or bottom part of this switch once displays the alias of the current zone. Then quickly pressing it again changes the selected zone up or down. The rotary A/B/C switch on the top panel can also be programmed for zone select. The “A” position then selects Zone 1, “B” Zone 2, and “C” Zone 3 (if applicable).

After the highest programmed zone is displayed, wrap-around to the lowest programmed zone occurs and vice versa. The selected zone is also displayed briefly on power up. If the selected zone alias needs to be displayed continuously, it must be programmed as part of the channel alias.

Channel Select

Channels are selected by the rotary 16-position switch on the top panel. The alias (identification) for the selected channel/group is displayed continuously during normal operation.

When an unprogrammed channel is selected, “UNPROGRAMD” is displayed and a tone sounds (if tones are enabled). When conventional channels are selected and the Display Information option key or menu parameter is programmed, either the channel frequency or alias can be displayed (see Section 5.9).

The channel selector knob can also be disabled by programming. Channels must then be directly selected as described next (if applicable). It may be desirable to disable the channel select knob when direct selection is used in order to prevent confusion since the channel knob then may not indicate the selected channel.

The radio can also be programmed so that the channel select control is also be disabled by the Keypad Lock feature (Section 3.6) similar to the volume control described in Section 3.1.3.

Direct Zone/Channel Selection

The direct Channel Select feature is available if the Channel Select option switch or menu parameter is programmed. This feature allows channels to be directly selected using the DTMF keypad numeric keys (DTMF models only) or Up/Down switch (all models).

For direct selection purposes, channels are numbered sequentially starting with the lowest zone. Each zone can be programmed with up to 16 channels, so Zone 1 channels are numbered 1-16, Zone 2 channels 17-32, and so on as shown below. For example, Zone 1/Channel 16 is selected by Channel 16, and Zone 2/Channel 16 is selected by Channel 32.

Seq. Ch. No.	Zone	Channel
1 ↓ 16	1	1 ↓ 16
17 ↓ 32	2	1 ↓ 16
33 ↓	3	1 ↓

Proceed as follows to select channels using this mode:

1. Enable the direct Channel Select mode by pressing the Channel Select option switch or selecting the “Chan Selct” menu parameter. The alias and sequential number of the current channel are alternately displayed.
2. Select the desired channel using the Up/Down keys or directly enter it using the 0-9 keys (if available). If using the 0-9 keys, the radio attempts to display the entered number after the 3rd digit is entered or approximately 2 seconds after the last key is pressed.
3. To exit the this mode and select the entered channel, press the Channel Select switch again or the F2 key. To exit without changing the channel, press the F1 key. This mode is also exited automatically without changing the channel after approximately 1 minute of no activity.

NOTE: The Channel Select function should probably not be assigned to a number key because pressing that key to select a channel then exits the select mode.

Other features of this mode are as follows:

- When using the Up/Down keys, wrap-around to the lowest zone/channel occurs after the last channel in the highest programmed zone is displayed and vice versa. For example, if Zone 1/Channel 5 is the highest programmed channel, wrap-around occurs after Zone 1/Channel 16 is displayed.

- When an unprogrammed channel is displayed, the sequential channel number and “Unprogramd” are alternately displayed.
- If an invalid channel number is entered using the 0-9 keys, or the F2 or Channel Select option switch is pressed with “Unprogrammed” displayed, an error tones sounds, “Invalid” is briefly displayed, and the displayed channel does not change.
- The rotary Channel Select switch may not correctly indicate the selected channel after direct channel selection is used. However, if this switch is enabled and rotated, it selects the channel it is indicating. For example, if the switch index is pointing to channel 3 and channel 15 of the current zone is being displayed, rotating it to channel 4 selects channel 4 of the current zone.
- If the rotary Channel Select switch is enabled, the radio always powers up on the channel it is selecting.

If it is disabled, the radio can be programmed to power-up on the last selected or home channel number of the last selected or home zone. With the “Last Zone”/“Home Channel” configuration, the programmed home channel number of the last active zone is selected. If it is not programmed, “Unprogrammd” is displayed. With earlier models, the last selected channel is displayed when powering up on the last selected zone, and channel 1 is displayed when powering up on the home zone.

3.4 LOW BATTERY INDICATION

3.4.1 GENERAL

NOTE: If the radio contains encryption keys and is not programmed for infinite key retention, be sure to reattach a battery within approximately 30 seconds to prevent the loss of these keys (see following).

A low-battery condition is indicated by the  icon in the display. The battery should be recharged or replaced as soon after this indication appears. Once this indication appears, it stays on until power is cycled.

The following additional low battery indications and conditions may be enabled by programming:

- A chirp sounds once a minute in the receive standby and transmit modes.
- A chirp sounds each time the PTT switch is pressed.
- The top panel LED indicator flashes red every 30 seconds in the receive mode.
- Low power is selected when transmitting.

As indicated in the preceding note, the radio may need to be connected to a constant power source to preserve the encryption keys in memory. This is required if “infinite key retention” is not programmed. To allow the battery to be changed without losing the keys with this feature disabled, storage capacitors maintain the supply voltage to memory for approximately 30 seconds without a battery attached. Therefore, be sure to reattach a battery within that time. Refer to Section 8.1.6 for more information on encryption keys.

There is a battery saver feature that can be enabled by programming. This feature functions on trunked channels only, and it automatically selects low transmit power when the receive signal strength (RSSI) indicates that the site is nearby.

3.4.2 BATTERY CHARGING

NOTE: When a battery is charged while attached to the radio, make sure radio power is off (see following).

The battery can be charged separately or while attached to the radio. When it is charged while attached to the radio, radio power should be turned off. If it is not, the battery begins slowly discharging when the charger enters the trickle charge mode. This mode is indicated by a green Ready indication, and it is entered automatically when the battery is nearly fully charged. Gradual discharging occurs in the trickle mode because the charge current of approximately 50 mA is less than the radio standby current of approximately 200 mA.

CAUTION: Do not transmit in close proximity to the charger base (see following).

Do not expose the charger base to high level RF signals while a battery is being charged because this may cause a charger fuse to blow (especially in the

UHF range). Radios programmed for SMARTNET/ SmartZone operation, for example, may affiliate while in the charger which causes them to automatically key. Therefore, do not leave radio power on while charging as described above.

3.5 BACKLIGHT

The backlight for the display and option keys can be programmed to automatically turn on when any key is pressed. It then automatically turns off after a programmed delay of 0-7.5 seconds so that battery drain is minimized. If the Backlight option switch or menu parameter is programmed, the user can manually turn the backlight on and off (it then stays on). If the Surveillance mode is programmed, the backlight is disabled (see Section 4.7). The radio can be programmed so that the backlight turns on in the keypad lock mode when a key is pressed (see next section).

3.6 KEYPAD LOCK

The Keypad Lock feature temporarily disables the front panel keys to prevent keys from being accidentally pressed. This feature is available if the Keypad Lock option switch is programmed. To lock the keypad, simply press the Keypad Lock option switch. Then to unlock the keypad again, press and hold this switch until a tone sounds (approximately 1 second).

Permanent Keypad Lockout can also be programmed. The keypad is then permanently disabled and cannot be enabled by the user. Additional information on this feature is as follows:

- A global “Front Keypad Lockout Only” function can be selected by programming. The front panel keys but not the side panel option keys are then disabled by the preceding Keypad Lock and Permanent Lock functions. If this function is not selected, both the front and side panel keys are disabled. The PTT switch is never disabled.
- The Channel Selector and Volume controls can be programmed so that they are locked by the Keypad Lock function.
- The “Channel Selector Enabled” function can be programmed globally. If this is not selected, the

channel selector is always disabled regardless of the Permanent Lockout or Keypad Lock status. Channels can then be selected only by direct channel select (see Section 3.3).

- The volume control is permanently disabled if a Volume Up/Down option switch is programmed regardless of the Permanent Lockout or Keypad Lock status. Refer to Section 3.1.3 for more information.
- There is the option to enable the backlight when a key is pressed in the Keypad Lock mode. There is also the option when programming conventional channels to disable DTMF dialing.

3.7 SETTING SQUELCH

This radio does not have a squelch control. The squelch level is preset during alignment. If the keypad programming feature is available (see Section 5.18), the squelch level can be changed by the user on each conventional analog channel.

3.8 TRANSMIT DISABLE

Transmitting can be disabled on each conventional, SMARTNET, SmartZone, and P25 Trunked channel so that the channel is monitor-only. When transmitting is attempted on a receive-only channel, "Rx Only" is displayed and an error tone sounds.

3.9 RADIO OPERATING MODES

3.9.1 GENERAL

Each selectable channel can be programmed for the conventional (analog or APCO Project 25 digital), SMARTNET/SmartZone, or APCO Project 25 digital trunked operating mode. For example, Zone 1/Channel 1 could be a conventional channel, Zone 1/Channel 2 a SMARTNET channel, and so on. More information on these modes follows.

3.9.2 CONVENTIONAL MODE

This is a non-trunked operating mode which accesses independent radio channels. There is no automatic access to several channels. Selecting a conven-

tional channel selects a transmit and receive frequency and other channel parameters such as squelch control coding.

Conventional channels can be either standard (analog) or Project 25 (digital). With digital operation, the DSP (Digital Signal Processor) converts the audio signal to digital data which is sent over the air as complex tones. Another difference is that analog channels use Call Guard (CTCSS/DCS) squelch control and Project 25 channels use a NAC (Network Access Code) and talk group ID codes.

With Project 25 operation, a NAC is transmitted and it must match the NAC programmed in the base equipment and the radio(s) being called for communication to occur. In addition, to receive standard group calls, the receiving radio must be programmed to detect the transmitted talk group ID code.

With conventional operation, a busy channel condition is detected automatically if the busy channel lockout (transmit disable on busy) feature is programmed. Otherwise, it must be detected manually. An out-of-range condition is not indicated by special tones or messages as with SMARTNET operation because there is no initial data exchange with the repeater that allows this condition to be detected. Operating features unique to conventional channels are described in Section 5.

3.9.3 SMARTNET/SMARTZONE MODE

This is a trunked operating mode in which automatic access is provided to several RF channels. ID codes are used to select what radios are being called and what calls are received. Monitoring is performed automatically and special messages and tones indicate busy and out-of-range conditions.

SMARTNET and SmartZone operation and programming is very similar. Basically, SMARTNET operation is limited to a single repeater site and SmartZone operation allows automatic roaming between sites. Enhanced SMARTNET/SmartZone features include roaming (SmartZone only), telephone, private, and emergency calls, Call Alert™, and messaging. Either analog or digital signaling may be used (digital is optional).

When a SMARTNET or SmartZone channel is selected or the radio is powered up on one of those channels, it searches for a control channel. Once a control channel is found, the alias (name) of the selected channel is displayed and the radio attempts to register on the radio system. If a control channel could not be found (because of an out of range condition or the system ID is not correct, for example), “NO SYS” (early units) or “Out Rnge” (later units) is displayed and the radio continues to search for a control channel.

The control channel transmits and receives system information to and from all radios registered on the system. Therefore, once a control channel is found, it is continuously monitored for incoming call information and is used to make call requests. The radio automatically changes to a traffic channel to place and receive calls and then returns to the control channel when the call is complete. Operating features unique to SMARTNET/SmartZone channels are described in Section 6.

3.9.4 P25 TRUNKED MODE

The P25 Trunked operating features are very similar to the SmartZone type just described. Since SmartZone features are also similar to SMARTNET features, all three modes are described in the Section 6. Some differences between the P25 Trunking and SmartZone modes are as follows:

- Digital signaling is always used with P25 calls. Either analog or digital signaling may be used for SmartZone calls.
- Calls made to a specific radio in the P25 mode are called Unit Calls. In the SMARTNET/SmartZone mode they are called Private Calls.
- Messaging is not available with P25 calls.
- The P25 control channel data rate is 9600 baud and the digital voice data rate is also 9600 baud. With SmartZone operation, the control channel data rate is 3600 baud (both digital and analog calls) and the narrowband digital voice data rate is 9600 baud.
- The P25 mode uses a system ID, Wide Area Communications Network (WACN) ID, and RF

Subsystem ID (RFSS). The SmartZone mode does not use the WACN and RFSS IDs.

- P25 Unit IDs can be 1-16,777,215 (000001-FFFFFF hex) and SmartZone Unit IDs can be 1-65,535 (0001-FFFF hex).

3.9.5 SYSTEMS, CHANNELS, AND ZONES

A zone and channel are selected to place and receive calls. The following describes the relationship between systems, channels, and zones.

Systems

A system is a collection of channels or talk groups belonging to the same repeater site. It defines all the parameters and protocol information required to access a site. Up to 16 systems of any type can be programmed.

The maximum number of channels assignable to a system is limited to 512. Channels may also be limited by available memory space as described in the following information.

Channels

A channel selects a radio (RF) channel or talk group as follows:

Conventional Analog Mode - A channel selects a specific radio channel, Call Guard (CTCSS/DCS) squelch coding, and other parameters unique to that channel.

Conventional Project 25 Mode - A channel selects a specific radio channel, NAC squelch coding, talk group ID, and other parameters unique to that channel.

SMARTNET/SmartZone and Trunked Project 25 Modes - A channel selects a specific talk group, announcement group, emergency group, and other parameters unique to that talk group.

A maximum of up to 512 channels can be programmed with the preceding modes. These channels can belong to a single system or multiple systems.

The maximum number is also limited by the available memory. For example, since more memory is required to program a SMARTNET system than a conventional system, the total number of channels decreases as the number of SMARTNET channels increases. The programming software displays a bar graph which shows the amount of available memory space that is used by the current data.

Zones

A zone is a collection of up to 16 channels of any type. For example, a zone could include 12 conventional channels and 4 SMARTNET channels. One use of zones may be to program the channels used for operation in a different geographical areas. The maximum number of zones is 32.

SECTION 4 RADIO-WIDE FEATURES

4.1 OPTION SWITCHES

NOTE: For descriptions of the functions controlled by these switches, refer to the section of this manual referenced in the last column of Table 4-1.

Almost all the buttons on this radio are programmable as follows:

- On the side panel, the three buttons above the PTT switch (see Figure 2-3 on page 11).
- On the top panel, the rotary three-position switch and the orange button (see Figure 2-2 on page 11).
- On the front panel, F1 and F2 unless the menu mode is used (see next section), and F3 and F4.
- With DTMF keypad models, all 12 DTMF keys.

The functions that can be controlled by option switches are shown in Table 4-1. Each option switch can be programmed to control a different function in each of the three operating modes. For example, F3 can control one function when a conventional channel is selected, another when a SMARTNET/SmartZone channel is selected, and still another when a Project 25 trunked channel is selected.

4.2 MENU MODE

NOTE: For descriptions of the functions controlled by the menu mode parameters, refer to the section of this manual referenced in the last column of Table 4-1.

Most functions that can be controlled by an option switch can also be controlled by the menu mode. The functions that can be controlled by the menu mode are shown in Table 4-1. Functions can be controlled by both an option switch and a menu parameter if desired.

When the menu mode is used, the F1 and F2 switches become dedicated menu mode control switches (see following illustration). The F1 switch is Back/Clear, and the F2 switch is Menu Select/Enter. If the menu mode is disabled, these switches can be programmed for other functions.

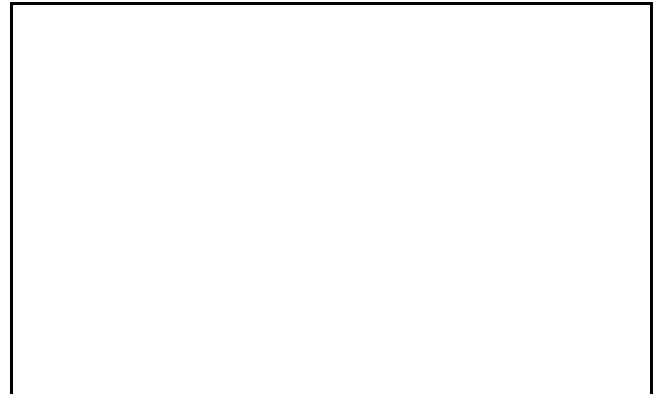

Menu Mode Buttons

Only the enabled menu items which apply to the selected channel type are displayed. For example, if a conventional channel is selected, only the enabled functions for conventional channels are displayed.

When in the menu mode, messages continue to be received on the selected channel. However, the display does not indicate who is calling. Pressing the PTT switch exits the menu mode and keys the transmitter.

The menu mode operates as follows:

1. To select the menu mode, press the F2 key. Up to three menu parameters are then displayed as shown in the preceding illustration.
2. To scroll up or down through the menu parameter list, press the Up/Down switch. The selected parameter is indicated by a dark bar.
3. To display the available modes for a highlighted parameter, press the F2 switch. The currently selected mode is indicated by an asterisk.
4. Press the Up/Down switch to highlight the desired mode. Then press the F2 key to select that mode.
5. To step back to the previous level or exit the menu mode, press the F1 (Back) key.

4.3 TIME-OUT TIMER

The time-out timer disables the transmitter if it is keyed continuously for longer than the programmed

Table 4-1 Programmable Option Switch and Menu Mode Functions

Function	Menu Display	Available in Mode:				See Descript. in Section:
		Conv.	P25 Trk	SMARTNET	SmartZone	
Alert tones On-Off	Tones	X	X	X	X	4.6
Backlight On-Off	Backlight	X	X	X	X	3.5
Call Alert Select	Call Alert	X	X	X	X	5.17.7, 6.7
Call Response Select	Call Rsp		X	X	X	6.5
Cancel Dynamic Regroup	Cancel DR		X	X	X	6.13
Change Keypad (OTAR)	Chg Keypad	X	X	X	X	10.6.3
Channel Select	Chan Selct	X	X	X	X	3.3
Clear/Secure Select	Security	X	X	X	X	10.3
Clone Select (menu only)	Clone	X				5.16
Configure (menu only)	Config	X	X	X	X	Not curr. used
Digital Talk Group Select	Select TG	X				5.17
Display Information Select	Display	X				5.9
Emergency Select	Emergency	X	X	X	X	5.10, 6.10
Erase Keys (menu only)	Erase Keys	X	X	X	X	10.2.6
High/Low Power Select	Tx Power	X	X	X	X	4.5
Home Zone Select	Home Zone	X	X	X	X	4.4
Key Select	Key Select	X				10.2.5
Keypad Lock Select	(Opt sw only)	X	X	X	X	3.6
Keypad Programming Select	Keypad Prg	X				5.18
Messaging	Message	X		X	X	5.17.8, 6.8
Monitor Mode Select	Monitor	X				5.3
Normal/Selective Select	Squelch	X				5.5
OTAR Rekey Request	OTAR Rekey	X				10.6.3
P25 Packet Data	Data Modes	X	X			5.17.10
Phone Call Select	Phone	X	X	X	X	5.17.6, 6.6
Priority Channel Select	Priority	X				5.11.3
Private Call Select	Priv Call			X	X	6.5
Radio Wide Scan Select	RW Scan	X	X	X	X	4.8
Repeater Talk-Around Select	Talk Arnd	X				5.8
RWS List Edit	RWS Edit	X	X	X	X	4.9.2
Scan Mode Select	Scan	X	X	X	X	4.8
Scan List Edit Select	Scan Edit	X	X	X	X	4.8
Scan List Select	Scan Selct	X	X	X	X	4.8
Set User Password	Set Paswd	X	X	X	X	9
Squelch Select List	Sqlch Code	X				5.5
Single Tone Encoder	Tone Encdr	X				5.14
Site Lock Select	Site Lock		X		X	6.14
Site Search Select	Site Srch		X		X	6.14
Status Select	Status	X	X	X	X	5.17.9, 6.9
Surveillance Mode Select	Surv Mode	X	X	X	X	4.7
Tone Volume Edit	Tone Vol	X	X	X	X	4.6
Unit Call Select	Unit Call	X	X			5.17
Unprogrammed (not used)	-	X	X	X	X	-
Volume Down	(Opt sw only)	X	X	X	X	3.1.3
Volume Up	(Opt sw only)	X	X	X	X	3.1.3

time. It can be programmed for 15 seconds to 3 minutes, 45 seconds or it can be disabled.

If the transmitter is keyed for longer than the programmed time, the transmitter is disabled, a continuous tone sounds, and “TX TIMEOUT” is displayed. Five seconds before time-out occurs, a warning beep sounds to indicate that time-out is approaching. The timer and tone are reset by releasing the PTT switch.

A different time can be programmed for each system, and the timer can be enabled or disabled on each conventional channel. With conventional channels, a penalty time may also be programmed that prevents transmissions for a certain time after the transmitter is disabled (see Section 5.6).

One use of this feature is to prevent a channel from being kept busy for an extended period by an accidentally keyed transmitter. It can also prevent possible transmitter damage caused by transmitting for an excessively long period.

4.4 HOME ZONE/CHANNEL SELECT

If the Home Zone option switch or menu parameter is programmed, it selects the preprogrammed home zone. The selected channel is displayed if the channel switch is enabled, and the preprogrammed home channel is selected if it is disabled.

Pressing and holding the Home Zone option switch until a tone sounds makes the currently selected zone the new Home zone. The radio is also programmed so that either the home or last selected zone is selected when power is turned on. Refer to Section 3.3 for more information.

4.5 POWER OUTPUT SELECT

Each conventional channel and SMARTNET/SmartZone and P25 Trunked system can be programmed for high, low, or switchable power. If the High/Low Power option switch or menu parameter is programmed and selectable power is programmed on the current channel or system, high and low transmitter power can be selected. All models support high and low power. The low power level is typically 1 watt and the high power level the rated power output of the radio (2.5 - 5 watts, depending on frequency band).

The new level is flashed in the display as either “HI POWER” or “LOW POWER”. If selectable power is not permitted on the current channel, “FIXED LOW” or “FIXED HIGH” is flashed and no change occurs. The selected power level for a channel or system is permanent until it is manually changed again. The low power mode may be automatically selected during a low battery condition (see Section 3.4).

4.6 ALERT TONE SELECT

The various alert tones that sound are described in Section 7.1. These tones can be turned on and off if the Alert Tone option switch or Tones menu parameter is programmed. When all tones are off, “TONE OFF” is momentarily displayed, and when all tones are on, “TONE ON” is momentarily displayed. If this switch or menu parameter is not programmed, tones are fixed in the on or off mode by programming. If the Surveillance mode is programmed (see following), tones are totally disabled.

The Alert Tone volume can be adjusted relative to the volume control setting. This is done by programming and also by the user if the Tone Volume Adjust option button or menu parameter is programmed. Relative levels of -170 to +170 can be set with “0” the default setting. A minus value decreases the tone volume and a plus value increases it. The user adjusted level permanently overrides the programmed level if applicable.

4.7 SURVEILLANCE MODE

The Surveillance mode totally disables the backlight, all alert tones, and front panel LED indicator in all operating modes. The radio can be fixed in this mode by programming or it can be turned on and off by the user if the Surveillance Mode option button or menu parameter is programmed. The user selected mode permanently overrides the programmed mode if applicable. To provide a transmit indication when the front panel LED is disabled, the  icon is displayed (see Section 2.4). This icon is displayed only in the surveillance mode.

4.8 SCANNING

4.8.1 INTRODUCTION

Scanning monitors the channels in the scan list for messages that the radio is programmed to receive. When a message is detected, scanning stops and the message is received. Shortly after the message is complete, scanning resumes (unless it has been disabled). When a call is received in the scan mode, the alias of the channel on which a call is received (and any other display parameters that may be programmed) are displayed until scanning resumes. The selected channel alias is then displayed if applicable.

There are two basic scan modes available: Priority (Standard) and Radio Wide. The operation of the priority type is unique to the type of channel selected, and the operation of Radio Wide type is the same regardless of the type of channel selected. Only one type can be enabled at a time. For example, if priority scanning is enabled and radio wide scanning is selected, priority scanning is automatically disabled and vice versa. More information on these types of scanning follows.

4.8.2 PRIORITY SCANNING

Priority scanning (also referred to as standard scan) monitors only channels that are the same type as that currently selected. For example, if a conventional channel is selected, only conventional channels are scanned and likewise for SMARTNET/SmartZone and Project 25 Trunked channels.

More information on how priority scanning operates in the Conventional Mode is located in Section 5.11, and for the other modes in Section 6.12. Priority scanning is turned on and off by the Scan option switch or menu parameter as follows. If this switch or menu parameter is not programmed, Priority scanning is not available.

- Enable scanning using the Scan option switch or menu parameter. Scanning is enabled when “Scan On” is briefly displayed and the  icon is indicated.
- To turn scanning off, press the Scan option switch again or select “Off” in the scan menu. Scanning is

disabled when “Scan Off” is briefly displayed and the  icon is no longer indicated.



- If the zone or channel is changed while scanning is selected, scanning continues on the same or a different scan list (see Section 4.9.1).

NOTE: Each SMARTNET/SmartZone and P25 trunked channel can be programmed so that scanning is automatically enabled when the channel is selected.

4.8.3 RADIO WIDE SCANNING

NOTE: Use radio wide scanning only if two different channel types need to be scanned at the same time such as conventional and SMARTNET/SmartZone. Otherwise, use the more efficient priority scanning because there is less chance of missed calls.

Radio wide scanning monitors the channels in the preprogrammed radio-wide scan list. This scan list can include up to 16 channels of any type and assigned to any zone (see Section 4.9.2). Radio wide scanning is turned on and off by the Radio Wide Scan option switch or menu parameter as follows. If this switch or menu parameter is not programmed, radio wide scanning is not available.

- Enable Radio Wide Scanning using the Radio Wide Scan option switch or menu parameter. Radio wide scanning is enabled when “RW Scn On” is briefly displayed and the  icon is indicated.
- To turn radio wide scanning off, press the Radio Wide Scan option switch again or select “Off” in the menu. Scanning is disabled when “RW Scn Off” is briefly displayed and the  icon is no longer indicated.
- If the zone or channel is changed while radio wide scanning, scanning continues normally.

4.8.4 SCAN HOLD TIME

When a message is received or transmitted while scanning, there is a delay before scanning resumes. The delay after receiving a call prevents another message from being received before a response can be made. The delay after transmitting a call ensures that a response is heard instead of another message occurring on some other channel.

Separate delay times are programmable for Radio Wide and Priority scanning. With radio wide and conventional priority scanning, delays of 0-7.5 seconds are programmable in 0.5-second steps. With SMARTNET/SmartZone and P25 Trunked priority scanning, a scan delay of 2-10 seconds can be programmed in 0.5-second steps.

4.8.5 TRANSMITTING IN THE SCAN MODE

Priority Scan Mode

When the transmitter is keyed while scanning is enabled, the transmission may occur on various channels as follows.

Conventional Operation - Transmissions can be programmed to always occur on the priority, selected, or receive channel (if applicable). Refer to Section 5.11 for more information.

SMARTNET/SmartZone/P25 Trunked Operation - If scanning is halted to receive a message, programming determines if transmissions occur on the selected or active channel. Transmissions at other times occur on the selected channel.

Radio Wide Scan Mode

The radio can be programmed to transmit on the selected or active channel similar to SMARTNET/SmartZone and P25 trunked operation just described.

4.8.6 NUISANCE CHANNEL ADD/DELETE

With priority scanning, channels can be temporarily deleted from the scan list, for example, if messages become annoying. This feature is not available with radio wide scanning. Channels can also be permanently added or deleted from a scan list as described in the next sections. Proceed as follows to temporarily delete a nuisance channel:

NOTE: The selected channel and also priority channels cannot be deleted from the scan list.

1. While receiving a message on the channel to be deleted, press and hold the Scan option switch until a tone sounds (about 1 second).

2. The channel is then deleted and scanning of the remaining channels in the scan list resumes.
3. Deleted channels are added back into the scan list if any of the following occur:
 - Scanning is turned off and then on again using the Scan option switch or menu parameter.
 - Radio power is turned off and then on again.
 - The selected channel is changed.

4.9 SCAN LISTS

4.9.1 PRIORITY SCAN LISTS

General

NOTE: The selected channel is always scanned.

A scan list is simply the channels that are scanned when scanning is enabled. With all operating modes, as many priority scan lists as are required can usually be programmed (up to 256). The only limitation is the available memory. Each scan list can include up to 512 channels/talk groups. More information on selecting and editing priority scan lists follows.

Determining Channels in Priority Scan List

The channels in conventional priority scan lists are indicated by selecting the scan mode as follows. Channels in SMARTNET/SmartZone/P25 Trunked priority scan lists are indicated only when editing a scan list (see “Editing a Priority Scan List” which follows).

1. Enable priority scanning using the Scan switch or menu parameter. Also select the scan list if applicable as described in the following “Selecting a Priority Scan List” description.
2. Select the desired zone and then scroll through the channels by rotating the channel switch. When the displayed channel is in the scan list (scanned normally), the  icon is displayed.

Selecting a Priority Scan List

NOTE: Only priority scan lists are selectable.

Conventional Channels - Conventional systems are programmed with a default scan list that is normally selected by all channels in that system. However, there is a programmable option to slave a particular conventional scan list to a zone. This then becomes the default list for all conventional channels in that zone (it overrides the system programming). This slave feature is programmed on the Edit Zone screen.

If the Scan (List) Select option switch or menu parameter is programmed, the default list selected by all conventional channels (even those belonging to slaved zones) is temporarily changed. The preceding default scan lists are automatically reselected whenever radio power is cycled.

SMARTNET/SmartZone and Project 25 Trunked Channels - Each channel (talk group) can be programmed so that one of the programmed lists is selected or scanning is disabled (No List). In addition, channels can be programmed so that scanning is automatically enabled (Auto Scan) when they are selected.

If the Scan (List) Select option switch or menu parameter is programmed, the list that is selected by all talk and announcement groups in the current system can be temporarily changed by the user as follows. “No List” (scanning disabled) or “Programmed” (default list) can also be selected if desired. The programmed default scan list is automatically reselected on power up.



To change the currently selected scan list (all channel types), proceed as follows:

1. With scanning disabled ( icon not displayed), press the Scan List option switch or select the Scan Selct menu parameter.
2. The currently selected list is displayed as “List x”, where “x” is the currently selected list. To exit without changing the selected list, simply press the Scan List option switch again or the F1 key.
3. To select another list, press the Up/Down switch. When the desired list is displayed, select it and exit

this mode by pressing the Scan List option switch again or the F1 or F2 key.

Editing a Priority Scan List

If the Scan Edit option switch or menu parameter is programmed, conventional, SMARTNET/SmartZone, and P25 Trunked priority (standard) scan lists can be user programmed. Changes are permanent (cycling power does not reselect a default condition). Proceed as follows:

1. Make sure that both priority and radio wide scanning are off ( icon not displayed). Select a conventional or SMARTNET/SmartZone/P25 Trunked channel corresponding to the scan list being programmed.
2. Select the scan edit mode using the Scan Edit option switch or menu parameter. This mode is indicated by  in the display.
3. If applicable, select the list to be edited by pressing the Up/Down switch. Select the desired list by pressing the F2 key. The selected list is indicated as “LIST x”. If user programming is disabled on a list, (conventional only) “NO EDIT” is momentarily displayed and it cannot be edited.
4. Select the channel you want to add or delete by pressing the Up/Down switch. After the last channel in the current zone is displayed, the first valid channel in the next zone is displayed and vice versa. Lists are limited to 512. If an attempt is made to add more than 512, “LIST FULL” is displayed and a channel must be deleted before another can be added.

NOTE: Priority channels can be deleted.

5. If the selected channel is in the scan list (scanned), the  icon is displayed. To change the status of the displayed channel, press the F2 (Enter) switch.

With conventional channels only, if the selected scan list is programmed with fixed priority channel(s), the next press of F2 makes the current channel the priority channel indicated by . If dual priority channels are used, pressing F2 again makes it the second priority channel indicated by

F2. Then pressing F2 again takes the channel out of the scan list. Refer to Sections 5.11.3 and 6.12.2 for more information on priority channel sampling.

6. To exit this mode and save the changes, press the F1 (Exit) key or the Scan Edit option switch again.

7.

4.9.2 RADIO WIDE SCAN LISTS

General

With radio wide scanning, there is only one scan list available regardless of the type of channel selected. This list is user programmable in later units, and can contain up to 16 channels of any type. For example, it could include six conventional channels and ten SMARTNET/SmartZone channels. More information on selecting and editing radio wide scan lists follows.

Determining Channels in Radio Wide Scan List

The channels in radio wide scan lists are determined by selecting the scan list edit mode (see “Editing Radio Wide Scan List” which follows).

When the displayed channel is in the radio wide scan list (scanned normally), the **(S)** icon is displayed.

Editing a Radio Wide Scan List

If the RWS Edit option switch or menu parameter is programmed, the radio wide scan list can be edited. Changes are permanent (cycling power does not reselect a default condition). Proceed as follows:

1. Make sure that both priority and radio wide scanning are off (**Z** icon not displayed). Select the scan edit mode using the RWS Edit option switch or menu parameter. This mode is indicated by  in the display.
2. Select the channel you want to add or delete by pressing the Up/Down switch. After the last channel in the current zone is displayed, the first valid channel in the next zone is displayed and vice versa. Lists are limited to 16 channels. If an attempt is made to add more than 16, “LIST FULL” is displayed and a channel must be deleted before another can be added.
3. If the selected channel is in the scan list (scanned), the **(S)** icon is displayed. To change the status of the displayed channel, press the F2 (Enter) switch.
4. To exit this mode and save the changes, press the F1 (Exit) key or the RWS Edit option switch again.

SECTION 5 CONVENTIONAL MODE FEATURES

5.1 INTRODUCTION

An overview of the conventional operating mode is located in Section 3.9.2. The following information describes the features unique to analog and digital (Project 25) conventional operation. Refer to the preceding “Radio Wide Features” section (4) for information on features common to all operating modes.

5.2 MONITORING BEFORE TRANSMITTING

With conventional operation, you may need to manually monitor the channel before transmitting to make sure that it is not be used by someone else. If you were to transmit while someone else was using the channel, you would probably disrupt their conversation. With SMARTNET/SmartZone and P25 Trunked operation, monitoring is performed automatically. Monitor conventional channels automatically or manually as follows:

Automatic Channel Monitoring

If the selected channel is programmed for Busy Channel Lockout (also called Transmit Disable On Busy), monitoring is performed automatically. Refer to Section 5.4 for more information on this feature.

Manual Channel Monitoring

The automatic monitoring just described may occasionally disable the transmitter when the channel is not in use, such as if the repeater has extended hang time. In this case, you may not want to use it and the channel must then be monitored manually as follows:

Busy Indicator - With scanning disabled, note if the multi-function indicator on the front panel is steady green. If it is not, the channel is not being used and a call can be transmitted. If it is green, a carrier is being detected, so the channel may be busy (see following).

Monitor Mode - There may be times when a busy condition is indicated even though no one is using the channel. Monitoring should then be performed by disabling Call Guard squelch (or group ID detect on Project 25 channels). This is usually done by selecting

the Monitor Mode (see following) or by the Normal/Selective option switch or menu parameter (see Section 5.5.5).

5.3 MONITOR MODE

The monitor mode unsquelches the receiver and monitors the channel even if a carrier is not detected. Other features of this mode are as follows:

- Call Guard (CTCSS/DCS) squelch is disabled on analog channels and NAC and group ID detect are disabled on P25 (conventional) channels.
- Busy Channel Lockout is overridden (see next section)
- Scanning temporarily halts

The Monitor Mode operates as follows:

1. To monitor the transmit frequency for activity before transmitting, briefly press the Monitor option switch or select the Monitor menu “Tx Channel” parameter. The  icon is then displayed to indicate the monitor mode and the receiver unsquelches.
2. To monitor the receive frequency instead, press and hold the Monitor option switch until a tone sounds or approximately 2 seconds, or select the Monitor menu “Sqlch Ovr” parameter. This can be used, for example, to improve reception if intermittent squelching is making a weak message difficult to understand.
3. To disable the monitor mode and return to normal operation, press the Monitor option switch again or select the Monitor menu “Off” parameter.

The Normal/Selective function disables Call Guard squelch and P25 group ID detect but not scanning and P25 NAC detect (see Section 5.5.5).

5.4 BUSY CHANNEL LOCKOUT

The Busy Channel Lockout feature (also called Transmit Disable on Busy) automatically disables the transmitter if the channel is busy when the PTT switch is pressed. When the transmitter is disabled by this

feature, “BUSY” is displayed, a busy tone sounds, and the transmitter is disabled.

The Busy Channel Lockout feature can be programmed to operate as follows. Each conventional channel can be programmed differently.

Off - Busy channel lockout is disabled and the transmitter keys even if the channel is busy.

Noise - If a carrier is detected on the channel, the transmitter is disabled when the PTT switch is pressed.

Tone (NAC) - If an incorrect Call Guard (CTCSS/DCS) or NAC code (see Section 5.17) is detected, the transmitter is disabled when the PTT switch is pressed. An incorrect code is any code other than the one programmed for the current channel.

If Busy Channel Override is permitted by programming, it is possible to transmit even when the transmitter is disabled by this feature. Simply release the PTT switch and then quickly press it again.

5.5 CALL GUARD SQUELCH

5.5.1 INTRODUCTION

Tone or digital Call Guard squelch (also called CTCSS/DCS signaling) can be programmed on each conventional analog transmit and receive channel in any order desired. The reverse burst and turn-off code are always transmitted and also detected on channels programmed with Call Guard squelch.

The Call Guard squelch feature eliminates distracting messages intended for others using the channel. This is done by using a subaudible tone or digital code to control the squelch. This tone or code is unique to a user or a group on that channel. This tone or code is transmitted with the voice signal but is not heard because it is in the subaudible range and is attenuated by a filter. Call Guard squelch must be used in both the transmitting and receiving radio to be functional.

5.5.2 CALL GUARD SQUELCH ENABLE/DISABLE

The Normal/Selective option switch or menu parameter (if programmed) can be used to disable

receive Call Guard squelch on analog channels or group ID code detection on P25 channels. When selective squelch is disabled, “Sq Normal” is flashed in the display, and when it is enabled, “Sq Select” is flashed.

When “Normal” is selected, the receiver un-squelches only if a carrier is detected. Scanning and Project 25 NAC detection are not disabled with this mode selected. The selected mode is in effect until it is manually changed again. Selecting another channel or cycling power does not reselect a default condition. There is a programmable option to display the monitor  icon when the “Normal” mode is selected.

5.5.3 TONE CALL GUARD SQUELCH

Tone-type Call Guard squelch utilizes subaudible CTCSS tones from 67-254.1 Hz. Although there are 42 tones assigned, those above 33 (210.7 Hz) are normally not used because of their close proximity to the voice band which starts at 300 Hz. In addition, tones 11 (97.4 Hz), 39 (69.3 Hz), 40 (206.5 Hz), 41 (229.1 Hz), and 42 (254.1 Hz) are normally not used because they may cause interference with adjacent tones.

A reverse burst is transmitted when the push-to-talk switch is released and also detected when calls are received. It is a 180-degree phase reversal for a period of time determined by the tone frequency, and it eliminates the squelch tail (noise burst) in the receiving radio. Both the transmitting and receiving radio must be equipped with this feature for it to be utilized.

5.5.4 DIGITAL CALL GUARD SQUELCH

Digital Call Guard squelch (DCS) uses digital data instead of subaudible tones to control the squelch. This data consists of continuous repetitions of 23-bit words. No bit or word synchronization information is used. When the push-to-talk switch is released, a turn-off code is transmitted which eliminates the squelch tail similar to the reverse burst.

Although there are thousands of possible code combinations with 23 bits, only 83 are unique with the data scheme used. The number specified when the code is programmed is actually a seed for a special algorithm used to generate the 23-bit data word. The data is transmitted at a rate of 134.4 bits per second. Therefore, approximately six words are transmitted each second. When the data is decoded, 23-bit samples

are taken and then the bits are rotated to determine if a valid code was received.

5.5.5 SELECTIVE SQUELCH CODE SELECT (CTCSS/DCS/NAC)

NOTE: Call Guard codes can be permanently reprogrammed by keypad programming described in Section 5.18.

This feature allows the normal transmit and receive Call Guard (CTCSS/DCS/NAC) programming to be temporarily overridden with a code selected from a preprogrammed list. It is available if the Squelch Select List option switch or menu parameter and a CTCSS/NAC code list have been programmed.

In addition, conventional systems can be programmed for the Keypad CTCSS/DSC feature. Codes can then be selected directly from the table by pressing the key for the code. For example, to select code 3 from the table, simply press the “3” key. No other conventional mode functions can then be assigned to these keys.

The CTCSS/DCS/NAC list is programmed with up to 64 tone (CTCSS) or digital (DCS) Call Guard codes. Different codes can be programmed for the transmit and receive modes, and carrier squelch (selective squelch disabled) can be programmed if desired. In addition, each position can be programmed with an NAC code for use with P25 operation.

When the Call Guard code is changed using this feature, it remains selected even if other channels are selected. However, if radio power is cycled or a talk-around channel is selected, the normal codes are reselected. When scanning, the selected code also applies to all scanned channels. Each channel can also be programmed to always ignore the code selected from this list and use the default code instead.

If both analog and digital (Project 25) channels can be selected or scanned, the CTCSS/DCS code for the selected position is used for analog channels and the NAC code for the selected position is used for P25 channels. If a channel is programmed for mixed mode operation, the selective squelch type (analog or digital)

programmed for the transmit mode determines the selective squelch type used.

Proceed as follows to select a code using the Squelch Select List option button or menu parameter:

1. Press the Squelch Select List option switch or select the Sqlch Code menu mode parameter. Then press the Up/Down switch to select the desired code. The display indicates “SEL SQ xx” where, “xx” is the selected code from 1-64. The code number and actual code are alternately displayed (NACs are displayed in hexadecimal).
2. To select the displayed code and return to the normal display, press the F2 (Select) key or the Squelch Select List switch again.
3. To check which code is selected, press the Squelch Select List switch once to display the current selection and then again to return to normal operation.
4. To return to the normal selective squelch codes, select “DEFAULT” in this mode. As previously described, the normal codes are also automatically reselected whenever radio power is cycled or a talk-around channel is selected.

5.6 PENALTY TIMER

A penalty timer may be programmed on conventional systems to prevent transmissions for the programmed time after the time-out timer disables the transmitter (see Section 4.3). The penalty timer can be programmed for the same times as the time-out timer, and timing starts when the PTT switch is released. If the PTT switch is pressed during the penalty time, the time-out indication occurs again and the transmitter remains disabled. When the penalty timer expires, a beep sounds and the transmitter can be keyed.

5.7 CONVERSATION TIMER

A conversation timer can be programmed on conventional systems in addition to the time-out timer (see Section 4.3). This timer limits the total length of a conversation rather than just the length of each transmission as with the time-out timer. The following is more information on this timer.

- It can be programmed for times up to 7.5 minutes.
- It is reset when the time between transmissions exceeds the time programmed for the penalty timer.
- A warning beep sounds 5 seconds before this timer disables the transmitter.
- When this timer disables the transmitter, a continuous tone sounds and the red transmit indicator turns off. The PTT switch must then be released until the penalty timer expires (indicated by a beep).

5.8 REPEATER TALK-AROUND

Normally, all transmissions go through a repeater which usually increases range. However, there may be times when a user is out of range of the repeater and therefore unable to talk to anyone even though the user being called is only a short distance away. To allow communication in this situation, repeater talk-around can be selected. Transmissions then occur on the receive frequency which permits direct radio-to-radio communication.

Repeater talk-around can be selected if the RTA option switch or menu parameter is programmed. When talk-around is enabled by this switch, **T_A** is displayed. This feature remains enabled during scanning, and changing channels or turning power off does not change the selected condition. Talk-around is available on conventional channels only, and power output is reduced in this mode.

5.9 DISPLAYING TRANSMIT/RECEIVE FREQUENCY

If the Displayed Information option switch or menu parameter is programmed (see Section 4.1), it can be used to display the channel frequency in megahertz. Pressing this switch toggles between displaying the standard channel alias and the channel frequency. The receive frequency is displayed when receiving and the transmit frequency is displayed when transmitting. This feature is available on conventional channels only.

5.10 EMERGENCY ALARM AND CALL

5.10.1 INTRODUCTION

Emergency Alarms and Calls are separate functions that can be individually enabled or disabled on each analog and P25 conventional system. The Emer-

gency option switch or menu parameter is required for these functions. Emergency Alarms and Calls are transmitted on the global (radio wide) emergency zone/channel if one is programmed. If it is not programmed, the emergency is transmitted on the selected channel. The emergency programming of the system to which that channel is linked controls the emergency operation.

5.10.2 EMERGENCY ALARMS

An emergency alarm is a special transmission that alerts a dispatcher of an emergency situation. It is sent automatically by simply pressing the Emergency option switch or selecting the Emergency menu parameter. The system to which the emergency channel is linked must have Emergency Alarms enabled. If it does not, Emergency Alarms are disabled.

In the P25 conventional mode, a special P25 emergency data transmission is sent, and in the conventional analog mode, an DTMF emergency ID is sent. This ID is programmed on the Conventional Radio Wide screen. Refer to Section 5.15 for information on MDC1200 Emergency Alert.

Proceed as follows to send an emergency alarm:

1. If required, select a channel of a system on which Emergency Alarms are enabled and then press the Emergency option switch or select that menu parameter. The radio then automatically transmits the emergency alarm.
2. Either Normal or Silent operation can be programmed. With Normal operation, the red LED lights, the emergency tone sounds, and “EMERGENCY” flashes in the display. This indication continues to flash until the alarm mode is ended (see step 4). If silent operation is programmed or the Surveillance mode is selected (see Section 4.7), none of these indications occur. If “No Receive Activity During Emergency” is programmed, receive audio, the front panel LED, and receive icons are disabled in the receive mode.
3. When the emergency alarm is acknowledged by the dispatcher, “ACK RCVD” is briefly displayed and the emergency acknowledge tone (two beeps)

sounds. This alert tone can be disabled if desired, and neither occur if Silent operation is programmed.

4. The emergency alarm mode is exited when radio power is cycled or by pressing and holding the Emergency option switch.

5.10.3 EMERGENCY CALLS

General

The Emergency Call feature allows a user to place an emergency voice call by pressing the PTT switch after pressing the Emergency option button or selecting the Emergency menu parameter. If the Emergency Hot Mic feature is enabled, the emergency call is automatically transmitted without having to press the PTT switch (see following description). The system to which the emergency channel is linked must have Emergency Calls enabled. Analog and Digital (P25) calls can be individually enabled.

If the emergency call is sent on a P25 channel, an emergency indication is sent according to the P25 standard (the emergency bit is set in the Common Air Interface). If it is sent on an analog channel, the DTMF Emergency ID is sent in place of the ANI DTMF PTT ID if applicable. *NOTE: The DTMF Emergency ID is sent only if pre- or post- DTMF ANI is enabled on the channel by programming.*

Emergency Hot Mic

If Emergency Hot Mic has been enabled for emergency calls, automatic transmitting occurs with microphone audio unmuted without having to manually press the PTT switch. The automatic transmit period is programmed for 10-120 seconds in 10-second steps. If this feature or emergency calls are not enabled by programming, automatic transmitting does not occur. This feature is initiated only on the first press of the Emergency switch. Subsequent presses do not trigger automatic transmissions. To reset this function, the channel must be changed or power cycled.

Placing an Emergency Call

1. If required, select a channel of a system on which Emergency Calls are enabled and press the Emergency option switch or select that menu parameter.

The Emergency Alarm is then sent as described in Section 5.10.2 if applicable.

2. If the preceding Emergency Hot Mic feature is enabled, the call is automatically transmitted without pressing the PTT switch. If it is disabled, press the PTT switch and begin speaking as with a standard call. If the channel is changed, operation continues on the new channel in the emergency mode.
3. With analog calls, subsequent presses of the PTT switch cause the DTMF emergency ID to be sent according to the ANI programming (if DTMF ANI is enabled on the channel). With digital calls, the calls continue to have the emergency bit set.
4. If the Surveillance Mode is enabled (see Section 4.7), all indicators, lights, and tones are disabled. If “No Receive Activity During Emergency” is programmed, receive audio, the front panel LED, and receive icons are disabled in the receive mode.
5. To exit this mode, cycle radio power or press and hold the Emergency switch.

5.10.4 EMERGENCY MAN-DOWN FEATURE

To have this feature, a special man-down switch (currently available only from third-party vendors) is attached to the accessory connector of the radio. Then if this feature is enabled by programming and the radio is in a horizontal position for longer than the programmed time (0-63 seconds), an emergency condition is triggered the same as if the Emergency switch was pressed. The emergency can be canceled by a press and release of the Emergency switch. Note that accessories such as speaker-microphones cannot be used with this feature.

5.11 CONVENTIONAL MODE SCANNING

5.11.1 GENERAL

Channel scanning features common to all operating modes are described in Sections 4.8 and 4.9. The following information describes features unique to conventional operation.

5.11.2 TRANSMITTING IN SCAN MODE

Each conventional scan list can be programmed for one of the following modes. These modes determine if priority sampling occurs and also the channel on which transmissions occur while scanning. Refer to the next section for more information on priority sampling.

No Priority - No priority channel sampling occurs when the list is selected. The radio transmits on the selected channel.

Priority/Tx Selected - Priority sampling occurs and the priority channel or channels are those programmed in the selected scan list. The radio transmits on the selected channel.

Priority/Tx Priority (1) - Priority sampling occurs and the priority channel or channels are those programmed in the selected scan list. The radio transmits on the priority (1) channel.

Priority (1) on Selected - The priority (1) channel is always the selected channel. The radio transmits on the selected channel.

Talkback - No priority sampling occurs. The radio transmits on the channel of a call while scanning is halted. Then once scanning resumes, it transmits on the selected channel.

5.11.3 PRIORITY CHANNEL SAMPLING

NOTE: The following describes priority sampling when scanning conventional channels. Priority sampling when scanning SMARTNET/SmartZone/P25 Trunked channels is described in Section 6.12.

General

The priority channel sampling feature ensures that when priority scanning, messages on the priority channel are not missed while listening to a message on some other channel. The radio can be programmed as just described so that the priority channel is a fixed channel programmed in the current scan list, the currently selected channel, or not used.

NOTE: The priority channel is not scanned if the active channel is an analog channel on the same

frequency as the priority channel and is programmed with CTCSS/DCS squelch control.

Either a single or dual priority channels can be programmed if desired. With dual priority, a call on the second priority channel is interrupted by a call on the first priority channel but not vice versa. When scanning and the selected channel is a single or first priority channel, **F** is indicated in the display. This indication is displayed regardless of whether the priority channel is fixed or always the selected channel. When it is a second priority channel, **F₂** is displayed.

The priority channel sampling frequency is determined by the programmed Priority Lookback Time A (see description which follows). For example, if 2.0 seconds is programmed, the priority channel is sampled every 2.0 seconds when listening to a message on a non-priority channel. When not listening to a message, the priority channels are scanned in the normal scan sequence. With dual priority, the first and second priority channels are alternately sampled at the Lookback Time.

Priority channel sampling occurs only with conventional priority scanning. It does not occur with radio wide scanning, when listening to any type of SMARTNET/SmartZone/P25 trunked call, encrypted call, or when transmitting (see preceding note). A series of “ticks” may be heard when the priority channel is sampled while listening to a message on some other conventional channel.

The priority sampling times are programmed by the following parameters:

Lookback Time A - This time determines how often the priority channel is checked for activity. Times of 0.25-4.00 seconds in 0.25-second steps can be programmed.

Lookback Time B - This time determines how often the priority channel is checked once an incorrect Call Guard (CTCSS/DCS) or NAC code is detected. Since it takes much longer to detect an incorrect Call Guard signal than a carrier, this time should be relatively long to prevent the interruptions from making a message difficult to understand. Times of 0.5-8.0 seconds can be programmed in 0.5-second steps.

Changing the Priority Channel

If a fixed priority channel is associated with the current scan list, it can be changed if the Priority option switch or menu parameter is programmed. With dual priority, this function changes only the first priority channel. To change both priority channels, use the Scan List Edit function described in Section 4.9.1.

Proceed as follows to change the priority channel using the Priority option switch/menu parameter:

1. Make sure scanning is disabled (**Z** icon not displayed) and the desired scan list is selected (see Section 4.9).
2. Select the channel you want to be the priority channel and then press the Priority option switch or select that menu parameter. "Priority" is then flashed to indicate that the current channel is now the priority channel when scanning that list. Other indications that may occur are as follows:
 - If "No Priority" is displayed, priority sampling may not be enabled on the scan list.
 - If "Sel Chan" is displayed, the priority channel is always the selected channel and cannot be changed.
 - If no indication displayed, the scan list may not be user editable or the channel may not be in the scan list.

5.12 STANDARD CONVENTIONAL CALLS

Standard conventional calls are placed to other radio units monitoring the selected channel. The proper coded Call Guard squelch tone or code or P25 NAC may need to be transmitted by your radio for them to receive a call (see Sections 5.5 and 5.17.3).

Placing a Standard Conventional Call

1. Turn power on and set the volume as described in Section 3.1. Select the channel programmed for the radio you want to call as described in Section 3.3.
2. Monitor the channel automatically or manually as described in Section 5.2.

3. Press the PTT switch and if the Busy Channel Lockout feature is programmed on the channel (see Section 5.4), the transmitter is automatically disabled if the channel is busy. Otherwise, busy and out-of-range conditions are not indicated.
4. Press (and hold) the PTT switch to talk and release it to listen.

Receiving a Standard Conventional Call

1. Select or scan the channel programmed for the call you want to receive (refer to Sections 4.8 and 4.9 for more scanning information).
2. When the call is received, press the PTT switch to talk and release it to listen. If scanning, responses may occur on the priority, selected, or receive channel as described in Section 5.11.2.

5.13 DTMF/ANI SIGNALING

DTMF (Dual Tone Multi-Frequency) tones can be generated for ANI (Automatic Number Identification) and other purposes on conventional analog channels. One of the following options may be enabled on each channel:

Pre-Tx ANI - A preprogrammed ANI sequence is automatically sent each time the PTT switch is pressed.

Post-Tx ANI - A preprogrammed ANI sequence is automatically sent each time the PTT switch is released.

When an emergency alarm or call is placed, this ANI signaling is replaced by the Emergency DTMF ID (see Section 5.10). Refer to Section 5.15 for information on MDC1200 ANI.

5.14 SINGLE TONE ENCODER

This feature allows the user to transmit a single tone by pressing the Single Tone Encoder option switch or selecting that menu parameter. Each conventional system can be programmed for a tone of 500-2500 Hz in 1 Hz steps with a duration of 0.5-2.5 seconds in 0.1 second steps.

5.15 MDC1200 COMPATIBILITY

MDC1200 is a signaling protocol designed and implemented by Motorola for analog channels only. The following features of this protocol are supported. Either MDC1200 or standard DTMF ANI/Emergency signaling can be programmed on each conventional system.

MDC1200 ANI - Both pre and post ANI are supported.

MDC1200 Emergency Alert - A retry counter is implemented. Currently, ACKs are not decoded so the radio retries the programmed number of times with each emergency.

5.16 CLONE MODE

5.16.1 GENERAL

The Clone feature enables one radio to program another with identical information. The PCConfigure programming software is not required. This feature is not available with 53xx mobiles. Other requirements are as follows:

- The Clone menu parameter must be enabled in the master (sending) radio. This parameter is not required with the slave (receiving) radio.
- The master and slave radios must be identical models (same frequency range and options).

Only zones with conventional analog and P25 channels can be transferred using this function. Any SMARTNET/SmartZone and P25 trunked information is not transferred. In addition, the P25 Unit ID, encryption keys, and the RSI ID and other OTAR information are not transferred. Cloned zones are indicated in the slave radio by an asterisk in the first character position of the zone alias (the first character is replaced by this asterisk).

5.16.2 WIRELESS CLONING

A new wireless cloning feature is available that allows one radio to program another using an RF link instead of having to be physically connected by a cloning cable. This feature is available on P25 conventional channels only.

The wireless cloning feature utilizes the P25 data functionality of the radio. Therefore, a conventional P25 channel must be programmed in both radios and the slave radio must have been programmed with a P25 Unit ID. In addition, Data Registration must be enabled in both radios. If it is not programmed, “Disabled” is displayed. Radios with wireless cloning capability have a new selection in the cloning menu to select either Clone N (Normal) or Clone W (Wireless). If Wireless is selected, an additional menu is displayed for entering the P25 Unit ID of the destination radio (slave). The Zone/Complete mode is then selected.

5.16.3 CLONING PROCEDURE

1. With normal (non-wireless) cloning, connect the master (sending) radio to the slave (receiving) radio using Cloning Cable, Part No. 023-5100-930.
2. On the master radio, select the Clone menu parameter and press the F2 key. If applicable, select either “Clone W” (Wireless) or “Clone N” (Normal). If normal cloning was selected or if this is not selectable, proceed to step 4.
3. With wireless cloning, a screen is then displayed for entering the P25 Unit ID of the destination (slave) radio. Enter this ID using the keypad (or the Up/Down keys) and F2.
4. The clone mode “Zone” or “Complete” is then selected. Select the desired mode. Operation is as follows:

Zone - This mode allows channel information for only the selected zone to be transferred. Information programmed on the Global, Radio Wide, and By System screens is not changed. A list of the current conventional zones is displayed. Select the desired zone by highlighting it and pressing the F2 key. A selected zone is indicated by an asterisk (*). Scroll to “OK” and press F2 to begin the data transfer. The selected zone in the slave radio is overwritten. Previously, multiple zones could be selected and they were appended to those in the slave radio.

Complete - This mode transfers all conventional programming information. This includes information on the Global, Radio Wide, and By System screens. Simply highlight “Complete” and press the

F2 key to begin the data transfer. This mode overwrites all this information currently in the slave radio. None of the previous information is retained except for the IDs as described in Section 5.16.1.

5.17 PROJECT 25 MODE FEATURES

NOTE: The following features are unique to conventional P25 channels.

5.17.1 UNIT ID CODE

Each radio that operates on Project 25 (digital) channels is programmed with an eight-digit unit ID. This ID is unique for each radio and can be any number from 1-16,777,216. When power is turned on with a Project 25 channel selected, this ID is briefly displayed.

5.17.2 GROUP ID CODE

Each Project 25 channel is programmed with a group ID that determines which group of radios will receive the call. A call is received on a channel if a selected or scanned channel is programmed with that ID and the correct NAC is detected (see following). Group IDs can be any number from 0-65,535. Group ID detect can be disabled by the Normal/Selective squelch function described in Section 5.5.2 or the monitor mode described in Section 5.3

5.17.3 NETWORK ACCESS CODE

Project 25 conventional channels also use a NAC (Network Access Code) to control which calls are received on a channel. The NAC can be 0-4095, and each transmit and receive channel can be programmed for a different code. Other operation, such as monitoring before transmitting, is similar to that of analog channels. NAC (and group ID) detect can be disabled by the monitor mode described in Section 5.3.

5.17.4 P25 GROUP CALLS

P25 group calls are placed by simply selecting the channel programmed for the desired group, monitoring the channel if required, and transmitting.

When a P25 group call is received, the alias (or frequency) of the selected channel is displayed. The radio can be programmed so that the following are

also displayed for 0.5-7.0 seconds or continuously during the call.

P25 PTT ID- The unit ID of the radio placing the call is displayed.

P25 Talk Group - The alias of the talk group on which the call is being received is displayed.

User Group ID - If the group ID of the call being received is included in a preprogrammed User Group ID list, the alias programmed in that list for that group is displayed.

Changing a Channel Talk Group

If the Digital Talk Group Select option switch or Select TG menu parameter is programmed, the talk group assigned to a channel can be changed by the user. The new talk group continues to be assigned to the channel until it is manually changed again (cycling radio power or selecting another channel does not reselect a default talk group). Change the talk group assigned to a channel as follows:

1. Select the channel to be changed.
2. To select the talk group from the list of programmed talk groups, briefly press the Talk Group Select option switch or select the **Select TG > ID List** menu parameter. Then press the Up/Down switch until the alias of the desired talk group is displayed. If talk group selection has been disabled on the channel by programming, "NO LIST" is displayed, a tone sounds, and no change occurs. Press the F2 switch to select the talk group and return to normal operation.
3. To enter a new talk group number from 1-65,535, press and hold the Talk Group Select option switch or select the **Select TG > Enter ID** menu parameter. Enter the desired talk group directly using the keypad. If less than five digits are entered, press the F2 switch to select the talk group and return to normal operation.

5.17.5 P25 UNIT CALLS

Unit Calls (also called Individual Calls) can be placed to a specific radio on a Project 25 channel if the Unit Call option switch or menu parameter is

programmed. Only the individual ID of the target radio is sent (a talk group ID is not sent). The radios that can be called are preprogrammed in the Unit Call list.

To receive a Unit Call, the RF channel of the call must be selected or scanned and the correct NAC and unit ID must be detected. The ID of the calling radio is then transmitted back. To respond to the call, the radio must be programmed with the Unit ID option switch or menu parameter, and have a Unit Call programmed for the ID of the calling radio.

Place and receive a Unit Call as follows:

1. To transmit a Unit Call, press the Unit Call option switch or select the Unit Call menu parameter. The alias (tag) of the last Unit Call is displayed.
2. If required, press the Up/Down switch to display the desired call. The alias and ID of the calls that have been programmed are alternately displayed.
3. Press and then release the PTT switch. Ringing is then heard and "WAIT" displayed to indicate that the radio is being rung. To disable this ringing but not the call, briefly press the PTT switch again. Ringing occurs for 20 seconds or until the call is answered, whichever occurs first.
4. When a Unit Call is received, two beeps sound (if tones are enabled), and "Call Rcvd" and the alias of the unit ID are alternately flashed.
5. To respond, select the Unit Call mode by pressing the Unit Call option switch or selecting the menu parameter. The following operation then occurs:
 - If a unit call has been programmed with the ID of the calling radio, it is automatically selected. A response can then be made without changing the selected channel.
 - If no Unit Call has been programmed with the ID of the calling radio, a response cannot be made in this mode.
 - If the call timer times out (set by programming) or the channel is changed before a response is made, the unit call mode is exited.

5.17.6 P25 CONVENTIONAL TELEPHONE CALLS

General

Telephone calls can be placed and received on P25 conventional channels. This feature allows telephone calls to be placed and received over the public telephone system using your radio. Telephone calls are programmed to operate in one of the following modes:

- Disabled
- Answer-only capability
- List only - Telephone numbers can be selected from a preprogrammed list only (direct entry using the keypad is not allowed)
- Unlimited - Telephone numbers can be selected from a list and also dialed directly entered using the keypad.

Both limited and DTMF keypad models can place telephone calls by recalling the telephone number from a preprogrammed list as just described. However, only DTMF keypad models can directly dial telephone numbers using the keypad.

Access/De-Access Codes

P25 conventional telephone calls utilize an access to access the system when placing a telephone call, and a de-access code to terminate the call when it is finished. These codes are preprogrammed in pairs by the Access/De-Access Code list selected on the conventional Per System screen, and up to 16 pair can be programmed. Each conventional P25 channel can be programmed to automatically select one of these code pairs. They must match the system codes, and the default code is *1P(pause)#.

Placing a Telephone Call

Recalling From List

1. Select the conventional channel that is programmed to select the desired access and de-access codes.
2. Momentarily press the Phone option key or select the **Phone > Num List** menu parameter. The display indicates the last number dialed by alternately displaying "Last Num" and the telephone number.

In addition, the phone mode is indicated by the  icon.

3. If required, press the Up/Down switch to display the desired number. The alias and telephone number are alternately displayed.
4. Briefly press the PTT switch to send the access code. A dial tone sound should then be heard. Briefly press the PTT switch again to send the digits. Proceed to step 5.

Direct Entry Using DTMF Keypad

1. Select the conventional channel that is programmed to select the desired access and de-access codes.
2. Press and hold the Phone option key until a tone sounds (approximately 1 second) or select the **Phone > Enter Num** menu parameter. The alias of the last called telephone number is displayed if it is in the phone number list. Otherwise, only the last eight digits are displayed. In addition, the phone mode is indicated by the  icon.
3. Enter the telephone number using the 0-9, *, and # keys. To enter a pause (indicated by “P”), press *#. The number scrolls to the left in the display so that the eight right-most digits are always displayed. Numbers up to sixteen digits (including pauses) can be entered.
4. Briefly press the PTT switch to send the access code. A dial tone sound then be heard. Briefly press the PTT switch again to send the digits.
5. Press the PTT switch to talk and release it to listen. Since the radio operates half duplex, it is not possible to talk and listen at the same time.
6. When the telephone call is finished or if it could not be completed for some reason, end it by pressing the Phone option key or F1 key. This sends the de-access code which tells the system that the call is finished and that the repeater can be released.

Answering a Telephone Call

1. When a telephone call is received, “ringing” similar to a standard telephone is heard and “PHONE” is displayed.

2. To answer the call, press the Phone option switch or select that menu parameter and press the PTT switch to talk and release it to listen.
3. When the call is finished, end it as in the preceding step 6.

5.17.7 CALL ALERT

General

The Call Alert™ feature allows pages to be sent and received on P25 conventional channels. Operation is similar to SMARTNET/SmartZone and P25 Trunked channels.

Answering a Page

1. When a page is received, five beeps sound and “PAGE” is displayed. The ID of the radio paging you is stored as the last ID received.
2. To clear or ignore the page, press any option switch. If the PTT switch is pressed, a group call is placed on the selected channel.
3. To answer the page as a unit call (see Section 5.17.5), press the Unit Call option switch or select that menu parameter and the alias of the radio paging you is displayed. Press the PTT switch and respond. One of the following conditions then occur:
 - If the radio being called is on the air, ringing is heard until the called party answers or for 20 seconds, whichever occurs first. If no answer occurs within 20 seconds, a continuous tone sounds and “NO ANS” is displayed.
 - If the radio being called is not on the air, a continuous tone is heard instead of ringing and “NO ACK” is displayed.
4. When the call is finished or if it could not be completed for some reason, end it by pressing the Unit Call option switch or the F1 (Exit) key.

Initiating a Page

1. With a P25 conventional channel selected, momentarily press the Call Alert option switch or select that

menu parameter. The alias of the last ID called is displayed.

2. If required, press the Up/Down switch to display the desired radio. The alias of each number is displayed.
3. Press the PTT switch or the F2 key and one of the following occur:
 - If five beeps sound, the system received the page and the paged radio is on the air and received it. The page mode is automatically exited.
 - If the system received the page but the called radio is not on the air, a single beep sounds and “NO ACK” is displayed 6 seconds after the PTT switch is pressed. Auto exit then occurs.

5.17.8 MESSAGING

The messaging feature allows preprogrammed messages to be sent to a dispatcher on P25 channels. Up to 16 messages can be preprogrammed, and they are identified by an alias. If a Message option switch or menu parameter is programmed, messages are sent as follows:

1. Momentarily press the Message option switch or select that menu parameter. The alias of the last message sent is displayed.
2. If required, press the Up/Down switch to display the desired message. Then send the message by pressing the F2 key or momentarily pressing the PTT switch. One of the following events then occurs:
 - If five beeps sound and “ACK RECVD” is displayed, the message was received and automatically acknowledged by the system.
 - If after five tries the message is not acknowledged, a tone sounds and “NO ACK” is displayed.

5.17.9 STATUS MESSAGING

The status messaging feature allows you to manually or automatically send your current status to your dispatcher on P25 channels. Up to eight status condi-

tions can be preprogrammed, and they are identified by an alias. If the Status option switch or menu parameter is programmed, status conditions are sent as follows:

1. Momentarily press the Status option switch or select that menu parameter. The alias of the current status condition is displayed.
2. To change the current status, press the Up/Down switch until the desired status is displayed. Then to send the status, press the F2 (Select) switch or momentarily press the PTT switch. One of the following events then occurs:
 - If five beeps sound and “ACK RCVD” is displayed, the status was received and acknowledged by the system.
 - If after five tries the message is not acknowledged, a tone sounds and “NO ACK” is displayed.

5.17.10 P25 PACKET DATA

P25 packet data transmission capability is available with 4100 portables. A P25 Packet Data option button or menu parameter must be programmed to toggle the data mode on and off.

The P25 Packet Data mode allows a subscriber unit to act as a packet data modem for a remote application connected to the subscriber unit via an RS-232 or SLIP (Serial Line Internet Protocol) connection. The SLIP connection requires an Ethernet port which is currently not available. The standard PCConfigure programming cable provides the RS-232 port (female DB9 connector) for connecting the external data equipment to a 4100 portable.

5.18 KEYPAD PROGRAMMING

NOTE: The Keypad programming feature is available to Federal Government users only. Users regulated by the Federal Communications Commission are not allowed to have this feature.

5.18.1 INTRODUCTION

Keypad programming can be enabled only if it has been enabled at the factory and a conventional mode option switch or menu parameter is programmed

for the “Keypad Programming” function. The keypad programming mode is indicated by “CHNG ZONE” and  in the display.

Keypad programming allows conventional channel parameters such as the transmit and receive frequency, Call Guard squelch code, and encryption key to be changed. In addition, several conventional mode timers can be changed. It cannot be used to reprogram disabled channels or any SMARTNET/ SmartZone/P25 Trunked information.

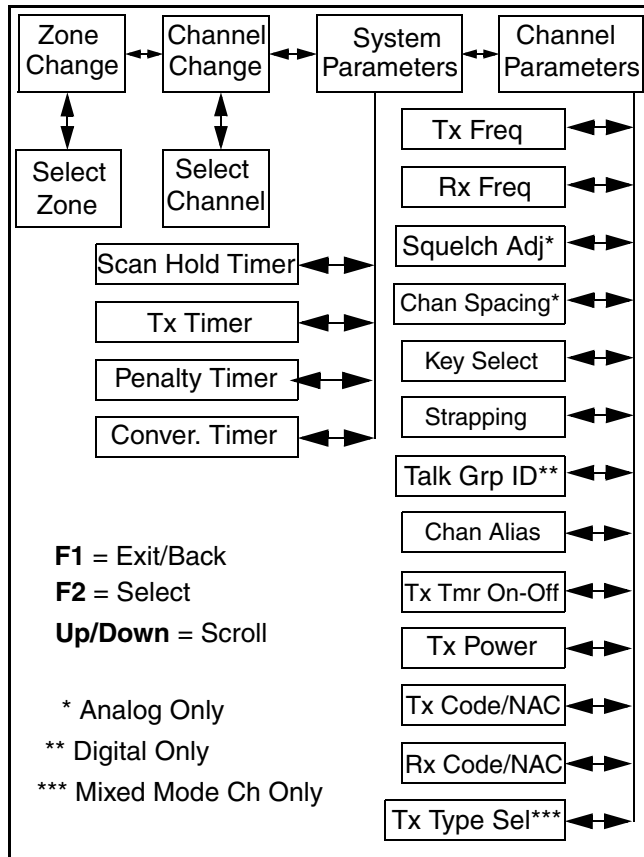

Figure 5-1 Keypad Programming Menu Flowchart

5.18.2 MENU DESCRIPTION

A menu system is used to select parameters in the keypad programming mode. A flowchart showing the keypad programming mode menu structure is located in Figure 5-1. When the keypad programming mode is selected by the Keypad Programming option switch or menu parameter, the first menu parameter “CHNG ZONE” is displayed as just described. Press the Up/

Down switch to scroll through the available parameters which are as follows.

- **CHNG ZONE**
- **CHNG CHAN**
- **SYS PARMS**
- **CHAN PARMS**

Press the F2 (Select) key to select a highlighted parameter, and press the F1 key from one of the main menus to exit keypad programming. Pressing it in the other menus returns to the previous menu. The Up/Down switch is also used in several menus to scroll through available selections. Additional information on this parameters is located in the following sections.

5.18.3 ZONE PASSWORD

NOTE: Make sure that the zone password(s) are not lost because they cannot be overridden in the field. The PCConfigure software must be used to display the lost password or program a new password.

Each zone can be programmed with a password by the PCConfigure software to prevent unauthorized reprogramming of zone by keypad programming. When this password is programmed, it must be entered before system or channel parameters in that zone can be changed by keypad programming. The zone password is programmed in the Zones > Edit Zone screen of the PCConfigure programmer. This screen is displayed by clicking the Edit Zone button. A different password can be programmed for each zone.

When an attempt is made to select a system or channel parameter in a password protected zone, “PASSWORD” is flashed. The password is always eight digits long and is entered using the same procedure as used for the power-up password described in Section 3.2. After the password is entered, system and channel parameters for that zone can be reprogrammed normally.

5.18.4 ZONE CHANGE PARAMETER

The “CHNG ZONE” menu parameter selects the zone containing the conventional channel to be reprogrammed. It does not change the zone selected for normal operation.

Press the F2 switch to select the “ZONE CHG” parameter and then scroll through the programmed zones by pressing the Up/Down switch. When the desired zone is displayed, select it by pressing the F2 switch.

5.18.5 CHANNEL CHANGE PARAMETER

The “CHNG CHAN” menu parameter selects the conventional channel to be reprogrammed. Disabled or SMARTNET/SmartZone/P25 Trunked channels cannot be selected. This does not change the channel selected for normal operation.

Press the Select switch to select the “CHNG CHAN” parameter and then scroll through the programmed channels by pressing the Up/Down switch. When the desired channel is displayed, select it by pressing F2 switch.

5.18.6 SYSTEM PARAMETERS

NOTE: If “PASSWORD” is briefly displayed when attempting to select a parameter, see Section 5.18.3.

The “SYS PARMS” menu parameter selects the conventional mode timers to be reprogrammed (see following). Press the F2 switch to select the “SYS PARMS” parameter and then press the Up/Down switch to display the desired parameter. Then press the F2 switch again to select it.

SCAN TIMER - Selects the Scan Hold timer. Press the Up/Down switch to increment/decrement the timer in 0.5-second steps from 0-7.5 or set it to 0 seconds to disable it. When the desired value is displayed, store it by pressing the F2 switch.

TX TIMER - Selects the transmit time-out timer. Press the Up/Down switch to increment/decrement the timer in 15-second steps from 0-225 or disable it by selecting 0 seconds. When the desired value is displayed, store it by pressing the F2 switch.

PEN TIMER - Selects the penalty timer. Press the Up/Down switch to increment/decrement the timer in 15-second steps from 0-225 or disable it by selecting 0 seconds. When the desired value is displayed, store it by pressing the F2 switch.

CONV TIMER - Selects the conversation timer. Press the Up/Down switch to increment/decrement the timer in 30-second steps from 0-450 or disable it by selecting 0 seconds. When the desired value is displayed, store it by pressing the F2 switch.

5.18.7 CHANNEL PARAMETERS

NOTE: If “PASSWORD” is briefly displayed when attempting to select a parameter, see Section 5.18.3.

The “CHAN PARMS” menu parameter selects the following conventional channel parameters that can be reprogrammed. Press F2 switch to select the “CHAN PARMS” parameter and then press the Up/Down switch to display the desired parameter. Then press the F2 switch to select it. The squelch control parameters are unique to the type of conventional channel selected (analog or Project 25).

NOTE: If a mixed mode channel is selected, both the Rx Code (analog) and Rx NAC (P25) can be programmed. In addition, if the Tx Type is Analog, a Tx Code is programmed, and if it is Digital (P25), a Tx NAC is programmed.

TX FREQ - Programs the transmit channel frequency. The digit being changed flashes, and press the Up/Down switch to select the desired number for that digit or enter it using the keypad. Then press the F2 switch to move to the next digit if applicable. If an invalid frequency is entered, a beep sounds, “INVALID” is briefly displayed, and the number must be re-entered.

RX FREQ - Programs the receive frequency the same as the preceding TX FREQ.

SQ ADJ (Analog Only) - Changes the preset squelch setting on that channel. The default setting is “0” and values of -7 to +7 can be selected. Increasing this setting toward +7 causes the squelch to open sooner so that weaker signals can be received, and decreasing it toward -7 causes the opposite to occur.

NOTE: The channel spacing is not set with P25 channels because it is always narrow, and the squelch cannot be changed because the setting is critical for proper receiver operation.

CHAN SPC (Analog Only) - Selects either wide or narrow band channel spacing on analog channels only. Press the Up/Down switch to select “WIDE” or “NARROW”, and when the desired setting is displayed, store it by pressing the F2 switch.

NOTE: The next two parameters are programmed only if the radio is programmed for encryption.

Key Select - Selects the encryption key for the channel if applicable. The key storage location of 0-15 or 1-16 is displayed. If no keys are programmed, “No Keys” is displayed. Refer to Section 10.2 for more information.

Strapping - Selects the encryption strapping mode for the channel as Clear, Secure, or Switched. Refer to Section 10.3 for more information.

TG ID (P25 Only) - Selects the talk group for the selected channel. Press F2 to display the current talk group ID and then press F2 again to enter a different ID from 1-65,535. This number must be entered directly using the DTMF keypad.

Channel Alias - Programs the alias for the channel (DTMF keypad models only). Up to ten characters can be entered. Press F2 once to display the current alias and then press it again to program a new alias. Alpha-numeric characters are programmed using the 0-9 keys. Pressing a key once enters the first letter on the key and then pressing it successive times enters the letters and the number on the key. For example, press the “2” key twice to enter “B”. Press the F2 key to move to the next position or press it twice to enter a space.

TX TIMER - Enables or disables the time-out timer on the current channel. Press the Up/Down switch to select the on and off mode, and when the desired setting is displayed, store it by pressing the F2 switch.

TX POWER - Selects the desired power output level. Press the Up/Down switch to scroll through the

following choices. When the desired setting is displayed, store it by pressing the F2 switch.

- Power High - High transmit power
- Power Low - Low transmit power
- Power SW - Switchable power selectable by the High/Low power switch. This choice is not available if that switch is not programmed.

CTCSS/DCS Squelch Control (Analog Channel)

TX CODE - Programs the transmit Call Guard (CTCSS/DCS) code. The currently selected code and is initially displayed. Press the Up/Down switch to select the desired code type (CTCSS analog or DCS digital). Then press F2 to select it and enter the code number similar to programming a channel frequency as just described.

RX CODE - Selects the receive codes the same as TX CODE above.

NAC Squelch Control (Project 25 Channel)

TX NAC - Programs the transmit Network Access Code (NAC) which can be any number from 0-4095. With later models, this number is displayed in hexadecimal from 000-FFF. The procedure is similar to programming a TX FREQ just described. If an invalid code is entered, a beep sounds, “INVALID” is briefly displayed, and the code must be re-entered.

RX NAC - Selects the receive NAC the same as RX NAC above.

Transmit Type (P25 Mixed Mode Only) - If the selected channel is a mixed mode, analog and P25 channel, this selects the transmit type. Either Analog or Digital (P25) can be selected. This then determines if a Tx Code or Tx NAC is programmed above.

SECTION 6 SMARTNET/SMARTZONE/P25 TRUNKED FEATURES

6.1 INTRODUCTION

An overview of the SMARTNET/SmartZone and P25 Trunked operating modes is located in Section 3.9. The following information describes the features unique to these modes of operation. Refer to the “Radio Wide Features” section starting on page 20 for information on features common to all operating modes.

6.2 ANALOG AND DIGITAL OPERATION

Either analog or digital operation can be selected for communication on SMARTNET traffic channels. Each talk group can be programmed for either type of operation. Digital operation may be an optional feature.

6.3 VIEWING UNIT ID

When power is turned on with a SMARTNET/SmartZone channel selected, the five-digit Unit ID from 1-65,535 is briefly displayed as IDxxxxx. When a P25 channel is selected, the eight-digit unit ID from 1-16,777,216 is briefly displayed (see Section 5.17.1).

6.4 STANDARD GROUP CALLS

6.4.1 INTRODUCTION

Standard group calls may be placed to another radio, group of radios, or a dispatcher, depending on programming. Most calls are probably this type. Proceed as follows to place and receive group calls:

6.4.2 PLACING A STANDARD GROUP CALL

1. Turn power on and set the volume as described in Section 3.1. Select the channel programmed for the talk group you want to call (see Section 3.3).
2. If the talk group is programmed for encryption and is not strapped to Clear or Coded, select the desired mode by pressing the Clear/Secure option switch or selecting that menu parameter. The status cannot be changed if the talk group is strapped to Clear or Coded. Refer to Section 10.3 for more information.

3. Press the PTT switch and begin talking. An optional talk permit tone may sound to indicate when talking can begin. Events that may occur are as follows:

- If in the secure mode and your radio is not programmed with the proper encryption key, “KEYFAIL” is displayed and the call must be made in the clear mode or the proper key must be programmed.
- If the busy tone sounds and “BUSY” is displayed, the system is busy. Release the PTT switch and wait for the call back tone to sound. Then press the PTT switch within 3 seconds.
- If a continuous tone sounds and “NO SYS” is displayed, you may be out-of-range. Drive closer or away from shielding objects and try again.
- If your unit ID is invalid, the call is being made to an invalid group ID, or group calls are not enabled, “DISABLED ID” is displayed and an alert tone sounds.
- If an attempt is made to change an analog call from the clear to secure mode and there is no available secure channel, “NO SEC” is flashed, an error tone sounds, and the call is terminated.
- If an attempt is made to change an analog channel from the secure to clear mode, “SEC ONLY” is displayed, an error tone sounds, and the call is terminated. (Calls on digital channels can be changed if not strapped to clear or secure.)
- If the secure mode is selected by the Secure/Clear option switch or menu parameter and an attempt is made to transmit on a channel strapped as clear, “Clear Only” is displayed and the transmitter is disabled. Likewise, if the clear mode is selected and the channel is strapped as secure, “Secure Only” is displayed and the transmitter is disabled.

6.4.3 RECEIVING A STANDARD GROUP CALL

Calls are received on only the talk group and/or announcement group programmed for the selected

channel (with scanning disabled). When the selected channel is programmed with both Talk and Announcement groups, only the Talk and Announcement group IDs are detected. Other IDs in the Announcement group are detected only if no talk group is programmed.

When a group call is received, the alias of the selected channel is displayed. The radio can be programmed so that the following are also displayed for 0.5-7.0 seconds or continuously during the call.

PTT ID- The unit ID of the radio placing the call is displayed.

TG on Rx - The alias of the talk group on which the call is being received is displayed.

User Group ID - If the group ID of the call being received is included in a preprogrammed User Group ID list, the alias programmed in that list for that group is displayed.

6.5 PRIVATE (UNIT-TO-UNIT) CALLS

NOTE: With P25 Trunked operation, these calls are called Unit Calls, and they function the same as Enhanced Private Conversation calls described in the following information.

6.5.1 GENERAL

Private calls allow calls to be placed to a specific radio unit. Either the Enhanced Private Conversation™ or standard Private Conversation modes may be programmed depending on the capabilities of the radio system. One difference between these call types is that the Enhanced type provides an indication that the called radio is not on the air and the standard version does not. Operation in each of these modes is described in the following information.

The Private Call option key is required to place these calls, and either that key or the Call Response option key is required to receive them. Private calls are programmed to operate in one of the following modes:

- Disabled
- Answer-only capability

- List only - Unit IDs can be selected from a preprogrammed list only (direct entry using the keypad is not allowed)
- Unlimited - Unit IDs can be selected from a list and also dialed directly entered using the keypad.

Both limited and DTMF keypad models can be programmed to recall the unit IDs from a preprogrammed list. However, only DTMF keypad models can be programmed to directly dial unit IDs.

6.5.2 PLACING AN ENHANCED PRIVATE CONVERSATION CALL

Recalling From List

1. Momentarily press the Private Call option key or select that menu parameter and the alias of the last called radio is displayed. The private call mode is indicated by  in the display.
2. If required, select another radio by pressing the Up/Down switch until the alias of the desired radio is displayed.
3. Press the PTT switch of the F2 key to initiate the call.

(Proceed to the bulleted list which follows Item 3 in the next section for events that may occur next.)

Direct Entry Using DTMF Keypad

1. Press and hold the Private Call option key until a tone sounds (approximately 1 second). The last ID called is displayed, and the private call mode is indicated by  in the display.
2. Using the 0-9 keys, dial the ID of the radio you are calling (five digits must be entered). To erase the last digit, press the Down key, and to cancel the call, press the Private Call Option key again.
3. Press the PTT switch to initiate the call. If the entered number is valid, the display indicates the alias of the ID if it matches an ID in the call list. Otherwise, the ID you entered continues to be displayed.

Events that may then occur are as follows:

- If the radio being called is on the air, “WAIT” is displayed and ringing is heard until the called party answers or for 20 seconds, whichever occurs first. Pressing the PTT switch or an option key stops the ringing but not the call. When the call is answered, the voice of the called party is heard.
 - If the called radio does not answer within 20 seconds, a continuous tone sounds and “NO ANS” is displayed.
 - If the called radio is not on the air, a continuous tone sounds instead of the ringing tone and “NO ACK” is displayed.
 - If the busy tone sounds and “BUSY” is displayed, the called radio has answered the call but the system is busy. When the system is no longer busy, the call back tone sounds.
 - If your radio or the called radio is inhibited or not programmed to make this type of call or for the requested secure mode, “Rspns Only” is displayed and an alert tone sounds.
 - If your radio does not have the proper encryption key, “KEYFAIL” is displayed and the call must be made in the clear mode by pressing the Clear/Secure option key (if strapped to switchable). Otherwise, load the correct key.
4. When the call is finished or is not answered, end it by pressing the Private Call option key or the F1 (Exit) key.

6.5.3 PLACING A STANDARD PRIVATE CONVERSATION CALL

Recalling From List

1. Momentarily press the Private Call option key or select that menu parameter. The alias of the last called radio is displayed, and the private call mode is indicated by  in the display.
2. If required, select another radio by pressing the Up/Down switch until the alias of the desired radio is displayed.

3. Press the PTT sw or the F2 key to initiate the call.

(Proceed to the bulleted list which follows Item 3 in the next section for events that may occur next.)

Direct Entry Using DTMF Keypad

1. Press and hold the Private Call option key until a tone sounds (approximately 1 second). The last ID called is displayed, and the private call mode is indicated by  in the display.
2. Using the 0-9 keys, dial the ID of the radio you are calling (all six digits). To erase the last digit, press the Down key, and to cancel the call, press the Private Call Option key again.
3. Press the PTT switch to initiate the call. If the entered number is valid, the display indicates the alias of the ID if it matches an ID in the call list. Otherwise, the ID you entered continues to be displayed.

Events that may then occur are as follows:

- The called party answers the call.
 - The called party does not answer. Press the Private Call option key or F1 (Exit) to end the call.
 - If the selected radio ID is not valid, “INVALID ID” is displayed and an alert tone sounds.
 - If the radio system is busy, four low tones sound and “BUSY” is displayed. When the system is no longer busy, the call back tone (four beeps) is heard and the channel is automatically acquired. Press the PTT switch to continue the call.
 - If the call is in the secure mode and the radio does not have the proper encryption key, “KEYFAIL” is displayed and the call must be made in the clear mode by pressing the Clear/Secure option key or selecting that menu parameter (if strapped to switchable). Otherwise, load the correct key.
4. When the call is finished or if it is not answered, end it by pressing the Private Call option key or the F1 (Exit) key.

6.5.4 RECEIVING A PRIVATE CALL (ALL TYPES)

1. When a private call is received, "CALL RCVD" is displayed and the call tone sounds once.
2. To answer the call, press the Private Call option key or select that menu parameter and then press the PTT switch and begin speaking. The unit ID of the calling radio is displayed. More information follows:
 - If the PTT switch is pressed before the Private Call option key, the call is transmitted as a group call.
 - If private calls are not permitted (the Private Call option key/menu parameter is not programmed), press the Call Response option key or select that menu parameter to answer the call.
 - The call must be answered within 20 seconds or it is automatically terminated.
 - If the system is busy when a response is made, "BUSY" is displayed and the busy tone sounds.

6.6 TELEPHONE CALLS

NOTE: Telephone calls are available in the P25 trunked mode only.

6.6.1 GENERAL

The telephone call feature allows telephone calls to be placed and received over the public telephone system using your radio. Telephone calls are programmed to operate in one of the following modes:

- Disabled
- Answer-only capability
- List only - Telephone numbers can be selected from a preprogrammed list only (direct entry using the keypad is not allowed)
- Unlimited - Telephone numbers can be selected from a list and also dialed directly entered using the keypad.

Both limited and DTMF keypad models can place telephone calls by recalling the telephone number from a preprogrammed list as just described. However,

only DTMF keypad models can directly dial telephone numbers using the keypad. The keypad remains active during a call for over dialing DTMF digits.

6.6.2 PLACING A TELEPHONE CALL

Recalling From List

1. Momentarily press the Phone option key or select that menu parameter. The alias of the last called telephone number is displayed. The interconnect call mode is indicated by  in the display.
2. If required, press the Up/Down switch to display the desired number. The alias of each number is displayed.
3. Press and release the PTT switch and "DIALING" is displayed. Refer to the bulleted list following step 3 in the next section for events that may then occur.

Direct Entry Using DTMF Keypad

1. Press and hold the Phone option key until a tone sounds (approximately 1 second). The alias of the last called telephone number is displayed if it is in the phone number list. Otherwise, the last eight digits of the last called telephone number are displayed. The interconnect call mode is indicated by  in the display.
2. Enter the telephone number using the 0-9, *, and # keys. To enter a pause (indicated by "P"), press * and then #. To erase the last digit, press the F1 key. The number scrolls to the left in the display so that the eight right-most digits are always displayed. Numbers up to sixteen digits (including pauses) can be entered. Press the Phone option key to cancel the call.
3. Press and release the PTT switch and "DIALING" is displayed. Events that may occur are as follows:
 - If the access is successful, a dial tone sounds and the dialed number is displayed and sent. Either ringing or a busy signal is then heard as with a standard telephone call. When the called party answers, press the PTT switch to talk and release it to listen (since the radio is half-duplex, it is not possible to talk and listen at the same time).

Each time the PTT switch is released, a go-ahead tone is sent to the landside party to indicate when they can respond. To dial a number after the connection is made, press the PTT switch and dial the number using the microphone keypad.

- If the selected telephone number is not valid, “INVALID” is displayed and an alert tone sounds. Select a valid number.
 - If the system is busy, “BUSY” is displayed and the busy tone sounds. The call will automatically proceed when the system becomes available.
 - If you are out-of-range or the radio cannot be accessed for some reason, “NO PHONE” is displayed and an alert tone sounds.
 - If the interconnect call you are making or the selected secure mode is not authorized, “REJECT” is displayed and an alert tone sounds.
 - If your radio does not have the proper encryption key, “KEYFAIL” is displayed and the call must be made in the clear mode using the Clear/Secure option key or menu parameter (if encryption is selectable on the channel). Otherwise, load the proper encryption key.
4. When the telephone call is finished or if it could not be completed for some reason, end it by pressing the Phone option key or F1 (Exit) key.

6.6.3 ANSWERING A TELEPHONE CALL

1. When a telephone call is received, “ringing” similar to a standard telephone is heard and “PHONE” is displayed.
2. To answer the call, press the Phone option switch or select that menu parameter and press the PTT switch to talk and release it to listen. Since the radio operates half duplex, it is not possible to talk and listen at the same time.
3. When the call is finished, end it by pressing the PHONE option switch or F1 (Exit) key.

6.7 CALL ALERT

6.7.1 GENERAL

The Call Alert™ feature allows pages to be sent and received. With SMARTNET/SmartZone operation, either the Enhanced Private Conversation™ or Standard Private Conversation mode may be programmed depending on the capabilities of the radio system. With P25 Trunked operation, operation is similar to the enhanced mode.

6.7.2 ANSWERING A PAGE

1. When a page is received, five beeps sound and “PAGE” is displayed. The ID of the radio paging you is stored as the last ID received.
2. To clear or ignore the page, press any option switch. If the PTT switch is pressed, a group call is placed on the selected channel.
3. To answer the page as a private call (see Section 6.5), press the Private Call option switch or select that menu parameter and the alias of the radio paging you is displayed. Press the PTT switch and respond. One of the conditions that follow may also occur:

Enhanced Private Conversation Mode

- If the radio being called is on the air, ringing is heard until the called party answers or for 20 seconds, whichever occurs first. If no answer occurs within 20 seconds, a continuous tone sounds and “NO ANS” is displayed.
- If the radio being called is not on the air, a continuous tone is heard instead of ringing and “NO ACK” is displayed.

Standard Private Conversation Mode

- If the radio being called is not on the air or does not answer, you will simply not hear a response.
4. When the call is finished or it could not be completed for some reason, end it by pressing the Private Call option switch or the F1 (Exit) key.

6.7.3 INITIATING A PAGE

1. With a SMARTNET/SmartZone or P25 Trunked channel selected, momentarily press the Call Alert option switch or select that menu parameter. The alias of the last ID called is displayed.
2. If required, press the Up/Down switch to display the desired radio. The alias of each number is displayed.
3. Press the PTT switch or the F2 key and one of the following occur:
 - If five beeps sound, the system received the page and the paged radio is on the air and received it. The page mode is automatically exited.
 - If the system received the page but the called radio is not on the air, a single beep sounds and “NO ACK” is displayed 6 seconds after the PTT switch is pressed. Auto exit then occurs.

6.8 MESSAGING

NOTE: This feature is not available with P25 trunked operation.

The messaging feature allows preprogrammed messages to be sent to a dispatcher. Up to 16 messages can be preprogrammed, and they are identified by an alias. If a Message option switch or menu parameter is programmed, messages are sent as follows:

1. Momentarily press the Message option switch or select that menu parameter. The alias of the last message sent is displayed.
2. If required, press the Up/Down switch to display the desired message. Then send the message by pressing the F2 key or momentarily pressing the PTT switch. One of the following events then occurs:
 - If five beeps sound and “ACK RECVD” is displayed, the message was received and automatically acknowledged by the system.
 - If after five tries the message is not acknowledged, a tone sounds and “NO ACK” is displayed.

6.9 SENDING STATUS CONDITIONS

The status feature allows you to manually or automatically send your current status to your dispatcher. Up to eight status conditions can be preprogrammed, and they are identified by an alias. If the Status option switch or menu parameter is programmed, status conditions are sent as follows:

1. Momentarily press the Status option switch or select that menu parameter. The alias of the current status condition is displayed.
2. To change the current status, press the Up/Down switch until the desired status is displayed. Then to send the status, press the F2 (Select) switch or momentarily press the PTT switch. One of the following events then occurs:
 - If five beeps sound and “ACK RCVD” is displayed, the status was received and acknowledged by the system.
 - If after five tries the message is not acknowledged, a tone sounds and “NO ACK” is displayed.

6.10 EMERGENCY ALARM AND CALL

6.10.1 INTRODUCTION

Emergency Alarms and Calls are separate functions that can be individually enabled or disabled on each SMARTNET/SmartZone and P25 Trunked system. The Emergency option switch (or menu parameter) is required for these functions. Other emergency features are as follows:

- Emergency Alarms are transmitted on the selected talk group if emergency calls are disabled, and on the emergency talk group if emergency calls are enabled.
- Emergency Call talk group selection priority is as follows. For example, if a global emergency channel is not programmed, the emergency talk group of the selected channel is used and so on.
 1. Global (radio wide) emergency channel
 2. Emergency group of the selected channel

3. Talk group of the selected channel
4. Announcement group of the selected channel

- The emergency programming of the system to which that emergency talk group is linked controls the emergency operation.

6.10.2 EMERGENCY ALARMS

An emergency alarm is a special transmission that alerts a dispatcher of an emergency situation. It is sent automatically by simply pressing Emergency option switch or selecting the Emergency menu parameter. The system to which the emergency channel is linked must have Emergency Alarms enabled. If not, Emergency Alarms are disabled. The alarm is sent on the control channel using Motorola proprietary signaling.

Proceed as follows to send an emergency alarm:

1. If required, select a channel of a system on which Emergency Alarms are enabled and then press the Emergency option switch or select that menu parameter. The radio then automatically transmits the emergency alarm.
2. Either Normal or Silent operation can be programmed. With the Normal mode, the red LED lights, the emergency tone sounds, and “EMERGENCY” flashes in the display. This indication continues to flash until the alarm mode is ended (see step 4). If silent programmed or the Surveillance mode is selected (see Section 4.7), none of these indications occur. If “No Receive Activity During Emergency” is programmed, receive audio, the front panel LED, and receive icons are disabled in the receive mode.
3. When the emergency alarm is acknowledged, “ACK RCVD” is briefly displayed and the emergency acknowledge tone (two beeps) sounds. Silent operation may also be programmed in which case no tone sounds and there is no indication that an acknowledgment occurred.
4. The radio continues to transmit this message until an acknowledgment is received or the programmed number of attempts have been made. The emergency alarm mode is exited when radio power is

cycled or by pressing and holding the Emergency option switch.

6.10.3 EMERGENCY CALLS

General

An emergency call urgently requests access to a voice channel (an emergency tone usually does not sound at the console). An emergency call is placed by pressing the PTT switch after pressing the Emergency option button or selecting the Emergency menu parameter. If the Emergency Hot Mic feature is enabled, the emergency call is automatically transmitted without having to press the PTT switch (see following description). The system to which the emergency channel is linked must have Emergency Calls enabled.

Emergency Hot Mic

If Emergency Hot Mic has been enabled for emergency calls, automatic transmitting occurs with microphone audio unmuted without having to manually press the PTT switch. The automatic transmit period is programmed for 10-120 seconds in 10-second intervals. If this feature or emergency calls are not enabled by programming, automatic transmitting does not occur. This feature is initiated only on the first press of the Emergency switch. Subsequent presses do not trigger automatic transmissions. To reset this function, the channel must be changed or power cycled.

Placing an Emergency Call

1. If required, select a channel of a system on which Emergency Calls are enabled and press the Emergency option switch or select that menu parameter. The Emergency Alarm is then sent as described in Section 5.10.2 if applicable.
1. The emergency mode is indicated when “ACK RCVD” is briefly displayed and then “EMERGENCY” and the emergency talk group are alternately displayed.
2. If the preceding Emergency Hot Mic feature is enabled, the call is automatically transmitted without pressing the PTT switch. If it is disabled,

press the PTT switch and begin speaking as with a standard call.

3. All group calls which follow are then emergency calls (private, telephone, and call alert calls are not allowed). If the channel is changed, the call is made on the emergency talk group programmed for the new channel. If the Surveillance Mode is enabled (see Section 4.7), all indicators, lights, and tones are disabled. If “No Receive Activity During Emergency” is programmed, receive audio, the front panel LED, and receive icons are disabled in the receive mode.
4. To exit this mode, cycle radio power or press and hold the Emergency switch.

6.10.4 EMERGENCY MAN-DOWN FEATURE

This feature requires a special man-down switch (currently available only from third-party vendors) that is attached to the accessory connector of the radio. Then if this feature is enabled by programming and the radio is in a horizontal position for longer than the programmed time (0-63 seconds), an emergency condition is triggered the same as if the Emergency switch was pressed. The emergency can be canceled by a press and release of the Emergency switch. Note that accessories such as speaker-microphones cannot be used with this feature.

6.11 FAILSOFT OPERATION

If a failure occurs in the SMARTNET/SmartZone or P25 Trunked system so that it cannot be used, the system directs the radio to automatically enter the failsoft mode. When in this mode, “FAILSOFT” and the alias of the selected channel are alternately displayed. A failsoft tone may also be heard, depending on how the repeater is programmed.

When in the failsoft mode, operation is in the conventional mode on the preprogrammed failsoft channel (a different failsoft channel can be programmed on each talk group). If a transmission is attempted before a failsoft channel is located, a continuous tones sounds until the PTT switch is released. When the radio system returns to normal operation, this is automatically detected and normal operation resumes.

6.12 SMARTNET/SMARTZONE/P25 TRUNKED SCANNING FEATURES

6.12.1 GENERAL

Scanning on a SMARTNET/Smartzone and P25 Trunked systems is called Priority Monitor Scan. The following are unique features of this type of scanning. For general scanning information applicable to all operating modes, refer to Sections 4.8 and 4.9.

- Scanning is turned on and off by the Scan option switch or menu parameter. Talk groups (channels) can be programmed so that scanning automatically starts when the talk group is selected (Autoscan).
- When responding to calls in the scan mode, the programming of the Talkback Scan parameter determines if a response always occurs on the talk group of the call (Active Group) or the Selected Group if they are different. Transmissions at other times always occur on the selected talk group.
- Each talk group can be programmed to select one of the programmed scan lists or “No List” (scanning is disabled). If scanning is enabled and the selected channel does not permit scanning, it is automatically enabled again when a channel is selected that permits scanning.
- Up to 256 scan lists, each with up to 512 talk groups from the same system can be programmed. The selected scan list can be temporarily changed and edited as described in Section 4.9.1.
- In addition to calls on channels in the scan list, pages, private/unit calls, and telephone calls are received while scanning. Private and telephone calls are not interrupted by priority messages.

6.12.2 PRIORITY TALK GROUP SAMPLING

One talk group in the scan list can be designated a priority talk group by programming or it can be the selected talk group. When scanning, messages on a non-priority talk group are interrupted by messages on the priority talk group. Priority scanning must also be supported at the system level for it to occur as programmed in the radio.

6.13 DYNAMIC REGROUPING

The dynamic regrouping feature allows a dispatcher to change the current talk group or switch radios to a predefined regrouping channel to receive an important message. When the console issues a regroup order, the radio switches to the preprogrammed regroup talk group.

If the Cancel Dynamic Regrouping option switch or menu parameter is programmed, it can be used to exit the dynamic regrouping mode if desired.

Otherwise, if the lock mode was not specified, the selected talk group can be manually changed and the previous talk group is reselected if power is cycled. If a locked regroup command is received, the displayed talk group cannot be changed manually or by cycling power. It can be changed only after a clear order is received from the console.

Dynamic regrouping operates as follows:

1. When this command is received, alternating tones sound and the radio automatically changes to the regrouping channel and “DYN REGRP” is displayed.
2. Manually select the channel corresponding to that alias. If this is not done, transmission still occurs on the new channel, but the alternating tones sound each time the PTT switch is pressed.
3. Talk and listen as usual. When dynamic regrouping is canceled by the dispatcher, a short tone sounds. If a standard channel is not selected after this occurs, transmission is not allowed if the talk group is assigned as a dynamic regrouping talk group only. If it is assigned as a normal talk group, normal transmissions are allowed.

6.14 SMARTZONE AND P25 TRUNKED UNIQUE FEATURES

6.14.1 INTRODUCTION

As described in Section 3.9.3, the SmartZone[®] mode provides wide area coverage by allowing roaming between SMARTNET and conventional sites. The P25 Trunked mode can provide access to a single

trunked site or roaming between several trunked sites. Operation in these modes is the same as just described in the preceding sections (6.1-6.13) with the following additional features:

6.14.2 BUSY OVERRIDE

The busy override feature is enabled at the system level by the system manager and is not a programmable radio feature. It allows a call to be placed even if not all sites you are calling have a free traffic channel. The only sites guaranteed to be included are the Critical Sites and the sites where a Critical User is located. This feature operates as follows:

1. Assume that you have attempted to place a call and the system was busy (“BUSY” displayed and busy tone sounded).
2. Release the PTT switch and then press it for 5 seconds or more. If a chirp tone sounds with the PTT switch pressed, busy override is occurring.

NOTE: Remember that not all members of the talk group are receiving your message. Missing members will start receiving your message as channels become available.

6.14.3 SITE TRUNKING

Site trunking occurs when a site can no longer participate in wide area trunking. It is disconnected from other sites and only supports calls with other radios on that site and cannot route audio to other sites. When site trunking is occurring, the radio searches for other sites that may provide wide area coverage.

Site trunking ends when a wide area coverage site is located, the current site is operating again as a wide area coverage site, an out-of-range condition occurs, or the failsoft mode is entered. The radio can be programmed so that “Site Trunking” is displayed and/or an alert tone sounds when site trunking occurs.

SmartZone and P25 trunked systems can be programmed for “Disable Site Trunking Operation”. The radio is then not allowed to start or operate on a site trunking site. If a site goes into site trunking, the radio leaves that site’s control channel and attempts to

find another valid wide area site. If no wide area site is available, the radio displays “Out-of-Range”. If a site adjacent to the current Home Site was in site trunking but then enters wide area trunking, it is evaluated to determine if it should move to that site as a better site.

6.14.4 DETERMINING CURRENT SITE AND SEARCHING FOR NEW SITE

To display the RSSI level of the current site, press the Site Search option switch or select that menu parameter. The display then indicates the current site number as “SITE xx” and the RSSI level as “RSSI xx”. This mode is then automatically exited.

To scroll through the other programmed sites, press and hold the Site Search option switch while “SITE xx” or “RSSI xx” is displayed. If site lock is on when site search is entered (see following), the radio will be locked on the new site when this function is exited.

6.14.5 LOCKING/UNLOCKING A SITE

It is sometimes desirable to stay on a site. To prevent the radio from searching for a new site, lock it on the current site by pressing the Site Lock option switch or selecting that menu parameter. The display then momentarily indicates the site alias to indicate that the current site is locked (“x” is the current site number). To unlock the site, press the Site Lock switch again or the F2 (Select) key and “UNLOCK” is momentarily displayed.

6.14.6 ZONEFAIL SITE LOCK

This is an optional feature that can be enabled only by factory programmed. It is not programmed by the PCConfigure software, and does not require any special inputs from the infrastructure to operate. This feature is intended to prevent some of the confusion resulting from a site controller failure. When this occurs, all sites go into the Site Trunking mode and radios continue to roam normally according to RSSI level. The result is that the various radios selected by a particular talk group may be operating on different sites and are unable to talk to each other (see Section 6.14.3 for more Site Trunking information).

With the Zone Fail Site Lock feature enabled, the radio continues to roam normally when the system

zone controller is active. However, if the zone controller fails, this is detected and the Zone Fail Site Lock mode is entered. The only site the radio is then allowed to operate on is its home site. If its home site is not available, “Out-of-Range” is displayed. A zone controller failure is detected by determining that every site in the dynamic site list is in Site Trunking. Currently, this condition must be detected for at least 1 minute for the Zone Fail Site Lock mode to be selected.

The result of this operation is that all radios with the same programmed home site are forced to the home site to communicate which ensures that they can continue to communicate. If the home site is not available, the Out-of-Range condition tells the user to attempt communication on another system or by some other means.

6.14.7 P25 WIDE AREA SCAN

Introduction

This feature is intended to enhance roaming performance, especially when system level steering via radio or talk group permissions is used.

Normal P25 and SmartZone Control Channel Hunt

The following control channel search methods are normally used to find a control channel:

Short Hunt - The dynamic array of 7 (or 15) adjacent sites is searched. This list is saved on power down and loaded again at power up. It is erased whenever parameters are downloaded to the radio by the PCConfigure programmer.

Long Hunt - If no valid control channel is located by the preceding short hunt method, the radio searches the list of control channels programmed into the radio by the PCConfigure programmer.

Full Spectrum CC Scan - If the two preceding methods do not locate a control channel, every channel available to the radio is searched.

Talkgroup Steering Via System Access Permissions

In order to use system channel resources more efficiently, some system operators are using system

access permissions to steer certain talkgroups to particular sites. For example, a police department may be allowed to use only Site 1, and a public works department may be allowed to use only Site 2.

The problem with this operation is that every time a different talk group is selected, the access permission may be different and a different site may need to be accessed. This could result, in a worst case, in a delay of up to 30 seconds in finding a new site. This could occur if there are no valid sites for the new talk group in the dynamic site list.

P25 Wide Area Scan

A feature called Wide Area Scan can be programmed to minimize the problem just outlined. This feature is programmed on the Talk Group list screen selected on the P25 System screen. When Wide Area Scan is selected, talk group site preferences are no longer available. However, System Site Preference lists can still be used. The Wide Area Scan feature functions as follows:

1. Assume TG1 is selected. If it is the first time this talk group is selected, normal searching for a control channel occurs according to the hunt methods previously described.

2. When another talk group is selected, the active valid site for TG1 is stored in EEPROM memory.
3. The next time TG1 is selected, the following procedure is performed before performing the normal hunt methods previously described.
 - a. The last valid site ID and its receive and transmit channel numbers are loaded from EEPROM memory.
 - b. The dynamic site list is checked to see if any newer receive/transmit channel information is available for the last site ID.
 - c. The best receive/transmit information is used and the radio checks to see if this control channel is available.

The result of the preceding operation is that the radio has a reasonable chance of finding a valid site, usually on the first try. This greatly reduces access time, even on systems which have highly restricted talk group based access.

SECTION 7 MISCELLANEOUS

7.1 SUPERVISORY TONES

Single Beep (Alert Tone)

- Power was turned on and a successful power-up sequence occurred (Section 3.1).
- The time-out timer is about to expire or the penalty timer has expired (Section 4.3).
- The conversation timer is about to expire (Section 5.7).
- The system received your page but the paged radio is not on the air (Section 6.7).
- Telephone interconnect is not operational (Section 6.6).

Continuous Tone (Invalid Condition)

- A transmission is being attempted on a conventional channel programmed as receive-only.
- The transmitter is disabled by the busy channel lockout feature (Section 5.4).
- The transmitter has been disabled by the time-out timer feature (Section 4.3).
- The transmitter has been disabled by the conversation timer (Section 5.7).
- An out-of-range condition exists (SMARTNET/SmartZone and P25 trunking only).
- A transmission is being attempted before the penalty timer has expired (Section 5.6).
- Dynamic regrouping has been exited but the dynamic regrouping channel is still selected (Section 6.13).

Single Short Medium-Pitch Tone

- A valid key has been pressed.

Single Short Low-Pitch Tone

- An invalid key has been pressed.

Medium Tone (No Acknowledge)

- The paged radio did not acknowledge the page (Section 6.7).

- The message that was sent has not been acknowledged (Section 6.8).
- The status condition that was sent has not been acknowledged (Section 6.9).

Five Beeps (Recurring)

- The page was received (Section 6.7).

Two Short Tones

- A private call was received (Section 6.5).

Five Beeps

- The paged radio received the page and acknowledged it (Section 6.7).
- The message that was sent has been received and acknowledged (Section 6.8).
- The status condition that was sent has been received and acknowledged (Section 6.9).

Four Beeps

- The emergency alarm condition was acknowledged (Section 6.10).
- Four low tone beeps indicate call back mode (the system is no longer busy)

Alternating Tone

- Dynamic regrouping has occurred (Section 6.13).
- Dynamic regrouping has occurred but the regrouping channel is not selected (Section 6.13).

Busy Signal

- The radio system is busy or a busy condition exists when making a telephone call.

Three Medium Pitch Tones

- A channel is available after a busy condition occurred (SMARTNET/SmartZone only).

7.2 ERROR MESSAGES

The following are definitions of the various error messages that may be displayed.

Aff Failed - A group affiliation attempt has received a FAILED response from the system. The precise reason for a FAILED response is manufacturer dependent.

Aff Deny - A group affiliation attempt has received a DENIED response from the system. The precise reason for a DENIED response is manufacturer dependent. One common cause is that the group is disallowed on the site/RFSS that the radio is attempting to affiliate on.

Aff Refused - A group affiliation attempt has received a REFUSED response from the system. The precise reason for a REFUSED response is manufacturer dependent.

Answer Only - The user has attempted to initiate a private call or interconnect call and the feature is programmed for answer only.

Bad Band - A profile/or user parameters have been downloaded with PCConfigure that are for a band different from the hardware of the radio.

Bad ESN -The ESN of the radio is not valid. This error is usually only seen in the factory when first programming brand new logic boards.

Bad Fl Fmt - A profile/or user parameters have been downloaded to the radio that do not match the file format supported by the firmware/software in the radio.

Bad Hrdwar - The ESN of the radio is not valid. This error is usually only seen in the factory when first programming brand new logic boards.

Batt Low - The battery voltage has been detected as being low.

Busy - A call has been attempted and the system has responded that no channels are available for assignment.

Busy Tmout - The radio previously received a busy response from the system and it has not received a

channel grant before the busy time-out timer has expired

Disabled - The selected channel is disabled.

Clear Only - The selected channel or group is strapped clear only and that a secure call can not be made.

Corrupt Prm - The radio has detected that its profile/user parameters are not valid because the functional blocks can not be identified.

Denied - A group call attempt has received a DENIED response from the system.

Deny - A unit or interconnect call attempt has received a DENIED response from the system.

Disabled - The feature that the user is attempting to use has been disabled on the radio either by programming or by factory options.

DSP Failed - The main processor and the DSP have failed to complete their startup procedure at powerup.

EEPRM Fail - The main processor has timed out while trying to validate or invalidate the profile/user parameters in the EEPROM.

Encryp Bad - The main processor and the Encryption Module have failed to complete their startup procedure at power up.

Fixed High - The selected channel or group is strapped to high power and thus low power can not be selected.

Fixed Low - The selected channel or group is strapped to low power and thus high power can not be selected.

Too Hot - The mobile has passed the hot temperature threshold. Under these conditions the radio will only transmit in low power.

Invalid - The received input from the user does not fit the criteria necessary for the feature.

Invalid ID - The received ID from the user was not a valid ID.

Invalid Key - The key pressed by the user was not valid for the current situation.

Invalid Ch - The channel entered by the user in keypad programming is not valid.

Key Fail - The encryption key required by the current selected group/channel is not valid.

Keypad Lockd - The keypad lock function is active and key presses are not accepted in this mode.

Keyset Fail - The encryption key set chosen by the user is not valid.

List Only - Direct entry of a unit ID or phone number is disabled.

Locked - A selector lock command has been received and zone and channel changes are not accepted.

Lost Signal - Signal from the infrastructure has been lost during an interconnect call.

Low Power - The current channel is strapped to low power and that the user can not select high power at this time.

Msg Failed - The current channel is strapped to low power and that the user can not select high power at this time.

Narrow - The current conventional channel is programmed as a narrow channel.

No Ack - The radio did not receive an ACK for the current signaling attempt.

No Edit - The current list is not able to be edited.

No Encrypt - Encryption is not available for the selected channel.

No List - No list is available for the selected channel.

No Message - No message is programmed for transmission.

No Reply - Radio cloning failed due to no response.

No Service - OTAR service is not available.

No Site - No site with a verified ID is yet on the dynamic site list.

No Keys - No keys are available for the key select function.

Out Of Rng - This error indicates no control channel has been found for trunking operation.

Parms Fail - The checksum of the profile / user parameters does not match the calculated checksum. This indicates that there is an error in the parameters file. This message only occurs if the redundant copy of the parameters is also corrupt or is unable to be used.

Rekey Fail - This error indicates a failure in a rekeying process.

Rx Only - The selected channel is Rx only.

Sts Failed - No acknowledgement was received while sending a status report.

Timeout - A time out has occurred in attempting the current function.

Too Hot - The mobile has passed the TOO HOT temperature threshold. Under these conditions the radio will not allow Tx.

Tx Timeout - The Tx time-out timer has expired and Tx has been terminated.

VOLTAGE HI - The input voltage to the mobile is too high.

VOLTAGE LO - The input voltage to the mobile is too low.

Write Fail - The radio is unable to write to the EEPROM.

7.3 SYSTEM OPERATOR PROGRAMMING

As noted several times in this manual, programming determines the availability and specific operation of many features. This usually refers to the programming performed by the PCConfigure programmer

when the radio was set up, not to any programming a user can perform. If a feature is controlled by a front panel option switch and that switch is not available, it is probably not available.

If the Keypad Programming option switch is available, you can reprogram some conventional channel parameters. Refer to Section 5.18 for more information.

7.4 SPEAKING INTO MICROPHONE

For best results, hold the radio about 1-2 inches from your mouth and speak at a normal conversational level. Do not shout since it distorts your voice and does not increase range. Make sure that the PTT (push-to-talk) switch is pressed before you begin to speak and released as soon as the message is complete.

7.5 OPERATION AT EXTENDED RANGE

When approaching the limits of radio range, the other party may not be able to hear your transmissions and there may be an increase in background noise when messages are received. You may still be out of range even though you can hear a message. The reason for this is that the signal you are receiving is usually transmitted at a higher power level than the one transmitted by your radio. Communication may be improved by moving to higher ground or away from shielding objects such as tall buildings or hills.

7.6 LICENSING

A government license is usually required to operate this radio on the air.

7.7 RADIO SERVICE

If the radio is not responding to any key presses, the keypad may be locked. Refer to Section 3.6 for more information.

If “PASSWORD” is briefly displayed when power is turned on and you are prompted to enter a password, the Power-Up Password feature is enabled. Refer to Section 3.2 for more information.

If “UNPROGRAMD” is displayed, the cause could be any of the following:

- An unprogrammed channel is selected. Select a programmed channel.
- The selected channel is programmed for an option that is not installed or an error in programming was detected. Reprogram the radio.

If no characters appear in the display, the battery may be discharged or defective. Try another battery. If some other problem is occurring, turn power off and then on again to reset the control logic. Also make sure that the controls are properly set. If it still does not operate correctly, return it for service.

NOTE: There are no user-serviceable components in the radio. Altering internal adjustments can cause illegal emissions, void the warranty, and result in improper operation that can seriously damage the radio.

SECTION 8 DETERMINING AVAILABLE OPTIONS

8.1 GENERAL

This manual describes the operation of all features that are currently available for the 41xx radio. However, many of these features are optional and therefore may not be available in your radio. For example, Project 25 trunked operation is optional and may not be available.

Availability of optional features is controlled by factory programming of the control logic. Only those features that are specifically ordered and enabled in a particular radio are available for use and can be programmed. The features controlled by factory programming are as follows:

P25 Options

- P25 conventional data
- P25 trunked data
- P25 conventional operation
- P25 trunked operation

Encryption Options

- DES
- DES-XL
- DES-OFB
- AES

OTAR Options

- OTAR P25 conventional
- OTAR P25 trunked

Trunking Options

- STAR roaming with P25 trunked operation [1]
- SMARTNET analog operation
- SmartZone analog operation
- Digital SMARTNET/SmartZone

Feature Options

- Keypad programming (Federal Gov't users only)
- 512 channels/talk groups (41xx only, currently standard)

- DTMF Keypad support (4100 only)
- Zonefail site lock

[1] 4100 radios require that this option be enabled to roam across zone controller boundaries.

Currently, the only operating mode that is standard with all models is the conventional analog mode. Other variables such as frequency range are hardware dependent instead of software dependent.

8.2 UPGRADING A RADIO WITH NEW OPTIONS

The capability exists to upgrade radios in the field with new features. A new feature can be purchased and a special encrypted code string keyed to the ESN (Electronic Serial Number) of the radio is then provided by the E.F. Johnson Company. This string is in the form of a computer file, and is downloaded to the radio using the PCConfigure programming software. This is initiated by clicking the "Update Options" button on the Radio Options screen shown in Figure 8-1.

8.3 USING PCCONFIGURE TO DETERMINE OPTIONS

To determine what software options have been enabled in a particular radio, it is recommended that you use the PCConfigure™ programming software to read and display what options are installed. Proceed as follows:

1. Connect the computer to the radio and start the program as described in the documentation included with the PCConfigure software.
2. Select the 41xx radio type by selecting menu parameter **Radio > Series > 4100 Portable**.
3. To display the Radio Options screen shown in Figure 8-1, select **Transfer > Read Options From Radio**.
4. The check boxes indicate which options are enabled in the radio. They are for informational purposes only and cannot be edited.

Examples

The following are examples of items that need to be checked to program various optional features:

P25 Conventional Operation with DES Encryption and OTAR

P25 Options - Digital Conventional, Conventional Radio Data

Encryption Options - P25 DES OFB

OTAR Options - Conventional

P25 Trunked Operation with DES Encryption

P25 Options - Digital Conventional

Encryption Options - P25 DES OFB

Trunking Options - P25 Trunking

SMARTNET Analog and Digital Operation with Encryption

P25 Options - Digital SMARTNET/SmartZone
Encryption Options - DES Securenet and DES-OFB

Trunking Options - SMARTNET Trunking

NOTE: The “Feature Disable Options” are currently not used, so those features are always available.

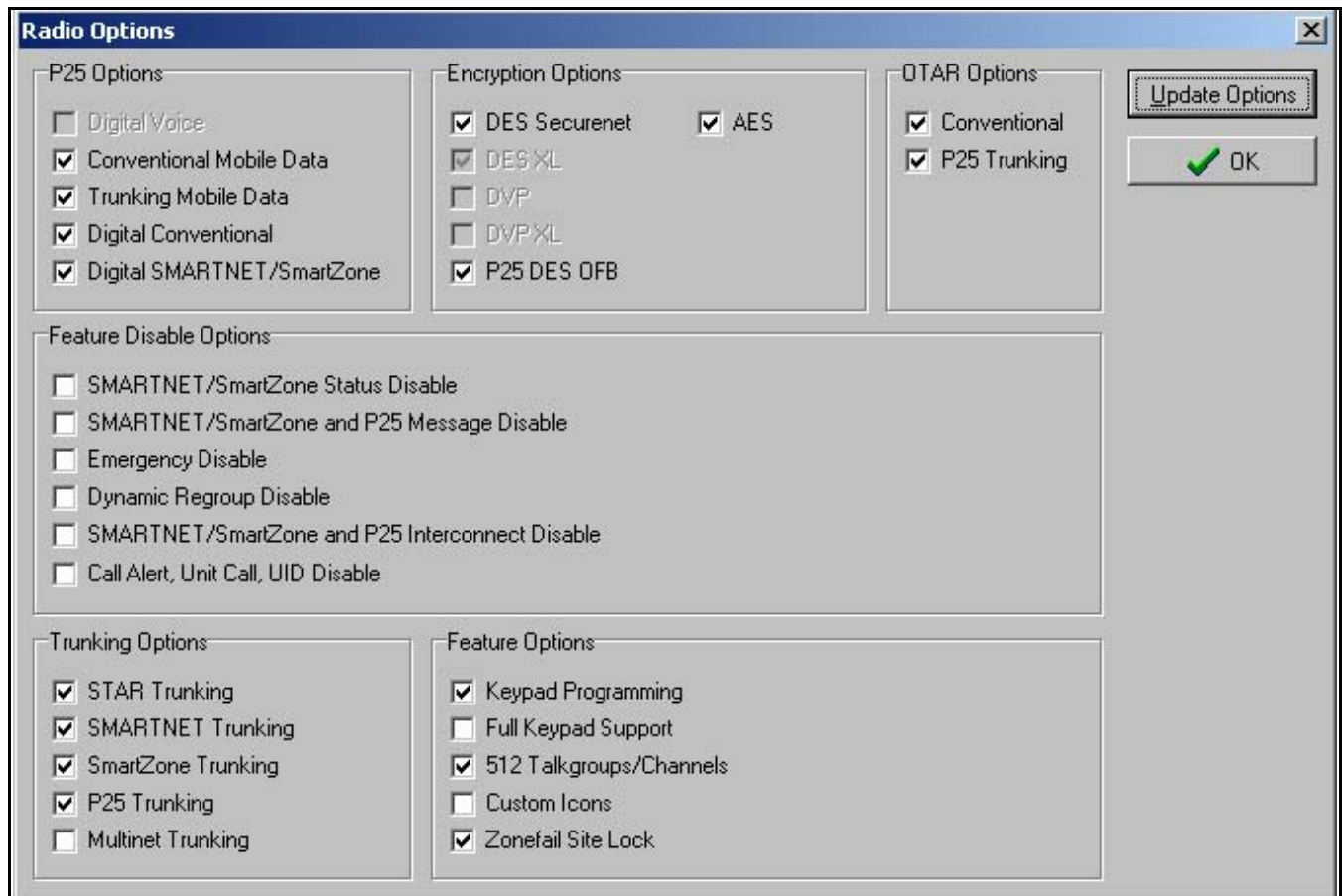

Figure 8-1 PCConfigure Radio Options Screen

SECTION 9 PASSWORD DESCRIPTION

9.1 NEW PASSWORD ENHANCEMENTS

9.1.1 INTRODUCTION

A new enhanced password feature is now available for 4100 portables and 4300 mobiles. The number of passwords have been increased along with the number of functions that can be under password control. The single Power-On password has been replaced by the following passwords:

- **Four Power-On (User x) Passwords**
- **Download and Upload Passwords**
- **Master Password**

9.2 PROGRAMMING PASSWORDS

9.2.1 GENERAL

With new versions of PCConfigure, the “Password at Power Up” parameter has been removed from the Global screen as just described. Passwords are now programmed using a password management screen displayed by the Tools > Password Management menu. The applicable radio must be connected to the computer and powered up to display this screen.

Password data is transferred and stored in an encrypted format for security purposes. In addition, actual passwords are never displayed. They are always indicated by eight asterisks (*****). Therefore, it is not possible to determine what passwords are in a radio using the PCConfigure software.

Passwords must be 1-8 characters in length and consist of the numbers 0-9. Zeros are valid characters in any location, even as leading characters. Initially, all passwords are null (deleted) characters. Therefore, when initially programming a password, no entry is required in the “Original/Master Password” box.

9.2.2 LOST PASSWORDS

If a password is lost, it can be changed using PCConfigure by entering the Master password (see

following). If even the Master password is lost or was not used, all passwords can be erased using the PCTune software as follows:

1. With PCTune 1.1.1.0 or later, simply select Radio > Reset Passwords. Only password information is erased.
2. With earlier versions of PCTune, after starting the PCTune program, press SHIFT CTRL E to toggle the following Erase EEPROM function (otherwise it is grayed and not selectable). Then Select Radio > Erase EEPROM > Params Only. All password and personality information is erased, so the radio must be reprogrammed. *NOTE: **DO NOT SELECT “COMPLETE”** because that erases all information and the radio must then be sent back to the factory to make it usable again.*

9.2.3 CHANGING PASSWORD

An assigned password can be changed by the user if the “Set User Password” option switch or menu parameter (4100 only) is programmed. Selecting this function displays prompts for entering and confirming a new password.

NOTE: With the 4100 portable and 4300 Handheld Control Unit, it is recommended that a number key not be used for this function because the password mode is exited if that key is pressed to enter a number.

9.2.4 PASSWORD ENTRY PROCEDURE

Whenever a password is requested, it is entered as follows:

43xx Mobile - Rotate and press the Select switch.

41xx Portable - With DTMF keypad models, enter each number using the keypad and press the F2 (Enter) key after the last digit is entered. With limited keypad models, enter each number by pressing the Up/Down switch and press the F2 key after each digit.

9.3 PASSWORD DESCRIPTION

9.3.1 USER (POWER-ON) PASSWORDS

When a User Password is enabled, it must be entered each time radio power is turned on. Up to four different User Passwords (User 1/User 2/User 3/User 4) can be programmed. Currently, the same radio features are enabled for each. Entering any User Password at power up enables normal radio operation.

9.3.2 DOWNLOAD/UPLOAD PASSWORDS

Separate Download (write) and Upload (read) passwords can be programmed to prevent unauthorized downloading or uploading of radio programming parameters. When one or both of these passwords are used, the proper password must be entered to perform the operation. A “User” password is not required to upload or download parameters.

9.3.3 MASTER PASSWORD

The Master Password overrides all the preceding passwords. It can be used by a system administrator as a “pass key” to a password controlled function or to change a lost or inadvertently changed password. Master passwords are set up and changed the same as

the other passwords. It does not override the following Zone Password.

9.4 ZONE PASSWORD

NOTE: The programming and usage of this password has not changed. It is independent from the preceding passwords, and programmed in the Zone > Edit Zones and Channels screen.

A zone password can also be programmed with the 43xx mobile and 41xx portable. It prevents unauthorized reprogramming of zones by keypad programming. When this password is used, it must be entered before system or channel parameters in that zone can be changed. The zone password is programmed in the Edit Zones and Channels screen. This screen is displayed by clicking the Edit Zone button on the Zone screen.

A different password can be programmed for each zone. When a password protected zone is selected, “PASSWORD” is flashed the first time an attempt is made to select a system or channel parameter in that zone. Each digit of the password is then entered as previously described. The password is always eight digits long, and after the eighth digit is entered, system and channel parameters for that zone can be reprogrammed normally.

SECTION 10 SECURE COMMUNICATION (ENCRYPTION)

10.1 GENERAL

10.1.1 INTRODUCTION

This radio may be equipped to provide secure communication on some or all channels. This feature encrypts the voice so that it can be understood only by someone using a radio equipped with a similar encryption device and encryption codes.

When a secure call is received or transmitted,  is indicated in the display (see Section 10.2.7). If equipped with the Clear/Secure option switch and the current channel is programmed to allow switch selection, secure communication can be manually enabled and disabled by that switch. Otherwise, channels are strapped to Clear or Coded operation (see Section 10.3). Secure communication can be programmed on a per channel or per talk group basis to operate in various ways. More information follows.

10.1.2 ENCRYPTION ALGORITHMS

SecureNet™

SecureNet encryption digitizes the voice and then encrypts it using the DES or DVP algorithm. It uses a 64-bit encryption key. The SecureNet protocols include the following algorithms:

- DVP (Digital Voice Privacy) is an earlier encryption method that is self synchronizing using cipher feedback. It was originally designed to be used by anyone needing protection from unauthorized eavesdropping.
- DES (Data Encryption Standard) provides a higher level of security, and also uses cipher feedback. It was originally designed to be used only by the Federal government.
- DVP-XL/DES-XL - A disadvantage of the DVP and DES encryption types is reduced communication range when compared to clear voice. The DES-XL and DVP-XL methods were designed to provide better range but at the cost of lower voice quality. They use a different type of feedback called counter addressing.
- DES-OFB - A form of DES encryption for digital channels that uses output feedback. This protocol does not result in the degraded range that occurs with analog channels.

AES (Advanced Encryption Standard)

A new encryption standard called AES is replacing DES-OFB encryption on digital (P25) channels. It uses a 128-, 192-, or 256-bit encryption key instead of the 64-bit key used with DES. EFJohnson radios currently support only 256-bit AES keys. The type of encryption (DES or AES) is determined by the type of encryption key that is loaded (see Section 10.2), and not by the PCConfigure programming software. AES encryption, like DES encryption, is an optional radio feature that must be purchased and then enabled at the factory.

10.1.3 ENCRYPTION AVAILABLE WITH VARIOUS CHANNEL TYPES

Analog Channels

On analog conventional and SMARTNET/Smart-Zone channels, DES and DES-XL encryption is used to provide secure communication. The DES-XL type is available only with later 41xx portables equipped with the Motorola UCM (Universal Crypto Module).

Digital Channels

On digital Project 25 and SMARTNET/Smart-Zone channels, the DES-OFB or AES protocol is used.

10.1.4 FIPS AND NON-FIPS MODES

FIPS 140-2 is a Federal Information Processing Standard for encrypted radios used by the Federal Government. This standard specifies Federal security

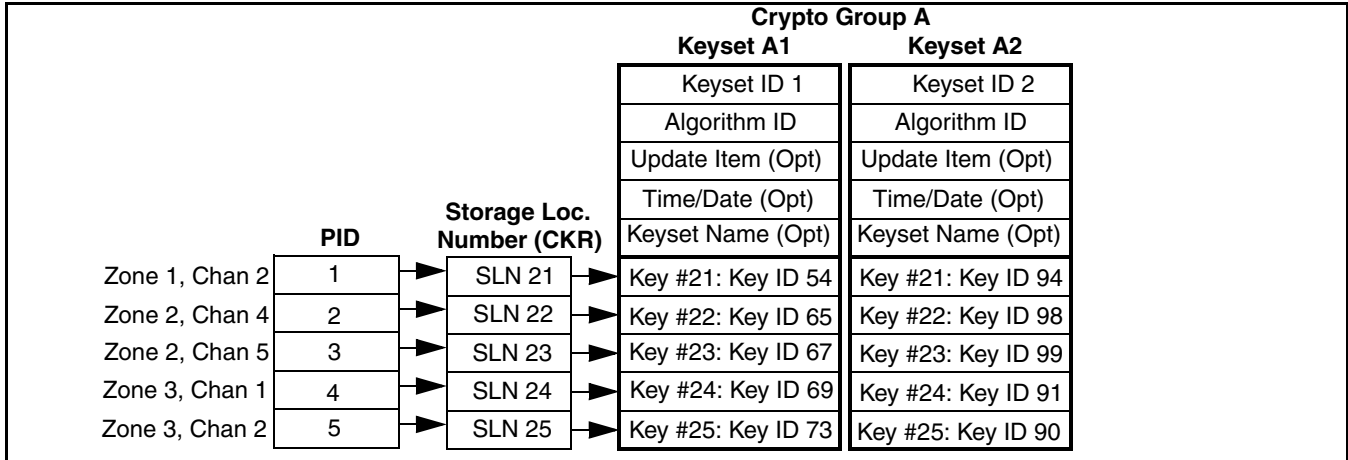

Figure 10-1 Key Selection Example

requirements for cryptographic modules for a wide range of applications and environments.

transmitted in the clear mode (this is possible only if the channel is strapped to “switchable”) or the key must be loaded.

10.2 ENCRYPTION KEYS

10.2.1 INTRODUCTION

An encryption key is a cryptographic variable that is required by the encryption algorithm to encrypt and decrypt voice or data. To maintain system security, these keys must be protected from disclosure and also periodically replaced or updated.

With the AES and DES encryption used by EFJohnson radios (see Section 10.1.2), the same encryption key is used by both the encrypting (sending) and decrypting (receiving) radio. AES encryption keys are generated from a string of 64 hexadecimal characters, and DES keys are generated from a string of 16 hexadecimal characters. Another four hexadecimal characters are used to specify the key ID. Multiple keys can be loaded into a radio using OTAR or manual loading.

When an encrypted message is transmitted, the encryption Algorithm ID (ALID) and key ID (KID) are usually included in the message. This tells the receiving radio which key and algorithm must be used to decrypt the message.

If an attempt is made to transmit a secure message without loading the corresponding key, “KEYFAIL” is displayed. The message must then be

10.2.2 KEY AND ALGORITHM IDS

Each encryption key is programmed with a Key ID (also called Logical ID). This ID plus the algorithm ID (ALGID) is transmitted in the message. The radio receiving the message must have a key programmed with the same IDs in order to decrypt it.

10.2.3 PID/SLN KEY MANAGEMENT MODES

NOTE: The term “SLN” from the Project 25 specification is equivalent to “CKR” (Common Key Reference) also used to define this parameter.

The channels, talk groups, and other calls that use encryption are linked to a specific Physical ID (PID) when the radio is programmed using the PCConfigure programming software. For example, Zone 1, channel 1 could be programmed to select the key in PID 1 and Zone 1, channel 2 could select the key in PID 3. The PID ranges are 0-15 when the PID mode is selected, and 1-16 when the SLN mode is selected (see Figure 10-1).

PID or SLN key management modes can be programmed on the Global programming screen. More information on these modes follows.

PID Mode - The PID mode can be used only when keys are loaded using the Motorola KVL 3000

keyloader. When this mode is selected, keys are loaded directly into a PID of 0-15 that corresponds to the PID programmed for each channel (if applicable). A Keys Table is not programmed with this mode.

SLN Mode - The SLN mode must be selected is either OTAR (Over-The-Air-Rekeying) or the EFJohnson System Management Assistant (PDA keyloader) is used. It can also be used if OTAR is not used. With this mode, keys are loaded into a SLN (Storage Location Number), typically from 0-4095. A Keys Table must then be programmed to link channel PIDs to a specific SLN.

The use of this type of indirect linking allows keysets and key IDs to be changed via OTAR while keeping the mapping from the channel or talk group the same. For example, as shown in Figure 10-1, PID 4 selects SLN 24 which selects key slot 24 in both keysets. This slot contains Key ID 69 in Keyset 1 and Key ID 91 in Keyset 2. Only one keyset is active at a time.

10.2.4 MAINTAINING KEYS IN MEMORY

The radio may need to be connected to a constant power source to preserve the encryption keys in memory. The programming of the Infinite Key Retention parameter determines if keys are permanently stored in memory or erased soon after power is removed.

When Infinite Key Retention is enabled, keys are stored in memory and are not lost when power is removed. If it is disabled, they are maintained only until the storage capacitance discharges. With 4100 models, storage capacitors maintain the supply voltage (and encryption keys) for approximately 30 seconds without power applied. Therefore, when changing the battery, make sure to reattach another within 30 seconds.

With 5300 models, the keys are maintained for approximately 8 hours with this feature disabled. However, a tamper switch causes immediate key erasure when the radio cover over the logic board is removed.

10.2.5 ENCRYPTION KEY SELECT

NOTE: This feature is available on conventional channels only.

When multiple encryption keys are programmed (see preceding information), the Key Select option switch can be programmed to allow selection of another key for the current channel. This feature changes the PID (hardware location) of the key, and the change is permanent (cycling power or selecting a different channel does not reselect the original key). Therefore, to switch back to the original key, it must be manually reselected. Proceed as follows to select a key:

1. Press the Key Select switch or select that menu parameter and HWKEY x is displayed. The “x” indicates the current key PID selection.
2. Press the Up/Down switch to display the desired key and then press the F2 (Select) key to select it. Press the F1 (Exit) or Key Select switch again to return the display to normal operation.

10.2.6 ENCRYPTION KEY ERASE

A Key Erase menu item can be programmed that allows the user to permanently erase all stored keys. If OTAR TEK and KEK keys are stored, all keys of both types are erased. This function can be used to ensure that unauthorized encrypted calls can no longer be placed or received by a radio.

10.2.7 ENCRYPTION ICON OPERATION

Basically, the encryption icon  is on continuously whenever a secure call is received or transmitted. Other operation is as follows:

- When a secure call is received on a digital channel in either the secure or clear mode, this icon flashes.
- When a clear call is received on a digital channel in the secure mode, this icon is on continuously.
- There is a programmable option on the Radio Wide screen to sound a beep whenever a secure call is received on a clear channel.

10.3 CLEAR/SECURE STRAPPING

10.3.1 TRANSMIT MODE OPTIONS

The following transmit options are available when encryption is selected:

Clear - All calls are in the clear mode unless responding to a secure call. If the response is then made within the delay time (see Section 4.8.4), it occurs in the secure mode.

Secure - All calls are made in the selected secure mode.

Switched - The mode is selected by the Clear/Secure switch. When the clear mode is selected by this switch, "CLEAR" is flashed, and when the secure mode is selected, "SECURE" is flashed.

If the channel has been strapped "Clear" and the option switch selects the "Secure" mode on power up and a transmission is attempted, "Clear Only" is displayed and transmitting is disabled. Likewise, if the channel is strapped "Secure" and the option switch selects the "Clear" mode on power up and a transmission is attempted, "Secure Only" is displayed and the transmitter is disabled.

The radio can be programmed to ignore the "Clear" or "Secure" switch setting ("Ignore Clear/Secure Switch When Strapped" selected on Global screen). These preceding indications then do not occur and transmissions always occur in the strapped mode.

NOTE: If all channels/talk groups are strapped clear or secure and no Clear/Secure option switch or menu parameter is programmed, this parameter must always be selected (see following).

If the Clear/Secure switch or menu parameter are not programmed, the radio is always in the last known state (usually Clear) and there is no way to change it. For example, if the last known state is Clear and this parameter is not selected, it is never possible to transmit a Secure message on a channel strapped Secure because all that happens is transmitting is disabled, an error tone sounds, and "Sec Only" is displayed.

10.3.2 RECEIVE MODE OPTIONS

The following receive options can be programmed with conventional operation. With SMARTNET/SmartZone and P25 Trunked operation, encrypted calls are received if the proper key is programmed.

No Autodetect - Only signals coded like the transmit signals are received.

Secure Autodetect - Both clear and secure signals are automatically detected. This mode is automatically selected if the transmit mode is switch selectable.

Proper Key Autodetect

Analog Channels

When this feature is disabled and a message is received with the wrong key, the audio unmutes and garbled (encrypted) audio is heard. However, if this occurs with this feature enabled, the audio remains muted.

Digital Channels

When this feature is enabled and a message is received with a different key, but the key resides in the radio, the audio is decrypted and received normally even though the key is assigned to a different talk group. If this feature is disabled or the key does not reside in the radio, the audio remains muted.

10.3.3 TALK GROUP ENCRYPTION OVERRIDE

On conventional digital (P25) channels, the encryption strapping mode and PID are programmed on a per talk group basis similar to the trunked modes (SMARTNET/SmartZone/P25 Trunked). However, with this mode only, there is the option to override the talk group encryption programming and program it on a per channel basis. Therefore, if desired on conventional digital channels, encryption can be programmed differently for each channel. Conventional analog channel encryption is always programmed on a per channel basis.

10.4 OTAR (OVER-THE-AIR REKEYING)

10.4.1 INTRODUCTION

OTAR stands for "Over-The Air-Rekeying". This is the process of sending encryption keys and related key management messages over-the-air to specific radios. The advantage of OTAR is that it allows these keys to be quickly and conveniently updated when

necessary. It is no longer necessary to periodically travel to the radio location or bring the radio into a maintenance facility to load new keys.

The actual OTAR rekeying functions are performed by a Key Management Facility (KMF) that sends Key Management Messages (KMM) to the radios. These messages are themselves encrypted using a unique key. Radios must be OTAR-compatible and programmed for OTAR for this type of rekeying to occur.

Currently, OTAR is available only on P25 conventional channels, and to program DES-OFB and AES keys (future programming on P25 trunked channels is planned). It is not used on SMARTNET/Smart-Zone channels or to load DES/DES-XL keys.

10.4.2 ENCRYPTION KEY TYPES

There are two types of keys used with OTAR:

TEK (Traffic Encryption Key) - The key used to encrypt voice and data traffic. All radios using encryption must have at least one of these keys. This is also another name for the keys used without OTAR.

KEK (Key Encryption Key) - The key used to encrypt keys contained in OTAR Key Management Messages (KMMs). All radios which use OTAR must contain at least one of these keys. The KEK used to decrypt/encrypt keys in an OTAR message is defined by the algorithm and key IDs transmitted in the decryption instructions field. A KEK may be unique to a particular radio (UKEK) or common to a group of radios (CKEK).

10.4.3 KEYSSETS

To simplify key management, a number of keys may be grouped together in a keyset. A keyset is simply a set of one or more keys of the same type (either TEK or KEK). Keysets are identified by Keyset IDs, and the upper four bits of this ID specify the crypto group (see next section).

The KEK keyset is considered always active and is ID 255. Two TEK keysets are normally used, and one is always active and the other inactive. This allows the inactive keyset to be replaced without interrupting operation. One is Keyset ID 1 and the other Keyset ID

2. With EFJohnson radios, each keyset can contain up to 128 keys, but less than 16 are normally used for optimum keying efficiency and because only up to 16 can be selected by the radio.

The active keyset is usually selected by the Key Management Facility. It can also be selected by the keyloader function of the EFJohnson SMA (Subscriber Management Assistant) or by the user if the Change Keyset option switch or menu parameter is programmed. Automatic keyset changeovers are not supported by EFJohnson radios. In the SLN mode (see Section 10.2.3), two TEK keysets can be used if desired even if OTAR is not used.

A diagram of a keyset is shown in Figure 10-2. Some information may be optional as shown. The 41xx portable does not support or use the Update Item and Time/Date parameters.

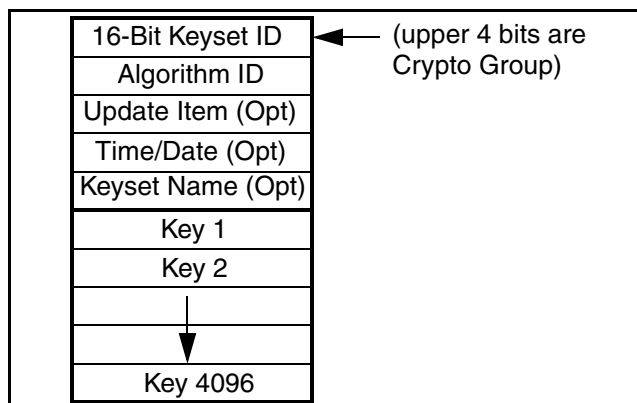

Figure 10-2 Keyset Diagram

10.4.4 CRYPTO GROUPS

A crypto group contains up to 16 keysets of the same type of key, either TEK or KEK (see Section 10.4.2). However, only two keysets are typically used as just described. Crypto groups are used to help manage keys such as when a radio uses keys with different active times or multiple algorithms. Currently, only one crypto group is supported, and it is always ID 0. As shown in Figure 10-3, the crypto group ID is the upper four bits of both the SLN and Keyset IDs.

10.4.5 KEY MANAGEMENT FACILITY

The Key Management Facility (KMF) provides key management and OTAR functions to applicable

radios within the radio system. One of the main tasks of the KMF is to maintain a data base of information

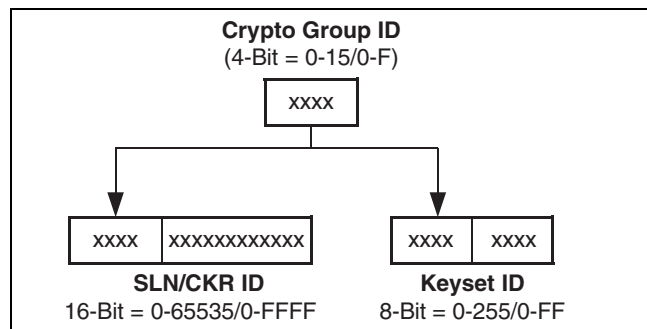

Figure 10-3 Encryption Parameter IDs

contained in each radio. This information may include the following:

- TEKs (main Traffic Encryption Keys)
- KEKs (Key Encryption Keys) used to encrypt OTAR messages
- Keypsets (groups of TEKs or KEKs)
- Crypto groups (groups of keysets)
- Cryptonets (groups of radios using same keys)
- Individual and group Radio Set Identifiers (RSIs)
- List of probable lost or stolen radios

The KMF performs OTAR functions by exchanging Key Management Messages (KMMs) with the radios. Both the KMF and radio can originate messages. Some functions performed by the KMF are as follows:

- Loading new keys
- Modifying keys
- Initiating keyset switch overs
- Modifying keyset attributes
- Deleting one or more keys to remove a radio from a cryptonet)
- Deleting all keys (zeroize) when a radio may be lost or compromised
- Determining if a radio is on the air and reading key information
- Changing individual and group RSIs

10.4.6 MESSAGE NUMBER PERIOD (MNP)

One of the parameters that is programmed in a radio utilizing OTAR is Message Number Period (MNP). This parameter is programmed as described in

Section 10.5.2. This parameter is used to minimize the possibility of someone sending messages to “spoof” the system. The MNP is used as follows.

Every message sent out has a message number. The message number increments by one with each message sent. The MNP is the maximum difference allowed between messages. For example, if the MNP is set to 1000 and the last message number received by the radio is different by more than 1000 from the current message number, the current message is ignored. If the MNP is set to 65535, message numbers are ignored.

When determining this number, consider the likelihood of someone trying to spoof the system by retransmitting recorded messages and then adjust the MNP accordingly. The higher the risk, the smaller the MNP should be. A disadvantage of setting a low MNP is that the chance of blocking out intended messages becomes higher. In addition, traffic level and terrain contribute to lost messages and should also be considered when selecting this number.

A setting of 1000 is a good compromise because it blocks out real old messages but is unlikely to affect anything intentionally sent out by the system (1000 messages sent to a single radio is not likely to occur in a system in less than a year with normal usage).

10.4.7 DEFINITIONS

Algorithm - Refers to the specific encryption standard (DES or AES) that is used to encrypt a message. Each standard uses different calculations to perform the encryption (see Section 10.1.2).

Algorithm ID (ALGID) - Identifies the algorithm (DES or AES) used to encrypt a message. This ID and the Key ID are transmitted with each message to uniquely identify the key being used.

Black - Refers to information that is encrypted. The opposite is “Red” which refers to unencrypted information.

Common Key Encryption Key (CKEK) - This is a KEK common to a group of subscriber units which share the same encryption keys (are part of same crypto group). These keys can be the DES or AES

type. The use of a common key allows the subscriber units to be rekeyed by the KMF using one Key Management Message. Refer to “KEK” for more information.

Common Key Reference (CKR) Group - Same as Storage Location Number (SLN).

Crypto Group - A group of up to 16 keysets containing the same type of keys (either TEK or KEK). Although a crypto group can contain up to 16 keysets, only two are normally used. Only one keyset in a crypto group is active at a time. EFJohnson radios currently support only one crypto group.

Cryptographic Variable - The variable used by a cryptographic algorithm to encrypt a message. Also called a “key”.

Currency - Relates to the need for key updates. If a subscriber unit is current, it does not require a key update at the current time. If it is not current, the KMF has new keys for that subscriber unit or CKR group have not been sent or have been sent but not acknowledged.

Group Rekeying - The process of changing the keys in several subscriber units with a single message addressed to the group rather than changing each subscriber unit separately. This addressing is done using a group RSI. Group rekeying reduces system overhead and makes rekeying more efficient. Subscriber units in the same group must be programmed with a common KEK (CKEK) and use the same TEKs.

Key - A variable used by a cryptographic algorithm to encrypt voice or data. Also called “Cryptographic Variable”.

Key Encryption Key (KEK) - A key used to encrypt keys contained in Key Management Messages (KMMs) during OTAR. These messages may themselves be encrypted by the currently active TEK. These keys can be the AES or DES type. There are KEKs unique to a subscriber unit (UKEK) and common to a group (CKEK). The other type of key is the Traffic Encryption Key (TEK) used to encrypt voice and data messages.

Key ID - This is a 16-bit (four hex digit) number identifier from 1-65535 for an encryption key which allows the key to be identified without revealing the actual key variable. This ID and the Algorithm ID uniquely identify a key within the KMF or subscriber unit. Therefore, two keys can have the same ID if they have different algorithm IDs and vice versa. The Key ID and Algorithm ID are usually transmitted with a message to identify the key that must be used to decrypt it. Key ID 0 is not used with OTAR.

Key Management Facility (KMF) - The equipment and software which provide OTAR and related key management services to the subscriber units.

Key Management Message (KMM) - These are the messages composed by the KMF to send encryption information to subscriber units via the keyloader or OTAR. KMMs are themselves encrypted using two layers of encryption: inner and outer. The inner layer of encryption is the KEK and the outer layer is the TEK. At this layer, the KMMs are also included in a Common Air Interface (CAI) message which adds another layer of addressing. In addition, a Message Authentication Code (MAC) is used.

Keyset - A group of keys of the same type (KEK or TEK) that are managed as a single entity (they can be updated, deleted, and rekeyed with a single command).

Keyset Changeover - The process used to switch a subscriber unit to another keyset so that the unused keyset can be replaced without interrupting encrypted communication.

Key Loader - Any type of device used to load encryption keys into a radio. With OTAR, this device must be used to provide the initial key loading of a subscriber unit so that it contains the basic keys needed for OTAR by the KMF. If OTAR is not utilized, is always used to load encryption keys. All keys stored in the key loader are themselves encrypted. EFJohnson offers a PDA-based keyloader.

Logical Link ID (LLID) - An ID transmitted with a data message to identify the destination of the message.

Message Number Period (MNP) - The maximum difference between message numbers that can occur before a message is declared invalid (see Section 10.4.6).

Over-The-Air-Rekeying (OTAR) - The process of sending new encryption keys over the air using an RF interface.

Red - Refers to information that is not encrypted. The opposite is “Black”.

Rekey - The process of preparing, sending, and loading encryption keys into a subscriber unit for current or future use. This may be done over-the-air (OTAR) or by directly connecting a keyloader to the subscriber unit.

Radio Set Identifier (RSI) - Subscriber units are programmed with one or more Radio Set Identifier (RSI) numbers that identify the unit for OTAR purposes. The RSI can be unique to a individual subscriber unit or unique to a group of subscriber units. An individual (unit) RSI is always assigned and one or more group RSIs may be assigned. The individual RSI is typically programmed when the subscriber unit is initially brought into service. The KMF is also identified by an RSI (KMFRSI) to use as the destination of any KMMs a subscriber unit originates. The KMMs (Key Management Messages) generated by the KMF (Key Management Facility) are addressed to a specific RSI.

Storage Location Number (SLN) - A link to a specific key (TEK or KEK) in the active keyset. The SLN specifies both a crypto group and a key within the keysets in that crypto group (the first four bits of the SLN are the crypto group ID). SLNs and CKRs are equivalent terms (see Section 10.2).

Traffic Encryption Key (TEK) - A key used to encrypt voice or data. The other type of key is the Key Encryption Key (KEK) which is used to encrypt keys contained in Key Management Messages. TEKs can be either the AES or DES type.

Unique Key Encryption Key (UKEK) - A KEK unique to a particular subscriber unit. Refer to “KEK” for more information. These keys can be either the AES or DES type.

Zeroize - The process of deleting all keys from a compromised subscriber unit to disable it. To make the unit functional again, the keys must be reloaded by a keyloader.

10.5 RADIO SETUP FOR ENCRYPTION

10.5.1 GENERAL ENCRYPTION SETUP

The following radio setup is required for encryption regardless of whether OTAR is used:

Options Enabled - The desired encryption type must have been enabled at the factory (DES, DES-XL, DES-OFB, AES). To determine what options are enabled, using the PCConfigure programming software, select the Transfer > Read Options From Radio menu parameter.

PCConfigure Programming

PID/SLN Mode - On the global screen, select either the PID or SLN mode (see Section 10.2.3). If the SLN mode is used, also program the Keys Table by clicking the  button.

Infinite Key Retention - On the global screen, select this parameter to store keys permanently in memory (see Section 10.2.4).

Erase Keys On Keyset Change - On the global screen, if the SLN mode is selected and more than one keyset is used (see Section 10.4.3), select this parameter to erase keys when changing keysets (see Section 10.2.6).

Program Channel/Group PIDs and Encryption

Type - With conventional analog calls, this information is programmed on the channel screen. With other types, it is programmed in the talk group list selected on the system screen. In addition, with conventional digital calls, the group programming can be overridden on the channel screen (see Section 10.3.3). Additional PIDs for special calls can also be specified on the system screen for digital and trunked calls. *NOTE: The encryption type is not selectable on digital channels because the AES/DES mode is determined by the key type loaded, not by PCConfigure programming.*

Currently, EFJohnson 41xx portables and 43xx mobiles that meet the following requirements support OTAR:

Programming - An RSI and UKEK and other information must be programmed as described in the next section.

10.5.2 ADDITIONAL SETUP FOR OTAR

Additional PCConfigure Programming For OTAR

The following parameters must be programmed for OTAR operation in addition to those in Section 10.5.1 .

1. On the Radio Wide Conventional screen, program the **Digital Unit** and **Unit RSI** IDs. The **Unit RSI** ID can be set to the **Digital Unit** ID only, but later can be changed by the KMF or keyloader if desired. Note these two numbers.
2. On the Per System Conventional screen, select **OTAR Enabled = On** and **Data Registration Enabled = On**. When data registration is enabled, the radio registers with the data system on a channel change.
3. Also on the Per System Conventional screen, set the **OTAR Time Out** Time. When rekeying is requested by the radio (OTAR Rekey option button pressed or menu selected), this setting determines how long the radio waits for a response from the KMF. Times of 20-180 seconds can be programmed, and the default is 30 seconds.

Motorola RNC Registration (If Required)

The 41xx portable does not support Motorola dynamic data registration. Therefore, each radio must be manually registered on the Motorola RNC Console by entering the following command:

LCRD 03 06 00 1234 7F xx xx xx 0A 0A 00 07 00 yy

Where, “xx xx xx” is the hex value of the Digital Unit ID entered by the PCConfigure software. Refer to the console documentation for the value of “yy” or use “00”. This registration needs to be done only once.

Programming By Keyloader

The following are the minimum parameters that need to be programmed in the radio to perform OTAR. It is not necessary to program a TEK to perform OTAR. If the radio does not contain a TEK, the KMF initiates a warm start-up sequence in which a temporary TEK is transferred to the radio to perform the key transfer.

1. **UKEK** - This key normally has SLN (CKR) 61440 and Key ID 62880 (F5A0 hex). Create a key (either AES or DES type as required) and download it to the radio.
2. **RSI** - This is normally initially the same as the P25 Unit ID and is programmed by the PCConfigure software as described in Section 10.5.1. Therefore, the RSI should not need to be loaded if it is the first time the radio is being set up for OTAR or if the radio dumps keys due to long-term battery disconnect. However, it may need to be loaded if the radio is manually deleted from the KMF and then recreated since the message number must be reset to 0 (the Load Target RSI command resets the message number to 0).
3. **KMF RSI** - This RSI is normally 9,999,999 and should not need to be loaded since it defaults to this number.
4. **MNP (Message Number Period)** - Load the proper message number period into the radio (typically 1000). Refer to Section 10.4.6 for more information.
5. Verify that the above information was properly stored in the radio by viewing it using the keyloader.

10.6 RADIO OTAR CAPABILITIES

10.6.1 SEM 4100/53XX, STANDARD 41XX

The OTAR capabilities of the SEM equipped 4100 portable and 4300 mobile are as follows.

Keysets

- Up to three keysets are used and it is assumed all three are always present. Keyset IDs 1 and 2 are for

TEKs and only one is active at a time. Keyset ID 255 is for KEKs and is considered active all the time

same as described in Section 10.5.

- Each keyset can have up to 128 keys. However, 16 or less are normally used.
- AES encryption is supported (with Flash code 1.8.0 or later) but not currently available with OTAR (future availability is planned).

10.6.3 OTAR OPTION SWITCHES

The following additional option switches can be programmed with the 4100 portable and 4300 mobile to control OTAR functions. They are also available as 4100 menu parameters unless noted otherwise.

RSI (Radio Set Identifier)

- One individual RSI and it is usually initially the same as the P25 Unit ID.
- One group RSI (usually initially “0”).
- One KMF RSI (usually always 9,999,999).

Change Keyset - Toggles the active keyset between Keyset 1 and Keyset 2. The new active keyset is briefly displayed and then normal operation resumes. When the 4100 menu is used, the current active keyset is indicated by an asterisk. To change to the other keyset, highlight it and press the F2 key.

OTAR Messages That Are Supported

The following KMM Message IDs are recognized by or sent:

CHANGE RSI	0x03
CHANGE RSI RESPONSE	0x04
KEYSET CHANGEOVER	0x05
KEYSET CHANGEOVER RESPONSE	0x06
DELAYED ACK	0x07
HELLO	0x0C
INVENTORY	0x0D
INVENTORY RESPONSE	0x0E
MODIFY KEY	0x13
MODIFY KEYSET ATTRIBUTES	0x14
MODIFY KEYSET ATTRIBUTES RESPONSE	0x15
NEGATIVE ACK	0x16
NO SERVICE	0x17
REKEY ACK	0x1D
REKEY	0x1E
WARM START	0x20
ZEROIZE	0x21
ZEROIZE RESPONSE	0x22

Clear/Secure Select - This enables and disables encryption regardless of whether OTAR is used. Refer to Section 10.3 for more information.

Erase Keys - Erases all TEK and KEK keys contained in the radio. With the 4100, this function is available as menu parameter only.

Key Select - This allows a different key to be selected for the current channel or group (conventional channels only). Refer to Section 10.2.5 for more information.

OTAR Rekey Request - Sends a message which tells the KMF that the radio is on the air and requests rekeying. The following status messages are displayed which indicate the progress of this function. Additional functions that are available when this is selected using the 4100 menu mode are described in the next section.

Rekeying - A radio-initiated rekeying session is in process.

No Ack - No response was received from the KMF in response to an Identify request before time out occurred (approximately 30 seconds).

Ack Rcvd - An acknowledgement was received in response to an Identify request.

No Service - A “No Service” reply was received from the KMF. No rekeying will take place.

10.6.2 UCM EQUIPPED 4100

The 41xx UCM version uses the Motorola UCM encryption module. Therefore, the OTAR capabilities are determined by that module. All capabilities of the Motorola KVL and KMF are supported. Initial radio programming by the PCConfigure software is the

Rekey Fail - Either the rekey command failed or timed out (after approximately 30 seconds). This message could indicate that the rekey request message was not received by the KMF. However, depending on the KMF configuration and channel traffic, it is possible that the message was received and a response is still pending.

Rekeyed! - The rekey session initiated by the radio was successful.

Additional Functions Selectable by 4100 Menu:

(To select one a parameter, highlight it and press F2.)

Rekey - Performs the same function as the OTAR Rekey Request option switch described in the preceding section.

Need KEK - Sends a request for a new KEK (Key Encryption Key). Upon receiving this message, the KMF marks the radio as requiring service. One time this function may be selected is if the radio dumps its keys.

Identify - Sends a message which tells the KMF that the radio is on the air. Currently, the KMF always responds with “No Service”, even if the keys are not up to date. If “No Ack” is displayed, the KMF may not have received the message (see preceding section). This function can be used to test communication without initiating the rekeying that occurs with the preceding “Rekey” function.

Erase Keys - Erases all keys in the radio the same as the Erase Keys option switch described in the preceding section.

INDEX

A

Accessory Connector 12
 AES Encryption 61
 Alert Tones 22
 Algorithm 66
 Algorithm ID 66
 Analog and Digital Operation 42
 ANI Signaling 33
 Antenna Connector 11
 Autodetect 64

B

Backlight 16
 Battery 12
 Battery Charging 16
 Battery Saver Feature 16
 Black 66
 Busy Indicator 27
 Busy Override 50

C

Call Alert 46
 Call Alert (P25 Conv) 37
 Call Guard Squelch 28
 Channel Select 14
 Channel Switch 11
 Channels 18
 CKEK 66
 CKR 67
 Clear/Secure Strapping 63
 Clone Feature 34
 Conventional Mode 17
 Conversation Timer 29
 Crypto Graphic Variable 67
 Crypto Group 65, 67
 CTCSS/DCS Signaling 28
 Currency 67

D

Delay, Scan Resume 23
 DES-OFB 61
 DES-XL 61
 Determining Available Options 57
 Direct Channel Selection 14
 Display 12
 DTMF Keypad 11
 Dynamic Regrouping 50

E

Emergency Alarms (Conv) 30
 Emergency Alarms (SN/SZ) 48
 Emergency Calls 48
 Emergency Calls (Conv) 31

Emergency Hot Mic 31, 48
 Emergency Man-DOWn Feature 49
 Encryption 61
 Encryption Key 62
 Encryption Key Select 63
 Encryption Keys 62
 Enhanced Private Conversation
 Mode 43
 Extended Range Operation 56

F

F1 Key 10
 F2 Key 10
 F3, F4 10
 Facility 65
 Failsoft Operation 49
 Features
 Conventional 8
 General 8
 P25 Trunked 9
 Project 25 35
 Project 25 Trunked 9, 42
 SMARTNET/SmartZone 8
 SmartZone 50
 FIPS 140-2 61
 Frequency Display 30
 Front Display 10

G

Group Calls 42
 P25 35
 Group ID Code 35
 Group Rekeying 67

H

Home Zone Select 22
 Hot Mic 31, 48

I

Indicator
 Priority Channel 32
 Top Panel 11
 Individual Calls 35
 Infinite Key Retention 16, 63

K

KEK 67
 Key 67
 Key Encryption Key 65
 Key Erase Menu Parameter 63
 Key ID 62, 67
 Key Loader 67
 Key Management Facility 65

Keypad Lock 16
 Permanent 16
 Keypad Programming 38
 Keypad 65, 67
 KMF 67
 KMM 67

L

Licensing 56
 Lookback Time 32
 Lost Passwords 59
 Low Battery Indicator 15

M

Man-DOWn Feature 31
 Master Radio 34
 Menu Mode 20
 Menu Mode Functions 21
 Message Number Period 68
 Message Number Period (MNP) 66
 Messaging 47
 Messaging (Conv P25) 38
 Microphone 10
 Mode
 Conventional 17
 Project 25 Conv 17
 Project 25 Trunked 18
 SMARTNET/SmartZone 17
 Monitor Mode 27
 Monitoring Before Transmitting 27

N

NAC 35
 Network Access Code 35
 Nuisance Channel Delete 24

O

On-Off/Volume Control 11
 Operating Modes 17
 Option Button
 Key Select 63
 Option Switch 11
 Alert Tones 22
 Backlight 16
 Call Alert 37, 47
 Call Response 45
 Change Keypad 70
 Channel Select 14, 15
 Clear/Secure 42, 70
 Digital Talk Group Select 35
 Display Information 30
 Emergency 11, 30, 31, 48
 Erase Keys 70

- High/Low Power 22
 - Home 22
 - Key Select 63, 70
 - Keypad Lock 16
 - Keypad Programming 39
 - Message 38, 47
 - Monitor Mode 27
 - Normal/Selective 28
 - OTAR Rekey Request 70
 - P25 Packet Data 38
 - Phone 37, 45
 - Priority Select 33
 - Private Call 43, 44, 45
 - Private Call (SmartNet) 43, 44, 46
 - Radio Wide Scan 23
 - Repeater Talk-Around 30
 - RWS List Edit 26
 - Scan 23
 - Scan List Edit 25
 - Scan List Select 25
 - Selective Squelch 29
 - Set User Password 14, 59
 - Single Tone Encoder 33
 - Site Lock 51
 - Site Search 51
 - Squelch Select List 29
 - Status 38, 47
 - Surveillance Mode 22
 - Talk Group Select 35
 - Tone Volume 22
 - Unit Call 36, 37
 - Volume Up/Down 13
 - Option Switch Functions 21
 - Option Switches 20
 - Option Upgrading 57
 - Optional Features 57
 - OTAR 68
 - OTAR Definitions 64
 - OTAR Messages Supported 70
- P**
- P25 Packet Data 38
 - Paging 37, 46
 - Answering 46
 - Answering (Conv P25) 37
 - Initiating 37, 47
 - Password
 - Changing 59
 - Download/Upload 59, 60
 - Master 59, 60
 - Operation 59
 - Power On 59, 60
 - Power-Up 13
 - User 59, 60
 - Zone 60
 - Penalty Timer 29
 - PID Mode 62
 - Power On-Off 13
 - Power Output Select 22
 - Power Up Sequence 13
 - Power-Up Password 13
 - Priority Channel
 - Changing 33
 - Priority Sampling
 - Conv 32
 - P25 Trunked 49
 - SMARTNET/SmartZone 49
 - Programming 55
 - Project 25
 - Group ID Code 35
 - Unit Calls 35
 - Unit ID 35
 - Project 25 Mode 18, 35
 - PTT ID 43
 - PTT Switch 11
- R**
- Radio Options Screen 58
 - Radio Set Identifier 68
 - Radio Wide Mode Scan List 26
 - Radio Wide Scan 23
 - Receive Only 17
 - Red 68
 - Rekey 68
 - Repeater Talk-Around 30
 - RS-232 Port 38
 - RSI 68
 - RW Scan List
 - Determining Channels in 26
 - Editing 26
- S**
- Scan Hold Time 23
 - Scan List 24
 - Channel Delete 24
 - Determining Channels in 24
 - Editing 25
 - Selecting 25
 - Scanning 23
 - Conv 31
 - P25 Trunked 49
 - Priority 23
 - Radio Wide 23
 - SMARTNET/SmartZone 49
 - Secure Communication 61
 - SecureNet 61
 - Servicing 56
 - Silent Mode 30
 - Single Tone Encoder 33
 - Site ID (SmartZone) 51
 - Site Locking/Unlocking 51
 - Site Trunking 50
 - Slave Radio 34
 - SLN Mode 62
 - SMARTNET/SmartZone Mode 17
 - Soft Power Down 13
 - Speaker 11
 - Speaking Into Microphone 56
 - Squelch Adjust 17
 - Squelch Code Select 29
 - Squelch Control 17
 - Standard Calls
 - Placing (Conv) 33
 - Receiving (Conv) 33
 - Receiving (SMARTNET) 42
 - Standard Private Conversation
 - Mode 43
 - Status Messages 38, 47
 - Storage Location Number 68
 - Supervisory Tones 53
 - Surveillance Mode 22
 - Systems 18
- T**
- TEK 68
 - Telephone Calls 45
 - Telephone Calls) 36, 45
 - TG on Rx 43
 - Time-Out Timer 20
 - Tone Select 22
 - Tones 53
 - Trademark Information 2
 - Traffic Encryption Key 65, 68
 - Transmit Disable 17
 - Transmit Disable On Busy 27
 - Transmit Type 41
 - Transmitting in Scan Mode 24, 32
 - Troubleshooting 56
- U**
- Unit Calls
 - P25 35
 - Unit ID
 - Project 25 Conv 35
 - SMARTNET/SmartZone 42
 - Unit-To-Unit Calls 43
 - Up/Down Switch 10
 - User Group ID 43
- V**
- Voice Encryption 61
 - Volume Adjust 13
 - Volume Control Disable 13
 - Volume Up/Down 13
- W**
- Warranty 2
 - Wireless Cloning 34
- Z**
- Zeroize 68
 - Zone Password 39, 60
 - Zone Select 11, 14
 - Zones 19

