

User Manual

10.1 inch tablet



ematic

EGQ236BD

FEATURES

Browse the Web

Visit your favorite websites.

Check your e-mail

Keep in touch with friends and family.

Watch YouTube™ videos

Browse the world's most popular videosharing community.

Read your favorite books

Download thousands of books with the included E-book reader.

Marketplace

Discover thousands of apps for Android™ Games, applications, and more with Marketplace (needs to be customer installed).

Connect to the Internet wirelessly

High-speed Wi-Fi 802.11 b/g/n networking.

Enjoy your media library anywhere

Portable powerhouse plays popular music, video, and photo formats.

Micro SD memory card reader

Increase your storage capacity (up to 32 GB supported).

Built-in camera

Convenient front-facing camera with 0.3MP.

Automatic orientation detection

Read any way you want; the display adjusts automatically!

*Reading books in the ePub format requires the included E-book reader application.

UNIT AT A GLANCE

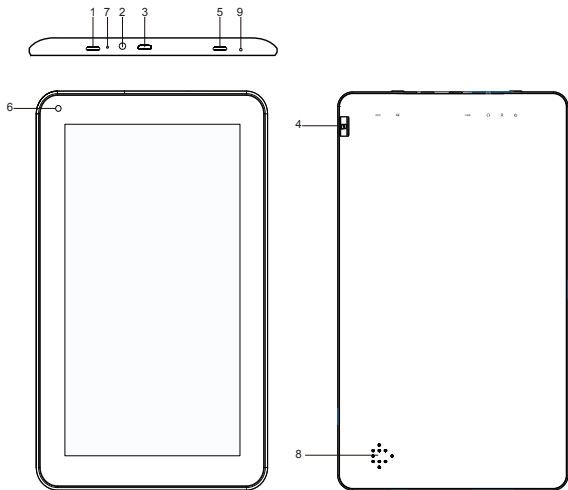

1. **Power Button:** Press this button to turn your device on or off.
2. **Headphone Jack:** Audio output connection for headphones.
3. **Micro USB Port:** Connect to a USB device.
4. **SD Card Slot:** Load external microSD memory cards here.
5. **Return:** Press this button to go back to previous screen.
6. **Front Camera:** Take photos or videos.
7. **Reset:** Restore the device to it's default factory settings.
8. **Speakers:** Project crystal-clear audio directly from your device.
9. **Microphone:** Capture audio signals for calls or voice recordings.

TOUCH SCREEN BASICS

Tap the screen once to activate or open something.



Touch and hold to move an item by dragging.

*In many apps touch and hold can offer more options.



Zooming: Double tap quickly to zoom into a webpage, picture, or map. Some apps allow you to zoom in and out by touching the screen with two fingers and pinching them together or spreading them apart.



TIP: You can flick the screen with your finger to quickly scroll through a long list, such as a library of music.

Tap a specific location on the screen where you would like to enter text. The on-screen keyboard will pop up.

GETTING STARTED

Turning the Tablet On or Off

Turn on the tablet: Press and hold the power button to start device.

Turn off the tablet: Press and hold the power button to power off the interface. Touch the “Power off” button to turn off the device.

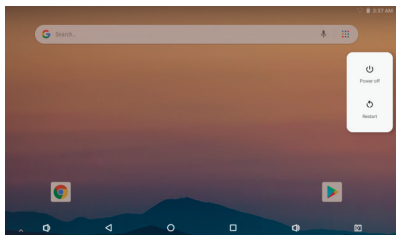

Turning the Screen On or Off

When the screen is bright, briefly press the power key to turn off the screen. Briefly press the power key again to turn on screen.

To conserve battery power, the screen can be set to turn off automatically when the tablet is not in use (between 1 minute and 30 minutes). This “Screen timeout” option can be found in the Display menu.

Unlocking the Screen

When the screen turns off, you will have to unlock the screen when you turn it back on. To unlock the screen, drag the lock icon upward across the screen.

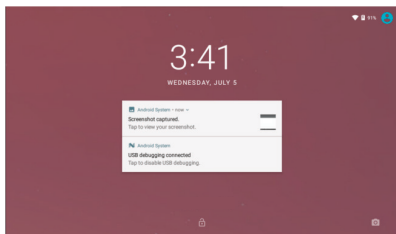

APPLICATIONS

To open an application, touch the application icon on the home screen or in the Launcher where you can tap the icon right up on the home screen to get in.

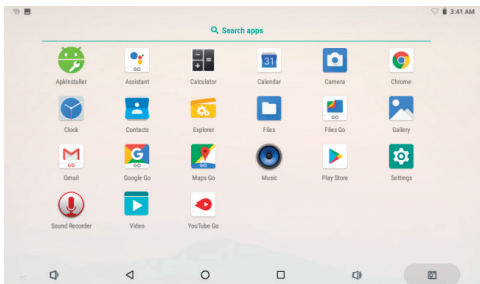

The screen shown above is for illustrative purposes only. The right to modify and improve the final list of applications available on the tablet is reserved.

Preinstalled Applications

Some applications have been installed on your tablet for your convenience. These applications include:



Gallery: View your stored images.



YouTube Go: Watch online videos.



Gmail: Check your e-mail.



Chrome: Browse the Web.



Sound Recorder: Record voice notes.



Calculator: Perform simple mathematical operations.



Maps Go: Check your location.



Calendar: Mark dates or events.



Camera: Take pictures or videos.



Video: Take pictures or videos.



Play Store: Download Apps and Games.



Files: View your stored files.

Installing Applications

You can also download and install additional applications from the device's applications marketplace, the web browser, or other sources.

The tablet must be set to allow installation of applications from non-Market sources. The "Unknown Sources" option can be set in the Application Settings menu.

YOUR HOME SCREEN

Icons

You can fill the home screen with any combinations of shortcuts, widgets, and folders you like.

When you power up your tablet for the first time, you'll see the main home screen panel. This panel is typically centered; you can access additional panels on either side of the main one by swiping your finger left or right.







Battery Level: The white battery level indicator will decrease and change to red as the battery is drained.



Wi-Fi Signal: As the Wi-Fi signal strength decreases, the blue bands will change to grey.



All Apps: Tap to view all apps.

-  Back: Go back to the previous screen.
-  Recent apps: Open a list of recent apps. Tap an app to open or swipe left/right to remove the thumbnail.
-  Home: Go back to the home screen. Hold and slide up to open Google Now.
-  Increase Volume
-  Decrease Volume

Adding Icons

Within the All Apps menu, choose an app or swipe right to choose a widget. Tap and hold the desired app or widget for about 2 seconds, until the home screen appears. Slide it wherever you want and let go.

Moving Icons

Touch and hold the icon. Slide your finger to the new position. (To move between home screens, slide toward the edge of the screen. To bump another icon out of the way, slide slowly towards it.) Lift your finger to drop the icon into its new position.

Removing Icons

Touch and hold the app or widget and drag to the “X Remove” icon at the top of the screen.

Taking a Screenshot

Make sure the image you want is displayed on the screen. Press the Screenshot icon on the status bar to take a screenshot.

You can also display or hide the screenshot button on the status bar in the settings menu.

The screenshot is automatically saved to your Gallery.

Sleep Mode

To save battery, you should put your tablet in sleep mode by turning off the LCD display. To do this, press the power key and immediately release it. Do it again to bring up the lock screen.

Quick Settings & Notifications

Swipe down from the top of your home screen to view your Notifications.

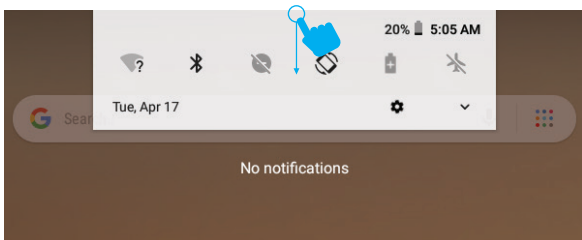

Use two fingers to swipe from the top of your home screen or swipe down again from notifications to view your Quick Settings.

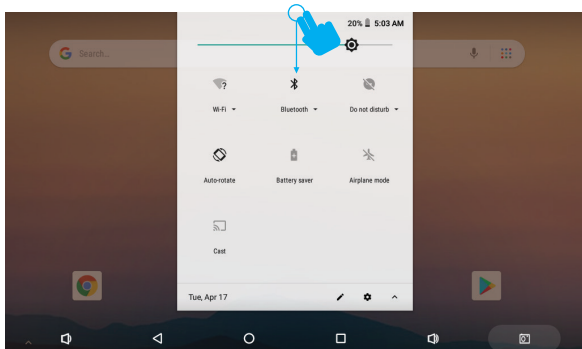

Managing Notifications

Tap on "Sounds & notifications" in the Settings Menu. You can manage what notifications you see, set notification priority level by app, and see what apps have access to your notifications. You can set up your device so that notifications only appear on at certain times, for certain types of notifications, and from specific contacts.

Widgets, Wallpapers, and other Settings

Tap and hold your finger on any open space on your home screen. A list of options appears. Here, you choose to add widgets, such as calendars, clocks, music, and more. Change your wallpaper and other home settings here.

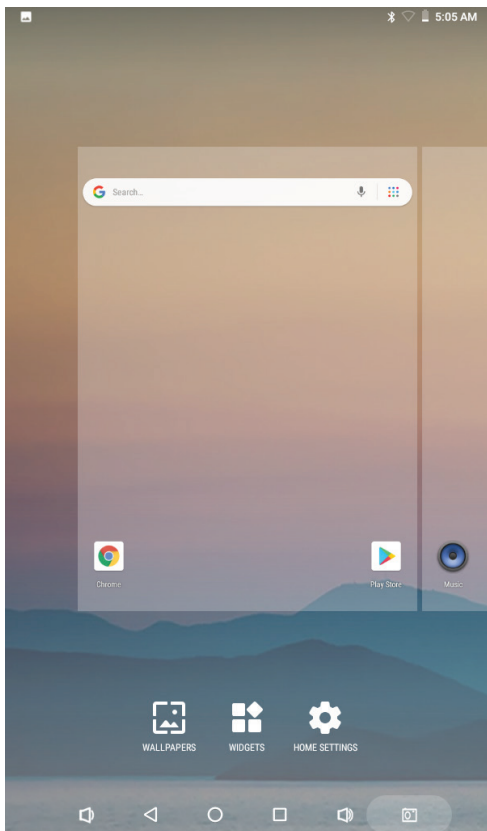

CONNECTING TO A WIFI NETWORK

1) Turn on WIFI:

Turn on the Wi-Fi button in the settings menu.

The tablet will search and display a list of the available Wi-Fi networks.

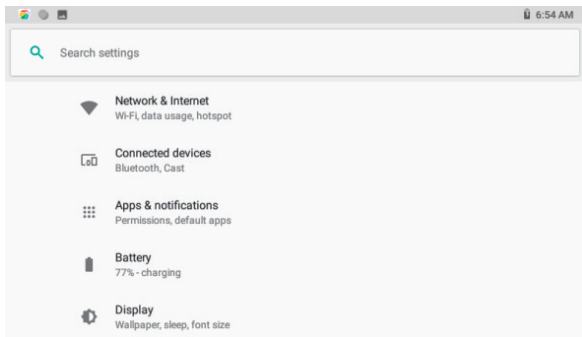

2) Connect to a Wifi Network

Choose the wifi network you wish to join, then input the password to be connected.

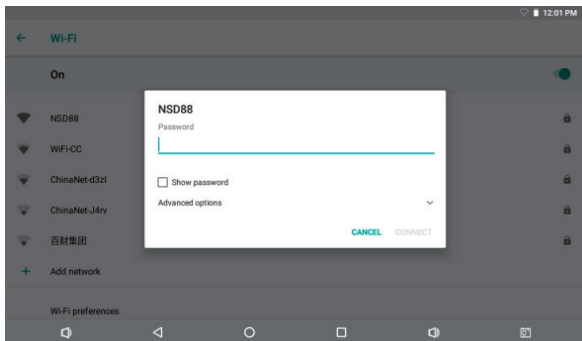

3) Other Functions

Scan, WPS pin entry, Wi-Fi direct, and advanced functions in the Wi-Fi menu.

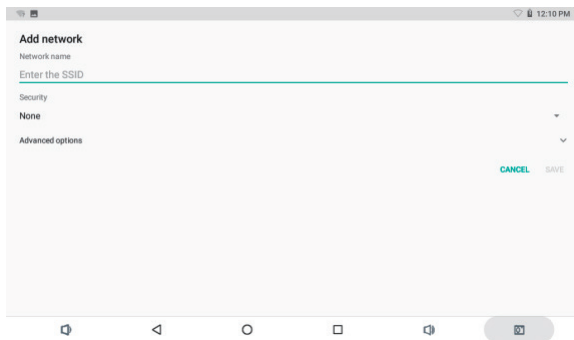

3) Add a Network

Press the “Add” button in the Wi-Fi screen to add a network. Input the SSID, choose the security, then input the password.



OPTIONAL CONNECTIONS

Connecting to a Computer

1. Connect your tablet to the computer. With the included USB cable, plug the small end of the cable into the USB 2.0 high-speed connector of the tablet. Plug the large end of the cable into an available USB 2.0 high-speed port on the computer.

2. When your tablet is connected, slide up the USB icon right on the screen and then touch the “USB connected” icon.

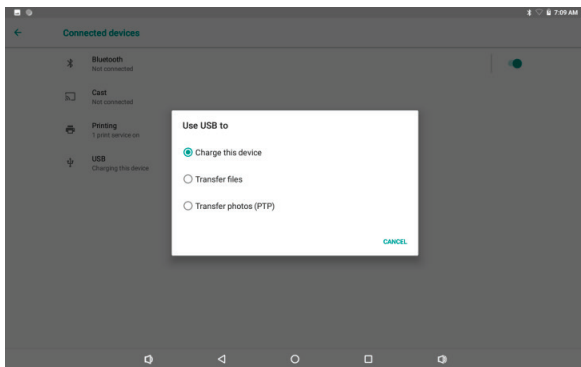

SPECIFICATIONS

- Android Oreo (Go Edition)
- 10.1" 1024 x 600 Screen
- Capacitive Multi-Touch Type
- 1.2GHz Quad-Core Processor
- 1GB RAM
- 16GB of Built-in Storage
(formatted capacity will be less)
- WiFi 802.11 b/g/n+
- 0.3MP Front Camera
- Micro SD Card Slot - Up to 64GB
- USB Connection
- Bluetooth 4.0

CUSTOMER SERVICE

Visit **ematic.zendesk.com** for customer support regarding your device. To submit a request, fill out the required information online. You will be provided a ticket number regarding your issue which you can refer to when contacting us further.

You can also reach an Ematic customer service representative by calling: 1-888-968-1985.

We are open Monday - Friday 9 AM - 5 PM PST, except weekends and major holidays. Ematic strongly urges customers to email their inquiry before calling, as this will enable us to better assist you.

Our email address is: **customerservice@ematic.us**

Please make sure to include the model number and brief description of the problem you are encountering.

Thank you for purchasing an Ematic product.



©2018 Ematic. All Rights Reserved. The Android robot is reproduced or modified from work created and shared by Google and used according to terms described in the Creative Commons 3.0 Attribution License. This device complies with part 15 of the FCC Rule. Operation is subject to the following two conditions: (1) this device may not cause harmful interference, and (2) this device must accept any interference received, including interference that may cause undesired operation. Micro SD card not included. 1 year limited warranty from date of purchase, 90 days only on labor.

FCC Caution:

This device complies with part 15 of the FCC Rules. Operation is subject to the following two conditions: (1) This device may not cause harmful interference, and (2) this device must accept any interference received, including interference that may cause undesired operation.

Any Changes or modifications not expressly approved by the party responsible for compliance could void the user's authority to operate the equipment.

Note: This equipment has been tested and found to comply with the limits for a Class B digital device, pursuant to part 15 of the FCC Rules. These limits are designed to provide reasonable protection against harmful interference in a residential installation. This equipment generates uses and can radiate radio frequency energy and, if not installed and used in accordance with the instructions, may cause harmful interference to radio communications. However, there is no guarantee that interference will not occur in a particular installation. If this equipment does cause harmful interference to radio or television reception, which can be determined by turning the equipment off and on, the user is encouraged to try to correct the interference by one or more of the following measures:

- Reorient or relocate the receiving antenna.
- Increase the separation between the equipment and receiver.
- Connect the equipment into an outlet on a circuit different from that to which the receiver is connected.
- Consult the dealer or an experienced radio/TV technician for help.

The device has been evaluated to meet general RF exposure requirement. The device can be used in portable exposure condition without restriction.