

Acclarix AX3 Series

Diagnostic Ultrasound System

Version 1.1

User Manual

Basic Volume

CE₀₁₂₃



About This Manual

P/N:01.54.458117

MPN: 01.54.458117011

Release Date: **March, 2019**

© Copyright EDAN INSTRUMENTS, INC. **2018-2019**

This User Manual applies to 1.0X releases for Acclarix AX3 series Diagnostic Ultrasound Systems including Acclarix AX3, Acclarix AX3 Exp, Acclarix AX3 Super, Acclarix AX25, Acclarix AX28, Acclarix AX2, Acclarix AX2 Exp, Acclarix AX2 Super, Acclarix AX15 and Acclarix AX18. See Appendix A.9 for the difference between these models.

This User Manual Basic Volume together with the User Manual Advanced Volume (P/N:01.54.458118) contain necessary and sufficient information to use the Acclarix AX3 series Diagnostic Ultrasound Systems safely for the intended purposes and approved clinical applications.

Please read and make sure you understand all of the instructions in this manual prior to using the system. Disregarding instructions, particularly warnings and cautions, is considered abnormal use.

Not all measurements and features are available for all system models and configurations. This manual is based on the complete set of transducers and features available. Therefore, some of the contents may not apply to your product. If you have any questions, please contact your local EDAN representative. **The pictures and interfaces in this manual are for reference only.**

Conventions

In this manual, the following conventions are used to describe the system for better understanding:

- ***Bold***: bold texts indicate keys or items on main screen or touch screen.
- ***<Bold>***: bold texts in angular brackets indicate buttons, knobs and other controls on the console or on the keyboard.
- ***->***: Arrow indicates operations following the path.

Contact Information

For sales or service information, please contact your local distributor or the EDAN Service Department at: support@edan.com.cn

Contents

1	Introduction	1
1.1	Intended Use/ Indications for Use	1
1.2	Contra-indications	1
1.3	Device Description	1
2	Safety	2
2.1	Warnings	2
2.2	Cautions	4
2.3	Labeling Symbols	7
3	Getting Started	10
3.1	System Configuration	10
3.2	System Overview	12
3.2.1.	Main Unit	12
3.2.2.	Control Panel	15
3.2.3.	Screen Layout	18
3.2.4.	Touch Screen	21
3.2.5.	Trackball	22
3.3	System Preparation	23
3.3.1.	Battery Use	23
3.3.2.	AC Power Use	24
3.3.3.	Transducer Connection	25
3.3.4.	Powering on/ off	27
4	Exam Operation	28
4.1	How to Start an Exam	28
4.2	How to End an Exam	29
4.3	How to Restart an Exam	29
4.4	The Patient Information Page	29
4.5	Modality Worklist	32
5	Imaging	33
5.1	B-mode	33
5.1.1.	Using B-mode	33
5.1.2.	B-mode Image Optimization	33
5.2	Color Mode	36
5.2.1.	Color Mode Variants	36
5.2.2.	Using Color Mode	36
5.2.3.	Color Image Optimization	36
5.3	PW Mode	39
5.3.1.	Using PW Mode	39
5.3.2.	PW Image Optimization	39
5.3.3.	HPRF	42

5.4 CW Mode	42
5.4.1. Using CW Mode	42
5.4.2. CW Image Optimization.....	43
5.5 M-mode	45
5.5.1. Using M-mode	45
5.5.2. M-mode Image Optimization	45
6 Transducers and Biopsy	47
6.1 Transducers.....	47
6.2 Using Transducers.....	48
6.3 Transducer Cleaning and Disinfecting	51
6.3.1. Cleaning	51
6.3.2. Disinfecting.....	51
6.4 Needle Biopsy Guide.....	54
6.4.1. Installing Needle Guide Bracket	54
6.4.2. Activating Needle Guide Function	58
6.4.3. Calibrating the Needle Guide Line.....	59
6.5 Needle Visualization	60
6.6 Center Line.....	61
6.7 Needle Guide Bracket Cleaning and Sterilization	61
7 Features	62
7.1 Comment.....	62
7.2 Body Mark	64
7.3 Dual Image Display	65
7.4 Zoom	65
7.5 Cine Review	66
8 Measurements and Reports	67
8.1 Generic Measurements	68
8.1.1. B-mode Generic Measurements.....	68
8.1.2. Strip Doppler Generic Measurements	71
8.1.3. M-mode Generic Measurements	75
8.2 Application Measurements	76
8.2.1. Abdomen Measurements.....	77
8.2.2. Gynecology Measurements.....	78
8.2.3. Obstetrics Measurements.....	79
8.2.4. Cardiac Measurements	81
8.2.5. Small Parts Measurements	84
8.2.6. Urology Measurements	84
8.2.7. Vascular Measurements	85
8.3 Worksheet and Report.....	88
8.3.1. Worksheet	88

8.3.2. OB Worksheet	90
8.3.3. Growth Curve	91
8.3.4. Report	93
8.4 Measurement Accuracy.....	95
9 Exam Data Management.....	96
9.1 Storing Images	96
9.2 Reviewing Images	97
9.3 Exam Database.....	99
9.4 Archiving Studies.....	100
10 Presets.....	101
10.1 Preset Organization.....	101
10.2 Selecting a Preset	102
10.3 Storing and Editing a Preset.....	102
10.3.1. Exam Preset.....	103
10.3.2. Image Preset.....	104
10.3.3. Comment Preset	105
10.3.4. Body Mark Preset.....	106
10.3.5. Measure Preset.....	107
11 Utilities.....	109
11.1 System Set-up	109
11.1.1. General Set-up	109
11.1.2. Patient Set-up.....	111
11.1.3. Store/Print Set-up	112
11.1.4. Report Set-up	113
11.1.5. Image Set-up	114
11.2 Connectivity	115
11.2.1. TCP/IP	115
11.2.2. DICOM.....	116
11.3 Maintenance	118
11.3.1. License	118
11.3.2. Version.....	119
11.3.3. Demo	119
11.3.4. Tool.....	120
11.4 Screen Adjust.....	120
12 In Between Exams	122
12.1 Unpacking	122
12.2 Transport.....	122
12.3 Storage.....	122
13 Troubleshooting and Maintenance.....	123
13.1 Daily Checklist.....	123

13.2 Troubleshooting.....	123
13.3 Cleaning the System	124
13.4 Maintenance.....	126
Appendix A Specifications.....	127
A.1 Electrical Safety Classifications.....	127
A.2 Power Supply	127
A.3 Machine Specifications.....	128
A.4 Display Specifications	128
A.5 General Specifications	128
A.6 Wi-Fi Specifications.....	129
A.7 Operating, Storage and Transportation Environment	129
A.7.1 Operating Environment.....	129
A.7.2 Storage and Transportation Environment	129
A.8 Transducer Specifications	130
A.9 Configuration Difference.....	130
Appendix B Ultrasound Intensity and Safety	131
B.1 Ultrasound in Medicine.....	131
B.2 Ultrasound Safety and the ALARA Principle.....	131
B.3 Explanation of MI/TI	132
B.3.1 MI (Mechanical Index)	132
B.3.2 TI (Thermal Index)	132
B.3.3 Display of MI/TI.....	133
B.4 Acoustic Output.....	133
B.4.1 Factors that Contribute to Uncertainty in the Output Display	133
B.4.2 Differences between Actual and Displayed MI/TI.....	133
B.4.3 Measurement Uncertainty.....	133
B.4.4 Acoustic Power Default Settings.....	134
B.5 Operator Control Features.....	134
B.6 Prudent Use Statement	135
B.7 References for Acoustic Output and Safety.....	135
B.8 Transducer Acoustic Output Data.....	135
Appendix C Order List.....	136
Appendix D EMC Information	138

1 Introduction

1.1 Intended Use/ Indications for Use

The Acclarix AX3 series Diagnostic Ultrasound System is intended for use by a qualified physician or allied health professional for ultrasound evaluations in hospitals and clinics. General clinical applications include:

- Abdominal
- Gynecology (including endovaginal)
- Obstetric
- Cardiac
- Small Parts (Breast, Testes, Thyroid, etc.)
- Urology
- Musculoskeletal
- Peripheral Vascular
- Adult Cephalic

1.2 Contra-indications

The Acclarix AX3 series Diagnostic Ultrasound System is not intended for ophthalmic use or any use causing the acoustic beam to pass through the eye.

1.3 Device Description

The Acclarix AX3 series Diagnostic Ultrasound System consists of a main system and associated ultrasound transducers.

The system circuitry generates an electronic voltage pulse, which is transmitted to the transducer. In the transducer, a piezoelectric array converts the electronic pulse into an ultrasonic pressure wave. When coupled to the body, the pressure wave transmits through body tissues. The waves are then reflected within the body and detected by the transducer, which then converts the waves back to an electrical signal. The system then analyzes the returned signals and generates an ultrasound image or spectral Doppler display.

The Diagnostic Ultrasound System provides the operator the ability to measure anatomical structures, and offers analysis packages that provide information used by competent health care professionals to make a diagnosis.

The system's user interface provides both hard keys for functions frequently used throughout an exam and touch screen controls for mode-specific functions.

2 Safety

Throughout this document the following terms are used:

- **Warning:** Advises against certain actions or situations that could result in personal injury or death.
- **Caution:** Advises against actions or situations that could damage equipment, produce inaccurate data, or invalidate a procedure.
- **Note:** Provides useful information regarding a function or a procedure.

Please read all warnings and cautions prior to using the system. For your convenience, all warnings and cautions are provided in this section, but may be duplicated elsewhere in this document in the context of the instructions for use.

2.1 Warnings

- Only use Edan supplied power adapter and power cord.
- Only use Edan supplied battery. Read and understand the battery installation instructions prior to changing the battery.
- Only use Edan supplied transducer. Use of other transducers may result in electric shock or system malfunction.
- Only use a hospital grade, grounded, power outlet and plug. Do not use with an ungrounded outlet.
- The system is ordinary equipment (sealed equipment without liquid proof). The transducers (not including transducer connector) is IPX7 certified. The footswitch is IP68 certified. Do not immerse or expose any of the parts to extended moisture. Splash resistance does not extend to transducer connectors. Please keep connectors dry.
- Do not use in a wet environment or when the relative humidity exceeds 95%.
- Do not reverse the positive and negative poles when installing the battery.
- Do not use the battery near heat sources or when the ambient temperature is over 40°C. Do not heat or dispose of in fire.
- Do not destroy the battery; do not pierce or cause a strong impact to the battery.
- Do not touch the connector pins on the transducer port.
- Parts and accessories used must meet the requirements of the applicable IEC/EN60601 series safety standards, and/or the system configuration must meet the requirements of the IEC/EN60601-1.
- Use protective barriers (gloves and transducer sheaths) whenever possible. Follow sterile procedures when appropriate. Thoroughly clean transducers and reusable accessories after each patient examination and disinfect or sterilize as needed. Refer to transducer use and care instructions. Follow all infection control policies established by your office, department or institution as they apply to personnel and equipment.
- Not intended for Ophthalmic use.
- If a sterile transducer cover becomes compromised during an intra-operative application involving a patient with transmissible spongiform encephalopathy, such as Creutzfeldt-Jakob disease, follow the guidelines of the U.S. Disease Control Center and this document from the World Health Organization: WHO/CDS/APH/2000/3, WHO Infection Control Guidelines for Transmissible Spongiform Encephalopathies. The transducers for your system cannot be decontaminated using a heat process.

- Contact with natural rubber latex may lead to a severe anaphylactic reaction in persons sensitive to the natural latex protein. Sensitive users and patients must avoid contact with these items. EDAN strongly recommends that health-care professionals identify their latex-sensitive patients, and refer to the March 29, 1991 Medical Alert on Latex products. Be prepared to treat allergic reactions immediately.
- Improper operation may cause the internal lithium battery (hereinafter called battery) to become hot, ignited or possibly explode, and it may lead to decreased battery capacity. It is necessary to read the user manual instructions and warning messages carefully.
- Do not touch accessible contacts of electrical equipment and the patient simultaneously.
- This device is not suitable for intra-cardiac use or direct cardiac contact.
- The system shall not be serviced or maintained while in use during an exam.
- Install the system according the EMC guidance provided in Appendix D.
- Do not stack the system on other electronic equipment.
- The use of transducer and connecting cable not supplied by the manufacturer may result in increased emissions or decreased immunity of the equipment.
- Refer to Appendix D for recommended separation distances from other equipment, including portable and RF communication devices.
- The power adapter is used to isolate the system from main power. Position the system so that it is easy to disconnect it from the power supply.
- No modification of this equipment is allowed.
- The system should be maintained regularly, at least annually, by a qualified technician who has adequate training, knowledge and experience. That person should be familiar with the Service Manual, available from your Edan representative.
- Keep non-medical equipment out of the vicinity of the patient. (1.5m/6ft.)
- Use of an extension cord or multi-socket outlet setup to provide power to the ultrasound system or to the system's peripheral devices, may compromise the system grounding and cause the system to exceed current leakage limits.
- It is not suggested to use a multiple socket-outlet with the device. If one is required, make sure that the multi-socket complies with the requirement specified in Chapter 16 of IEC 60601-1, or the multi-socket is with an isolation transformer. And the multi-socket shall not be placed on the floor.
- SHOCK HAZARD - Don't connect electrical equipment, which has not been supplied as a part of the system, to the multiple portable socket-outlet supplying the system.
- SHOCK HAZARD - Don't connect non-electrical equipment, which has been supplied as a part of the system, directly to the wall outlet when the non-medical equipment is intended to be supplied by a multiple portable socket-outlet with an isolation transformer.
- SHOCK HAZARD – Do not connect non-isolated electrical equipment to the same circuit being used to power the system.
- Edan recommends the use of isolated connectors on any electrical equipment attached to the system, and/or using isolation transformers that comply with IEC60601-1 to power that electrical equipment.
- Always use sterile technique during a biopsy procedure. Sterilize the needle guide assembly between uses.
- Use a sterile needle with each use.
- The system may be interfered with by other equipment, even if that other equipment complies with CISPR EMISSION requirements.
- The system cannot be used together with high-frequency surgical equipment.

- Remove the battery from the device when the device is not used for a long time.

Transducer Warnings

- To avoid infection, always use protective gloves when cleaning or disinfecting
- Read and follow all manufacturer instructions for disinfection agents.
- To avoid infection, ensure that expiration date of the disinfecting solution has not passed.
- Disinfect the transducer after each intra-cavity procedure. Use a new sterile sheath for each such procedure.
- Unplug the transducer from the system prior to cleaning or disinfecting.
- Do not immerse the transducer beyond the point indicated in Figure 6-3.
- Do not allow the transducer connector to get wet.

2.2 Cautions

- The system contains no user serviceable components other than the battery. Do not remove any covers other than the battery cover.
- Excessive dust and dirt could clog internal airflow and cause overheating. Do not use in a dusty environment.
- Do not use a battery that leaks, emits an odor, appears deformed, or discolored. Immediately replace it with a new Edan-supplied battery and dispose of the old battery according to local regulations. Replace a battery that has reached the end of its service life.
- Use care when storing or disposing of batteries. Do not allow the leakage from one battery to come in contact with other batteries. Batteries (including button cell on the main board) are hazardous waste. Do not dispose of them together with household garbage. At the end of their life hand the batteries over to the applicable collection points for the recycling of waste batteries. Inappropriate disposal of waste may contaminate the environment.
- Inspect the system regularly, at least weekly. Before use, ensure there is no visible evidence of damage to the equipment, cables, and transducers. If a component is damaged, replace it before use.
- Do not use in locations subject to vibration.
- Read and understand the section *Appendix B.2 Ultrasound Safety and the ALARA Principle* before using the system. Do not expose a patient to ultrasound energy longer than clinically reasonable.
- Practice ALARA principle when operating ultrasound system. Minimize the acoustic power without compromising the image quality.
- Do not use in the presence of a flammable anesthetic.
- The system generates radio frequency energy, which may cause interference with other devices in the vicinity. If interference is suspected, try re-orienting or relocating the equipment.
- The use of electrosurgical units or other devices that generate radio frequency interference may cause image distortion or other malfunctions.
- During long term storage, the battery should be charged at least once every 3 months to ensure battery capacity.
- The system should only be used by a qualified physician or allied health professional for ultrasound evaluations.
- Use only Edan supplied or recommended parts and accessories.
- Verify measurement results prior to entering them into a report.
- Contact your local distributor or Edan Service if there is excessive noise from the system speaker or fans.

- Please read and understand cleaning instructions prior to use.
- Please read and understand maintenance instructions prior to use.
- Please read and understand instructions for system operation prior to use.
- Studies stored on the system hard drive should be archived regularly. The system is not intended for long term storage of patient information. Confirm successful archiving before deleting a study from the hard drive.
- Ensure that the system vents are clear and unobstructed.
- Confirm patient identification information prior to storing or printing any exam information.
- If you have any questions about maintenance, technical specifications, or system functionality, please contact your local distributor or Edan Service at: support@edan.com.cn
- Ultrasound images occasionally have artifacts, and should only be used as one part of an overall clinical assessment.
- To avoid electrical shock, turn off and disconnect the device from the AC power source before cleaning and disinfecting.
- No user serviceable parts are inside the system. All repairs on the system must be performed by EDAN certified service personnel.
- The device and accessories are to be disposed of according to local regulations after their useful lives. Alternatively, they can be returned to the dealer or the manufacturer for recycling or proper disposal.
- The packaging is to be disposed of according to local or hospital's regulations; otherwise, it may cause environmental contamination. Place the packaging at a location that is inaccessible to children.
- Patient data transmitted by the system is not encrypted. Please ensure the physical security of the network. If WiFi is used, use WPA2 protocol and require a WiFi password.
- Only use upgrade files with known provenance. Confirm that the system boots to imaging after an upgrade.
- Properly dispose of used cleaning agents or disinfectants according to your hospital's regulations.
- The system does not need calibration as part of routine maintenance.

Transducer Cautions

- Do not use disinfection agents beyond their expiration date.
- Do not use sterile sheaths beyond their expiration date.
- Inspect the transducer connector, cable, and head periodically. Do not use if there is evidence of excessive wear or damage.
- Do not operate the transducer to temperatures in excess of 40°C or store the transducer in temperatures in excess of 55°C.
- Do not kink or pull on the transducer cable.
- Broken or bent connector pins can cause image artifacts. Do not use a transducer with broken or bent pins.

Federal Communications Commission (FCC) statement:

This equipment has been tested and found to comply with the limits for a Class B digital device, pursuant to part 15 of the FCC Rules. These limits are designed to provide reasonable protection against harmful interference in a residential installation. This equipment generates uses and can radiate radio frequency energy and, if not installed and used in accordance with the instructions, may cause harmful interference to radio communications. However, there is no guarantee that interference will not occur in a particular installation. If this equipment does cause harmful interference to radio or television reception, which can be determined by turning the equipment off and on, the user is encouraged to try to correct the interference by one or more of the following measures:













- Reorient or relocate the receiving antenna.
- Increase the separation between the equipment and receiver.
- Connect the equipment into an outlet on a circuit different from that to which the receiver is connected.
- Consult the dealer or an experienced radio/TV technician for help.













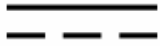

The device has been evaluated to meet general RF exposure requirement. The device can be used in portable exposure condition without restriction.

Any changes or modifications not expressly approved by the party responsible for compliance could void the user's authority to operate the equipment







2.3 Labeling Symbols

The following labels are used on the system:

No.	Symbol	Definition
1		Serial Number
2	<i>P/N</i>	Part Number
3		Date of Manufacture
4		Manufacturer
5		Operating instructions
6		Warning (Background: Yellow; Symbol & outline: Black)
7		Refer to User Manual (Background: Blue; Symbol: White)
8		Caution
9		Biological Risks
10		CE Marking
11		Authorized Representative in the European Community
12		Disposal method. Indicates that the equipment should be sent to special agencies according to local regulations for separate collection after its useful life.
13		General Symbol for Recovery / Recyclable
14	Rx only	Caution: Federal (U.S.) law restricts this device to sale by or on the order of a physician.
15	IPX7	No harm for short time immersion

16		Type BF Applied Part
17		Transducer connector
18		Pencil Transducer connector (reserved)
19		Transducer lock
20		Transducer unlock
21		Network port
22	EDAN	Trademark
23		Direct current
24		S-Video Output port
25		USB 2.0 port
26		USB 3.0 port
27	HDMI	HDMI port
28		AC Power Indicator
29		System Working Indicator
30		Battery Indicator
31		Non-ionizing electromagnetic radiation
32	FCC ID: SMQAX3EDAN	Federal Communications Commission: FCC ID:SMQAX3EDAN

The following labels are used on the packaging:

No.	Symbol	Definition
1		This way up
2		Fragile
3		Keep away from rain
4		General Symbol for Recovery / Recyclable
5		Stacking limit by number
6		Do not step on!
7		Handle with care

NOTE:

The user manual is printed in black and white.

3 Getting Started

3.1 System Configuration

Standard Configuration:

The system is shipped with the following components:

- ◆ 1 main unit
- ◆ 1 AC adapter
- ◆ 1 power cord
- ◆ 1 rechargeable lithium battery
- ◆ 1 USB disk
- ◆ 1 bottle of coupling gel
- ◆ 1 basic user manual and 1 advanced user manual
- ◆ 1 packing list

Options:

The following options are also available:

- ◆ Transducers:
C5-2Q, L12-5Q, E8-4Q, P5-1Q, L17-7Q
- ◆ Needle Guide Bracket Kit

Model	Angle/Depth	Description
BGK-C5-2	20° , 28° , 40°	For use with the C5-2Q, Supports: 14G-23G
BGK-L40UB	34° , 43° , 53° , 66°	For use with the L17-7Q, Supports: 14G-23G
BGK-001	1.0cm, 1.5cm, 2.0cm	For use with the L17-7Q, Supports: 21G
BGK-002	38° , 46° , 58°	For use with the L12-5Q, Supports: 14G-23G
BGK-003	1.0cm, 1.5cm, 2.0cm	For use with the L12-5Q, Supports: 21G
BGK-CR10UA	2°	For use with the E8-4Q, Supports: 16G, 18G

Table 3-1 Needle Guide Bracket Kits

- ◆ 2nd rechargeable lithium battery
- ◆ Footswitch
- ◆ Suitcase

Supported Peripheral Accesories:

- ◆ The recommended printers are listed as follows:

Printer Type	Printer Model	Interface
Color Video Printer	SONY UP-25MD	S-Video
	SONY UP-D25MD	USB
B/W Video Printer	SONY UP-X898MD	USB
Report Printer	HP Officejet Pro 251dw	USB
	HP LaserJet Pro 200 color M251n	USB
	HP LaserJet CP1525n Color	USB
	HP Deskjet Ink Advantage 2010	USB
	HP Deskjet 1010	USB
	HP Deskjet 1510	USB
	HP LaserJet 400 M401d	USB
	HP DeskJet Ink Advantage Ultra 2029	USB
	HP DeskJet 1112	USB
	Canon E518	USB
	Canon iP2780	USB
	HP LaserJet Pro MFP M126nw	USB
	EPSON L310	USB
	HP DeskJet 1050	USB
	HP DeskJet 2050	USB
	HP LaserJet M252n	USB
EPSON L130	USB	

Table 3-2 Printer List

WARNING

Only the recommended printers listed above are verified by EDAN. Therefore, it is suggested to only use these printers. Use of other printers should comply with IEC 60950 or IEC 60601-1. Edan is not responsible for the accuracy of other printers.

3.2 System Overview

3.2.1. Main Unit

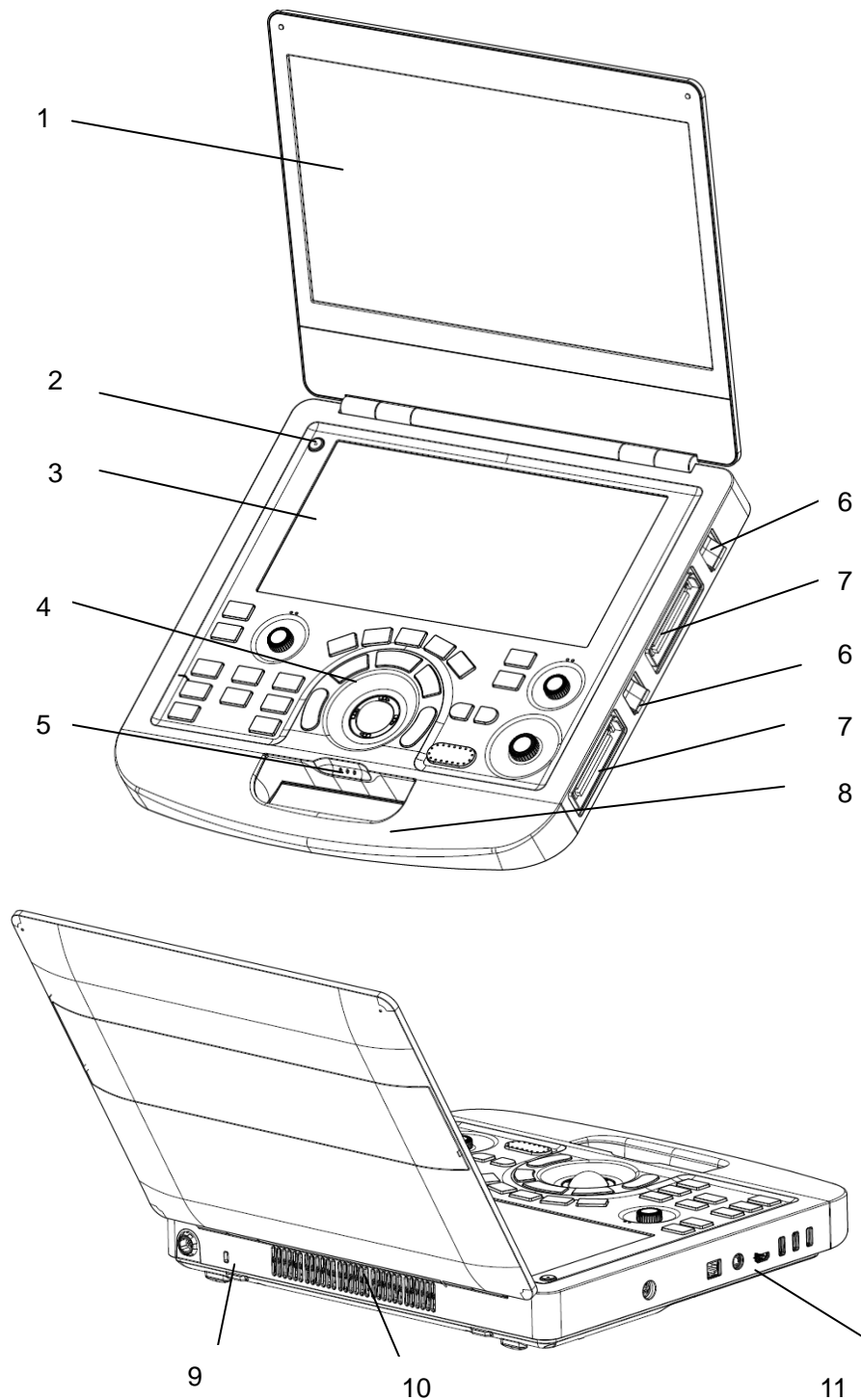

Figure 3-1 Main Unit



No.	Name	Description
1	Monitor	Display the images and parameters during scanning.
2	Power Switch	Power on/off the system.
3	Touch Screen	Use to control operation and activate functions.
4	Control Panel	Use to control the operation .
5	AC Power Indicator 	It illuminates when the system is connected to AC power. It is off when the system is no connected to AC power
	System Working Indicator 	It illuminates when system is running, and it is off when the system is shutdown.
	Battery Indicator 	It is off when no battery is connected or battery is fully charged. It illuminates in orange when battery is low. It illuminates in green when the system operates on battery power or the battery is charging.
6	Transducer Locking Lever	Use to lock or unlock the transducer.
7	Transducer Port	Used for connecting a transducer to the system.
8	Handle	Used for carrying the system.
9	Safety Lock Connector	Used for connecting a safety lock to the system.
10	Vents	Used for heat dissipation and ventilation.
11	I/O Ports	Use to connect the I/O extend modules.

Table 3-3 Main Unit Description

CAUTION

1. Ensure system vents are clear and unobstructed. Bad ventilation will result in high system temperature. When the high temperature warning "System Temperature is High. Please check the system for good ventilation" displays, refer to section 13.2 Troubleshooting for the specific troubleshooting steps.
2. Excessive dust and dirt could clog internal airflow and cause overheating. Do not use in a dusty environment.

I/O Ports on the left panel:

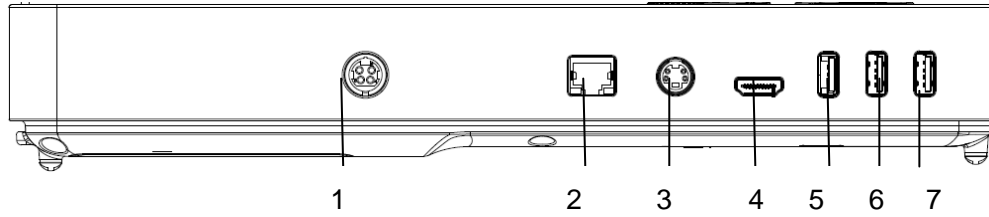

Figure 3-2 I/O ports

1.	Power supply	2.	Network port
3.	S-Video output port	4.	HDMI port
5.	USB 3.0 port	6.	USB 2.0 port
7.	USB 2.0 port		

Table 3-4 I/O Ports

Caution

1. The HDMI port does not support "hot plug" feature. Please connect the external display to the HDMI port before starting the ultrasound system. Otherwise the external display may be unrecognized or display abnormally.

3.2.2. Control Panel

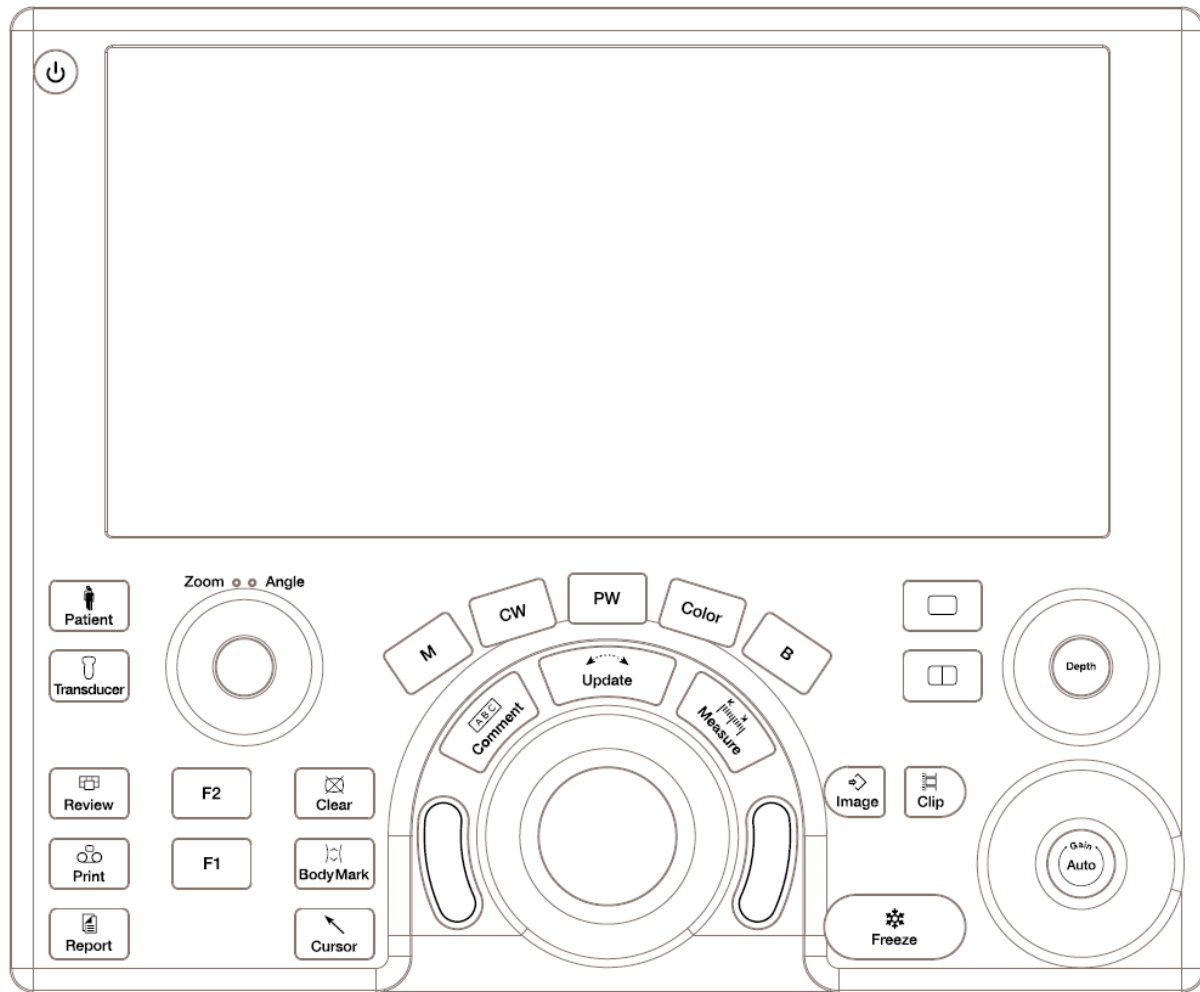







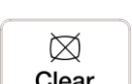

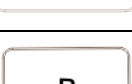

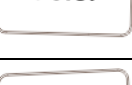
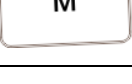











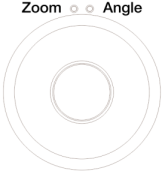

Figure 3-3 Control Panel

No.	Key	Name	Description
1.		Power switch	Press to power on/off the system
2.		Patient	Invokes the Patient Information Screen typically used to start/end exams or to modify patient information during an exam. See section 4.1.
3.		Transducer	Press to switch transducers or exam presets.
4.		Review	Press to enter exam database or image review mode. See section 9 for details.
5.		Print	Press to print images via the connected video printer.

6.		Report	Press to display the report page.
7.		F1	User-defined button
8.		F2	User-defined button
9.		Clear	Press to clear all the measurements, calculations, comments, and body marks displayed on the current image.
10.		Body Mark	Enters or exits the Body Mark function. See section 7.2 for details.
11.		Cursor	Press to hide or display the mouse cursor.
12.		B	Press to return to B-mode imaging from any other imaging modes. See section 5.1 for details.
13.		Color	Press to enter or exit Color Mode. See section 5.2 for details.
14.		M	Press to enter or exit M Mode. See section 5.5 for details. Use the trackball to adjust the M sample line.
15.		PW	Press to get the sample line. Use the trackball to adjust the position of the sample line. Press it again to display the Doppler strip. See section 5.3 for details.
16.		CW	Press to get the sample line. Use the trackball to adjust the position of the sample line. Press it again to display the Doppler strip. See section 5.4 for details.
17.		Comment	Enters or exits the Comment function. See section 7.1 for details.
18.		Measure	Invokes the Measure function for Generic and Application Measurements. See section 8 for details.
19.		Single	Press to display the currently active side of Dual image as a single image. See section 7.3 for details.

20.		Dual	Enters dual split screen. Each single press on it toggles between two images. See section 7.3 for details.
21.		Store Image	Press to store static images.
22.		Store Clip	Press to store clips.
23.		Freeze	Press to switch between the frozen and real-time states.
24.		Update	In measurement, pressing <Update> switches the active side of calipers. See section 8 for details. When Spectral Doppler strip is displayed, pressing <Update> allows switching between live acquisition of the Doppler strip or the reference image.
25.		Trackball	Move the trackball to change the cursor position, adjust M mark position in M mode, adjust sample line position in PW mode, etc.
26.		Trackball keys	Two trackball keys provide a wide variety of functions depending on the system state (e.g., selects a start or end point of a measurement, selects menu items on the screen, etc). For the convenience of introduction, we call them <Set> throughout this user manual.
27.		Zoom/Angle	The functions of this knob vary with system functions. When one function is activated, its indicator illuminates. Then rotate to zoom an image or adjust the angle. For example: In B and Color mode, the Zoom function is auto activated and its indicator illuminates. Rotating the knob will zoom images. In PW or CW mode, the Angle function is auto activated and its indicator illuminates. Rotating the knob will adjust the Doppler scale to account for the angle between the Doppler cursor and the blood flow. When Comment or Body Mark function is enabled, the Angle function is auto activated and its indicator illuminates. Rotating the knob will adjust the angle of comment arrow or the transducer icon.



28.		Depth	Rotate to adjust the depth of the image displayed.
29.		Auto/Gain	Press to optimize B image automatically. Rotate to change the gain of images.

Table 3-5 Buttons on Control Panel

3.2.3. Screen Layout

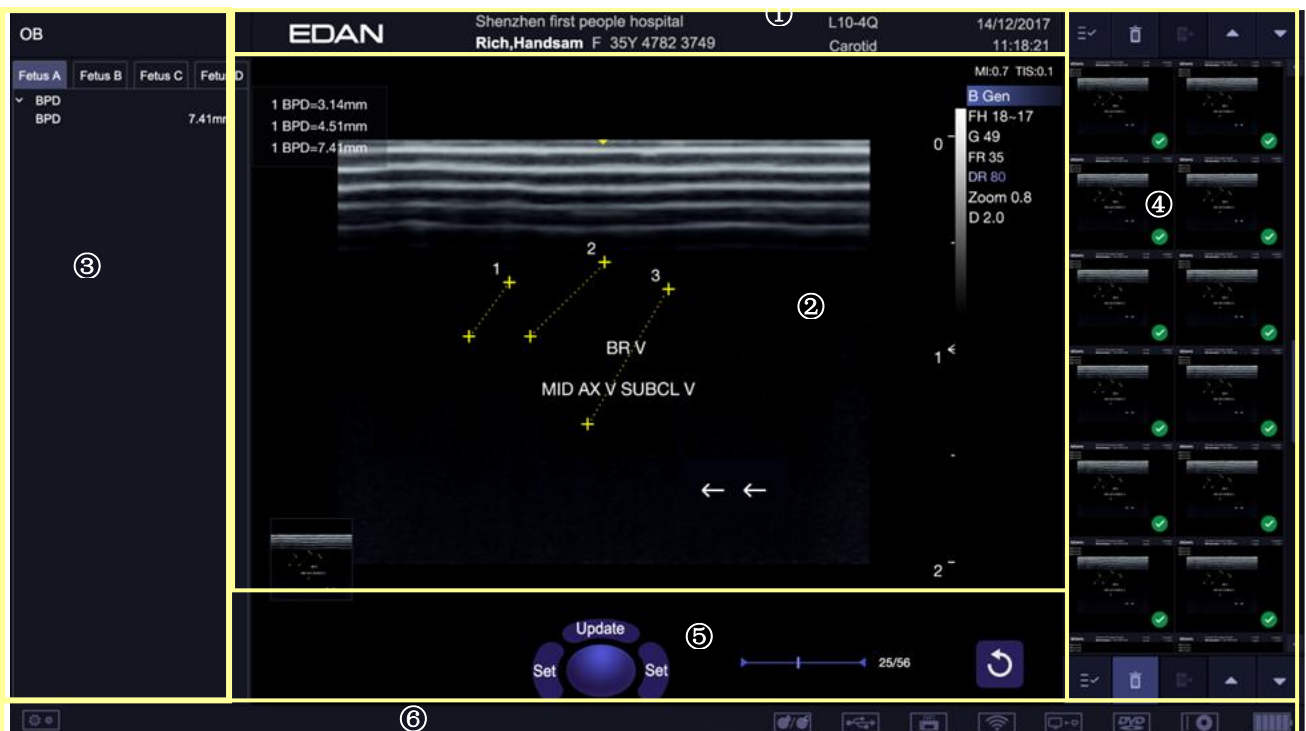

Figure 3-4 Main Screen Display

① Information Field

The top line of this field contains your hospital/institution name. Please see Section 11.1.1 *General Set-up* for information on customization.

The second line of this field contains the patient name, gender, age and ID, as entered through the Patient Information screen.

This field also contains data fields for:

- The currently active transducer
- The currently active preset
- System date and time.

② Image Field





The ultrasound image appears in the Image field, under the Information field. The Image field also contains information typically associated with the image, such as depth, TGC, maps, image parameters, MI and TI.

③ **Mini Report**

The left side of the screen displays a “mini-report” which displays measurements performed during the current exam.

④ **Thumbnail Field**

The right side of the screen displays thumbnail images of all statics and clips captured for currently active exam or when in Review. This field also contains several shortcut keys for selecting, viewing, deleting, exporting images. See the below for details:

No.	Shortcut Keys	Description
1	 Select All	Selects all the displayed static images and clips.
2	 Delete	Deletes the selected static images and clips.
3	 Export	Exports the selected static images and clips to removable storage devices.
4	 Page Up	Turns the page up when more than one page of images are displayed.
5	 Page Down	Turns the page down when more than one page of images are displayed.





⑤ **Soft Keys Field**





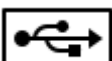

The soft keys field is displayed below image field and above status bar. This field displays:





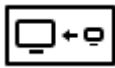

- The illustration of trackball and trackball keys.
- Cine bar when the system is frozen.
- An "Exit" icon . Only displayed in review mode. Clicking on this icon will exit the review mode.

⑥ **Status Bar**

The bottom of the screen is used to display icons that provide system status. These include:

No.	Icons	Description
1	Utility icon 	Provides access to system setup, screen adjust, connectivity, maintenance, etc.
2	Image Store icon 	Displays the number of static images and clips stored in the current exam.
3	USB icon 	USB disk available.
4	Printer icon 	Printer available. Symbol is in green when printing in progress.

5	Wi-Fi icon		<p>Wi-Fi function is enabled, but no WI-FI network is connected.</p> <p>No WI-FI icon will be displayed when Wi-Fi function is disabled in Connectivity setup.</p>
			<p>Wi-Fi network is connected.</p> <p>Clicking on this icon shows a list of available Wi-Fi networks. Selecting an available network displays a dialog box for entering password. Clicking on the "WiFi: Turn off" button above the list will disconnect the currently connected WI-FI network.</p>
			<p>Wi-Fi network is disconnected.</p> <p>Clicking on this icon shows a "WiFi: Turn on" button. Clicking on this button shows a list of available Wi-Fi networks. Selecting an available network displays a dialog box for entering password.</p>
6	Network Transfer Status icon		<p>The network transfer status icon shows the transfer statuses of the DICOM network.</p> <ul style="list-style-type: none"> • Outline in grey color: At least one DICOM network is configured for file transfer. • Outline in green color: Data exchange with a DICOM Server. • Outline in red color: No DICOM network is configured for file transfer. <p>Clicking on this icon displays a queue of exam or image transfers and as well as the transfer status of each exam or image including refused, pending, active, succeeded and failed.</p>
7	Hard Drive icon		Hard drive available.
			Hard drive data exchange, symbol in green.
			Hard drive 95% full, symbol in red.
			Hard drive 95% full with data exchange, symbol in red.

8	Battery icon		Battery fully charged, symbol in green.
			Battery more than 80% charged.
			Battery 60%-80% charged.
			Battery 40%-60% charged.
			Battery low, symbol in red.
			Battery removed.
			Battery charging.

3.2.4. Touch Screen

The Touch Screen contains controls that vary depending on the active imaging mode or function. There are several types of controls used by the touch screen, as illustrated below:

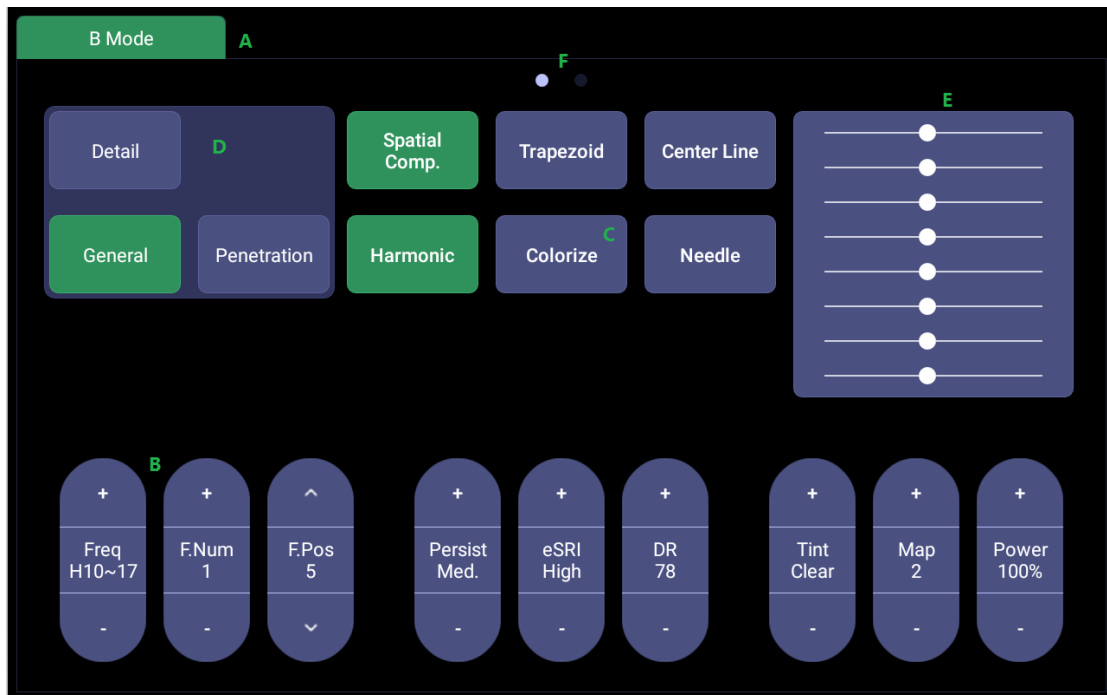

Figure 3-5 Touch screen of the System

- A. **Tabs:** Each imaging mode that is active has a tab at the top of the touch screen. Usually, the imaging mode that was most recently activated is the top tab and has priority. Pressing on any other tab will bring it to the top and provide access to the controls available for that imaging mode.
- B. **Paddle:** Pressing on the top or bottom of a paddle changes the control setting by one value. Pressing anywhere on the control and swiping across it will continuously change the value.
- C. **Push button:** This can either be an on/off control (like “Colorize”).
- D. **Radio Buttons:** A collection of buttons where only one is active at any time. Activating one will

de-activate all others.

- E. **TGC:** The B-mode tab has a specialized control for TGC. Each slider can be dragged horizontally and individually. Dragging vertically down across the sliders will set all sliders.
- F. **Pages:** When a tab has multiple pages of controls, each page is represented by a dot at the top of the page. The current page is indicated by a filled-in dot. You can move between pages by dragging your finger horizontally across the dots. These dots do not appear when there is only one page in the current tab.

3.2.5. Trackball

The trackball operation is easy and convenient. It can achieve the following functions:

- ◆ Move the measurement cursor during measurement.
- ◆ Move the comment cursor in the comment status.
- ◆ Move the M Mark in the B+M mode.
- ◆ Move the scan area of Color mode, increase or decrease the size of scan area of Color mode.
- ◆ Move the sample line in the PW/CW mode.
- ◆ Realize single frame playback in the frame-by-frame playback status.
- ◆ Move the zoomed window in the zoom status.

NOTE:

1. Please be gentle when running the trackball.
2. Please keep the surface of trackball clean.

3.3 System Preparation

3.3.1. Battery Use

The system may come with two lithium-ion batteries depending on your order. One fully charged battery can run the system for approximately 1 hour and two fully charged batteries together can run the system for approximately 2 hours, depending on use. The batteries are automatically charged when the system is plugged in.

The system has two battery compartments which are identified by letter A and B respectively. The battery icon of the battery which is installed in battery compartment A is displayed with letter A on it and the battery icon of the battery which is installed in battery compartment B is displayed with letter B on it.

CAUTION

1. If the system will remain unused for more than one week, charge the battery to at least 75% capacity, take the battery out and store the system and battery separately.
2. During long term storage, the battery should be charged at least once every 6 months to ensure battery capacity is more than 75%.
3. Only use Edan supplied battery.

To install the battery:

1. Turn off and unplug the system.
2. Close the monitor, turn the system upside down and rest it on a flat stable surface.
3. Unscrew the three screws securing the battery door, and remove the battery door.

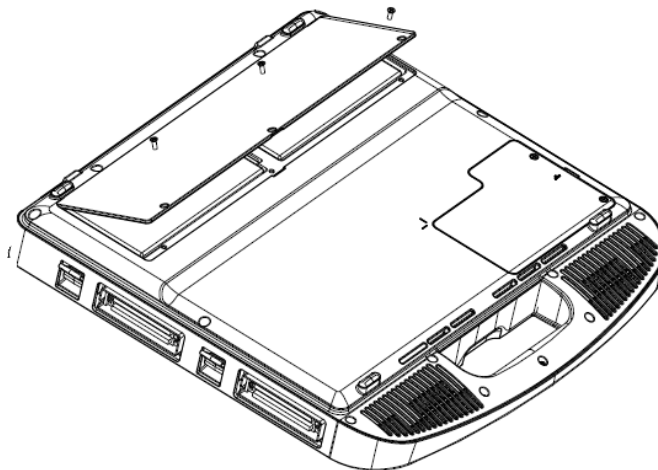

Figure 3-6 Removing battery door.

4. Put the battery gently to battery compartment.

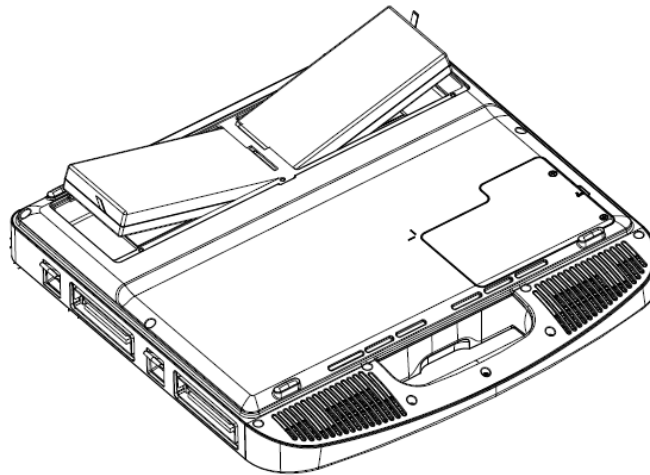

Figure 3-7 Installation of the Battery

5. Close the battery door and screw the three screws.

To remove a battery:

1. Turn off and unplug the system.
2. Close the monitor, turn the system upside down and rest it on a flat stable surface.
3. Unscrew the three screws securing the battery door, and remove the battery door.
4. Remove the battery.
5. Close the battery door and screw the three screws.

WARNING

1. When the battery capacity is $\leq 20\%$, the battery status icon turns red.
 2. When the battery capacity is $\leq 10\%$, the system displays a prompt "Low Battery. The system will shutdown in 3 mins. Please plug in the power supply immediately."
-

3.3.2. AC Power Use

When using AC power, position the system so that it is easy to disconnect it from AC power supply.

To connect AC power:

1. Connect the AC power cord with the power adapter.
2. Connect the DC power cord from the power adapter to the power connector on the system. Make sure the side with a "Direction Indicating Dot" should face upside when connecting the DC power connector, as the illustration below.

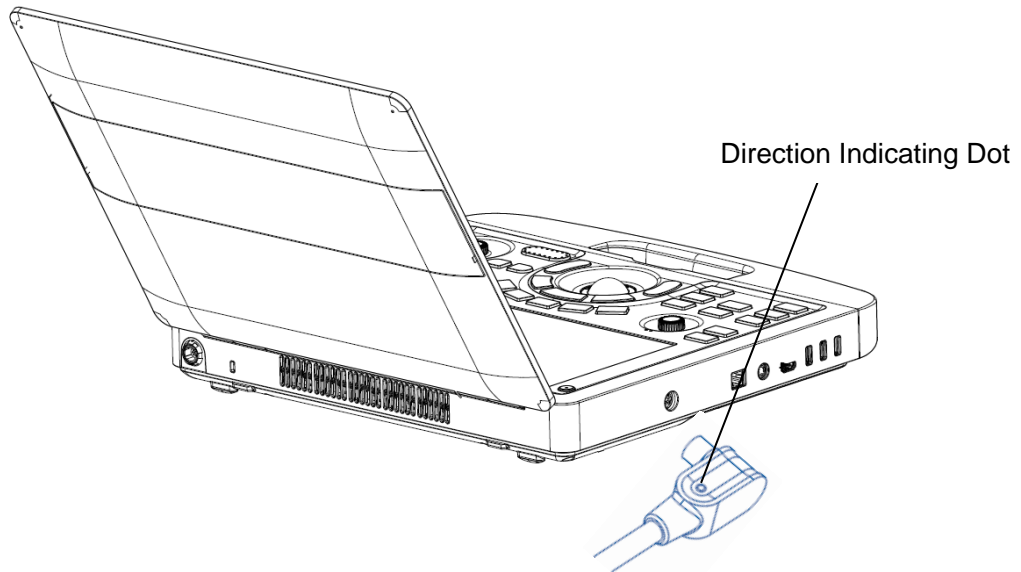

3. Push the power cord in firmly to ensure a secure connection.
4. Connect the AC power cord to a hospital-grade power outlet.

WARNING

1. Make sure the AC power supply complies with the following specifications: 100V-240V~, 50Hz/60Hz.
 2. Only use a hospital grade, grounded, power outlet and plug. Do not use with an ungrounded outlet.
 3. Only use Edan supplied power adapter and power cord.
-

3.3.3. Transducer Connection

To connect a transducer:

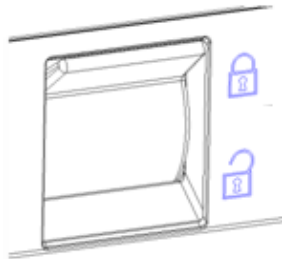

Figure 3-8 Transducer Locking Handle

1. Align the connector with the transducer port and carefully push into place.
2. Toggle the locking handle to the top position.
3. Do not allow the transducer head to hang free. Impact to the transducer head could result in irreparable damage.

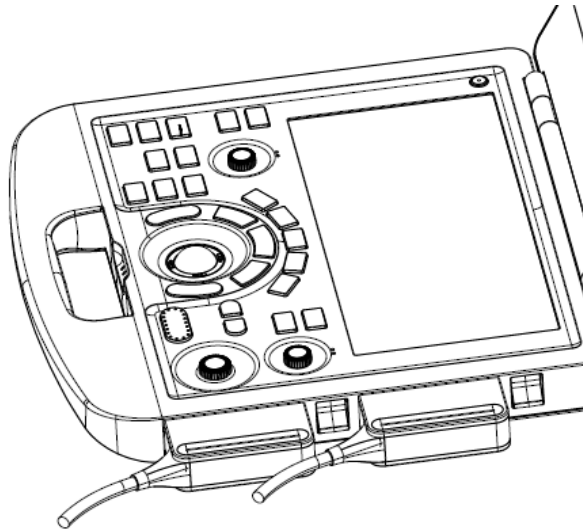

Figure 3-9 Lock the transducer locking handle

To disconnect a transducer:

1. Toggle the locking handle to the bottom position to unlock the transducer connector.
2. Firmly grasp the transducer connector and carefully remove it from the system port.
3. Store transducer in its protective carrying case prior to transport.

CAUTION

1. Do not touch the pins of the transducer connector.
 2. Broken or bent connector pins can cause image artifacts. Do not use a transducer with broken or bent pins.
 3. Only disconnect a transducer when the system is shutdown or is frozen.
-

3.3.4. Powering on/ off

To power on:

1. Connect the system to a hospital grade power supply, or use the battery as the power supply.
2. Press the Power on/off key on the top left of the control panel.

To power off:

1. Press the Power on/off key on the top left of control panel and the system displays a confirmation dialog box.
2. Select "Shut Down" from the confirmation dialog box.

If the system is unresponsive, a long press of the Power on/off key will shut down the system directly.

NOTE:

1. Turn off and unplug the device after use.
2. Please unplug the AC adapter from the power socket and disconnect the battery prior to storage.

Sleep mode

The system will enter a sleep mode that maintains exam information while using minimal power. There are three events that can invoke sleep mode:

- Close the cover of the system without powering-off the system.
- No user input for a configurable amount of time. Please see System Set-up to configure this time.
- Pressing the **Sleep** button on the confirmation dialog box when powering off.

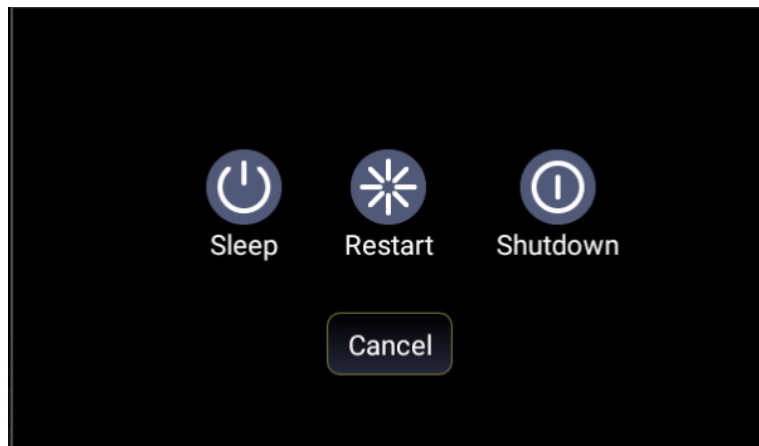

Figure 3-10 Confirmation Dialog Box When Power off

There are two events that can exit sleep mode:

- Open the cover of the system.
- Press the Power on/off key.

4 Exam Operation

4.1 How to Start an Exam

1. Press the **<Patient>** key and enter patient information, or select a scheduled patient from the modality worklist.

If there is no previous exam, pressing the **<Patient>** key will bring you directly to the Patient Information Page (see figure 4-2 below).

If a previous exam is still active you will see the following dialog:

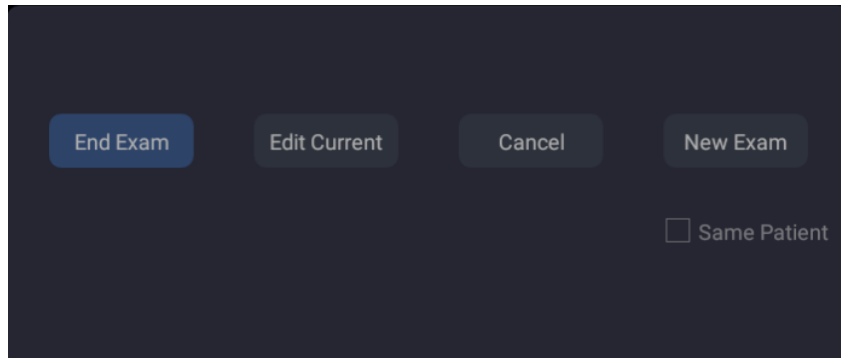

Figure 4-1 Exam Confirmation Dialog

The following options are available:

- **End Exam:** select this to end the current exam and return to live imaging to start a new exam.
 - **Edit Current.** This lets you edit the Patient Information for the current exam. It does not start a new exam.
 - **New Exam:** Select this to start a new exam.
If **Same Patient** is checked, selecting **New Exam** will end the previous exam and create a new exam for the same patient. The main screen will display the Patient Information Page with the previously entered patient information except for the exam accession number. Changing the patient information for one exam will not impact the others.
If **Same Patient** is unchecked, selecting **New Exam**, a blank Patient Information Page will be displayed for entering patient information for a new patient.
Tick the check box of **Same Patient** when operating multiple exams for same patient.
 - **Cancel:** Exits the dialog without starting or ending an exam.
2. Press **OK** on the touch screen or press the **<Patient>** key again to start scanning.
 3. To change transducer or exam preset, press the **<Transducer>** key, and then the **Transducer** touch screen provides you choices of available transducers and exam presets, as the figure below.



Figure 4-2 Example of Transducer Touch Screen

4.2 How to End an Exam

There are two ways to end an exam:

- Pressing the **<Patient>** key, as described above, and then selecting **New Exam**. This both ends the exam and displays the Patient Information Page for the next exam.
- Pressing the **<Patient>** key, as described above, and then selecting **End Exam**. This brings up a dialog to confirm you want to end the exam, but does not invoke the Patient Information Page for the next exam.

4.3 How to Restart an Exam

1. Select an exam from the Exam Database within the time limit selected in **Patient Set-up** menu. For the setting of time limit, refer to section *11.1.2 Patient Set-up*.
2. Press **Restart** on the touch screen to continue/edit the exam that was performed on the selected patient. You can also modify the patient information by pressing **<Patient>-->Edit Current**.

4.4 The Patient Information Page

The Patient Information Page is used to enter or modify patient demographic data. The following figure is an example:

Figure 4-3 Patient Information Page(OB Exam)

The top three lines are for entering the patient last name, first name, ID, exam accession number, and DOB (Date-of-Birth) or age. If date of birth is entered, the age is automatically calculated.

Note:

By default, the patient name has two fields: family name and given name. It can be configured to be one field in the Patient Setup screen (See section 11.1.2 for detail).

The next line displays tabs of multiple exam presets, and the associated patient information fields are displayed below this line. The patient information needed to fill in changes with different exam presets.

All the possible patient information fields you may need to fill in are listed below:

- Gender: Select the patient's gender: "M" (Male), "F" (Female), "O" (Other), or "<blank>".
- LMP: Last Menstrual Period (yyyy/mm/dd or mm/dd/yyyy), If LMP is entered then GA and EDD are calculated. Entering EDD does not impact LMP. An LMP more than 300 days ago is considered invalid.
- GA: Gestational Age (xxWyD), it is autocalculated when LMP or EDD is entered (only in OB Exam). A GA of more than 42W6D is considered invalid and not displayed.
- EDD: Estimated Date of Delivery (yyyy/mm/dd or mm/dd/yyyy).EDD is autocalculated when LMP is entered.
- Fetus: Enter 1 up to 4 for multiple gestations.
- G/P/A: G stands for Gravida, P stands for Para and A stands for Aborta. Enter values for each in the fields separated by slashes.
- Study Description: enter the study description.
- Height: Enter the patient's height. The units can be set in the Patient section of Setup.

- Weight: Enter the patient's weight. The units can be set in the Patient section of Setup.
- BSA: Body Surface Area, it is auto-calculated and displayed when Height/Weight is entered.
- HR: Enter the Heart Rate.
- BP: Enter the Blood Pressure.
- PSA: Prostate Specific Antigen.
- PPSA Coefficient: Predicted Prostate Specific Antigen.
- Ref. Physician: Enter the name of the Ref.Physician.
- Dx. Physician: Enter the name of the Dx.Physician.
- Operator: Enter the name of the person performing the exam..
- CPT code: Current Procedural Terminology code.
- Comment: Enter any additional comments.

While the Patient Information Page is displayed the following buttons are displayed on the touch screen and Patient Information Page:

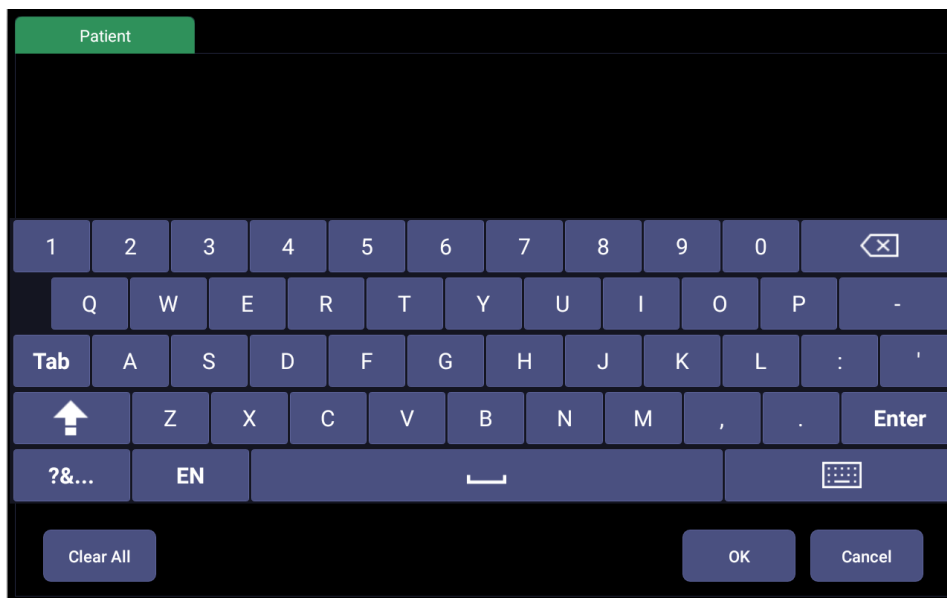

Figure 4-4 Patient Information Touch Screen

Press **OK** to exit the Patient information Page and save the patient information.

Press **Cancel** to exit the Patient Information Page without storing any of the entered data.

Press **Clear All** to clear all of the demographic fields except for name and ID.

4.5 Modality Worklist

Modality worklist provides a list of scheduled patients derived from a DICOM server. It is available only when a DICOM server is configured and worklist is enabled.

When the modality worklist function is enabled and configured in DICOM connectivity setup screen, the worklist is shown to the left of the Patient Information Page, as shown below.

The screenshot displays the 'Modality Worklist' interface. On the left, there is a list of patients with columns for 'Patient Name' and 'Patient ID'. The right side features a detailed form for patient information, including fields for Last Name (YU), First Name, ID, Accession, DOB (MM/DD/YYYY), Age (Years), Gender, LMP, GA, EDD, G/P/A, Fetus, Height (cm), Weight (Kg), BSA (m²), Study Description, Ref. Physician, Dx. Physician, Operator, and Comment. At the bottom, there are buttons for 'Filter', 'Hide List', 'Update', 'Clear All', 'Cancel', and 'OK'. The top right corner shows the date and time: 12/12/2018 02:47:05.

Figure 4-5 Modality Worklist Display

The worklist is displayed on the left side of the Patient Information Page in two columns labeled patient name and patient ID. Clicking on the header of each column will sort the list for the corresponding column.

The worklist shows all scheduled ultrasound exams within the date-range specified in the DICOM connectivity setup screen (See 11.2.2). Typing any text in the **Filter** field will filter the list to exams that contain the entered text.

Update: Press to query the patient data and update the list manually.

Hide List: Press to hide the list with only a **Show List** button displayed. Press the **Show List** button to display the list and other buttons.

Select one patient from the list and the detailed patient information is entered into the associated fields on the patient information page, with the option to edit or complete. Then press **OK** on the touch screen to start an exam.

5 Imaging





5.1 B-mode





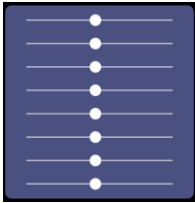

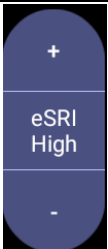
5.1.1. Using B-mode

1. Press on the console to enter B mode.
2. Perform the image scanning.
3. Adjust Image parameters to optimize the image.

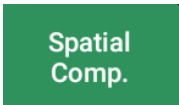
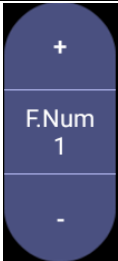
5.1.2. B-mode Image Optimization

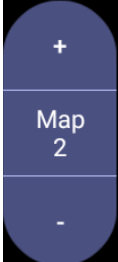
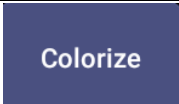
The following touch controls can be used to optimize the B-mode image.

Name	Control	Description
TGC		The Time Gain Compensation control (TGC) adjusts the gain of the image at different depths. Each slider can be adjusted separately, or you can drag your finger vertically to adjust all sliders to a new setting.
Dynamic Range		The Dynamic Range, or log compression, adjusts how echo intensities are converted to brightness. A high dynamic range will display more shades of gray, while a low dynamic range will display fewer shades of gray and a more contrasty image.
eSRI		eSRI is Speckle Reduction Imaging. There are 4 levels: Off, Low, Med. and High. High level provides more aggressive speckle reduction.
Persistence		Persistence averages frames together to reduce random noise. There are 4 options: Off, Low, Med., and High. The persistence level corresponds to the number of frames averaged. The frame rate is unchanged.
Frequency		Frequency allows selection of the fundamental or harmonic frequencies used for imaging. The Harmonic option must be invoked to access the harmonic frequencies. Frequency selection is available during live imaging.

Harmonic		The Harmonic control invokes and exits harmonic imaging. While in harmonic imaging the control is highlighted and an 'H' is displayed in the B-mode frequency field. Depending on the transducer, there may be multiple harmonic frequencies.
Spatial Compounding		Spatial Compounding combines images derived from multiple angles to reduce speckle, reduce shadow artifacts, and enhance contrast resolution. Spatial compounding is an on/off control.
Focus Number		Focus Number adjusts the number of foci is displayed. As the number of foci increases, image uniformity across depth will increase, but the frame rate will decrease.
Focus Position		Focus Position adjusts the depth of the focus or foci. Upward presses move the focus shallower, regardless of the U/D invert status of the image.
Gray Map		Gray Map adjusts the postprocessing map used on the B-mode image. In general, higher map numbers correspond to more contrast in the image.
Colorize		The Colorize control adds a color tint to the B-mode image.
Tint		The Tint control changes the color tint being used. There are 20 tint maps available. If Colorize had been off, changing the Color map control will automatically activate it.
Left/Right		The Left/Right invert control is indicated by a backward R and is used to toggle the left/right orientation of the image. The Edan E orientation marker at the top of the image switches with the left/right invert to match the orientation marker on the transducer.
Up/Down		The Up/Down invert control is indicated by an upside-down R and is used to toggle the up/down orientation of the image. The TGC curve is also re-oriented with Invert On, so that the top of the TGC curve corresponds to the top of the image on the screen.







<p>FOV</p>		<p>The Field of View control adjusts the image width. Full, Large, Med. and Small settings are available. As the image becomes narrower, the frame rate increases.</p>
<p>Steer</p>		<p>The Steer control is only available for linear transducers and steers the B-mode image left or right, without moving the transducer. This function can be particularly useful when visualizing needles or other objects that are enhanced by a perpendicular beam. Steer is not available if Spatial Compounding or Trapezoid are turned on.</p>
<p>Trapezoid</p>		<p>The Trapezoid control activates the trapezoidal imaging on linear transducers. It is a part of the B-mode function and available in live imaging.</p>
<p>Image Type</p>		<p>B-mode supports presets for Detail, General, and Penetration. See section 10.3.2 for more information.</p>
<p>Line Density</p>		<p>Adjusts the line density to optimize the lateral resolution for the best possible image. The higher the line density, the higher the lateral resolution, but the lower the frame rate.</p>
<p>Needle</p>		<p>Press to invoke the touch screen for Needle Enhancement Visualization and Needle Biopsy Guide functions. See section 6.4 and 6.5 for more information.</p>
<p>Acoustic power</p>		<p>Adjusts the acoustic output power of the activate transducer and is only available in live imaging. Higher acoustic power numbers correspond to increased sensitivity in the image with improved penetration, but the ALARA principle should be followed in actual clinical situations.</p>
<p>Center Line</p>		<p>Press to activate the Center Line function. Refer to section 6.6 for details.</p>

Table 5-1 B-mode Touch Screen Controls

5.2 Color Mode

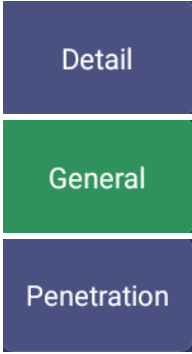
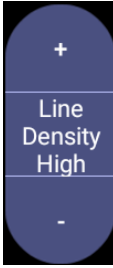
5.2.1. Color Mode Variants

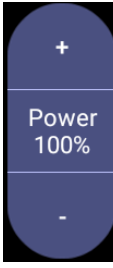
The system supports 3 types of Color Doppler imaging:



- Color (Color Doppler): This is velocity Color Doppler that shows direction and velocity of flow. Different colors represent different velocities and positive flow has different colors than negative flow.
- PDI (Power Doppler Imaging): PDI shows the power, or intensity, of the Doppler signal. PDI is typically more sensitive to low levels of flow, but cannot distinguish the velocity or direction of the flow.
- DPDI (Directional Power Doppler Imaging): This is similar to DPI in that it shows the power of the Doppler signal instead of the velocity. However, it does map positive flow to different colors than negative flow.





5.2.2. Using Color Mode



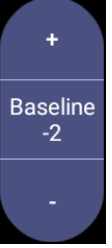

1. Perform the image scanning to get a good image in B mode;
2. Press <Color> to enter B+Color mode and display ROI box;
3. Adjust the size and position of ROI box.
Presses on <Set> switch between the status of adjusting the size and position of ROI box. Use trackball to adjust.
4. Press PDI, DPDI or Color mode key on the touch screen to switch Color Doppler modes when necessary;
5. Adjust image parameters to optimize the Color image.

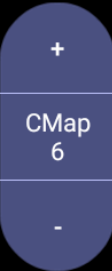
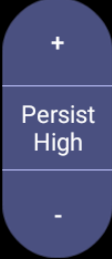
5.2.3. Color Image Optimization

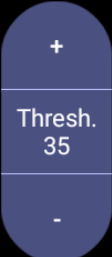
The following touch controls can be used to optimize the Color image.

Name	Control	Description
Color Mode Variation		A set of radio-buttons display the color modes that are available on the current transducer, and let you switch between them. See section 5.4.1 for details.
Scale		Scale adjusts the range of velocities that are displayed. Upward presses increase scale and downward presses decrease it. It is available in Velocity, PDI, and DPDI. It is not available in Freeze/Cine.

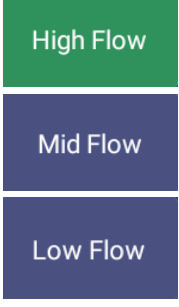
<p>Baseline</p>		<p>The Baseline control adjusts the Color baseline. Upward presses move the baseline up on the scale and downward presses move the baseline down. Baseline is not available in PDI mode.</p>
<p>Invert</p>		<p>Normally, signals above the baseline are positive velocities (moving toward the transducer). However, when Invert is pressed then negative velocities are above the baseline. Invert does not affect the baseline position. Invert is not available in PDI mode.</p>
<p>Wall Filter</p>		<p>The Filter control removes excessive noise from movement of vessel walls. Options of Low, Med. and High are available. Higher wall filter level will suppress more strong single of the vessel walls, but low flow signal will be missing.</p>
<p>Map</p>		<p>Adjusts the current map for the active color variation.</p>
<p>Persist</p>		<p>Persistence determines the number of frames that are averaged together for display. Levels of Off, Low, Med. and High are available.</p>
<p>Smooth Filter</p>		<p>The smoothness filter determines the spatial filtering that is applied to the Color image. Higher filter levels create a smoother image. Upward presses increase the filter. Downward presses decrease the filter.</p>
<p>Threshold</p>		<p>When the system receives both B-mode and color signals from a region within the Color ROI box, the Threshold determines whether to display overlapping signals as grayscale or color. In Color mode, higher Threshold values display more color, and lower Threshold values display more grayscale. Upward presses increase threshold. Downward presses decrease threshold.</p>

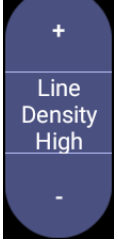
<p>Frequency</p>		<p>Frequency determines the transmit frequency used by color Doppler. Upward presses increase the frequency. Downward presses decrease the frequency.</p>
<p>Steer</p>		<p>This control is only available for linear transducers. It steers the Color ROI box angle left or right.</p>
<p>Image Type</p>		<p>Color Doppler supports image presets for Low Flow, Medium Flow, and High Flow.</p>
<p>Dual Live</p>		<p>To activate split screen with simultaneous live B/Color and live B. The live B image without color and the same live B image with color are simultaneously displayed on each side of the image field. Freezing the image will freeze both sides simultaneously. Cine review will review both sides simultaneously.</p>
<p>Dynamic Range</p>		<p>The Dynamic Range, or log compression, adjusts how echo intensities are converted to brightness. A high dynamic range presents a flatter, less contrasty color display, while a low dynamic range presents a more contrasty color display. Only available in PDI/DPDI mode.</p>
<p>Line Density</p>		<p>Adjusts the line density to optimize the lateral resolution for the best possible image. The higher the line density, the higher the lateral resolution, but the lower the frame rate.</p>

Acoustic power		Adjusts the acoustic output power of the activated transducer. It is only available in live imaging. Higher acoustic power numbers correspond to increased color sensitivity and penetration, but the ALARA principle should be followed in actual clinical situations.
----------------	---	---

Table 5-2 Color Mode Touch Screen Controls



5.3 PW Mode



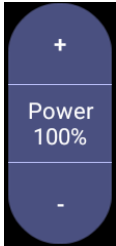

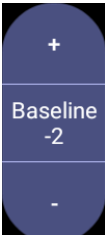

5.3.1. Using PW Mode



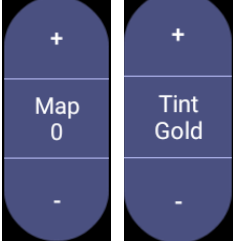

1. Perform the image scanning to get a good image in B mode or B+Color(DPI/DPDI) mode;
2. Press <PW> on the console to display sample line;
3. Use the trackball and touch controls to adjust the position of the sample line and the size and angle of the sample gate;
4. Press <PW> on the console to enter B+PW or B+Color(PDI/DPDI)+PW mode and display Doppler strip.
5. Adjust image parameters to optimize the Doppler strip.
6. When spectrum is displayed, pressing <Update> toggles between acquiring the Doppler strip and acquiring the reference image.

5.3.2. PW Image Optimization

The following touch controls can be used to optimize the PW image.

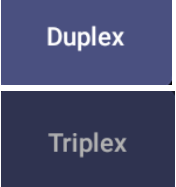
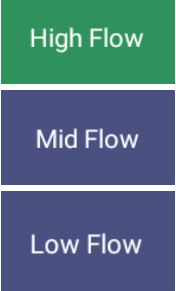
Name	Control	Description
Scale		Scale adjusts the range of velocities that are displayed. Upward presses increase scale and downward presses decrease scale. Increasing scale when the PW cursor is relatively deep may result in invoking HPRF, if it is configured. See section 5.3.3 for details.
Baseline		The Baseline control adjusts the Doppler baseline. Upward presses move the baseline up on the screen and downward presses move the baseline down.
Invert		Normally, signals above the baseline are positive velocities (moving toward the transducers). However, when Invert is pressed, the negative velocities are displayed above the baseline. Invert does not affect the baseline position.
Quick-Angle		Adjusts the angle correct quickly to one of 60/0/-60.

Filter		<p>The Filter control removes excessive noise from movement of vessel walls. Options of Low, Med. and High are available. Higher wall filter level will suppress more strong single of the vessel walls, but low flow signal will be missing.</p>
Colorize		<p>Switches between grayscale and colored (pseudo-color) postprocessing maps.</p>
Gray Map Tint		<p>Adjusts the current postprocessing, either grayscale or tinted.</p>
Dynamic Range		<p>The Dynamic Range, or log compression, adjusts how signal intensities are converted to brightness. A high dynamic range will display more shades of gray, while a low dynamic range will display fewer shades of gray and a more contrasty Doppler display.</p>
Gate Size		<p>Gate adjusts the size of the sample volume gate. Upward presses increase the gate size. Downward presses decrease the gate size.</p>
Sweep Speed		<p>Sweep adjusts the sweep speed of the Doppler strip. Options of Slow, Low, Med., High and Fast are available. Upward presses increase sweep speed. Downward presses decrease sweep speed.</p>
Strip Size		<p>Changes the relative size of the Doppler strip compared to the reference image. Full, Large, Med. and Small are available.</p>

Volume		<p>Volume adjusts the audio volume of the Doppler strip. This can be adjusted in pre-Doppler to set the initial volume upon invoking Doppler acquisition.</p>
Duplex Triplex		<p>This determines if the strip mode and reference image are imaging simultaneously or not. In Duplex mode, either the Doppler strip or the reference image is updated continuously. In Triplex mode, both the Doppler strip and reference image are updated simultaneously.</p>
Image Type		<p>Spectral Doppler supports image presets for Low Flow, Medium Flow and High Flow.</p>
Steer		<p>This control is only available for linear transducers and steers the Doppler cursor angle left or right.</p>
Frequency		<p>This determines the Doppler transmit frequency used for imaging.</p>
Auto Trace		<p>Press to activate the Auto Trace function on a real-time or frozen PW Doppler strip. The Auto Trace function automatically traces the spectral Doppler waveform and records several measurements on selected waveforms.</p>
Trace Side		<p>Press one of the three options to specify which side of the Doppler baseline to take measurements from: Up: traces positive portion of waveform (above baseline). Down: traces negative portion of waveform (below baseline). Both: traces waveform on both sides of baseline.</p>

Acoustic Power		Adjusts the acoustic output power of the activated transducer. It is only available in live imaging. Higher acoustic power numbers correspond to increased sensitivity in the Doppler display and improved penetration, but the ALARA principle should be followed in actual clinical situations.
----------------	---	---

Table 5-3 PW Mode Touch Screen Controls

5.3.3. HPRF

Conventional PW Doppler scales are limited by the Nyquist limit. High Pulse Repetition Frequency (HPRF) allows the system to exceed the Nyquist limit by having multiple Doppler pulses in the body at the same time. In HPRF imaging, multiple Doppler gates are displayed since the multiple Doppler pulses could be giving information from different depths. HPRF is automatically invoked when needed to maintain the requested depth and scale. For example, if the system is at a high scale and you move the cursor deeper, the system may automatically invoke HPRF. This can also happen if the cursor is deep and you increase scale.

If HPRF is active, you will see multiple Doppler gates on the reference image. If you do not want to be in HPRF, decrease the scale or move the primary PW gate to a shallower location until only one gate is displayed.

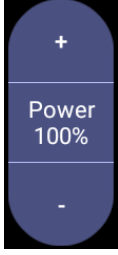
5.4 CW Mode

5.4.1. Using CW Mode





CW mode is only available on phased array transducer.

1. Perform the image scanning to get a good image in B mode or B+Color(DPI/DPDI) mode;
2. Press <CW> on the console to display sample line;
3. Use the trackball and touch controls to adjust the position of the sample line;
4. Press <CW> on the console to enter B+CW or B+Color(PDI/DPDI)+CW mode and display Doppler strip.
5. Adjust image parameters to optimize the Doppler strip.
6. When spectrum is displayed, pressing <Update> toggles between acquiring the Doppler strip and acquiring the reference image.

In CW mode, pressing on <PW> on the console will switch PW mode directly.

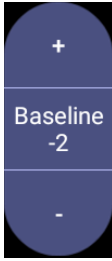
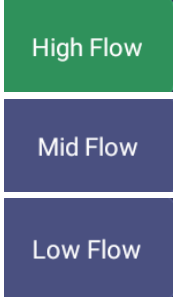
5.4.2. CW Image Optimization

The following touch controls can be used to optimize the CW image.

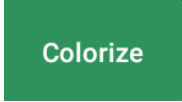
Name	Control	Description
Scale		Scale adjusts the range of velocities that are displayed. Upward presses increase scale and downward presses decrease it.
Baseline		The Baseline control adjusts the Doppler baseline. Upward presses move the baseline up on the screen and downward presses move the baseline down.
Image Type		Strip Doppler supports image presets for Low Flow, Medium Flow, and High Flow.
Invert		Normally, signals above the baseline are positive velocities (moving toward the transducer). However, when Invert is pressed then negative velocities are above the baseline. Invert does not affect the baseline position.
Quick-Angle		Adjusts the angle correct quickly to one of 60/0/-60.
Filter		The Filter control removes excessive noise from movement of vessel walls. Options of Low, Med. and High are available. Higher wall filter level will suppress more strong single of the vessel walls, but low flow signal will be missing.
Colorize		Switches between grayscale and tinted (pseudo-color) postprocessing maps.





<p>Gray Tint</p>		<p>Adjusts the current post processing, either grayscale or tinted.</p>
<p>Dynamic Range</p>		<p>The Dynamic Range, or log compression, adjusts how signal intensities are converted to brightness. A high dynamic range will display more shades of gray, while a low dynamic range will display fewer shades of gray and a more contrasty Doppler display.</p>
<p>Sweep Speed</p>		<p>Sweep adjusts the sweep speed of the Doppler strip. Options of Slow, Low, Med., High and Fast are available. Upward presses increase sweep speed. Downward presses decrease sweep speed.</p>
<p>Strip Size</p>		<p>Changes the relative size of the Doppler strip compared to the reference image. Full, Large, Med. and Small are available.</p>
<p>Volume</p>		<p>Volume adjusts the audio volume of the Doppler strip. This can be adjusted in pre-Doppler to set the initial volume upon invoking Doppler acquisition.</p>
<p>Acoustic Power</p>		<p>Adjusts the acoustic output power of the activated transducer. It is only available in live imaging. Higher acoustic power numbers correspond to increased sensitivity in the Doppler display and improved penetration, but the ALARA principle should be followed in actual clinical situations.</p>

Table 5-4 CW Mode Touch Screen Controls

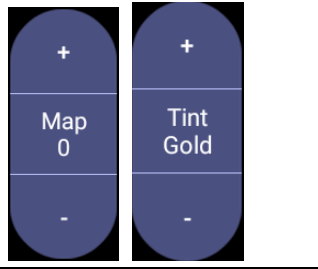

5.5 M-mode

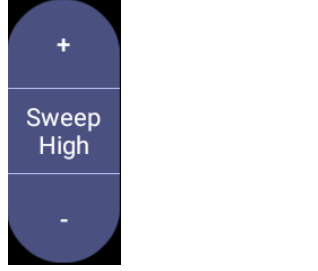
5.5.1. Using M-mode

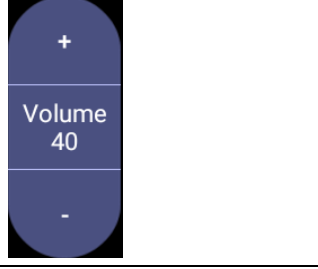
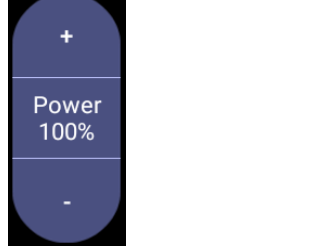
1. Perform image scanning to get a good image in B mode;
2. Press **<M>** to display M strip and sample line;
3. Move the trackball to adjust the sample line;
4. Adjust image parameters to optimize M strip.

5.5.2. M-mode Image Optimization

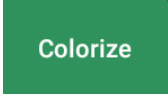
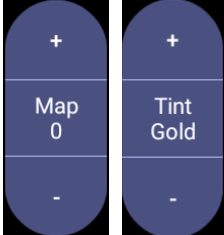
The following touch controls can be used to optimize the M-mode image.

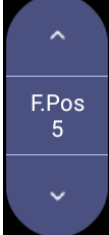
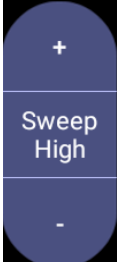
Name	Control	Description
Colorize		Switches between grayscale and colorized (pseudo-color) postprocessing maps.
Gray Map Tint		Adjusts the current postprocessing, either grayscale or tinted.
Dynamic Range		The Dynamic Range, or log compression, adjusts how echo intensities are converted to brightness. A high dynamic range will display more shades of gray, while a low dynamic range will display fewer shades of gray and a more contrasty M-mode display.
Focus Pos		The focus position set in B-mode applies to M-mode as well. Upward presses move the focus shallower, regardless of the U/D invert status of the M-mode. Downward presses move the focus deeper.
Sweep Speed		Sweep adjusts the sweep speed of the M-mode strip. Options of Slow, Low, Med High and Fast are available. Upward presses increase sweep speed. Downward presses decrease sweep speed.





Strip Size		Changes the relative size of the M-mode strip compared to the reference image. Full, large, Med. and small are available.
Side-by-side		This is an on/off control. When On, the M-Mode strip is displayed side-by-side with the B-mode image. When Off, the M-Mode strip is displayed below the B-mode image
Line Persistence		The line Persistence determines how many M-mode lines are averaged together for the display (similar to persistence in B-Mode). Off, Low, Med. and High settings are available.
Frequency		Frequency determines the transmit frequency used by M-Mode. Upward presses increase the frequency. Downward presses decrease the frequency.
Acoustic power		Adjusts the acoustic output power of the activated transducer. It is only available in live imaging. Higher acoustic power numbers correspond to increased sensitivity and penetration in the image, but the ALARA principle should be followed in actual clinical situations.

Table 5-5 M-Mode Touch Screen Controls

6 Transducers and Biopsy

6.1 Transducers

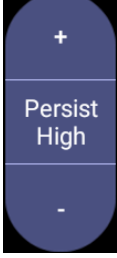
No.	Model	Type	Application	Applied Region
1	C5-2Q	Convex	Abdomen Fetal / Obstetrics Urology Gynecology Musculoskeletal	Surface
2	E8-4Q	Micro Convex	Fetal / Obstetrics Gynecology Trans-vaginal Trans-rectal Urology	Endocavity
3	L12-5Q	Linear	Small parts Peripheral Vascular Musculoskeletal	Surface
4	P5-1Q	Phased Array	Adult Cardiac Abdomen Pediatric Cardiac Adult Cephalic	Surface
5	L17-7Q	Linear	Small Parts Peripheral Vascular Musculoskeletal	Surface

Table 6-1 Transducer Model & Application

6.2 Using Transducers

Understanding a Transducer:

Figure 6-1 takes L12-5Q transducer to show an example of a transducer.

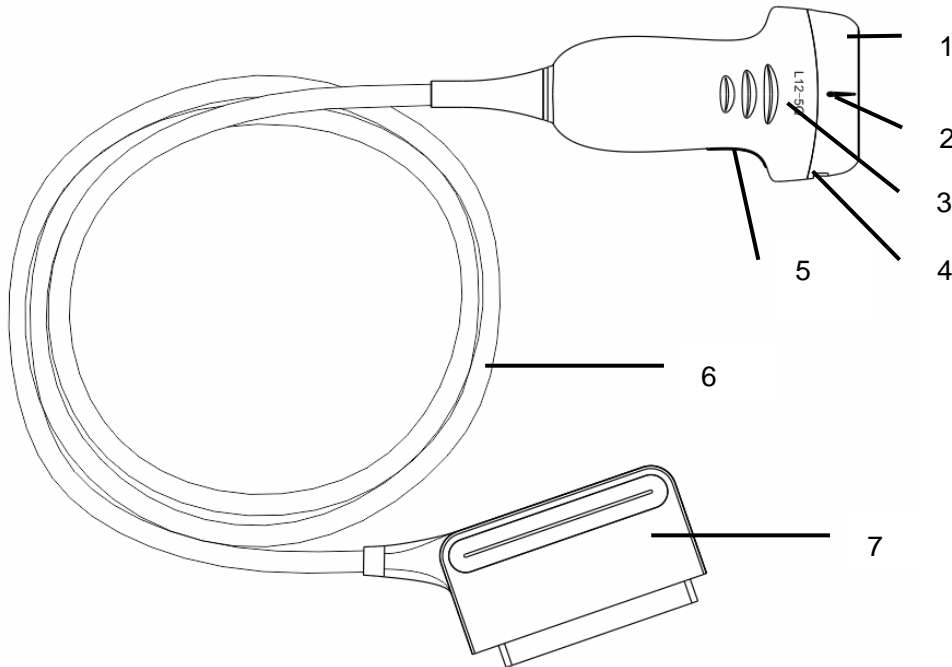

Figure 6-1 Typical transducer

No.	Name	Function
1	Transducer head	Converts electrical signals to sound waves, and then converts received echoes back to electrical signals. The tip of the transducer is the acoustic lens.
2.	Center line mark	Indicates the center line position of the transducer, which are usually used for out-of-plane needle guide.
3.	Transducer model	Displays the transducer model.
4	Needle-guided bracket fixing tabs and groves	Provides mounting support for the needle-guided bracket.
5.	Transducer orientation mark	The side of orientation mark on the transducer corresponds to the side of orientation mark on the display screen
6	Transducer cable	Transmits electrical signals between the transducer head and the transducer connector.
7	Transducer connector	Connects the transducer to the ultrasound imaging system.

Image Orientation Mark

The image orientation mark on the display screen and on the transducer are shown as below. The side of orientation mark on the transducer corresponds to the side of orientation mark on the display screen. Ensure orientation marks on the display screen and transducer are on the same side prior to scanning.

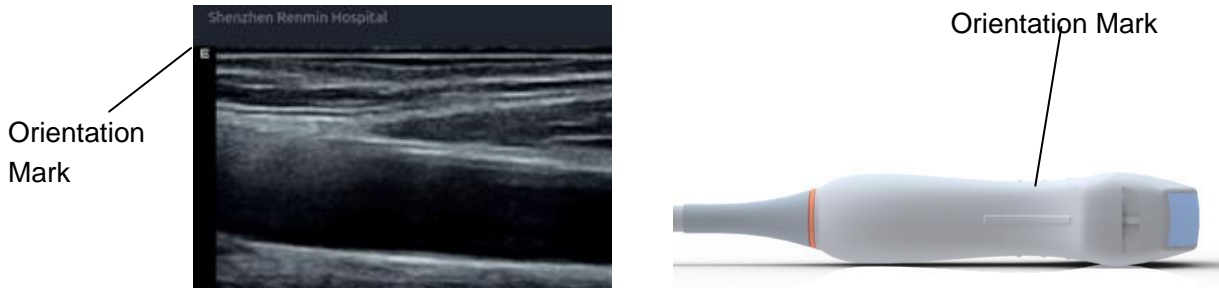

Figure 6-2 Image Orientation Mark

Proper Use of Transducers

To extend the service life and maintain optimum transducer performance, please operate as follows:

- Inspect transducer cable, socket and acoustical window of the transducer periodically.
- Shut down the machine before connecting or disconnecting the transducer.
- Do not drop the transducer onto the floor or collide with hard objects. Otherwise it will be damaged easily.
- Do not heat the transducer.
- Do not pull or bend the transducer cable.
- Coupling gel can only be used on the head of the transducer, and it should be wiped off after use.
- Clean and disinfect the transducer after every use.
- The acoustical window and the shell of the transducer should be examined frequently.

CAUTION

1. Do not disinfect or clean transducers under high temperature. The temperature should be below 45°C.
2. To avoid damaging the device, the disinfection method is limited to regular maintenance of devices in hospitals. Disinfecting instruments should be cleaned first.
3. The coupling gel adapted to the transducer is a medical ultrasound coupling gel. Use only ultrasound coupling gel that complies with local regulations.

Use of Transducer sheath

CAUTION

1. Always wear gloves to perform the following steps.
2. To minimize disease transmission, legally marketed, sterile transducer sheath is required to use for intra-cavitary procedures.
3. DO NOT use an expired transducer sheath. Check whether the term of validity has expired prior to using transducer sheaths.
4. The single-use sheath should comply with the local regulations.
5. Before cleaning or disinfecting the transducer, remove the sheath gently and discard it. Put on a new single-use sheath before using the transducer.
6. Use of protective sheath with natural rubber latex may lead to a severe anaphylactic reaction in persons sensitive to the natural latex protein.
7. Transducer sheath should be used with all clinical situations where infection is a concern.

To install transducer sheath:

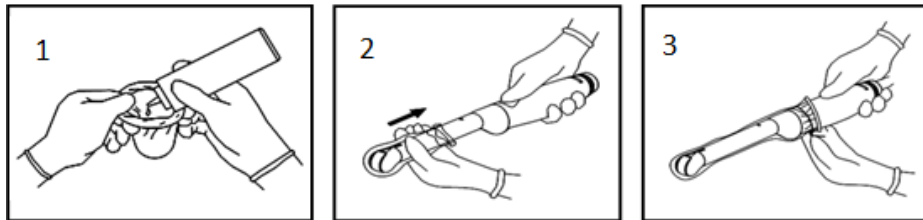

1. Place an adequate amount of sterile coupling gel in the protective sheath and/or on the acoustic window of the transducer;
2. Insert the transducer into the sheath;
3. Pull the sheath over the transducer and cable until the sheath is fully extended. Check and eliminate bubbles between the surface of the transducer and the sheath. Be careful not to pierce the sheath.
4. Secure the sheath using the bands or clips supplied with the sheath;
5. Inspect the sheath to ensure that there are no damages (i.e. holes or tears).

6.3 Transducer Cleaning and Disinfecting

Transducers should be cleaned and/or disinfected as necessary or between use with a recommended cleanser or disinfectant. Disconnect the transducer from the system prior to cleaning and disinfecting.

6.3.1. Cleaning

The validated cleaning agents for cleaning the transducers are:

- Ethanol (75%)
- Isopropanol (70%)

Cleaning agents should be applied and removed using a clean, soft, non-abrasive cloth or paper towel.

To clean the transducers:

1. Disconnect the transducer from the system.
2. Wipe the transducer cable with a soft cloth dampened with the cleaning solution until no visible contaminants remain.
3. Wipe the patient contact area with a soft cloth dampened with the cleaning solution until no visible contaminants remain.
4. After cleaning, wipe off the cleaning solution with a fresh cloth or towel dampened with tap water until no visible cleaning agent remains.
5. Wipe off with a dry cloth to remove residual moisture.
6. Leave the transducer to air dry.

WARNING

1. Unplug the transducer from the system prior to cleaning or disinfecting.
2. To avoid infection, always use protective gloves when performing cleaning and disinfecting procedures.
3. Prohibit infiltration of any type of liquid into the device or the transducer.

6.3.2. Disinfecting

Selecting a proper way to disinfect your transducers based on your transducer applied region:

<i>Transducer Applied Region</i>	<i>Transducer Type</i>	<i>Disinfecting Intensity</i>	<i>Disinfecting Method</i>
Contact intact body surface	Body surface	LLD	Spraying or wiping
Contact mucous membrane	Endocavity	HLD	Immersion

Note: LLD=Low-level Disinfection; HLD=High-level disinfection

The validated disinfectants for transducer are:

<i>Disinfectants</i>	<i>Disinfecting Intensity</i>	<i>Disinfecting Method</i>
Ethanol (75%)	LLD	Spraying or wiping
Isopropanol (70%)	LLD	Spraying or wiping
Cidex OPA (0.55%)	HLD	Immersion
Glutaraldehyde(1.8%-2.2%)	HLD	Immersion

WARNING

1. Unplug the transducer from the system prior to cleaning or disinfecting.
2. To avoid infection, always use protective gloves when performing cleaning and disinfecting procedures.
3. To avoid infection, ensure that expiration date of the disinfecting solution has not passed.
4. Please cleaning the transducer prior to disinfection.

Disinfecting by spraying or wiping:

1. Disconnect the transducer from the system.
2. Wear protective gloves to prevent infection.
3. Prepare the disinfectant solution (75% ethanol or 70% isopropanol).
4. Spray the solution to the transducer interface or wipe it with a soft cloth dampened with the disinfectant solution. Follow the disinfectant manufacturer's recommended contact time and mode.
5. Rinse the transducer according to the disinfectant instructions. Wipe the transducer with a dry cloth or leave the transducer to air dry.
6. Inspect the transducer to ensure that there is no damage.

Note:

If Ethanol or Isopropanol is used for both cleaning and disinfecting, then a new cloth is required for the disinfection step.

Disinfecting by Immersion:

1. Disconnect the transducer from the system.
2. Wear protective gloves to prevent infection.
3. Prepare the disinfectant solution (Cidex OPA 0.55% or Glutaraldehyde(1.8%-2.2%)).
4. Place the cleaned and dried transducer in contact with the disinfectant (refers to figure 6-3 for the contacting area) for the time specified by the disinfectant manufacturer.
5. Rinse the transducer according to the disinfectant instructions. Wipe the transducer with a dry cloth or leave the transducer to air dry.
6. Inspect the transducer to ensure that there is no damage.

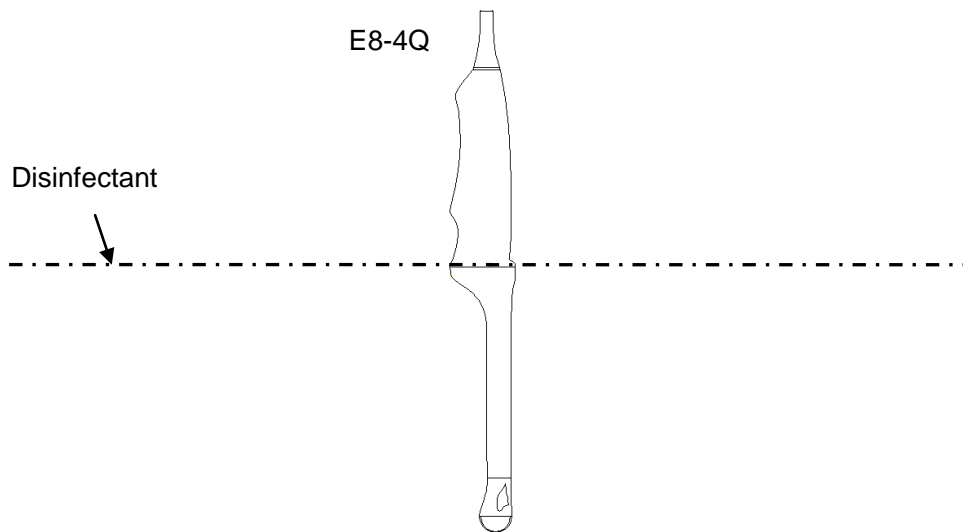

Figure 6-3 Depth of the Transducer Immersed into Disinfectant

WARNING

1. Do not immerse the transducer connector. If the cable connector is immersed, do not plug the connector into the system. Rinse the connector under running water and dry it thoroughly. If necessary, contact EDAN for service.
2. Prohibit infiltration of any type of liquid into the device or the transducer.
3. Do not immerse the AC adapter and connector of the transducer into solutions. Transducers can be submerged to, but not including, the strain relief of the transducer array. Do not immerse or soak any part of a transducer in any cleaning material not listed in the recommended list of disinfectant.
4. Use the immersion method to disinfect the intra-cavitary transducer.
5. Only non-immersion method can be used with solution of ethanol or isopropanol. The solution concentration should not exceed the value provided above.
6. The immersion time should not exceed the time that is specified by the disinfectant manufacturer.
7. Patient contact area should be immersed into the solution while using the immersion method, but should not exceed the depth shown in figure 6-3.
8. Do not sterilize the transducer using techniques such as autoclave, ultraviolet, gamma radiation, gas, steam, or heat. Severe damage may result.

6.4 Needle Biopsy Guide

NOTE:

Use proper sterile technique at all times when performing a biopsy.

Always follow these basic precautions:

WARNING

1. Disinfect the needle guide kit before the first use and after each subsequent use.
 2. Calibrate the needle guide kit (see section 6.4.3) under any of the following conditions:
 - a) The first time that each bracket/transducer combination is used.
 - b) If the bracket or transducer head is dropped or struck, or has evidence of wear.
 - c) If previous use has shown some drift of the needle from the center of the guidelines.
 3. The displayed needle guide pathway on the EDAN video monitor is intended for reference during biopsy procedures. A variety of factors outside EDAN's control, such as changing tissue density, bending of the needle, off-axis pressure by the person holding the transducer, etc., may cause deflection of a needle outside of the displayed video pathway even when the transducer, needle guide, and the system software are all performing as intended and within manufacturing specification. The specialist performing a biopsy procedure must be aware of potential external factors when performing an invasive procedure.
 4. Do not freeze the system when performing a biopsy.
 5. EDAN needle guides are designed and manufactured to attach firmly to designated transducers and should not require excessive force to assemble or disassemble. Do not use a needle guide that requires excessive force or manipulation to assemble or disassemble.
 6. A single-use sheath should be used on transducer when performing a biopsy.
-
-

6.4.1. Installing Needle Guide Bracket

WARNING

1. For illustration purpose only, transducer and bracket may be shown without a protective sheath. Always place a protective sheath on transducer and bracket to protect cross infection.
-
-

■ **BGK-C5-2/BGK-L40UB/BGK-002**

The installation steps for BGK-C5-2, BGK-L40UB and BGK-002 brackets are the same. Here we take one bracket for illustration.

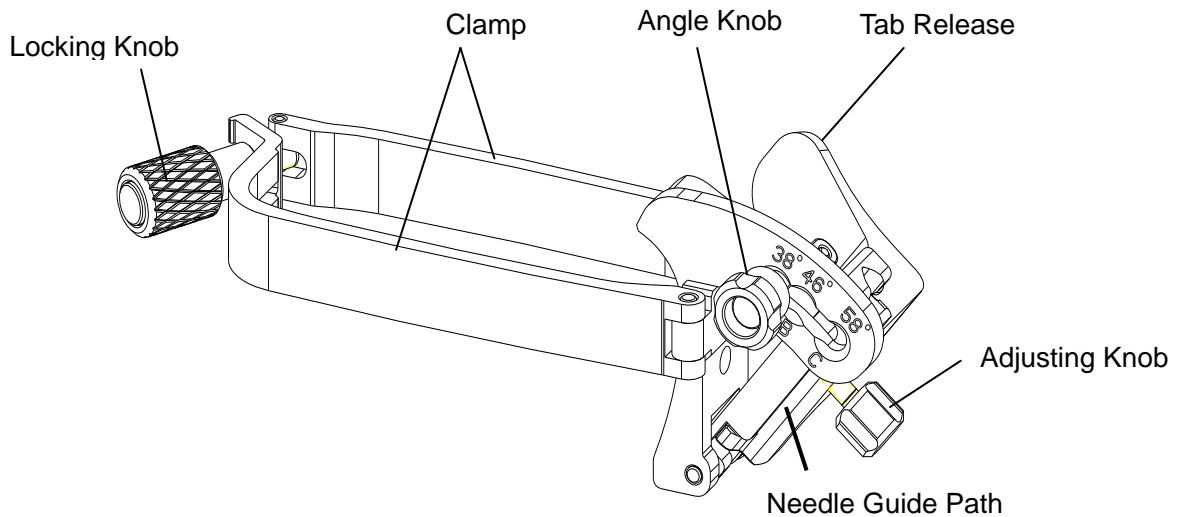
Structures:**Installation and Use Steps:**

1. Place an appropriate amount of gel on transducer surface, and insert transducer into the sheath.
2. Loosen the locking knob to open the clamp of bracket. Attach the bracket to the transducer by aligning the locating markers on the bracket and the transducer. Properly secure the clamp of bracket with the locking knob. Ensure the bracket is firmly attached.

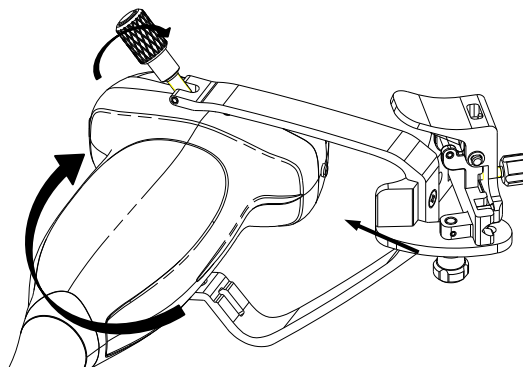

3. Loosen the angle knob to select a needle guide angle, and secure the angle knob.

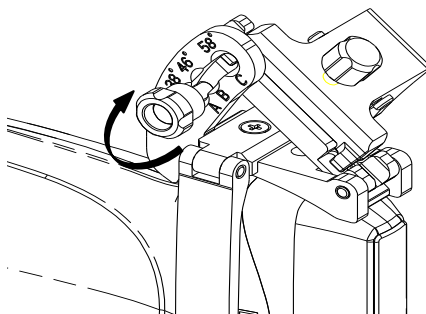

4. Press the tab release and place the biopsy needle into the needle guide path. Use the adjusting knob to properly secure the needle.

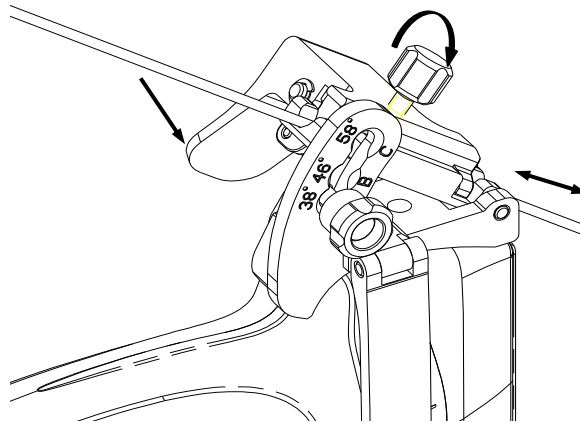

5. After biopsy, press the tab release to remove the needle, and loosen the locking knob to remove the bracket from the transducer.

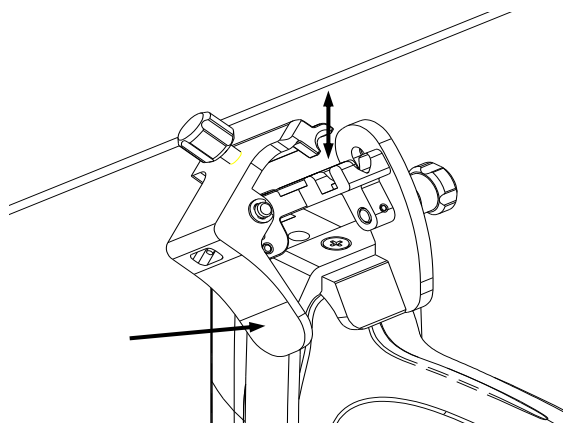

■ **BGK-CR10UA**

Structures:

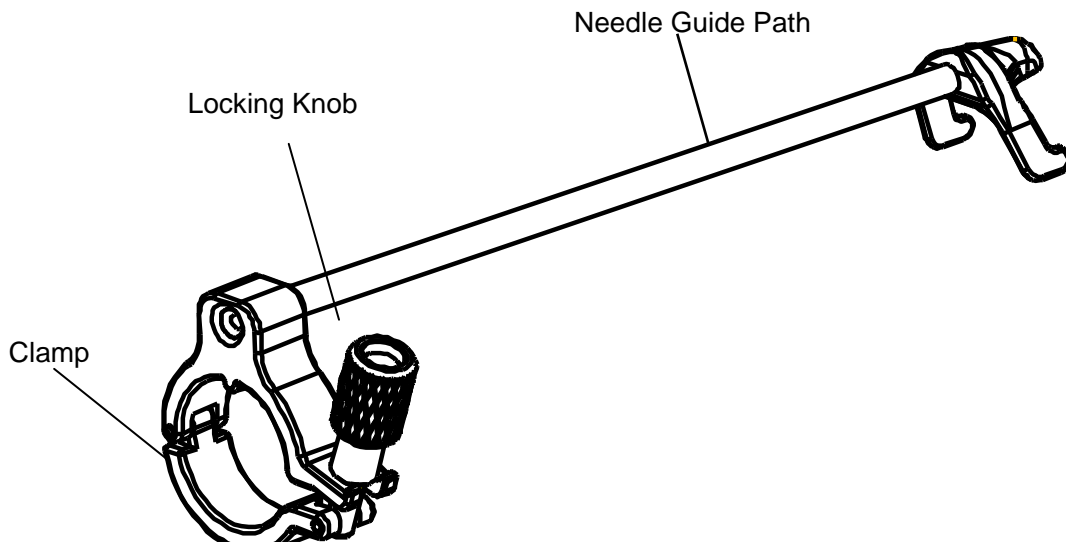

Installation and Use Steps:

1. Place an appropriate amount of gel on transducer surface, and insert transducer into the sheath.
2. Loosen the locking knob to open the clamp of bracket. Attach the bracket to the transducer by aligning the locating markers on the bracket and the transducer.

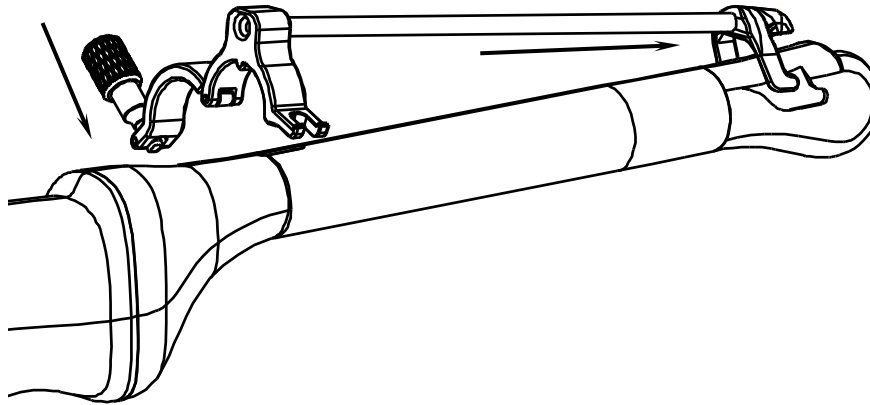

3. Properly secure the clamp of bracket with the locking knob. Ensure the bracket is firmly attached, and then place the biopsy needle into the needle guide path.

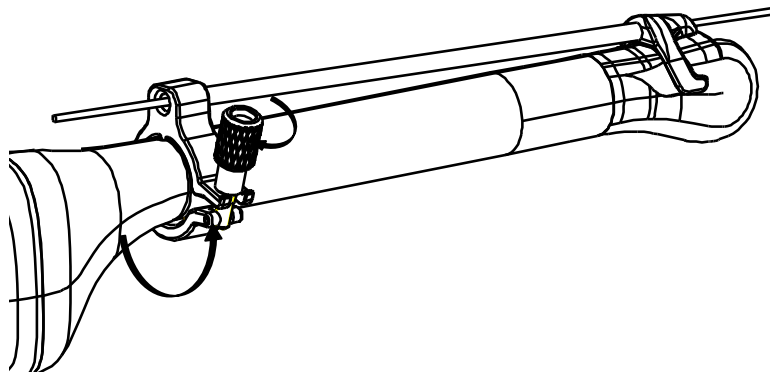

■ **BGK-001/BGK-003**

The installation steps for BGK-001 and BGK-003 brackets are the same. Here we take one bracket for illustration.

Structures:

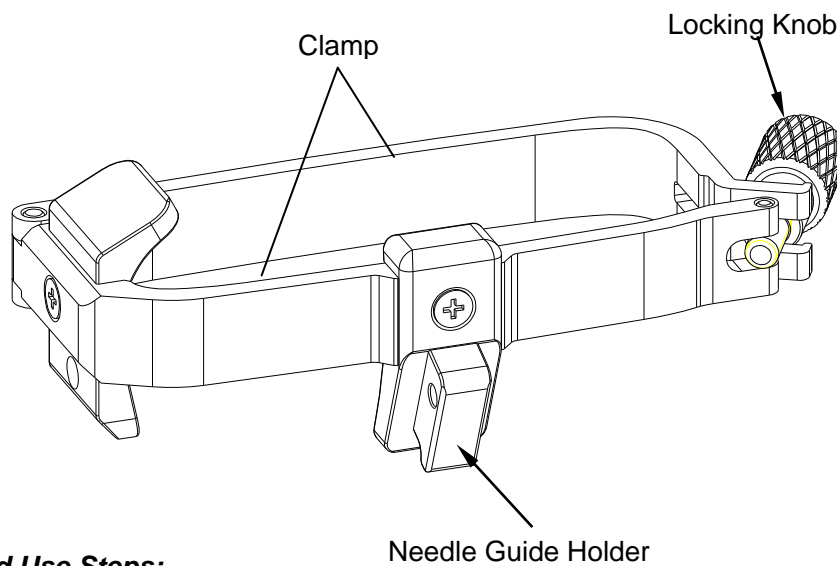

Installation and Use Steps:

1. Place an appropriate amount of gel on transducer surface, and insert transducer into the sheath.
2. Loosen the locking knob to open the clamp bracket. Attach the bracket to the transducer by aligning the locating markers on the bracket and the transducer. Properly secure the clamp of bracket with the locking knob.

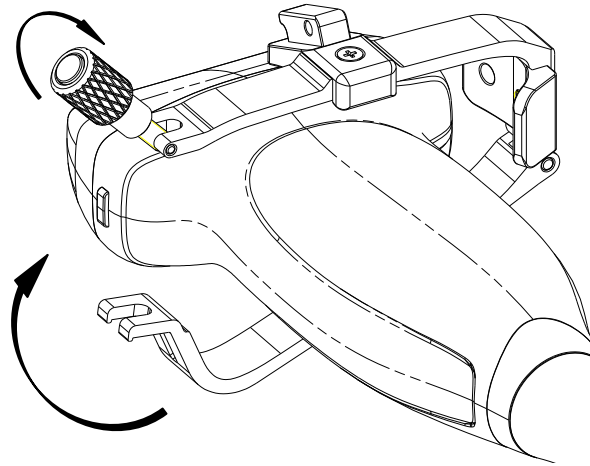

3. Install the disposable Needle Guide.

- a. Select appropriate disposable needle guide to achieve target depth from skin line:

Specification	Depth
21G (1.0cm)	0.8 - 1.2 cm
21G (1.5cm)	1.3 - 1.7 cm
21G (2.0cm)	1.8 - 2.2 cm

- b. Install the needle guide to the needle guide holder, and then put in the biopsy needle:

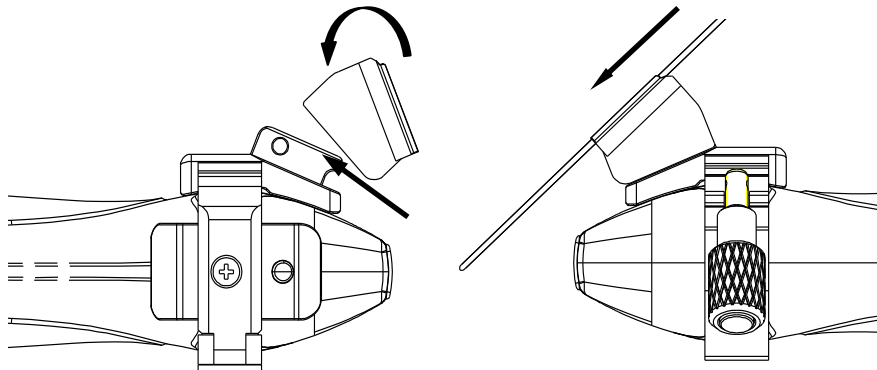

6.4.2. Activating Needle Guide Function

To enable the needle guide function:

1. In the B mode imaging, press **Needle** button on touch screen. A needle touch screen UI is displayed. Press **Enable** button to active the Needle Guide function.
2. Press **Double Line** button to switch double line and single line as the Needle guide Line graphics.
3. Some needle guide brackets support multiple angles. If the current transducer supports such a guide then the **Line** paddle key appears. Pressing it selects guide lines of different angles. Each line represents a corresponding angle marked on the needle guide bracket.

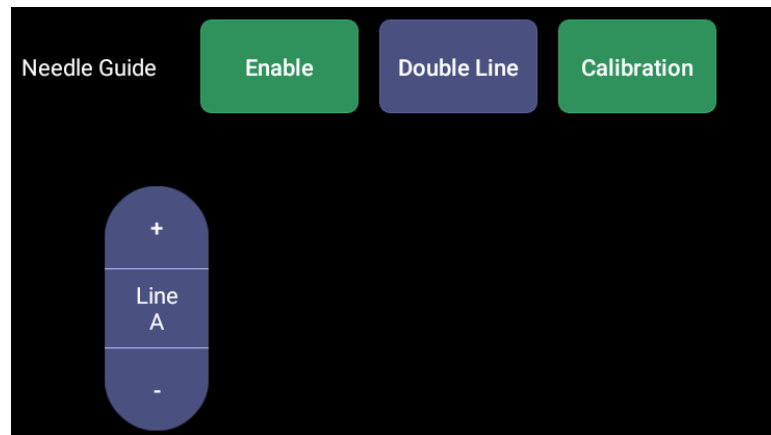

Figure 6-4 Needle Guide Touch Screen

WARNING

1. To avoid patient injury when using a multi-angle bracket, make sure that the same angle(A, B, C or D) is selected on both the bracket and the ultrasound system.

6.4.3. Calibrating the Needle Guide Line**WARNING**

2. Calibrate the needle guide under any of the following conditions:
 - a) The first time a needle guide is used with a given transducer.
 - b) Any time the needle guide or transducer has been dropped or struck against a hard surface.
 - c) After repeated use.
3. Do not use the needle guide bracket if the needle does not track with the guide during calibration.

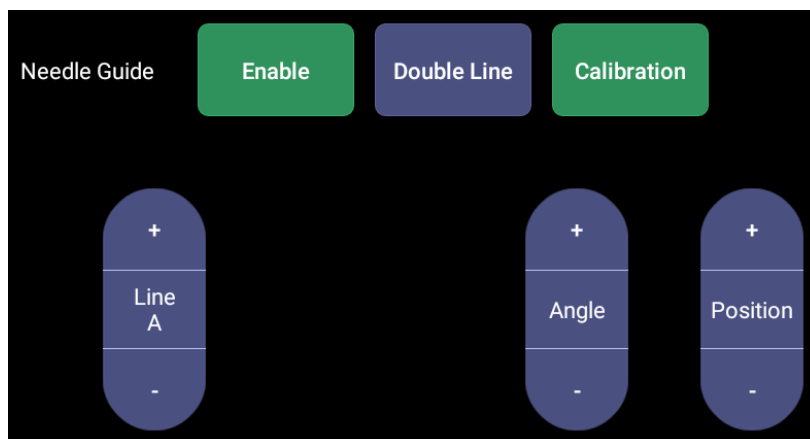

Figure 6-5 Needle Guide Calibration Touch Screen

To calibrate the guide line

1. Assemble the needle guide bracket on the transducer, and use the transducer to image a water bath or needle guide phantom.
2. From the Needle function on the B-mode touch screen, press the **Line** paddle key to select a guide line.
3. Press the **Calibration** button on the touch screen to display the **Angle** and **Position** paddle button.

- Use the **Position** paddle to adjust the line horizontally until the origin aligns with the actual needle.
- Use the **Angle** paddle to adjust the angle of the line until the entire line aligns with the actual needle.

4. Any changes will be saved as the default value automatically.

6.5 Needle Visualization

Needle Visualization is an image processing technology that enhances needle visibility. It is available in B-mode for all linear transducers.



Figure 6-6 Needle Enhancement Visualization

Needle Visualization is invoked by pressing the **Needle** button on B-mode touch screen, and then the **Enable** button in the Needle Visualization section of the Needle touch screen. The following parameters can be adjusted when it is active.

- **Enable:** Enables or disables Needle Visualization.
- **L/R:** press to display the angle line on left side or right side of the image field.
- **Shallow/Medium/Steep:** press to enhance the needle visibility for different needle inserted angles. For best results use the angle line that is closest to perpendicular to the needle path.



Figure 6-7 Touch Screen for Needle Enhancement Visualization

6.6 Center Line

The Center Line is a vertical dotted line displayed at the middle of the image field, representing the middle of ultrasound beam. The Center Line helps to locate the position and depth of a target disease focus for out-of-plane biopsy, lithotripsy and etc..

To use Center Line:

1. Press **Center-Line** on B-mode touch screen to activate Center Line.
2. A dotted center line is displayed vertically at the middle of the image field. The position and direction of the center line cannot be changed.
3. Move the transducer to locate the target.
4. Use distance measurement to obtain the depth of the target.

Note:

Center Line is not available on Endocavity transducer E8-4Q.

6.7 Needle Guide Bracket Cleaning and Sterilization

NOTE:

1. Use proper sterilization technique at all times when performing a biopsy.
2. Ensure that protective gloves are worn.

WARNING

The needle guide bracket kits are not disinfected or sterilized before delivery. The operators must clean and sterilize the needle guide bracket kits before and after each use.

To clean a needle guide bracket:

1. Disconnect the needle guide bracket from the transducer after each use, and remove all visible residues from the needle guide bracket using a small and soft-bristled brush or other similar devices. Do the cleaning quickly before the needle guide bracket dries out.
2. Soak the needle guide bracket in the cleaning solution (Ethanol 75% or Isopropanol 70%) for at least five minutes. Use a soft-bristled brush to clean the needle guide bracket during the soaking. If the residue is hard to be removed, repeat the soaking procedures. Take out the needle guide bracket from the cleanser and wipe all residues with a dry cloth.

To sterilize a needle guide bracket:

Sterilize the Needle Guide Assembly by autoclaving for at least four minutes at 132°C.

7 Features

7.1 Comment

The Comment function allows you add annotation to an image. The Comment function is invoked by pressing the <**Comment**> hard key on the console. Figure 7-1 shows an example touchscreen for the Comment function. The top portion of the screen shows comments that are pre-defined in pre-sets. See section 10 for details on how to configure these. The bottom portion of the screen shows controls available while the Comment function is active. Table 7-1 gives an overview of these controls.

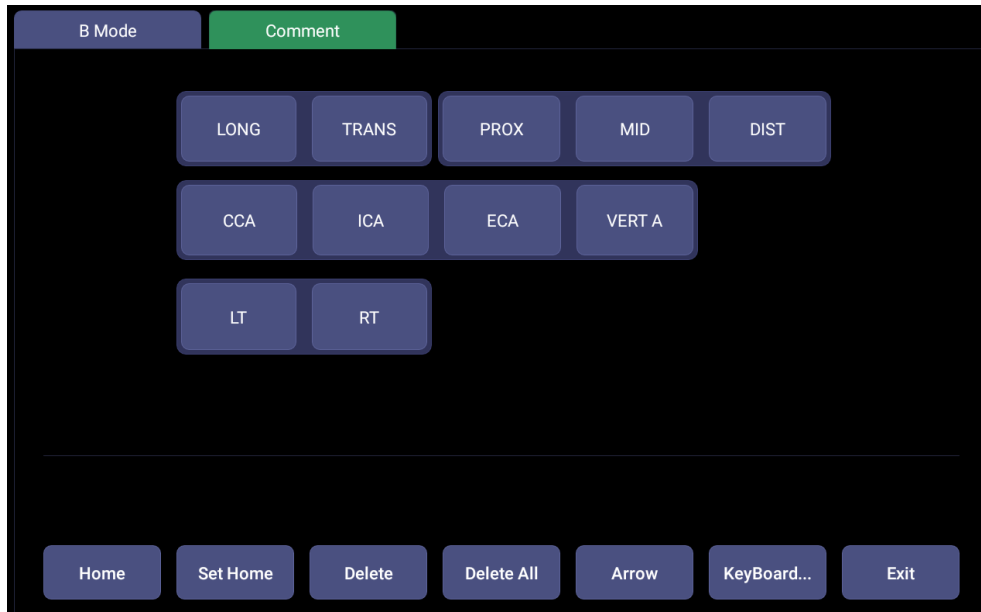

Figure 7-1 Comment Touch Screen

Button	Description
Home	Set the cursor in a pre-defined location.
Set Home	Set the current cursor location as the new Home location
Delete	Delete a whole text or text group or an arrow
Delete All	Clear all comments on the image area
Arrow	Create a new arrow for annotating
Keyboard	Show or hide a touch screen keyboard.
Exit	Press to exit the comments function.

Table 7-1 Comment Touch Screen Description

Adding comments

You can add either pre-defined comments or use a keyboard.

➤ **Adding comments using the keyboard**

1. Invoke the Comment function.
2. Press the "**Keyboard**" touch screen key to display a keyboard on the touch screen.
3. Move the cursor to the desired location and type the desired text.

➤ **Adding comments using pre-defined comments**

1. Invoke the Comment function
2. Move the cursor to the desired location and press the desired pre-defined comment.

Some of the pre-defined comments may be grouped together with a border surrounding them (such as 'Rt' and 'Lt' in figure 7-1). These are special keys that let you quickly replace one term with another, regardless of where the cursor is within a block of text. For example, if you had entered "Rt. Kidney" as a block of text, pressing the "Lt." button would change that block to "Lt. Kidney" even if the cursor is not at the specific location.

➤ **Adding arrows**

1. Invoke the Comment function.
2. Press **Arrow** button on the touch screen to display an arrow at the current cursor location.
3. Move the arrow to the desired location. Note that while the arrow is being moved the orientation of the arrow is fixed.
4. Rotate the **<Angle>** knob on the console to adjust the orientation of the arrow.
5. Press **<Set>** key to confirm the arrow and you can now enter text at the end of the arrow.

If the "**Continuous Arrow**" is checked on General Comment Settings Screen, pressing **<Set>** key will confirm the arrow and display a second arrow. Repetition of this will add multiple arrows.

Modifying comments

1. Move the cursor to a desired comment, notice that an insert cursor appears in the text as the cursor moves over an existing block of text.
2. Enter text using either the keyboard or pre-defined comments. The new comments will be added to the old text.

Deleting comments

There are several ways to delete comments:

- ◆ Move the cursor to the desired block of comments and press the **Delete** button on the touch screen to delete that block of comments.
- ◆ Press the **Delete All** button on the touch screen to remove all comments.
- ◆ Press the **<Clear>** hard key on the console to remove all comments, body marks, and measurements.

7.2 Body Mark

Body Mark allows you add a body mark graphic to an image and indicate the location of the transducer using a transducer icon on that graphic. The Body Mark function is invoked by pressing the **<Body Mark>** hard key on the console. Figure 7-2 shows an example touch screen for Body Mark. The main portion of the screen shows a grid of body marks that are pre-defined in pre-sets. See section 10 for details on how to configure these. The bottom portion of the screen shows controls available while the Body Mark function is active. Table 7-2 gives an overview of these controls.

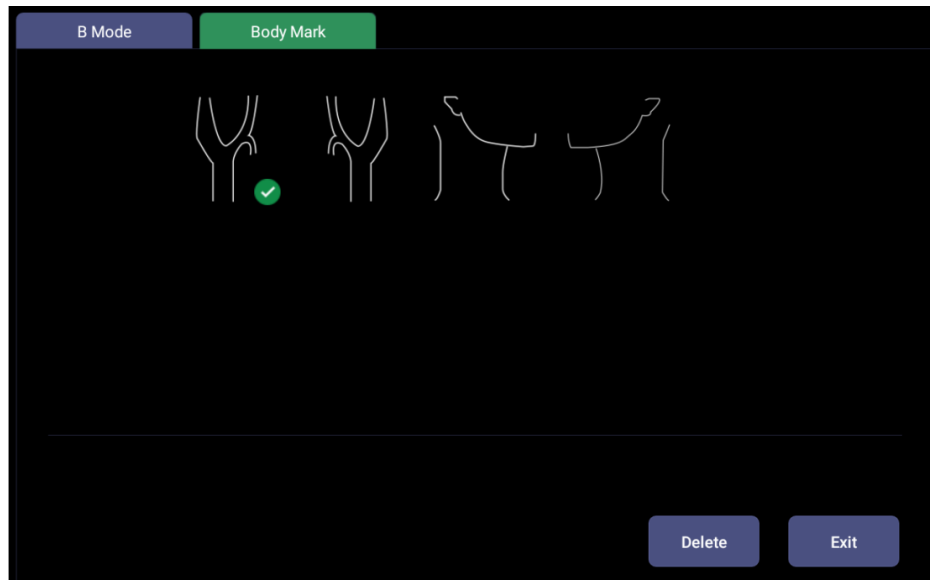

Figure 7-2 Body Mark Touch Screen

Button	Description
Delete	Delete the graphics on the image area
Exit	Press to exit the body mark function.

Table 7-2 Body Mark Touch Screen Description

Adding a body mark:

1. Invoke the **Body Mark** function
The default body mark graphic appears on the main screen with the transducer icon shown in the default position.
2. Select a desired body mark graphic on the touch screen, that graphic replaces the default.
3. Move the position of transducer icon as needed. The orientation of the transducer icon can be changed with the **<Angle>** knob on the console.
4. Press **<Update>** key and roll the trackball to move the position of body mark graphic.
The **<Update>** key can be used to toggle between moving the transducer icon and moving the body mark graphic.
5. Press **<Set>** to complete the adding of a body mark.

Deleting a body mark:

There are two ways of deleting a body mark graphic:

- ◆ Press **Delete** on the touch screen to delete the graphics on the image area.
- ◆ Press the **<Clear>** hard key to delete all body marks, comments, and measurements.

7.3 Dual Image Display

Dual Imaging displays images side by side on the screen. During real-time imaging when Dual imaging is enabled, the active image is displayed in real-time and the other image is frozen.

Dual image display is invoked by pressing the Dual hard key  on the console. Each single press of Dual key during real-time imaging activates the image on one side and the image on other side becomes frozen.

In Dual mode, press the Single hard key  on the console to return to single image real-time scanning.

Dual Exit

Exit Dual using any of the following:

- Pressing the B, M, PW, CW hard key.
- Transducer change, preset recall, or new exam.

Dual image display is available in B and Color Doppler mode.

7.4 Zoom

Zoom mode is available on the live or frozen image in B mode and Color mode. When the indicator of zoom function illuminates, rotate the physical Zoom knob on the console, as shown below, to zoom an image. The indicator of zoom function will illuminate whenever zoom function is available.

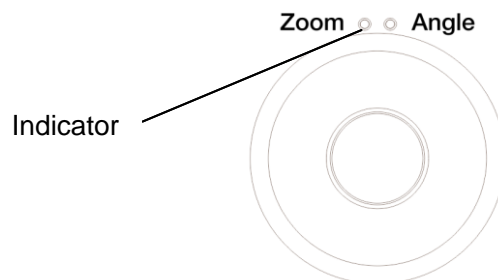

When in Zoom mode, use the trackball to pan the position of zoomed image. The B image remains zoomed after entering other imaging modes.

7.5 Cine Review

Press **<Freeze>** key on the console to freeze the image or select a stored cine clip, and the cine bar is displayed on the bottom of the screen, as shown below.

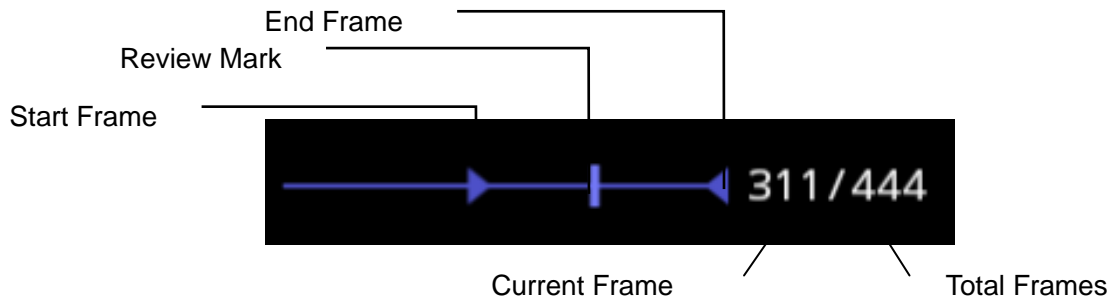

Figure 7-3 Typical Cine Bar in B/Color Mode

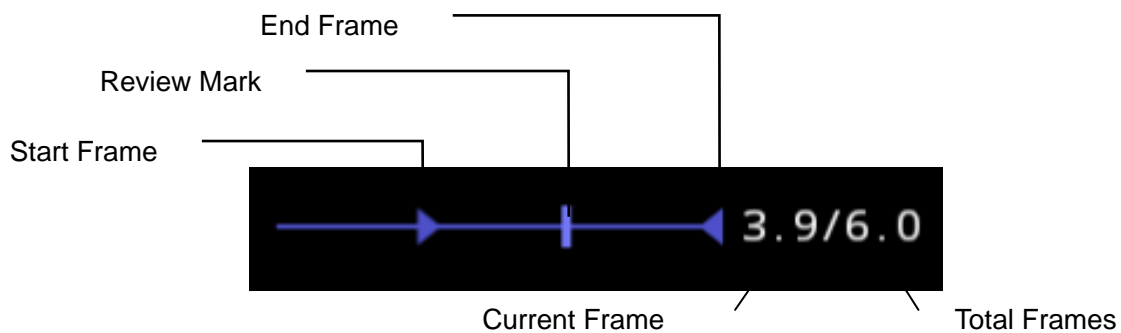

Figure 7-4 Typical Cine Bar in PW/CW/M Mode

The cine can be reviewed manually or automatically.

Manual Review:

Move the trackball to review the cine frame by frame. As the trackball moves, the current cine number is displayed on the right of the cine bar.

Auto Review:

1. Set the start frame: in manual review status move the trackball to review frame by frame until the frame that you want to set as the start point, press **Set Start** button on the touch screen to select a frame as the start frame.
2. Set the end frame: in manual review status, move the trackball to review frame by frame until the frame that you want to set as the end point, press **Set End** button on the touch screen to select a frame as the end frame.
3. Adjust the review speed by the **Speed** paddle key.
4. Press **Play** button on the touch screen to review the cine within the set region automatically.



In dual imaging, freeze the image, and press  to toggle between the two windows. The cine bar corresponds to the currently active image, and you can perform manual/auto review for the currently active image.

8 Measurements and Reports

The Measure function lets you perform measurements on a live or frozen image. The Measure function is invoked by pressing the **<Measure>** hard key on the console. Figure 8-1 shows an example touch screen for Measure.

There are two types of measurements:

Generic Measurements: These are simple tools like Distance or Area. There is no specific anatomy associated with these measurements and they do not appear in a report.

Application Measurements: These are measurements for specific anatomy or clinical conditions. The results can be entered into a report that can be printed later.

On the Measure touch screen, the lower part of the touch screen shows Generic Measurements. These are different for each imaging mode. The upper part of the touch screen shows Application Measurements. These are different for each imaging mode and each preset.

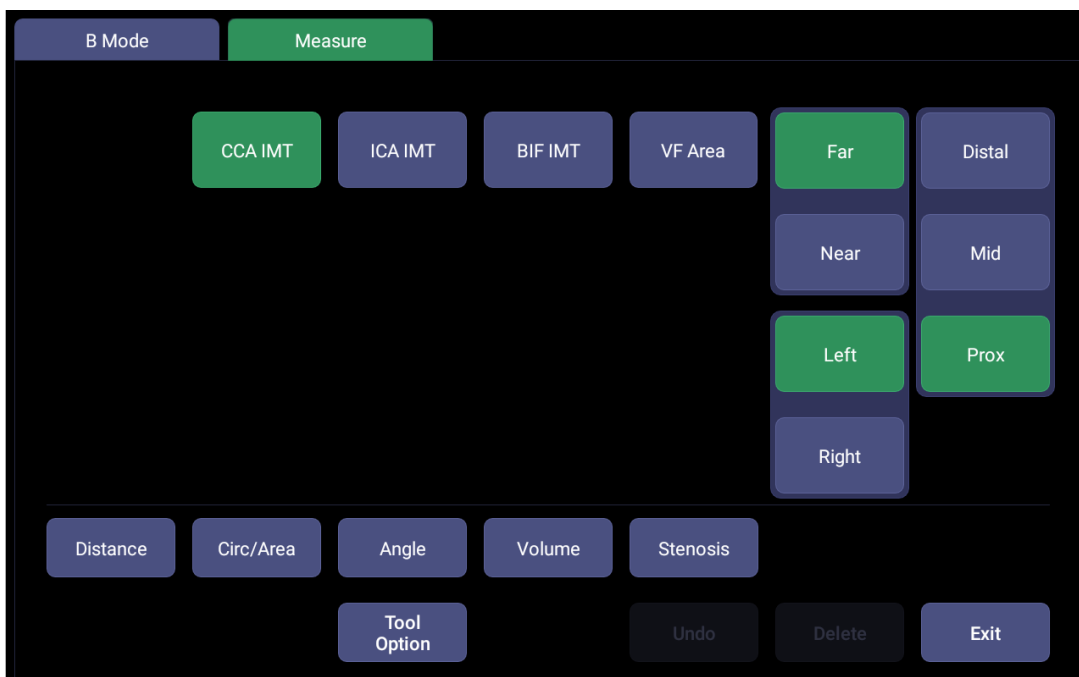

Figure 8-1 Measure Touch Screen

Tool Options

Some measurements can be done with a choice of different tools and each tool has a choice of multiple output result items. The users can configure the default tool and result items for these measurements by **Tool Options**. For result options, at least one item should be selected.



Figure 8-2 Tool Options Touch Screen

Moving the measurement result window

The measurement result window is displayed on the top left corner of the image field by default, the system supports changing the display position of the result window by dragging it.

To change the display position of result window:

1. Press **<Cursor>** hard key to invoke a cursor after a measurement is done.
2. Move the cursor over the result window, and press **<Set>** key, the result window will turn green.
3. Move the trackball to locate a desired position within the image field for the result window.
4. Press **<Set>** key again to fix the result window on the new position.

8.1 Generic Measurements

A default generic measurement is automatically started when Measure is invoked. Each imaging mode supports several types of measurements, as described below. You can switch between these types using the touch screen buttons along the bottom of the touch screen. Some generic measurements have options for the method used to perform the measurement. When the current generic measurement has options available, you can view and change those options through the ***Tool Options*** touch screen buttons.

Note:

The generic measurements supported in each imaging mode may vary with different exam presets. The following sections describe all the generic measurements supported in each imaging mode.

8.1.1. B-mode Generic Measurements

The system supports the following types of generic B-mode measurements:

- Distance
- Circ/Area
- Angle
- Volume

- Stenosis

Distance: The distance measurement is always done with a caliper pair.

To measure Distance with a caliper pair:

1. Invoke the measure function on a B-mode image.
2. Select **Distance** from the touch screen.
3. Move the caliper to the start point.
4. Press the **<Set>** key to fix the start point.
5. Move the caliper to the end point.

Presses of the **<Update>** key will toggle between active calipers, allowing you to adjust the position of start point and end point.

6. Press the **<Set>** key to fix the end point and complete the measurement.

Circ/Area: Area and Circumference can be measured with an Ellipse or Trace tool.

To measure Area or Circumference with an Ellipse:

1. Invoke the measure function on a B-mode image.
2. Select **Circ/Area** from the touch screen.

If Ellipse is not the default tool, press **Tool Options** to switch to Ellipse.

3. Move the caliper to the start point.
4. Press the **<Set>** key to fix the start point.
5. Move the caliper and press the **<Set>** key to fix the end point. An ellipse appears and can be adjusted with the trackball.

Presses of the **<Update>** key will toggle between active calipers, allowing you to adjust the ellipse diameter.

6. Press the **<Set>** key to complete the measurement.

To measure Area or Circumference with a Trace:

1. Invoke the measure function on a B-mode image.
2. Select **Circ/Area** from the touch screen.

If Trace is not the default tool, press **Tool Options** to switch to Trace. Trace can be done with a Draw option. Draw will follow your movements.

3. Move the caliper to the start point.
4. Press the **<Set>** key to fix the start point and start drawing the trace.
5. Moving the caliper to mark the trace outline.
6. Press the **<Set>** key to complete the trace.

Angle: The Angle measurement is always done with an angle tool.

To measure Angle:

1. Invoke the measure function on a B-mode image.
2. Select **Angle** from the touch screen.
3. Move the caliper to the vertex of the angle you are measuring, and press the **<Set>** key to fix the first point.
4. Move the caliper to one end of the angle, and press the **<Set>** key to fix the second point.
5. Move the caliper to the other end of the angle.

Presses of the **<Update>** key will toggle between active calipers, allowing you to adjust the position of the three points that make up the angle.

6. Press the **<Set>** key to fix the third point and complete the angle measurement.

Volume: Volume can be measured with 3 Distances.

To measure Volume with 3 Distances:

1. Invoke the measure function on a B-mode image.
2. Select **Volume** from the touch screen.
3. Move the caliper to the start point.
4. Press the **<Set>** key to fix the start point.
5. Move the caliper to the end point.

Presses of the **<Update>** key will toggle between active calipers, allowing you to adjust the position of start point and end point.

6. Press the **<Set>** key to fix the end point and complete the measurement of the first distance.
7. Repeat step 3~6 to complete the measurements of the second and third distance. Then the Volume measurement result displays.

Stenosis: Stenosis can be measured with Caliper Pairs, Ellipses or Traces.

To measure Stenosis with Caliper Pairs:

1. Invoke the Measure Function on a B-mode image.
2. Select **Stenosis** from the touch screen.
3. Move the caliper to the start point.
4. Press the **<Set>** key to fix the start point.
5. Move the caliper to the end point.

Presses of the **<Update>** key will toggle between active calipers, allowing you to adjust the position of start point and end point.

6. Press the **<Set>** key to complete the measurement of the first distance.
7. Repeat step 3~6 to complete the measurement of the second distance. Then the Stenosis measurement result displays.

To measure Stenosis with Ellipses:

1. Invoke the Measure Function on a B-mode image.
2. Select **Stenosis** from the touch screen.
3. Move the caliper to the start point.
4. Press the **<Set>** key to fix the start point.
5. Move the caliper and press the **<Set>** key to fix the end point. An ellipse appears and can be adjusted with the trackball.
6. Press the **<Set>** key to complete the measurement of the first ellipse.
7. Repeat step 3~6 to complete the measurement of the second Ellipse. Then Stenosis measurement result displays.

To measure Stenosis with Traces:

1. Invoke the Measure Function on a B-mode image.
2. Select **Stenosis** from the touch screen.
If Traces is not the default tool, press **Tool Options** to switch to Traces.
3. Move the caliper to the start point.
4. Press the **<Set>** key to fix the start point and start drawing the trace.
5. Moving the caliper to mark the trace outline.
6. Press the **<Set>** key to complete the trace.
7. Repeat step 3~6 to complete the measurement of the second trace. Then Stenosis measurement result displays.

8.1.2. Strip Doppler Generic Measurements

The system supports the following types of generic strip Doppler measurements:

- Caliper
- Trace
- Auto Trace
- HR (Heart Rate)
- RI (Resistive Index)
- TEI
- dp/dt

Caliper. The Caliper measurement can provide a wide range of results, as shown below. The actual results displayed will depend on the results you selected in **Tool Options**.

- V1
- V2
- RI
- S/D
- Time
- ΔV
- Accel
- PG1
- PG2
- PHT

To use the Caliper measurement:

1. Invoke the Measure Function on a Doppler strip.
2. Select **Caliper** from the touch screen.
3. Move the caliper to the PS point.
4. Press the **<Set>** key to fix the PS point.
5. Move the caliper to the ED point.
Presses of the **<Update>** key will toggle between active calipers, allowing you to re-position

the PS point or ED point.

6. Press the **<Set>** key to fix the ED point and complete the measurement.

The S/D, PI, and PHT results assume that the first caliper is placed on the peak systolic point.

Trace: The Trace measurement can provide a wide range of results, as shown below. The actual results displayed will depend on the results you selected in **Tool Options**.

- PS
- ED
- MD
- TAMax
- PGmax
- PGmean
- PI
- RI
- S/D
- VTI
- Time
- AT
- DT

NOTE:

Trace measurement can only be activated on a frozen image.

To use the Trace measurement with a draw method:

1. Freeze the strip and invoke the Measure Function on a Doppler strip.
2. Select **Trace** from the touch screen. Trace can be done with a Draw. Draw will follow your movements
3. Move the caliper to the start point.
4. Press the **<Set>** key to fix the start point and start drawing the trace.
5. Moving the caliper to mark the trace outline.
Presses of the **<Update>** key will toggle between active calipers, allowing you to adjust the positions of the PS or ED points in the trace.
6. Press the **<Set>** key to complete the trace.

Auto Trace: Auto Trace is capable of measuring the maximum and/or mean blood flow on a frozen Doppler strip. Each result that it calculates is associated with either the maximum or the mean value. Auto Trace measurement can provide a wide range of results, as shown below. The actual results displayed will depend on the results you selected in **Tool Options**.

- PS
- ED
- MD
- TAMax
- TAMean
- PGmax

- PGmean
- PI
- RI
- S/D
- VTI
- Time
- AT
- DT
- HR

NOTE:

1. Auto trace measurement can only be activated on a frozen Doppler strip..
2. Live Auto Trace is available as a separate feature on the Doppler touch screen. To activate Auto Trace in real time mode, press **Auto Trace** button on PW touch screen.

To use the Auto Trace measurement:

1. Freeze the strip and invoke the Measure Function on a Doppler strip.
2. Select **Auto Trace** from the touch screen.
3. The trace waveform(s) automatically appear. If any maximum-related results are enabled then the maximum value waveform is displayed on the Doppler strip. If any mean-related results are enabled then the mean value waveform is displayed.

HR: The HR measurement tool can provide the heart rate calculation.

To use the HR measurement tool:

1. Invoke the Measure Function on a Doppler strip.
2. Select **HR** from the touch screen.
3. Move the caliper to the first heartbeat.
4. Press the **<Set>** key to fix the start point.
5. Move the caliper to the next beat.
Presses of the **<Update>** key will toggle between active calipers, allowing you to adjust the position of start point and end point.
6. Press the **<Set>** key to fix the end point and complete HR measurement.

RI: The RI measurement can provide a wide range of results, as shown below. The actual results displayed will depend on the results you selected in **Tool Options**..

- PS
- ED
- RI
- S/D

To use the RI measurement tool:

1. Invoke the Measure Function on a Doppler strip.
2. Select **RI** from the touch screen.
3. Move the caliper to the PS point.
4. Press the **<Set>** key to fix the PS point.

5. Move the caliper to the ED point.
Presses of the **<Update>** key will toggle between active calipers, allowing you to re-position the PS point or ED point.
6. Press the **<Set>** key to fix the ED point and complete RI measurement.

TEI: The TEI index measurement is useful for the assessment of ventricular systolic and diastolic function. Higher TEI index indicates decreased ventricular function.

To use the TEI measurement:

1. Invoke the Measure Function on a Doppler strip.
2. Select **TEI** from the touch screen.
3. Measure Time A (Mitral Valve Close-Open Duration) by caliper pairs.
4. Measure Time B (Ventricular Ejection Time) by caliper pairs.
5. The system calculates the TEI index automatically. The illustration is shown below:

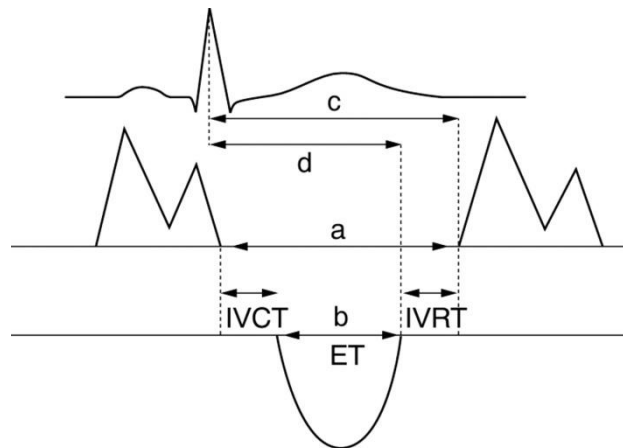

$$\text{Index} = \frac{a - b}{b} = \frac{(\text{IVCT} + \text{IVRT})}{\text{ET}}$$

dp/dt: The left ventricular dp/dt measurement is a useful index for evaluating myocardial contractility.

To use the dp/dt measurement:

1. Invoke the Measure Function on a Doppler strip.
2. Select **dp/dt** from the touch screen.
3. Move the caliper to the position at the 100 cm/s scale on one of the cardiac cycles and press the **<Set>** key.
4. Move the caliper to the position at 300 cm/s scale on the same cardiac cycle and press the **<Set>** key. The time difference "dt" between the two positions come out.
5. The system calculates dp/dt based on the "dt" value. *Formula:*

$$\text{dp/dt} = 32/\text{dt} \text{ (mmHg/s)}$$

8.1.3. M-mode Generic Measurements

The system supports the following types of generic M-mode measurements:

- Caliper
- HR (Heart Rate)

Caliper: The Caliper measurement can provide a wide range of results, as shown below:

- Distance
- Time
- Slope

To use the Caliper measurement:

1. Invoke the Measure Function on an M-mode strip.
2. Select Caliper from the touch screen.
3. Move the Caliper to the start point.
4. Press the **<Set>** key to fix the start point.
5. Move caliper to the end point.
Presses of the **<Update>** key will toggle between active calipers, allowing you to adjust the position of start point and end point.
6. Press the **<Set>** key to fix the end point and complete the measurement.

HR: The HR measurement tool can provide the heart rate calculation.

To use the HR measurement tool:

1. Invoke the Measure Function on an M-mode strip.
2. Select **HR** from the touch screen.
3. Move the caliper to the first heartbeat.
4. Press the **<Set>** key to fix the start point.
5. Move the caliper to the next beat.
Presses of the **<Update>** key will toggle between active calipers, allowing you to adjust the position of start point and end point.
6. Press the **<Set>** key to fix the end point and complete HR measurement.

8.2 Application Measurements

Application Measurements have a pre-defined meaning and can be entered into a report. The system supports the following application packages, each with its own set of measurements, calculations and report:

- OB (including multiple fetuses)
- Abd
- Vascular
- Cardiac
- Gynecology
- Small Parts
- Urology

When you select an application measurement from the touch screen it will automatically invoke the type of measurement it needs. For example, if you select “BPD” from the OB application it will automatically invoke a distance measurement. These measurements generally behave as described above for generic measurements. The results are entered into the report when the measurement is done.

Some application measurements can have multiple variations. For example, in a twin OB exam the OB measurements can be done on either fetus. As another example, in Vascular exams several measurements can be done in a Proximal, Mid, or Distal location. When a measurement has multiple variations, you will see buttons on the touch screen that let you pick which variation you are measuring.

Please refer to the Advanced User Manual for the calculation formulas and references.

8.2.1. Abdomen Measurements

Abdomen measurements include liver, gall bladder, pancreas, spleen, renal and Aorta Diam.

No.	Abdomen Measurement	Description	Tool	
Section 1: B-mode Measurements				
1.1	Liver	Liver L	Liver Length	Caliper
		Liver W	Liver Width	
		Liver H	Liver Height	
		Portal Vein	Portal Vein Diameter	
		CHD	Common Hepatic Duct	
1.2	Gall Bladder	GB L	Gallbladder Length	
		GB H	Gallbladder Height	
		GB wall th	Gallbladder wall thickness	
		CBD	Common Bile Duct	
1.3	Pancreas	Panc duct	Pancreatic duct	
		Panc head	Pancreatic head	
		Panc body	Pancreatic body	
		Panc tail	Pancreatic tail	
1.4	Spleen	Spleen L	Spleen Length	
		Spleen H	Spleen Height	
1.5	Renal	Renal L	Renal Length	
		Renal W	Renal Width	
		Renal H	Renal Height	
		Cortex	Renal Cortex thickness	
1.6	Aorta Diam	Aorta Diameter		
Section 2: Doppler Measurements				
2.1	AA	Abdominal Aorta	Caliper* Trace* Auto Trace*	
2.2	SMA	Superior Mesenteric Artery		
2.3	IMA	Inferior Mesenteric Artery		
2.4	HA	Hepatic Artery		
2.5	Splenic A	Splenic Artery		
2.6	Renal A	Renal Artery		
2.7	Portal V	Portal Vein	Caliper	
2.8	IVC	Inferior Vena Cava		
2.9	M Portal V	Main Portal Vein		
2.10	Hepatic V	Hepatic Vein		
2.11	M Hepatic V	Middle Hepatic Vein		
2.12	Splenic V	Splenic Vein		
2.13	SMV	Superior Mesenteric Vein		

No.	Abdomen Measurement	Description	Tool
2.14	IMV	Inferior Mesenteric Vein	

Table 8-1 Abdomen Measurement

* The tools can be switched by **Tool Options** in the touch screen after the Measurement is selected.

8.2.2. Gynecology Measurements

Gynecology measurements include uterus and ovary.

No.	Gynecology Measurement	Description	Tool
Section 1: B-mode Measurements			
1.1	Uterus	Uterus L	Uterus Length
		Uterus W	Uterus Width
		Uterus H	Uterus Height
		Endo	Endometrium Thickness
		UT-Cavity	Uterine Cavity Depth
1.2	Cervix	Cervix L	Cervix Length
		Cervix W	Cervix Width
		Cervix H	Cervix Height
1.3	Ovary	Ovary L	Ovary Length
		Ovary W	Ovary Width
		Ovary H	Ovary Height
1.4	Cyst**	Cyst D1	Cyst Distance 1
		Cyst D2	Cyst Distance 2
		Cyst D3	Cyst Distance 3
1.5	Follicle**	Fol. D1	Follicle Distance 1
		Fol. D2	Follicle Distance 2
		Fol. D3	Follicle Distance 3
1.6	Fluid POD	Fluid Pouch of Douglas	
Section 2: Doppler Measurements			
2.1	Ovary A	Ovary Artery	Caliper* Trace*
2.2	Ut. A	Uterine Artery	Auto Trace*

Table 8-2 Gynecology Measurements

*The tools can be switched by **Tool Options** in the touch screen after the Measurement is selected.

** The measurement method including 1 Distance, 2 Distances and 3 Distances can be configured in Measure Preset. See Section 10.3.5 for details.

8.2.3. Obstetrics Measurements

Obstetric measurements are used to calculate the GA (Gestation Age), EDD (Estimated Delivery Date) and EFW (Estimated Fetus Weight).

Multiple fetuses

The Obstetric package supports measurements and reports on up to four fetuses. If you know the number of fetuses at the start of the exam then you can enter this in the Patient page (see section 4.4). When the number of fetuses is known the system adjusts the user interface to optimize for that number. If no information is entered about the number of fetuses the system will assume there is one.

Except where noted below, every measurement and calculation supports multiple fetuses.

The system supports the B/D/M obstetric measurements.

No.	OB Measurement	Description	Tool
Section 1: B-mode Measurements			
1.1	GS	Gestational Sac	Caliper
1.2	YS	Yolk Sac	
1.3	CRL	Crown Rump Length	
1.4	NT	Nuchal Translucency	
1.5	NF	Nuchal Fold	
1.6	BPD	Biparietal Diameter	
1.7	OFD	Occipital Frontal Diameter	
1.8	HC	Head Circumference	
1.9	AC	Abdominal Circumference	Caliper
1.10	FL	Femur Length	
1.11	TAD	Transverse Abdominal Diameter	
1.12	APAD	Anteroposterior Abdominal Diameter	
1.13	CER	Cerebellum Diameter	
1.14	HUM	Humerus Length	
1.15	ULNA	Ulna Length	
1.16	RAD	Radius Length	
1.17	TIB	Tibia Length	
1.18	FIB	Fibula Length	
1.19	APTD	Anteroposterior Trunk Diameter	
1.20	TTD	Transverse Trunk Diameter	Ellipse* Trace*
1.21	FTA	Fetal Trunk Area	Caliper
1.22	THD	Thoracic Diameter	
1.23	Foot	Foot Length	

No.	OB Measurement	Description	Tool		
1.24	AF	Deepest Pocket			
1.25	AFI**	Q1	Amniotic Fluid Index	Caliper	
		Q2			
		Q3			
		Q4			
1.26	RV Diam	Right Ventricular Diameter	Caliper		
1.27	RA Diam	Right Atrium Diameter			
1.28	RVOT Diam	Right Ventricular Outflow Tract Diameter			
1.29	LV Diam	Left Ventricular Diameter			
1.30	LA Diam	Left Atrium Diameter			
1.31	LVOT Diam	Left Ventricular Outflow Tract Diameter			
1.32	Asc Aorta	Ascending Aorta Diameter			
1.33	Ao Arch Diam	Aorta Arch Diameter			
1.34	Ao Isthmus	Aorta Isthmus Diameter			
1.35	Desc Aorta	Descending Aorta Diameter			
1.36	MPA Diam	Main Pulmonary Artery			
1.37	Ductus A	Duct Arteriosus Diameter			
1.38	CTAR	A1	Cardio/Thorax area ratio	Cardio Area	Trace
		A2		Thorax Area	Ellipse
Section 2: Doppler Measurements					
2.1	MCA	Middle Cerebral Artery	Caliper* Trace* Auto Trace*		
2.2	Umb. A	Umbilical Artery			
2.3	Placenta A**	Placenta Artery			
2.4	Ductus V	Ductus Venosus	Caliper		
2.5	MV	Mitral Valve			
2.6	TV	Tricuspid Valve			
2.7	MPV	Main Pulmonary Vein			
2.8	Ductus A	Duct Arteriosus			
2.9	Ovary A**	Ovary Artery	Caliper* Trace* Auto Trace*		
2.10	Ut. A**	Uterine Artery			
2.11	Fetal Ao	Fetal Aorta			
2.12	Desc Aorta	Descending Aorta			
2.13	FHR***	Fetal Heart Rate (1 cycles)	Caliper		

No.	OB Measurement	Description	Tool
Section 3: M-mode Measurements			
3.1	FHR***	Fetal Heart Rate	Caliper

Table 8-3: OB Measurements

* The tools can be switched by **Tool Options** in the touch screen after the Measurement is selected.

**Multiple Fetuses N/A.

***System provides 1-8 cycles for HR measurement, depending on measurement setup.

8.2.4. Cardiac Measurements

No.	Cardiac Measurement	Description	Tool	
Section 1: B-mode Measurements				
1.1	LV Simpson	A4C Dias.	Left Ventricular apical four-chamber views at End-diastole	Simpson
		A4C Sys.	Left Ventricular apical four-chamber views at End-systole	
		A2C Dias.	Left Ventricular apical two-chamber views at End-diastole	
		A2C Sys.	Left Ventricular apical two-chamber views at End-systole	
1.2	Vent. Dim (Ventricular Diameter)	RVAWd	Right Ventricular Anterior Wall Thickness at End-diastole	Caliper
		RVIDd	Right Ventricular Internal Diameter at end-diastole	
		IVSTd	Interventricular Septal Thickness at End-diastole	
		IVSTs	Interventricular Septal Thickness at End-systole	
		LVIDd	Left Ventricular Internal Diameter at End-diastole	
		LVIDs	Left Ventricular Internal Diameter at End-systole	
		LVPWd	Left Ventricular Posterior Wall Thickness at End-diastole	
		LVPWs	Left Ventricular Posterior Wall Thickness at End-systole	
1.3	PV Diam	Pulmonary Valve Diameter		
1.4	RVDs	Right Ventricular Diameter at end-systole		
1.5	RA Length	Right Atrium Length Diameter		
1.6	RA Width	Right Atrium Width Diameter		
1.7	LA Length	Left Atrium Length Diameter		

No.	Cardiac Measurement	Description	Tool	
1.8	LA Width	Left Atrium Width Diameter		
1.9	Ao Asc	Ascending Aorta Diameter		
1.10	AoD	Aortic Root Diameter		
1.11	LVOT Diam	Left Ventricular Outflow Tract		
1.12	RVOT Diam	Right Ventricular Outflow Tract		
Section 2: Doppler Measurements				
2.1	MV(Mitral Valve)	E/A	E-wave Velocity/ A-wave Velocity	Caliper
		MV PHT	Mitral Valve Pressure Half Time	
		MV Trace	Mitral Valve Trace	Trace
		IVRT	Isovelocity Relaxation Time	Caliper
		MV A Dur	Mitral Valve A-wave Duration	
		MV DecT	Mitral Valve Deceleration Time	
2.2	TV(Tricuspid Valve)	TV Trace	Tricuspid Valve Trace	Trace
		TV Vmax	Tricuspid Valve Maximum Velocity	Caliper
2.3	AoV(Aortic Valve)	LVOT Trace	Left ventricular outflow tract Trace	Trace
		LVOT Vmax	Left ventricular outflow tract maximum Velocity	Caliper
		AoV Trace	Aortic Valve Trace	Trace
		AoV Vmax	Aortic Valve maximum Velocity	Caliper
2.4	PV (Pulmonic Valve)	PV Trace	Pulmonic Valve Trace	Trace
		PV Vmax	Pulmonic Valve maximum Velocity	Caliper
2.5	P Vein (Pulmonic Vein)	PVein S Vel	Pulmonic Veins Systole Velocity	Caliper
		PVein D Vel	Pulmonic Veins Diastole Velocity	
		PV A Vel	A Point Reverse Velocity	
2.6	HR**	Heart rate	Caliper	
Section 3: M-mode Measurements				
3.1	Vent. Dim (Ventricular Diameter)	RVAWd	Right Ventricular Anterior Wall Thickness at End-diastole	Caliper
		RVIDd	Right Ventricular Internal Diameter at end-diastole	
		IVSTd	Interventricular Septal Thickness at End-diastole	
		LVIDd	Left Ventricular Internal Diameter at End-diastole	
		LVPWd	Left Ventricular Posterior Wall	

No.	Cardiac Measurement	Description	Tool
		Thickness at End-diastole	
	IVSTs	Interventricular Septal Thickness at End-systole	
	LVIDs	Left Ventricular Internal Diameter at End-systole	
	LVPWs	Left Ventricular Posterior Wall Thickness at End-systole	
3.2	LVET	Left Ventricular Ejection Time	
3.3	MV(Mitral Valve)	E-F Slope	Mitral Valve E-F slope
		EPSS	E point septal separation
3.4	LA/Ao	LA	Left atrial diameter
		AoD	Aortic root diameter
		RVOT Diam	Right Ventricular outflow tract
3.5	HR**	Heart rate	

Table 8-4 Cardiac Measurements

* The tools can be switched by **Tool Options** in the touch screen after the Measurement is selected.

**System provides 1-8 cycles for HR measurement, depending on measurement setup.

Simpson’s Method of Disks (MOD)

Simpson’s MOD is a method used to calculate LV diastolic and systolic volumes and ejection fraction. Simpson’s MOD is available in the Cardiac presets.

To use the Simpson’s MOD measurement:

1. Invoke the B-mode Measure function.
2. Select **LV Simpson** measurement on the touch screen and then select one measurement label from **A4C Dias.**, **A4C Sys.**, **A2C Dias.**, and **A2C Sys.**.A single caliper will be displayed on the image field.
3. Move the caliper and press **<Set>** key to position the start point A at one end of left ventricular long axis.
4. Draw the trace along the endocardium of the left ventricle.
5. Press **<Set>** key to fix the end point B and complete the trace. A new caliper positions automatically at the apex (Point D) of the trace, connecting the Point C (Midpoint of point A and B). This distance between point C and D is the longest detected by the system, as shown below:

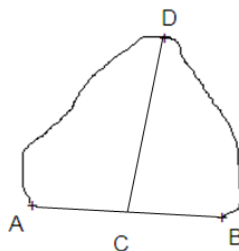

6. Pivot the Point D caliper to a new desired position if necessary.
7. Press **<Set>** key to complete the measurement.

8.2.5. Small Parts Measurements

Small Parts measurements include thyroid and breast.

No.	Small Parts Measurement	Description	Tool	
Section 1: B-mode Measurements				
1.1	Thyroid	THY L	Thyroid Length	Caliper
		THY W	Thyroid Width	
		THY H	Thyroid Height	
		Isthmus	Thyroid Isthmus	
1.2	Breast	Lesion 1	Breast Lesion 1	
		Lesion 2	Breast Lesion 2	
		Lesion 3	Breast Lesion 3	
		Lesion 4	Breast Lesion 4	
		Lesion 5	Breast Lesion 5	
1.3	Testis	Testis L	Testis Length	
		Testis W	Testis Width	
		Testis H	Testis Height	
Section 2: Doppler Measurements				
2.1	STA	Superior Thyroid Artery	Caliper* Trace*	
2.2	ITA	Inferior Thyroid Artery	Auto Trace*	

Table 8-5 Small Parts Measurement

* The tools can be switched by **Tool Options** in the touch screen after the Measurement is selected.

8.2.6. Urology Measurements

Urology measurements include renal, bladder, prostate, seminal and testicle.

No.	Urology Measurement	Description	Tool	
Section 1: B-mode Measurements				
1.1	Renal	Renal L	Renal Length	Caliper
		Renal W	Renal Width	
		Renal H	Renal Height	
		Cortex	Renal Cortex thickness	
1.2	Bladder	Pre-BL L	Pre-void Bladder Length	

No.	Urology Measurement	Description	Tool
		Pre-BL W	Pre-void Bladder Width
		Pre-BL H	Pre-void Bladder Height
		Post-BL L	Post-void Bladder Length
		Post-BL W	Post-void Bladder Width
		Post-BL H	Post-void Bladder Height
1.3	Prostate	Prostate L	Prostate Length
		Prostate W	Prostate Width
		Prostate H	Prostate Height
1.4	Seminal	Seminal L	Seminal Length
		Seminal W	Seminal Width
		Seminal H	Seminal Height
1.5	Testis	Testis L	Testis Length
		Testis W	Testis Width
		Testis H	Testis Height
Section 2: Doppler Measurements			
2.1	Renal A	Renal Artery	Caliper* Trace* Auto Trace*
2.2	Arcuate A	Arcuate Artery	
2.3	Seg. A	Segmental Artery	
2.4	Int. A	Interlobar Artery	

Table 8-6 Urology Measurements

* The tools can be switched by **Tool Options** in the touch screen after the Measurement is selected.

8.2.7. Vascular Measurements

Vascular measurements include IMT in B-Mode, Carotid and Artery in Doppler Mode.

No.	Vascular Measurement	Description	Tool
Section 1: B-mode Measurements			
1.1	CCA IMT	Common Carotid Artery Intima-Media Thickness	Caliper
1.2	ICA IMT	Internal Carotid Artery Intima-Media Thickness	
1.3	BIF IMT	Carotid Artery Bifurcation Intima-Media Thickness	
1.4	VF Area	Volume Flow Area	
Section 2: Doppler Measurements			
2.1	CCA	Common Carotid Artery	Caliper* Trace* Auto Trace*
2.2	ECA	External Carotid Artery	
2.3	ICA	Internal Carotid Artery	

No.	Vascular Measurement	Description	Tool	
2.4	VA	Vert Artery		
2.5	SUBC A	Subclavian Artery		
2.6	Axill A	Axillary Artery		
2.7	Brach A	Brachial Artery		
2.8	Ulnar A	Ulnar Artery		
2.9	Radial A	Radial Artery		
2.10	CFA	Common Femoral Artery		
2.11	DFA	Deep Femoral Artery		
2.12	SFA	Superficial Femoral Artery		
2.13	CIA	Common Iliac Artery		
2.14	EIA	External Iliac Artery		
2.15	IIA	Internal Iliac Artery		
2.16	Pop A	Popliteal Artery		
2.17	Peron A	Peroneal Artery		
2.18	PTA	Posterior Tibial Artery		
2.19	ATA	Anterior Tibial Artery		
2.20	DPA	Dorsalis Pedis Artery		
2.21	SUBC V	Subclavian Vein		Caliper
2.22	Axill V	Axillary Vein		
2.23	Brach V	Brachial Vein		
2.24	Cepha V	Cephalic Vein		
2.25	Basilic V	Basilic Vein		
2.26	Ulnar V	Ulnar Vein		
2.27	Radial V	Radial Vein		
2.28	M Cubital V	Median Cubital Vein		
2.29	CFV	Common Femoral Vein		
2.30	DFV	Deep Femoral Vein		
2.31	SFV	Superficial Femoral Vein		
2.32	CIV	Common Iliac Vein		
2.33	EIV	External Iliac Vein		
2.34	IIV	Internal Iliac Vein		
2.35	Saph V	Great Saphenous Vein		
2.36	Pop V	Popliteal Vein		
2.37	Peron V	Peroneal Vein		
2.38	PTV	Posterior Tibial Vein		

No.	Vascular Measurement	Description	Tool
2.39	ATV	Anterior Tibial Vein	
2.40	SSV	Small Saphenous Vein	
2.41	HR**	Heart Rate	
2.42	VF TAMean	Volume Flow Time Average Mean Velocity	Auto Trace
2.43	ACA	Anterior Cerebral Artery	Auto Trace
2.44	MCA	Middle Cerebral Artery	
2.45	PCA	Posterior Cerebral Artery	
2.46	ACoA	Anterior Communicating Artery	
2.47	PCoA	Posterior Communicating Artery	
2.48	BA	Basilar Artery	
2.49	VA	Vertebral Artery	
2.50	ICA	Internal Carotid Artery	

Table 8-7 Vascular Measurements

* The tools can be switched by **Tool Options** in the touch screen after the Measurement is selected.

**System provides 1-8 cycles for HR measurement, depending on measurement setup.

8.3 Worksheet and Report

Worksheet is available at any time during an exam, and is displayed as default on the main screen. Report contains the information from a worksheet but it is formatted in a slightly different manner.

8.3.1. Worksheet

To view a worksheet:

Press **<Report>** key on the console to open worksheet screen. A worksheet includes: Patient Information, Measure/Calculation data and Comments.

page: 1/6

2D Measurements						
	Value	V1	V2	V3	V4	Method
Liver						
Length	45.04mm	45.04				Avg. -
Width	58.11mm	58.11				Avg. -
Height	53.13mm	53.13				Avg. -
Portal V.Diam.	50.15mm	50.15				Avg. -
CHD	70.86mm	70.86				Avg. -
Gall Bladder						
Length	56.75mm	56.75				Avg. -
Height	42.00mm	42.00				Avg. -
GB wall thick	55.85mm	55.85				Avg. -
CBD	35.00mm	35.00				Avg. -
Pancreas						
Duct						-
Head						-
Body						-
Tail						-
Spleen						
Length						-

Figure 8-3 2D Worksheet Main Screen Display

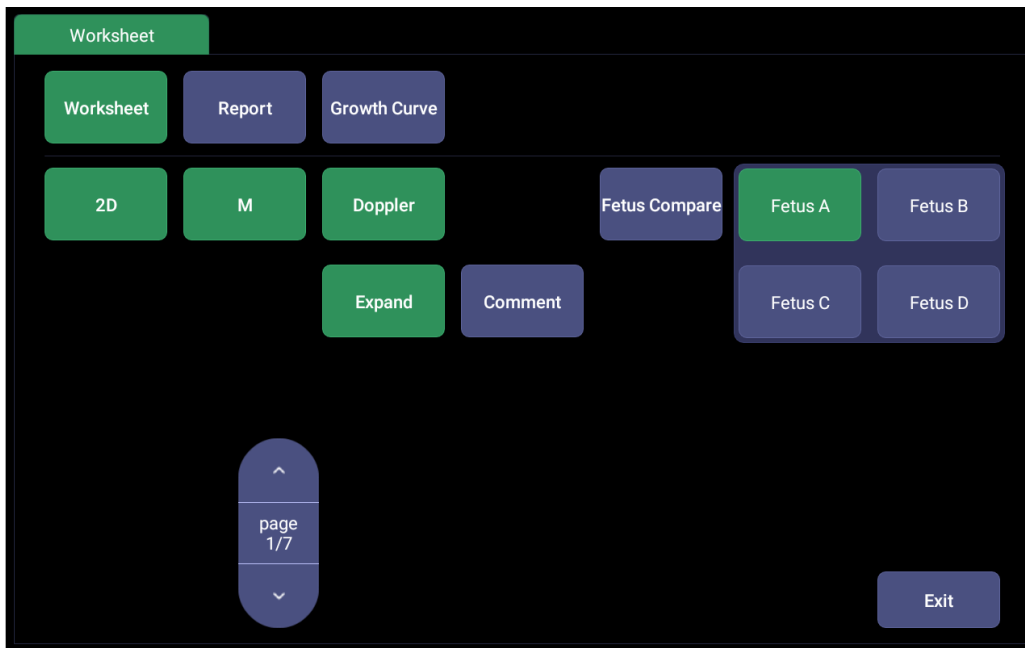

Figure 8-4 Worksheet Touch Screen Display(OB as Example)

There is a group of radio button that includes: **Report**, **Worksheet** and **Growth Curve**.

Note: Radio Buttons are buttons where only one is active at any time. Activating one will de-activate all others

- ◆ Press **Report** button on the touch screen to get the report page.
- ◆ Press **Worksheet** button on the touch screen to switch back to the worksheet page.
- ◆ Press **Growth Curve** button on the touch screen to access the fetal growth curves. It is only available in OB worksheet, and is not displayed for any other preset.
- **2D, M, Doppler:** Press these buttons to display or hide separate measurement data by image modes. The three buttons are on status as default, and user can switch it to off associated section. Each of these sections will start to display on a new page in worksheet.
- **Expand:** Press to expand and list all available measurements of current measure preset no matter whether it is measured or not when it is on, and contracts unmeasured items when it is off. All those measured items are always displayed, regardless it is in current measure preset or not.
- **Comment:** Press to display or hide comment section. This is an editable field for user to type any diagnosis or treatment comments.
- **Fetus Compare:** Click it to get the pages to compare multiple fetus data in one page. It only shows summary data for each fetus. It is available only in multiple fetus situations.
- **Fetus A, Fetus B, Fetus C, Fetus D:** There is a group of radio button to switch fetus, and worksheet main screen page shows data of selected fetus. It is only available in multiple fetus situations, and the number of enabled button equals current fetus number which is determined in patient information page.
- **Page:** Press to switch worksheet page in multiple pages. This is disabled when there is only one page.

To edit a worksheet:

Move the cursor over an editable field such as a measurement result, and press the **<Set>** key. A touch QWERTY is automatically invoked. Type in your changes and press the **Enter** key to save the changes. After editing a result, an "underline" will be displayed below the value to indicate this is a

manually edited value.

page: 1/6

2D Measurements						
	Value	V1	V2	V3	V4	Method
Liver						
Length	45.04mm	45.04				Avg. ▾
Width	58.11mm	58.11				Avg. ▾
Height	53.13mm	53.13				Avg. ▾
Portal V.Diam.	50.15mm	50.15				Avg. ▾
CHD	70.86mm	70.86				Avg. ▾
Gall Bladder						
Length	56.79mm	56.79				Avg. ▾
Height	42.02mm	42.02				Avg. ▾
GB wall thick	55.85mm	55.85				Avg. ▾
CBD	35.00mm	35.00				Avg. ▾
Pancreas						
Duct						▾
Head						▾
Body						▾
Tail						▾
Spleen						
Length						▾

Figure 8-5 Editing a measurement in Worksheet

8.3.2. OB Worksheet

Please see previous section for an overview of reports and worksheets. This section describes worksheet capabilities that are unique to OB. Figure 8-7 shows an example of the OB worksheet.

Fetus:A/4 page: 1/7

LMP	11/01/1969 A	Clinical GA	8 W 5 D	Clinical EDD	08/08/1970
		GA(CUA)	17w2d B	EDD(CUA)	06/08/1970 C
FetusPos		PLAC			

2D Measurements										
	GA	EDD	Value	V1	V2	V3	V4	Method D	Reference	CUA E
BPD	16w5d	06/13/19...	34.80mm	34.80				Avg. ▾	Hadlock ▾	<input checked="" type="checkbox"/>
HC	15w5d	06/20/19...	116.15mm	116.15				Avg. ▾	Hadlock ▾	<input checked="" type="checkbox"/>
AC	16w6d	06/12/19...	109.33mm	109.33				Avg. ▾	Hadlock ▾	<input checked="" type="checkbox"/>
FL	20w1d	05/19/19...	32.61mm	32.61				Avg. ▾	Hadlock ▾	<input checked="" type="checkbox"/>
HUM								-	-	<input type="checkbox"/>
CER								-	-	<input type="checkbox"/>
FTA								-	-	<input type="checkbox"/>
THD								-	-	<input type="checkbox"/>

EFW	224±32g	Hadlock4(AC,BPD,FL,HC) F
-----	---------	---------------------------------

2D Measurements						
	Value	V1	V2	V3	V4	Method
Liver						

Figure 8-6 OB Worksheet With **Expand** on.

- A: LMP: The LMP is displayed on the first page of the report. If the LMP was entered on the Patient page that date is transferred to here.
- B: GA: Two different versions of the GA are displayed:
- Clinical GA: Calculated from the LMP.
 - GA(CUA) or GA(AUA): Displays Composite Ultrasound Age(CUA) or Average Ultrasound Age(AUA), depending the Default GA display configured in Measure Preset(see section 10.3.5 for details).
- C: EDD: Two different versions of the EDD are displayed based on the two GA values.
- D: Reference: Change the equation used to calculate the GA.
- E: CUA/AUA: These checkboxes let you decide which results are included in the CUA or AUA calculation. CUA is calculated from the selected BPD, HC, AC and/or FL measurement result; AUA is the averaged value of the selected GAs calculated from single parameter including BPD, HC, AC, FL etc. Whether CUA or AUA is displayed depends on the Default GA display configured in Measure Preset(see section 10.3.5 for details).
- F: EFW reference: Change the equation used to calculate the estimated fetal weight.

8.3.3. Growth Curve

OB Growth Curve indicates predicted fetal growth patterns according to the selected reference for a measurement or calculation. A growth curve graph can display information acquired in the current exam. Multiple fetus data can be display in the same graphic to compare their growth trending details. For each growth curve graph, there is a drop-down list for selecting specific measurement or calculation, and a drop-down list for selecting specific reference of selected measurement or calculation. Selecting one of them, the growth curve graph will change accordingly.

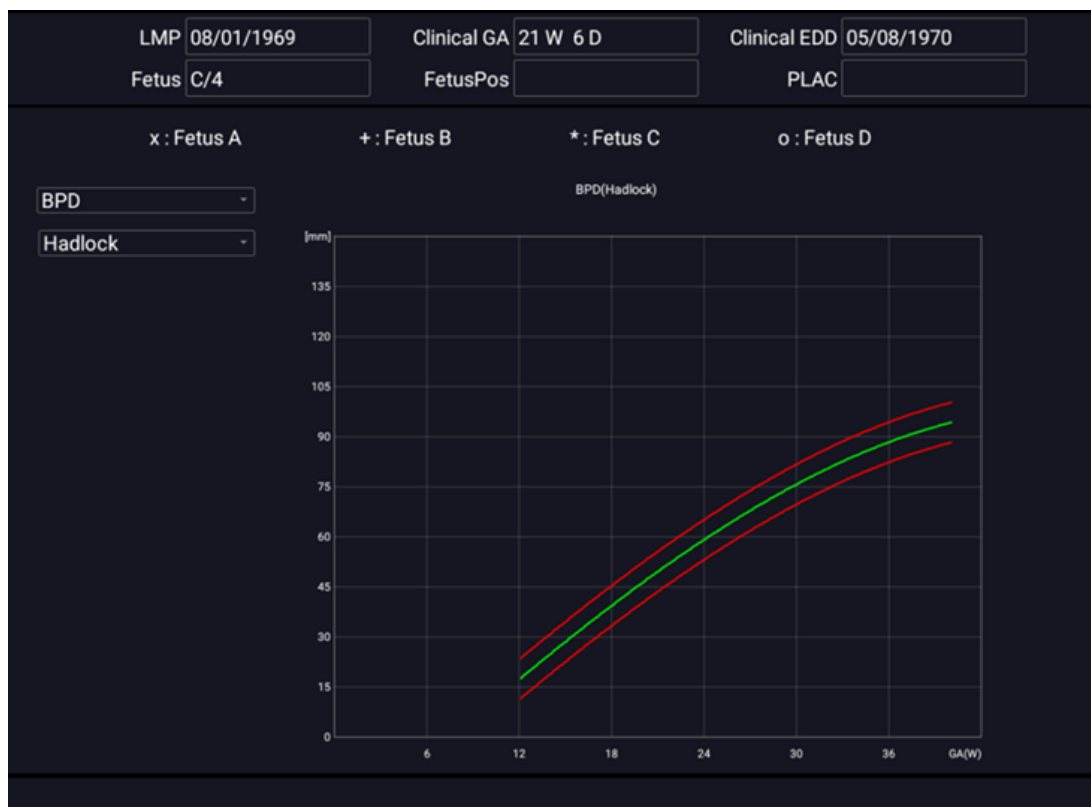

Figure 8-7 Growth Curve Graph

To view a growth curve graph:

Press the **<Report>** hard key to enter the Worksheet, and then press the **Growth Curve** button on the touch screen to display the Growth Curve Graph.

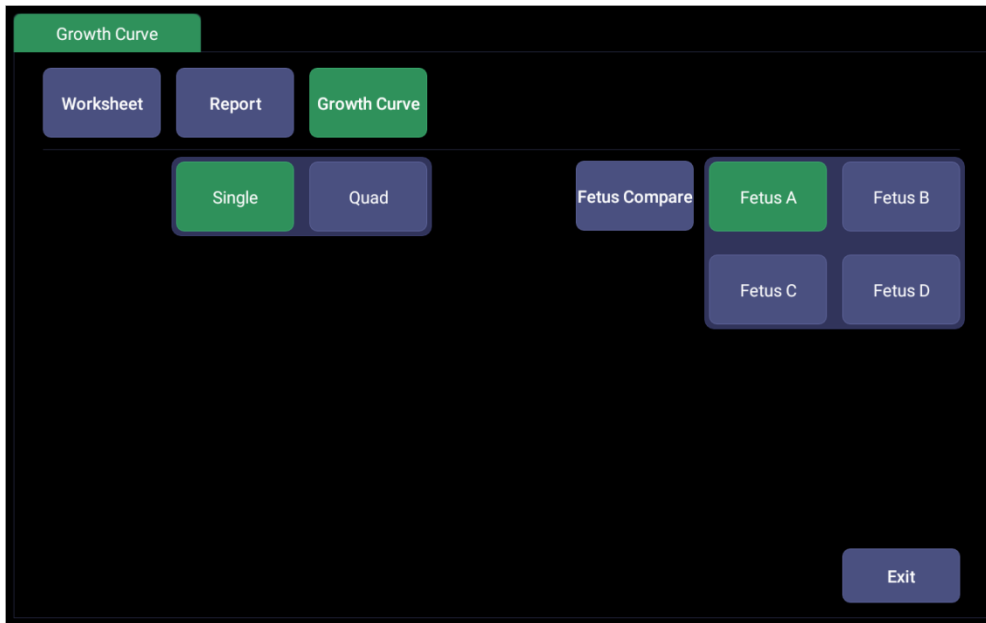

Figure 8-8 Growth Curve Touch Screen

Following controls are invoked by **Growth Curve** button.

- **Single/Quad:** press to select the number of the growth curve graph for display.

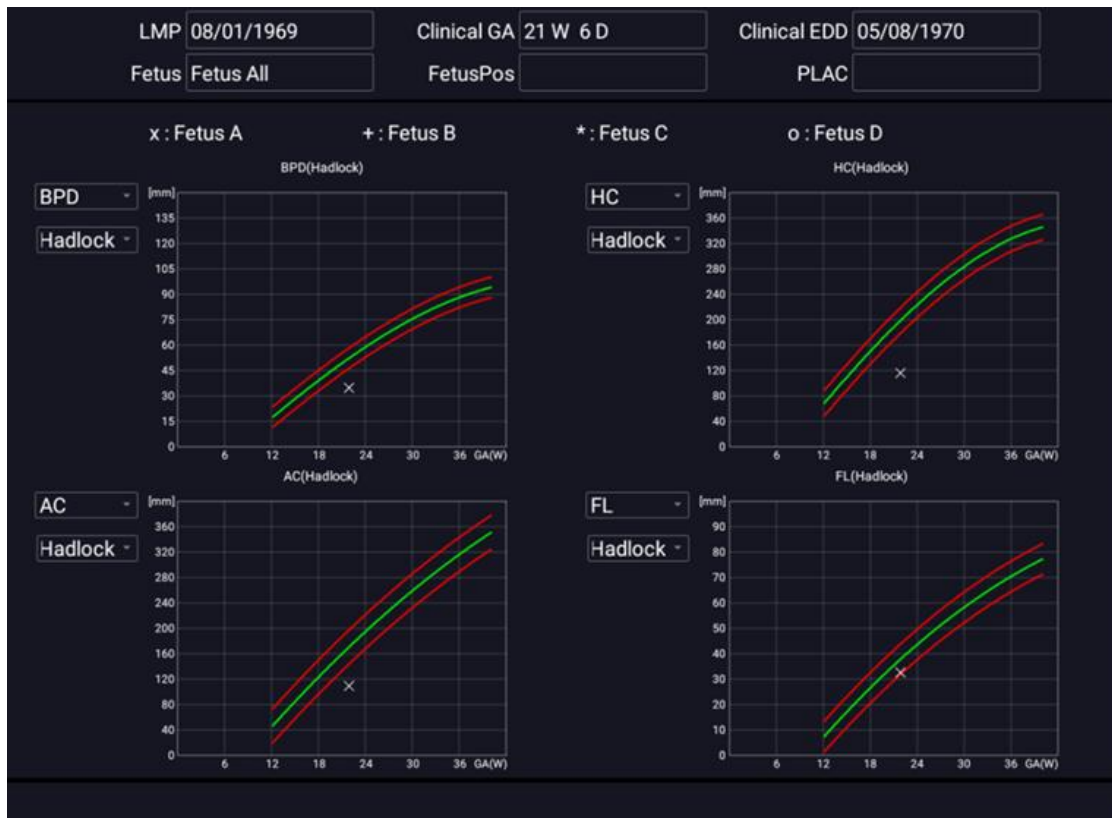

Figure 8-9 Quad Growth Curve Graph

- **Fetus Compare:** Press to display multiple fetus data in the same graphic for comparing their

data directly .It appears only in multiple fetus situations, and the fetus number is determined by which is entered in patient information.



Figure 8-10 Comparing fetus in a growth curve graph

- **Fetus A, Fetus B, Fetus C, Fetus D:** There is a group of radio button to switch fetus, and the growth curve graph shows data of selected fetus. It is only available in multiple fetus situations, and the number of enabled button equals current fetus number which is determined in patient information page. It is disabled when **Fetus Compare** is on.

8.3.4. Report

Press the <Report> hard key to enter the Worksheet, and then press the **Report** button on the touch screen to display the Report screen. A report includes: Header, Patient Information, Images, Measurement/Calculation data, Comments and Sonographer signature .



Figure 8-11 Report Main Screen

The middle part of the main screen is the general layout of a report.

On the left side of the main screen, you can set the layout of the report:

- **Auto Adjust:** Automatically adjusts the layout of the report.
- **Image Column:** Selects the column number and the images will be displayed accordingly.

On the right side of the main screen, you can select images to add into the report. Maximum 21 images can be added to the report.

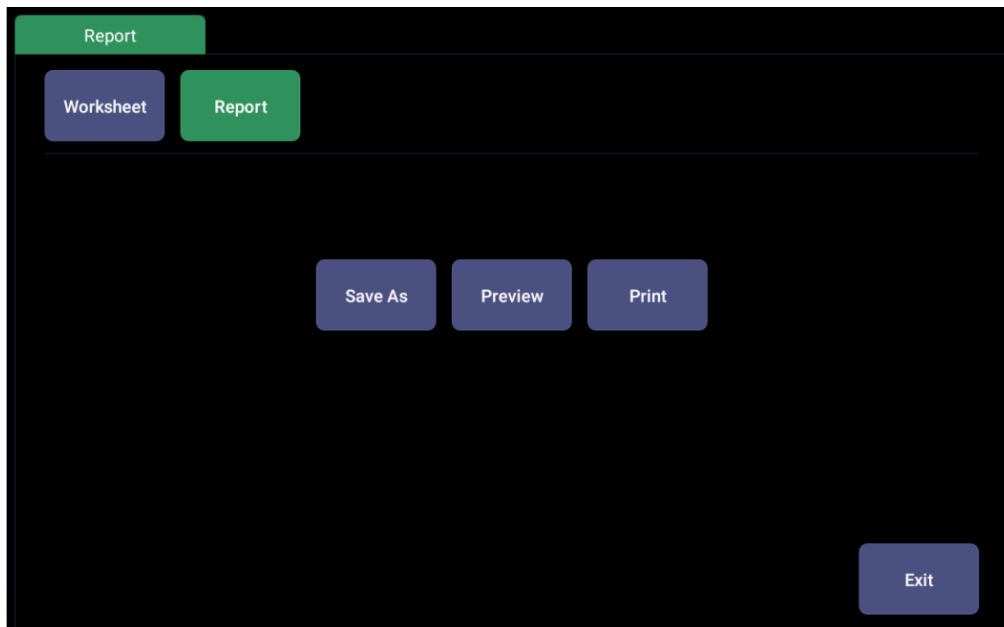

Figure 8-12 Report Touch Screen

Save As: Press it to store the report as PDF file to external storage.

Preview: Press it to invoke print preview before print. Then switching report pages and zooming in report are supported.

Print: Press it to print the report when connecting a USB report printer.

8.4 Measurement Accuracy

Parameter	Range	Accuracy
1.B Mode Measurement		
Distance	Full Screen	< $\pm 5\%$
Circumference (Ellipse)	Full Screen	< $\pm 5\%$
Circumference (Trace)	Full Screen	< $\pm 5\%$
Area (Ellipse)	Full Screen	< $\pm 10\%$
Area (Trace)	Full Screen	< $\pm 10\%$
Angle	Full Screen	< $\pm 3\%$
2. M Mode Measurement		
Distance	Full Screen	< $\pm 5\%$
Time	Timeline display	< $\pm 5\%$
HR	Timeline display	< $\pm 5\%$
3. Doppler Mode Measurement		
Velocity(PW mode)	10-200cm/s	When angle $\leq 60^\circ$, < $\pm 10\%$
Velocity(CW mode)	10-200cm/s	When angle $\leq 60^\circ$, < $\pm 10\%$
Time	Timeline display	< $\pm 5\%$
HR	Timeline display	< $\pm 5\%$

Table 8-9 Measurement accuracy

9 Exam Data Management

9.1 Storing Images

The system supports storing static images and cine clips. What is displayed in Information area, Image area and Image parameter area on the main screen will be stored.

Storing static images:



Pressing the  hard key on the console will always capture what is on the image area of the screen. This includes live, frozen, or Cine images. It also includes reports or other GUI screens and review.

Storing a clip:



Pressing the  hard key on the console will capture the moving images in scanning or cine review status.

➤ Live Store

Live store is to capture the moving images in image scanning status. The system continues scanning while storing.



The store starts with the press of the  hard key and continues for the configured length of the clip or until the clip store is interrupted. The length of the clip can be configured by setting the **Duration for prospective** on the **Store/Print** page (See section 11.1.3 for details).

➤ Frozen Store

Frozen store is to store the cine clip between the start frame and end frame when in cine review status.



Freeze the image and press the  hard key to start storing. The default length of the cine clip between start frame and end frame can be configured by setting the **Duration for retrospective** on the **Store/Print** page(See section 11.1.3 for details). Or, you can manually change the start frame or end frame to determine the clip length.

9.2 Reviewing Images





To enter image review:

If Static or Clip images have been stored for the current exam, then they can be reviewed by pressing the <Review> hard key on the console. The review touch screen is shown as the figure below.

NOTE: If nothing has been stored in the current exam, then the **Review** hard key will invoke the Exam Database function (see the next section).

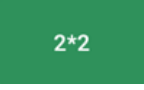

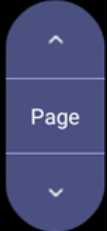
Figure 9-1 Review Touch Screen

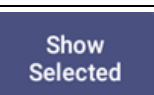
Button	Description
  	Change the displayed layout: 4*4, 2*2, 1*1, 2*3
	Turn pages to move forward or backward through the available images, one page at a time.
	Select all the images in the current exam.
	Toggle between showing all images and only showing the selected images.

<p>Delete</p>	<p>Delete the selected image.</p>
<p>Export</p>	<p>Export selected images to a removable media currently available. Plug in a USB disk, select an image, press this button and the following confirmation dialog pop-up:</p>  <p>Select the export path from destination drop list menu, select the export format and click OK to export.</p> <p>If there is no USB plugged in, the Export button is unavailable.</p> <p>Note: Cine clips are not supported to export in AVI and DICOM format for this release.</p>
<p>RawData</p>	<p>Load the raw data of the selected image or clip for post-processing. On the touch screen, press the mode tabs, for example "B Mode", to adjust the imaging parameters for post-processing images.</p> <p>Note: The Dual image/clip can not be loaded to review in this release.</p>
<p>Exit</p>	<p>Exit review function.</p>

Table 9-1 Review Touch Screen Controls

9.3 Exam Database

The Exam Database provides a list of recently performed studies. It can be accessed by pressing the <Review> hard key on the console when there is no active exam.

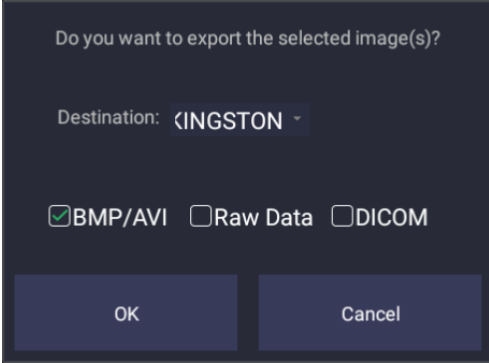

Figure 9-2 Exam Database Main Screen

The main part of the display shows a list of studies. Clicking on the header of a field will sort the list by that field. Fields can be displayed or hidden.

Filter:

The database filter field at the top-left of the screen provides a powerful tool to find the study of interest. It filters the list based on the text that is typed in this field. The filter applies to all fields. By default the filter is set to blank, so the default list shows all exams.

Storage Size:

There is a box displaying current disk usage. It contains text with the current usage and is filled with a solid color to the extent that the current capacity is used. The text shows “<current usage> of <total capacity>”. The units are “Mb” for values less than 1 Gb, and “Gb” for anything larger. The solid color fill is green when usage is less than 75% of capacity, yellow for usage between 75% and 95%, and red when disk usage is above 95%.

Destination:

The location where the highlighted exam(s) shall be exported, including all configured network locations and any writable USB disk currently available. This includes:

- Available DICOM server location(s). (See 11.2.2)
- Any inserted USB disk.

Export Format:

This location displays export format for static images and clips. **BMP, Raw Data** and DICOM formats are available for static images. AVI, Raw Data and DICOM formats are available for clips.

Note: Cine clips are not supported to export in AVI and DICOM formats for this release.

Send:

Pressing this button will send the selected exam(s) to the destination. This button is available when one or more exams are selected.

Working with one study:

A study is selected by clicking on it. When a study is selected thumbnail images from that study are shown on the right side of the screen. Operations such as reviewing and restarting of the selected study can be accessed on the touch screen.

A study can also be send to a DICOM server, saved to a USB device, or deleted. If the study has been copied to either a server or to a USB device a small disk icon appears next to it, indicating that it has been saved.

CAUTION:

- Studies stored on the system hard drive should be archived regularly. The system is not intended for long term storage of patient information. Confirm successful archiving before deleting a study from the hard drive.

Working with multiple studies:

Multiple studies can be selected by clicking the small box at the left of each listed study. Multiple studies can be stored to a DICOM server, saved to a USB device or deleted. Only one study can be reviewed at a time.

9.4 Archiving Studies

All Clips and Static images stored on the system are stored internally in Raw Data format. They can be archived to other storage device for long-term storage in .bmp, .avi, .dcm and Raw Data formats as described below.

- The study can be sent to a DICOM server. In this case the images are in DICOM (.dcm) format.
- The study can be saved to an USB. In this case the images can be stored as either DICOM, Raw Data or .bmp/.avi format.

Note: Cine clips are not supported to export in AVI and DICOM formats for this release.

Sending a study to DICOM server:

1. Configure a DICOM server. See Section 11.2.2 for details.
2. From the exam database screen, select a study or multi-studies.
3. Select a configured DICOM server from the **Destination** drop-down list.
4. Press **Send**.

Saving a study to USB

1. Plug the device into a USB port.
2. From the exam database screen, select a study or multi-studies.
3. Select the USB device from the **Destination** drop-down list.
4. Select the Export Formats and Press **Send**.

10 Presets

10.1 Preset Organization

The Presets are divided into two levels: the Exam Presets and Application Presets.

Exam Preset: Each transducer has its own set of Exam Presets. Each Exam Preset contains:

- The image parameters that optimize its transducer for an intended use.
- The list of data fields displayed on the patient demographic page.
- Pointers to Application Presets for Comments, Measurements, and Body Marks.

Application Preset: The Application Presets are independent from the transducer. Application Presets are used to select Comments, Body Marks and Measurements. Since they are independent from the transducer, several Exam Presets can use the same Application Preset.

Figure 10-1 shows an example of how Transducers, Exam Presets, and Application Presets are related. For simplicity, this shows just a few of the items that are on the real system. In this example the C5-2Q and the E8-4Q both have an OB Exam Preset. The C5-2Q OB Exam Preset optimizes the C5-2Q imaging for OB while the E8-4Q OB Exam Preset optimizes the E8-4Q for the same use. The parameters used for each transducer can be different, and changing one Exam preset does not change the other.

However, both OB Exam Presets point to the same OB Measurement Preset as the Application Preset. This means you can, for example, just configure OB measurements once, and both the C5-2Q and E8-4Q will have updated OB measurements.

This example just shows a single kind of Application Preset. The system actually has separate Application presets for Comments, Body Marks and Measurements. The same principle applies to each of these: application presets can be shared across exam presets and transducers.

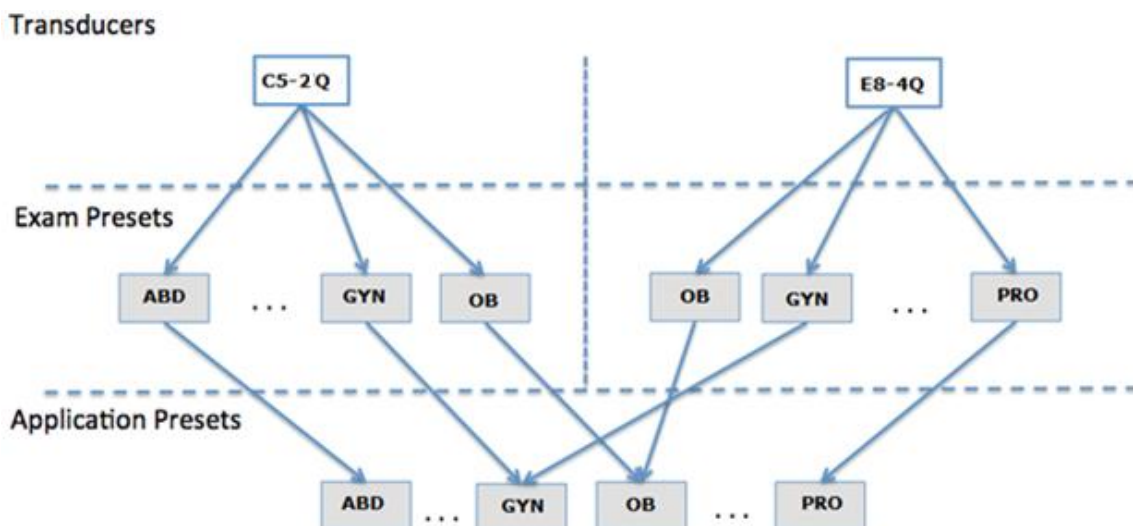

Figure 10-1 Preset Organization

10.2 Selecting a Preset

Pressing the **<Transducer>** key on the console will open the **Transducer** touch screen. See figure 10-2 for an example Transducer touch screen. The currently active transducer is shown at the top of the touch screen. Below it are all the presets associated with that transducer. Pressing any preset button selects that preset, recalling its parameters for system use.



Figure 10-2 Example Preset Screen

10.3 Storing and Editing a Preset

There are two ways to store or modify an exam preset: Snapshot and Editing.

Snapshot:

- Select the exam preset you want to modify or use as the basis for a new preset.
- Make any changes you want to system settings using the standard imaging UI.
- Press the **<Transducer>** key on the console.
- Press the **Save** button on the touchscreen to update the current exam preset with the new setting.
- Press the **Save As** button to create a new preset and rename the preset.

Editing:

You can directly view and change the settings for any preset using the Set-up function.

- Click the Utility icon  on the status bar.
- Press **Presets** to display the preset touch screen, as shown below, which provides access to configuring Exam, Image, Comment, Body Mark and Measure presets. See the following sections for details.

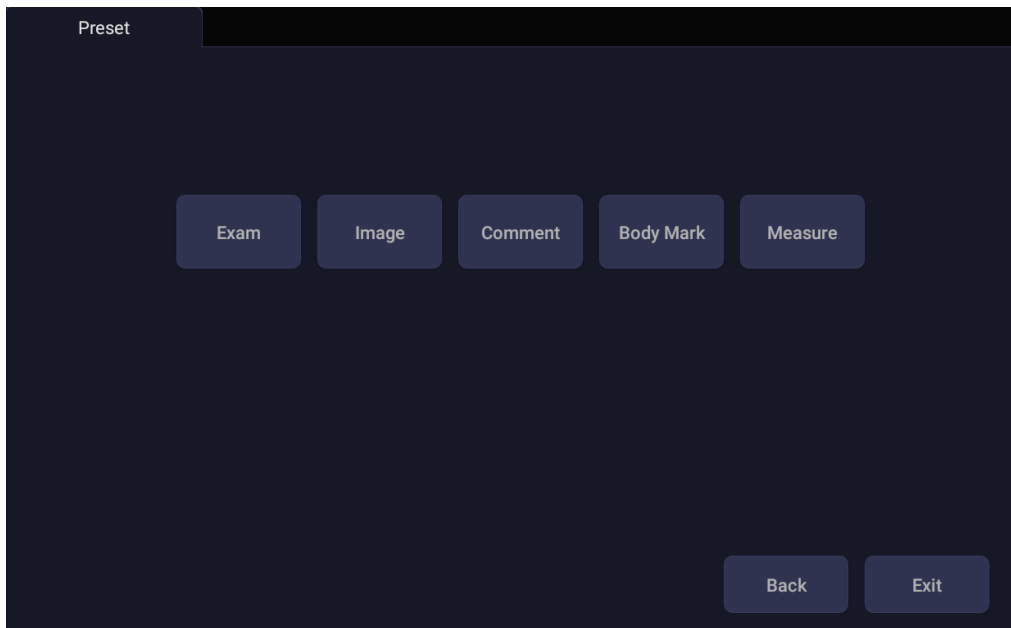

Figure 10-3 Preset Main Screen

10.3.1. Exam Preset

Figure 10-4 shows an example of the exam preset page where you can configure which Comment, Measure, Body Mark or Patient info presets are associated with each exam preset.

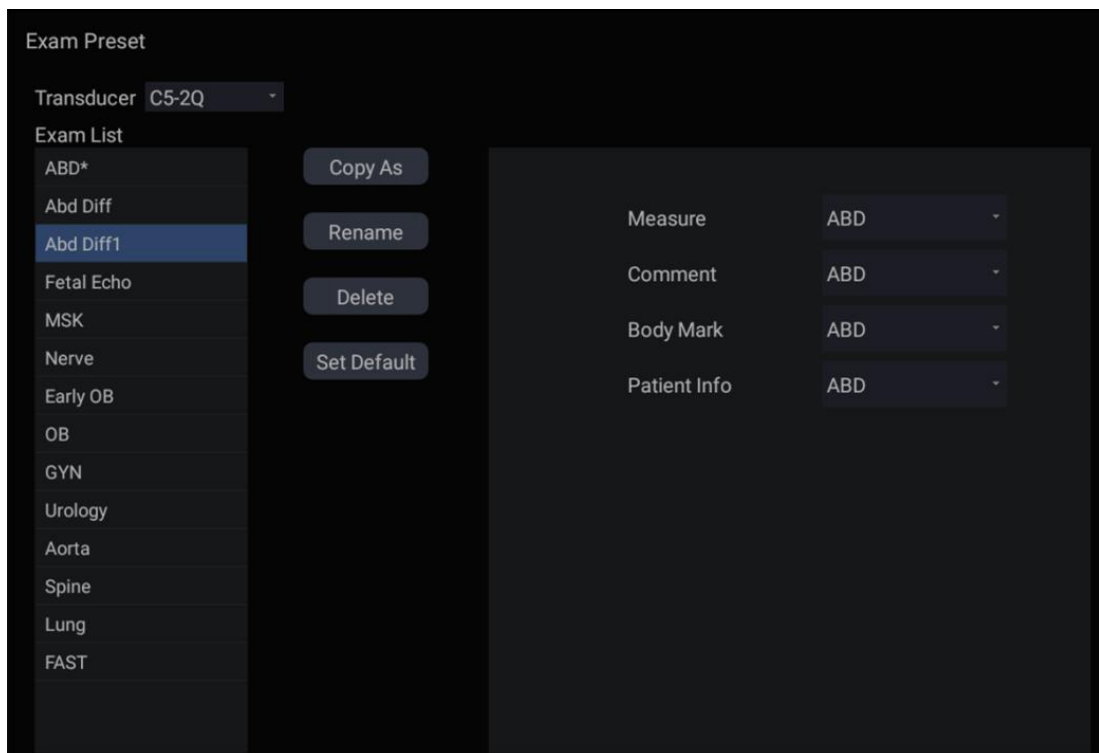

Figure 10-4 Exam Preset Page

Transducer: Select one transducer from the list to configure its exam presets.

Exam List: Select one exam preset to configure its associated Comment, Measure, Body Mark or Patient info settings.

Measure: Select one of the pre-defined application measurement packages to be the default measure preset for the selected exam preset.

Comment: Select one of the pre-defined comment presets to be the default comment preset for the selected exam preset.

Body Mark: Select one of the pre-defined body mark presets to be the default body mark preset for the selected exam preset.

Patient Info: Select one of the pre-defined patient information categories for the selected exam preset, which determines the patient information items displayed on the patient information page by default.

Set Default: Set the selected exam preset as the default exam preset of the transducer. The default exam preset will be marked with "**".

Copy As and **Rename:** Copy the selected exam preset as a new preset and then rename it.

Delete: Delete the copied exam preset.

10.3.2. Image Preset

Figure 10-5 shows an example set-up screen for Image Preset, where you can configure the imaging parameters for an exam preset. This example shows the screen for editing the B-mode settings for the C5-2Q OB exam preset.

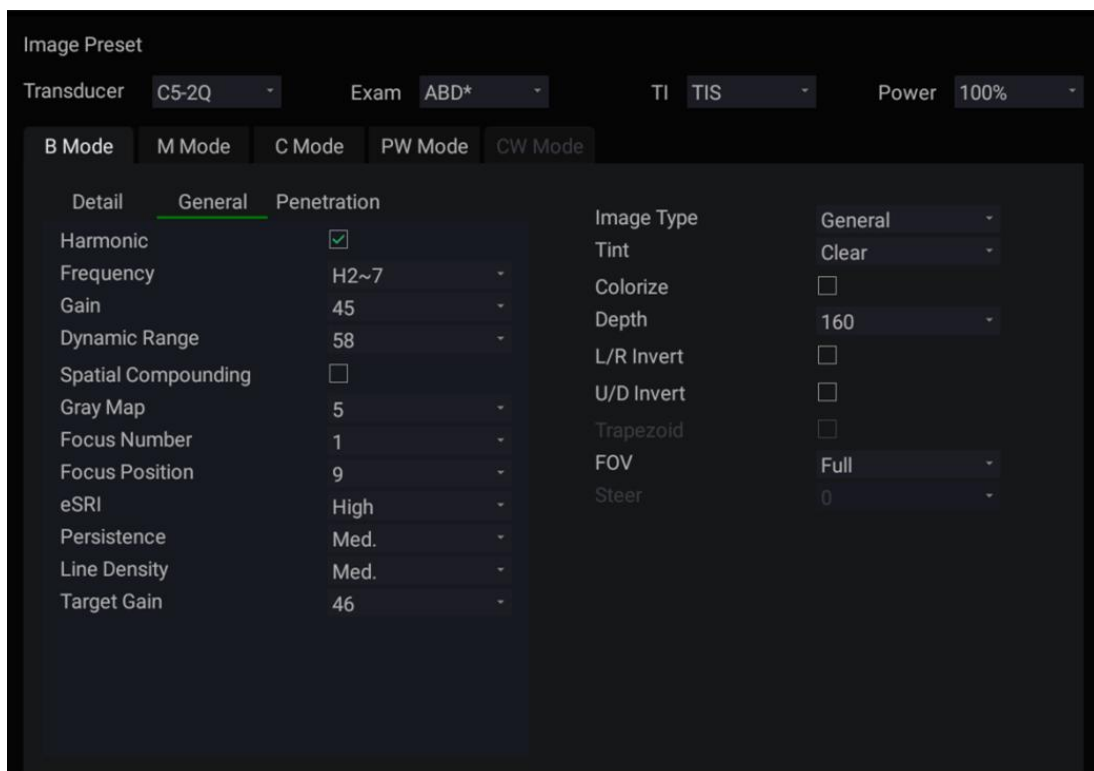

Figure 10-5 Example Set-up Screen for Image Preset

Transducer and **Exam:** There are drop-downs at the top of the screen for selecting the Transducer and Exam Preset you want to edit. Each transducer has its own set of exam presets, and these two drop-downs let you select which exam preset, on which transducer, you want to edit.

TI: Select the TIB, TIS or TIC to display on main screen.

Power: Set the default acoustic output power of the current exam preset.

Image Modes: The next row of controls show tabs for each imaging mode. These let you select which imaging mode you want to edit for the current exam preset. The example shows the B-mode tab selected.

The image mode is divided into two sections. Parameters that have one value for each preset are shown on the left. Parameters that are associated with Image Types are shown on the right.

Image Type: Each imaging mode has a set of image types. For example in B-mode the types are Detail, General, and Penetration. While imaging, the image type lets you quickly change the aesthetic look of the image without changing settings like depth or invert status. The right side of the preset set-up screen shows a tab for each image look. The parameters shown below those tabs let you customize that image type for the current preset.

10.3.3. Comment Preset

Figure 10-6 shows an example set-up screen for Comment Preset, where you can add or edit the comment texts of each Comment preset.

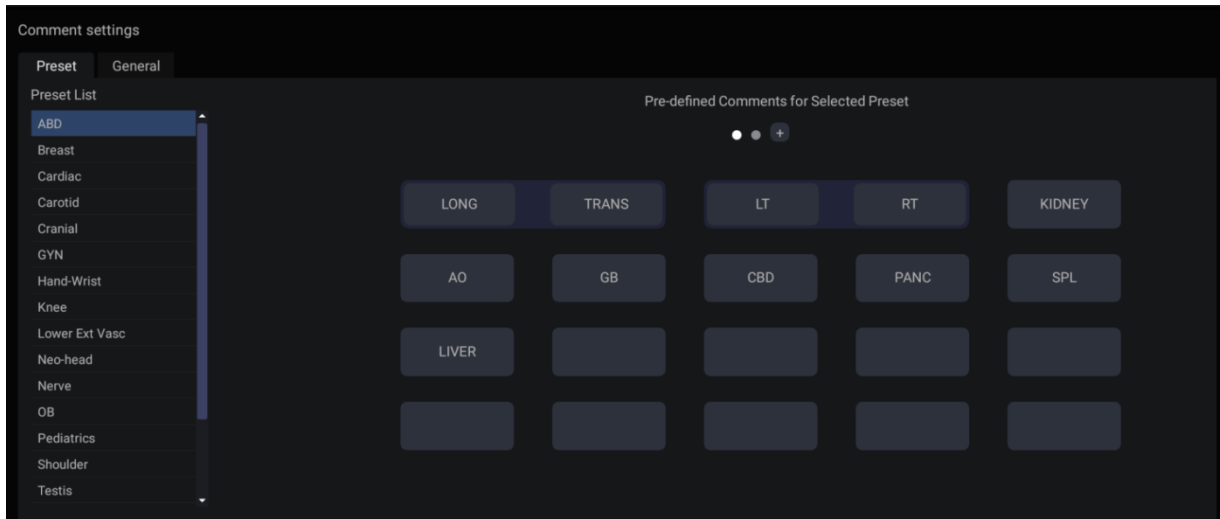

Figure 10-6 Comment Preset Screen

Editing Comment Preset:

Select a comment preset from the preset list on the left side of the screen, and then you can do the followings to edit the comment texts for the selected preset.

➤ **Adding a new Comment:**

1. Move the cursor to a blank block and press **<Set>**.
2. Enter a new comment through keyboard.

➤ **Editing an Exist Comment in Comment Preset:**

1. Move the cursor to a comment and press **<Set>**.
2. Edit the selected comment through keyboard.

➤ **Deleting an Exist Comment in Comment Preset:**

1. Move the cursor to a comment and press **<Set>**.
2. Press **Delete** key on the keyboard to delete the selected comment.

General Settings:

- **Auto-erase comments when the image is unfrozen:** If this option is enabled, the comments will be erased when the image is unfrozen, otherwise the comments will only be erased on demand or at the start of a new exam.
- **Continuous Arrow:** If this option is enabled, you can add multiple arrows continuously by pressing **<Set>** key after **Arrow** touch button is enabled in Comment function. If this option is disabled, only one arrow can be added after **Arrow** touch button is enabled. A second arrow is added by pressing **Arrow** touch button again.

10.3.4. Body Mark Preset

Figure 10-7 shows an example set-up screen for Body Mark Preset, where you can configure which body mark graphics appear with each Body Mark preset.

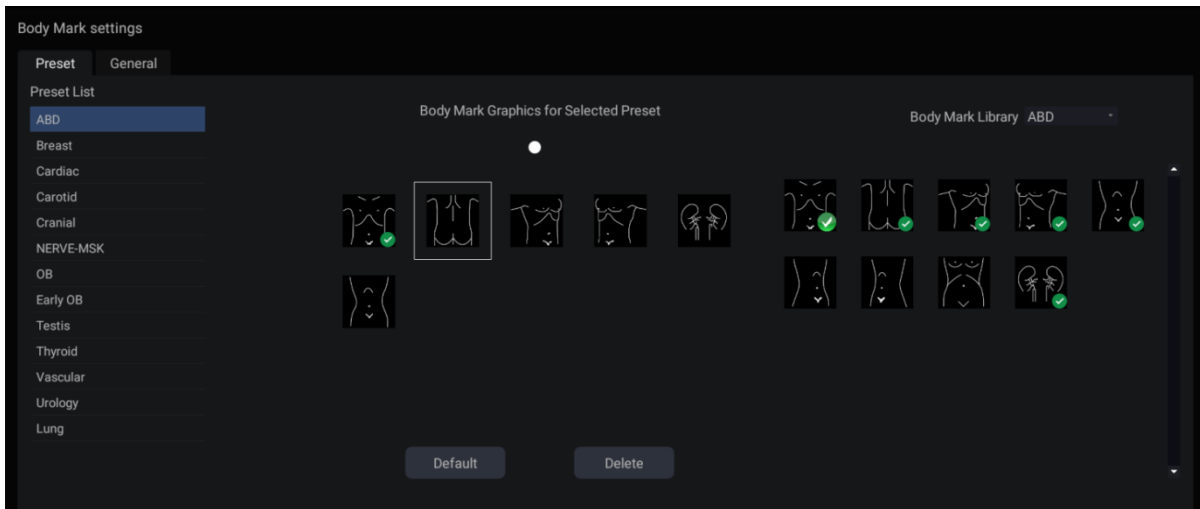

Figure 10-7 Body Mark Preset Screen

Editing Body Mark Preset:

Select an Body Mark preset from the preset list on the left side of the screen, and then you can do the followings to edit the body mark preset for the selected preset.

➤ **Adding a Body Mark to a Preset:**

The right of the screen provides Body Mark Library. Select one domain of Body Mark from the drop-down list, for example ABD, and its body mark graphics are displayed in the box beneath.

Move the cursor to a Body Mark in the Body Mark Library box on the right side of the screen and press **<Set>**. When a Body Mark graphic is added to the box on the middle of the screen which displays the pre-defined body mark graphics for the select preset, it is marked with a green check mark in the Body Mark Library box. When more than one page of Body Mark graphics are added to the middle box, the system will create another new page, indicating by dots at the top of the box. Clicking the dots switches the page.

➤ **Deleting a Body Mark from a Preset:**

Move the cursor to a Body Mark graphic in the middle box and press **<Set>**. Press the **Delete** button below the box to delete it.

Or, move the cursor to a Body Mark graphic with green check mark on it and press **<Set>** to delete it from the selected preset.

➤ **Setting a Default Body Mark for a Preset:**

Select a Body Mark from the box of Body Mark Graphics for Selected Preset and Press **Default**. The Body Mark graphic is set as the default Body Mark to the selected preset.

The default Body Mark can not be deleted from a preset until another Body Mark is selected as a default one.

General Settings:

- **Auto-erase body mark when the image is unfrozen:** If this option is enabled, the body mark will be erased when the image is unfrozen, otherwise the body mark will only be erased on demand or at the start of a new exam.

10.3.5. Measure Preset

Figure 10-8 shows an example set-up screen for Measure Preset, where you can configure general measurement settings.

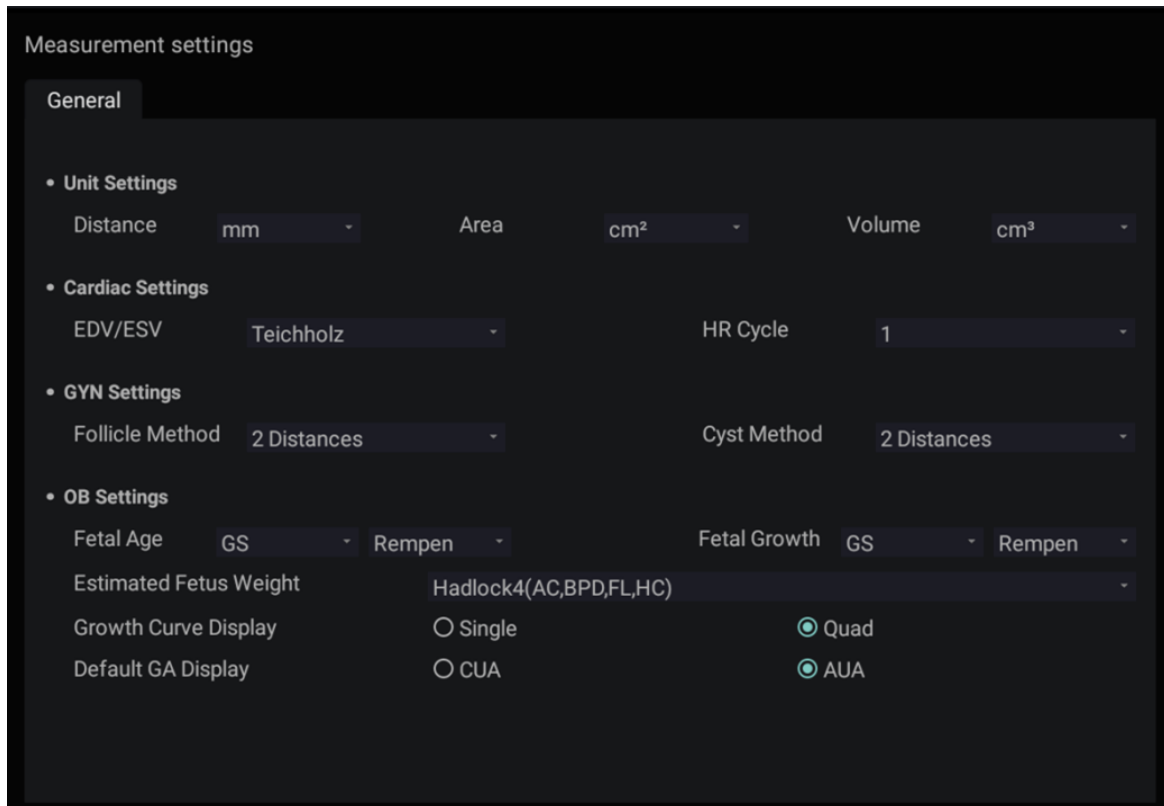

Figure 10-8 Measure Preset Screen

- **Unit Settings**

The system supports following unit settings:

- **Distance:** Set the default unit of distance measurement. "mm" and "cm" are available.
- **Area:** Set the default unit of area measurement. "mm²" and "cm²" are available.
- **Volume:** Set the default unit of volume measurement. "mm³" and "cm³" are available.

- **Cardiac Settings**

The system supports following Cardiac measurement settings:

- **EDV/ESV:** set the author of the formula that is used in EDV/ESV calculation. There are three options: Teichholz, Gibson and Cube.
- **HR Cycle:** set the number of heartbeats that are assumed in the HR or FHR measurement calculation. Range: 1-8.

- **GYN Settings**

The system supports following GYN measurement settings:

- **Follicle Method:** Set the default method for follicle measurement. "1 Distance", "2 Distances" and "3 Distances" are available.
- **Cyst Method:** Set the default method for cyst measurement. "1 Distance", "2 Distances" and "3 Distances" are available.

- **OB Settings**

The system supports the following OB measurement settings:

- **Fetal Age:** set equation for measurements which are used for calculating fetal age.
- **Fetal Growth:** set equation for measurements which are used for calculating fetal growth.
- **Estimated Fetus Weight:** select an equation for the Estimated Fetus Weight calculation.
- **Growth Curves Display:** set single or quad curves as the default display format for the Growth Curves.
- **Default GA display:** set the CUA (Composite Ultrasound Age) or AUA (Average Ultrasound Age) as a default result displayed in the worksheet.

11 Utilities

To open the **Utility** screen:

1. Press **<Cursor>** key to display the cursor;



2. Move the cursor to the Utility icon displayed at the lower left corner of the screen;
3. Press **<Set>** key.

The **Utility** screen provides access to System setup, Presets, Connectivity, Maintenance and Screen adjust. Each of these is described in separate sections.

11.1 System Set-up

System setup is used to configure parameters that are unrelated to presets. Generally, there is one value of each system setup parameter that is shared across all presets.

Entering System Set-up:

Open **Utility** screen. Press **Set up** touch screen button, and then the **System** touch screen button to access system setup.

Reloading Factory Default Settings:

1. Press "Restore Factory Settings" on the System Settings screen, you are prompted "Restore System Setting to factory default? This will erase all system data."
2. Press **Yes** to restore to factory default, and press **No** to cancel.

11.1.1. General Set-up

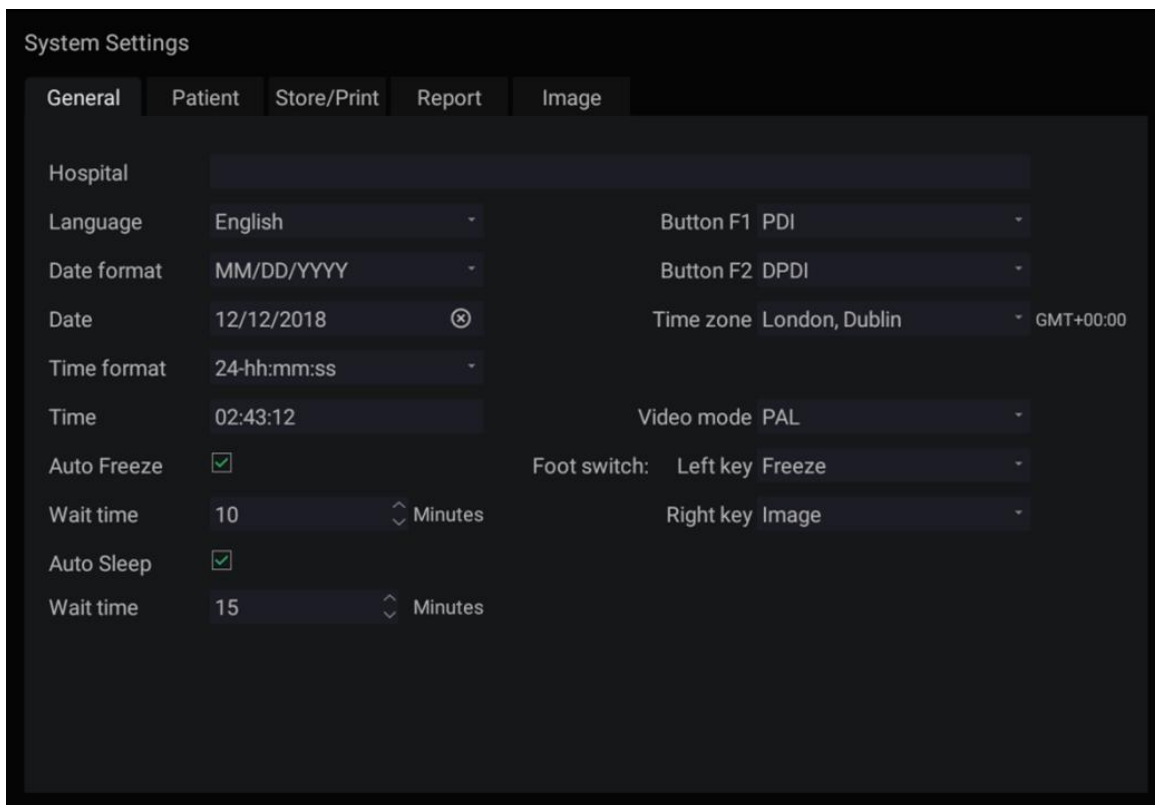

Figure 11-1 General Set-up Screen

Item	Options	Description
Hospital	Input freely	Set hospital name displayed on the top left of the screen and diagnosis report.
Language	Chinese, English	Set the system language(new language is effective after reboot the system).
Date Format	YYYY/MM/DD/ MM/DD/YYYY DD/MM/YYYY	Set the date format.
Date	/	Set the system date Note: If the license is invalidated because of changing the system date, please contact EDAN serviceman.
Time Format	12-AM/PM, 24-hh:mm:ss	Set the time format.
Time	/	Set the system time, format: H/M/S.
Auto-Freeze& Waiting Time	√/x 1-999 min	Set whether to turn on auto-freeze function by default or not; and set the waiting time to perform auto-freeze.
Sleep& Waiting time	√/x 1-999 min	Set whether to turn on system sleep function by default or not; and set the system waiting time to enter sleep mode.
Button F1/F2	PDI, DPDI, Needle, Center Line	Define the F1/F2 keys, select one of the pull-down options. The options that are available will depend on what functions are enabled on the system.
Time Zone	/	Select the time zone from the drop down list.
Video Mode	PAL/NTSC	Set the output video mode. The selected video mode should be the same as that of the s-video printer, otherwise the printer can not work.
FootSwitch	Freeze, Image, Clip, Print	Set a function for the left key or right key of Footswitch. If the physical footswitch only has one button then the Left button selection applies.

Table 11-1 General Set-up Description

11.1.2. Patient Set-up

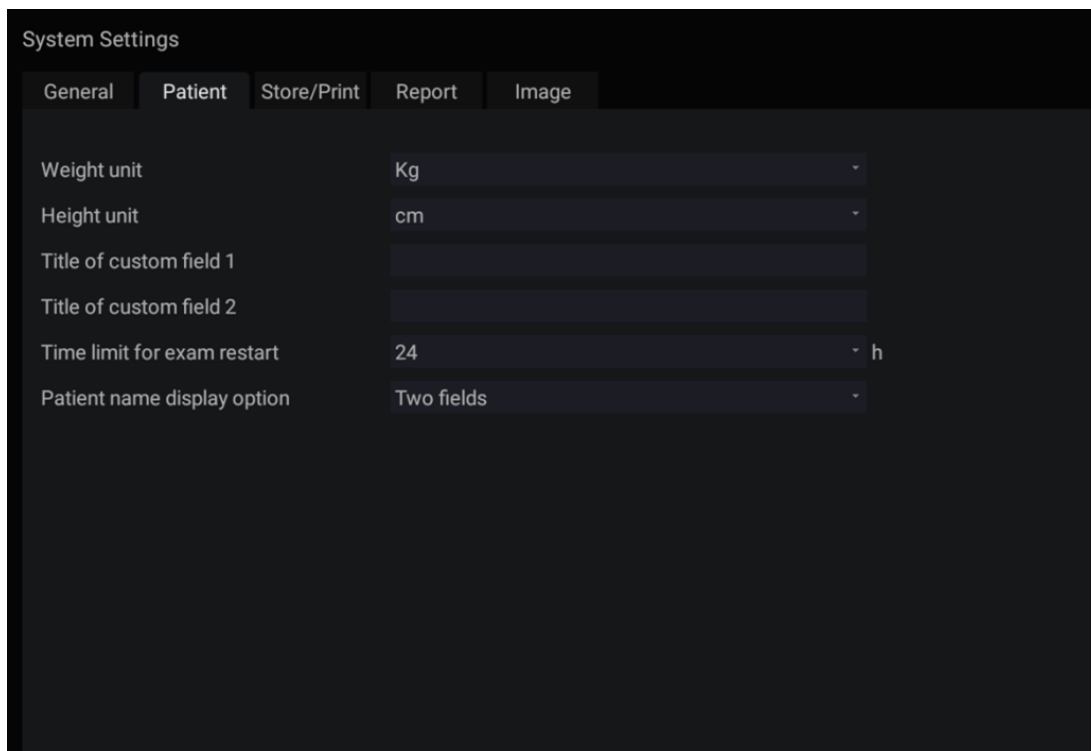

Figure 11-2 Patient Set-up Screen

Item	Options	Description
Weight Unit	kg, lbs	Set the weight unit of patients
Height Unit	cm, ft/in	Set the height unit of patients
Title of custom field 1/2	/	You can define two additional fields for data entry on the Patient Information screen. The Patient Information screen only displays the data entry when you define the title of the custom field.
Time limit for exam restart	0/12h/24h/48h/72h/Unlimited	You can define the time limit for restarting exam. Only exams within the time limit can be restart. If 0 is selected, no exam can be restart.
Patient name display option	One field/Two fields	You can define the patient name display format. The patient information page displays “Patient Name” for one field and displays “Last Name” and “First Name” for two fields.

Table 11-2 Patient Set-up Description

11.1.3. Store/Print Set-up

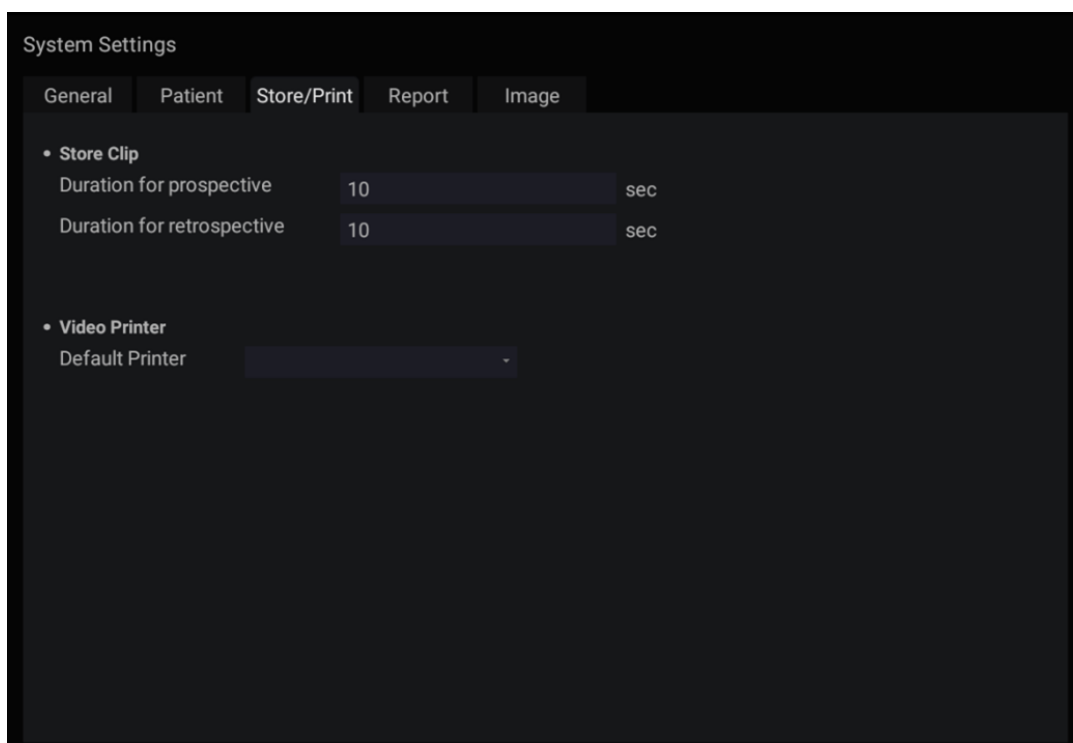

Figure 11-3 Store/Print Set-up Screen

<i>Item</i>		<i>Description</i>
Store Clip	Duration for prospective	Set the cine length for prospective cine storing in live scanning status.
	Duration for retrospective	Set the default cine length for retrospective cine storing in the frozen status.
Video Printer	SONY-UP-D25MD, SONY-UP_X898MD	Select one video printer as the default printer from the list when more than one video printer are connected with the system via USB cable.

Table 11-3 Store/Print Set-up Description

11.1.4. Report Set-up

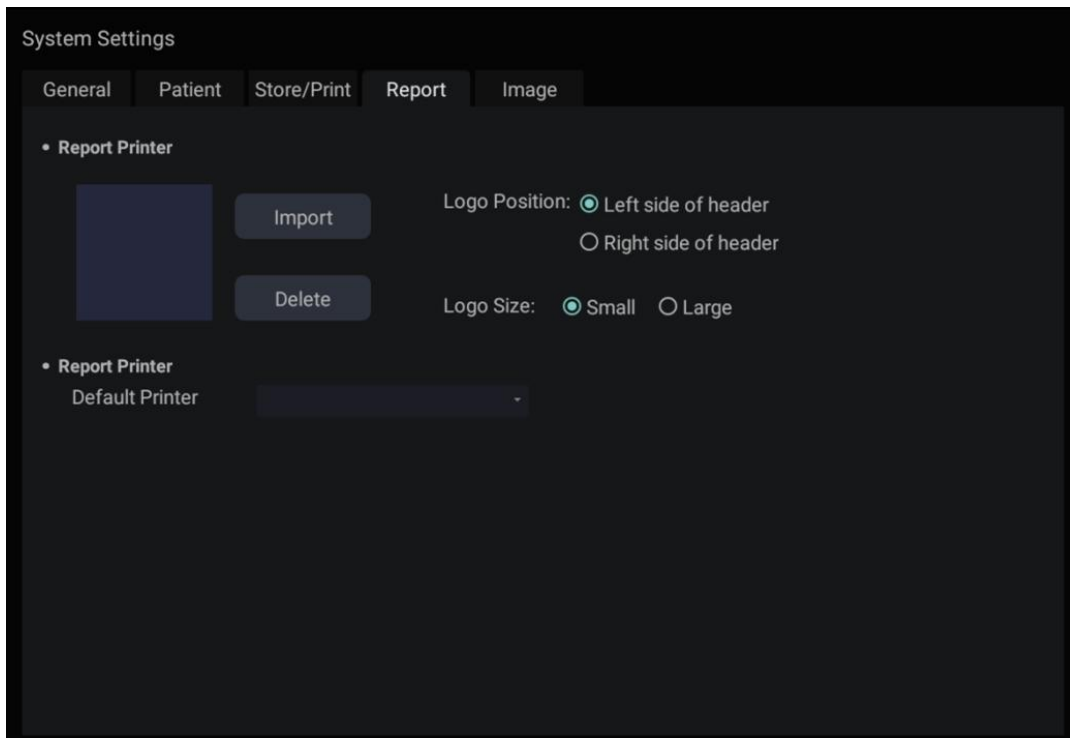

Figure 11-4 Report Set-up Screen

<i>Item</i>		<i>Description</i>
Report Logo	Import	Import a bmp format logo from USB disk.
	Logo Position	Set the logo position to locating at the left or right side of report header.
	Logo Size	Set the logo size to Small or Large.
	Delete	Delete the imported logo.
Report Printer	Default Printer	Select one report printer as the default printer from the list when more than one report printer are connected with the system via USB cable.

Table 11-4 Report Set-up Description

11.1.5. Image Set-up

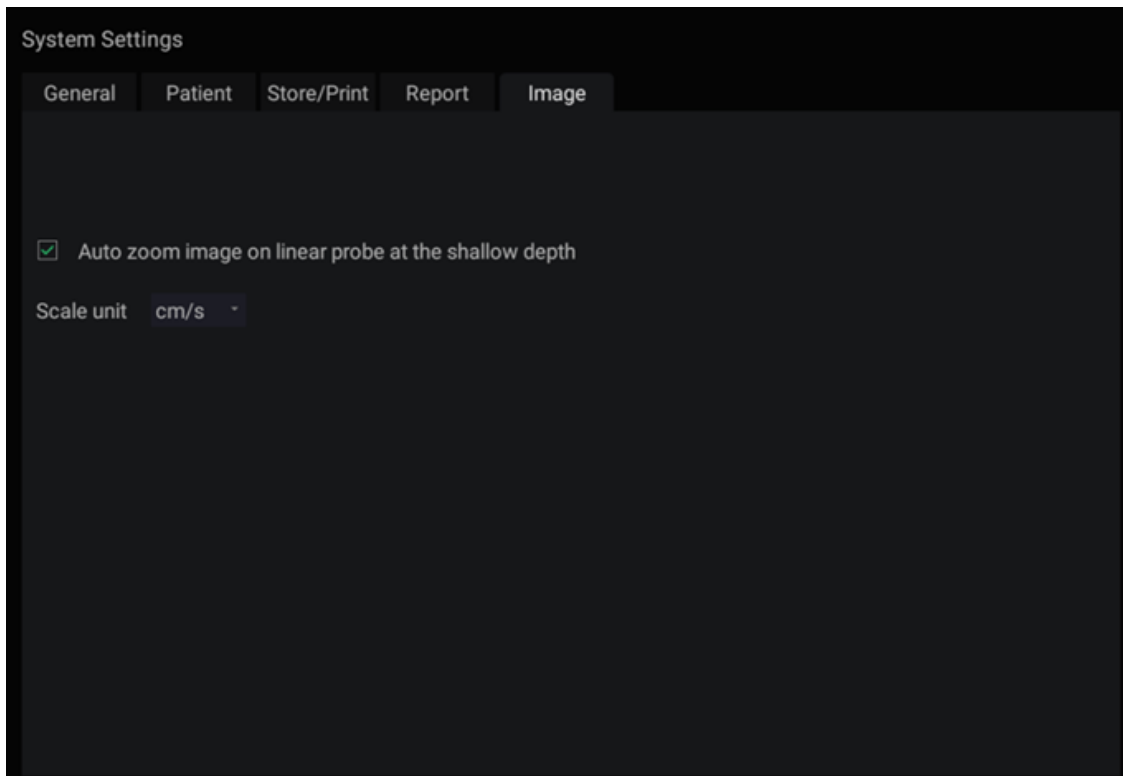

Figure 11-5 Image Set-up Screen

<i>Item</i>	<i>Options</i>	<i>Description</i>
Scale unit	cm/s, kHz	Set the velocity units of spectrum scale.
Auto zoom image on linear probe at the shallow depth	$\sqrt{}/x$	Set whether to auto zoom image at the shallow depth when using linear transducers.

Table 11-5 Image Set-up Description

11.2 Connectivity

Entering Connectivity Screen:

Open **Utility** page. Press **Set up** touchscreen button, and then the **Connectivity** touchscreen button to access Connectivity screens.

The Connectivity screens support configuration of network access and services. It is divided into 2 tabs:

- **TCP/IP:** Configures access to the network from the system.
- **DICOM:** Configures network DICOM services.

11.2.1. TCP/IP

This screen configures access to a network.

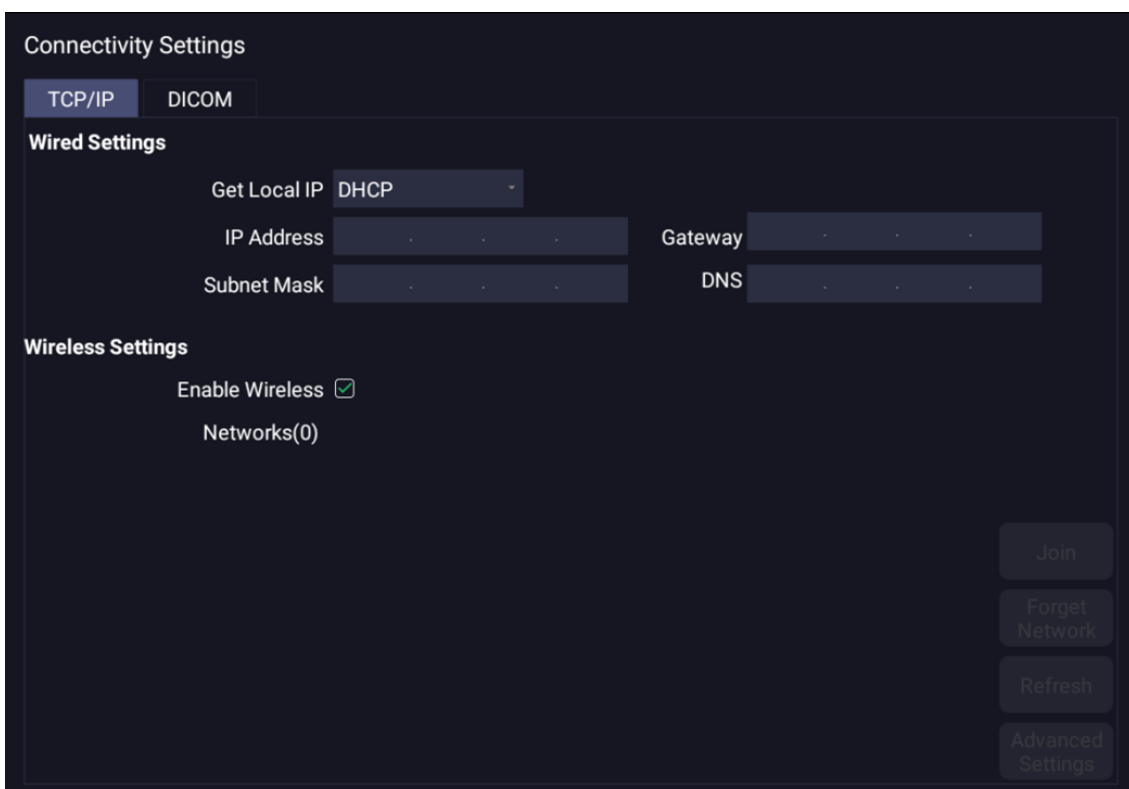

Figure 11-6 TCP/IP settings

Wired Settings:

The following settings apply when connecting a system to a wired network via the network port on the side of the system.

Get Local IP: Either Manually entered (Static) or DHCP. The correct setting will depend on how your DICOM network is administrated. If you are unsure, try DHCP first. Generally a Static IP is only needed if the target PACS system requires it. If it is needed, contact your network IT manager.

IP Address, Subnet Mask, Gateway, DNS: These settings determine how the system communicates with your network. If you chose DHCP then your network router will set these automatically. If you chose Manually Entered IP then contact your network IT manager for the appropriate settings.

Wireless Settings:

Enable Wireless: This will turn the wireless radio on/off. No wireless networks are displayed when this is disabled.

Networks: When wireless is enabled the system will search for wireless networks that are available and display them in this list. Networks that have been previously accessed will show up with an asterisk (“*”). If there is currently an active network it will show up with a checkmark (“√”). If the network requires a password it shows up with a lock icon. Each displayed network shows the strength of the wireless signal.

Refresh: Clicking on this button updates the list of displayed networks.

The following controls require that a wireless network has been selected from the network list. Click on the name of a network to select it.

Join: This joins the selected network. If a password is needed a dialog box will be displayed to enter it.

Forget Network: This forgets any password of the selected network that had been entered, but the network is still shown in the list.

Advanced Settings: This brings up a dialog box with additional settings for the selected wireless network. The dialog box includes the following:

- **Password:** This is useful when the network password has changed.
- **Method:** Either Manually entered (Static) or DHCP. Generally wireless networks use DHCP, and a Static address is only needed if required by the target PACS system.
- **IP Address, Subnet Mask, Gateway, DNS:** If you chose DHCP then your network router will set these automatically. If you chose Manually Entered IP then contact your network IT manager for the appropriate settings.

11.2.2. DICOM

This screen configures DICOM services, including Store and Modality Worklist.

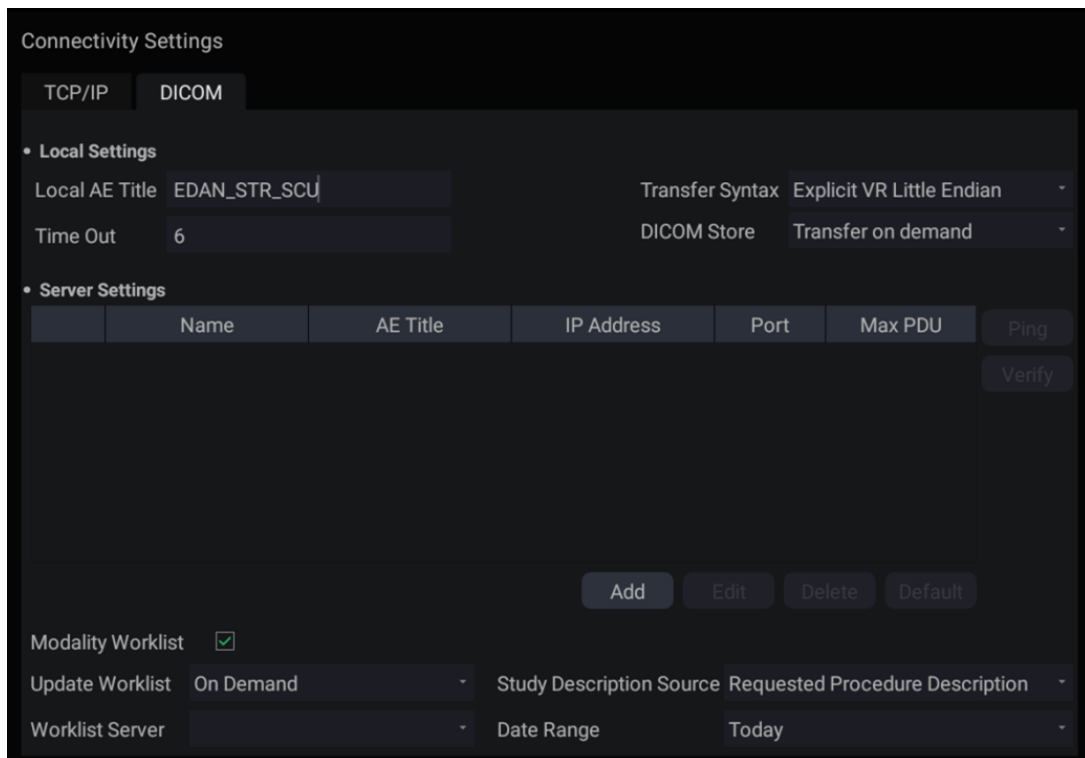

Figure 11-7 DICOM Settings

Local Settings:

These settings determine how the system communicates with other DICOM devices. These are required for both Store and for Modality Worklist.

Local AE Title: Any 16 characters that uniquely identify this system on your DICOM network. The default "EDAN_STR_SCU" will work unless you have multiple Edan systems on your network.

Time Out: This determines the time after which this system will stop trying to establish a connection to the DICOM server.

Server Settings:

Server list: The main interaction in this section is a list of configured servers. It starts off as an empty list, and grows as servers are added. Most sites will only use one server, but if the system is moved between locations then multiple servers may be entered.

- **Default:** A check mark on the left side indicates which server is the default for file transfer.
- **Name:** The name of the server that appears in the drop-down list of the patient database
- **AE Title, IP Address, Port, Max PDU:** These are the settings of the destination DICOM server; it's how the system finds the DICOM server on your network. The AE title and IP Address are unique to your network; contact your network IT manager for these settings. The most common setting of Remote Port for DICOM servers is 104, although your server may be different.

Testing the server: There are two tests to ensure that the server information is entered correctly. Click on any field for a given server to make that server selected, then:

- **Ping:** A successful Ping means that the system can communicate with the server at a low-level; basically that the two computers 'see' each other. As a security measure, some servers on the Internet may be configured to not respond to a Ping even if the connection is successful.
- **Verify:** A successful Verify means that the system can communicate with the server at a DICOM level; basically that the DICOM on both computers understand each other. A successful Verify will typically mean that your DICOM configuration is correct.

Other controls:

- **Add:** Adds another line in the list of servers.
- **Edit:** Edits the information of a selected server.
- **Delete:** Deletes the selected server.
- **Default:** Makes the selected server the default for transfer.

Modality Worklist: Modality Worklist will query the configured server for a list of all ultrasound exams scheduled within the configured date range.

Enable: Turns Modality Worklist on/off.

Update Worklist: Determines when the worklist is updated. Choices are:

- **On Demand:** Updates only when the Update button is pressed from the patient page.
- **On Start of Exam:** Updates when the patient page is displayed at the start of each exam.

Study Description Source: Modality Worklist can fill the ultrasound comments section from the server. Depending on:

- **Requested Procedure Description:** Obtains comments from DICOM tag

(0x0010,0x4000);

- **Scheduled Procedure Description:** Obtains comments from DICOM tag (0x0040,0x0007)
- **Comments on The Schedules Procedure Step:** Obtains comments from DICOM tag (0x0040,0x0400)

Worklist Server: Selects the server to query for the worklist. Options include any server configured in **Server Settings** (see previous section).

Date Range: The range of dates for the worklist query. Note, the option of “Yesterday and Tomorrow” includes today’s exams.

11.3 Maintenance

Open **Utility** page and press **Maintenance** touch screen button to access Maintenance screens.

The Maintenance screen provides access to controls that are not typically needed during normal operation of the system.

11.3.1. License

The **License** page displays which features are currently licensed for use on the system. At the top of the screen is displayed the current license key as well as a license QR code. Below that is a list of all licensable features, along with its current status. The system supports temporary trial licenses. Click the **Trial** button can try the function for one time in the valid period of three months. If a feature is so licensed the expiration date is also shown.

- Press **Import** button to import a license file from a USB external storage device. Please contact your distributor or Edan service engineer to obtain a new license key.
- Press **Revert** button to restore the previous license if the imported license is not correct.
- Press **Import Config** button to import config file from a USB external storage device.
- Press **Show Config** button to view the config file showing whether a feature is enabled or not.

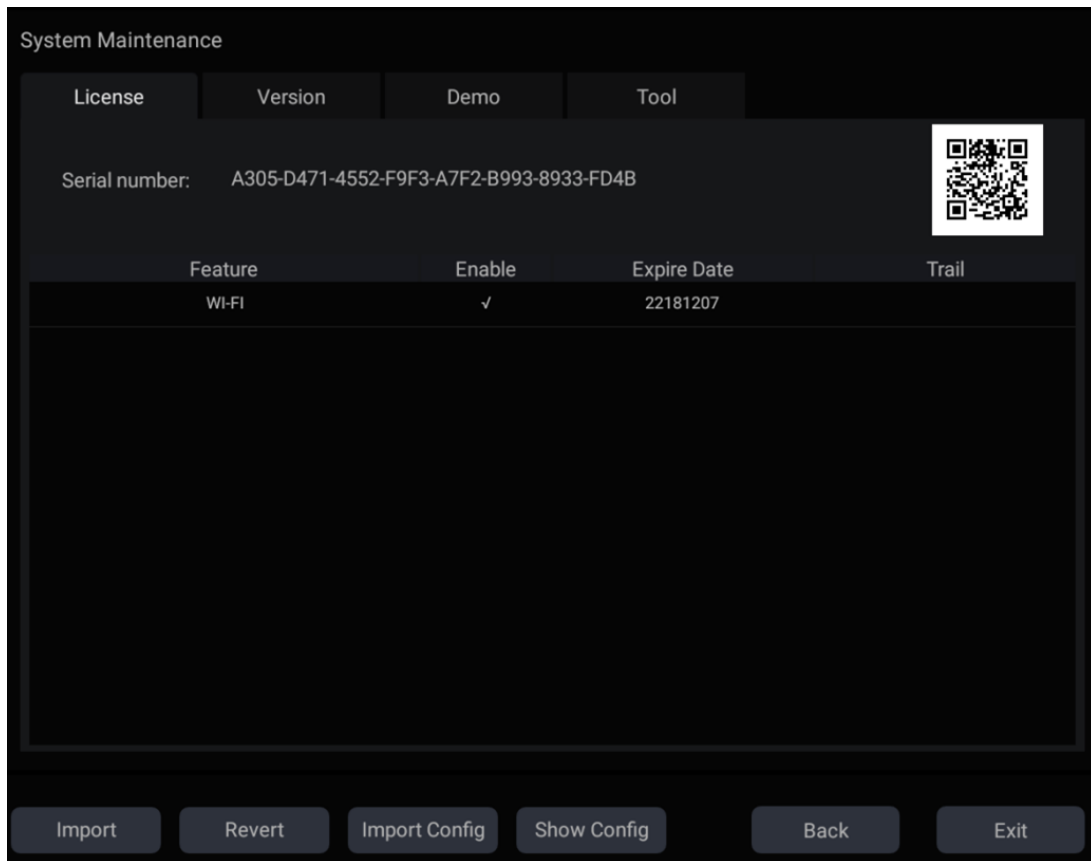

Figure 11-8 System License Screen

11.3.2. Version

The **Version** screen shows the current version of software, firmware, and selected hardware for the system. This information is only needed if requested by an Edan service engineer. This page also includes an **Upgrade** and **Export Logs** button.

Caution

1. Anti-virus measures such as USB device virus scanning should be carried out prior to using USB flash drive.
2. Do not connect an USB device with unknown provenance to the ultrasound system.
3. To avoid loss of patient data, please backup the patient data prior to software upgrade.

11.3.3. Demo

The Demo screen provides access for you to show a set of images you collected for demonstration purpose.

Import: Imports a collection of images to the ultrasound system.

1. Before import, you need create any a folder in USB disk and put the images inside.
2. Connect the USB disk to the ultrasound system.
3. Open the **Demo** screen and press **Import** button.
4. Find the path of the folder and press **OK** to import.

SlideShow: Shows an imported collection of images slide by slide.

Export: Exports the imported images to USB storage device.

Delete: Deletes the imported images.

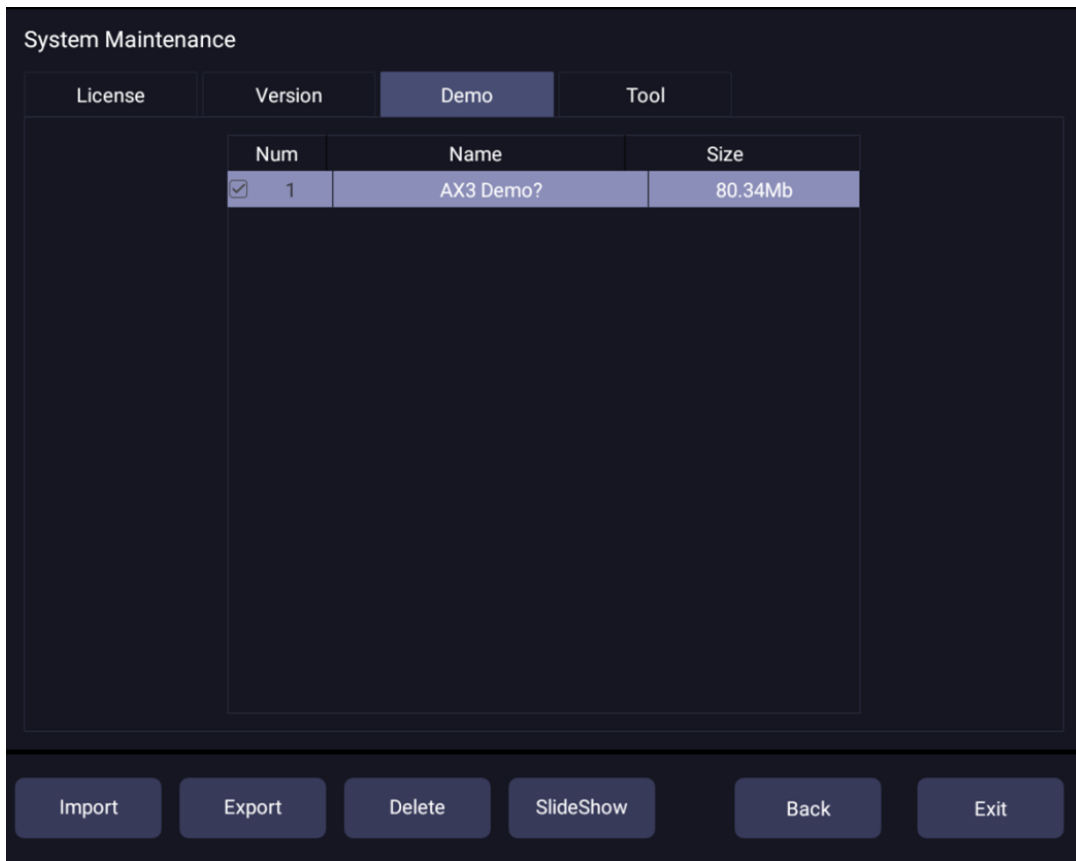

Figure 11-9 Demo Screen

11.3.4. Tool

The Tool screen provides access to system maintenance which must be performed by authorized service personnel. Please refer to the Service Manual for the details.

11.4 Screen Adjust

Entering Screen Adjust Screen:

Open **Utility** page. Press **Set up** touch screen button, and then the **Screen Adjust** touch screen button to access Screen Setup touch screen.

The brightness and contrast of the monitor and touch screen in the system can be customized.

- **Main Screen Brightness:** adjusts the brightness value of the monitor.
- **Main Screen Contrast:** adjusts the contrast value of the monitor.
- **Touch Screen Brightness:** adjusts the brightness value of the touch screen.

Press **Restore all settings** button to restore the factory settings for all the brightness and contrast values.

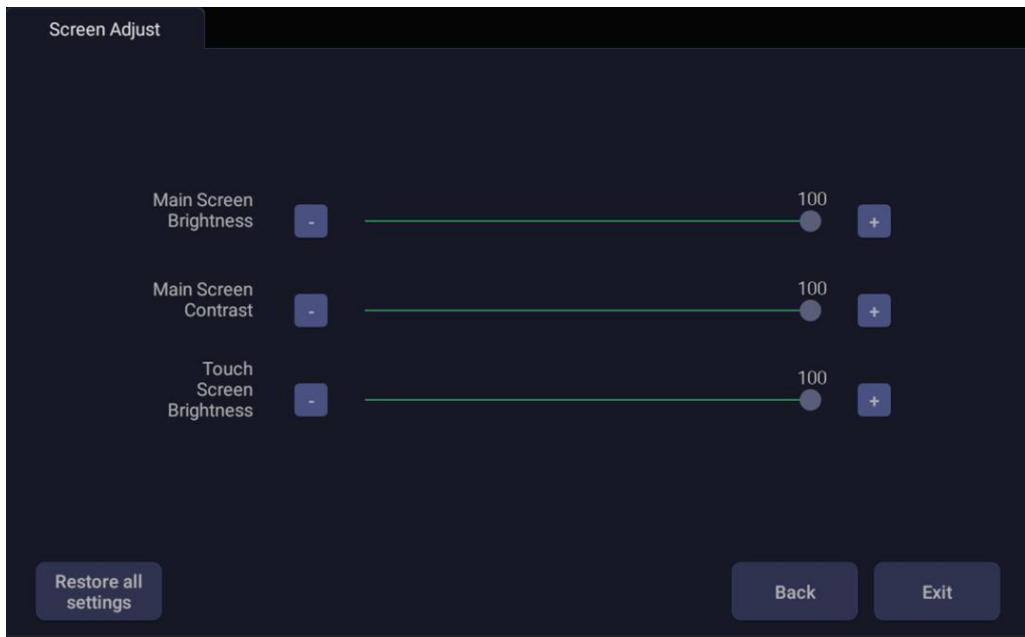

Figure 11-10 Screen Adjust Screen

12 In Between Exams

12.1 Unpacking

Visually examine the package prior to unpacking. If any signs of mishandling or damage are detected, contact the carrier to claim for damage. After unpacking the device, you should follow the packing list to check the product carefully and to make sure that no damage has occurred during transportation. For installation, please contact your local distributor or the EDAN service department at: support@edan.com.cn.

WARNING

1. Do not use the device if it is found to be damaged or defective.
 2. Do not drop or collide with the transducer. Otherwise you shall give up using it.
-

12.2 Transport

The system is designed to be portable and easily transported. Power off the system and secure all accessories before moving it to another location.

CAUTION

- 1 Switch off the ultrasound system. Unplug the AC adapter from the power source and secure the power cable.
 - 2 Remove the transducer and place them in a safe place.
 - 3 Disconnect and secure the connecting cable.
 - 4 Connect optional system accessories.
 - 5 Secure the system and complete the system setup, and then perform all the daily checking before using it.
-

To prepare the system for shipment over long distances or rough terrain, repack the system in the factory packing

To prepare the system for transport over distances: load the system into a vehicle using a lift gate.

To prevent lateral movement of the system, secure the system with cargo straps. To prevent sudden jarring of the system during transport, provide anti-shock cushions beneath the system.

It is suitable for transportation by air, railway, highway and ship. Protect the system from inversion, collision, and splashing with rain and snow.

12.3 Storage

- ◆ Do not place the device near the ground, walls or the roof.
- ◆ Keep good indoor ventilation. Avoid strong and direct sunlight, and erosive gas.

13 Troubleshooting and Maintenance

In order to ensure proper system operation and function, a maintenance and inspection plan should be established to periodically check the safety of the system. If any system malfunction is experienced, contact EDAN or authorized representatives.

13.1 Daily Checklist

Check before the system is switched on, if any system malfunction is experienced, eliminate the malfunction before use, or contact EDAN or authorized representatives for service if needed.

- ◆ Visually inspect all the transducers. Do not use any damaged transducer.
- ◆ Visually inspect all the transducer assembly cables and associated connectors.
- ◆ Visually inspect all the cords. Do not turn on the power if a cord is frayed or split, or shows signs of wear.
- ◆ Verify that the controls are clean and free from gel or contaminants.

Check after the system is switched on:

- ◆ Visually check the on-screen display and lighting. Verify that the monitor displays the current date and time and there isn't any error message.
- ◆ Verify that the transducer identification and indicated frequency on the screen are correct for the activated transducer.
- ◆ Ensure that there isn't obvious abnormal noise, discontinuous image or dark area.
- ◆ Ensure that it isn't smelly or too hot.
- ◆ Ensure that the ultrasound window isn't too hot, checking with your hand.
- ◆ Verify that the buttons on the keyboard are good to operate.
- ◆ Ensure that there isn't obvious abnormal noise from the loudspeakers.
- ◆ Ensure that there isn't obvious abnormal noise from the air fan.

13.2 Troubleshooting

If any persistent system malfunction is experienced, e.g. an onscreen error message, blank imaging screen, absent menus, please refer to the following table below. If the failure cannot be eliminated, please contact EDAN or authorized representatives.

<i>Item</i>	<i>Problem</i>	<i>Solution</i>
1.	When the power switch is on, there isn't any image displayed.	<ol style="list-style-type: none"> 1. Check power supply. 2. Check wires and plugs. 3. Check transducers are connected properly.

2.	Strip-shape or snowflake-shape disturbance occurs on the display screen.	<ol style="list-style-type: none"> 1. Inspect the power supply. 2. Check whether it is disturbed by the ignition action of any other device. 3. Check the disturbance of electric or magnetic field in the surrounding environment. 4. Check whether the plug and socket of power supply and transducer are properly connected.
3.	Image is not displayed clearly on the screen.	<ol style="list-style-type: none"> 1. Adjust overall gain (Gain). 2. Adjust eight TGC slide controls. 3. Adjust focus (the number and the position).
4.	Image window is dark.	<ol style="list-style-type: none"> 1. Adjust the brightness and slide the TGC controls on the touch screen. 2. Check whether the transducer is connected correctly.
5.	The button is unresponsive	<ol style="list-style-type: none"> 1. Check the control panel to see whether the button is blocked and press it several times to release it. 2. Clean the button

Troubleshooting for high system temperature:

1. Check whether system vents are clear and unobstructed. See section 3.2.1 for the location of system vents. Too much dust on the vents or obstructed vents could cause high temperature to the system.
2. Check whether the ambient temperature where the system is used is above 40°C. The system must be used in the ambient temperature lower than 40°C.
3. Check whether the five fans at the system vents are working.

If all these troubles above are cleared, but the system still displays high temperature warning, please contact the Service.

13.3 Cleaning the System

Use only the EDAN-approved substances and methods listed in this chapter to clean the system. The warranty does not cover damage caused by using unapproved substances or methods.

Edan Instruments has validated the cleaning and disinfection instructions included in this User Manual. It is the responsibility of the healthcare professional to ensure that the instructions are followed so as to ensure adequate cleaning and disinfection.

General Points:

Keep your monitor, cables and accessories free of dust and dirt. To prevent the device from damage, please follow the procedure:

- Use only recommended cleaning substances and disinfectants listed in this manual. Others may cause damage (not covered by warranty), reduce product lifetime or cause safety hazards.
- Always dilute according to the manufacturer's instructions.
- Unless otherwise specified, do not immerse any part of the equipment or any accessories in

liquid.

- Do not pour liquid onto the system.
- Do not allow liquid to enter the case.
- Never use abrasive material (such as steel wool or silver polish).
- Inspect the monitor and reusable accessories after they are cleaned and disinfected.

WARNING

The console is not waterproof. Do not immerse or expose to extended moisture. Splash resistance does not extend to transducer connectors. Keep connectors dry.

13.3.1. System Cleaning and Disinfection

The validated disinfecting agents for cleaning and disinfecting the system are:

- Ethanol (75%)
- Isopropanol (70%)

To clean/disinfect the system surface:

1. Switch off the system and unplug it.
2. Use a soft cloth dampened with disinfecting agent to gently wipe the entire exterior surface, including the screen, of the equipment thoroughly until no visible contaminants remain.
3. Wipe off the disinfecting agent with a fresh cloth or towel, dampened with tap water after cleaning until no visible cleaning agent remains.
4. Dry the system in a ventilated and cool place.

NOTE:

1. Make sure the system is free of gel and any other visible residue.
2. Use a soft dry cloth without chemicals for cleaning. The monitor surface is easily scratched.

To clean/disinfect the trackball:

1. Remove the front panel bezel.
2. Remove the trackball as shown in *Figure 13-1*.
3. Wipe the trackball, X and Y rollers, and the auxiliary idler wheel with a soft cloth dampened with the disinfecting agent until no visible contaminants remain.
4. Wipe off the disinfecting agent with a fresh cloth or towel dampened with tap water until no visible disinfecting agent remains.
5. Wipe off with a dry cloth to remove residual moisture.
6. Leave the trackball, X and Y rollers, and the auxiliary idler wheel to air dry.
7. Assemble the trackball and front panel bezel after the assembly parts completely dry.

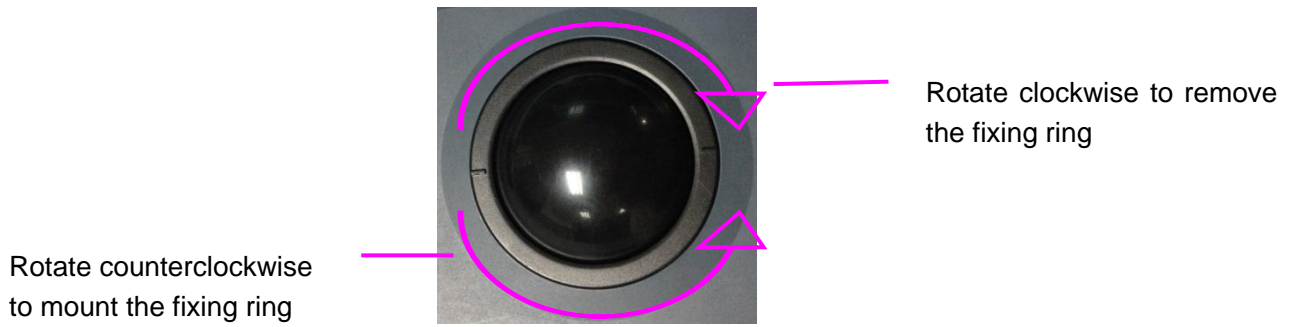

Figure 13-1 Assembling and Disassembling Trackball

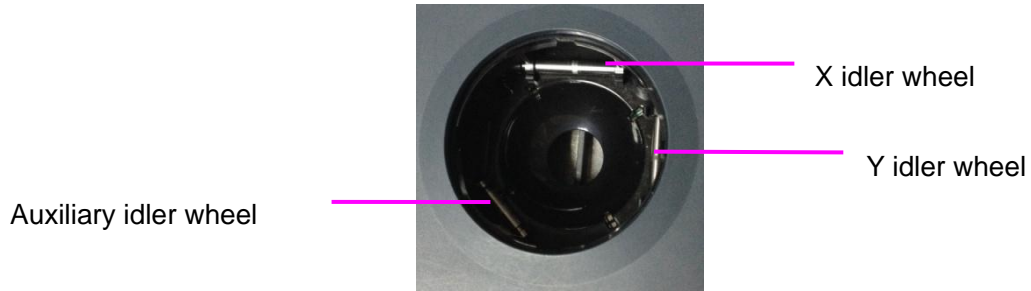

Figure 13-2 X, Y and the Auxiliary Idler Wheels

CAUTION

Do not drop or place foreign objects inside the trackball assembly or it may affect the trackball operation and damage the system.

NOTE:

Be sure to clean the X and Y idler wheels and the auxiliary idler wheel.

13.4 Maintenance

The system should be maintained regularly, at least annually, by a qualified technician who has adequate training, knowledge and experience. That person should be familiar with the Service Manual, available from your Edan representative.

Appendix A Specifications

A.1 Electrical Safety Classifications

According to the type of protection against electric shock	Internally powered equipment, Class I equipment
According to the degree of protection against electric shock	Type BF
According to the degree of protection against harmful ingress of liquid	Whole device: IPX0 Transducer (not including the transducer connector): IPX7; Footswitch: IP68
According to the degree of safety of application in the presence of a flammable gas	Equipment not suitable for use in the presence of a flammable gas
According to the mode of operation	Continuous operation
According to the grade of EMC	CISPR 11 Group 1, Class A
Standards Compliance	EN 60601-1:2006/A1:2013 idt IEC 60601-1: 2005/A1:2012 EN 60601-1-2: 2015 idt IEC 60601-1-2: 2014 EN 60601-2-37:2008/A1:2015 idt IEC 60601-2-37:2007/A1:2015

A.2 Power Supply

Operating Voltage	100 -240 V~
Operating Frequency	50 Hz/60 Hz
AC Input Current	2.5A-1.5A
DC Input Current	19V === 7.8A MAX
Lithium battery	
Capacity	5000 mAh
Voltage	14.8V
Working time	Proximately 1 hours for one fully charged battery; Proximately 2 hours for two fully charged batteries
Charging time	About 2.5 hours for one battery; About 5 hours for two batteries.
Cycle life	> 300

A.3 Machine Specifications

Main unit dimensions	375 mm×380 mm×58 mm
Weight	Weight: 4.2kg (Including one transducer socket, not including battery, power adapter and transducers) Weight:4.35kg (Including two transducer sockets, not including battery, power adapter and transducers)

A.4 Display Specifications

Display	TFT-LCD
Diagonal Size	15.6 inches
Open Angle	0°-180°
Pixel Number	1920x1080
White Luminance	300 cd/m ² (typ)
Contrast Ratio	700 (typ)

A.5 General Specifications

Display Modes	<p>B Mode: B, 2B</p> <p>Color Mode: B/C(Single, Dual); B+B/C(Dual Live); B/C/PW (triplex mode)</p> <p>PDI/DPDI Mode: B/PDI(DPDI) (Single, Dual); B+B/PDI(DPDI) (Dual Live); B/PDI(DPDI)/PW (triplex mode)</p> <p>PW Mode: B/PW;(Update) B/PW; (duplex, simultaneous) B/C/PW(Update) B/C/PW, B/PDI(DPDI)/PW; (triplex mode)</p> <p>CW Mode: B/CW; B/C/CW, B/PDI(DPDI)/CW;</p> <p>M Mode: B/M (Display layout: Up/down, Left/right)</p>
Hard Drive Storage	120GB (SSD)
Report Packages	Abdomen, Obstetrics, Small Parts, Vascular, Cardiac, Gynecology, Urology

A.6 Wi-Fi Specifications

Standard Conformance	802.11a, 802.11b, 802.11g ,802.11n
Frequency Band	2.412-2.484GHz(@2.4GHz band)
Modulation Technique	OFDM DSSS CCK
Typical Transmit Power(± 2 dBm)	2.4G Transmit 1MbpsDSSS :17.3dBm 2MbpsDSSS :17.3dBm 5.5MbpsCCK :17.3dBm 11MbpsCCK :17.3dBm 6MbpsOFDM: 17.1dBm 9MbpsOFDM :17.1dBm 12MbpsOFDM: 17.1dBm 18MbpsOFDM :17.1dBm 24MbpsOFDM :16.2dBm 36MbpsOFDM :15.3dBm 48MbpsOFDM :14.6dBm 54MbpsOFDM: 13.8dBm

A.7 Operating, Storage and Transportation Environment

A.7.1 Operating Environment

Temperature	0 °C ~ +40 °C(+32 °F~+104 °F)
Relative humidity range	15% RH ~ 95% RH(non-condensing)
Atmospheric pressure range	86kPa ~ 106kPa

A.7.2 Storage and Transportation Environment

Temperature	-20 °C ~ +55 °C(-4 °F~+131 °F)
Relative humidity range	15% RH ~ 95% RH(non-condensing)
Atmospheric pressure range	70kPa ~ 106kPa

A.8 Transducer Specifications

No.	Transducer	Center Frequency
1	L17-7Q	12.0MHz
2	E8-4Q	6.2MHz
3	L12-5Q	8.0MHz
4	C5-2Q	3.5MHz
5	P5-1Q	2.7MHz

A.9 Configuration Difference

Models	Configuration Difference			
	Feature 1	Feature 2	Feature 3	Feature 4
	Seminal Vesicle Meas.	Testis Meas.	Single Button Footswitch	Socket Number
Acclarix AX3	√	√	√	Double
Acclarix AX3 Exp	√	X	√	Double
Acclarix AX3 Super	X	X	√	Double
Acclarix AX25	X	√	√	Double
Acclarix AX28	√	X	X	Double
Acclarix AX2	√	√	√	Single
Acclarix AX2 Exp	√	X	√	Single
Acclarix AX2 Super	X	X	√	Single
Acclarix AX15	X	√	√	Single
Acclarix AX18	√	X	X	Single

Appendix B Ultrasound Intensity and Safety

B.1 Ultrasound in Medicine

The use of diagnostic ultrasound has proved to be a valuable tool in medical practice. Given its known benefits for non-invasive investigations and medical diagnosis, including investigation of the human fetus, the question of clinical safety with regards to ultrasound intensity arises.

There is no easy answer to the question of safety surrounding the use of diagnostic ultrasound equipment. Application of the ALARA (As Low As Reasonably Achievable) principle serves as a rule-of-thumb that will help you to get reasonable results with the lowest possible ultrasonic output.

The American Institute of Ultrasound in Medicine (AIUM) states that given its track record of over 25 years of use and no confirmed biological effects on patients or instrument operators, the benefits of the prudent use of diagnostic ultrasound clearly outweigh any risks.

B.2 Ultrasound Safety and the ALARA Principle

Ultrasound waves dissipate energy in the form of heat and can therefore cause tissue warming. Although this effect is extremely low with Transcranial Doppler, it is important to know how to control and limit patient exposure. Major governing bodies in ultrasound have issued statements to the effect that there are no known adverse effects from the use of diagnostic ultrasound, however, exposure levels should always be limited to As Low As Reasonably Achievable (the ALARA principle).

Imaging Functions Affecting Acoustic Output

In addition to the level of voltage transmitted, adjustment of the following imaging functions and /or controls may affect the acoustic output.

Item	Affection
Probe	Acoustic output will be changed with the change of probe.
Imaging mode	There are different parameters applied in B mode, Color mode, M mode, and PW mode, so acoustic output will be changed with the change of among B mode, Color mode, M mode, and PW mode.
Field of view (scan angle or scan width)	Frame rate may be changed with the change of the scan angle or the scan width, and the acoustic output will also be changed.
Image depth	Pulse repeated frequency will be changed with the change of the image depth, and the acoustic output will be changed.
Focus number	Frame rate and focus position will be changed with the change of the focus number, and acoustic output will also be changed.
Focus position	Acoustic output will be changed with the change of the focus position even the beam power level and the beam aperture have not been changed.
Freeze	When freezing the system, it will stop transmitting ultrasonic wave.
Transmission power	The output of probe will be changed with the change of the transmission power, and acoustic output will be changed.
Multi-frequency	The character of the wave focus will be changed with the change of the frequency, and acoustic output will be changed.

Line density	The acoustic output will be changed with the change of the number of the scanning line (line density).
PRF	The acoustic power will be changed with the change of PRF.
Sample volume	The pulsed wave and the power will be changed with the change of the sample volume, and acoustic output will be changed.
Presets	Presets contain all the parameters above, so any change of the presetting will change acoustic output.
Restart, or power on/off	System will return to the default setting when restarting, or powering on/off the system, and acoustic output will be changed.

B.3 Explanation of MI/TI

B.3.1 MI (Mechanical Index)

Cavitations will be generated when ultrasound wave passes through and contacts tissues, resulting in instantaneous local overheating. This phenomenon is determined by acoustic pressure, spectrum, focus, transmission mode, and factors such as states and properties of the tissue and boundary. This mechanical bioeffect is a threshold phenomenon that occurs when a certain level of ultrasound output is exceeded. The threshold is related to the type of tissue. Although no confirmed adverse mechanical effects on patients or mammals caused by exposure at intensities typical of present diagnostic ultrasound instruments have ever been reported, the threshold for cavitation is still undetermined. Generally speaking, the higher the acoustic pressure, the greater the potential for mechanical bioeffects; the lower the acoustic frequency, the greater the potential for mechanical bioeffects.

The AIUM and NEMA formulate mechanical index (MI) in order to indicate the potential for mechanical effects. The MI is defined as the ratio of the peak-rarefactional acoustic pressure (should be calculated by tissue acoustic attenuation coefficient 0.3dB/cm/MHz) to the square root of acoustic frequency.

$$MI = \frac{Pr, \alpha}{\sqrt{f_{aw}} \times C_{MI}}$$

$$C_{MI} = 1 \text{ (MPa / MHz)}$$

B.3.2 TI (Thermal Index)

Heating of tissues is caused by absorption of ultrasound when the ultrasound energy is applied. The temperature rise is determined by the acoustic intensity, exposed area and thermophysical properties of the tissue.

In order to indicate the potential for temperature rise caused by thermal effects, the AIUM and NEMA formulate thermal index (TI). It is defined as the ratio of the total acoustic power to the acoustic power required to raise the tissue temperature by 1°C.

According to different thermophysical properties of the tissue, TI is divided into three kinds: TIS, TIB and TIC.

TIS (Soft Tissue Thermal Index): It provides an estimate of potential temperature rise in soft or similar tissues.

TIB (Bone Thermal Index): It provides an estimate of potential temperature rise when the ultrasound beam passes through soft tissue and a focal region is in the immediate vicinity of bone.

TIC (Cranial Bone Thermal Index): It provides an estimate of potential temperature rise in the cranial bones or superficial bones.

B.3.3 Display of MI/TI

The system provides real-time display of MI/TI values in the upper right part of the screen. The start point of MI/TI value is 0.0.

The operator should monitor these values during examinations and keep the exposure time and output level at the minimum amounts needed for effective diagnosis.

The display precision is 0.1.

MI display error:

When measured $MI \leq 0.5$, the absolute display error ≤ 0.25 ;

When measured $MI > 0.5$, the relative display error $\leq \pm 50\%$.

TI display error:

When measured $TI \leq 2.0$, the absolute display error ≤ 1.0 ;

When measured $TI > 2.0$, the relative display error $\leq \pm 50\%$.

B.4 Acoustic Output

B.4.1 Factors that Contribute to Uncertainty in the Output Display

A number of factors should be considered in display accuracy determination methods, such as:

- Transducer variability
- System variability
- Measurement variability and accuracy
- The number of operating conditions of which the system is capable and the number tested in obtaining display accuracy results
- Whether display accuracy will be determined by specific combinations of system, mode, transducer assembly and transmit patterns, or all allowed combinations of them
- Accuracy of system software MI and TI calculation algorithms.
- Engineering approximations for real-time calculations

B.4.2 Differences between Actual and Displayed MI/TI

Actually, many assumptions adopted in the process of measurement and calculations are relatively conservative. Over-estimation of actual in situ intensity exposure, for the majority of tissue paths, is made to the measurement and calculation process. For example, attenuation coefficient of 0.3 dB/cm·MHz, which is much lower than the actual value for most tissues of the body, is adopted. And conservative values of tissue characteristics are selected for use in TI models. Therefore, the display of MI and TI should be used as relative information to assist operator in prudent use of ultrasound system and implementation of ALARA principle, and the values should not be interpreted as the actual physical values in tissues or organs examined.

B.4.3 Measurement Uncertainty

The uncertainties in the measurements were predominantly systematic in origin; the random uncertainties were negligible in comparison. So the intensity and pressure measurement uncertainties were showed in table 1 and table 2. The power, the center frequency and MI measurement uncertainties were showed in table 3.

Table 1 The intensity and pressure measurement uncertainties table

	Total uncertainties		Hydrophone Sensitivity		Digitizer	
	Intensity	Pressure	Intensity	Pressure	Intensity	Pressure
Uncertainty	±23.68%	±11.84%	±14%	±7%	±0.95%	±0.475%
Notes	The RMS combination of all sources of measurement uncertainty, based on all sources being independent.		Uncertainties based on the hydrophone calibration certificate.		Uncertainties based on oscilloscope calibration certificate.	

Table 2 The intensity and pressure measurement uncertainties table

	Temperature		Spatial Ave.		Distortion	
	Intensity	Pressure	Intensity	Pressure	Intensity	Pressure
Uncertainty	±2.39%	±1.195%	±18.5%	±9.8%	±4%	±2%
Notes	Uncertainties based on temperature variation of the water bath and difference in the mean temperature between the hydrophone calibration lab and our facility.		Uncertainties based on part 7 of B.7 and discussions with industry consultants.		Non-linear distortion estimates are based on part 7 of B.7 and discussions with industry consultants.	

Table 3 The power, center frequency and MI measurement uncertainties table

	Power	Center frequency	MI
Uncertainty	±23.68%	±0.2%	±11.84%
Notes	Uncertainties based on the intensity uncertainties.	Uncertainties based on the oscilloscope.	Uncertainties based on the pressure and center frequency.

B.4.4 Acoustic Power Default Settings

The ultrasound system allows direct control of acoustic power by the Power paddle key on the touch screen. The range can be adjusted is 10% to 100%. The higher the acoustic power number, the greater the acoustic output.

The factory default settings of acoustic power is 100%. The default settings can be reconfigured by



the operator through the Acoustic Power item on **->Preset->Image Preset** page. The ultrasound system switch to default settings upon power up, new patient, new exam or new transducer.

B.5 Operator Control Features

The possibility of producing mechanical/thermal biological effects can be influenced by three kinds of controls: Direct Controls, Indirect Controls, and Receiver Controls. The qualified operator may use the system controls to minimize the ultrasound output while acquiring necessary clinical information.

◆ Direct Controls

The acoustic output of the system can be controlled directly through the level of voltage transmitted. In this case, the maximum acoustic output never exceeds the limits in any mode of operation.

◆ Indirect Controls

The acoustic output of the system can be controlled indirectly through many imaging parameters, including imaging modes, field of view, line density, probe frequency, focus number/position, depth and pulse repetition frequency (PRF).

The imaging mode determines whether the ultrasound beam is scanning or non-scanning. Thermal bioeffect is closely associated with M, PW and Color mode.

Acoustic attenuation of tissue is directly connected to probe frequency.

The focus number/position is related to active aperture of probe and beam width.

The higher PRF (pulse repetition frequency), the more output pulses occur over a period of time.

◆ Receiver Controls

The receiver controls (such as gain, TGC, dynamic range and image processing), which are used to improve image quality, have no effect on acoustic output. Thus these controls should be optimized before increasing acoustic output.

B.6 Prudent Use Statement

Although no confirmed bioeffects on patients caused by exposure from present diagnostic ultrasound equipment have ever been reported, the potential exists that such bioeffects may be identified in the future. Therefore, the ultrasound should be used prudently. High levels of acoustic output and long exposure time should be avoided while acquiring necessary clinical information.

B.7 References for Acoustic Output and Safety

1. "Bioeffects and Safety of Diagnostic Ultrasound" issued by AIUM in 1993
2. "Medical Ultrasound Safety" issued by AIUM in 1994
3. "Acoustic Output Measurement Standard for Diagnostic Ultrasound Equipment, Revision 3" issued by AIUM/NEMA in 2004
4. "Information for Manufacturers Seeking Marketing Clearance of Diagnostic Ultrasound Systems and Transducers" issued in 2008.
5. IEC60601-2-37, Medical electrical equipment - Part 2-37:2007+AMD1:2015 Particular requirements for the basic safety and essential performance of ultrasonic medical diagnostic and monitoring equipment, International Electro technical Commission.
6. Roy C. Preston, David R. Bacon, and Robert A. Smith, Calibration of Medical Ultrasonic Equipment - Procedures and Accuracy Assessment, IEEE Transactions on Ultrasonics, Ferroelectrics, and Frequency Control, Vol. 35, No. 2, page110, March 1988.

B.8 Transducer Acoustic Output Data

Please refer to the User Manual Advanced Volume(P/N: 01.54.458118) for details acoustic output data of each transducer.

Appendix C Order List

The following accessories are recommended for use on the system.

WARNING

Only accessories supplied or recommended by EDAN can be used, the battery and transducers of EDAN can be only used on EDAN's systems. Otherwise, the performance and electric shock protection cannot be guaranteed. If electrical or mechanical equipment from other companies need to be connected to the device, please contact EDAN or authorized representatives before connection.

The following accessories are recommended for use on the ultrasound system.

<i>Part Name</i>	<i>Part Number</i>
Transducer E8-4Q	02.01.214513
Transducer P5-1Q	02.01.213916
Transducer L17-7Q	02.01.214800
Transducer C5-2Q	02.01.212622
Transducer L12-5Q	02.01.212623
BGK-C5-2 Needle Guide Bracket Kit	02.01.211006
BGK-L40UB Needle Guide Bracket Kit	02.01.210407
BGK-CR10UA Needle Guide Bracket Kit	02.01.102963
BGK-001 Needle Guide Bracket Kit	02.01.215191
BGK-002 Needle Guide Bracket Kit	02.01.215192
BGK-003 Needle Guide Bracket Kit	02.01.215193
Lithium-Ion battery	01.21.064143
Adapter	21.21.064243
Power Cable, European Standard	01.13.036638
Power Cable, American Standard	21.13.036384
Ultrasound Gel	01.57.78008
USB Disk	01.18.052245
Footswitch(single button)	01.10.000910

Fottswitch(double button)	01.10.027323
Suitcase	01.56.466572

NOTE: The part name may vary depending on context, but the part number is constant.

Appendix D EMC Information

Electromagnetic emissions

Guidance and manufacture's declaration – electromagnetic emission		
The system is intended for use in the electromagnetic environment specified below; The customer or the user of the system should assure that it is used in such an environment.		
Emission test	Compliance	Electromagnetic environment – guidance
RF emissions CISPR 11	Group 1	The system is suitable for use in all establishments other than domestic and those directly connected to the public low-voltage power supply network that supplies buildings used for domestic purposes.
RF emissions CISPR 11	Class A	
Harmonic emissions IEC 61000-3-2	Class A	
Voltage fluctuations/flicker emissions IEC61000-3-3	Complies	

NOTE:

The EMISSIONS characteristics of the system make it suitable for use in industrial areas and hospitals (CISPR 11 class A). If it is used in a residential environment (for which CISPR 11 class B is normally required) the system might not offer adequate protection to radio-frequency communication services. The user might need to take mitigation measures, such as relocating or re-orienting the equipment.

Electromagnetic immunity**Guidance and manufacture's declaration – electromagnetic immunity**

The system is intended for use in the electromagnetic environment specified below. The customer or the user of the system should assure that they are used in such an environment.

Immunity test	IEC/EN 60601 test level	Compliance level	Electromagnetic environment - guidance
Electrostatic discharge (ESD) IEC/EN 61000-4-2	± 8 kV contact ± 15 kV air	± 8 kV contact ± 15 kV air	Floors should be wood, concrete or ceramic tile. If floor are covered with synthetic material, the relative humidity should be at least 30%.
Electrical fast transient/burst IEC/EN 61000-4-4	±2 kV for power supply lines	±2kV for power supply lines	Mains power quality should be that of a typical commercial or hospital environment.
Surge IEC/EN 61000-4-5	±1 kV for line to line ±2 kV for line to ground	±1 kV for line to line ±2 kV for line to ground	Mains power quality should be that of a typical commercial or hospital environment.
Power frequency (50/60Hz) magnetic field IEC/EN 61000-4-8	30 A/m	30 A/m	Power frequency magnetic fields should be at levels characteristic of a typical location in a typical commercial or hospital environment.
Voltage dips, short interruptions and voltage variations on power supply input lines IEC/EN 61000-4-11	0 % U_T ; 0.5 cycle At 0°, 45°, 90°, 135°, 180°, 225°, 270° and 315° 0 % U_T ; 1 cycle and 70 % U_T ; 25/30 cycles) Single phase: at 0° 0 % U_T ; 250/300 cycle	0 % U_T ; 0.5 cycle At 0°, 45°, 90°, 135°, 180°, 225°, 270° and 315° 0 % U_T ; 1 cycle and 70 % U_T ; 25/30 cycles Single phase: at 0° 0 % U_T ; 250/300 cycle	Mains power quality should be that of a typical commercial or hospital environment. If the user of the system requires continued operation during power mains interruptions, it is recommended that the system be powered from an uninterruptible power supply or a battery.
NOTE U_T is the a.c. mains voltage prior to application of the test level.			

Electromagnetic immunity

Guidance and manufacture's declaration – electromagnetic immunity

The system is intended for use in the electromagnetic environment specified below. The customer or the user of the system should assure that they are used in such an environment.

Immunity test	IEC/EN 60601 test level	Compliance level	Electromagnetic environment - guidance
<p>Conducted RF IEC/EN 61000-4-6 Radiated RF IEC/EN 61000-4-3</p>	<p>3 V_{rms} 150 kHz to 80 MHz 6V_{rms}^c in ISM bands between 0.15 MHz and 80 MHz 3 V/m 80 MHz to 2.7 GHz See table 1</p>	<p>3 V_{rms} 150 kHz to 80 MHz 6V_{rms}^c in ISM bands between 0.15 MHz and 80 MHz 3 V/m 80 MHz to 2.7 GHz Comply with table 1</p>	<p>Portable and mobile RF communications equipment should be used no closer to any part of the system, including cables, than the recommended separation distance calculated from the equation applicable to the frequency of the transmitter.</p> <p>Recommended separation distance</p> <p>$d = 1.2\sqrt{P}$ 150KHz to 80MHz</p> <p>$d = 1.2\sqrt{P}$ 80 MHz to 800 MHz</p> <p>$d = 2.3\sqrt{P}$ 800 MHz to 2.7 GHz</p> <p>$d = 6\sqrt{P/E}$ at RF wireless communications equipment bands (Portable RF communications equipment (including peripherals such as antenna cables and external antennas) should be used no closer than 30 cm (12 inches) to any part of the system, including cables specified by the manufacturer).</p> <p>Where P is the maximum output power rating of the transmitter in watts (W) according to the transmitter manufacturer and d is the recommended separation distance in meters (m).</p> <p>Field strengths from fixed RF transmitters, as determined by an electromagnetic site survey,^a should be less than the compliance level in each frequency range.^b</p> <p>Interference may occur in the vicinity of equipment marked with the following symbol:</p> 

NOTE 1 At 80 MHz and 800 MHz, the higher frequency range applies.

NOTE 2 These guidelines may not apply in all situations. Electromagnetic propagation is affected by absorption and reflection from structures, objects and people.

^a Field strengths from fixed transmitters, such as base stations for radio (cellular/cordless) telephones and land mobile radios, amateur radio, AM and FM radio broadcast and TV broadcast cannot be predicted theoretically with accuracy. To assess the electromagnetic environment due to fixed RF transmitters, an electromagnetic site survey should be considered. If the measured field strength in the location in which the system is used exceeds the applicable RF compliance level above, the system should be observed to verify normal operation. If abnormal performance is observed, additional measures may be necessary, such as reorienting or relocating the system.

^b Over the frequency range 150kHz to 80MHz, field strengths should be less than 3V/m.

^c The ISM (industrial, scientific and medical) bands between 0.15 MHz and 80 MHz are 6.765 MHz to 6.795 MHz; 13.553 MHz to 13.567 MHz; 26.957 MHz to 27.283 MHz; and 40.66 MHz to 40.70 MHz. The amateur radio bands between 0.15 MHz and 80 MHz are 1.8 MHz to 2.0 MHz, 3.5 MHz to 4.0 MHz, 5.3 MHz to 5.4 MHz, 7 MHz to 7.3 MHz, 10.1 MHz to 10.15 MHz, 14 MHz to 14.2 MHz, 18.07 MHz to 18.17 MHz, 21.0 MHz to 21.4 MHz, 24.89 MHz to 24.99 MHz, 28.0 MHz to 29.7 MHz and 50.0 MHz to 54.0 MHz.

Table 1 Test specifications for ENCLOSURE PORT IMMUNITY to RF wireless communications equipment

Test frequency (MHz)	Band ^{a)} (MHz)	Service ^{a)}	Modulation ^{b)}	Maximum power (W)	Distance (m)	Immunity test level (V/m)
385	380-390	TETRA 400	Pulse modulation ^{b)} 18 Hz	1.8	0.3	27
450	430-470	GMRS 460, FRS 460	FM ^{c)} ± 5 kHz deviation 1 kHz sine	2	0.3	28
710	704-787	LTE Band 13, 17	Pulse modulation ^{b)} 217 Hz	0.2	0.3	9
745						
780						
810	800-960	GSM 800/900, TETRA 800, iDEN 820, CDMA 850, LTE Band 5	Pulse modulation ^{b)} 18 Hz	2	0.3	28
870						
930						
1720	1700-1990	GSM 1800; CDMA 1900; GSM 1900; DECT; LTE Band 1, 3, 4, 25; UMTS	Pulse modulation ^{b)} 217 Hz	2	0.3	28
1845						
1970						

2450	2400-2570	Bluetooth, WLAN, 802.11 b/g/n, RFID 2450, LTE Band 7	Pulse modulation ^{b)} 217 Hz	2	0.3	28
5240	5100-5800	WLAN 802.11 a/n	Pulse modulation ^{b)} 217 Hz	0.2	0.3	9
5500						
5785						

NOTE If necessary to achieve the IMMUNITY TEST LEVEL, the distance between the transmitting antenna and the ME EQUIPMENT or ME SYSTEM may be reduced to 1 m. The 1 m test distance is permitted by IEC 61000-4-3.

a) For some services, only the uplink frequencies are included.

b) The carrier shall be modulated using a 50 % duty cycle square wave signal.

c) As an alternative to FM modulation, 50 % pulse modulation at 18 Hz may be used because while it does not represent actual modulation, it would be worst case.

Recommended Separation Distances

Recommended separation distances between portable and mobile RF communications equipment and the system

The system is intended for use in an electromagnetic environment in which radiated RF disturbances are controlled. The customer or the user of the system can help prevent electromagnetic interference by maintaining a minimum distance between portable and mobile RF communications equipment (transmitters) and the system as recommended below, according to the maximum output power of the communications equipment.

Rated maximum output power of transmitter (W)	Separation distance according to frequency of transmitter(m)		
	150 kHz to 80 MHz $d = 1.2\sqrt{P}$	80 MHz to 800 MHz $d = 1.2\sqrt{P}$	800 MHz to 2.7 GHz $d = 2.3\sqrt{P}$
0.01	0.12	0.12	0.23
0.1	0.38	0.38	0.73
1	1.2	1.2	2.3
10	3.8	3.8	7.3
100	12	12	23

For transmitters rated at a maximum output power not listed above, the recommended separation distance d in meters (m) can be determined using the equation applicable to the frequency of the transmitter, where P is the maximum output power rating of the transmitter in watts (W) according to the transmitter manufacturer.

NOTE 1:At 80 MHz and 800 MHz, the separation distance for the higher frequency range applies.

NOTE 2:These guidelines may not apply in all situations. Electromagnetic propagation is affected by absorption and reflection from structures, objects and people.

P/N: 01.54.458117

MPN: 01.54.458117011



EDAN INSTRUMENTS, INC.

#15 Jinhui Road, Jinsha Community, Kengzi Sub-District

Pingshan District, 518122 Shenzhen, P.R.China

Email: info@edan.com.cn

TEL: +86-755-2689 8326 FAX: +86-755-2689 8330

Website: www.edan.com.cn

EC REPRESENTATIVE

Shanghai International Holding Corp. GmbH

Eiffestrasse 80, 20537 Hamburg Germany

TEL: +49-40-2513175

E-mail: shholding@hotmail.com