

## Copyright

This publication, including all photographs, illustrations and software, is protected under international copyright laws, with all rights reserved. Neither this manual, nor any of the material contained herein, may be reproduced without written consent of the author.

Version 2.0

## Disclaimer

The information in this document is subject to change without notice. The manufacturer makes no representations or warranties with respect to the contents hereof and specifically disclaims any implied warranties of merchantability or fitness for any particular purpose. The manufacturer reserves the right to revise this publication and to make changes from time to time in the content hereof without obligation of the manufacturer to notify any person of such revision or changes.

## Trademark Recognition

Microsoft, MS-DOS and Windows are registered trademarks of Microsoft Corp. MMX, Pentium, Pentium-II, Pentium-III, Celeron are registered trademarks of Intel Corporation. Other product names used in this manual are the properties of their respective owners and are acknowledged.

## Regulatory Compliance Information

FCC Declaration of Conformity

This device complies with Part 15 of the FCC Rules. Operation is subject to the following two conditions:

(1) this device may not cause harmful interference, and (2) this device must accept any interference received, including interference that may cause undesired operation.

This equipment has been tested and found to comply with the limits for a Class B digital device, pursuant to part 15 of the FCC Rules. These limits are designed to provide reasonable protection against harmful interference in a residential installation. This equipment generates, uses, and can radiate radio frequency energy and, if not installed and used in accordance with the instructions, may cause harmful interference to radio communications. However, there is no guarantee that interference will not occur in a particular installation. If this equipment does cause harmful interference to radio or television reception, which can be determined by turning the equipment off and on, the user is encouraged to try to correct the interference by one or more of the following measures:

- Reorient or relocate the receiving antenna.
- Increase the separation between the equipment and receiver.
- Connect the equipment into an outlet on a circuit different from that to which the receiver is connected.
- Consult the dealer or an experienced radio/TV technician for help.

This equipment complies with FCC radiation exposure limits set forth for an uncontrolled environment. This equipment should be installed and operated with minimum distance 20 cm between the radiator and your body.

This device meets the government's requirements for exposure to radio waves.

This device is designed and manufactured not to exceed the emission limits for exposure to radio frequency (RF) energy set by the Federal Communications Commission of the U.S. Government, Industry Canada, and other national regulatory agencies.

Any special accessories needed for compliance must be specified in the instruction manual. Use only shielded and terminated cables to connect I/O devices to this equipment.

**Warning!**



*Any changes or modifications made to the equipment which are not expressly approved by the relevant standards authority could void your authority to operate the equipment.*

**Attention!**



Tout changement ou modification non expressément approuvé par l'autorité compétente peut annuler le droit du propriétaire à utiliser l'équipement

## MPE

Exposure to Radio Frequency Radiation:

To comply with FCC RF exposure compliance requirements, a separation distance of at least 20cm must be maintained between the antenna of this device and all persons. This device must not be co-located or operating conjunction with any other antenna or transmitter.

## CE, FCC, NCC RF

### USA RF: FCC Caution

This equipment complies with FCC radiation exposure limits set forth for an uncontrolled environment. This equipment should be installed and operated with minimum distance 20cm between the radiator & your body.

### Canada RF: IC Caution

This equipment complies with IC radiation exposure limits set forth for an uncontrolled environment. This equipment should be installed and operated with minimum distance 20cm between the radiator & your body.

Cet équipement est conforme aux limites d'exposition aux rayonnements IC établies pour un environnement non contrôlé. Cet équipement doit être installé et utilisé avec un minimum de 20 cm de distance entre la source de rayonnement et votre corps.

### Taiwan RF: NCC Caution

本產品符合低功率電波輻射性管理辦法 第十二條、第十四條等條文規定

1. 經型式認證合格之低功率射頻電機，非經許可，公司、商號或使用者均不得擅自變更頻率、加大功率或變更原設計之特性及功能。
2. 低功率射頻電機之使用不得影響飛航安全及干擾合法通信；經發現有干擾現象時，應立即停用，並改善至無干擾時方得繼續使用。前項合法通信，指依電信法規定作業之無線電通信。低功率射頻電機須忍受合法通信或工業、科學及醫療用電波輻射性電機設備之干擾。

## Japan VCCI Statement

この装置は、情報処理装置等電波障害自主規制協議会（VCCI）の基準に基づくクラスB 情報技術装置です。この装置は、家庭環境で使用することを目的としていますが、この装置がラジオやテレビジョン受信機に近接して使用されると、受信障害を引き起こすことがあります。  
取扱説明書に従って正しい取り扱いをして下さい。

電磁波曝露量 MPE 標準値  $1\text{mW}/\text{cm}^2$ ，送測産品實測値為：  
 $0.0941\text{mW}/\text{cm}^2$

CE mark. Declaring compliance to all the applicable European Union (EU) Directives.



Waste disposal instruction



廢電池請回收

**HDMI**<sup>®</sup>  
HIGH-DEFINITION MULTIMEDIA INTERFACE

Do not throw this electronic device into the trash can when discarding. To minimize pollution and ensure utmost protection of the global environment, please recycle it in European WEEE (waste electrical and electronic equipment) directive system or recycle system in Taiwan.

Part NO.  
Printed in China

Edition 2  
AUG 2016

## Packing List

Before setting up the system, check that the items listed below are included and in good condition. If any items are missing, please contact your dealer immediately.

- |                                    |   |
|------------------------------------|---|
| ■ SKM-U mPC x1                     | ■ Extension HDD Box x1 (Optional)       |
| ■ Adapter 65W / 90W x1 (Optional)  | ■ Extension COM Box x1 (Optional)       |
| ■ User Manual x1                   | ■ Micro B to Type A Cable x1 (Optional) |
| ■ Antenna x2 (Optional)            | ■ DB44 to DB9 Cable x1 (Optional)       |
| ■ VESA Mount Bracket x1 (Optional) |   |

### **Warning!**



To prevent electric shock, Do not remove cover.  
No user serviceable parts inside, refer servicing to qualified personnel.

### **Attention!**



*Pour éviter un choc électrique, ne pas retirer le couvercle.  
Aucune pièce réparable par l'utilisateur, voir l'entretien à du personnel qualifié.*

## Additional Information and Assistance

1. Visit the ECS websites at [www.ECS.com.tw](http://www.ECS.com.tw) where you can find the latest information about the product.
2. Contact your distributor, sales representative, or ECS's customer service center for technical support if you need additional assistance. Please have the following information ready before you call:
  - Product name and serial number
  - Description of your peripheral attachments
  - Description of your software (operating system, version, application software, etc.)
  - A complete description of the problem
  - The exact wording of any error messages
  - This equipment is a source of electromagnetic waves. Before use, please make sure that there are not EMI sensitive devices in its surrounding which may malfunction therefore

### **Warning!**



1. Input voltage rated 100-240V~, 50~60Hz, 1.5A max  
Output Voltage rated 3.43A, 19Vdc
2. Input voltage rated 100-240V~, 50~60Hz, 1.5A max  
Output Voltage rated 4.74A, 19Vdc
3. Maintenance: to properly maintain and clean the surfaces, use only approved products or clean with a dry applicator

### **Attention!**



1. Le voltage d'entrée nominale de 100-240V~, 50-60Hz. Max à 1.5A  
Le voltage de sortie nominal 3.43A, 19Vdc
2. Le voltage d'entrée nominale de 100-240V~, 50-60Hz. Max à 1.5A  
Le voltage de sortie nominal 3.74A, 19Vdc
3. La maintenance : Entretenez et nettoyez les surfaces avec soin, Utiliser seulement les produits ratifiés ou nettoyer avec un applicateur sec

**Warning!**



*Danger of explosion if battery is incorrectly replaced.*

*Replace only with the same or equivalent type recommended by the manufacturer.*

*Dispose of used batteries according to the manufacturer's instructions.*

**Prudence!**



Danger d'explosion si la pile est remplacée de façon incorrecte.

Remplacez-la exclusivement par une batterie identique ou par un type de batterie équivalent recommandé par le fabricant

La mise au rebut des batteries usagées doit se faire conformément aux indications du fabricant de ces batteries.

## Safety Instructions

1. Read these safety instructions carefully.
2. Keep this User Manual for later reference.
3. Disconnect this equipment from any AC outlet before cleaning. Use a damp cloth.  
Do not use liquid or spray detergents for cleaning.
4. For plug-in equipment, the power outlet socket must be located near the equipment and must be easily accessible.
5. Keep this equipment away from humidity.
6. Put this equipment on a reliable surface during installation. Dropping it or letting it fall may cause damage.
7. The openings on the enclosure are for air convection. Protect the equipment from overheating.  
**DO NOT COVER THE OPENINGS.**
8. Make sure the voltage of the power source is correct before connecting the equipment to the power outlet.
9. Position the power cord so that people cannot step on it. Do not place anything over the power cord.
10. All cautions and warning on the equipment should be noted.
11. If the equipment is not used for a long time, disconnect it from the power source to avoid damage by transient overvoltage.
12. Never pour any liquid into an opening. This may cause fire or electrical shock.
13. Never open the equipment. For safety reasons, the equipment should be opened only by qualified service personnel.
14. If one of the following situations arises, get the equipment checked by service personnel:
  - a. The power cord or plug is damaged.
  - b. Liquid has penetrated into the equipment.
  - c. The equipment has been exposed to moisture.
  - d. The equipment does not work well, or you cannot get it to work according to the user's manual.
  - e. The equipment has been dropped and damaged.
  - f. The equipment has obvious signs of breakage.
15. **DO NOT LEAVE THIS EQUIPMENT IN AN ENVIRONMENT WHERE THE STORAGE TEMPERATURE MAY GO BELOW -20° C (-4° F) OR ABOVE 60°C (140° F). THIS COULD DAMAGE THE EQUIPMENT. THE EQUIPMENT SHOULD BE IN A CONTROLLED ENVIRONMENT.**
16. If your computer is losing time significantly or the BIOS configuration resets itself to be default, the battery may have no power.
17. **IMPROPER INSTALLATION OF VESA MOUNTING CAN RESULT IN SERIOUS PERSONAL INJURY!** VESA mount installation should be performed by a professional technician; please contact the service technician or your retailer if you need this service.
18. Maintenance: to properly maintain and clean the surfaces, use only the approved products or clean with a dry applicator.

# Contents

- Chapter 1 System Information.....1
  - 1.1 Introduction.....1
  - 1.2 Specifications.....2
  - 1.3 Claeaning/Disinfecting.....4
  
- Chapter 2 Getting Started.....5
  - 2.1 System Tour.....5
    - Figure 2.1 Top View.....5
    - Figure 2.2 Bottom View.....5
    - Figure 2.3 Bottom View.....5
    - Figure 2.4 I/O Side View.....6
  - 2.2 Distribution Description.....8
  - 2.3 Powering the System.....8
  
- Chapter 3 Hardware Installation.....9
  - 3.1 Motherboard Introduction.....9
  - 3.2 Installing the Motherboard.....12
  
- Chapter 4 Using BIOS.....21
  - 4.1 About the Setup Utility.....21
  - 4.2 Using BIOS.....22
  
- Chapter 5 Feature Information.....49
  - 5.1 Introduction.....49

MEMO



# Chapter 1

## *System Information*

---

### 1.1 Introduction

The product has onboard Intel® Skylake™ U SoC for personal micro desktop markets or educational usage.

Below is a brief summary of the computer's many features:

**NOTE:**

The features listed in this section is for your reference only. The exact configuration of the system depends on the model purchased.

## 1.2 Specifications

Description	
<b>CPU</b>	
CPU/SoC	Intel® SkyLake™ U SOC
<b>Super I/O</b>	
Super I/O	IT8607
<b>PCB Dimension</b>	
Dimension	101.6*104*1.6mm
<b>System Dimension</b>	
Dimension	116.6*112*64.6mm(w/HDD) 116.6*112*64.6mm(w/o HDD)
<b>MEMORY</b>	
Channel/DIMM type	2 channels/DDR4 2133
Socket numbers/type	2 sockets/SO-DIMM Slot
MEM size	Max 32GB
<b>STORAGE</b>	
M.2 SSD	1x2280, for SSD(SATA interface) Key M
SATA 6GB/s	1xSATA connector, for 2.5"/HDD(customized)
<b>Additional Feature</b>	
M.2 WLAN	Intel/3165NGW
<b>Chip</b>	
AUDIO chip	Realtek ALC283-CG
LAN chip	Realtek RTL8111H
<b>Front Port I/O</b>	
USB 3.1 Type-A	1
USB 3.1 Type-C	1
IR	1
Audio	1x UAJ(Combo jack)
<b>Rear I/O</b>	
HDMI	1x A type HDMI, support 4K/2K
DP	1x mini DP, support 4K/2K
LAN	1x LAN connector, Gigabit LAN
USB 3.0	2x USB 3.0 ports
DC Jack	1x DC jack, (base on power consumption) 19V 3.43A(65W) 19V 4.74A(90W)

INTERNAL I/O CONNECTORS & HEADERS	
FPC header	2 (Type design by EE, USB 3.0 signal) FPC Header for Pogo Pin Top: 14 Pin FPC to 10 Pogo Pin Bottom: 16 Pin FPC to 10 Pogo Pin
CPU FAN	1 (H4x1, 4pins, P=1.25mm)
Serial SATA III	1x SATA connector, for 2.5" HDD
SATA PWR	1 (H5x1, 5pins, P=1.25mm)
Battery connector	1 (H2x1, 2pins, P=1.25mm)
CLR CMOS	1 (SWITCH.TACT, 2P 180D.H1.5mm)
Power ON LED	1 (SMD, Color.blue)
LOGO LED header	1 (H2x1, P=2.0mm, P=1.25mm)
Wireless charger header (Not Support)	(H2x1, 2pins, P=1.25mm)
Speaker (Optional)	(H4x1, 4pins, P=0.8mm)
NFC header (Optional)	(H8x1, 8pins, p=05.mm)
HDD LED	1 (SMD, Color.Green)
Power button	1 (Design by RD)
SYSTEM	
OS	Windows 10
BIOS	64 Mb SPI ROM
Description	
Adapter	FSP ADAPTER/FSP065-10AABA
	19Vdc, 3.43A.65W
	APD ADAPTER/WA-65B19R
	19Vdc, 3.43A.65W
	APD ADAPTER/DA-90F19
	19Vdc, 4.74A.90W

### 1.3 Cleaning/Disinfecting

During normal use SKM-U mPC may become soiled and should, therefore, be cleaned regularly.  
Steps:

1. Wipe SKM-U mPC with a clean cloth that has been moistened in the cleaning solution.
2. Prepare agent per manufacturer's instructions or hospital protocol.
3. Wipe thoroughly with a clean cloth.

**Caution!**



Do not immerse or rinse SKM-U mPC or its peripherals. If you accidentally spill liquid on the device, disconnect the unit from the power source. Contact your Biomed personnel regarding the continued safety of the unit before placing it back in operation.

Do not spray cleaning agent on the chassis.

Do not use disinfectants that contain phenol.

Do not autoclave or clean SKM-U mPC or its peripherals with strong aromatic, chlorinated, ketone, ether, or other solvents, sharp tools or abrasives. Never immerse electrical connectors in water or other liquids.

**Attention!**



Ne pas immerger ou rincer SKM-U mPC ou ses périphériques. Si vous renversez par accident un liquide sur l'appareil, débranchez l'appareil de la source d'alimentation. Contactez votre Biomed concernant la sécurité continue de l'unité avant de la remettre en service.

Ne pas pulvériser l'agent de nettoyage sur le châssis.

Ne pas utiliser de désinfectants contenant du phénol.

Ne pas passer à l'autoclave ou SKM-U mPC propre ou ses périphériques avec fortes, cétone, éther, ou d'autres solvants, des outils tranchants ou abrasifs aromatiques chlorés. Ne jamais plonger connecteurs électriques dans l'eau ou d'autres liquids.

# Chapter 2

## Getting Started

---

### 2.1 System Tour

Before you start to set up system, take a moment to become familiar with the location and purposes of the controls, drives, connections and ports, which are illustrated in the figures below.



Figure 2.1 Top View

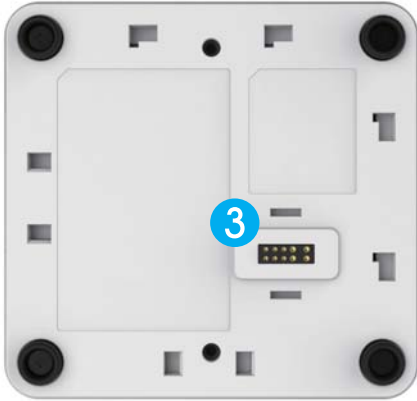

Figure 2.2 Bottom View

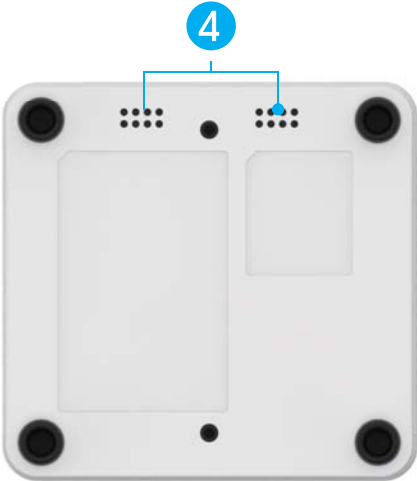

Figure 2.3 Bottom View

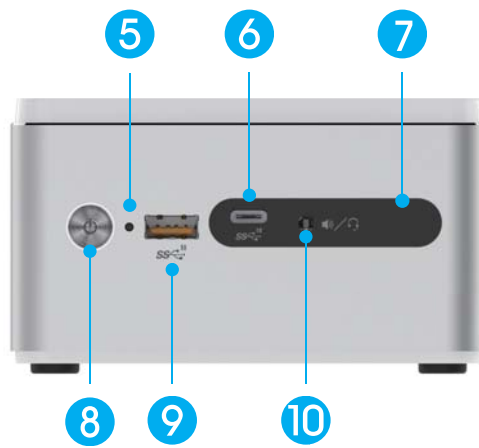

Figure 2.4 IO Side View

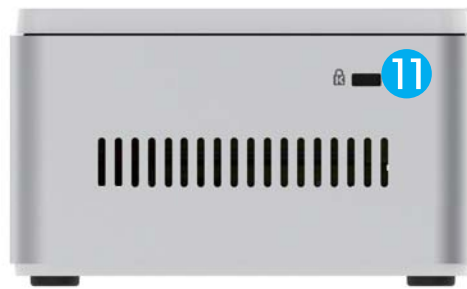

Figure 2.5 Side View

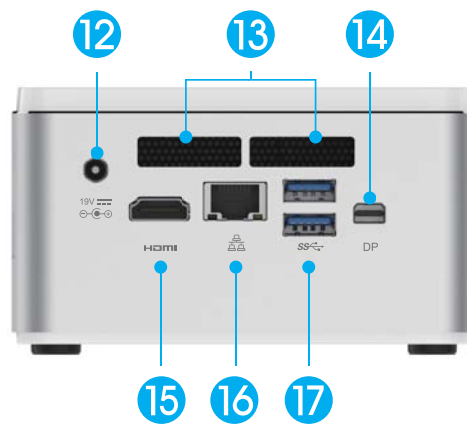
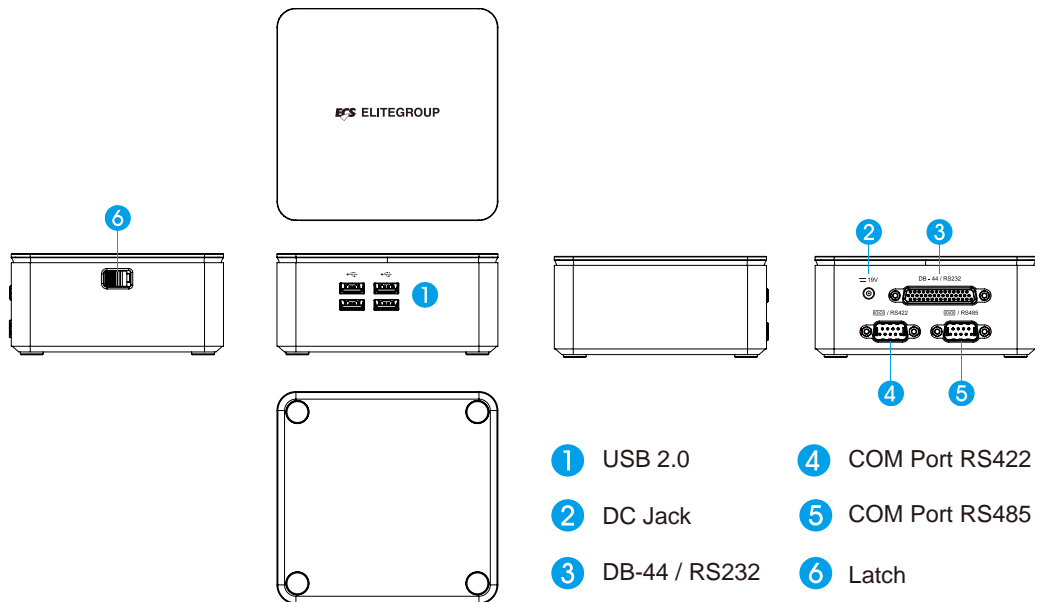

Figure 2.6 IO Side View

No	Components	No	Components
1	Wireless Charger LED (Optional) (Power Transfer Green Blink, Fault Red Blink)	9	USB 3.1 (TypeA / BC1.2)
2	Wireless Charger / LED (Optional)	10	Combo Audio Jack (Mic In & Line Out)
3	Pogo Pin (Optional)	11	Kensington Lock
4	Speaker (Optional)	12	DC Jack
5	HDD LED	13	Thermal Opening
6	USB 3.1 (Type C)	14	DP
7	IR Sensor	15	HDMI
8	Power Button	16	RJ45 Port
		17	USB3.0

### Extension COM Box (Optional)



### Extension HDD Box (Optional)

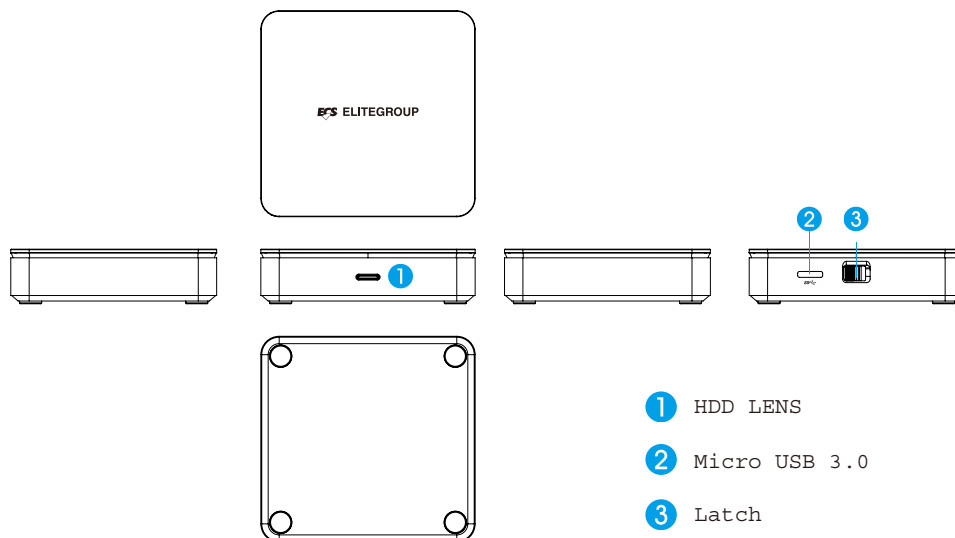

## Assembly-COM Box / HDD Box

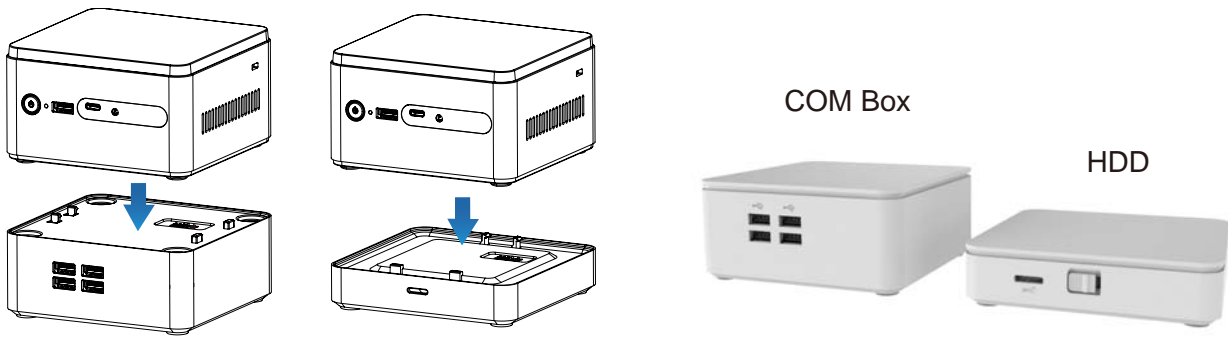

## 2.2 Distribution Description

The operating system is based on Windows 10 64bit / FreeDOS.

## 2.3 Distribution Description

Connecting a 19V adapter to the DC-In Jack, the system will start up automatically.

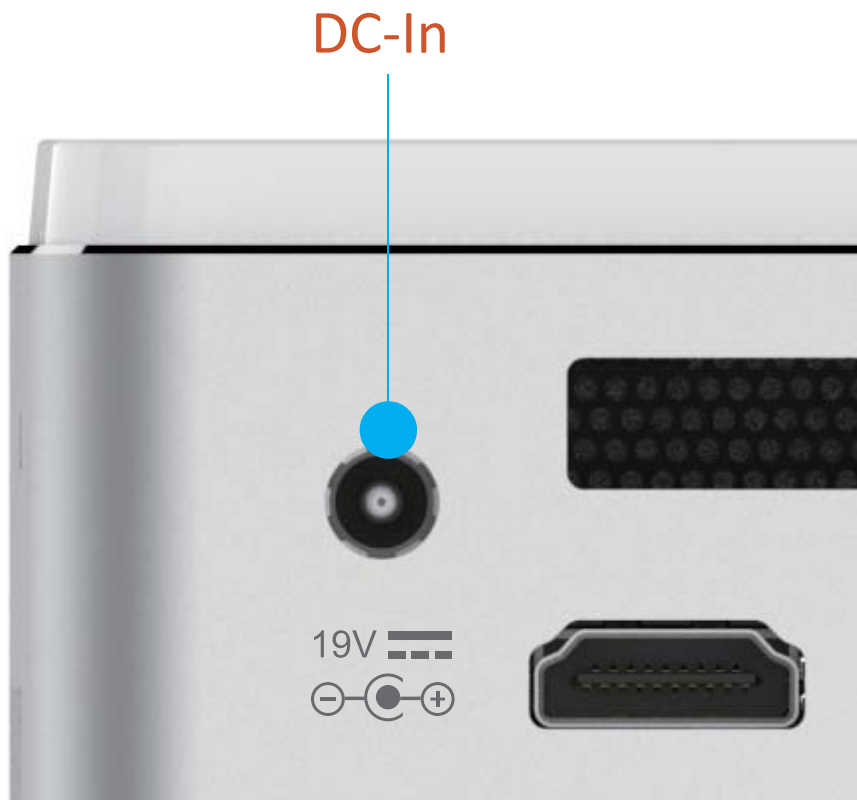



# Chapter 3

## Hardware Installation

### 3.1 Motherboard introduction

Before you start to set up system, take a moment to become familiar with the location and purposes of the controls, drives, connections and ports, which are illustrated in the figures below.

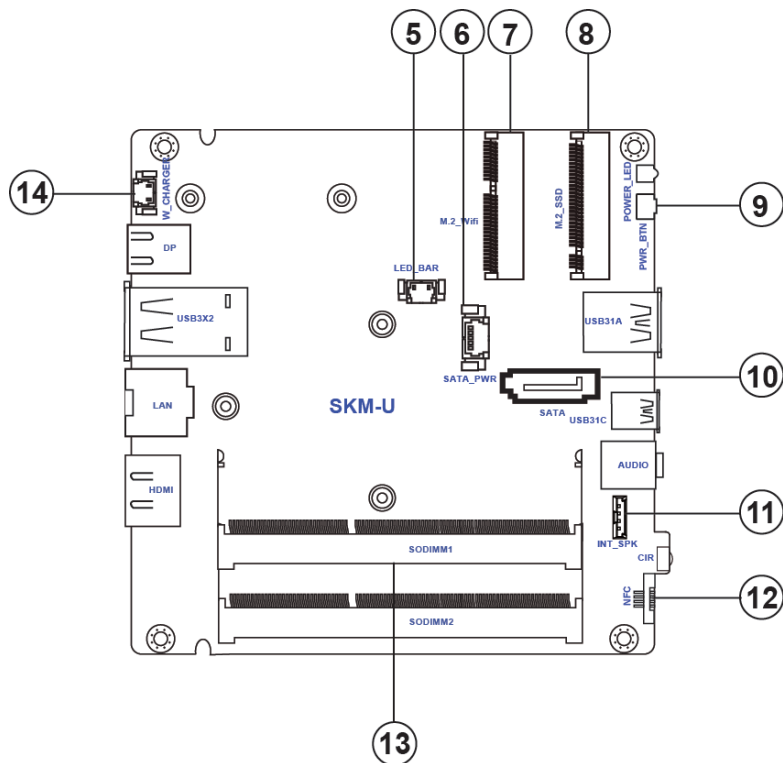
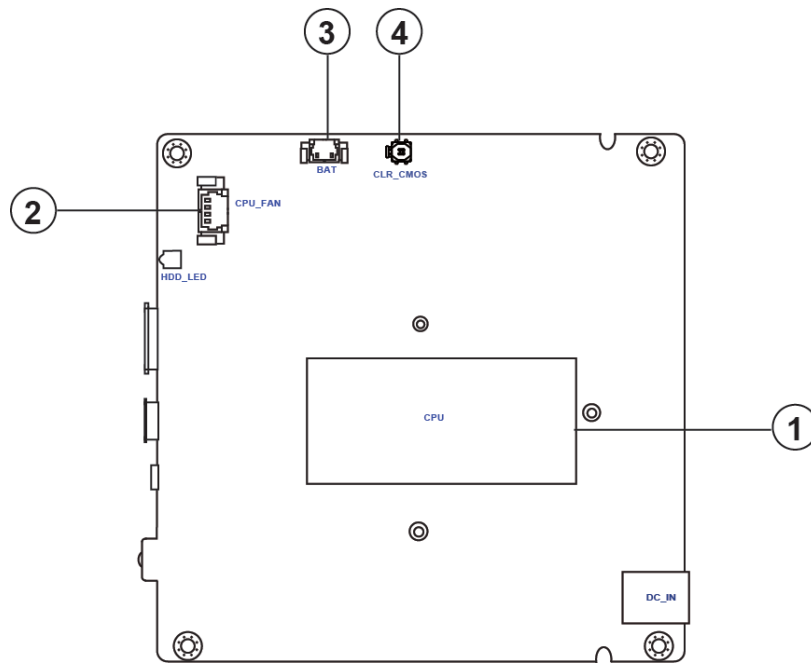

## Table of Motherboard Components

LABEL	COMPONENTS
1.CPU	Intel® SkyLake™ U SOC
2.CPU_FAN	CPU cooling fan connector
3.BAT	Battery connector
4.CLR_CMOS	Clear CMOS jumper
5.LED_BAR	Logo LED connector
6.SATA_PWR	SATA power connector
7.M.2_Wifi	M.2 slot for Wifi
8.M.2_SSD	M.2 slot for SSD
9.PWR_BTN	Power button
10.SATA	Serial ATA connector
11.INT_SPK	Internal Speaker connector
12.NFC	NFC connector
13.SODIMM1~2	DDR4 2133 SO-DIMM slots
14.W_CHARGER	Wireless charger connector

## I/O Ports

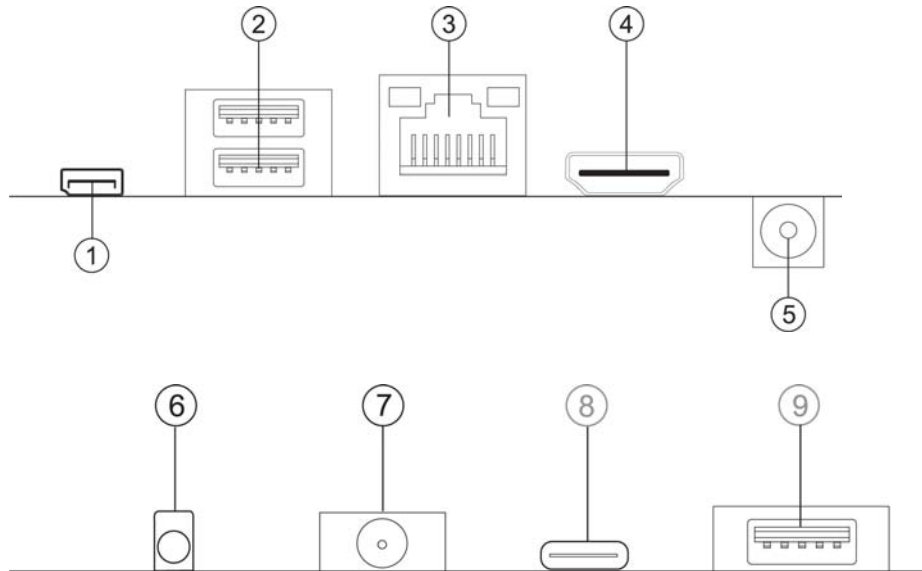

### 1. DP Port

Connect the display devices to the DP port.

### 2. USB 3.0 Ports

Use the USB 3.0 ports to connect USB 3.0 devices.

### 3. RJ45 LAN Port

Connect an RJ-45 jack to the LAN port to connect your computer to the Network.

LAN LED	Status	Description
Activity LED	OFF	No data
	Orange blinking	Active
Link LED	OFF	No link
	Green	Link

Activity LED    Link LED

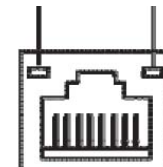

### 4. HDMI Port

Connect the display devices to the HDMI port.

### 5. DC 19V Jack

Connect the DC\_IN jack to the power adapter.

### 6. CIR

It is customer IR sensor.

### 7. Combo Audio Jack (Mic In & Line Out)

Use the combo audio jack to connect the microphone, speaker or headphone.

### 8. USB 3.1 (Type-C) Port

Use the USB 3.1 (Type-C) port to connect USB 3.1 devices.

### 9. USB 3.1 Port

Use the USB 3.1 ports to connect USB 3.1 devices.

## 3.2 Installing the Motherboard

Before you start to set up system, take a moment to become familiar with the location and purposes of the controls, drives, connections and ports, which are illustrated in the figures below.

### 1. Safety Precautions

Follow these safety precautions when installing the motherboard:

- Wear a grounding strap attached to a grounded device to avoid damage from static electricity.
- Discharge static electricity by touching the metal case of a safely grounded object before working on the motherboard.
- Leave components in the static-proof bags.
- Always remove the AC power by unplugging the power cord from the power outlet before installing or removing the motherboard or other hardware components.

### 2. Installing the motherboard in a Chassis

- Aim four locating holes of the SKM-U motherboard.
- Use four screws to secure the motherboard.

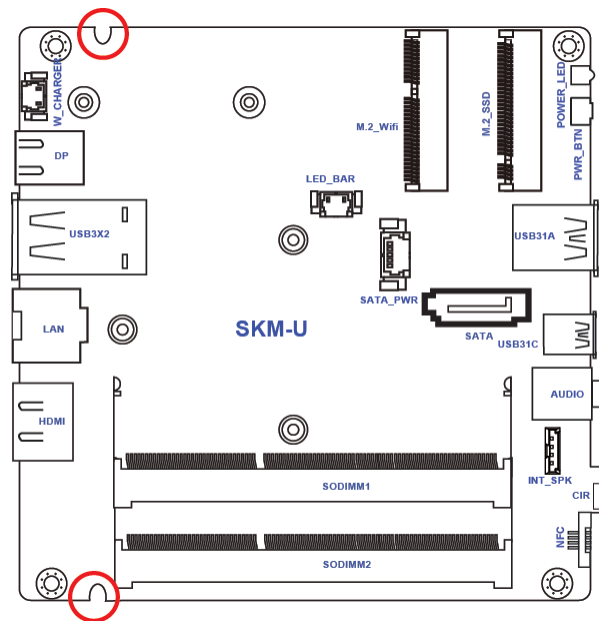

Do not over-tighten the screws as this can stress the motherboard.

### 3. Installing Hardware

#### 3-1. Installing Memory Modules

- This motherboard accommodates two memory module. It can support two 204-pin DDR4 DIMM 2133 MHz.
- Do not remove any memory module from its antistatic packaging until you are ready to install it on the motherboard. Handle the modules only by their edges. Do not touch the components or metal parts. Always wear a grounding strap when you handle the modules.
- You must install one module in the slot. Total memory capacity is 32 GB.
- Refer to the following to install the memory modules.

Install the DIMM module into the slot and press it firmly down until it fits in place. Check that the cutouts on the DIMM module edge connector match the notches in the DIMM slot.

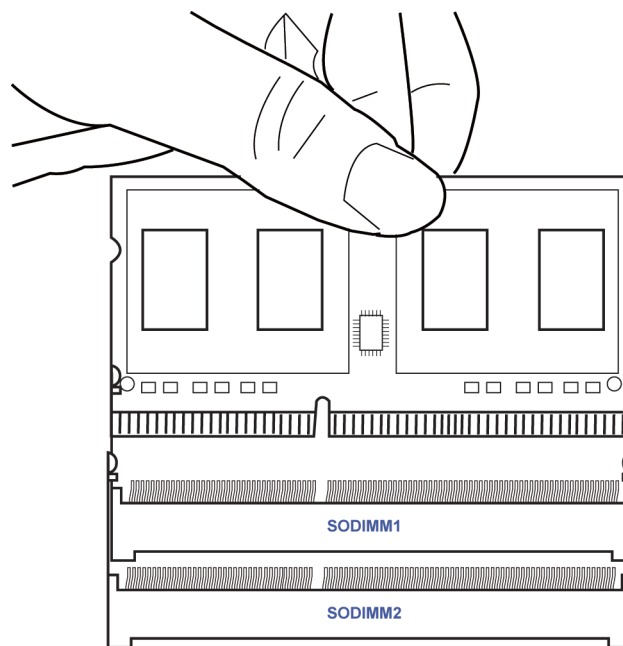

### 3-2. Installing Add-on Cards

The slots on this motherboard are designed to hold expansion cards and connect them to the system bus. Expansion slots are a means of adding or enhancing the motherboard's features and capabilities. With these efficient facilities, you can increase the motherboard's capabilities by adding hardware that performs tasks that are not part of the basic system.

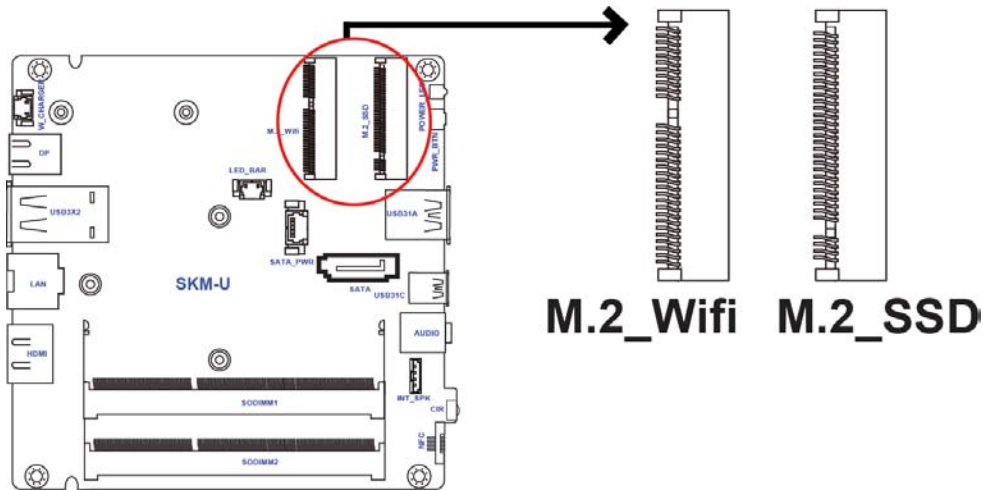

- M.2\_Wifi Slot** The M.2 slot is for extending usage which supports half-card with Wifi signal.
- M.2\_SSD Slot** The M.2 slot is for extending usage which supports half-card with SSD signal.



*Before installing an add-on card, check the documentation for the card carefully. If the card is not Plug and Play, you may have to manually configure the card before installation.*

Follow these instructions to install an add-on card:

- 1 Remove a blanking plate from the system case corresponding to the slot you are going to use.
- 2 Install the edge connector of the add-on card into the expansion slot. Ensure that the edge connector is correctly seated in the slot.
- 3 Secure the metal bracket of the card to the system case with a screw.



*For some add-on cards, for example graphics adapters and network adapters, you have to install drivers and software before you can begin using the add-on card.*

Please refer to the following illustrations to install the add-on card:

*Insert a WIFI card into the M.2\_Wifi Slot.*

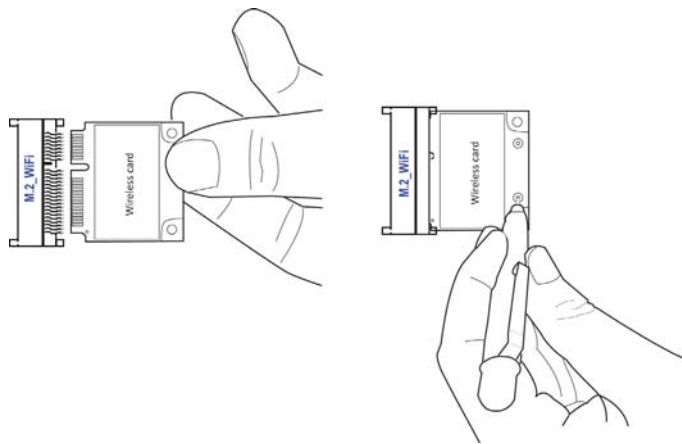

*\* For reference only*

*Insert a SSD card into the M.2\_SSD Slot.*

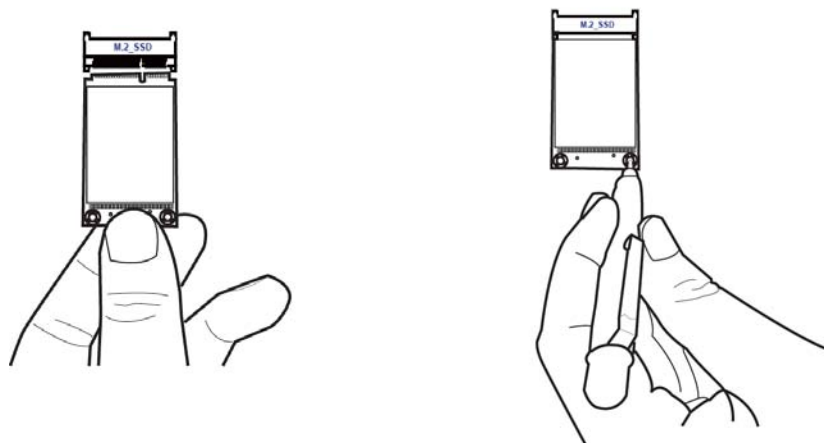

*\* For reference only*

### 3-3. Checking Jumper Settings

This section explains how to set jumpers for connecting configuration of the motherboard.

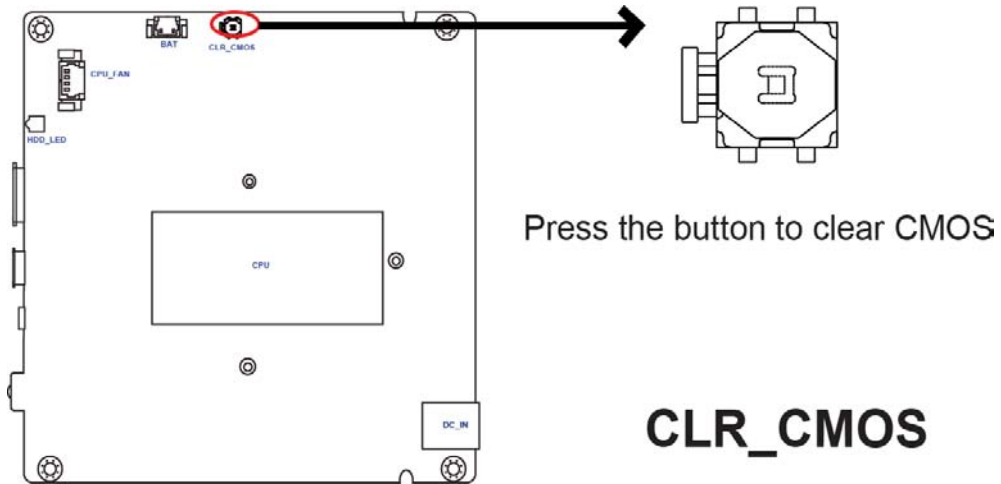

### 3-4. Connecting Optional Devices.

Refer to the following for information on connecting the motherboard's devices.

#### 1. CPU\_FAN: CPU cooling fan connector

Connect the CPU cooling fan to the CPU\_FAN connector.

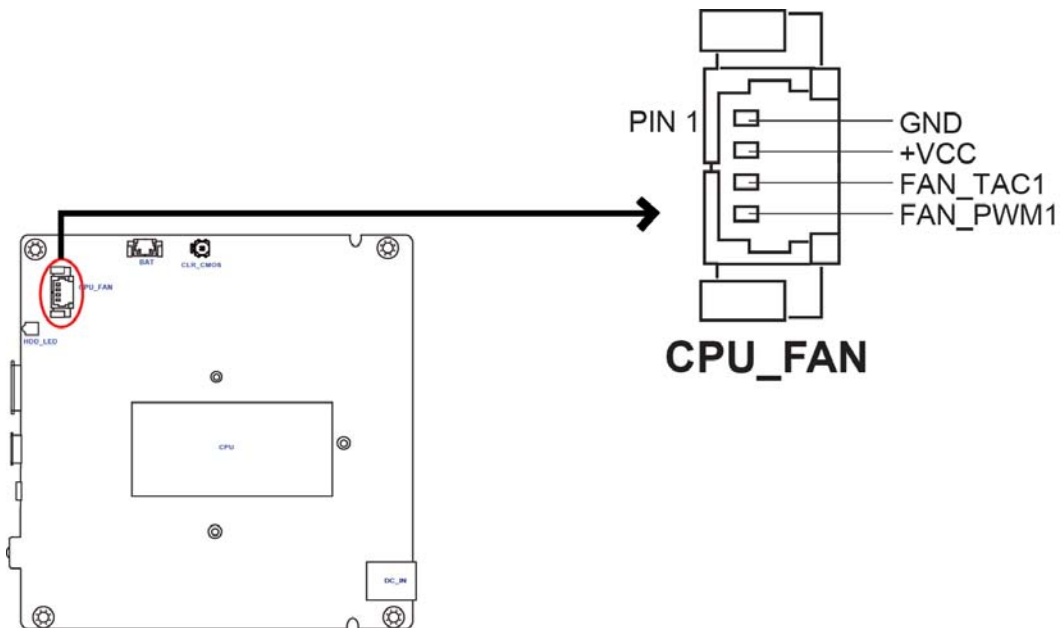



## 2. BAT: Battery connector

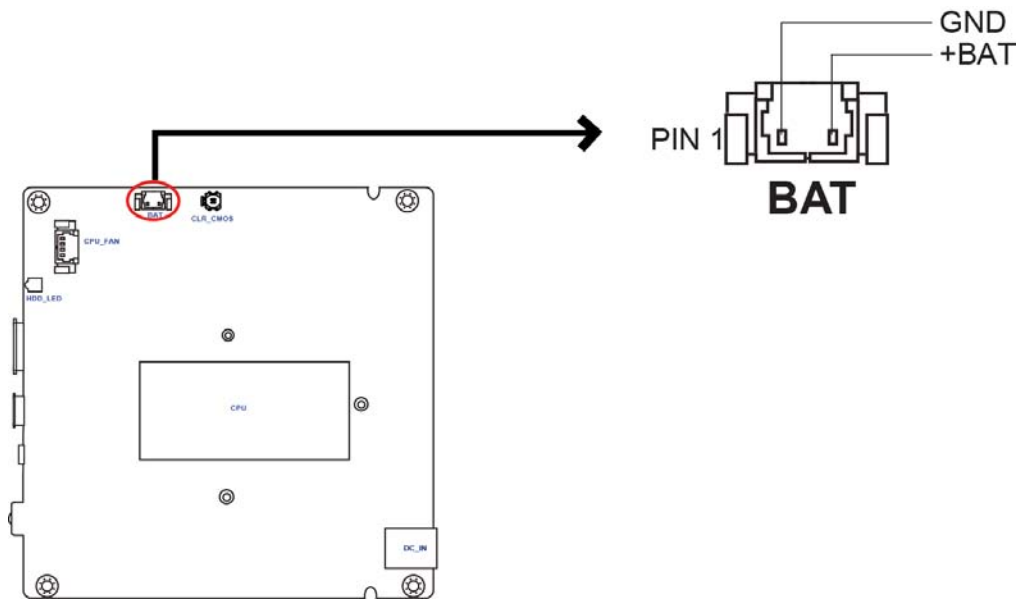

## 2. INT\_SPK: Internal Speaker connector

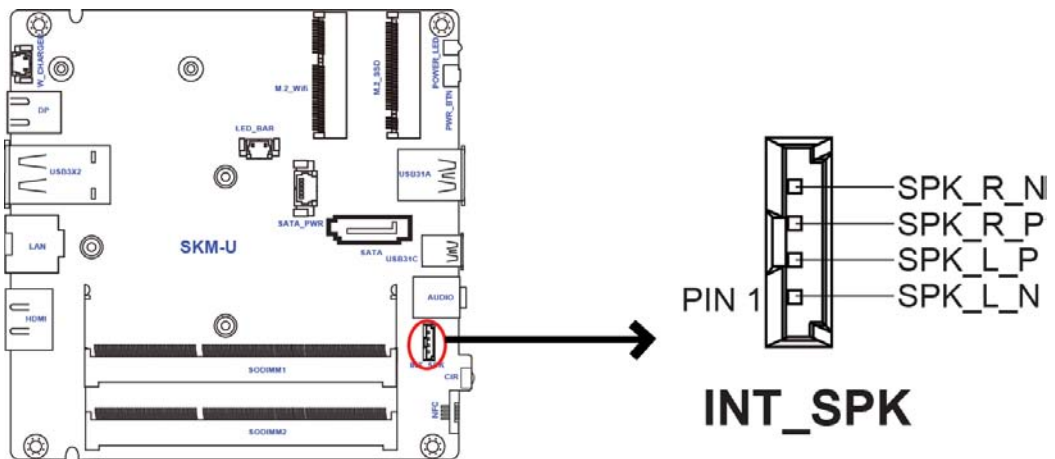

#### 4. W\_CHARGER: Wireless charger connector

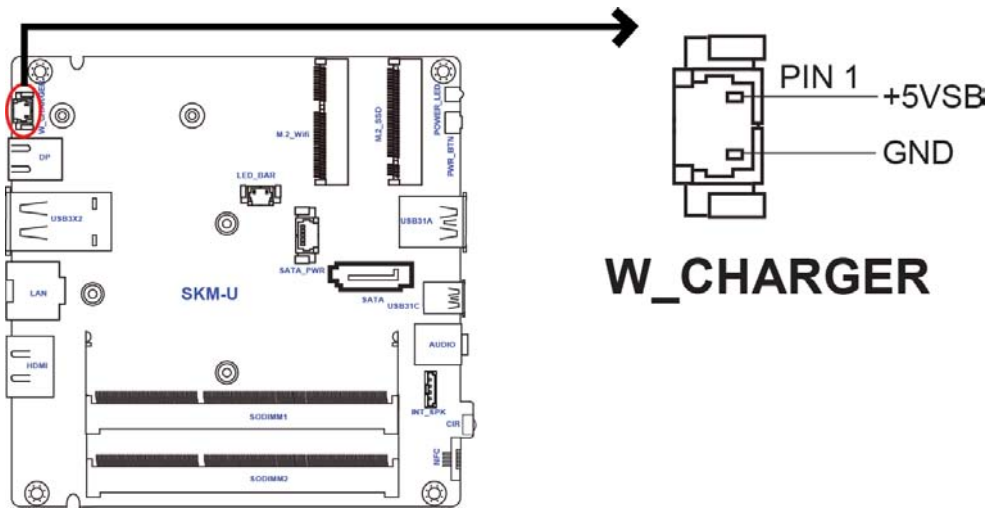

#### 5. LED\_BAR: Logo LED connector

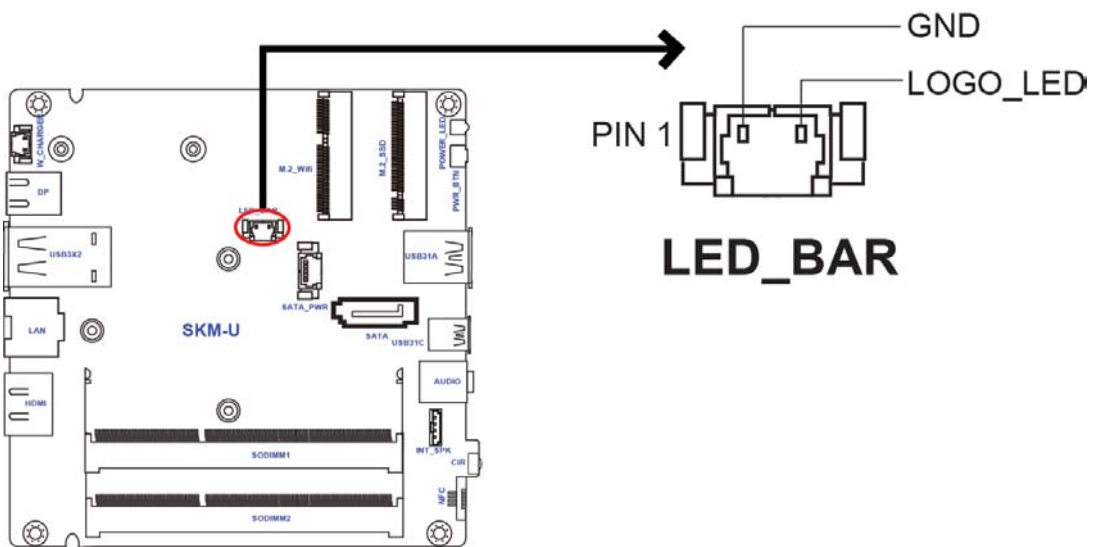

## 6. SATA: Serial ATA connector

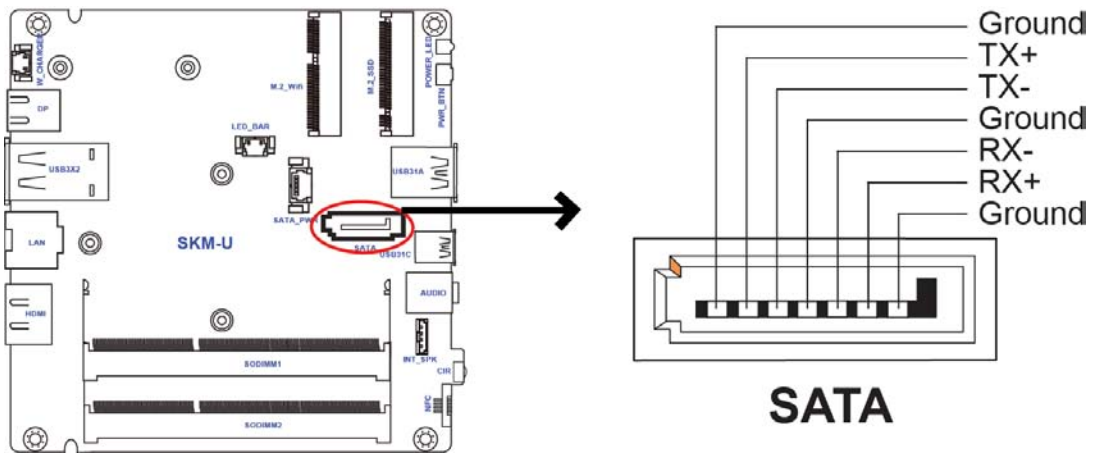

## 7. SATA\_PWR: SATA power connector

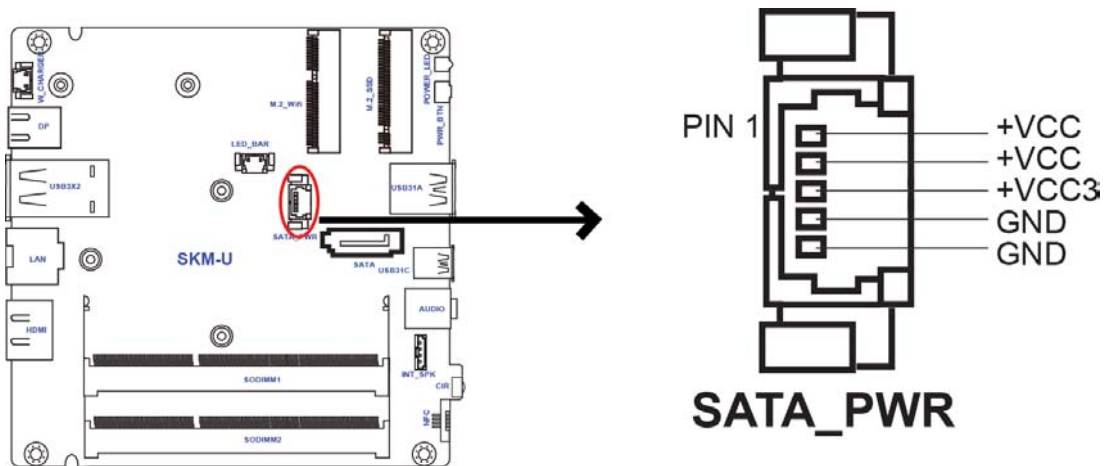

## 8. NFC: NFC connector

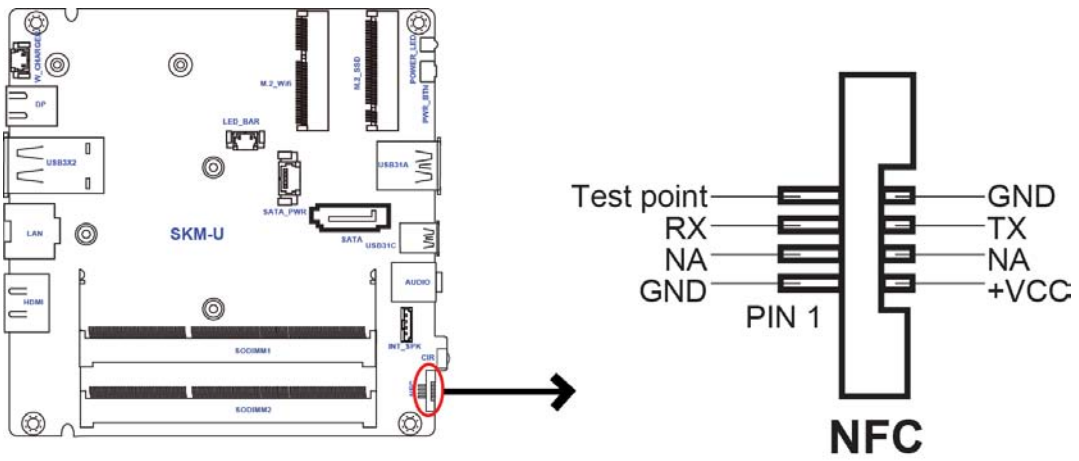

## Chapter 4

### *Using BIOS*

---

#### **About the Setup Utility**

The computer uses the latest “American Megatrends Inc. ?BIOS with support for Windows Plug and Play. The CMOS chip on the motherboard contains the ROM setup instructions for configuring the motherboard BIOS.

The BIOS (Basic Input and Output System) Setup Utility displays the system’s configuration status and provides you with options to set system parameters. The parameters are stored in battery-backed-up CMOS RAM that saves this information when the power is turned off. When the system is turned back on, the system is configured with the values you stored in CMOS.

The BIOS Setup Utility enables you to configure:

- Hard drives, diskette drives and peripherals
- Video display type and display options
- Password protection from unauthorized use
- Power Management features

The settings made in the Setup Utility affect how the computer performs. Before using the Setup Utility, ensure that you understand the Setup Utility options.

This chapter provides explanations for Setup Utility options.

#### ***The Standard Configuration***

A standard configuration has already been set in the Setup Utility. However, we recommend that you read this chapter in case you need to make any changes in the future. This Setup Utility should be used:

- when changing the system configuration
- when a configuration error is detected and you are prompted to make changes to the Setup Utility
- when trying to resolve IRQ conflicts
- when making changes to the Power Management configuration
- when changing the password or making other changes to the Security Setup

#### ***Entering the Setup Utility***

When you power on the system, BIOS enters the Power-On Self Test (POST) routines. POST is a series of built-in diagnostics performed by the BIOS. After the POST routines are completed, the following message appears:

***Press DEL to enter SETUP***

Press the delete key to access BIOS Setup Utility.

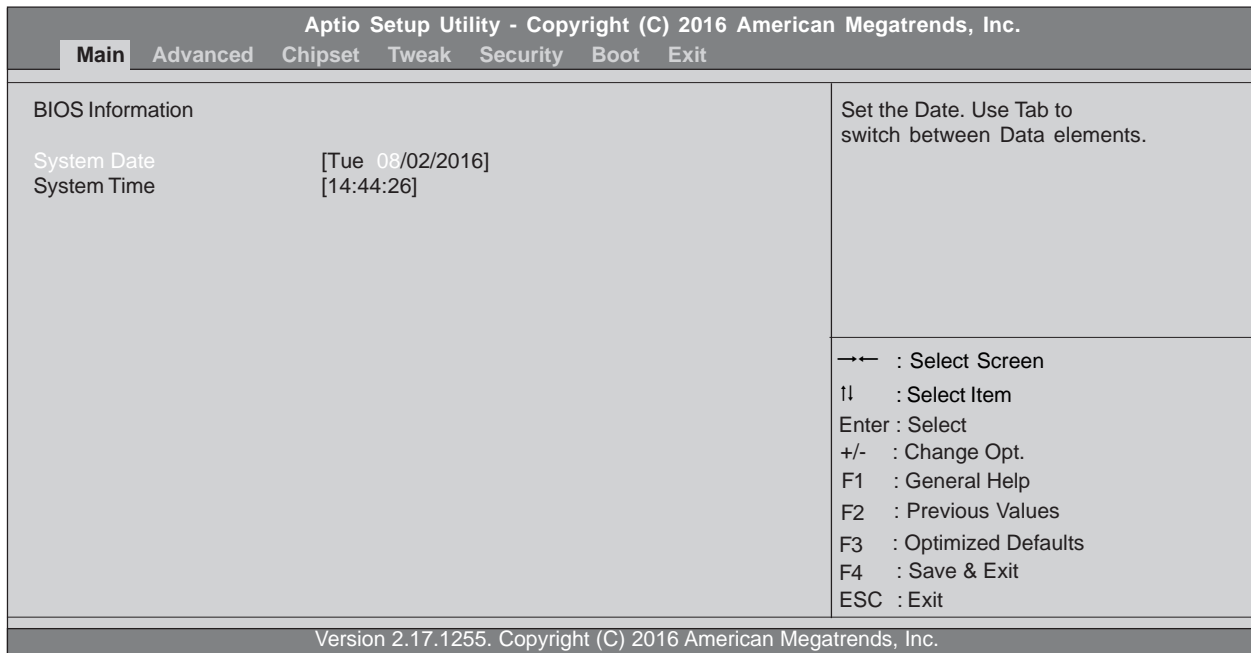

## Using BIOS

When you start the Setup Utility, the main menu appears. The main menu of the Setup Utility displays a list of the options that are available. A highlight indicates which option is currently selected. Use the cursor arrow keys to move the highlight to other options. When an option is highlighted, execute the option by pressing <Enter>.

Some options lead to pop-up dialog boxes that prompt you to verify that you wish to execute that option. Other options lead to dialog boxes that prompt you for information.

Some options (marked with a triangle ►)lead to submenus that enable you to change the values for the option. Use the cursor arrow keys to scroll through the items in the submenu.

In this manual, default values are enclosed in parenthesis. Submenu items are denoted by a triangle ►.



*The default BIOS setting for this motherboard apply for most conditions with optimum performance. We do not suggest users change the default values in the BIOS setup and take no responsibility to any damage caused by changing the BIOS settings.*

## **BIOS Navigation Keys**

The BIOS navigation keys are listed below:

<b>KEY</b>	<b>FUNCTION</b>
<b>ESC</b>	Exits the current menu
↑↓←→	Scrolls through the items on a menu
+/-	Change Opt.
<b>Enter</b>	Select
<b>F1</b>	General Help
<b>F2</b>	Previous Value
<b>F3</b>	Optimized Defaults
<b>F4</b>	Save & Exit



*For the purpose of better product maintenance, the manufacture reserves the right to change the BIOS items presented in this manual. The BIOS setup screens shown in this chapter are for reference only and may differ from the actual BIOS. Please visit the manufacture's website for updated manual.*

## Main Menu

When you enter the BIOS Setup program, the main menu appears, giving you an overview of the basic system information. Select an item and press <Enter> to display the submenu.

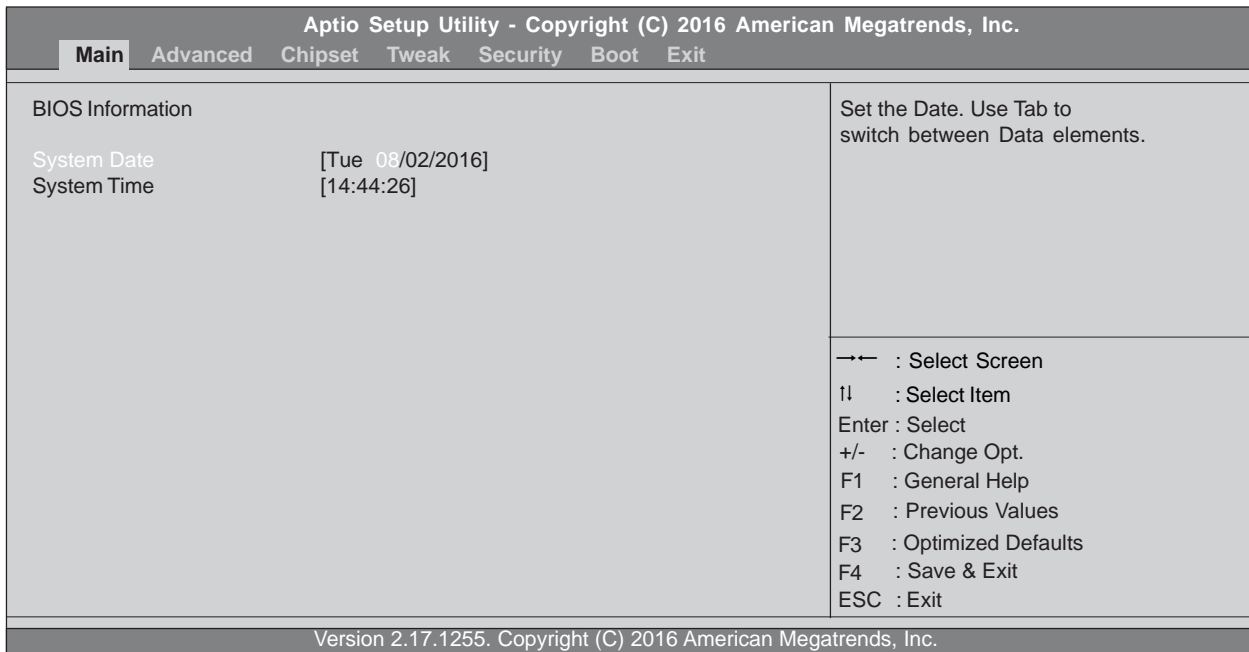

## System Date & Time

The Date and Time items show the current date and time on the computer. If you are running a Windows OS, these items are automatically updated whenever you make changes to the Windows Date and Time Properties utility.



## Advanced Menu

This page sets up more advanced information about your system. Handle this page with caution. Any changes can affect the operation of your computer.

Aptio Setup Utility - Copyright (C) 2016 American Megatrends, Inc.	
<b>Main</b> <b>Advanced</b> Chipset   Tweak   Security   Boot   Exit	
<ul style="list-style-type: none"><li>▶ LAN Configuration</li><li>▶ PC Health Status</li><li>▶ Power Management Setup</li><li>▶ ACPI Settings</li><li>▶ CPU Configuration</li><li>▶ SATA Configuration</li><li>▶ USB Configuration</li><li>▶ Super IO Configuration</li><li>▶ Trusted Computing</li></ul>	LAN Configuration Parameters
	←→ : Select Screen ↑↓ : Select Item Enter : Select +/- : Change Opt. F1 : General Help F2 : Previous Values F3 : Optimized Defaults F4 : Save & Exit ESC : Exit
Version 2.17.1255. Copyright (C) 2016 American Megatrends, Inc.	

## ► LAN Configuration

The item in the menu shows the LAN-related information that the BIOS automatically detects.

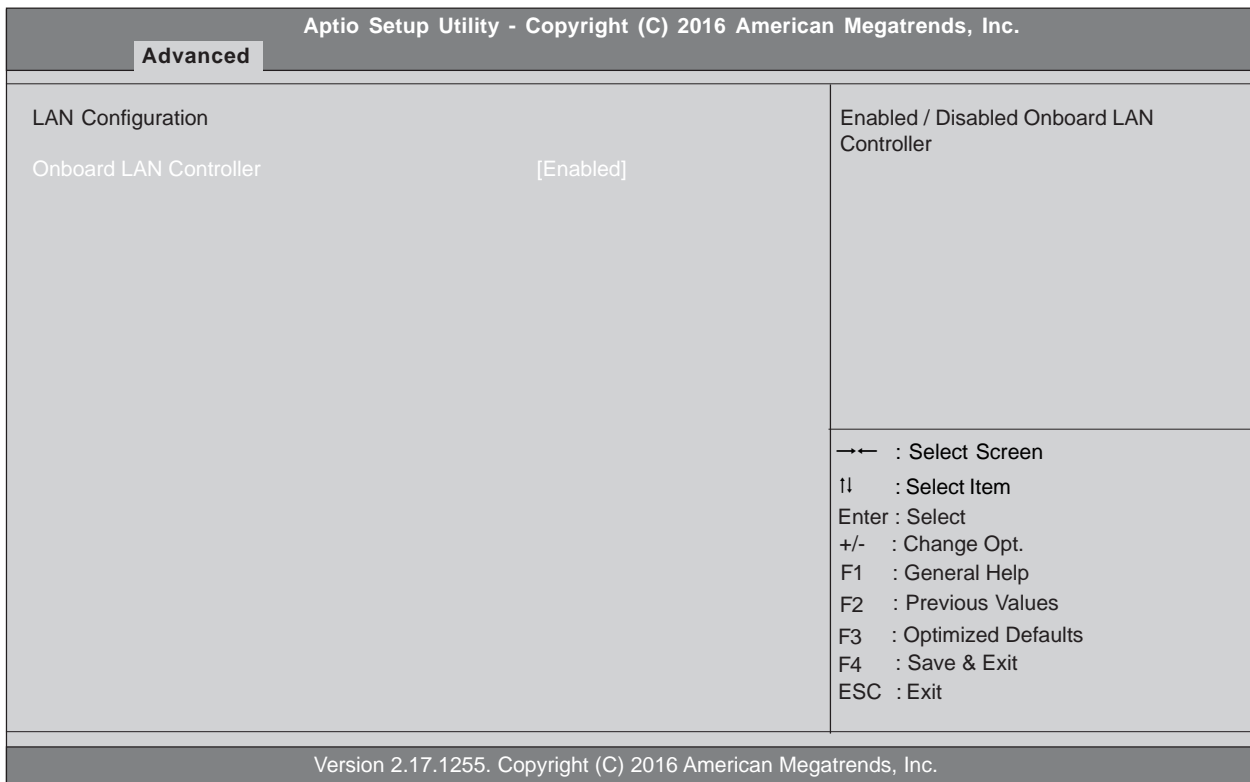

### **Onboard LAN Controller (Enabled)**

Use this item to enable or disable the Onboard LAN.

Press <Esc> to return to the Advanced Menu page.

► **PC Health Status**

On motherboards support hardware monitoring, this item lets you monitor the parameters for critical voltages, temperatures and fan speeds.

Aptio Setup Utility - Copyright (C) 2016 American Megatrends, Inc.		
Advanced		
PC Health Status		Enabled / Disabled Onboard LAN Controller
► Smart Fan Function		
CPU Temperature (DTS)	75	
System Temperature	53°C	
CPU Fan Speed	2789 RPM	
Core Voltage	0.780V	
DIMM Voltage	1.212V	
+5V	5.040V	
+3.3V	3.264V	
+19V	19.080V	
TCC Activation Temperature (DTS)	100	
		←→ : Select Screen ↑↓ : Select Item Enter : Select +/- : Change Opt. F1 : General Help F2 : Previous Values F3 : Optimized Defaults F4 : Save & Exit ESC : Exit
Version 2.17.1255. Copyright (C) 2016 American Megatrends, Inc.		

► **Smart Fan Function**

Scroll to this item and press <Enter> to view the following screen:

Aptio Setup Utility - Copyright (C) 2016 American Megatrends, Inc.		
Advanced		
Smart Fan Select	[CPU]	Enabled / Disabled Onboard LAN Controller
Smart Fan Mode	[Normal]	
Smart Fan start PWM value	89	
Smart Fan start PWM TEMP (DTS)	76	
Deltat	2	
Smart Fan Slope PWM value	6	
Fan Full Speed Offset (DTS)	91	
		←→ : Select Screen ↑↓ : Select Item Enter : Select +/- : Change Opt. F1 : General Help F2 : Previous Values F3 : Optimized Defaults F4 : Save & Exit ESC : Exit
Version 2.17.1255. Copyright (C) 2016 American Megatrends, Inc.		

### **Smart Fan Select (CPU)**

This item enables you to select CPU Smart fan or System Smart fan, and control it.

### **Smart Fan Mode (Normal)**

This item allows you to select the fan mode (Normal, Quiet, Silent, or Manual) for a better operation environment. If you choose Normal mode, the fan speed will be auto adjusted depending on the CPU temperature. If you choose Quiet mode, the fan speed will be auto minimized for quiet environment. If you choose Silent mode, the fan speed will be auto restricted to make system more quietly. If you choose Manual mode, the fan speed will be adjust depending on users' p parameters.

### **Smart Fan start PWM value (89)**

This item is used to set the start PWM value of the smart fan.

### **Smart Fan start PWM TEMP (DTS) (76)**

This item is used to set the start temperature of the smart fan.

### **DeltaT (2)**

This item specifies the range that controls CPU temperature and keeps it from going so high or so low when smart fan works.

### **Smart Fan Slope PWM value (6)**

This item is used to set the Slope Select PWM of the smart fan.

### **Fan Full Speed Offset (DTS) (91)**

This item is used to set the CPU fan/System fan full speed offset value.

Press <Esc> to return to the PC Health Status page.

## **System Component Characteristics**

These items display the monitoring of the overall inboard hardware health events, such as System temperature, CPU & DIMM voltage, CPU & System fan speed... etc.

- CPU Temperature
- System Temperature
- CPU Fan Speed
- Core Voltage
- DIMM Voltage
- +5V
- +3.3V
- +19V

Press <Esc> to return to the Advanced Menu page.

## ► Power Management Setup

This page sets up some parameters for system power management operation.

Aptio Setup Utility - Copyright (C) 2016 American Megatrends, Inc.		
Advanced		
Power Management Setup		About Resume By PCI/PCI-E/LAN/Ext. USB3.1 PME
Resume By PME	[Disabled]	
Resume By USB	[Disabled]	
Resume By CIR	[Disabled]	
Resume By RTC Alarm	[Disabled]	
EUP Function	[Enabled]	
		→← : Select Screen ↑↓ : Select Item Enter : Select +/- : Change Opt. F1 : General Help F2 : Previous Values F3 : Optimized Defaults F4 : Save & Exit ESC : Exit
Version 2.17.1255. Copyright (C) 2016 American Megatrends, Inc.		

### **Resume By PME (Disabled)**

This item specifies whether the system will be awakened from power saving modes when activity or input signal of the specified hardware peripheral or components is detected.

### **Resume By USB (Disabled)**

This item allows you to enable/disable the USB device wakeup function from S3 mode.

### **Resume By CIR (Disabled)**

This item enables or disables you to wake up the system by IR.

### **Resume By RTC Alarm (Disabled)**

The system can be turned off with a software command. If you enable this item, the system can automatically resume at a fixed time based on the system's RTC (realtime clock). Use the items below this one to set the date and time of the wake-up alarm. You must use an ATX power supply in order to use this feature.

### **EUP Function (Enabled)**

This item allows user to enable or disable EUP support.

Press <Esc> to return to the Advanced Menu page.

► **ACPI Settings**

This item in the menu shows the highest ACPI sleep state when system enters suspend.

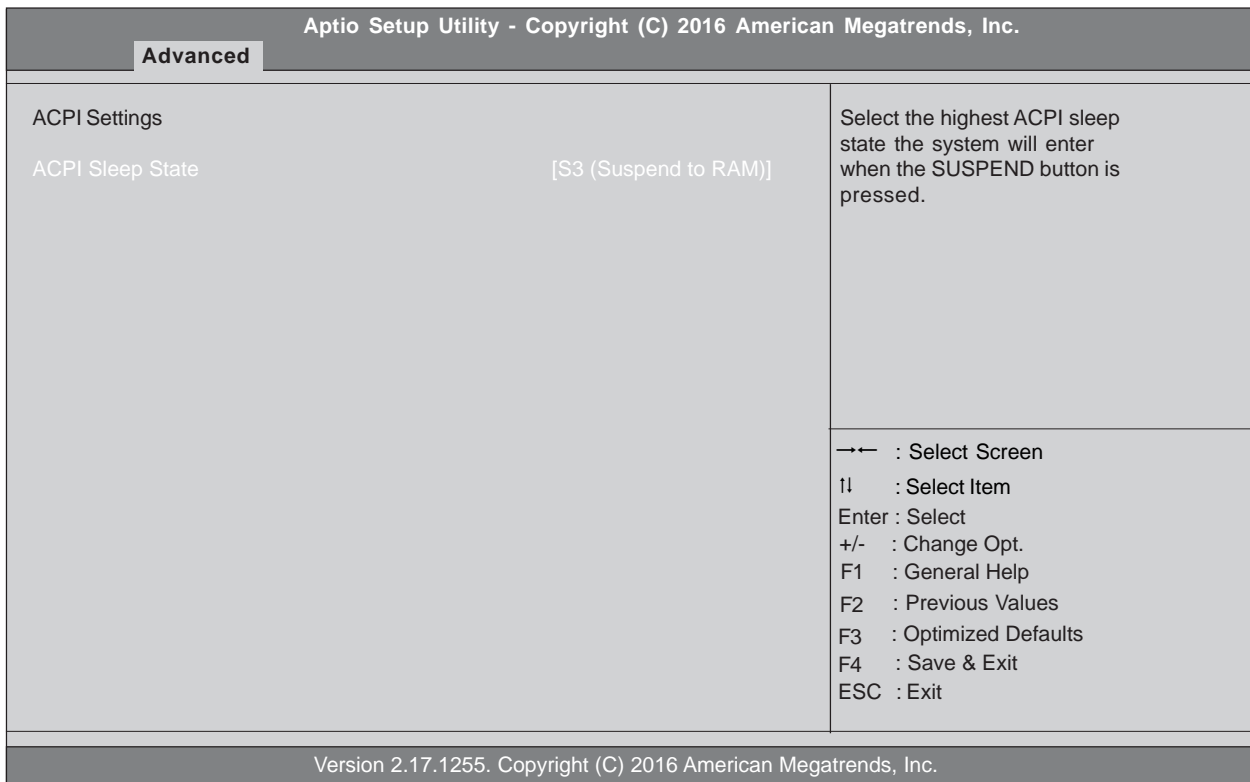

**ACPI Sleep State (S3 (Suspend to RAM))**

This item allows you to enter the ACPI S3 (Suspend to RAM) Sleep State (default).

Press <Esc> to return to the Advanced Menu page.

► **CPU Configuration**

This item in the menu shows the CPU Configuration.

Aptio Setup Utility - Copyright (C) 2016 American Megatrends, Inc.		
Advanced		
CPU Configuration		Enabled for windows XP and Linux (OS optimized for Hyper-Threading Technology) and Disabled for other OS (OS not optimized for Hyper-Threading Technology). when Disabled only one thread per enabled core is enabled.
Intel (R) Core (TM) i5-6260U CPU @ 1.80GHz	Supported	
EM64T	1800 MHz	
Processor Speed	406E3	
Processor Stepping	8A	
Microcode Revision	2	
Processor Cores	Supported	
Intel HT Technology	Supported	
Intel VT-x Technology	Supported	
Hyper-threading	[Enabled]	
Active Processor Cores	[All]	→← : Select Screen ↑↓ : Select Item Enter : Select +/- : Change Opt. F1 : General Help F2 : Previous Values F3 : Optimized Defaults F4 : Save & Exit ESC : Exit
Limit CPUID Maximum	[Disabled]	
Execute Disable Bit	[Enabled]	
Intel Virtualization Technology	[Enabled]	
Package C State limit	[AUTO]	
Enhanced Halt (C1E)	[Enabled]	
Version 2.17.1255. Copyright (C) 2016 American Megatrends, Inc.		

**Intel (R) Core (TM) i5-6260U CPU @ 1.80GHz**

This is display-only field and displays the informaton of the CPU installed in your computer.

**EM64T (Supported)**

This item shows the computer supports EMT64.

**Processor Speed (1800 MHz)**

This item shows the processor speed.

**Processor Stepping (406E3)**

This item shows the processor stepping version.

**Microcode Revision (8A)**

This item shows the Microcode version.

**Processor Cores (2)**

This item shows the number of cores of the processor.

**Intel HT Technology (Supported)**

This item shows the computer supports Intel HT technology or not.

**Intel VT-x Technology (Supported)**

This item shows the computer supports Intel VT-x technology or not.

**Hyper-threading (Enabled)**

This item only available when the chipset supports Hyper-threading and you are using a Hyper-threading CPU.

**Active Processor Cores (All)**

Use this item to control the number of active processor cores.

**Limit CPUID Maximum (Disabled)**

Use this item to enable or disable the maximum CPUID value limit, you can enable this item to prevent the system from “rebooting” when trying to install Windows NT 4.0.

**Execute Disable Bit (Enabled)**

This item allows the processor to classify areas in memory by where application code can execute and where it cannot. When a malicious worm attempts to insert code in the buffer, the processor disables code execution, preventing damage or worm propagation. Replacing older computers with Execute Disable Bit enabled systems can halt worm attacks, reducing the need for virus related repair.

**Intel Virtualization Technology (Enabled)**

When disabled, a VMM cannot utilize the additional hardware capabilities provided by Vander Pool Technology.

**Package C state limit (AUTO)**

Use this item to set package C state limit.

**Enhanced Halt (C1E) (Enabled)**

Use this item to enable the CPU energy-saving function when the system is not running.

Press <Esc> to return to the Advanced Menu page.



## ► ACPI Settings

This item in the menu shows the highest ACPI sleep state when system enters suspend.

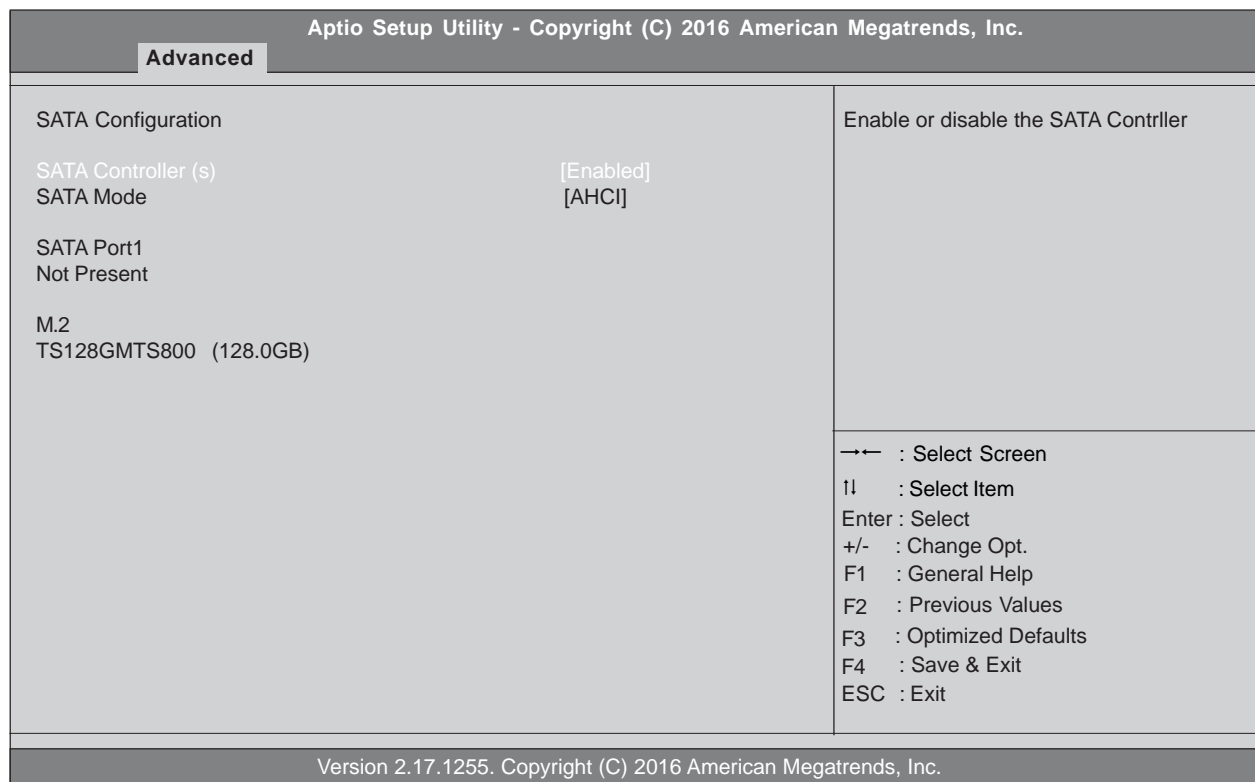

### **SATA Controllers (Enabled)**

This item allows you to to enable or disable SATA controllers.

### **SATA Mode (AHCI)**

Use this item to select SATA mode.

### **SATA Port1 (Not Present/M.2)**

This motherboard supports one SATA channel and one M.2\_SSD, each channel allows one SATA device to be installed. Use these items to configure each device on the SATA channel and the M.2\_SSD.

Press <Esc> to return to the Advanced Menu page.

## ► USB Configuration

Use this item to show the information of USB configuration.

Aptio Setup Utility - Copyright (C) 2016 American Megatrends, Inc.	
Advanced	
USB Configuration	USB Support Parameters
All USB Devices [Enabled]	
Legacy USB Support [Enabled]	
USB3.0 Controller [Enabled]	
	→← : Select Screen
	↑↓ : Select Item
	Enter : Select
	+/- : Change Opt.
	F1 : General Help
	F2 : Previous Values
	F3 : Optimized Defaults
	F4 : Save & Exit
	ESC : Exit
Version 2.17.1255. Copyright (C) 2016 American Megatrends, Inc.	

### All USB Devices (Enabled)

Use this item to enable or disable all USB devices

### Legacy USB Support (Enabled)

Use this item to enable or disable support for legacy USB devices.

### USB3.1 Contrller (Enabled)

Use this item to enable or disable USB3.1 contrller.

Press <Esc> to return to the Advanced Menu page.

► **Super IO Configuration**

Use this item to show the information of Super IO configuration.

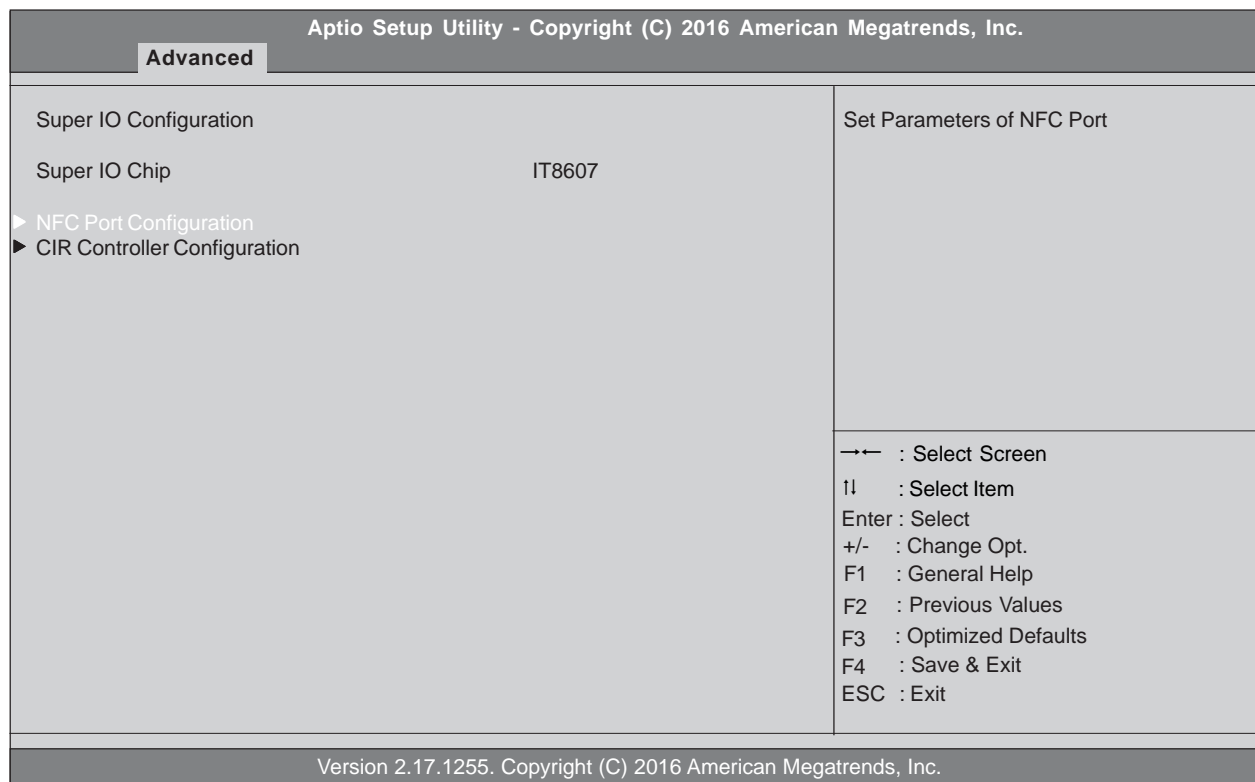

**Super IO Chip (IT8607)**

This item shows the information of the super IO chip.

► **NFC Port Configuration**

Scroll to this item and press <Enter> to view the following screen.

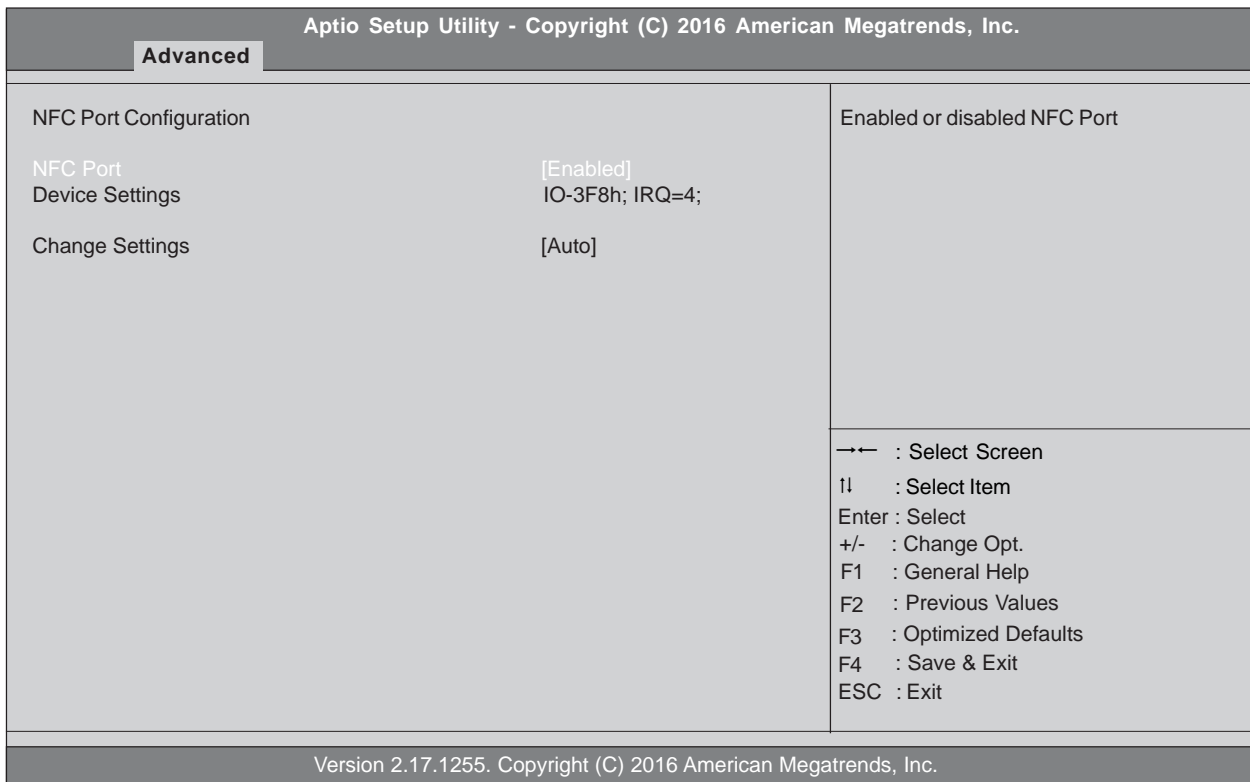

**NFC Port (Enabled)**

This item allows you to enable or disable NFC.

**Device Settings (IO=3F8h; IRQ=4;)**

This item shows the information of the device settings.

**Change Settings (Auto)**

Use this item to change device settings.

Press <Esc> to return to the Super IO Configuration page.

Press <Esc> to return to the Advanced Menu page.

## ► CIR Controller Configuration

Scroll to this item and press <Enter> to view the following screen.

Aptio Setup Utility - Copyright (C) 2016 American Megatrends, Inc.		
Advanced		
CIR Controller Configuration		Enabled or disabled CIR Controller
CIR Controller	[Enabled]	
Device Settings	IO=3E0h; IRQ=10;	
Change Settings	[Auto]	
		→← : Select Screen ↑↓ : Select Item Enter : Select +/- : Change Opt. F1 : General Help F2 : Previous Values F3 : Optimized Defaults F4 : Save & Exit ESC : Exit
Version 2.17.1255. Copyright (C) 2016 American Megatrends, Inc.		

### **CIR Controller (Enabled)**

This item allows you to enable or disable CIR Controller.

### **Device Settings (IO=3E0h; IRQ=10;)**

This item shows the information of the device settings.

### **Change Settings (Auto)**

Use this item to change device settings.

Press <Esc> to return to the Super IO Configuration page.

Press <Esc> to return to the Advanced Menu page.

► **Trusted Computing**

Use this item to show the information of trusted computing configuration.

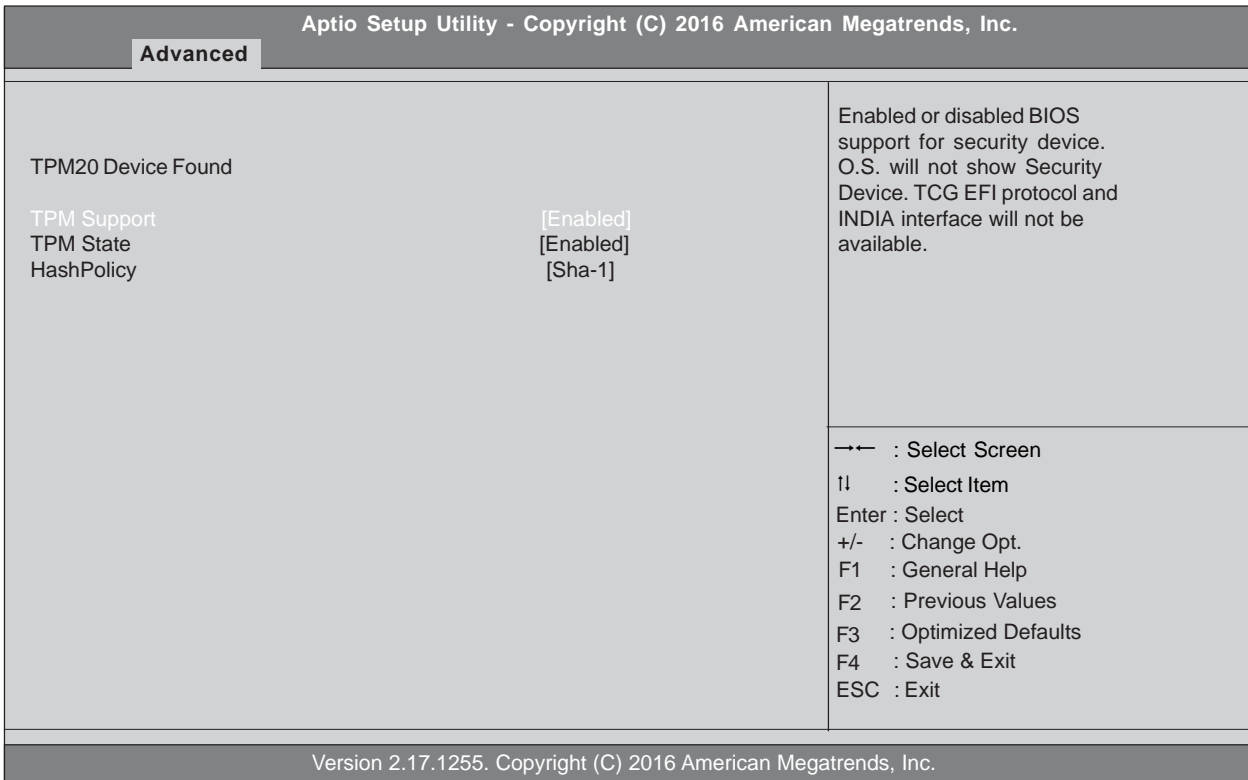

**TPM Support (Enabled)**

Use this item to enable or disable the TPM support. OS will not show TPM. Reset of platform is required.

**TPM State (Enabled)**

Use this item to enable or disable the security device.

**HashPolicy (Sha-1)**

Select the Hash policy to use. SHA-2 is most secure but might not be supported by all Operating Systems.

Press <Esc> to return to the Advanced Menu page.

## Chipset Menu

This page sets up more advanced information about your system. Handle this page with caution. Any changes can affect the operation of your computer.

The screenshot shows the Aptio Setup Utility interface. At the top, the title bar reads "Aptio Setup Utility - Copyright (C) 2016 American Megatrends, Inc." Below the title bar is a navigation menu with options: "Main", "Advanced", "Chipset" (which is highlighted), "Tweak", "Security", "Boot", and "Exit". The main area is divided into two columns. The left column contains a list of configuration options: "System Agent Configuration", "PCH Configuration", and "ME Configuration", each preceded by a right-pointing triangle. The right column is titled "LAN Configuration Parameters" and is currently empty. Below the main content area, a legend lists keyboard shortcuts: "←→" for "Select Screen", "↑↓" for "Select Item", "Enter" for "Select", "+/-" for "Change Opt.", "F1" for "General Help", "F2" for "Previous Values", "F3" for "Optimized Defaults", "F4" for "Save & Exit", and "ESC" for "Exit". At the bottom of the screen, a footer bar contains the text "Version 2.17.1255. Copyright (C) 2016 American Megatrends, Inc."

► **System Agent Configuration**

Scroll to this item and press <Enter> and view the following screen:

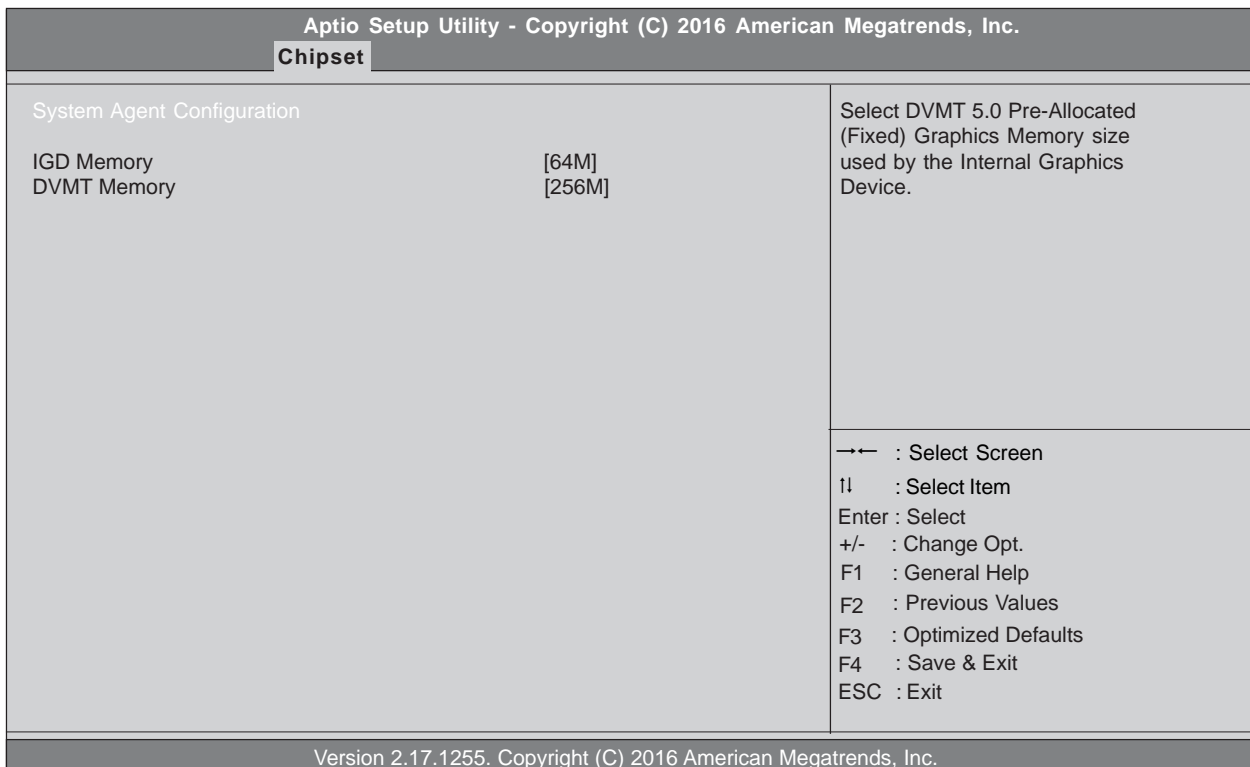

**IGD Memory (64M)**

This item shows the information of the IGD (Internal Graphics Device) memory.

**DVMT Memory (256M)**

When set to Fixed Mode, the graphics driver will reserve a fixed position of the system memory as graphics memory, according to system and graphics requirements.

Press <Esc> to return to the Chipset Menu page.



► **PCH Configuration**

Scroll to this item and press <Enter> and view the following screen:

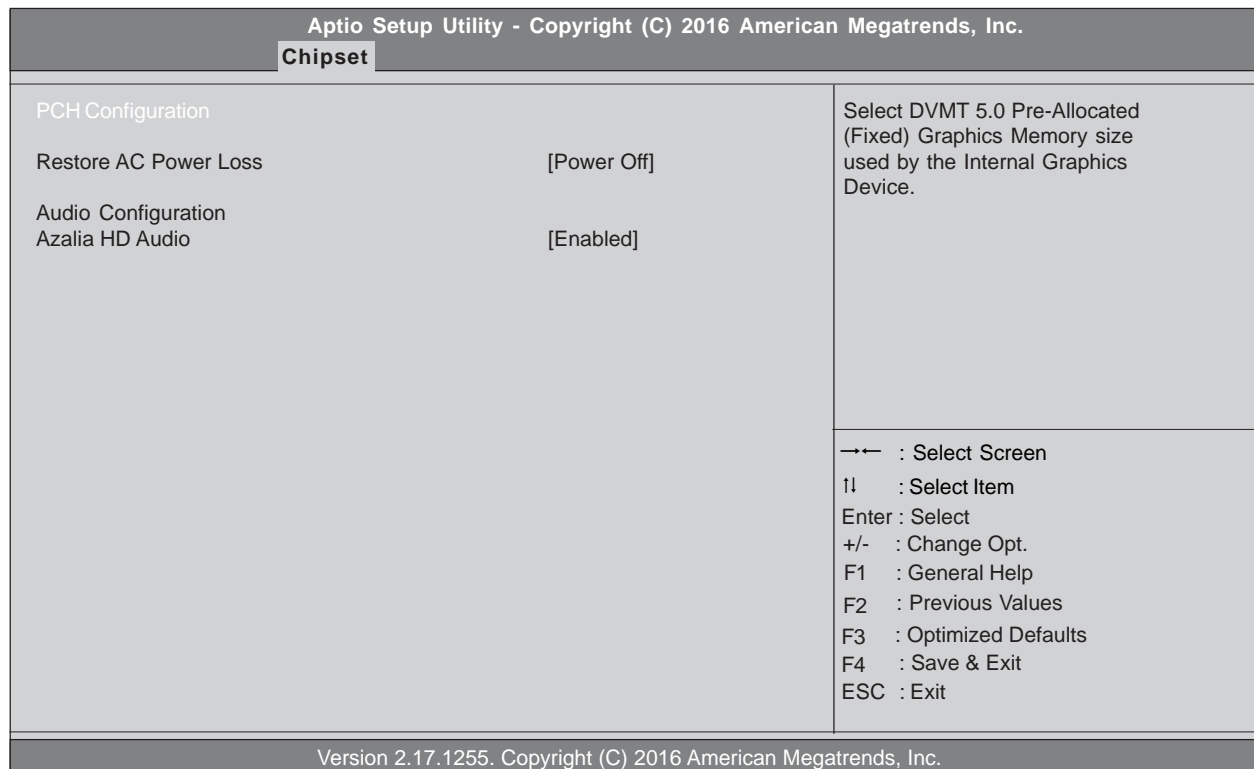

**Restore AC Power Loss (Power Off)**

This item enables your computer to automatically restart or return to its operating status.

**Azalia HD Audio (Enabled)**

This item enables or disables Azalia HD audio.

Press <Esc> to return to the Chipset Menu page.

► **ME Configuration**

Scroll to this item and press <Enter> and view the following screen:

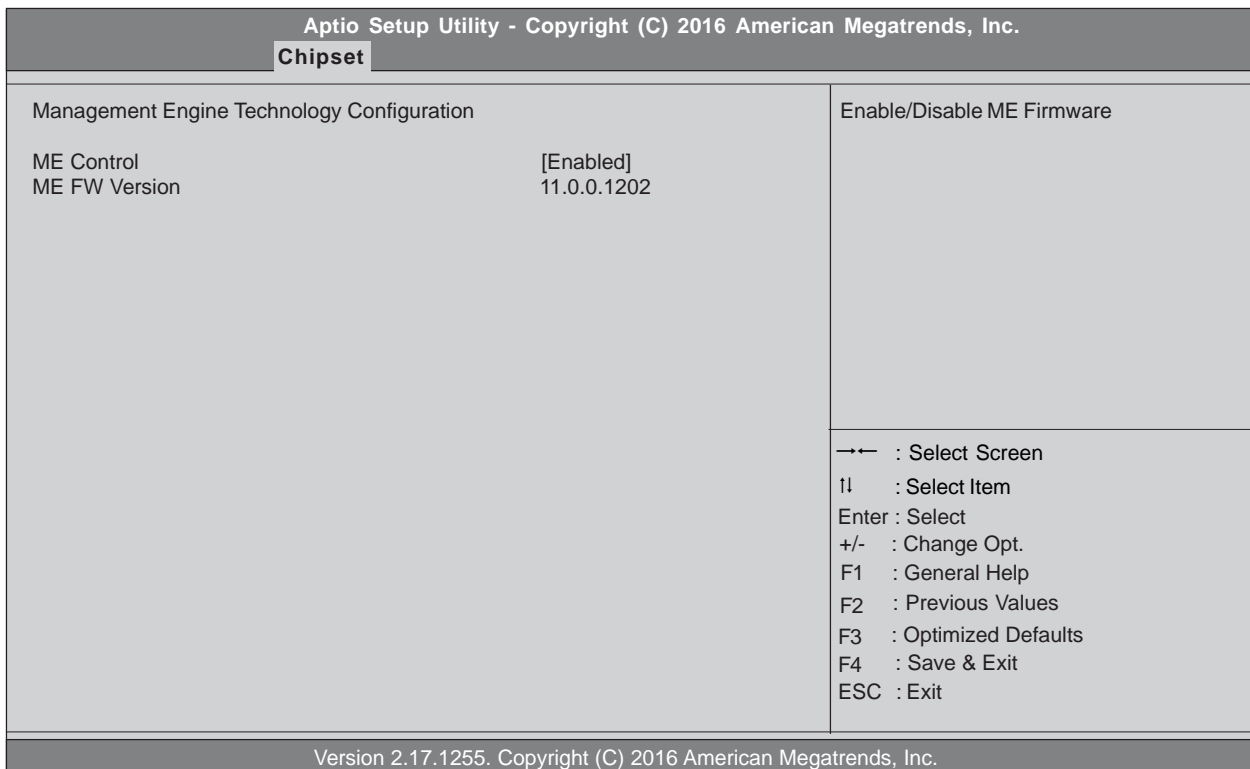

**ME Control (Enabled)**

Use this item to enable or disable the ME Firmware.

**ME FW Version (9.1.0.1120)**

This item shows the ME FW version.

Press <Esc> to return to the Chipset Menu page.

## Tweak Menu

This page enables you to monitor or set some information of the processor you have installed in your system.

Aptio Setup Utility - Copyright (C) 2016 American Megatrends, Inc.						
Main	Advanced	Chipset	<b>Tweak</b>	Security	Boot	Exit
Tweak				Turbo Boost		
Turbo Boost				[Enabled]		
Intel (R) Core (TM) i5-6260U CPU @ 1.80GHz						
Processor Speed				1800 MHz		
Memory Frequency				2133 MHz		
Total Memory				4096 MB		
				→← : Select Screen		
				↑↓ : Select Item		
				Enter : Select		
				+/- : Change Opt.		
				F1 : General Help		
				F2 : Previous Values		
				F3 : Optimized Defaults		
				F4 : Save & Exit		
				ESC : Exit		
Version 2.17.1255. Copyright (C) 2016 American Megatrends, Inc.						

### **Turbo Boost (Enabled)**

This item allows you to enable or disable the turbo boost.

### **Intel(R) Core (TM) i5-6260U CPU @ 1.80GHz**

This is display-only field and displays the information of the CPU installed in your computer.

### **Processor Speed (1800 MHz)**

This item shows the current CPU speed.

### **Memory Frequency (2133 MHz)**

This item shows the memory frequency.

### **Total Memory (4096 MB)**

This item shows the total memory.

## Security Menu

This page enables you to set administrator password and user password.

Aptio Setup Utility - Copyright (C) 2016 American Megatrends, Inc.						
Main	Advanced	Chipset	Tweak	Security	Boot	Exit
Administrator Password				Set Administrator Password		
Administrator Password		Not Install				
User Password Status		Not Install				
System Mode state		Setup				
Secure Boot state		Not Active				
Secure Boot		[Enabled]				
Secure Boot Mode		[Standard]				
				→← : Select Screen		
				↑↓ : Select Item		
				Enter : Select		
				+/- : Change Opt.		
				F1 : General Help		
				F2 : Previous Values		
				F3 : Optimized Defaults		
				F4 : Save & Exit		
				ESC : Exit		
Version 2.17.1255. Copyright (C) 2016 American Megatrends, Inc.						

### Administrator Password Status (Installed)

This item shows administrator password installed or not.

### User Password Status (Not Installed)

This item shows user password installed or not.

### System Mode state (Setup)

This item shows system mode setup or not.

### Secure Boot state (Not Active)

This item allows you to enable or disable the secure boot state.

### Secure Boot (Enabled)

This item is used to control the secure boot flow, it is possible only if system runs in User Mode.

### Secure Boot Mode (Standard)

This item is used to select secure boot mode, when you select standard mode, secure boot policy is fixed; when you select custom mode, the image execution policy and secure boot key databases are changeable.

## Boot Menu

This page enables you to set the keyboard NumLock state.

Aptio Setup Utility - Copyright (C) 2016 American Megatrends, Inc.		
Main	Advanced	Chipset Tweak Security <b>Boot</b> Exit
Boot Configuration Operating System Select [Windows 8.x / 10] Launch PXE OpROM [Disabled] Launch Storage OpROM [Enabled] Bootup NumLock State [On] Quiet Boot [Enabled] Boot Mode Select [UEFI] Fixed BOOT ORDER Priorities Boot Option #1 [Hard Disk: windows B...] Boot Option #2 [USB Hard Disk] Boot Option #3 [USB CD/DVD] Boot Option #4 [USB Key] Boot Option #5 [USB Floppy] Boot Option #6 [Network]		Windows 7 or other OS: Boot policy for Legacy OS Windows 8.x / 10: Boot policy for UEFI OS without Compatibility Support Module (CSM) Manual: User customized CSM parameters & boot policy
► UEFI Hard Disk Drive Priorities		←→ : Select Screen ↑↓ : Select Item Enter : Select +/- : Change Opt. F1 : General Help F2 : Previous Values F3 : Optimized Defaults F4 : Save & Exit ESC : Exit
Version 2.17.1255. Copyright (C) 2016 American Megatrends, Inc.		

### Operating System Select (Windows 8.x / 10)

This item is used to select the operating system.

### Launch PXE OpROM (Disabled)

This item enables or disables launch PXE Option ROM

### Launch Storage OpROM (Enabled)

This item enables or disables the Storage OpROM.

### Bootup NumLock State (On)

This item enables you select NumLock state.

### Quiet Boot (Enabled)

This item enables or disables the boot LOGO.

### Boot Mode Select (UEFI)

Use this item to select boot mode.

### Boot Option #1~6 (UEFI)

These items show the boot priorities and can be used to set the boot priorities of various device categories.

### UEFI Hard Disk Drive Priorities

This item enables you to specify the sequence of loading the operating system from the installing Hard Disk drive.(This item only shows when there is boot device connecting)

Press <Enter> to see the submenu.

## Exit Menu

This page enables you to set administrator password and user password.

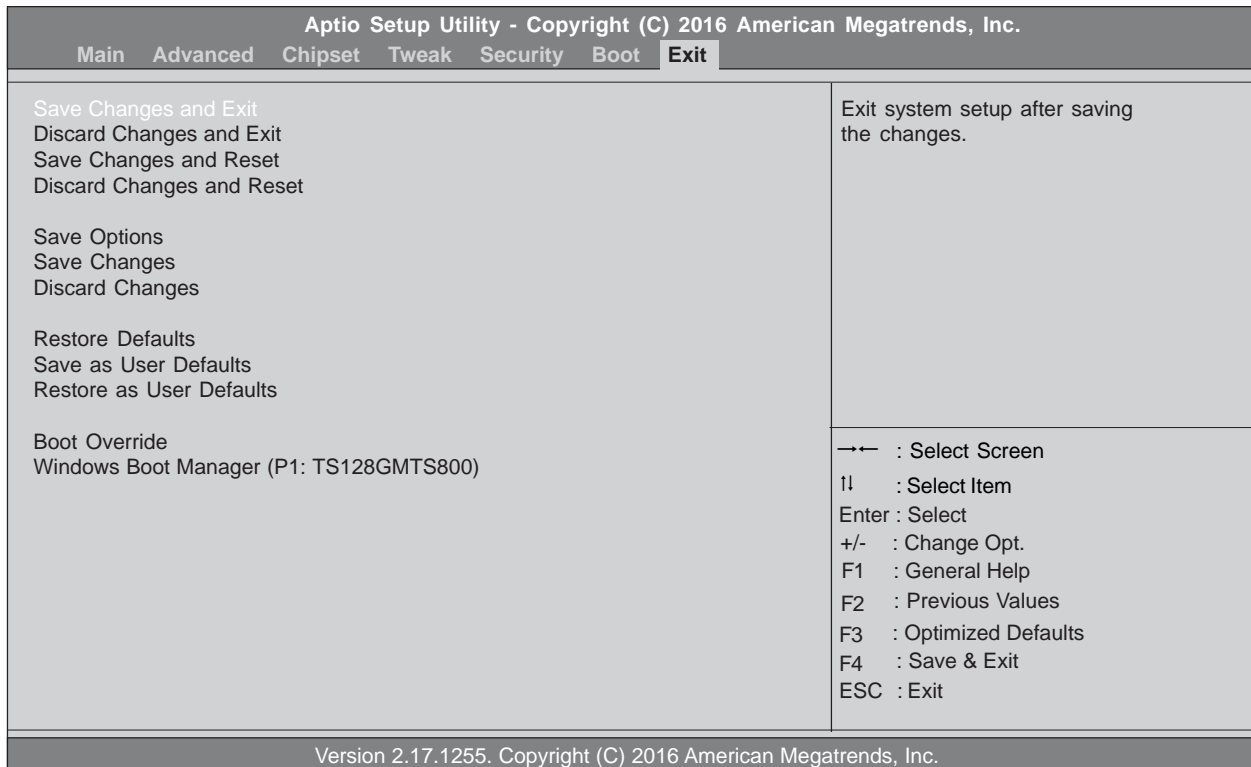

### Save Changes and Exit

This item enables you to exit system setup after saving the changes.

### Discard Changes and Exit

This item enables you to exit system setup without saving any changes.

### Save Changes and Reset

This item enables you to reset system setup after saving the changes.

### Discard Changes and Reset

This item enables you to reset system setup without saving any changes.

### Save Options

This item enables you to save the options that you have made.

### Save Changes

This item enables you to save the changes that you have made.

### Discard Changes

This item enables you to discard any changes that you have made.

### Restore Defaults

This item enables you to restore the system defaults.

### Save as User Defaults

This item enables you to save the changes that you have made as user defaults.

### Restore User Defaults

This item enables you to restore the user defaults.

### Boot Override

Use this item to select the boot device.

## Updating the BIOS

You can download and install updated BIOS for this motherboard from the manufacturer's Website. New BIOS provides support for new peripherals, improvements in performance, or fixes for known bugs. Install new BIOS as follows:

- 1 If your motherboard has a BIOS protection jumper, change the setting to allow BIOS flashing.
- 2 If your motherboard has an item called Firmware Write Protect in Advanced BIOS features, disable it. (Firmware Write Protect prevents BIOS from being overwritten.)
- 3 Prepare a bootable device or create a bootable system disk. (Refer to Windows online help for information on creating a bootable system disk.)
- 4 Download the Flash Utility and new BIOS file from the manufacturer's Web site. Copy these files to the bootable device.
- 5 Turn off your computer and insert the bootable device in your computer. (You might need to run the Setup Utility and change the boot priority items on the Advanced BIOS Features Setup page, to force your computer to boot from the bootable device first.)
- 6 At the C:\ or A:\ prompt, type the Flash Utility program name and the file name of the new BIOS and then press <Enter>. Example: AFUDOS.EXE 040706.ROM
- 7 When the installation is complete, remove the bootable device from the computer and restart your computer. If your motherboard has a Flash BIOS jumper, reset the jumper to protect the newly installed BIOS from being overwritten. The computer will restart automatically.

*Memo*



## Chapter 5

### ***Feature Information***

---

#### **Introduction**

The NFC and wireless charger is optional feature on this computer. Please refer to following instructions.

#### **1. Wireless charger**

The Wireless charger specification that the computer support is compatible with Qi. Put the Rx device on charger area for power transfer.

#### **2. NFC**

The NFC module that compatible with (1) ISO 15693 (2) ISO 14443A (3) ISO 14443B. Put the device on the center of computer for read/write.



**MEMO**