

Installation and Operation Guide  
**Model 6340 Television Modulator**

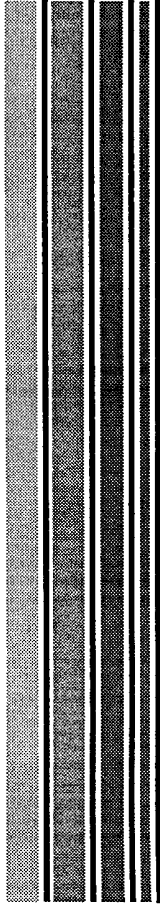

**Scientific-Atlanta, Inc.**  
Our customers are the winners.

United States: 4386 Park Drive, Box 105027, Atlanta, GA 30346; Telephone 404-903-5000, TWX 810-766-4912; Telex 0542898  
Europe: Home Park Estate, Kings Langley, Herts WD4 8LZ, England; Telephone 092-326-6133; Telex 912044  
Australia: Unit 2, 2 Aquatic Drive, Frenchs Forest, N.S.W. 2086, Australia; Telephone 011-612-452-3388; Telex (790)177418

Effective Date: May 1982  
Copyright Scientific-Atlanta, Inc. All rights reserved. Printed in USA.

Publication No. 69T259B  
S-A Part No. 379881

**Scientific  
Atlanta**

# IMPORTANT RULES FOR SAFE OPERATION

## Note to CATV System Installer

This reminder is provided to call the CATV system installer's attention to Article 820-40 of the NEC that provides guidelines for proper grounding and, in particular, specifies that the CATV cable ground shall be connected to the grounding system of the building, as close to the point of cable entry as practical.



**CAUTION**  
RISK OF ELECTRIC SHOCK  
DO NOT OPEN



**CAUTION:** To reduce the risk of electric shock, do not remove cover (or back). No user-serviceable parts inside. Refer servicing to qualified service personnel.

## WARNING

**TO PREVENT FIRE OR ELECTRIC SHOCK, DO NOT EXPOSE THIS UNIT TO RAIN OR MOISTURE.**

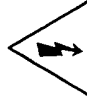

This symbol is intended to alert you that insulated voltage within the unit may have sufficient magnitude to cause electric shock. Therefore, it is dangerous to make any kind of contact with any inside part of the unit.



This symbol is intended to alert you to important operating, maintenance, servicing and safety instructions in the literature accompanying the equipment.

- Read Instructions** – All the safety and operating instructions should be read before this product is operated.
- Retain Instructions** – The safety and operating instructions should be retained for future reference.
- Heed Warnings** – All warnings on the product and in the operating instructions should be adhered to.
- Follow Instructions** – All operating and use instructions should be followed.
- Cleaning** – Unplug this product from the wall outlet before cleaning. Do not use liquid cleaners or aerosol cleaners. Use a damp cloth for cleaning.
- Attachments** – Do not use attachments not recommended by Scientific-Atlanta as they may cause hazards.
- Water and Moisture** – Do not use this product near water – for example, near a bathtub, wash bowl, kitchen sink, or laundry tub, in a wet basement, or near a swimming pool, and the like.
- Accessories** – Do not place this product on an unstable cart, stand, bracket, or table. The product may fall, causing serious injury to a child or adult, and
- Ventilation** – Openings in the cabinet are provided for ventilation and to ensure reliable operation of the product and to protect it from overheating, and these openings must not be blocked or covered. The openings should never be blocked by placing the product on a bed, sofa, rug, or other similar surface. This product should never be placed near or over a radiator or heat register. This product should not be placed in a built-in installation such as a bookcase or rack unless proper ventilation is provided or the instructions have been adhered to.
- 8A. An appliance and cart combination should be moved with care.** Quick stops, excessive force, and uneven surfaces may cause the appliance and cart combination to overturn.



serious damage to the product. Use only with a cart, stand, bracket, or table recommended by Scientific-Atlanta. Any mounting of the product should follow the instructions, and should use a mounting accessory recommended by Scientific-Atlanta.

## IMPORTANT RULES FOR SAFE OPERATION

10. **Power Sources** - This product should be operated only from the type of power source indicated on the marking label. If you are not sure of the type of power supply to your home or business, consult your appliance dealer or local power company. For products intended to operate from battery power, or other sources, refer to the operating instructions.
11. **Grounding and Polarization** - This product is equipped with a 3-wire grounding-type plug, a plug having a third (grounding) pin. This plug will only fit into a grounding-type power outlet. This is a safety feature. If you are unable to insert the plug into the outlet, contact your electrician to replace your obsolete outlet. Do not defeat the safety purpose of the grounding-type plug.
12. **Power-Cord Protection** - Power-Supply cords should be routed so that they are not likely to be walked on or pinched by items placed upon or against them, paying particular attention to cords at plugs, convenience receptacles, and the point where they exit from the appliance.
13. **Lightning** - For added protection for this product during a lightning storm or when it is left unattended and unused for long periods of time, unplug it from the wall outlet and disconnect the antenna or cable system. This will prevent damage to the product due to lightning and power-line surges.
14. **Power Lines** - An outside antenna system should not be located in the vicinity of overhead power lines or other electric light or power circuits, or where it can fall into such power lines or circuits. When installing an outside antenna system, extreme care should be taken to keep from touching such power lines or circuits as contact with them might be fatal.
15. **Overloading** - Do not overload wall outlets and extension cords as this can result in a risk of fire or electric shock.
16. **Object and Liquid Entry** - Never push objects of any kind into this product through openings as they may touch dangerous voltage points or short-out parts that could result in a fire or electric shock. Never spill liquid of any kind on the product.
17. **Servicing** - Do not attempt to service this product yourself as opening or removing covers may expose you to dangerous voltage or other hazards. Refer all servicing to qualified service personnel.
18. **Damage Requiring Service** - Unplug this product from the wall outlet and refer servicing to qualified service personnel under the following conditions:
  - a. When the power-supply cord or plug is damaged.
  - b. If liquid has been spilled, or objects have fallen into the product.
  - c. If the product has been exposed to rain or water.
  - d. If the product does not operate normally by following the operating instructions. Adjust only those controls that are covered by the operating instructions as an improper adjustment of other controls may result in damage and will often require extensive work by a qualified technician to restore the product to its normal operation.
  - e. If the product has been dropped or the cabinet has been damaged.
  - f. When the product exhibits a distinct change in performance - this indicates a need for service.
19. **Replacement Parts** - When replacement parts are required, be sure the service technician has used replacement parts specified by Scientific-Atlanta or have the same characteristics as the original part. Unauthorized substitutions may result in fire, electric shock or other hazards.

69T259B

v

## IMPORTANT RULES FOR SAFE OPERATION

20. **Safety Check** - Upon completion of any service or repairs to this product, ask the service technician to perform safety checks to determine that the product is in safe operating condition.
21. **Outdoor Antenna Grounding** - If an outside antenna or cable system is connected to the product, be sure the antenna or cable system is grounded so as to provide some protection against voltage surges and built-up static charges. Section 810 of the National Electrical Code, ANSI/NFPA No. 70-1990, provides information with respect to proper grounding of the mast and supporting structure, grounding of the lead-in wire to an antenna discharge unit, size of grounding conductors, location of antenna-discharge unit, connection to grounding electrodes, and requirements for the grounding electrode. See figure below.

### EXAMPLE OF ANTENNA GROUNDING

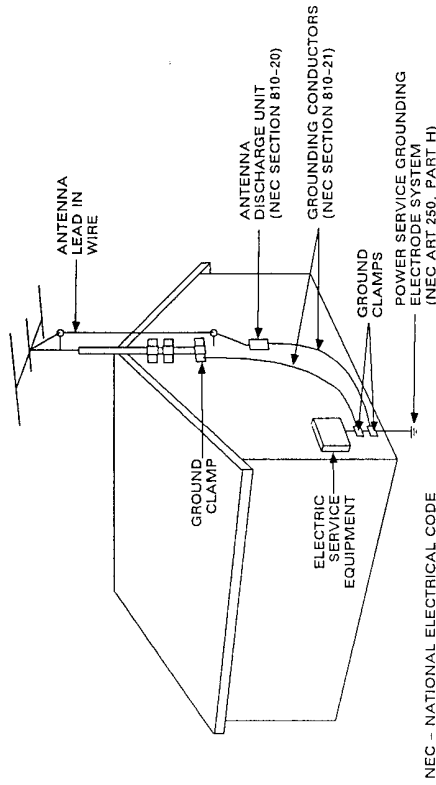

This product is to be mounted within a distance of less than 3 feet of a standard 120 V ac outlet to accommodate the 3-foot power cord furnished.

69T259B

v

## FCC COMPLIANCE

This equipment has been tested and found to comply with the applicable limits for a Class A digital device, pursuant to Part 15 of FCC Rules. These limits are designed to provide reasonable protection against harmful interference when the equipment is operated in a commercial environment. This equipment generates, uses and can radiate radio frequency energy and, if not installed and used in accordance with the instruction manual, may cause harmful interference to radio communications. Operation of this equipment in a residential area is likely to cause harmful interference in which case the user will be required to correct the interference at his own expense.

### CAUTION

Any changes or modification to this equipment not expressly approved by Scientific-Atlanta could void the user's authority to operate this equipment.

## WARRANTY

All items that we manufacture are warranted to be free from defects in material and workmanship and to conform to our currently published specifications. The warranty period is one year from the date of shipment. Written notice of defects must be received by us within the warranty period. Our liability is limited to servicing or adjusting any item returned to the factory for that purpose, including replacing any defective parts therein. Customer must pay packing, crating, and transportation costs to and from the factory. At customer's request, we will make reasonable efforts to provide warranty service at the customer's premises, provided the customer pays our then current rates for field services and the associated travel and living expenses. If a fault has been caused by improper installation, maintenance or use, or by abnormal conditions of operation, repairs will be billed at normal rates.

If any fault develops, the following steps should be taken:

- A. Notify us by giving the item model number, serial number and details of the difficulty. On receipt of this information, you will be given service data or shipping instructions.
- B. On receipt of shipping instructions, forward the item prepaid. If the item or the fault is not covered by warranty, an estimate of charges will be furnished before work begins.

WE DISCLAIM STATUTORY AND IMPLIED WARRANTIES, SUCH AS WARRANTIES OF MERCHANTABILITY AND FITNESS FOR PURPOSE.

IN NO EVENT SHALL SCIENTIFIC-ATLANTA BE LIABLE, IN CONTRACT OR IN TORT OR UNDER ANY OTHER LEGAL THEORY, FOR INCIDENTAL, INDIRECT, SPECIAL OR CONSEQUENTIAL DAMAGES, REGARDLESS OF WHETHER WE WERE INFORMED ABOUT THE POSSIBILITY OF SUCH DAMAGES, AND IN NO EVENT SHALL SCIENTIFIC-ATLANTA'S LIABILITY EXCEED AN AMOUNT EQUAL TO THE SALES PRICE.

## CONTENTS

### CHAPTER 1 – GENERAL DESCRIPTION

Overview .....	1-1
Introduction .....	1-1
Physical Description .....	1-1
Functional Description .....	1-1
Features .....	1-2
Options .....	1-2
Dual IF Loop (Type A or B) Option Package .....	1-3
Spectrum Inversion .....	1-3
Technical Specifications .....	1-4

### CHAPTER 2 – INSTALLATION

Unpacking and Inspecting the Modulator .....	2-1
General .....	2-1
What To Do About Visible Loss or Damage .....	2-1
What To Do About Concealed Damage .....	2-1
How To Inventory the Equipment Received .....	2-1
Equipment Return Information .....	2-2
Installation Prerequisites .....	2-3
Space and Physical Arrangement .....	2-3
Power Requirements .....	2-3
Fuse Requirements .....	2-3
Cooling Requirements .....	2-3
Cabling .....	2-4
Stereo Applications .....	2-4
Mono Mode .....	2-4
Stereo Mode .....	2-4
Installing the Modulator .....	2-5
Equipment Mounting .....	2-5
Connecting Cables .....	2-6
DIFL Option: .....	2-7
IF Switch Feature .....	2-7
4.5 MHz Feature .....	2-7

### CHAPTER 3 – OPERATION

Equipment Description .....	3-1
Controls and Indicators .....	3-1
Operating the Modulator .....	3-4
Turn-on Procedure .....	3-4

## CONTENTS

User Adjustments .....	3-4
Output RF Level Adjustment .....	3-4
Output Audio Carrier Level Adjustment .....	3-4
Audio Deviation Adjustment (Monaural) .....	3-4
Audio Deviation Adjustment (Stereo) .....	3-5
Video Modulation Adjustment .....	3-5
Circuit Description .....	3-6
Modulator/IF Board .....	3-7
Output Converter Board .....	3-7
Power Supply .....	3-7

## CHAPTER 4 – MAINTENANCE AND SERVICE

Maintenance .....	4-1
Visual Inspection .....	4-1
Cleaning .....	4-1
Service .....	4-2
Troubleshooting Procedures .....	4-3

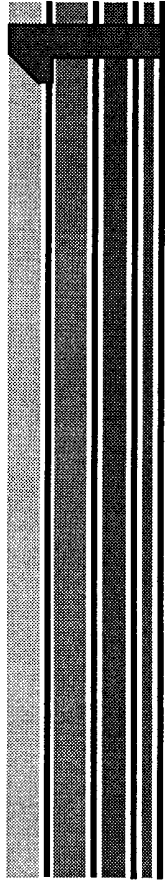

## General Description

- OVERVIEW
- FEATURES
- OPTIONS
- TECHNICAL SPECIFICATIONS

## OVERVIEW

### INTRODUCTION

The Model 6340 Television Modulator (also called the modulator in this manual) converts a baseband television signal to the desired channel frequency for distribution on a CATV system. The video source is first modulated to an IF (intermediate frequency) of 45.75 MHz where it is combined with an audio signal IF of 41.25 MHz. The audio IF originates from either a baseband audio source or the 4.5 MHz audio carrier input. This composite signal is then converted to the desired output frequency. The result is a high quality vestigial sideband television signal on any cable television channel from 54 to 450 MHz.

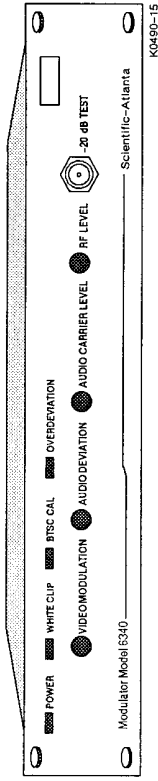

Figure 1-1. Model 6340 Television Modulator

### PHYSICAL DESCRIPTION

The Model 6340 Television Modulator is 1.75 inches high, has an overall width of 19 inches, and fits the EIA standard 24-inch rack. The modulator weighs 11 pounds. All input and output connectors are located on the rear panel, along with the power cord and fuse. Chapter 2 describes the rear panel connectors. All operating controls and LED indicators on the front panel are described in Chapter 3.

### FUNCTIONAL DESCRIPTION

The Model 6340 Television Modulator provides you with sophisticated versatile features. Advanced circuitry gives the highest picture and sound fidelity. Audio input may be provided at baseband or as a 4.5 MHz carrier. The audio source may be monaural or a BTSC (Broadcast Television Standards Committee) stereo signal. Dual IF loops are available for scrambling the television signal. An Alternate IF input switch provides for selection of an external IF source. A white-level clip circuit protects against over-modulation of the visual carrier. A surface acoustic wave (SAW) filter is used to achieve high quality amplitude and group delay characteristics in the vestigial sideband signal. Front panel controls, indicators and the test point provide access to important operating parameters.

## GENERAL DESCRIPTION

### FEATURES

The Model 6340 Television Modulator combines excellent performance and cost effectiveness for all broadband television transmission applications. Some of the features that enhance the operation and flexibility of headend operations are listed below.

- High quality RF output for adjacent channel applications
- Compact stand-alone unit or may be rack mounted
- SAW vestigial filtering
- Composite IF loop-through
- Alternate IF input switching
- FCC pre-distortion group delay
- Output channels available from 54 MHz to 450 MHz
- Output level: +50 to +60 dBmV
- Front panel monitor/test point
- Front panel output level control
- Video, audio and power LED indicators
- Video percent-of-modulation, audio deviation and carrier level adjust
- 4.5 MHz Sound carrier input capability
- BTSC (Broadcast Television Standards Committee) Stereo compatible with a front panel calibration light
- FCC offsets and stability as required on affected FCC/FAA channels

### OPTIONS

The option choices for the Model 6340 Television Modulator are as follows:

- DIFL (Type A or B)
- Spectrum Inversion

## GENERAL DESCRIPTION

An explanation of each option follows:

### Dual IF Loop (Type A or B) Option Package

Two options, Type A or Type B, separate audio and video IF signals before or after the vestigial sideband filter. The DIFL-A option loops video IF out before the vestigial (SAW) filter and the DIFL-B option loops video out of the chassis after the filter. Use Type A with sync-pulse suppression systems and Type B with sine-wave suppressed scrambler systems.

### Spectrum Inversion

The spectrum inversion option reverses the video and audio carriers, putting the video carrier 4.5 MHz above the audio at RF. Use of this option with set-top converters may also require frequency off-set. Consult with the converter manufacturer and Scientific-Atlanta for the correct crystal frequency.



## TECHNICAL SPECIFICATIONS

### TECHNICAL SPECIFICATIONS

Table 1-1. Model 6340 Television Modulator Technical Characteristics - continued

Characteristic	Specification
Harmonic distortion	<0.5% (30 Hz to 105 kHz at 25 kHz deviation) <0.5% (15 kHz to 50 kHz at 50 kHz deviation)
FM hum and noise (mono)	70 dB down with respect to 25 kHz deviation
(stereo 80 kHz bandwidth)	60 dB down with respect to 25 kHz deviation
Overdeviation LED (mono mode)	>25.2 kHz peak dev ( $\pm 0.2$ dB)
Cal LED (stereo mode)	25 kHz peak dev ( $\pm 0.2$ dB, $\pm 0.07$ dB window)
<b>4.5 MHz FM Input</b>	
Input level	28 to 45 dBmV
Input impedance	75 ohms, unbalanced (output return loss 16 dB minimum)
Output frequency	RF Any standard channel; VHF; mid-band; superband; hyperband through 450 MHz. Transposed video-sound channels available from spectrum inversion option.
Output impedance	75 ohms unbalanced, (output return loss 16 dB minimum)
Output level	+50 dBmV to +60 dBmV continuously variable
Spurious outputs	>60 dB below video carrier with video carrier at +60 dBmV and sound carrier at +45 dBmV

Table 1-1 lists the technical specifications of the Model 6340 Television Modulator.

Table 1-1. Model 6340 Television Modulator Technical Characteristics

Characteristic	Specification (0°C to 50°C)
<b>Video</b>	
Input type	Baseband video, sync negative
Input level of	0.5 to 2.0 V p-p min for 87.5% depth modulation
Input impedance	75 ohms, unbalanced (return loss 28 dB minimum)
Frequency response	$\pm 1.0$ dB from 30 Hz to 4.2 MHz
Differential gain	$\leq 3\%$ at 87.5% modulation
Differential phase	$\leq 2^\circ$ at 87.5% modulation
Signal-to-noise	>65 dB
S/N (0 kHz to 10 kHz)	>68 dB (CCIR weighted)
S/N (60 kHz to 4.2 MHz)	2% max on 60 Hz, 50% square wave
Tilt	
<b>Audio</b>	
Input level	-10 to +10 dBm for 25 kHz deviation
Input impedance	600 ohms, balanced (field modifiable for Hi-Z bridging input)
Pre-emphasis (mono)	75 microseconds, internally defeatable
Common mode hum rejection	> 40 dB
Frequency response (mono)	$\pm 0.5$ dB from 30 Hz to 15 kHz
(stereo)	$\pm 0.5$ dB from 30 Hz to 105 kHz
	$\pm 0.1$ dB from 50 Hz to 50 kHz

## TECHNICAL SPECIFICATIONS

Table 1-1. Model 6340 Television Modulator Technical Characteristics - continued

Characteristic	Specification
Frequency stability FCC channels Non-FCC channels	± 5 kHz ± 10 kHz to 228 MHz (except FCC channels) ± 20 kHz, 400 MHz to 450 MHz
Group delay response	Meets FCC predistortion requirements for color transmission
Vestigial sideband response	-20 dB at channel edge; -40 dB at adjacent picture and sound carrier frequencies and all frequencies farther removed from channel
<b>GENERAL</b>	
Input voltage	105 to 125 V ac, 60 Hz
Input power	24 W, typical at 115 V ac (below 300 MHz) 27 W, typical at 115 V ac (above 300 MHz) 32 W, max
Operating temperature	0°C to +50°C range (+32°F to +120°F)
<b>IF SPECIFICATIONS</b>	
Output impedance	75 ohms, unbalanced (return loss > 16 dB)
IF frequency, video	45.75 MHz
IF frequency, audio	41.25 MHz
Intercarrier frequency	4.5 MHz ± 50 Hz
Alternate IF input impedance	75 ohms, unbalanced (return loss > 16 dB)
Alternate IF input level	35 dBmV

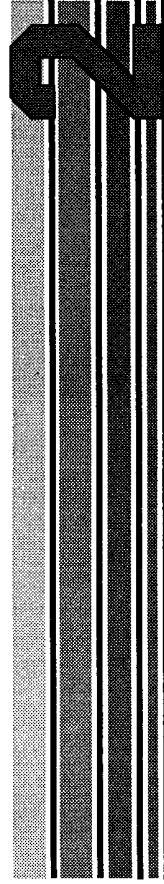

## Installation

- UNPACKING AND INSPECTING THE MODULATOR
- EQUIPMENT RETURN INFORMATION
- INSTALLATION PREREQUISITES
- INSTALLING THE MODULATOR
- INSTALLATION TESTING

---

## UNPACKING AND INSPECTING THE MODULATOR

### GENERAL

Scientific-Atlanta thoroughly inspects and carefully packs all equipment before shipment. However, at the time of shipment, the carrier assumes responsibility for its safe delivery. Therefore, do not return damaged units to Scientific-Atlanta. Instead, file a claim with the carrier as noted in this chapter. The initial unpacking procedures are given below.

1. Inspect the shipping carton for visible damage.
2. Open the shipping carton.
3. Remove all packing material.
4. Inspect the unit for visible damage.
5. Gently shake the unit, checking for loose items that may indicate concealed damage.
6. Check for missing items.

### WHAT TO DO ABOUT VISIBLE LOSS OR DAMAGE

Make note of any loss or evidence of external damage on the freight bill or receipt, and have it signed by the carrier's agent. Failure to adequately describe such external evidence of loss or damage may result in the carrier refusing to honor a damage claim. The form required to file such a claim will be supplied by the carrier.

### WHAT TO DO ABOUT CONCEALED DAMAGE

Concealed damage means damage which does not become apparent until the unit has been unpacked. The contents may be damaged in transit due to rough handling, even though the carton may not show external damage. If you discover damage after unpacking the unit, make a written request for inspection by the carrier's agent within 15 days of the delivery date. File a claim with the carrier since such damage is the carrier's responsibility. If you follow these instructions carefully, Scientific-Atlanta guarantees its full support of your claims to protect you against loss from concealed damage.

### HOW TO INVENTORY THE EQUIPMENT RECEIVED

Now that you have inspected the shipment for damage, you need to verify that all items ordered have been received. This is especially important if your order was for more than one piece of equipment or was to include any options on the equipment. Check off each item received against that list on the packing slip included with the shipment, and verify that the list matches your purchase order. If any items are missing, please notify Scientific-Atlanta right away by calling 1-800-722-2009. When you hear the recording, follow the instructions to reach the Sales Department.

## UNPACKING AND INSPECTING THE MODULATOR

### EQUIPMENT RETURN INFORMATION

Scientific-Atlanta tries to ensure that all items arrive safely and in working order. Occasionally, despite these efforts, equipment will be received which is not in working condition. When this occurs, and it is necessary to return the equipment for repair or replacement, follow the procedure given below.

1. Call Scientific-Atlanta's Customer Service Department and request a Return Material Authorization (RMA) number. The toll-free telephone number is 1-800-722-2009. When you hear the recording, follow the instructions for customer service.
2. Tag or identify the defective equipment, noting the defect or circumstances. Be sure to write the RMA number on the tag. Reference the sales order number and purchase order number, as well as the date the equipment was received.
3. Pack the equipment in its original container and protective packing material if possible. If the original container and packing material are no longer available, pack the equipment in a sturdy corrugated box and cushion it with appropriate packing material.
4. Be sure to include the following information when returning the equipment.

Name  
Address  
City, State and Zip Code  
Telephone Number  
RMA Number  
Sales Order Number  
Purchase Order Number  
Date equipment was received  
Problem Description

### NOTE

Scientific-Atlanta will not accept freight collect. Be sure to ship all items freight prepaid.

## INSTALLATION PREREQUISITES

### SPACE AND PHYSICAL ARRANGEMENT

The Model 6340 Television Modulator measures 1.75 inches height by 19 inches wide by 12.5 inches deep (see the outline drawing shown in figure 1-1). It can be rack mounted or simply set on a shelf or table. When mounting the modulator on a shelf or table, ensure that the unit is safe from falling caused by tangled or strained interconnecting cables.

### POWER REQUIREMENTS

#### WARNING

For reliable operation as well as safety, the Model 6340 Television Modulator requires a good earth ground connection for the third prong on its electrical power plug.

The Model 6340 Television Modulator requires a standard duplex power receptacle capable of supplying 105-125 V ac, 60 Hz at 32 watts.

#### CAUTION

Damage to Model 6340 Television Modulator will occur if you connect its power cord to a 230 V ac source. Be sure that your line voltage is correct.

### FUSE REQUIREMENTS

The fuse holder on the rear panel contains the ac power fuse and should be a 1/2 ampere slow-blow fuse. The fuse is accessed by pressing down on the top of the rectangular housing to release the holder. Pull back on the fuse holder to expose the fuse.

### COOLING REQUIREMENTS

The Model 6340 Modulator should be installed in an environmentally controlled location. Although the equipment has been tested over a temperature range of +20°F to +120°F, it is recommended ambient temperature be maintained at +75°F (±5°F).

#### CAUTION

Prolonged operation of this equipment above the maximum specified operating temperature (120°F) can void the warranty.

## INSTALLATION PREREQUISITES

When rack mounting the unit, 3.5 inches of air space should be allowed above and below the unit. If the equipment must be installed using 1.75 inches of spacing, it is recommended that forced-air ventilation be used. When installing the air moving device, care should be taken to ensure air between the units is sufficiently moved. The blower or fan should be installed in a manner that assists the rising warmer air, rather than opposing it.

The fans or blowers chosen to ventilate the cabinet should provide air movement of 200 cubic feet per minute per kilowatt of power dissipated.

### CAUTION

**Under no circumstance install the unit with less than 1.75 inches of air space above and below. High internal temperature can result in reduced product life.**

## CABLING

You will need to supply coaxial cables for the modulator's VIDEO INPUT, RF OUTPUT, and any additional cables for use with the optional loop connections when those options have been included with your order. In addition, an audio input cable is required; this is generally a shielded twisted-pair of standard audio type cable.

## STEREO APPLICATIONS

### Mono Mode

The Model 6340 Modulator is delivered in a monaural audio mode. The pre-emphasis jumper (labeled J3 on the internal board) is accessible through the top cover and is set in the normal position (toward the front) which uses the pre-emphasis circuit. This is the Monaural (M) position. It also activates the overdeviation LED circuit for mono signals.

### Stereo Mode

BTSC stereo sources for the modulator may be baseband or a 4.5 MHz carrier. If a baseband stereo signal is connected, the pre-emphasis jumper (labeled J3 on the internal board) must be positioned to the BTSC stereo position (toward the rear). This is the Stereo (S) Position. This removes the pre-emphasis and activates the BTSC calibration LED circuit, while switching off the mono overdeviation LED circuit.

A 4.5 MHz stereo carrier will operate correctly with the pre-emphasis jumper plug in either position.

## INSTALLING THE MODULATOR

If you are installing the Model 6340 Modulator on a shelf or in a closet, no specific mounting instructions are necessary. Simply follow the suggested installation prerequisites previously given. When installing the modulator in a rack, follow the instructions given below. Cable connecting information is also included for typical applications of the product.

## EQUIPMENT MOUNTING

The Model 6340 Modulator can be mounted by one of two methods.

1. Mounting by the front bezel.

The unit has been designed to be self-supporting when secured using all bezel mounting holes. It is recommended that the angle support bracket (part number 345763) be used with this method to support the equipment and aid in installation.

2. Mounting using rack slides.

The unit can be mounted using the Universal Rack Slide Kit (part number 275317). This method allows the unit to be extended from the equipment cabinet, for maintenance or adjustment, without removing it. The unit is held in the cabinet by the bezel mounting holes. Refer to the **Universal Rack Slide Kit Installation Manual** for installation instructions.

Position the modulator in the rack and insert a 10-24 X 1/2 inch screw through the modulator mount and the rack at each of four locations (two on each side of the modulator as shown in figure 2-1). Tighten the screws firmly at each location.

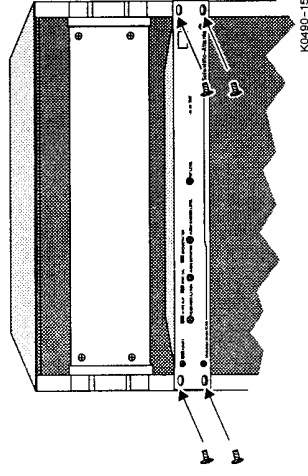

Figure 2-1. Equipment Mounting

## INSTALLING THE MODULATOR

### CONNECTING CABLES

All connections are made on the rear panel of the modulator. The following cable types are recommended:

- 75-ohm double shielded coaxial cable with F-type connectors for VIDEO, IF and RF signals
  - 2-conductor shielded twisted pair cable for AUDIO to the terminal barrier strip
- Extreme care should be taken to ensure that mating F-type connectors are compatible with the female F-type connectors on the modulator chassis. Male connector center conductors or center pin diameters should range between .022 to .047 inches. Conductors or center pins below or above this range should not be used as this condition may result in connectors with insufficient contact normal force to provide a reliable connection.

#### NOTE

The female F-type connectors are designed to accept a conductor or center pin of .022 to .047 inches in diameter. Once a center conductor with a diameter in the upper part of the acceptable range has been inserted into the female connector, it is inadvisable to return to a smaller conductor size.

The Model 6340 Modulator is connected to a baseband audio and video source, such as a TVRO receiver. The following illustration, showing the connections between the Model 6340 modulator and a satellite video receiver, provides an example of baseband video and audio connections.

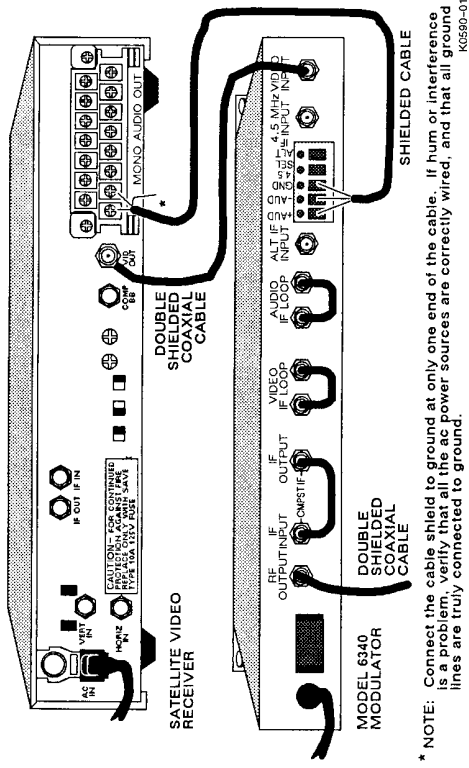

Figure 2-2. Equipment Connection  
Refer to Table 2-1 for connector functions and specifications.

## INSTALLING THE MODULATOR

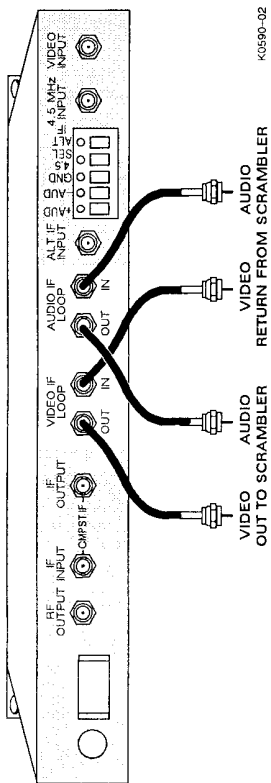

Figure 2-3. DIFL Option Connections

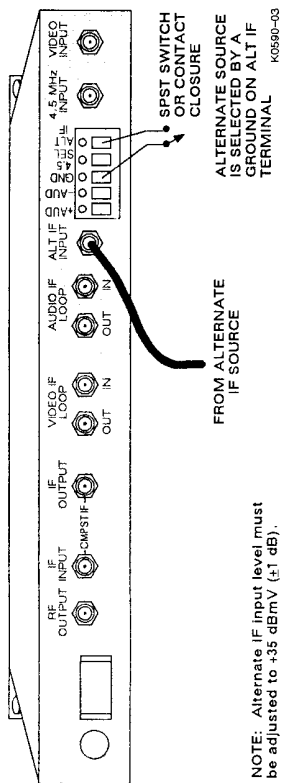

Figure 2-4. Alternate IF Switch Connections

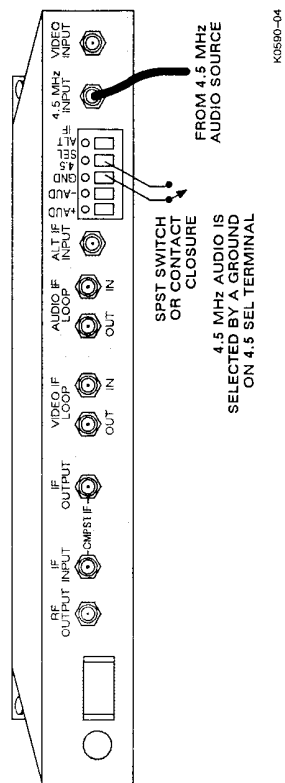

Figure 2-5. 4.5 MHz Audio Connections

## INSTALLING THE MODULATOR

1. Connect a 75 ohm double shielded coaxial cable with an F-type connector from the video source to the modulator's VIDEO INPUT.
2. Connect a shielded twisted pair cable from the audio source to the modulator's AUDIO IN terminal block. Connections should be made carefully according to the indications (+, GND, -) as labeled by each terminal. See figure 2-2.
3. Connect a 75 ohm double shielded coaxial cable with an F-type connector from the RF OUTPUT to the headend combiner.
4. Attach a 75 ohm double-shielded coaxial cable jumper from COMPOSITE OUTPUT to COMPOSITE INPUT to complete the IF signal path.
5. Plug the modulator power cord into a power outlet. The power indicator (green light) on the front panel should come on. If it does not, check the wiring to verify that 115 V ac is applied to the modulator. If power is present and the light does not come on, unplug the power cord and check fuse in rear panel fuse holder. If the 1/2 amp fuse has failed, refer servicing to a qualified technician.

Any additional connections that may be needed for the modulator are discussed below.

### DIFL Option

If your modulator has the DIFL option, and you desire to scramble the video and/or audio signal, remove the appropriate IF loop cable and connect input and output coaxial cables from your scrambler. See figure 2-3.

If the DIFL option is present but not being used, complete the IF audio and video signal paths by attaching coax jumpers.

### Alternate IF Switch Feature

If you want to inject a composite IF signal from an external source, attach the alternate IF source to the ALT IF INPUT. This signal is selected by connecting ground to the ALT IF select terminal on the rear panel. See figure 2-4.

### 4.5 MHz Feature

If you want to inject the audio signal as a 4.5 MHz audio subcarrier instead of baseband audio, connect a 75 ohm double shielded coaxial cable with an F-type connector from the 4.5 MHz source to the 4.5 MHz INPUT connector. This option is selected by attaching a ground to the 4.5 SEL terminal on the back of the chassis. See figure 2-5.

## INSTALLING THE MODULATOR

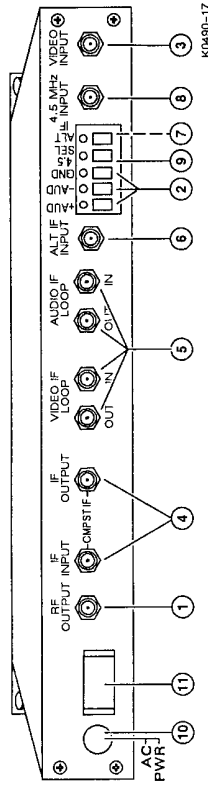

Figure 2-6. Model 6340 Television Modulator - Rear View Connectors

Table 2-1. Model 6340 Modulator Connectors

Reference Number	Item	Function
1	RF OUTPUT connector	Female F-type connector for final RF signal at channel frequency.
2	AUDIO INPUT/GND terminals	Screw terminals for baseband audio input (600 ohm balanced input).
3	VIDEO INPUT connector	Female F-type connector for baseband video input.
4	COMPST IF INPUT/OUTPUT loop connectors	Female F-type connectors serve to loop the composite IF signal from the IF modulator to the output converter. An external composite IF signal can be fed directly to the output converter via the IF INPUT connector.
5	VIDEO IF LOOP OUT/IN connectors (DIFL option only)	Female F-type connectors serve to loop the video IF signal within the IF modulator. Allows connection to and from the scrambler.
5	AUDIO IF LOOP OUT/IN connectors (DIFL option only)	Female F-type connectors serve to loop the audio IF signal within the IF modulator. Allows connection to and from the scrambler.
6	ALTERNATE IF INPUT	Female F-type connector that allows an alternate composite IF signal to be supplied to a solid-state switch located in the modulator. The alternate IF input is manually selected when the IF SELECT terminal on the rear-panel terminal block is grounded. Alternate IF input level must be adjusted to +35 dBmV ( $\pm 1$ dB) to set RF output level.

## INSTALLING THE MODULATOR

Table 2-1. Model 6340 Modulator Connectors - continued

Reference Number	Item	Function
7	ALT IF terminal	Screw terminal that selects an alternate IF signal source when grounded.
8	4.5 MHz INPUT connector	Female F-type connector for input of 4.5 MHz audio subcarrier. This input is controlled by the 4.5 MHz SEL terminal.
9	4.5 MHz SEL terminal	Puts the audio modulator in a mode to accept sound on the 4.5 MHz subcarrier input when the terminal is grounded.
10	Power cord	Input line for ac power. Equipped with 3-prong, grounded plug.
11	FUSE holder	Contains ac line fuse (1/2 A, slow blow) for protection of the modulator against overloads.

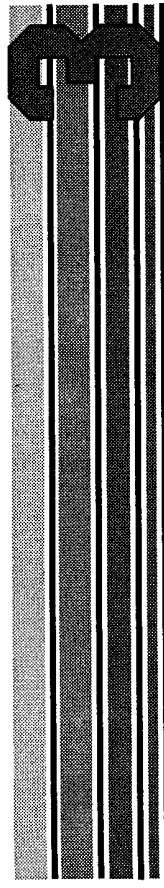

## Operation

- EQUIPMENT DESCRIPTION
- OPERATING THE MODULATOR
- CIRCUIT DESCRIPTION



## EQUIPMENT DESCRIPTION

### CONTROLS AND INDICATORS

All operational controls and indicators are located on the front panel of the modulator. Refer to the following illustration for their location. Operation of the modulator follows this descriptive section.

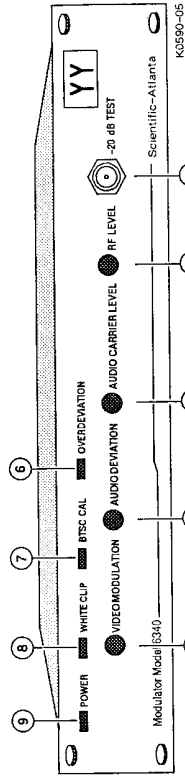



Figure 3-1. Model 6340 TV Modulator Front Panel



The following table describes the controls and indicators on the front panel of the modulator.

Table 3-1. Front Panel Controls and Indicators

Reference Number	Item	Function
1	-20 dB TEST 	The -20 dB TEST POINT provides front panel monitoring of the RF output level. This TEST POINT provides a -20 dB access when the RF output is properly terminated with a 75 ohm impedance.
2	RF LEVEL 	The RF LEVEL control increases and decreases the RF output level. Turn the control clockwise to increase the output. The maximum output level is +60 dBmV, and the minimum is less than +50 dBmV. The RF LEVEL control adjusts the video and audio RF levels simultaneously.





**EQUIPMENT DESCRIPTION**

Table 3-1. Front Panel Controls and Indicators - continued

Reference Number	Item	Function
8	WHITE CLIP 	The red WHITE CLIP light above the VIDEO MODULATION control indicates over-modulation and white level clipping. If this light comes on, turn the control counterclockwise until the light goes out.
9	POWER 	The POWER indicator (green light) is lit whenever power is present.

**EQUIPMENT DESCRIPTION**

Table 3-1. Front Panel Controls and Indicators - continued

Reference Number	Item	Function
3	AUDIO CARRIER LEVEL 	The AUDIO CARRIER LEVEL control increases and decreases the audio carrier level. Turn the control clockwise to increase the audio carrier in relation to the video carrier.
4	AUDIO DEVIATION 	The AUDIO DEVIATION control increases and decreases the frequency deviation of the audio carrier. Turn the control clockwise to increase the deviation.
5	VIDEO MODULATION 	The VIDEO MODULATION control increases and decreases the video depth of modulation. Turn the control clockwise to increase the modulation depth.
6	OVERDEVIATION 	This indicator is active only when the modulator stereo/mono jumper is in the mono mode. The red OVERDEVIATION LED above the AUDIO DEVIATION control indicates over-deviation. If this light comes on, turn the control counterclockwise until the light just goes out. It is normal for the light to blink on and off occasionally.
7	BTSC CAL 	This indicator is active only when the modulator stereo/mono jumper is in the stereo (BTSC) mode. Operation assumes a stereo encoder capable of generating a calibration tone. The tone amplitude should provide 25 kHz deviation. (The Scientific-Atlanta Model 6380A Stereo Encoder and Model 6250 Demodulator with Pulse Count Audio Output Module have this capability.) With the calibration tone switched on in the stereo encoder, adjust the audio deviation until the BTSC CAL LED illuminates. Be sure to turn the calibration tone OFF in the encoder.

## OPERATING THE MODULATOR

### TURN-ON PROCEDURE

To turn on the Model 6340 Modulator, plug the power cord into a standard power receptacle. The front panel POWER LED should come on. Perform any of the necessary adjustments as described below.

### USER ADJUSTMENTS

The Model 6340 Television Modulator has four user adjustments that may require altering during the course of normal use. These adjustments are:

- Video modulation
- Audio deviation
- Audio carrier level
- RF level

Refer to table 3-1 for the location of each control. The following paragraphs describe how to perform each adjustment.

#### Output RF Level Adjustment

The final output RF signal level from the Model 6340 Modulator is adjustable from +50 dBmV to +60 dBmV as measured at the rear-panel RF OUTPUT connector. The output signal level needed is based on your particular television network requirements. Adjustment is made with the front panel RF LEVEL control. Adjust as necessary.

#### Output Audio Level Adjustment

The output level of the audio carrier is factory set to be 15 dB below the output video carrier level. If you need a different audio carrier level, adjust this control as necessary.

#### Audio Deviation Adjustment (Monaural)

Adjust this control until the front panel AUDIO OVERDEVIATION LED just lights, then back off slightly until the LED just goes out.

#### Audio Deviation Adjustment (Stereo)

In systems with the audio input encoded in the BTSC stereo format, the audio pre-emphasis jumper network in the modulator must be switched out. This should only be changed by qualified service personnel.

To set the audio deviation, apply a tone at a level that is equivalent to 25 kHz deviation. When using a Model 6380A Stereo Encoder, turn on the CAL TONE. Adjust the audio deviation control until the BTSC CAL LED comes on. Turn off CAL TONE on the Stereo Encoder.

#### Video Modulation Adjustment

With a baseband video input signal level of 1 volt, peak-to-peak, the percent of modulation is factory set to 87.5 percent. If the input baseband video signal is at some other level, you will need to readjust the VIDEO MODULATION control until the front panel WHITE CLIP LED just lights, then back off until the LED goes out. This will result in approximately 87.5 percent modulation for your input baseband video signal, and indicates white clipping if approximately 94 percent modulation occurs.

#### NOTE

Once power is applied and any adjustments have been performed, no further attention is required to operate the modulator. However, should a problem develop and you suspect a malfunction with the modulator, refer to chapter 4 to aid you in isolating the problem area.

CIRCUIT DESCRIPTION

This section contains a description of the circuitry of the Model 6340 Television Modulator.

NOTE

This section is included as reference material only. Servicing of the modulator should be performed only by a qualified service technicians only.

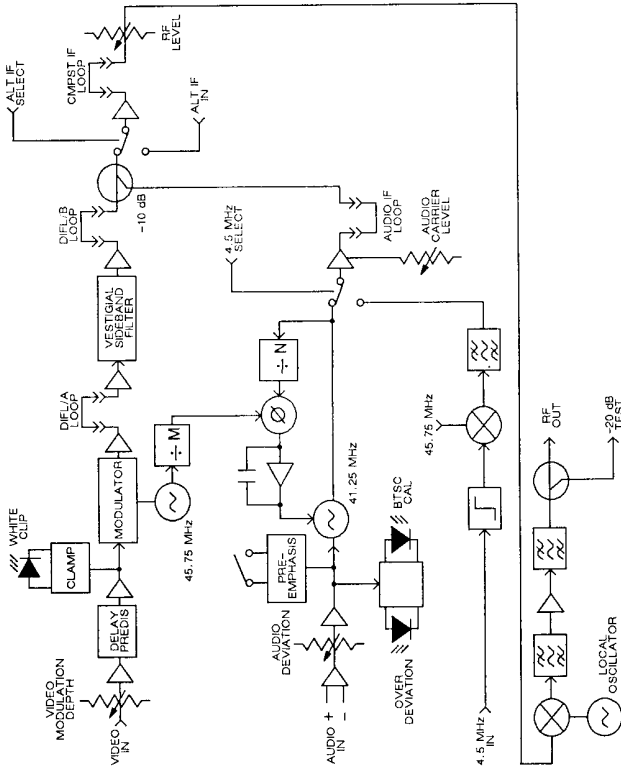

Figure 3-2. Model 6340 Television Modulator Block Diagram

The Model 6340 Modulator accepts audio and video as inputs. The modulator also accepts a 4.5 MHz audio subcarrier and an alternate IF input. The output is a composite RF TV signal on any EIA channel.

MODULATOR/IF BOARD

The video input passes through an FCC delay predistortion network and several buffer circuits. A white clip circuit limits the video modulation to 93.75% and illuminates the front panel White Clip LED when clipping occurs. The video is then applied to an AM modulator circuit. A 45.75 MHz oscillator provides the modulator circuit with the video carrier signal. The video carrier is amplified and vestigial sideband filtered by a SAW filter. The video carrier is combined with the audio carrier by a directional coupler.

Audio inputs are processed and applied to the FM modulator. The audio carrier oscillator is phase-locked to the video carrier. The modulator output is applied to a diode switch. If the input is monaural audio, the audio is pre-emphasized and applied to a peak detector. When peak modulator exceeds 25 kHz, the peak detector illuminates the front panel Overdeviation LED. If the input is a composite BTSC stereo signal, the pre-emphasis network and Overdeviation LED are disabled. The front panel BTSC Cal LED is used to precisely set the deviation to 25 kHz when an external reference calibration tone is applied to the audio input.

A 4.5 MHz audio subcarrier input is limited and mixed with a signal from the video carrier oscillator to generate a 41.25 MHz audio carrier. The 41.25 MHz output signal is filtered and applied to a diode switch. The switch is used to select either the output of the internal audio carrier modulator or output of the 4.5 MHz mixer. A rear panel 4.5 MHz Select terminal is grounded to select the 4.5 MHz source. The switch output is amplified by a circuit whose gain is set by the front panel Audio IF Carrier control. The output is combined with the video carrier.

The combined audio and video carriers are applied to a diode switch. This switch selects the internally generated carriers or an external alternate IF input. A rear panel Alt IF Select terminal is grounded to select the alternate IF input. The switch output is amplified, filtered, and sent to the rear panel IF Output connector.

OUTPUT CONVERTER BOARD

The IF signal from the Modulator Board passes through a front panel RF Level attenuator and is applied to a mixer. A crystal oscillator generates a LO signal for the mixer. The output of the mixer passes through several sections of channel filters and amplifiers. The output is applied to the rear panel RF Output. A coupler feeds the front panel -20 dB Test connector.

POWER SUPPLY

For modulators that operate below channel frequencies of 300 MHz, the power supply is located on the output converter.

For modulators that operate above channel frequencies of 300 MHz, a separate power supply board provides voltages to the Modulator Board and Output Converter Board.

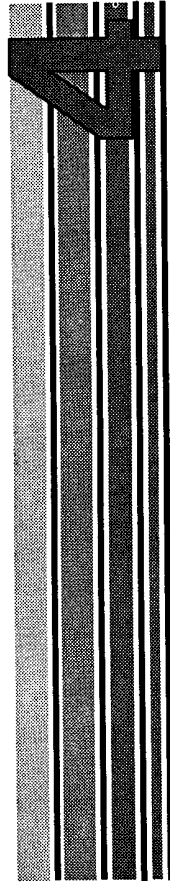

## Maintenance and Service

■ MAINTENANCE

■ SERVICE

■ TROUBLESHOOTING

## MAINTENANCE

While maintenance and service should be performed only by qualified personnel, there is a limited amount of maintenance and service that you can perform on the Model 6340 Modulator. This chapter presents maintenance and service information about the Model 6340 that should be useful to anyone performing maintenance functions.

Routine maintenance consists of general cleaning procedures to remove dust and dirt and involves inspection of equipment for possible damage or loose components. The following paragraphs describe these items as they apply to the modulator.

## VISUAL INSPECTION

Inspect the modulator's interconnecting cables to be sure that all connections are secure and that there are no cuts or tears on the cable covering. Check that none of the stripped ends of the cables connected to the rear panel barrier strip can make contact with the chassis or another terminal. Make sure that no strain is put on any cable that might cause it to break or pull the unit off its shelf if not rack mounted.

## CLEANING

### WARNING

Unplug the unit from the wall outlet before cleaning to avoid possible electrical shock or personal injury.

To clean the modulator, wipe exposed surfaces and cable assemblies with a clean damp cloth to remove dust or dirt. Do not use liquid cleaners or aerosol sprays.

## SERVICE

The Model 6340 Television Modulator has no user-serviceable repair parts other than the ac power fuse. Therefore, if a problem develops you should refer service to a qualified repair technician. However, as a user, there are a few simple checks you can make prior to calling for service. Table 4-1 is a fault isolation diagram that will lead you through some simple checks which may avoid a service call when there really is no serious problem.

## TROUBLESHOOTING PROCEDURES

Table 4-1. Common Problems and How to Solve Them

Symptom	Probable Cause	Corrective Action
Power indicator does not come on	Modulator power cord unplugged Fuse not fully inserted into fuseholder Blown fuse or internal malfunction	Plug the power cord into a power outlet with the appropriate electrical power supply. Fully insert fuse. Contact qualified service technician.
No RF output	Cable not connected to RF output connector	Make sure that the cable connection is completely secure at the RF output connector. Check that cable center conductor is plugged completely into its receptacle.
Poor quality video contrast	Modulation depth not set correctly.	Adjust the VIDEO MODULATION control for best contrast when picture content is reasonably normal. (Do not adjust during high white or black content). For more accurate setting follow adjustment procedure in Chapter 3.
Poor quality audio	Connections not made correctly	Check audio cable connections on the rear audio panel. Reconnect if connections were not made according to the indications on each terminal. Be sure the grounding wire is connected on one end only.

## TROUBLESHOOTING PROCEDURES

Table 4-1. Common Problems and How to Solve Them - continued

Symptom	Probable Cause	Corrective Action
Poor quality audio	Deviation level setting (Monaural Mode)	When the sound is too low: Raise audio deviation level with the AUDIO DEVIATION control on the front panel until just before the OVERDEVIATION indicator lights up. When the sound is distorted or too high: Lower the modulation level with the AUDIO DEVIATION control on the front panel until the OVER-DEVIATION indicator goes off. Audio deviation can be adjusted only by using an encoder calibration tone. (BTSC Stereo Mode) Pre-emphasis is disabled Sound carrier level setting is too high
Adjacent channel has beat		Lower the sound carrier level with the AUDIO CARRIER LEVEL control on the front panel until the beat interference disappears.

## Installation and Operation Guide Model 6340 Television Modulator

Publication Number 69T259B

### User's Comments

Please take a few minutes to answer the questions below. Your input will help us in our continuing effort to improve the quality of our publications. This questionnaire has been developed as a self-contained, postage paid mailer for your convenience.

Check the appropriate box.

Accuracy	Excellent	Very Good	Good	Fair	Poor
Completion	<input type="checkbox"/>	<input type="checkbox"/>	<input type="checkbox"/>	<input type="checkbox"/>	<input type="checkbox"/>
Organization	<input type="checkbox"/>	<input type="checkbox"/>	<input type="checkbox"/>	<input type="checkbox"/>	<input type="checkbox"/>
Format	<input type="checkbox"/>	<input type="checkbox"/>	<input type="checkbox"/>	<input type="checkbox"/>	<input type="checkbox"/>

If you checked fair or poor for any of the items above, please specify why. \_\_\_\_\_

Is the manual clear and comprehensible to your technical and non-technical personnel? \_\_\_\_\_

What features (i.e., notes, tables, illustrations, etc.) are most useful? \_\_\_\_\_

What features are not useful and why? \_\_\_\_\_

Have you found errors? Yes  No

If errors have been found, please reference page #, table # or figure #. \_\_\_\_\_

Did our publication satisfy your needs? Yes  No

If not, please offer additional comments and suggestions here. \_\_\_\_\_

Name \_\_\_\_\_ Title \_\_\_\_\_  
 Company \_\_\_\_\_ Department \_\_\_\_\_  
 Address \_\_\_\_\_ City \_\_\_\_\_ State \_\_\_\_\_ Zip Code \_\_\_\_\_



**Addendum**  
*Installation and Operation Guide*  
*for the Model 6340 Television Modulator*  
*Publication Number 69T259B*

August 1992

**4.5 Input Selections for Model 6340 Television Modulator**

**Composite or Separate Input Choices for Video and 4.5 MHz Audio**

The Model 6340 Modulator provides a separate input connector on the rear of the chassis for 4.5 MHz audio. This 4.5 MHz audio input is sometimes used instead of a baseband audio input. The modulator has been revised to include a Composite selection (video and 4.5 MHz audio combined into the Video input connector). The modulator comes from the factory with the main board jumpers set to provide for a separate 4.5 MHz audio, but they may be easily repositioned for operators wanting to connect a composite signal to the modulator.

In either case (separate or combined), the 4.5 subcarrier is selected by grounding the 4.5 SEL terminal on back of the chassis (figure 2-6 in the operator's manual).

The jumper settings are as follows:

**Composite** Move jumper plugs P-4 and P-5 on J10, and P-6 on J11 toward rear of chassis.

**Separate** Move jumper plugs P-4 and P-5 on J10, and P-6 on J11 toward front of chassis.

**Physical Locations of Jumpers on Main IF Board (largest circuit board)**

P4 and P5 plugs for board jumper J10 are located 3/4 in. from the front of the board and 2 2/3 in. from the chassis side.

P6 plug for board jumper J11 is located 5 in. from the back of the board and 2 1/2 in. from the chassis side.

S-A Part No. 501107

NO POSTAGE  
NECESSARY  
IF MAILED  
IN THE  
UNITED STATES

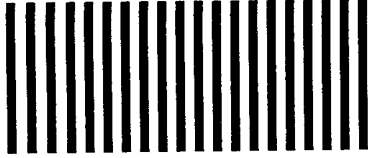

**BUSINESS REPLY MAIL**  
FIRST CLASS PERMIT NO. 12476, ATLANTA, GA, U.S.A.

POSTAGE WILL BE PAID BY ADDRESSEE

**Scientific-Atlanta, Inc.**

Attn: Publications  
Dept. ATL 1-X  
Box 105600  
Atlanta, GA 30348-9649

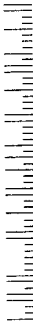

DO NOT TEAR--FOLD HERE AND TAPE