

## ! IMPORTANT !

If an icon appears at the end of a paragraph, go to the box on that page with the corresponding icon for pertinent information.

- ⚠ — Warning
- ! — Important
- ⚡ — Caution
- 💡 — Hint
- 📌 — Note

## ! CAUTION !

- Use only fresh batteries of the required size and recommended type.
- Do not mix old and new batteries, different types of batteries (standard, alkaline, or rechargeable), or rechargeable batteries of different capacities.
- Never leave dead or weak batteries in your Brum or the transmitter. Where they can corrode and damage the units.

## 📌 Note 📌

All batteries and chargers required for your Brum are available at your local RadioShack store.

Your RadioShack Brum is built to built to 1/4 scale, it can reach speeds of up to 160 feet per minute.

### INSTALLING BATTERIES

You need four AA batteries to power your Brum, and one 9-volt battery for its transmitter.

#### Installing your Brum's Batteries

You need four AA batteries (not supplied) to power your Brum. We recommend the use of RadioShack alkaline batteries.

1. Slide ON/OFF on the bottom of your Brum to OFF.
2. Turn the battery compartment cover's latch counterclockwise until it stops, then grasp the ribs on the cover and lift the cover up to remove it.
3. Install the batteries in the compartment as indicated by the polarity symbols (+and-) marked inside.
4. Replace the cover, and then turn the latch clockwise until it stops to secure it.

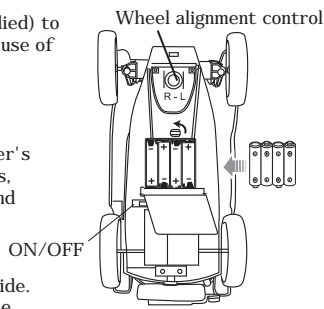

If your Brum moves slowly or not at all, replace your Brum's batteries.

Note: If you do not plan to use your Brum for several days, remove the batteries. Batteries can leak chemicals that can damage electronic parts.

#### Installing the Transmitter's Battery

The transmitter requires one 9-volt battery (not supplied).

1. Press and slide the battery compartment cover off the transmitter.
2. Place a 9V battery in the compartment according to the polarity symbols (+and-) marked inside.
3. Replese the cover. Be sure it snaps shut.

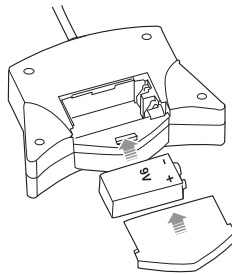

When the transmitter's range decreases, replace its battery.

#### Operation Driving your Brum

1. Slide ON/OFF on the bottom of your Brum to ON  
When the car is on, there are two modes: Expression mode and Driving mode. If you leave the car on and not moving it, you will hear engine tick-over sound then the Brum has entered into a 5 second standby mode. After 5 seconds, you will see and hear the following sound and actions ("expression") in sequence.

## ⚠ Warning ⚠

Dispose of old batteries and the battery pack promptly and properly; do not burn or bury them.

## ⚡ Caution ⚡

Do not play with your Brum in the street.

Sequence	Action	sound	expression	duration
1	Side rock/starter handle spin	Side rock	hello	3 sec
2	Starter handle spin	Starter hander	Starter handle	3 sec
3	Headlamp turn left and right	Same as standby mode	looking	3 sec

1. Side rock/starter handle spin

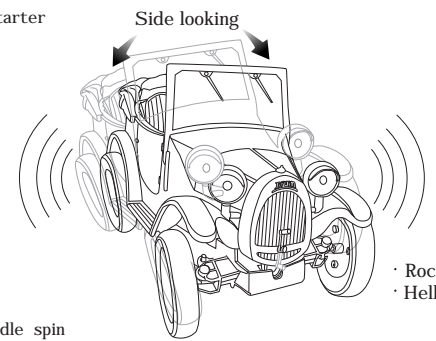

2. Starter handle spin

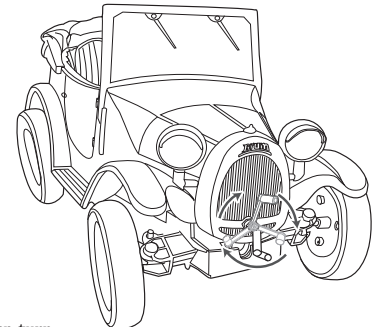

3. Headlamp turn left and right

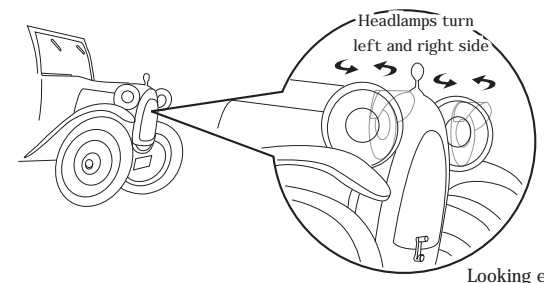

After performing the above expressions, Brum will enter into a 10 sec standby mode (engine tick-over sound) and will start all over again from sequence one.

Use the transmitter's control levers to control the movement and direction of the Brum.



© 2003 InterTAN Inc. All Rights Reserved  
RadioShack is a Registered trademark licensed to ITA and used with the permission of TRS Quality Inc.

LEFT CONTROL LEVER	ACTION	SOUND
Pull forward	Move forward	Start with Horn sound and then Past and Away Sound and stop with Tire Squeal Sound
Pull backward	Move backward	Move with Slow Revs Sound
Release	Stop	Engine Tick-over Sound

Remarks: When your Brum is moving forward, it carries short bursts of expression (Hello, Starter Handle or Looking) each of 1 second, in intervals of 10 seconds between them.

RIGHT CONTROL LEVER	ACTION	SOUND
Push left	Turn left	Tire squeal sound
Pull backward	Turn right	Tire squeal sound
Release	Go straight	Same as that of the movement

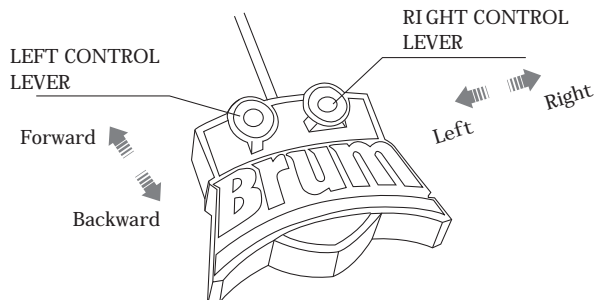
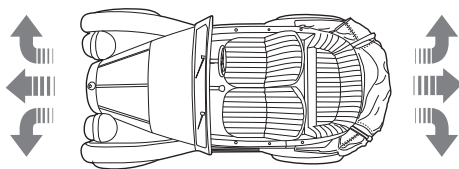

Remarks: the body will also lean to same direction on the turning side  
3. When you finish driving your Brum, slide ON/OFF to OFF.

#### WHEEL ALIGNMENT

If your Brum does not drive in a straight line when you release the right control lever, adjust the wheel alignment control on the bottom of your Brum. Rotate the control to the left if your Brum is pulling to the right or to the right if your Brum is pulling to the left.

#### CARE AND MAINTENANCE

- The following suggestions will help you care for your RadioShack Brum so you can enjoy it for years.
- Do not expose your Brum or its transmitter to temperature extremes, and do not store them in direct sunlight or near a heat

#### 💡 HELPFUL HINTS 💡

- These hints can help you get the most enjoyment from your Brum.
- Running your truck continuously for long periods generates high heat levels. Heat causes wear and tear on the motor. To help keep heat levels down, when your truck's battery power dies, let the truck cool at least 10 minutes before installing new batteries.
- If your Brum's motor runs but your Brum does not respond to the transmitter, move the transmitter closer to your Brum and try again.
- If someone uses a CB nearby, it might interfere with control of your Brum. If this happens, move your Brum away from the CB. You cannot operate your Brum near devices with transmitters that use the same frequency (27 MHz).

source.

- Wipe your Brum and transmitter with a damp cloth occasionally to keep them looking new. Do not use harsh chemicals to clean them.
- Do not drive your Brum through puddles or mud, on a wet floor, or in sand, rain, or snow. These can damage it.
- Do not leave your Brum or its transmitter outside overnight. Night dampness can damage their electronic circuits.
- To protect your Brum's mechanisms from lint and hair, do not drive your Brum on carpet.

Modifying or tampering with your Brum's or the transmitter's components can cause a malfunction and might invalidate the car's warranty and void your FCC authorization to operate them. If your Brum does not work properly, as it should, take it to your local RadioShack store for assistance.

#### THE FCC WANTS YOU TO KNOW

Your Brum or its transmitter might cause TV or radio interference even when it is operating properly. To determine whether your Brum or transmitter is causing the interference, release the transmitter's control button and turn off your Brum. If the interference goes away, your Brum or transmitter is causing it. Try to eliminate the interference by: Moving your Brum away from the TV or radio Contacting your local RadioShack store for help. If you cannot eliminate the interference, the FCC requires that you stop using your Brum and transmitter.

#### USER-REPLACEABLE PARTS

You can order these parts through your local RadioShack store.

#### Limited Ninety-Day Warranty

RadioShack warrants this product against manufacturing defects in material and workmanship under normal use for ninety (90) days from the date of purchase from RadioShack company-owned stores and authorized RadioShack franchisees and dealers. EXCEPT AS PROVIDED HEREIN, RadioShack MAKES NO EXPRESS WARRANTIES AND ANY IMPLIED WARRANTIES, INCLUDING THOSE OF MERCHANTABILITY AND FITNESS FOR A PARTICULAR PURPOSE, ARE LIMITED IN DURATION TO THE DURATION OF THE WRITTEN LIMITED WARRANTIES CONTAINED HEREIN. EXCEPT AS PROVIDED HEREIN, RadioShack SHALL HAVE NO LIABILITY OR RESPONSIBILITY TO CUSTOMER OR ANY OTHER PERSON OR ENTITY WITH RESPECT TO ANY LIABILITY, LOSS OR DAMAGE CAUSED DIRECTLY OR INDIRECTLY BY USE OR PERFORMANCE OF THE PRODUCT OR ARISING OUT OF ANY BREACH OF THIS WARRANTY, INCLUDING, BUT NOT LIMITED TO, ANY DAMAGES RESULTING FROM INCONVENIENCE, LOSS OF TIME, DATA, PROPERTY, REVENUE, OR PROFIT OR ANY INDIRECT, SPECIAL, INCIDENTAL, OR CONSEQUENTIAL DAMAGES, EVEN IF RadioShack HAS BEEN ADVISED OF THE POSSIBILITY OF SUCH DAMAGES.

Some states do not allow the limitations on how long an implied warranty lasts or the exclusion of incidental or consequential damages, so the above limitations or exclusions may not apply to you.

In the event of a product defect during the warranty period, take the product and the RadioShack sales receipt as proof of purchase date to any RadioShack store. RadioShack will, at its option, unless otherwise provided by law: (a) correct the defect by product repair without charge for parts and labor; (b) replace the product with one of the same or similar design; or (c) refund the purchase price. All replaced parts and products, and products, on which a refund is made, become the property of RadioShack. New or reconditioned parts and products may be used in the performance of warranty service. Repaired or replaced parts and products are warranted for the remainder of the original warranty period. You will be charged for repair or replacement of the product made after the expiration of the warranty period.

This warranty does not cover: (a) damage or failure caused by or attributable to acts of God, abuse, accident, misuse, improper or abnormal usage, failure to follow instructions, improper installation or maintenance, alteration, lightning or other incidence of excess voltage or current; (b) any repairs other than those provided by a RadioShack Authorized Service Facility; (c) consumables such as fuses or batteries; (d) cosmetic damage; (e) transportation, shipping or insurance costs; or (f) costs of product removal, installation, set-up service adjustment or reinstallation.

This warranty gives you specific legal rights, and you may also have other rights, which vary, from state to state.

RadioShack Customer Relations, 200 Taylor Street, 6th Floor, Fort Worth, TX 76102

We Service What We Sell

03/00