



國際電器認證中心有限公司 International Electrical Certification Centre Ltd.

提供電器產品測試國際認證及諮詢服務 Technical Services in Electrical Product Testing, International Certification & Information

Agent of   
Accredited Laboratory

**FCC ID: HAP91117**

## **Exhibit 5 - User's Manual**

**Head Office**

Unit 602-605, 6/F, 31 Lok Yip Road, On Lok Tsuen, Faning, NT, Hong Kong Tel (852) 2305 2570 Fax (852) 2756 4480  
香港新界粉嶺安樂村樂業路31號6樓602-605室 電話 (852) 2305 2570 傳真 (852) 2756 4480

# KNIGHT TRAKK RADIO CONTROL OWNER'S MANUAL

---

Read this manual carefully to the end before playing with your vehicle.

## CAUTION:

1. DO NOT pick up vehicle while it is in motion;
2. Keep fingers, hair and loose clothing away from the treads and tread hubs while the product is switched "ON";
3. If this toy is being operated in the presence of children under 8 years of age, adult supervision is recommended.
4. To avoid accidental operation, remove battery pack when not in use.

## FEATURES

- Full function system
  - High-speed spin turn
  - Wide PVC track
- 

## CONTENTS

- Vehicle x 1
- Transmitter x 1
- Charger x 1
- Owner's Manual x 1

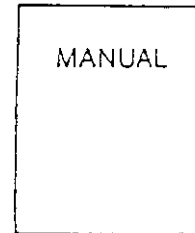
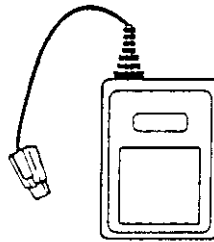
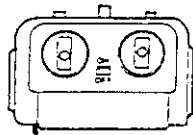
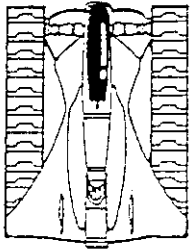

## BATTERY REQUIREMENTS (NOT INCLUDED)

Transmitter:



1 x "9V" alkaline battery

Vehicle:

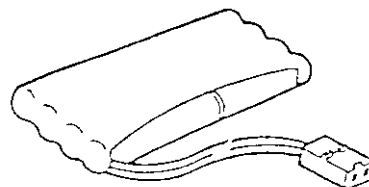

one Ni-Cd battery pack (9.6V)

---

# BATTERY INSTALLATION

## (A) TRANSMITTER

1. Press and slide the battery compartment cover in the direction of the arrow to open.
2. Insert one "9V" alkaline battery (not included) as shown in diagram.
3. Be sure to observe correct polarity (+ and -)
4. Replace cover

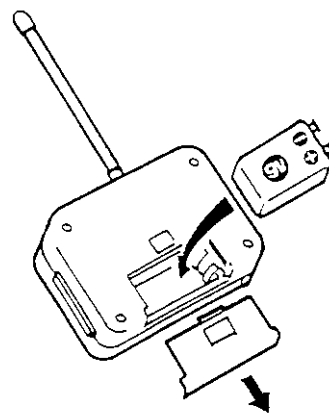

## (B) VEHICLE

Battery compartment is at the bottom of car.

1. Use a coin to turn the lock in anti-clockwise direction ①
2. Slide the cover in the direction of the arrow ②
3. Lift the cover to open ③
4. Plug battery pack connector ⑤ into the battery compartment socket ④. (Battery pack not included)
5. Tuck wires neatly into compartment and then place battery pack above wires and close cover.
6. To disconnect, pull connector out. Do not pull by the wires.

Note: When you connect the connectors, make certain that the vehicle switch is in the "OFF" position.

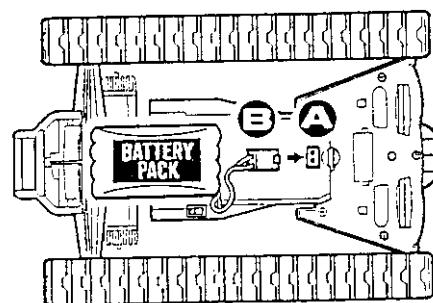
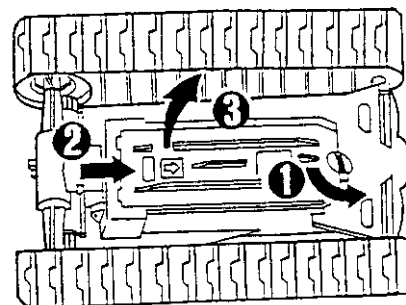

# OPERATING THE VEHICLE

1. Turn ON/OFF switch on the transmitter to "ON" position first and extend the transmitter antenna fully.

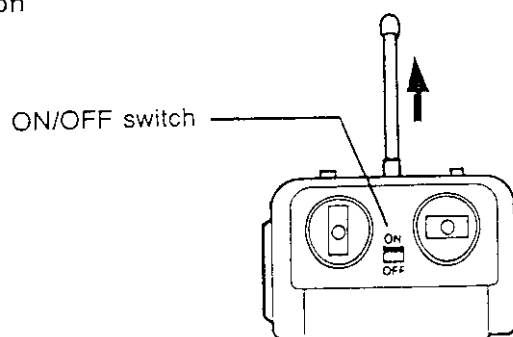

2. Turn ON/OFF switch on the vehicle to "ON" position.

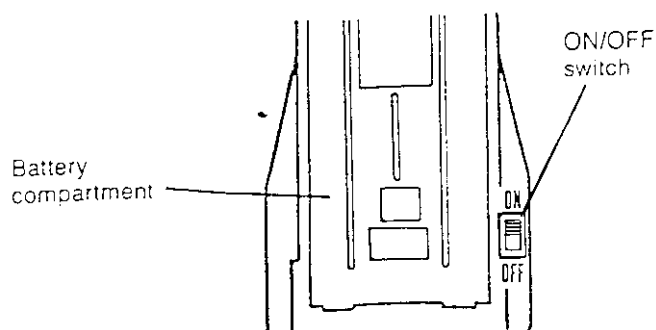

### 3. STEERING

#### FORWARD

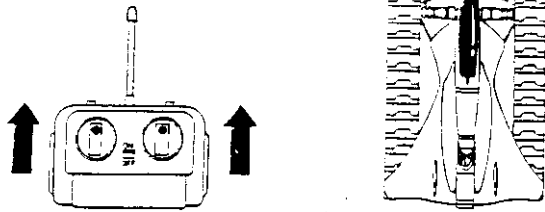

#### REVERSE

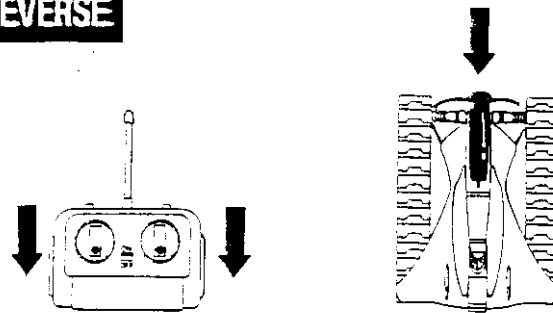

#### LEFT TURN

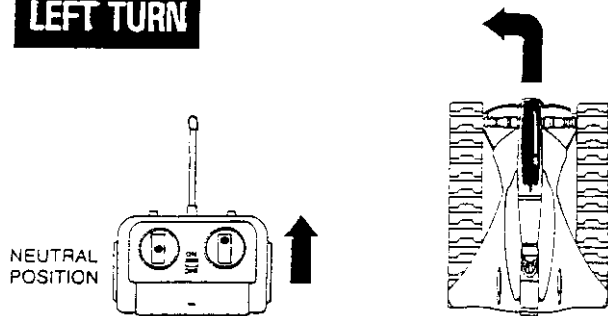

#### RIGHT TURN

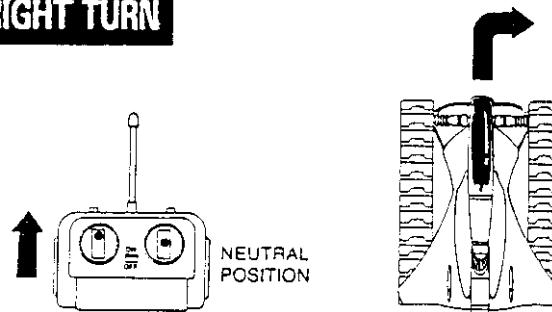

#### SPIN COUNTERCLOCKWISE

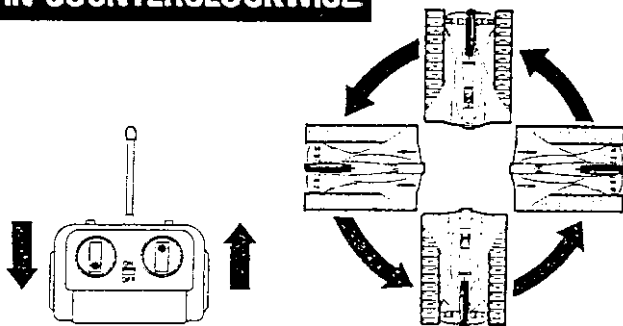

#### SPIN CLOCKWISE

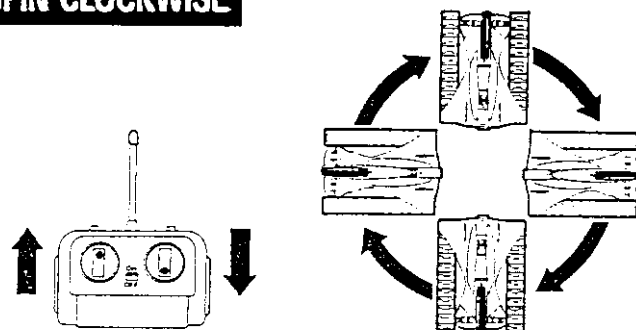

### BATTERY CHARGING

1. Plug wall pack charger into standard 110/120 (or 220 where applicable) volt wall outlet. (Charger not included)
2. Connect the wires leading from the battery pack to the wall pack charger connector. Make certain the two connectors are tightly snapped together.
3. To disconnect wires, push down on the connector clip and pull apart.
4. After charging for 10 hours, the battery pack will feel warm. This condition is normal for fully charged batteries.
5. Charging the battery pack for more than 10 hours will not give you longer running time. Ten hours is all that is required for a fully charged battery pack.
6. Unlike alkaline batteries, where the power loss is gradual, a NiCd (nickel cadmium) battery will lose all of its power at once. Your R/C vehicle will suddenly stop operating. The vehicle is not defective, but it is time to recharge the battery pack.
7. After use, the battery pack will be hot! Wait at least 20 minutes until the battery pack cools down before recharging. Recharging a hot battery pack will greatly reduce the number of times your battery pack can be recharged.

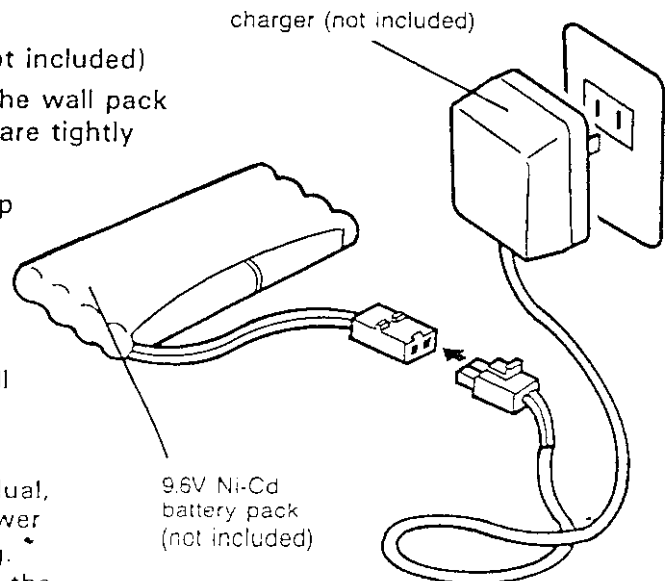

---

## RUNNING TIME

This vehicle has two motors which require a lot of power to operate. The running time is up to 20 minutes.

---

## CARE AND MAINTENANCE

- 1) The car works best on a clean flat surface. Do not use it on a wet floor, or in mud or sand.
- 2) When you have finished using the car, be sure to put the ON/OFF switch to "OFF". This saves battery power.
- 3) If you are not planning to use the car for a few days, remove the battery pack from the car and battery from the transmitter. Never leave weak or dead batteries in either unit. They might leak corrosive chemicals that can cause damage.
- 4) If the car moves slowly, or doesn't move at all, recharge the battery pack.
- 5) If the car with new batteries does not respond to the transmitter, replace the "9V" battery with a new one.
- 6) If CB transceivers are operating near by, they may interfere with your control of the car. If this happens, wait till the CB unit stop transmitting or move to a new location.
- 7) Do not use the car in the street.

**BATTERY REQUIREMENTS (NOT INCLUDED)****VEHICLE:**

1 x 9.6V POWER PACK 9.6V --- 22W

(NI-CD RECHARGEABLE)

CAPACITY OF BATTERY 600 mAh

**TRANSMITTER**

1 x 9V SIZE 6F22, 9V --- 0.5W

(CARBON, ALKALINE, NI-CD RECHARGEABLE)

CAPACITY OF BATTERY 120 mAh

**WARNING:**

THE UNIT SHOULD ONLY BE POWERED BY THE ABOVE BATTERIES.  
MAKE SURE YOU HAVE INSERTED THE BATTERY CORRECTLY.

**CAUTION**

CHARGING UNIT TO BE USED WITH THE TOY SHOULD BE REGULARLY EXAMINED FOR POTENTIAL HAZARD, SUCH AS DAMAGE TO THE CABLE OR CORD, PLUG, ENCLOSURE OF OTHER PARTS AND THAT, IN THE EVENT OF SUCH DAMAGE, THE TOY MUST NOT BE USED UNTIL THAT DAMAGE HAD BEEN PROPERLY REMOVED.



©1998 ECHO TOYS LTD. ALL RIGHTS RESERVED

8A & B, TAI PING INDUSTRIAL CENTRE, BLOCK 1, 57 TING KOK ROAD, TAI PO, NT HONG KONG