



99944200563

ProThatch Attachment

FOR MODELS: SRM-2400SB, 260SB, 261SB, PAS-2400, 2601, 230, 231, 260, 261, 265, 266, 280

Operator's Manual

⚠ WARNING



Users of this equipment risk injury to themselves and others if the unit is used improperly and/or safety precautions are not followed. ECHO provides an operator's manual. It must be read and understood for proper and safe operation. Failure to do so could result in serious injury.

Specifications, descriptions and illustrative material in this literature are as accurate as known at the time of publication, but are subject to change without notice. Illustrations may include optional equipment and accessories, and may not include all standard equipment.

TABLE OF CONTENTS

Table of Contents 2

Introduction 3

 The Operator’s Manual 3

Service Information 3

 Parts/Serial Number..... 3

 Service 3

 Echo Consumer Product Support 3

 Warranty Registration 3

 Additional or Replacement Manuals 3

Safety..... 4

 Manual Safety Symbols and Important Information 4

 International Symbols 5

 Personal Condition and Safety Equipment 5

 Equipment..... 8

Description 9

Contents 10

Assembly 11

 Fender / Wheel Assembly to Lower Drive Shaft Assembly..... 11

 Lower Drive Shaft Assembly to Dethatcher Gear Housing 11

 Front J-Handle Assembly..... 12

 Power Head Shaft/Lower Shaft Assembly 13

 Fender/Wheel Assembly Adjustment..... 14

 Front J-Handle Adjustment 15

Operation 16

 Dethatching Information..... 16

 Dethatching Operation 16

Maintenance 17

 Skill Levels 17

 Maintenance Intervals..... 17

 Lubrication 17

 Tine Replacement..... 18

Storage 20

Specifications..... 21

Warranty Statements 22

INTRODUCTION

Welcome to the ECHO family. This ECHO product was designed and manufactured to provide long life and on-the-job dependability. Read and understand this manual. You will find it easy to use and full of helpful operating tips and SAFETY messages.

The Operator's Manual

Keep it in a safe place for future reference. Contains specifications and information for safety, operation, maintenance, storage and assembly specific to this product.

SERVICING INFORMATION

Parts/Serial Number

Genuine ECHO Parts and ECHO REPOWER™ Parts and Assemblies for your ECHO products are available only from an Authorized ECHO Dealer. When you do need to buy parts **always** have the Model Number and Serial Number of the unit with you. You can find these numbers on the engine housing. For future reference, write them in the space provided below.

Model No. _____ SN. _____

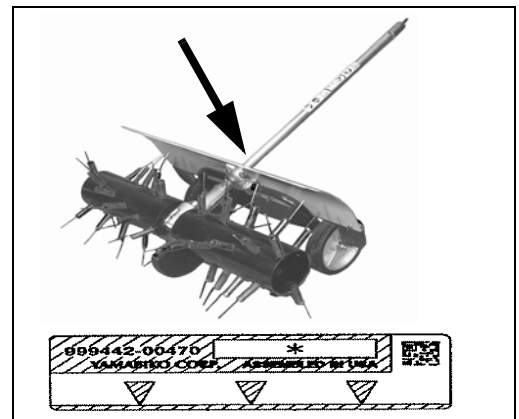

Service

Service of this product during the warranty period must be performed by an Authorized ECHO Service Dealer. For the name and address of the Authorized ECHO Service Dealer nearest you, ask your retailer or call: 1-800-432-ECHO (3246). Dealer information is also available on our Web Site. When presenting your unit for Warranty service/repairs, proof of purchase is required.

Echo Consumer Product Support

If you require assistance or have questions concerning the application, operation or maintenance of this product you may call the ECHO Consumer Product Support Department at 1-800-673-1558 from 8:30 am to 4:30 pm (Central Standard Time) Monday through Friday. Before calling, please know the model and serial number of your unit.

Warranty Registration

To ensure trouble free warranty coverage it is important that you register your ECHO equipment on-line at www.echo-usa.com or by filling out the warranty registration card supplied with your unit. Registering your product confirms your warranty coverage and provides a direct link between you and ECHO if we find it necessary to contact you.

Additional or Replacement Manuals

Replacement Operator, Safety Manuals, and Parts Catalogs are available from your ECHO dealer or at www.echo-usa.com or by contacting ECHO Inc., 400 Oakwood Road, Lake Zurich, IL 60047 (800-673-1558). Always check the ECHO Web Site for updated information.



For more information scan this QR code.

Safety Videos are available from your Echo dealer. A \$5.00 shipping charge will be required for each video.

SAFETY

WARNING

Refer to your Pro Attachment Series or Split Boom Operator's Manual for correct engine fueling, starting and stopping instructions.

Manual Safety Symbols and Important Information

Throughout this manual and on the product itself, you will find safety alerts and helpful, informational messages preceded by symbols or key words. The following is an explanation of those symbols and key words and what they mean to you.

DANGER

The safety alert symbol accompanied by the word "DANGER" calls attention to an act or condition which WILL lead to serious personal injury or death if not avoided.

WARNING

The safety alert symbol accompanied by the word "WARNING" calls attention to an act or condition which CAN lead to serious personal injury or death if not avoided.

CAUTION

The safety alert symbol accompanied by the word "CAUTION" calls attention to an act or condition which may lead to minor or moderate personal injury if not avoided.

NOTICE

The enclosed message provides information necessary for the protection of the unit.



















Note: This enclosed message provides tips for use, care and maintenance of the unit.



CIRCLE AND SLASH SYMBOL

This symbol means the specific action shown is prohibited. Ignoring these prohibitions can result in serious or fatal injury.

International Symbols

Symbol	Description	Symbol	Description	Symbol	Description	Symbol	Description
	Warning, See Operator's Manual		Safety/Alert		DO NOT USE BLADES - Line Head Only		Thrown objects
	Wear eye, ear and head protection		Finger Severing		Plan retreat path from falling objects		
	Wear hand and foot protection		Rotating Cutting Attachment	   		AVOID KICKOUT. Keep bystanders at least 15 meters (50 feet) away.	
	Wear Face Shield		Wear slip resistant foot wear			Beware Thrown Objects Wear Eye Protection	
	Keep feet away from blade		Do not operate closer than 15 M (50 ft.) from electrical hazards. Keep bystanders at least 15 meters (50 feet) away			Keep bystanders and helpers away 15 m (50 ft.).	

Personal Condition and Safety Equipment

WARNING

Users of this product risk injury to themselves and others if the unit is used improperly and/or safety precautions are not followed. Proper clothing and safety gear must be worn when operating unit.

Physical Condition

Your judgment and physical dexterity may not be good:

- if you are tired or sick,
- if you are taking medication,
- if you have taken alcohol or drugs.

Operate unit only if you are physically and mentally well.

Eye Protection

Eye protection that meets ANSI Z87.1, CE, or CSA Z94.3 requirements must be worn whenever you operate the unit.

Hand Protection

Wear no-slip, heavy duty work gloves to improve your grip on the handles. Gloves also reduce the transmission of machine vibration to your hands.

Breathing Protection

Wear a facemask to protect against dust.

Hearing Protection

ECHO recommends wearing hearing protection whenever unit is used.

Proper Clothing

Wear snug fitting, durable clothing;

- Pants should have long legs, shirts with long sleeves.
- DO NOT WEAR SHORTS,
- DO NOT WEAR TIES, SCARVES, JEWELRY, or clothing with loose or hanging items that could become entangled in moving parts or surrounding growth.

Wear sturdy work shoes with nonskid soles;

- DO NOT WEAR OPEN TOED SHOES,
- DO NOT OPERATE UNIT BAREFOOTED.

Wear no-slip, heavy duty work gloves.

Keep long hair away from engine and air intake. Retain hair with cap or net.

Hot Humid Weather

Heavy protective clothing can increase operator fatigue which may lead to heat stroke. Schedule heavy work for early morning or late afternoon hours when temperatures are cooler.

WARNING

The ignition components of this machine generate an electromagnetic field during operation which may interfere with some pacemakers. To reduce the risk of serious or fatal injury, persons with pacemakers should consult with their physician and the pacemaker manufacturer before operating this machine. In the absence of such information, ECHO does not recommend the use of ECHO products by anyone who has a pacemaker.

Vibration and Cold

It is believed that a condition called Raynaud's Phenomenon, which affects the fingers of certain individuals, may be brought about by exposure to vibration and cold. Exposure to vibration and cold may cause tingling and burning sensations, followed by loss of color and numbness in the fingers. The following precautions are strongly recommended, because the minimum exposure, which might trigger the ailment, is unknown.

- Keep your body warm, especially the head, neck, feet, ankles, hands, and wrists.
- Maintain good blood circulation by performing vigorous arm exercises during frequent work breaks, and also by not smoking.
- Limit the hours of operation. Try to fill each day with jobs where operating the unit or other hand-held power equipment is not required.
- If you experience discomfort, redness, and swelling of the fingers followed by whitening and loss of feeling, consult your physician before further exposing yourself to cold and vibration.

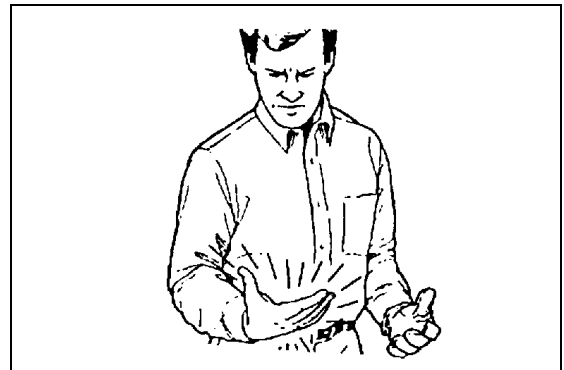

Repetitive Stress Injuries

It is believed that overusing the muscles and tendons of the fingers, hands, arms, and shoulders may cause soreness, swelling, numbness, weakness, and extreme pain in those areas. Certain repetitive hand activities may put you at a high risk for developing a Repetitive Stress Injury (RSI). An extreme RSI condition is Carpal Tunnel Syndrome (CTS), which could occur when your wrist swells and squeezes a vital nerve that runs through the area. Some believe that prolonged exposure to vibration may contribute to CTS. CTS can cause severe pain for months or even years.

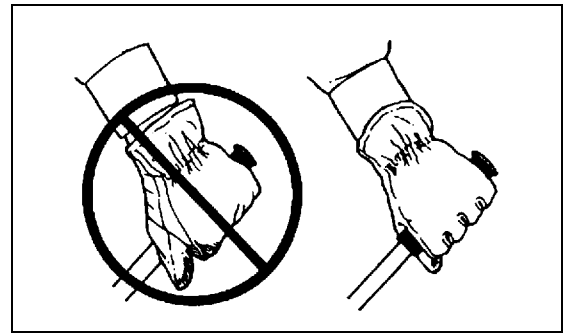

To reduce the risk of RSI/CTS, do the following:

- Avoid using your wrist in a bent, extended, or twisted position. Instead try to maintain a straight wrist position. Also, when grasping, use your whole hand, not just the thumb and index finger.
- Take periodic breaks to minimize repetition and rest your hands.
- Reduce the speed and force with which you do the repetitive movement.
- Do exercise to strengthen the hand and arm muscles.
- Immediately stop using all power equipment and consult a doctor if you feel tingling, numbness, or pain in the fingers, hands, wrists, or arms. The sooner RSI/CTS is diagnosed, the more likely permanent nerve and muscle damage can be prevented.

DANGER

All over head electrical conductors and communications wires can have electricity flow with high voltages. This unit is not insulated against electrical current. Never touch wires directly or indirectly, otherwise serious injury or death may result.

DANGER

Do not operate this product indoors or in inadequately ventilated areas. Engine exhaust contains poisonous emissions and can cause serious injury or death.

Read the Manuals

- Provide all users of this equipment with the Operator's Manual and Safety Manual for instructions on Safe Operation.

Clear the Work Area

- Spectators and fellow workers must be warned, and children and animals prevented from coming nearer than 15 m (50 ft.) while the unit is in use.

Keep a Firm Grip

- Hold the front and rear handles with both hands, with thumbs and fingers tightly encircling the handles.

Keep a Solid Stance

- Maintain footing and balance at all times. Do not stand on slippery, uneven or unstable surfaces. Do not work in odd positions or on ladders. Do not over reach.



Avoid Hot Surfaces

- During operation, the drive shaft housing and attachment bearing housing may become very hot, too hot to touch. Avoid contact during and immediately after operation.

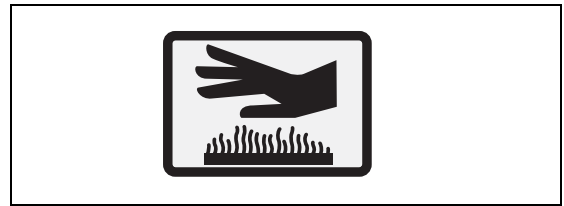

Equipment

WARNING

Use this attachment with ECHO approved models only. Serious injury may result from the use of this attachment combined with a non approved ECHO product.

- Check unit for loose/missing nuts, bolts, and screws. Tighten and/or replace as needed.
- Inspect ProThatch tines for damage and that they are firmly secured in place. Replace brushes if damaged or missing.
- Check that the dethatcher attachment is firmly attached and in safe operating condition.

Note: ECHO, INC. will not be responsible for the failure of cutting devices, attachments or accessories which have not been tested and approved by ECHO.

WARNING

Moving parts can amputate fingers or cause severe injuries. Keep hands, clothing and loose objects away from all openings.

- ◆ *ALWAYS stop engine, disconnect spark plug, and make sure all moving parts have come to a complete stop before removing obstructions, clearing debris, or servicing unit.*
- ◆ *DO NOT start or operate unit unless all guards and protective covers are properly assembled to unit.*
- ◆ *NEVER reach into any opening while the engine is running. Moving parts may not be visible through openings.*

DESCRIPTION

Locate the safety decal(s) on your unit. Make sure the decal(s) is legible and that you understand and follow the instructions on it. If a decal cannot be read, a new one can be ordered from your ECHO dealer. See PARTS ORDERING instructions for specific information.

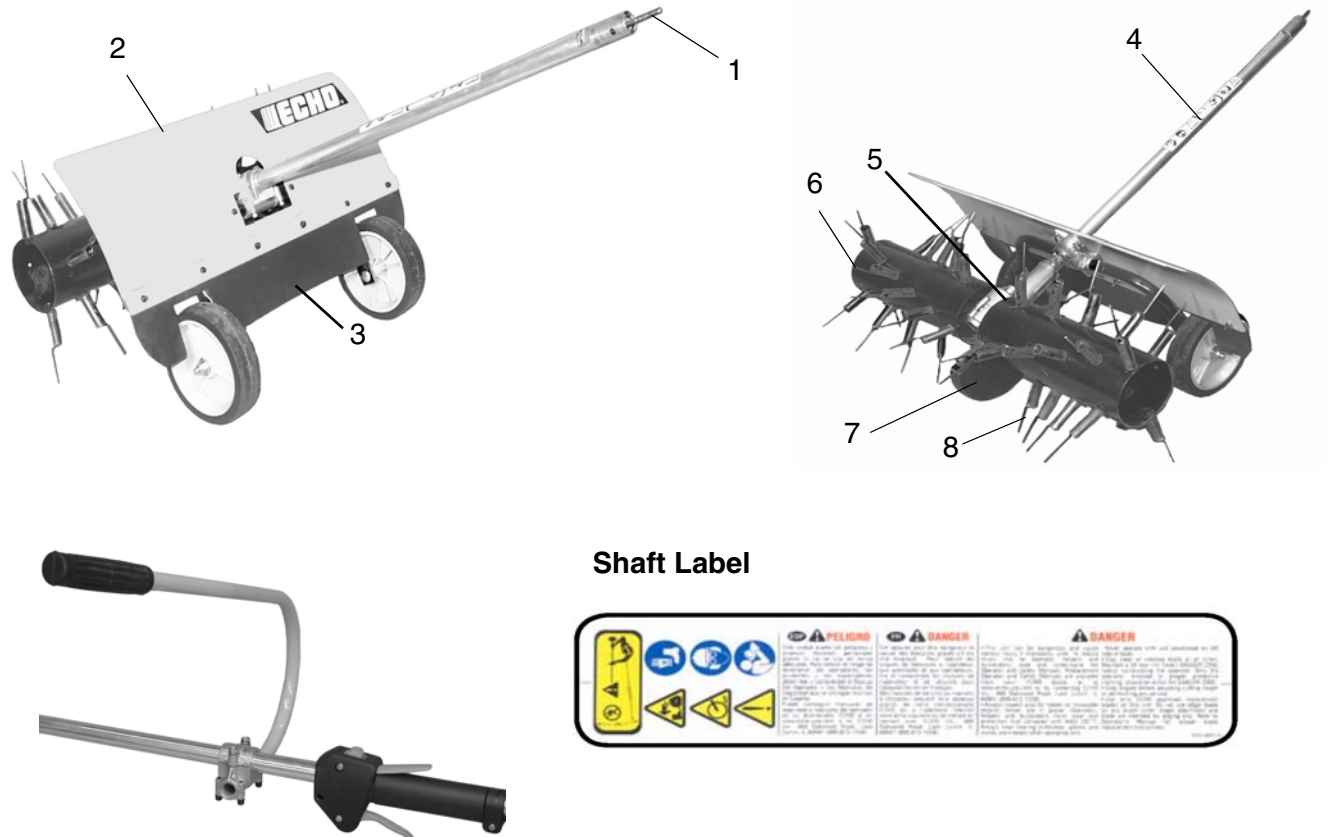

Shaft Label

1. **FLEXIBLE DRIVE CABLE** - Cable end fits into drive shaft coupler of Pro Attachment Series or Split Boom models. Lubricate drive cable every 25 hours with high temperature automotive grease.
2. **FENDER / WHEEL ASSEMBLY** - Consists of pre-assembled wheels, wheel bracket, fender and rubber flap. For best results, wheels should be adjusted for 13 mm (0.5 in.) ground clearance and are intended to provide operational stability over uneven ground.
3. **FENDER / RUBBER FLAP** - Provides operator protection against thrown thatch, rocks and other debris. Always insure that fender and flap are in place and in good condition before operating Pro Thatch Attachment.
4. **LOWER DRIVE SHAFT ASSEMBLY** - Included separately in the carton and must be assembled to the dethatcher / gear housing assembly. Contains flexible drive cable, outer shaft housing and safety decal.
5. **DETHATCHER / GEAR HOUSING ASSEMBLY** - Right and left reels pre-assembled to gear housing.
6. **DETHATCHER REELS** - Dethatcher reels have 22 tines each and are pre-assembled to the gear housing. Reels must be installed properly to prevent side pull.
7. **GRASS GUIDE** - Attached to the dethatcher assembly / gear housing. The guide prevents tines from penetrating too deeply into the ground, which can cause the dethatcher to bounce and give uneven thatch removal.
8. **TINES** - Steel springs with 51 mm (2 in.) fingers. Tines are protected by a plastic cover to prevent thatch and dirt buildup.

CONTENTS

The ECHO product you purchased has been factory pre-assembled for your convenience.

After opening the carton, check for damage. Immediately notify your retailer or ECHO Dealer of damaged or missing parts. Use the contents list to check for missing parts.

- _____ Dethatcher / Gear Housing Assembly
- _____ Lower Drive Shaft Assembly
- _____ Fender / Wheel Assembly
- _____ Operator's Manual
- _____ Warranty Card
- _____ J-Handle

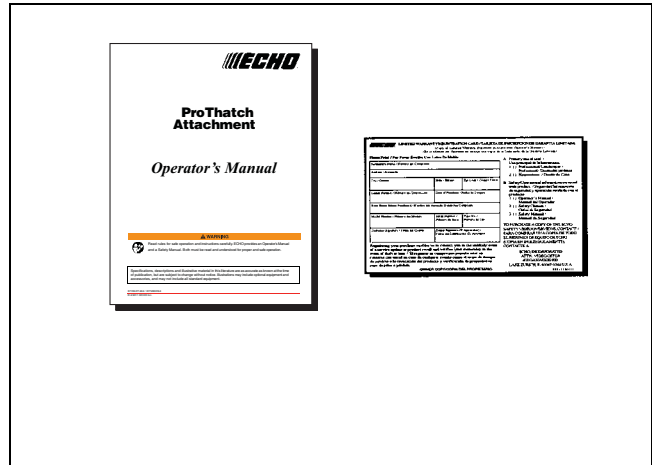

ASSEMBLY

Fender / Wheel Assembly to Lower Drive Shaft Assembly

⚠ WARNING

Do not perform maintenance or assembly procedures with engine running.

Parts Required: Lower Drive Shaft Assembly, Fender / Wheel Assembly

1. Remove vinyl caps from attachment drive shaft tube.
2. Loosen two (2) fender/wheel assembly bracket bolts (A). The bolts should be very loose to prevent bracket from damaging locating arrow decal label.
3. Install fender/wheel assembly, fender side first, onto end of lower drive shaft without serial number label. End of drive shaft should be 95 mm (3.74 in.) from fender clamp. Assure locating hole (B) is facing upward, and locating arrow decal (C) is aligned with edge of fender clamp.
4. Tighten bolts (A).

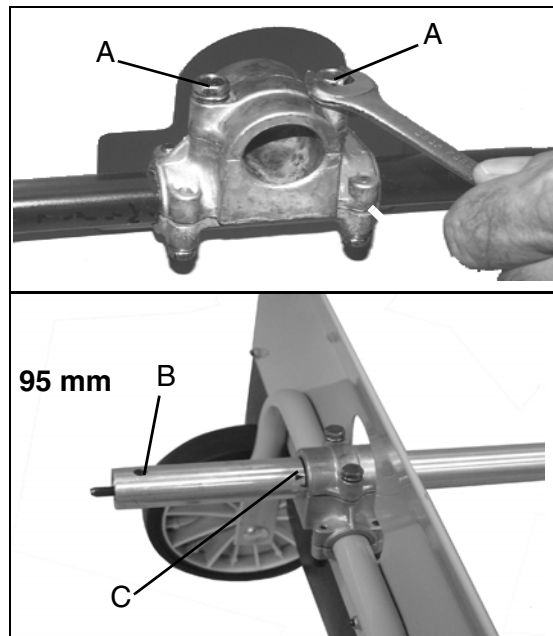

Lower Drive Shaft Assembly to Dethatcher Gear Housing

Parts Required: Dethatcher Gear Housing, Lower Drive Shaft with Fender / Wheel Assembly

1. Place dethatcher gear housing on a flat surface with gear housing shaft mount at 45° angle.
2. Remove gear housing shaft alignment screw (A).
3. Loosen gear housing shaft mounting bolt (B).

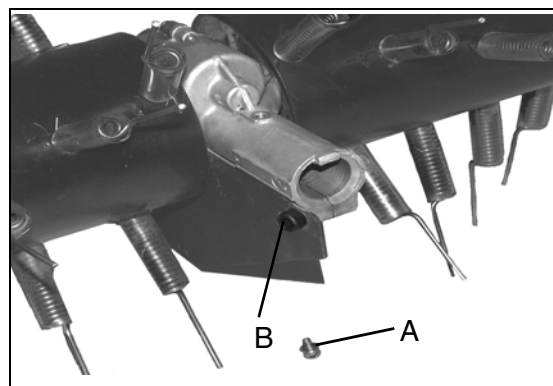

4. Install and seat lower drive shaft end (end with fender/wheel assembly) into gear housing shaft mount. Make sure grass guide (D) is facing down toward the ground.

5. Rotate and align hole in drive shaft housing with gear housing shaft hole. Install and tighten alignment screw (A).
6. Tighten gear housing shaft mounting bolt (B).

7. Check for proper inner flex cable (C) engagement into gear housing adaptor. If flex cable extends out of drive shaft then cable is not properly engaged. Rotate and push cable end until lower cable end slides into place in gear housing adaptor. Cable end will recess approximately 16 mm (5/8 in.) into drive shaft.

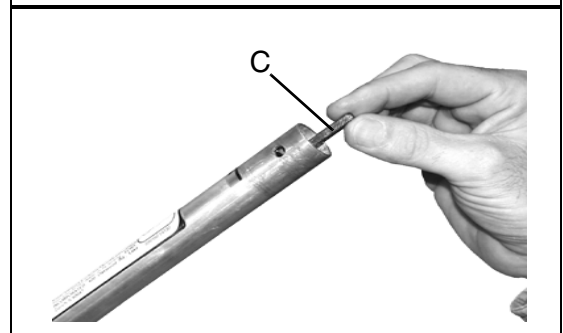
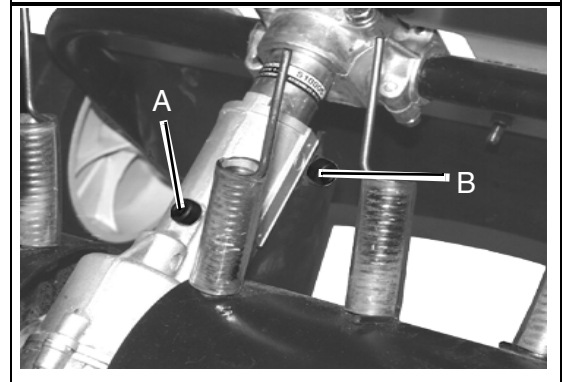
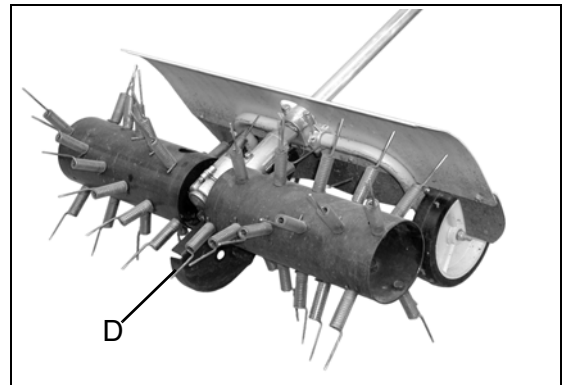

Front J-Handle Assembly

Parts Required: Pro Attachment Series or Split Boom Upper Shaft and Power Head

1. Remove original front handle assembly. Assemble handle parts with fasteners and store in a safe place for future application with other attachments.
2. Remove two (2) J-Handle bracket bolts (A).

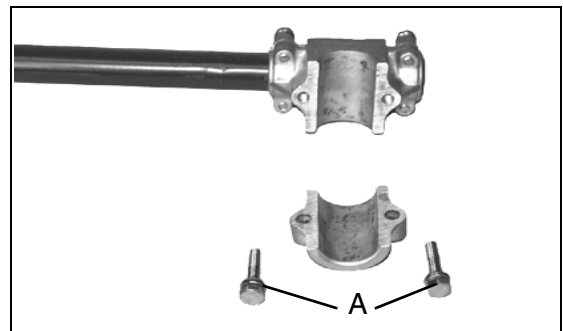

3. Install J-Handle assembly with handle grip on the left side (viewed from the operator's position) onto the upper drive shaft. Lightly snug bolts (A) to temporarily hold handle in place.

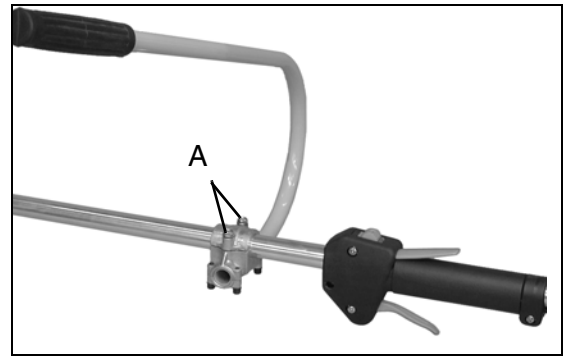

Power Head Shaft/Lower Shaft Assembly

Parts Required: PAS or SRM-SB Power Head w/Shaft & Coupling.

1. Set Power Head/Shaft Assembly on a level surface.
2. Pull locator pin (A) out, and turn counter-clockwise 1/4 turn to lock-out position.
3. Remove vinyl cap from attachment drive shaft.
4. Remove cardboard spacer, if necessary.

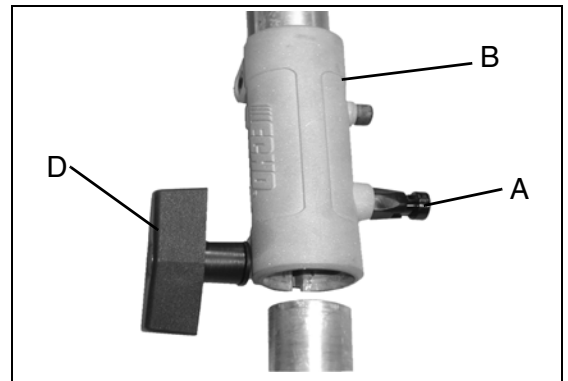

5. Carefully fit attachment drive shaft assembly into coupler (B) to decal assembly line (C), making sure that the inner lower drive shaft engages into the square upper drive shaft socket.

Note: Earlier model Power Heads may have shorter couplings. Short couplings fit flush to decal point (E). New couplings are 4-3/4 in. long, and fit flush to line (C).

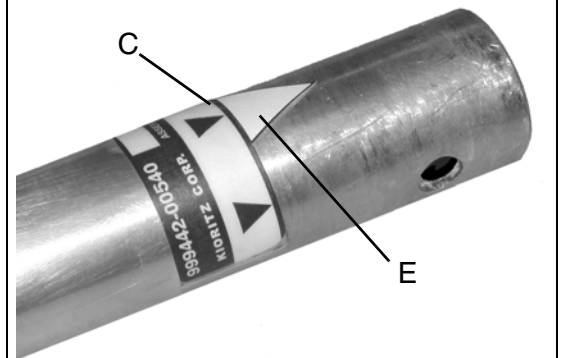

6. Rotate locator pin (A) 1/4 turn clockwise to engage lower shaft hole. Insure locator pin is fully engaged by twisting lower drive shaft. Locator pin should snap flush in coupler. Full engagement will prevent further shaft rotation.
7. Secure lower shaft assembly to coupler by tightening clamping knob (D).

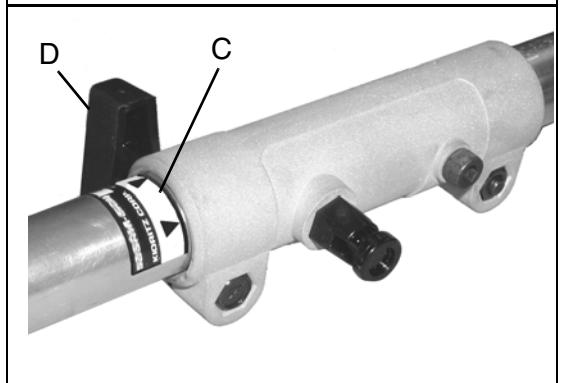

Fender/Wheel Assembly Adjustment

Dethatcher combing efficiency is best when the full weight of the dethatcher assembly rests on the tines during operation. Wheel height should be adjusted for 6 - 13 mm (0.25 - 0.50 in.) above ground for operational stability over uneven grass. Perform wheel height adjustment procedures as follows:

1. Loosen (2) two lower hex head wheel bracket bolts (B).
2. Hold unit in comfortable operating position on a flat surface and check for wheel to ground clearance of 6 - 13 mm (0.25 - 0.50 in.).
3. Rotate wheels towards tines to reduce ground clearance; away from tines to increase ground clearance. Tighten bolts (B).

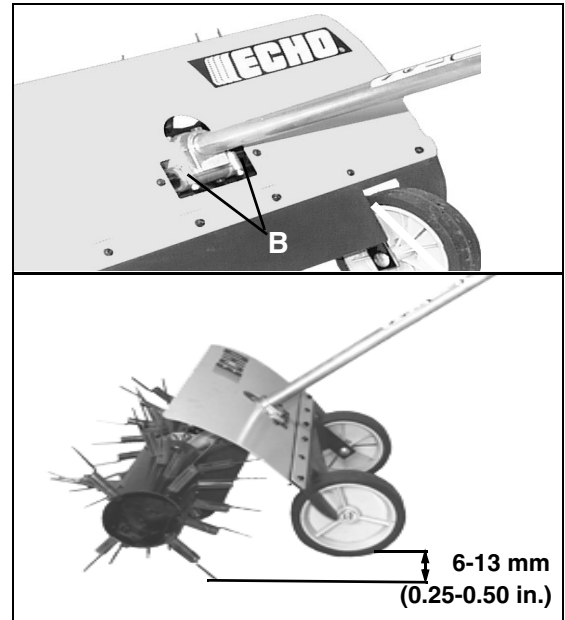

NOTICE

Do not rotate wheels against tines. Wheels and tines will be damaged during operation.

If wheel rotation is not sufficient to provide proper wheel height clearance then perform these additional steps:

4. Loosen two upper wheel bracket bolts (C).
5. Slide fender/wheel assembly up drive shaft housing until proper wheel clearance is achieved. Tighten hex head bolts (C).

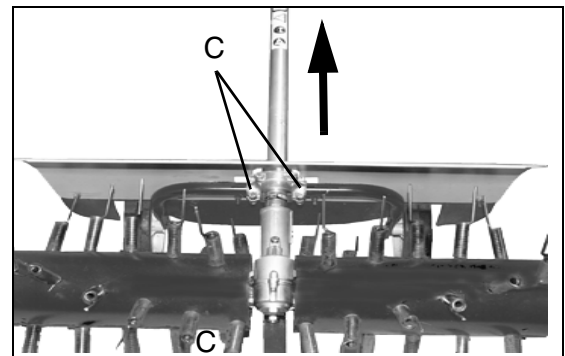

Front J-Handle Adjustment

1. Loosen two (2) J-Handle bracket bolts (A).
2. Rest dethatcher tines on flat surface. Stand to left side of drive shaft housing with right hand on throttle grip and left hand on J-Handle.
3. Move J-Handle up or down drive shaft housing for comfortable operating position. Tighten J-Handle bracket bolts (A).

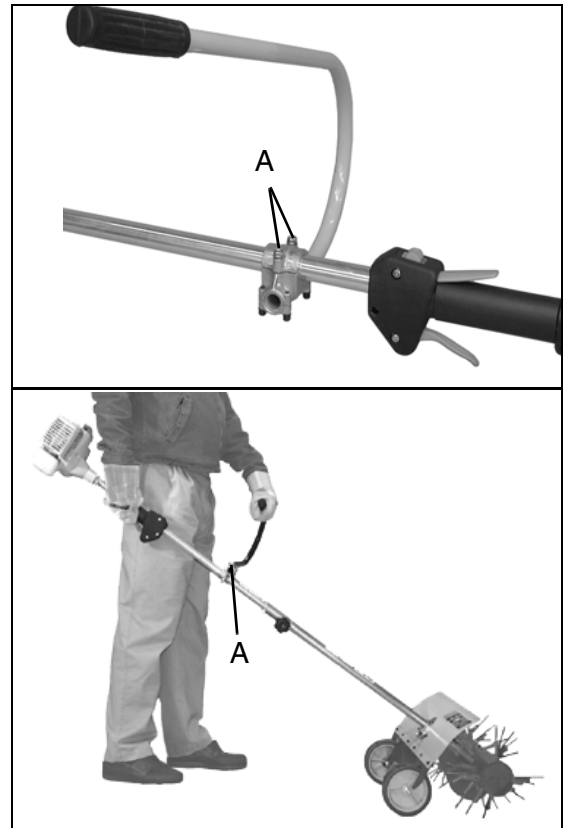

OPERATION

⚠ WARNING

Moving parts can amputate fingers or cause severe injuries. Keep hands, clothing and loose objects away from all openings. Always stop engine, disconnect spark plug, and make sure all moving parts have come to a complete stop before removing obstructions, clearing debris, or servicing unit. Allow unit to cool before performing service.

Note: Refer to your Pro Attachment Series or Split Boom Operator's Manuals for correct engine fueling, starting and stopping instructions.

Dethatching Information

Thatch is a normal buildup of grass and leaf clippings around the base of grass stems. Excessive thatch prevents air, water and nutrients from reaching the root system, increasing the probability of lawn disease from mold spore and insects. When excessive thatch is removed, air, water, nutrients and pesticides are allowed to keep your lawn healthy, promoting denser, greener grass. In most areas some thatch approximately 6-13 mm (0.25 - 0.50 in.) is healthy for soil water retention. Never remove all thatch from your lawn. Contact your local government agriculture agency for best dethatching practice for your lawn type and area.

Dethatching is recommended in early spring and late summer to allow grass to fill in low density areas of your lawn. Dethatching should also be performed at regular intervals throughout spring and summer.

Dethatching is not recommended for grasses that have above ground root systems such as St. Augustine, Floratam, Persley, or Zoysia varieties. The dethatcher tines will damage delicate interconnected root systems of these grass varieties.

Dethatching Operation

1. Operate dethatcher in straight rows changing direction from row to row as shown. If thatch is very dense a second dethatching operation may be required, and should be performed 90° to the original pattern to assure best results.
2. Hold unit in a comfortable position engage throttle trigger to full and allow dethatcher tines to "pull forward" over the ground. For heavy thatch removal gently pull back against dethatching rotation, to allow the tines to fully penetrate and remove thatch.

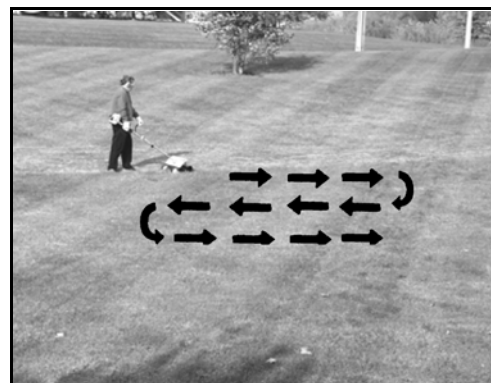

NOTICE

Do not remove grass guide attached to the gear housing to achieve deeper tine engagement. The guide prevents tines from penetrating too deeply into the ground which can cause the dethatcher to bounce during operation, and cause uneven thatch removal.

MAINTENANCE

⚠ WARNING

Moving parts can amputate fingers or cause severe injuries. Keep hands, clothing and loose objects away from all openings. Always stop engine, disconnect spark plug, and make sure all moving parts have come to a complete stop before removing obstructions, clearing debris, or servicing unit. Allow unit to cool before performing service. Wear gloves to protect hands from sharp edges and hot surfaces.

Your ECHO unit is designed to provide many hours of trouble free service. Regular scheduled maintenance will help your unit achieve that goal. If you are unsure or are not equipped with the necessary tools, you may want to take your unit to an ECHO Service Dealer for maintenance. To help you decide whether you want to DO-IT-YOURSELF or have the ECHO Dealer do it, each maintenance task has been graded. If the task is not listed, see your ECHO Dealer for repairs.

Skill Levels

Level 1 = Easy to do. Common tools may be required.

Level 2 = Moderate difficulty. Some specialized tools may be required.

ECHO offers **REPOWER™** Maintenance Kits and Parts to make your maintenance job easier.

Maintenance Intervals

COMPONENT/SYSTEM	MAINTENANCE PROCEDURE	SKILL LEVEL	Interval
Drive Shaft	Grease	1	Every 25 hours of use [1]
Gear Housing	Grease	1	Every 25 hours of use [2]
Tines	Inspect/Tighten/Replace	1	Before Each Use
Screws/Nuts/Bolts	Inspect/Tighten/Replace	1	Before Each Use

IMPORTANT - Time intervals shown are maximum. Actual use and your experience will determine the frequency of required maintenance.

[1] Apply POWER BLENDX™ grease.

[2] Apply Lithium-based EP00 Grease every 25 hours of use

Lubrication

Level 1.

Parts Required: Lithium-based EP00 Grease for gearcase; POWER BLENDX™ 8 oz. or Lithium Base Grease for driveshaft



Gear Housing

1. Clean all loose debris from gear box.
2. Remove plug (A) and check level of grease.
3. Add grease if necessary, DO NOT over-fill.
4. Install screw plug (A).

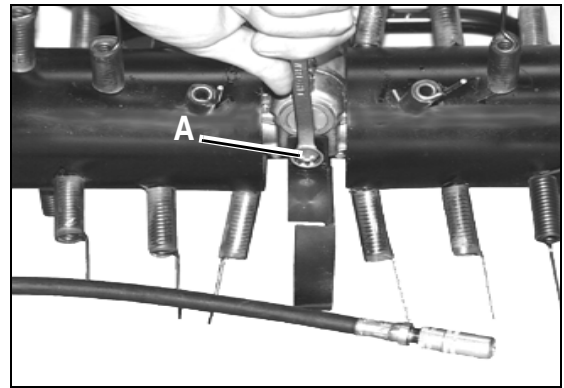

Drive Shaft

1. Remove gear housing locator screw (A).
2. Loosen gear housing mounting bolt (B).
3. Pull gear box from drive shaft housing.
4. Pull flexible cable from the drive shaft housing, wipe clean and re-coat with a thin coating [15 ml (1/2 oz.)] of grease.
5. Slide the flexible cable back in the drive housing. DO NOT get dirt on the flex cable.
6. Position lower drive shaft (end without safety decal) into gear housing shaft mount.
7. Align hole in drive shaft housing with gear housing shaft hole (C), and seat lower drive shaft end into gear housing shaft mount. Install and tighten locator screw (A).
8. Tighten gear housing mounting bolt (B).

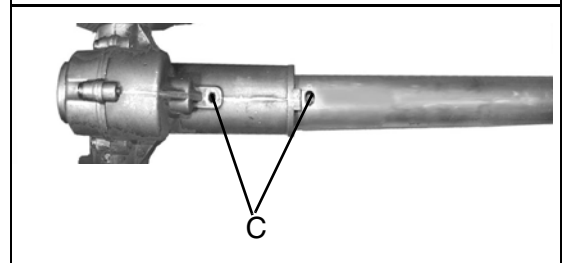
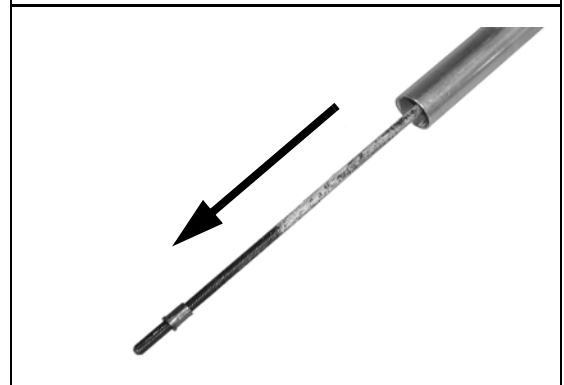
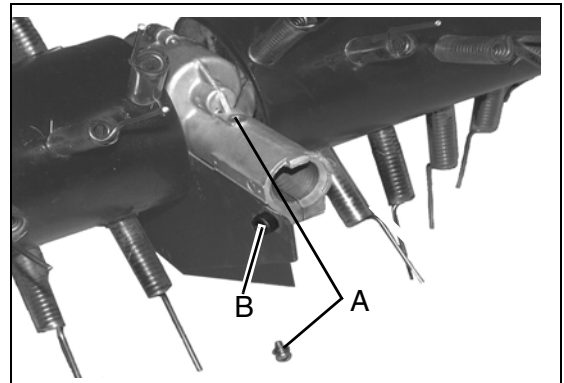

Tine Replacement

Level 2.

Parts Required: Thatching spring (P/N 61004725560),
Screw (P/N 88995325560), plastic tube
(P/N 21001325560)

Bent or broken tines should be replaced before operation for best dethatching efficiency.

⚠ WARNING

Never replace tines with engine running. Tines are sharp, wear gloves to protect your hands when replacing them.

(Outer five (5) rows from open reel end)

1. Hold inner tine mounting bolt from turning with 13 mm wrench inserted through open reel end.
2. Grip plastic sleeve at the base of the tine firmly with vice grip. Remove tine from bolt turning tine counter clockwise. Remove bolt.
3. Insert new bolt with star washer through reel mounting hole.

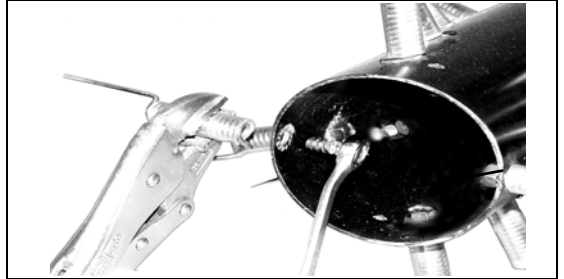
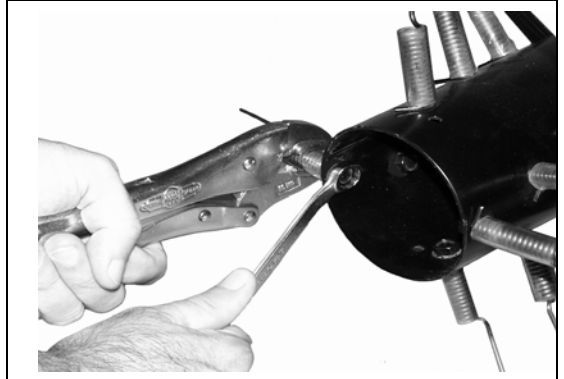
**NOTICE**

Star washer must be assembled on tine mounting bolt, otherwise bolt and tine will loosen on the reel.

4. Install tine onto bolt turning tine clockwise with vice grip. Tighten securely.

(Inside tine nearest gear housing)

5. Disconnect dethatcher attachment from Power Head/Shaft.
6. Rotate flex cable (C) mounted in the dethatcher assembly drive shaft housing. Turn flex cable end until front dethatcher gear housing to reel end clearance is achieved for tine bolt head access with 13 mm wrench. (See photo at right.)
7. Replace tines following steps 1 - 4 above.
8. Connect dethatcher attachment to Power Head/Shaft.

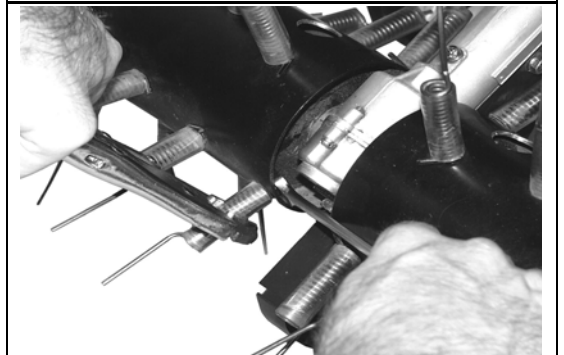
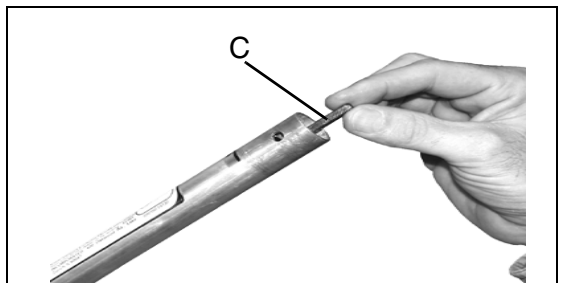

STORAGE

1. Clean dethatcher attachment with a bristle brush and rinse with clear water.

NOTICE

Do not immerse this attachment in water. Water will enter gear housing and damage gears, bearings and seals.

2. Apply thin coating of oil to metal parts to prevent rust.
3. Lubricate lower shaft assembly with grease. (Refer to Lubrication instructions.)
4. Store ProThatch Attachment in a dry place out of reach of children with lower shaft housing in a horizontal or vertical position to prevent grease loss from open shaft end.

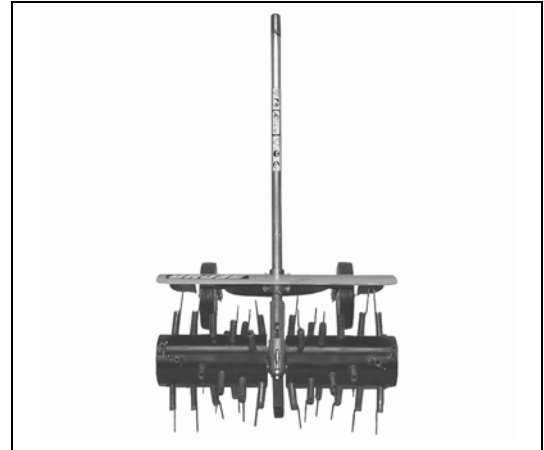

SPECIFICATIONS

MODEL	99944200563
Shaft Length	928 mm (36.5 in.)
Attachment Width	565 mm (22.2 in.)
Attachment Height	403 mm (15.9 in.)
Weight	9.6 kg (21.14 lb.)
Drive Shaft	6.35 mm (1/4 in.)
Direction of Rotation	Away from the operator viewed from the rear
DeThatcher Head	Left and right reels mounting 22 tines each, totaling 44 tines
Tines	3 mm (.19 in.) spring steel
Combing Width	571 mm (22.5 in.)
Lubrication	Lithium Base Grease
Gear Reduction Ratio	42.75 : 1
Dethatcher Operating	210 RPM
Engine Wide Open Throttle w/attachment	7,700-8,500 RPM

WARRANTY STATEMENTS

ECHO LIMITED WARRANTY STATEMENT FOR PRODUCT SOLD IN USA AND CANADA BEGINNING 01/01/2010

ECHO'S RESPONSIBILITY

ECHO Incorporated's Limited Warranty, provides to the original purchaser that this ECHO product is free from defects in material and workmanship. Under normal use and maintenance from date of purchase, ECHO agrees to repair or replace at ECHO's discretion, any defective product free of charge at any authorized ECHO servicing dealer within listed below application time periods, limitations and exclusions. **THIS LIMITED WARRANTY IS ONLY APPLICABLE TO ECHO PRODUCTS SOLD BY AUTHORIZED ECHO DEALERS. IT IS EXTENDED TO THE ORIGINAL PURCHASER ONLY, AND IS NOT TRANSFERABLE TO SUBSEQUENT OWNERS EXCEPT FOR EMISSION RELATED PARTS.** Repair parts and accessories replaced under this warranty are warranted only for the balance of the original unit or accessory warranty period. Any damage caused by improper installation or improper maintenance is not covered by this warranty. All parts or products replaced under warranty become the property of ECHO, Inc. This warranty is separate from the Emission control warranty statement supplied with your new product. Please consult the Emission Control Warranty Statement for details regarding emission related parts. For a list of Authorized ECHO Dealers refer to WWW.ECHO-USA.COM or call 1-800-432-ECHO.

OWNER'S RESPONSIBILITY

To ensure trouble free warranty coverage it is important that you register your ECHO equipment on-line at WWW.ECHO-USA.COM or by filling out the warranty registration card supplied with your unit. Registering your product confirms your warranty coverage and provides a direct link if we find it necessary to contact you.

The owner shall demonstrate reasonable care and use, and follow preventative maintenance, storage, fuel and oil usage as prescribed in the operator's manual. Should a product difficulty occur, you must, at your expense, deliver or ship your ECHO unit to an authorized ECHO servicing dealer for warranty repairs (within the applicable warranty period), and arrange for pick-up or return of your unit after the repairs have been made. For your nearest authorized ECHO servicing dealer, call ECHO's Dealer Referral Center, at 1-800-432-ECHO or you can locate an ECHO servicing dealer at WWW.ECHO-USA.COM. Should you require assistance or have questions concerning ECHO's Warranty Statement, you can contact our Consumer Product Support Department at 1-800-673-1558 or contact us through the web at WWW.ECHO-USA.COM.

PRODUCT WARRANTY PERIOD

RESIDENTIAL APPLICATION

- **5 YEAR WARRANTY** - All units for residential, or non-income producing use will be covered by this limited warranty for **five (5) years** from date of purchase.

EXCEPTIONS:

- For two-stroke engine powered products, the electronic ignition module, flexible drive cables, SRM solid drive shafts, and TC tines are warranted for the **life*** of the product on parts only.
- Cutting attachments such as, but not limited to, bars, chains, sprockets, blades, and nylon trimmer heads for residential or non-income producing use will be covered for failures due to defects in material or workmanship for a period of **60 days** from original product purchase date. Any misuse from contact with concrete, rocks, or other structures is not covered by this warranty.
- ECHO's Rapid Loader String Head carries a lifetime warranty on the line locking system, parts only; no labor. Refer to your operator's manual for string head installation and maintenance instructions.
- All SB-Series and PRO ATTACHMENT SERIES Split Shaft attachments carry the same warranty duration as the units they are designed to fit.

COMMERCIAL APPLICATION

- **1 YEAR WARRANTY** - All Chain Saws, QuikVent Saws, and Cut-Off Saws for commercial, institutional, agricultural, industrial, or income producing use will be covered by this limited warranty for one **(1) year** from the date of purchase.
- **2 YEAR WARRANTY** - All other units for commercial, institutional, agricultural, industrial, or income producing use will be covered by this limited warranty for two **(2) years** from the date of purchase.

EXCEPTIONS:

- For two-stroke engine powered products, the electronic ignition module, flexible drive cables, SRM solid drive shafts and TC tines, are warranted for the **life*** of the product on parts only.
- Cutting attachments such as, but not limited to, bars, chains, sprockets, blades, and nylon trimmer heads for commercial, institutional, agricultural, industrial, rental, or income producing will be covered for failures due to defects in material or workmanship for a period of **30 days** from original product purchase date. Any misuse from contact with concrete, rocks, or other structures is not covered by this warranty.
- ECHO's Rapid Loader String Head carries a lifetime warranty on the line locking system, parts only; no labor. Refer to your operator's manual for string head installation and maintenance instructions.
- All SB-Series and PRO ATTACHMENT SERIES Split Shaft attachments carry the same warranty duration as the units they are designed to fit.

RENTAL APPLICATION - 90 DAYS WARRANTY

- Units for rental use will be covered against defects in material and workmanship for a period of 90 days from the date of purchase.

* ECHO's liability under the "Lifetime" coverage is limited to furnishing parts specified under the PRODUCT WARRANTY PERIOD section of this warranty statement for "Life" free of charge for a period of ten (10) years after the date of the complete unit's final production.

PURCHASED REPAIR PARTS, SHORT BLOCKS AND ACCESSORIES

- 90-day residential, or non-income producing warranty
- 30-day commercial, institutional, agricultural, industrial, income producing, or rental application warranty

ATTENTION TWO-STROKE ENGINE POWER PRODUCT OWNERS

This ECHO two-stroke engine power product is a quality-engineered unit which has been manufactured to exact tolerances to provide superior performance. To help ensure the performance of the unit, it is required to use two-stroke oil which meets the ISO-L-EGD Standard per ISO/CD 13738 and JASO M345FD Standards. **ECHO Power Blend™ Two-Stroke Oil** is a premium two-stroke oil specifically formulated to meet ISO-L-EGD (ISO/CD 13738) and JASO M345FD Standards. The use of two-stroke oils designed for other applications, such as for outboard motors or lawnmowers can result in severe engine damage, and will void your two-stroke engine limited warranty.

THIS WARRANTY DOES NOT COVER DAMAGE CAUSED BY:

- Lack of lubrication or engine failure, due to the use of two-stroke oils that do not meet the ISO-L-EGD (ISO/CD 13738) and JASO M345FD Standards. Engine problems due to inadequate lubrication caused by failure to use an ISO-L-EGD compliant and JASO M345FD registered oil, will void the two-stroke engine limited warranty. **ECHO Power Blend™ Two-Stroke Oil** meets the ISO-L-EGD and JASO M345FD Standard. Emission related parts are covered for 5 years residential use or 2 years commercial use regardless of two-stroke oil used, per the statement listed in the EPA or California Emission Defect Warranty Explanation.
- Damage caused by use of gasohol, containing methanol (wood alcohol), or gasoline containing less than 89 octane. Only use gasoline which contains 89 octane or higher. Gasohol which contains a **maximum** 10% ethanol (grain alcohol) or 15% MTBE (methyl/tertiary/butyl/ether) is also approved. The prescribed mixing ratio of gasoline to oil is listed on the ECHO oil label and covered in your operator's manual.
- Engine damage caused by use of ether or any starting fluids.
- Damage caused by tampering with engine speed governor or emission components, or running engines above specified and recommended engine speeds as listed in your operator's manual.
- Operation of the unit with improperly maintained/removed cutting shield or removed/damaged air filter.
- Damage caused by dirt, pressure or steam cleaning the unit, salt water, corrosion, rust, varnish, abrasives, and moisture.
- Defects, malfunctions or failures resulting from abuse, misuse, neglect, modifications, alterations, normal wear, improper servicing, or use of unauthorized attachments.
- Incorrect storage procedures, stale fuel, including failure to provide or perform required maintenance services as prescribed in the operator's manual. Preventative maintenance as outlined in the operators manual is the customer's responsibility.
- Failures due to improper set-up, pre-delivery service or repair service by anyone other than authorized ECHO servicing dealer during the warranty period.
- Certain parts and other items are not warranted, including but not limited to: lubricants, starter cords, and engine tune-ups.
- Use of spark plugs other than those meeting performance and durability requirements of the OEM spark plug listed in the Operator's Manuals.
- Overheating or carbon scoring failures due to restricted, clogged exhaust port or combustion chamber, including damage to spark arrester screen.
- Adjustments after the first (30) thirty days and beyond, such as carburetor adjustment and throttle cable adjustment.
- Damage to gears or gear cases caused by contaminated grease or oil, use of incorrect type or viscosity of lubricants, and/or failure to comply with recommended grease or oil change intervals.
- Damage caused by loading SHRED 'N' VAC® beyond recommended capacity.
- Damage caused by pump or sprayer running dry, pumping or spraying caustic or flammable materials, or lack of or broken strainers.
- Additional damage to parts or components due to continued use after operational problem or failure occurs. Should operational problem or failure occur, the product should not be used, but delivered as is to an authorized ECHO servicing dealer.

It is a dealer's and/or customer's responsibility to complete and return the warranty registration card supplied with your ECHO product or by visiting WWW.ECHO-USA.COM. Your receipt of purchase including date, model and serial number must be maintained and presented to an authorized ECHO servicing dealer for warranty service. Proof of purchase rests solely with the customer. Some states do not allow limitations on how long an implied warranty lasts, so the above limitations may not apply to you. Some states do not allow the exclusion or limitation of incidental or consequential damages, so you may also have other specific legal rights which vary from state to state. This limited warranty is given by ECHO Incorporated, 400 Oakwood Rd., Lake Zurich, IL 60047.

DISCLAIMER OF IMPLIED WARRANTIES

This limited warranty is in lieu of all other expressed or implied warranties, including any warranty of FITNESS FOR A PARTICULAR PURPOSE OR USE and any implied warranty of **MERCHANTABILITY** otherwise applicable to this product. ECHO and its affiliated companies shall not be liable for any special incidental or consequential damage, including lost profits. There are no warranties extended other than as provided herein. This limited warranty may be modified only by ECHO.

99922201032
11/18/2011



ECHO, INCORPORATED

400 Oakwood Road

Lake Zurich, IL 60047

www.echo-usa.com

S08300001001/S08300999999