



# Pro Attachment Series™

## *Operator's Manual*

**MODEL**

**PAS-225 Value Pack**

**WARNING**  **DANGER**



The muffler or catalytic muffler and surrounding cover may become extremely hot.



Always keep clear of exhaust and muffler area, otherwise serious personal injury may occur.



**WARNING**



The engine exhaust from this product contains chemicals known to the State of California to cause cancer, birth defects or other reproductive harm.



**WARNING**

Read rules for safe operation and instructions carefully. ECHO provides an Operator's Manual and Safety Manual with this unit and a separate Operator's Manual with the attachment. All manuals must be read and understood for proper and safe operation. Failure to do so could result in serious injury.

## INTRODUCTION

Welcome to the ECHO family. This ECHO product was designed and manufactured to provide long life and on-the-job-dependability. Read and understand this manual as well as your attachment operator's manual and SAFETY MANUAL before operation. You will find these manuals easy to read and full of helpful operating tips and SAFETY messages.

## THE OPERATOR'S MANUAL

Read and understand this manual before operation. Keep it in a safe place for future reference. It contains specifications and information for operation, starting, stopping, maintenance, storage, and assembly specific to this product.

## THE ATTACHMENT OPERATOR'S MANUAL

Read and understand this manual before operation. Keep it in a safe place for future reference. It contains specifications and information for operation and maintenance specific to the attachment.

## THE SAFETY MANUAL

Explains possible hazards and what measures you should take to insure safe operation.

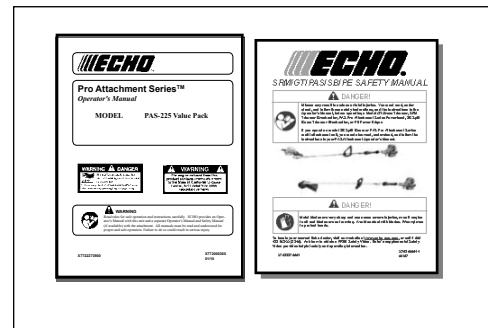

## TABLE OF CONTENTS

Introduction.....	2	Maintenance.....	19
- The Operator's Manual.....	2	- Skill Levels.....	19
- The Safety manual.....	2	- Maintenance Intervals.....	20
Safety.....	3	- Air Filter.....	20
- Manual Safety Symbols & Important Information.....	3	- Fuel Filter.....	21
- International Symbols.....	3	- Spark Plug.....	21
- Personal Condition and Safety Equipment.....	4	- Cooling System Cleaning.....	22
- Equipment.....	6	- Exhaust System.....	23
Emission Control.....	6	- Carburetor Adjustment.....	24
Description.....	7	- High Altitude Operation.....	24
Contents.....	9	- Lubrication.....	25
Assembly.....	9	- Nylon Line Replacement.....	26
- Power Head Shaft / Lower Shaft Assembly.....	9	- Sharpening Metal Blades.....	28
- Plastic Shield Installation.....	10	Troubleshooting.....	29
- Nylon line head installation.....	11	Storage.....	30
- To advance trimmer line.....	11	Specifications.....	31
- Nylon line replacement.....	11	- ECHO Approved Optional Equipment.....	32
- Remove nylon line head.....	11	- Recommended Optional Attachments.....	32
- Front Handle Installation.....	12	Warranty Statements.....	33
Operation.....	12	Servicing Information.....	36
- Trimmer Operation with Blades.....	13	- Parts.....	36
- Operating Blower.....	15	- Service.....	36
- Fuel.....	16	- ECHO Consumer Product Support.....	36
- Starting Cold Engine.....	17	- Warranty Card.....	36
- Starting Warm Engine.....	18	- Additional or Replacement Manuals.....	36
- Stopping Engine.....	19		

Specifications, descriptions and illustrative material in this literature are as accurate as known at the time of publication, but are subject to change without notice. Illustrations may include optional equipment and accessories, and may not include all standard equipment.

## SAFETY

### MANUAL SAFETY SYMBOLS AND IMPORTANT INFORMATION

Throughout this manual and on the product itself, you will find safety alerts and helpful, informational messages preceded by symbols or key words. The following is an explanation of those symbols and key words and what they mean to you.



#### DANGER

The safety alert symbol accompanied by the word "DANGER" calls attention to an act or condition which WILL lead to serious personal injury or death if not avoided.



#### WARNING

The safety alert symbol accompanied by the word "WARNING" calls attention to an act or condition which CAN lead to serious personal injury or death if not avoided.



#### CAUTION

The safety alert symbol accompanied by the word "CAUTION" calls attention to an act or condition which may lead to minor or moderate personal injury if not avoided.



#### CIRCLE AND SLASH SYMBOL

This symbol means the specific action shown is prohibited. Ignoring these prohibitions can result in serious or fatal injury.

#### NOTE

This enclosed message provides tips for use, care and maintenance of the unit.

#### IMPORTANT

The enclosed message provides information necessary for the protection of the unit.

## INTERNATIONAL SYMBOLS

SYMBOL	DESCRIPTION	SYMBOL	DESCRIPTION
	"WARNING, SEE OPERATOR'S MANUAL"		Hot Surface
	Wear eye, ear and head protection		Rotating Cutting Attachment
	Wear hand and foot protection		DO NOT allow flames or sparks near fuel.
	Safety/Alert		DO NOT smoke near fuel.
		Keep bystanders and helpers away 15 m (50 ft.).	
		Guaranteed sound power level	

SYMBOL	DESCRIPTION	SYMBOL	DESCRIPTION
	Emergency Stop		Fuel and oil mixture
	Carburetor Adjustment - High speed mixture		Primer Bulb
	Carburetor Adjustment - Idle speed		Ignition ON/OFF
	Carburetor Adjustment - Low speed mixture		Do not use blades. String line only
	Choke Control "Run" Position (Choke Open)		Choke Control "Cold Start" Position (Choke Closed)

## PERSONAL CONDITION AND SAFETY EQUIPMENT



### **WARNING**

Users of this product risk injury to themselves and others if the unit is used improperly and/or safety precautions are not followed. Proper clothing and safety gear must be worn when operating unit.

### ***Physical Condition***

Your judgment and physical dexterity may not be good:

- if you are tired or sick,
- if you are taking medication,
- if you have taken alcohol or drugs.

Operate unit only if you are physically and mentally well.

### ***Eye Protection***

Wear eye protection that meets ANSI Z87.1 or CE requirements whenever you operate the unit.

### ***Hand Protection***

Wear no-slip, heavy-duty work gloves to improve your grip on the handle. Gloves also reduce the transmission of machine vibration to your hands.

### ***Hearing Protection***

ECHO recommends wearing hearing protection whenever unit is used.

### ***Proper Clothing***

Wear snug fitting, durable clothing;

- Pants should have long legs, shirts with long sleeves.
- **DO NOT WEAR SHORTS,**
- **DO NOT WEAR TIES, SCARVES, JEWELRY,** or clothing with loose or hanging items that could become entangled in moving parts or surrounding growth.

Wear sturdy work shoes with nonskid soles;

- **DO NOT WEAR OPEN TOED SHOES,**
- **DO NOT OPERATE UNIT BAREFOOTED.**

Wear no-slip, heavy duty work gloves.

Keep long hair away from engine and air intake. Retain hair with cap or net.

### ***Hot Humid Weather***

Heavy protective clothing can increase operator fatigue which may lead to heat stroke. Schedule heavy work for early morning or late afternoon hours when temperatures are cooler.



### **WARNING**

The ignition components of this machine generate an electromagnetic field during operation which may interfere with some pacemakers. To reduce the risk of serious or fatal injury, persons with pacemakers should consult with their physician and the pacemaker manufacturer before operating this machine. In the absence of such information, ECHO does not recommend the use of ECHO products by anyone who has a pacemaker.

### ***Extended Operation/Extreme Conditions***

It is believed that a condition called Raynaud's Phenomenon, which affects the fingers of certain individuals, may be brought about by exposure to vibration and cold. Exposure to vibration and cold may cause tingling and burning sensations, followed by loss of color and numbness in the fingers. The following precautions are strongly recommended, because the minimum exposure, which might trigger the ailment, is unknown.

- Keep your body warm, especially the head, neck, feet, ankles, hands, and wrists.
- Maintain good blood circulation by performing vigorous arm exercises during frequent work breaks, and also by not smoking.
- Limit the hours of operation. Try to fill each day with jobs where operating the unit or other hand-held power equipment is not required.
- If you experience discomfort, redness, and swelling of the fingers followed by whitening and loss of feeling, consult your physician before further exposing yourself to cold and vibration.



***Repetitive Stress Injuries***

It is believed that overusing the muscles and tendons of the fingers, hands, arms, and shoulders may cause soreness, swelling, numbness, weakness, and extreme pain in those areas. Certain repetitive hand activities may put you at a high risk for developing a Repetitive Stress Injury (RSI). An extreme RSI condition is Carpal Tunnel Syndrome (CTS), which could occur when your wrist swells and squeezes a vital nerve that runs through the area. Some believe that prolonged exposure to vibration may contribute to CTS. CTS can cause severe pain for months or even years.

To reduce the risk of RSI/CTS, do the following:

- Avoid using your wrist in a bent, extended, or twisted position. Instead try to maintain a straight wrist position. Also, when grasping, use your whole hand, not just the thumb and index finger.
- Take periodic breaks to minimize repetition and rest your hands.
- Reduce the speed and force with which you do the repetitive movement.
- Do exercise to strengthen the hand and arm muscles.
- Immediately stop using all power equipment and consult a doctor if you feel tingling, numbness, or pain in the fingers, hands, wrists, or arms. The sooner RSI/CTS is diagnosed, the more likely permanent nerve and muscle damage can be prevented.

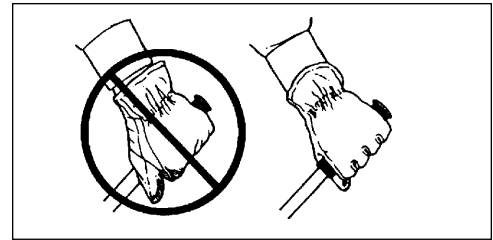

**DANGER**

Do not operate this product indoors or in inadequately ventilated areas. Engine exhaust contains poisonous emissions and can cause serious injury or death.

**Read the Manual**

- Provide all users of this equipment with the Operator's Manual for instructions on Safe Operation.

***Clear the Work Area***

- Spectators and fellow workers must be warned, and children and animals prevented from coming nearer than 15 m (50 ft.) while the unit is in use.
- Take wind conditions into account: avoid open doors and windows.
- Do not point blower at people or animals.
- Review area to be cleared. Look for potential hazards such as stones or metal objects.



**Keep a Firm Grip**

- Hold the front and rear handles with both hands, with thumbs and fingers encircling the handles.

**Keep a Solid Stance**

- Maintain footing and balance at all times. Do not stand on slippery, uneven or unstable surfaces. Do not work in odd positions or on ladders. Do not over reach.

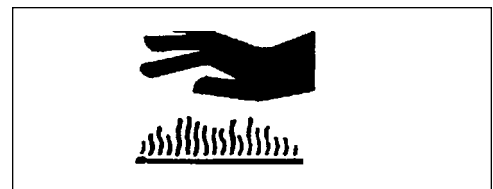

**Avoid Hot Surfaces**

- Keep exhaust area clear of flammable debris. Avoid contact during and immediately after operation.

## EQUIPMENT



### WARNING

Use only ECHO approved attachments. Serious injury may result from the use of a non-approved attachment combination. ECHO, INC. will not be responsible for the failure of cutting devices, attachments or accessories which have not been tested and approved by ECHO. Read and comply with all safety instructions listed in this manual and safety manual.

- Check unit for loose/missing nuts, bolts, and screws. Tighten and/or replace as needed.
- Inspect shield for damage and ensure that the cut-off knife is securely in place. Replace if either is damaged or missing.
- Check that the cutting attachment is firmly attached and in safe operating condition.



### WARNING

Moving parts can amputate fingers or cause severe injuries. Keep hands, clothing and loose objects away from all openings.

- **ALWAYS** stop engine, disconnect spark plug, and make sure all moving parts have come to a complete stop before removing obstructions, clearing debris, or servicing unit.
- **DO NOT** start or operate unit unless all guards and protective covers are properly assembled to unit.
- **NEVER** reach into any opening while the engine is running. Moving parts may not be visible through openings.



### WARNING

Check fuel system for leaks due to fuel tank damage, especially if the unit is dropped. If damage or leaks are found, do not use unit, otherwise serious personal injury or property damage may occur. Have unit repaired by an authorized servicing dealer before using.

## EMISSION CONTROL (EXHAUST & EVAPORATIVE)

### *EPA 2010 and Later and/or C.A.R.B. TIER III*

The emission control system for the engine is EM/TWC (Engine Modification and 3-way Catalyst) and for the fuel tank the Control System is EVAP (Evaporative Emissions) or N (for nylon tank). Evaporative emission may be applicable to California models only.

**EMISSION CONTROL INFORMATION**  
 ENGINE FAMILY: EHX0454KA DISPLACEMENT: 45.0cc  
 EMISSION COMPLIANCE PERIOD = 300 HOURS  
 THIS ENGINE MEETS U.S. EPA EXH/EVP REGS FOR MODEL YEAR 2010-2014  
 REFER TO OWNER'S MANUAL FOR MAINTENANCE SPECIFICATIONS AND ADJUSTMENTS.  
**YAMABIKO CORP.** [E] [\*\*\*]

**EMISSION CONTROL INFORMATION**  
 ENGINE FAMILY: EHX0214KG DISPLACEMENT: 21.2cc  
 EMISSION COMPLIANCE PERIOD = 300 HOURS  
 THIS ENGINE MEETS \*\*\*\* U.S. EPA EXH/EVP AND CALIFORNIA EXH AND EVP EMISSION REGULATIONS FOR S.O.R.E.  
 REFER TO OWNER'S MANUAL FOR MAINTENANCE SPECIFICATIONS AND ADJUSTMENTS.  
**YAMABIKO CORP.** [E] [\*\*\*\*]

An Emission Control Label is located on the engine. (This is an EXAMPLE ONLY, information on label varies by engine FAMILY).

### PRODUCT EMISSION DURABILITY (EMISSION COMPLIANCE PERIOD)

The 300 hour emission compliance period is the time span selected by the manufacturer certifying the engine emissions output meets applicable emissions regulations, provided that approved maintenance procedures are followed as listed in the Maintenance Section of this manual.

## DESCRIPTION

Locate these safety decals on your unit. Make sure the decals are legible and that you understand and follow the instructions on them. If a decal cannot be read, a new one can be ordered from your ECHO dealer. See PARTS ORDERING instructions for specific information.

### Hot Decal (near muffler)

P/N X505002130

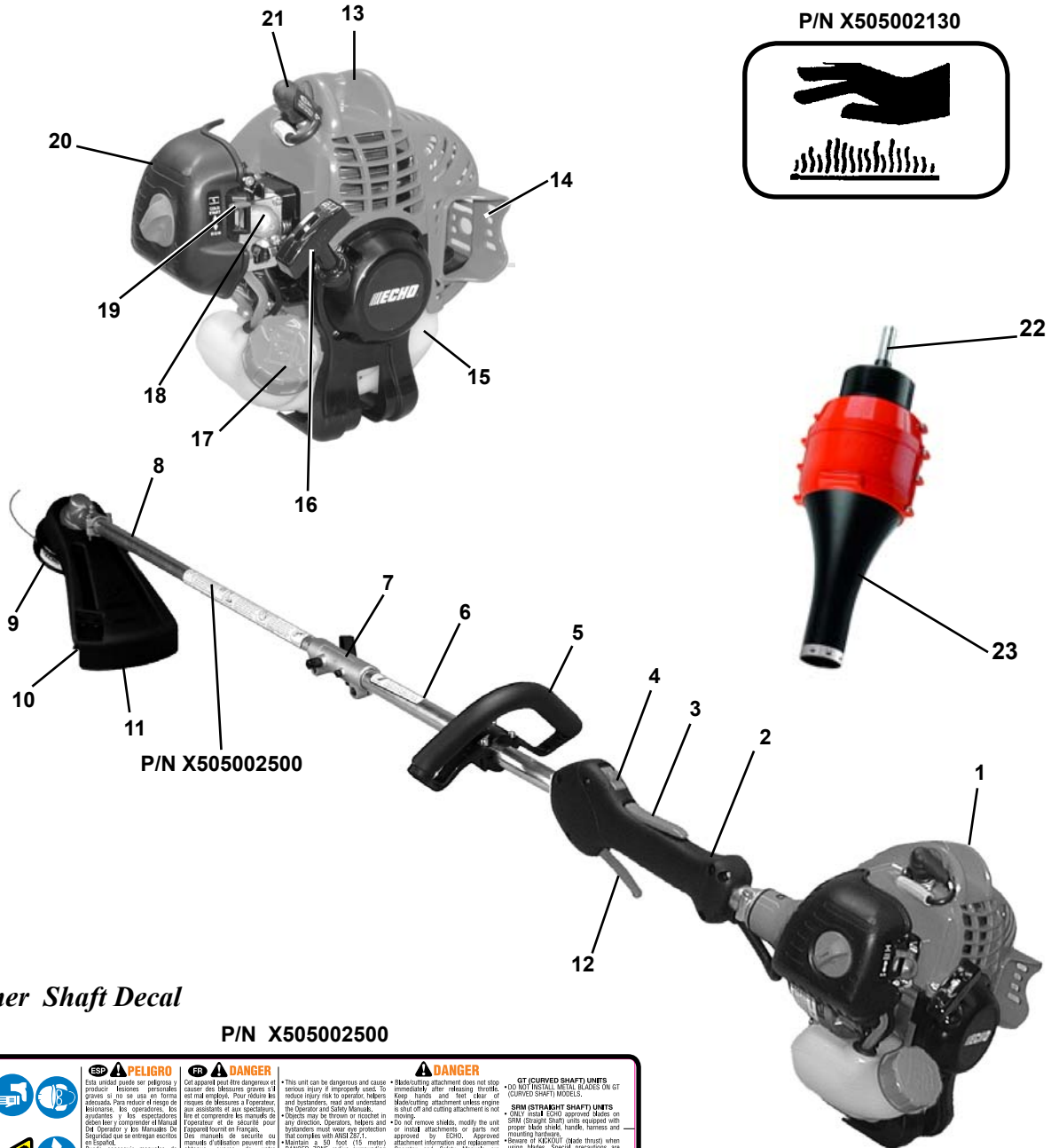
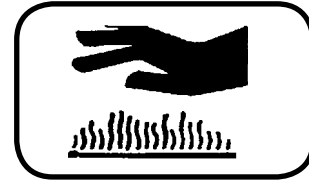

P/N X505002500

### Trimmer Shaft Decal

P/N X505002500

	<p><b>ESP PELIGRO</b> Esta unidad puede ser peligrosa y producir lesiones personales graves si no se usa en forma adecuada. Para reducir el riesgo de lesiones, los operadores, los asistentes, y los espectadores deben leer y comprender el Manual del Operador y los Manuales de Seguridad que se entregan escritos en español. Para obtener más información o manuales del operador o de asistencia, comuníquese con el distribuidor ECHO o el representante ECHO en su país. Visite <a href="http://www.echo-usa.com">www.echo-usa.com</a> o en ECHO Inc., 400 Oakwood Road, Lake Zurich, IL 60047 (800-873-5583), 60047 (800-873-5583).</p>	<p><b>FR DANGER</b> Cet appareil peut être dangereux et causer des blessures graves s'il est mal employé. Pour réduire les risques, les opérateurs, les assistants et les spectateurs, lire et comprendre les manuels de l'opérateur et de sécurité qui sont fournis écrits en français. Pour obtenir plus d'informations ou manuels d'utilisation, contactez votre distributeur ECHO ou votre représentant ECHO dans votre pays. Visitez <a href="http://www.echo-usa.com">www.echo-usa.com</a> ou contactez ECHO Inc., 400 Oakwood Road, Lake Zurich, IL 60047 (800-873-5583).</p>	<p><b>EN DANGER</b> This unit can be dangerous and cause serious injury if improperly used. To reduce injury risk to operator, helpers and bystanders, read and understand the Operator and Safety Manuals. Objects may be thrown or ejected in any direction. Operators, helpers and bystanders must wear eye protection (minimum 18 (1/2) meter). DANGER ZONE exists surrounding the operator. Only the operator should be within the DANGER ZONE. Always wear hearing protection gloves and sturdy work boots when operating unit.</p>	<p><b>ES DANGER</b> Blastcutting attachment does not stop immediately after releasing throttle. Keep hands and feet clear of blastcutting attachment unless engine is shut off and cutting attachment is not moving. Do not remove sticks, modify the unit or install attachments or parts not approved by ECHO. Approval necessary for any modification. Beware of KICKOUT (blade thrust) when using blades. Special precautions are necessary for blade operation; refer to the Operator and Safety Manuals. INSPECT BLADES BEFORE USE. DO NOT USE DAMAGED, CHOKED, SET, DULL OR IMPROPERLY SHARPENED BLADES.</p>	<p><b>GT (CURVED SHAFT) UNITS DO NOT INSTALL METAL BLADES ON GT (CURVED SHAFT) MODELS.</b> <b>ONLY INSTALL ECHO APPROVED BLADES ON STRAIGHT SHAFT UNITS EQUIPPED WITH PROPER KICK SHIELD, HANDLE, HARNESS AND MISSING PARTS.</b> Beware of KICKOUT (blade thrust) when using blades. Special precautions are necessary for blade operation; refer to the Operator and Safety Manuals. INSPECT BLADES BEFORE USE. DO NOT USE DAMAGED, CHOKED, SET, DULL OR IMPROPERLY SHARPENED BLADES.</p>
--	---	--	---	---	--

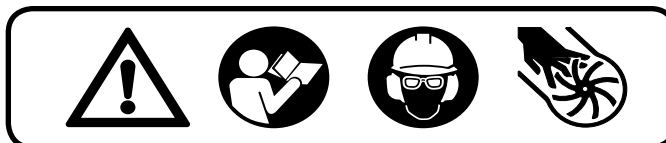

### General Warning Decal (located on blower housing)

P/N X505002080



P/N X505001930



1. **POWER HEAD** - Includes the Engine, Clutch, Fuel System, Ignition System and Recoil Starter.
2. **GRIP** - Rear (right hand) handle.
3. **THROTTLE TRIGGER LOCKOUT** - Operation of the throttle trigger is prevented unless throttle trigger lockout lever is engaged.
4. **STOP SWITCH** - "SLIDE SWITCH" mounted on top of the Throttle Trigger Housing. Move switch FORWARD to RUN, BACK to STOP.
5. **FRONT HANDLE** - The front (loop) handle must be assembled to the Upper Drive Shaft Assembly (some models) and must be positioned for proper cutting attitude and operator comfort.
6. **UPPER DRIVE SHAFT ASSEMBLY** - Includes the Rear (Right Hand) Grip Assembly, Front (Left Hand) Handle Assembly, Upper Flexible Drive Cable, Drive Shaft Assembly Coupler and Power Head.
7. **DRIVE SHAFT COUPLER** - Includes Locator Pin and Clamping Knob.
8. **LOWER DRIVE SHAFT ASSEMBLY** - Includes the Debris Shield Assembly, Gear Housing Assembly, Lower Flexible Drive Cable, Cutting Attachment, and Safety Decal.
9. **NYLON CUTTING ATTACHMENT** - Contains replaceable nylon trimming line that advances when the trimmer head is tapped against the ground while the head is turning at normal operating speed.
10. **CUT-OFF KNIFE** - Automatically trims line to the correct length: 5 in. after head is tapped on the ground. If trimmer is operated without a cut-off knife the line will become too long, the engine will overheat and engine damage may occur.
11. **PLASTIC DEBRIS SHIELD ASSEMBLY** - Included in plastic bag (co-pack). **MUST** be installed on unit before use, see Assembly Instructions. Shield assembly includes the Cut-Off Knife and Safety Decal. Mounts on the Gear Housing Assembly just above the cutting attachment. Helps protect the operator by deflecting debris produced during the trimming operation. This shield must be replaced with the steel shield for blade use.
12. **THROTTLE TRIGGER** - Spring loaded to return to idle when released. During acceleration, press trigger gradually for best operating technique.
13. **TOP GUARD** - Protects arm from the hot engine.
14. **SPARK ARRESTOR MUFFLER OR SPARK ARRESTOR MUFFLER WITH CATALYST** -The muffler or catalytic muffler controls exhaust noise and emission. The spark arrestor screen prevents hot, glowing particles of carbon from leaving the muffler. Keep exhaust area clear of flammable debris.
15. **FUEL TANK** - Contains fuel and fuel filter.
16. **I-30 RECOIL STARTER/HANDLE** - *i-30* spring-assisted recoil starter requires 30% less pulling force than standard recoil starter. Pull handle slowly until starter engages, then quickly and firmly. When engine starts, return handle slowly. DO NOT let handle snap back or damage to unit will occur.
17. **FUEL TANK CAP** - Covers and seals fuel tank opening.
18. **PURGE BULB** - Pumping purge bulb before starting engine draws fresh fuel from the fuel tank, purging air from the carburetor. Pump purge bulb
19. **CHOKE** - Adjusts Fuel/Air ratio for starting or running engine. The choke control is located at the top of the air filter case. Move choke lever to "Cold Start" () to close choke for cold starting. Move choke lever to "Run" () position to open choke.
20. **AIR CLEANER** - Contains replaceable filter element.
21. **SPARK PLUG** - Provides spark to ignite fuel mixture.
22. **DRIVE SHAFT ASSEMBLY** – Lightweight aluminum drive shaft. 2-position shaft design permits unit to be rotated in 180-degree steps.
- 2.3 **BLOWER PIPE** - Concentrates air stream.



## CONTENTS

After opening the carton, check for damage. Immediately notify your retailer or ECHO Dealer of damaged or missing parts. Use the contents list to check for missing parts.

- \_\_\_\_\_ 1 - Power Head w/Upper Drive Shaft Assembly
- \_\_\_\_\_ 1 - Lower Drive Shaft Assembly
- \_\_\_\_\_ 1 - Operator's Manual
- \_\_\_\_\_ 1 - Safety Manual
- \_\_\_\_\_ 1 - Warranty Registration Card
- \_\_\_\_\_ 1 - Plastic shield
- \_\_\_\_\_ 1 - Shield plate
- \_\_\_\_\_ 3 - 5 mm x 16 mm screws (shield mounting)
- \_\_\_\_\_ 1 - Nylon Trimmer Head
  - Assembly Tool (s)
- \_\_\_\_\_ 1 - Safety Glasses
- \_\_\_\_\_ 1 - Echo Power BlendX™ 2-stroke oil sample
- \_\_\_\_\_ 1 - Power Blower Attachment
- \_\_\_\_\_ 1 - Storage Hook Assembly

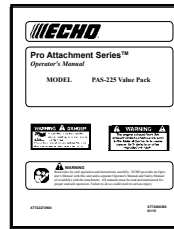

## ASSEMBLY

### POWER HEAD SHAFT/LOWER SHAFT ASSEMBLY

*Parts Required:* Trimmer or Power Blower Attachment Assembly

1. Set Power Head/Shaft Assembly on a level surface.
2. Pull locator pin (A) out, and turn counter-clockwise 1/4 turn to lock-out position.
3. Remove vinyl cap from attachment drive shaft.
4. Remove cardboard spacer, if necessary.

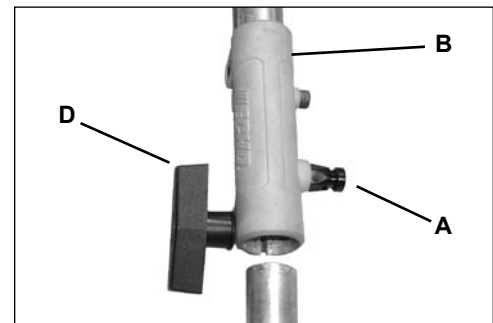

- Carefully fit attachment drive shaft assembly into coupler (B) to decal assembly line (C), making sure that the inner lower drive shaft engages the square upper drive shaft socket.

**NOTE**

Lower bearing housing and head assembly must be in line with the engine.

- Rotate locator pin (A) 1/4 turn clockwise to engage lower shaft hole. Insure locator pin is fully engaged by twisting lower drive shaft. Locator pin should snap flush in coupler. Full engagement will prevent further shaft rotation.
- Secure lower shaft assembly to coupler by tightening clamping knob (D).

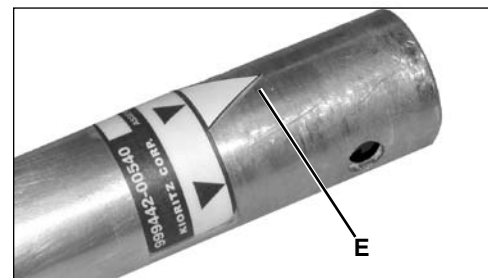
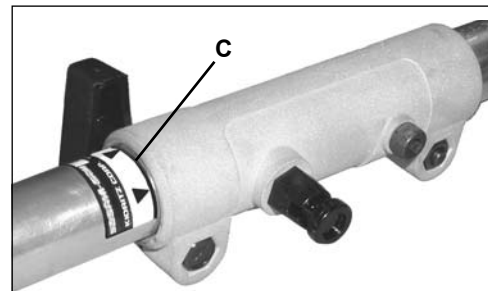
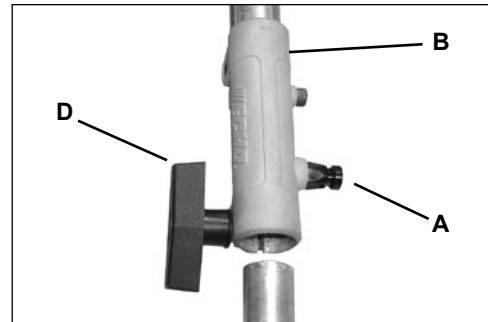

## PLASTIC SHIELD INSTALLATION (for Nylon Line Operation)

*Parts Required:* Plastic Shield, Shield Plate, three (3) 5mm x 16mm screws.

**NOTE**

The plastic shield is for use with the Nylon Line Head only. Install Metal Shield when using plastic or metal blades.

- Remove plastic threaded shaft sleeve and adapter plate (C) from PTO shaft (A).
- Place the shield on the bottom of the bearing housing flange.
- Place shield plate (B) on shield, align holes. Install three (3) screws from bottom through plate and shield into gear case.
- Assemble adapter plate (C) onto PTO shaft.

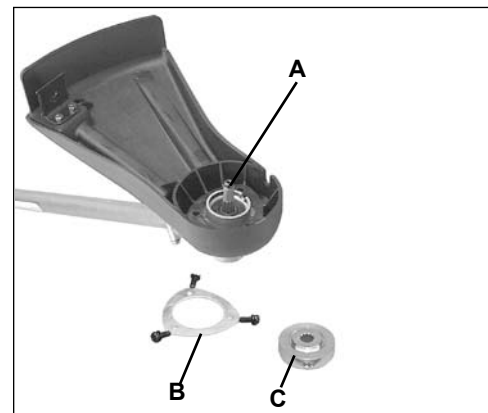

## NYLON LINE HEAD INSTALLATION

Parts Required: Nylon Line Head.

### **Caution**

- Wear Gloves or personal injury may result:
- Cutoff knife is sharp.
  - Gearcase and surrounding area may be hot.

1. Be sure adapter plate (C) remains on PTO shaft (A).
2. Align locking hole in upper plate with notch in edge of gear housing and insert head locking tool (D).
3. Thread line head (E) onto shaft by turning it counter-clockwise until head is tight against adapter plate (C).
4. Remove locking tool (D).

### **IMPORTANT**

Semi-automatic nylon line heads must be used only with plastic debris shield with cut-off knife. Using nylon line heads with metal debris shield can result in trimmer damage, caused by operation with excessive line length.

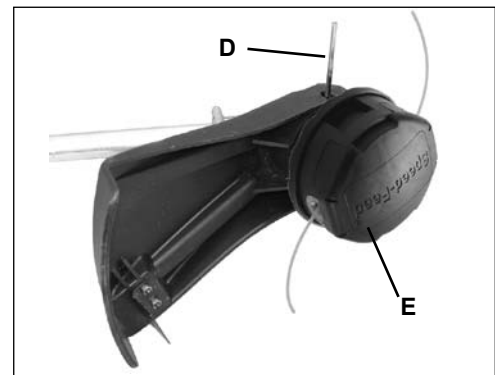
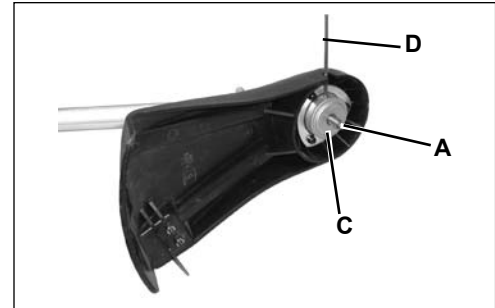

## TO ADVANCE TRIMMER LINE

See Maintenance Section for nylon line replacement.

### **Tip:**

To advance trimmer line, tap trimmer head against the ground while the head is turning at normal operating speed.

### **IMPORTANT**

When the wear indicators located at the bottom of the Speed-Feed head are worn smooth, replacement of the cover or the entire Speed-Feed head is required.

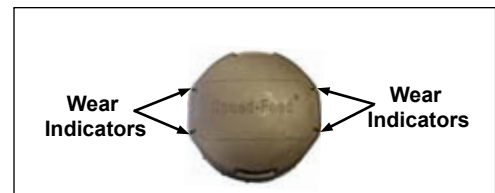

## REMOVE NYLON LINE HEAD

### **NOTE**

Do not disassemble nylon line head.

1. Align locking hole in upper plate with notch in edge of gear housing and insert head locking tool (D).
2. Remove line head (E) by turning it clockwise until head is completely off of shaft.
3. Remove locking tool (D).

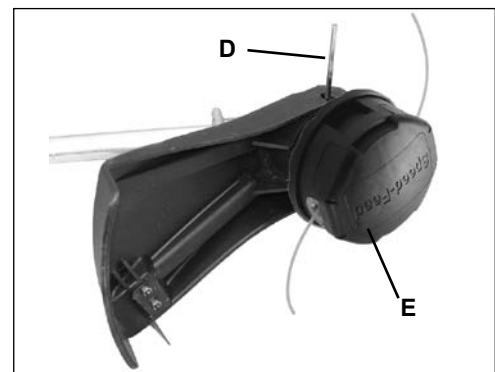

## FRONT HANDLE INSTALLATION

### NOTE

Label shows minimum spacing for front handle location.

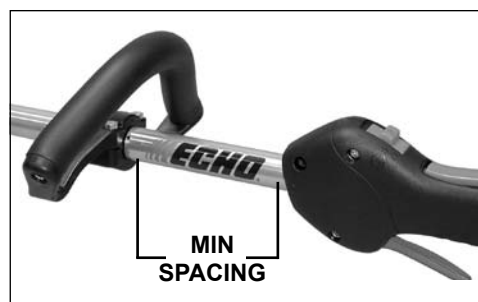

1. Position front handle for comfortable operation and secure screws.

## OPERATION



### WARNING

Moving parts can amputate fingers or cause severe injuries. Keep hands, clothing and loose objects away from all openings. Always stop engine, disconnect spark plug, and make sure all moving parts have come to a complete stop before removing obstructions, clearing debris, or servicing unit. Allow unit to cool before performing service. Wear gloves to protect hands from sharp edges and hot surfaces.



### WARNING

Engine exhaust IS HOT, and contains Carbon Monoxide (CO), a poison gas. Breathing CO can cause unconsciousness, serious injury, or death. Exhaust can cause serious burns. ALWAYS position unit so that exhaust is directed away from your face and body.



### WARNING

Operation of this equipment may create sparks that can start fires around dry vegetation. This unit is equipped with a spark arrestor and a spark arrestor may be required. The operator should contact local fire agencies for laws or regulations relating to fire prevention requirements.

## TRIMMER - OPERATION WITH BLADES

### Preparing the Trimmer/Brush Cutter for Blade Use



#### **WARNING**

Blade use **DEMANDS** specific Brush Cutter configuration. Operation without specified shield, barrier bar or U-handle, and harness can result in serious personal injury. Follow installation instructions included in optional kits.

### BLADE SET-UP GUIDE

TO USE THESE BLADES	Pro Maxi-Cut Grass/Weed Blade	Rigid Plastic Tri-Cut Grass/Weed Blade	Metal Blade
  You must install these parts!	Loop Handle, w/o w/o Barrier Bar	U-Handle or Loop Handle w/Barrier Bar	U-Handle or Loop Handle w/Barrier Bar
	Plastic Shield	Plastic Shield	Metal Shield
	Harness	Harness	Harness
	Upper Plate & Flat Washer	Upper Plate & Glide Cup	Upper/Lower Blade Plates
	Hex Nut	Hex Nut	Hex Nut
	New Cotter Pin	New Cotter Pin	New Cotter Pin

- **WARNING!** DO NOT INSTALL BLADES ON GT (CURVED SHAFT) MODEL TRIMMERS
- Arbor diameter of Upper Blade Plate must match arbor diameter of blades.
- New cotter pin required each time blade is installed.
- Brush Cutters over 16.5 lbs (7.5 kg) dry weight (weight w/o fuel) require a double shoulder harness

#### **NOTE**

The Barrier Bar is used to restrict rearward movement of the unit. The Barrier Bar is NOT A HANDLE and should not be gripped when using or carrying the unit.

## Choosing the Correct Blade



### **WARNING**

The type of Blade used **MUST** be matched to the type and size of material cut. An improper or dull blade can cause serious personal injury. Blades **MUST** be sharp. Dull blades increase the chance of kick out and injury to yourself and bystanders.

**Plastic/Nylon Blades** may be used where ever the nylon line head is used. **DO NOT** use this blade for heavy weeds or brush!



**8 Tooth Weed/Grass Blade** is designed for grass, garden debris and thick weeds. **DO NOT** use this blade for brush or heavy woody growth, 19 mm (3/4 in.) diameter or larger.

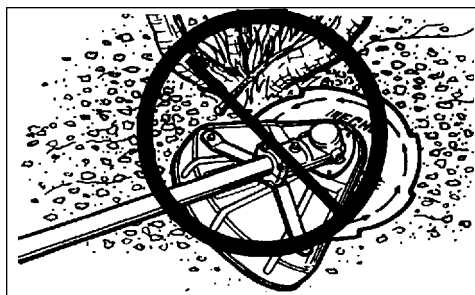

**80 Tooth Brush Blade** is designed for cutting brush and woody growth up to 13 mm (1/2 in.) diameter.



**22 Tooth Clearing Blade** is designed for dense thickets and saplings up to 64 mm (2-1/2 in.) diameter.

**Use Shoulder/Waist Harness** Use of the Shoulder/Waist Harness is recommended for **ALL** Trimmer/Brush Cutter use. The Shoulder/Waist Harness suspends the trimmer from the operator's shoulder and reduces operator fatigue.

The restrictive harness enhances operator safety by reducing the possibility of blade contact with the operator's hands and feet.



## OPERATING BLOWER

### **WARNING**

Moving parts can amputate fingers or cause severe injuries. Keep hands, clothing and loose objects away from all openings. Always stop engine, disconnect spark plug, and make sure all moving parts have come to a complete stop before removing obstructions, clearing debris, or servicing unit. Blower housing may contain shredder blades and other sharp edges that can cause serious injuries if touched, even if engine is off and blades are not moving. Wear gloves to protect hands from sharp edges and hot surfaces.

### **WARNING**

Always wear safety glasses, hearing protection and a face filter mask or serious personal injury may result. Do not point the blower pipe in the direction of people or pets.

Read the Safety Section carefully.

### **IMPORTANT**

To avoid engine damage due to over-revving, do not block blower pipe.

1. Use only during appropriate hours.

### **IMPORTANT**

Use reduced speed only when performing light-duty tasks or to comply with local noise regulations. Continuous low speed operation may allow fuel/oil residue to build-up on the piston and cause rapid build-up of carbon on the spark arrestor screen, resulting in overheating and engine damage. To reduce harmful build-up, run engine at wide open throttle for at least 5 minutes every hour, and inspect/clean the spark arrestor screen after approximately 40 hours of operation.

2. Control blower speed with throttle trigger.
3. Use lower speed to blow debris from hard surfaces.
4. Additional speed may be necessary to clean debris, snow, etc. from lawns and flowerbeds.

### **NOTE**

Never use a higher speed setting than necessary to perform a task. Remember, the higher the engine speed, the louder the blower noise. Minimize dust by using blower at lower speeds. Keep debris on your property.

Be Smart - be a good neighbor.



## FUEL

**NOTICE:** Use of unmixed, improperly mixed, or fuel older than 90 days, (stale fuel), may cause hard starting, poor performance, or severe engine damage and void the product warranty. Read and follow instructions in the Storage section of this manual.



### WARNING

Alternative fuels, such as E-15 (15% ethanol), E-85 (85% ethanol) or any fuels not meeting ECHO requirements are **NOT** approved for use in ECHO 2-stroke gasoline engines. Use of alternative fuels may cause performance problems, loss of power, overheating, fuel vapor lock, and unintended machine operation, including, but not limited to, improper clutch engagement. Alternative fuels may also cause premature deterioration of fuel lines, gaskets, carburetors and other engine components.

### *Fuel Requirements*

**Gasoline** - Use 89 Octane [R+M/2] (mid grade or higher) gasoline known to be good quality. Gasoline may contain up to 10% Ethanol (grain alcohol) or 15% MTBE (methyl tertiary-butyl ether). Gasoline containing methanol (wood alcohol) is **NOT** approved.

**Two Stroke Oil** - A two-stroke engine oil meeting ISO-L-EGD (ISO/CD 13738) and J.A.S.O. FD Standards must be used. Echo brand premium Power BlendX™ Universal 2-Stroke Oil meets these standards. Engine problems due to inadequate lubrication caused by failure to use an ISO-L-EGD (ISO/CD 13738) and J.A.S.O. FD certified oil, such as Echo premium Power BlendX™, will void the two-stroke engine warranty.

### IMPORTANT

Echo premium Power BlendX™ Universal 2-Stroke Oil may be mixed at 50:1 ratio for application in all Echo engines sold in the past regardless of ratio specified in those manuals.

### *Handling Fuel*



### DANGER

Fuel is VERY flammable. Use extreme care when mixing, storing or handling or serious personal injury may result.

- Use an approved fuel container.
- DO NOT smoke near fuel.
- DO NOT allow flames or sparks near fuel.
- Fuel tanks/cans may be under pressure. Always loosen fuel caps slowly allowing pressure to equalize.
- NEVER refuel a unit when the engine is HOT or RUNNING!
- DO NOT fill fuel tanks indoors. ALWAYS fill fuel tanks outdoors over bare ground.
- DO NOT overfill fuel tank. Wipe up spills immediately.
- Securely tighten fuel tank cap and close fuel container after refueling.
- Inspect for fuel leakage. If fuel leakage is found, do not start or operate unit until leakage is repaired.
- Move at least 3m (10 ft.) from refueling location before starting the engine.



**Mixing Instructions**

1. Fill an approved fuel container with half of the required amount of gasoline.
2. Add the proper amount of 2-stroke oil to gasoline.
3. Close container and shake to mix oil with gasoline.
4. Add remaining gasoline, close fuel container, and remix.

**IMPORTANT**

Spilled fuel is a leading cause of hydrocarbon emissions. Some states may require the use of automatic fuel shut-off containers to reduce fuel spillage.

**After use**

- DO NOT store a unit with fuel in its tank. Leaks can occur. Return unused fuel to an approved fuel storage container.

**Storage** - Fuel storage laws vary by locality. Contact your local government for the laws affecting your area. As a precaution, store fuel in an approved, airtight container. Store in a well-ventilated, unoccupied building, away from sparks and flames.

Fuel to Oil Mix - 50:1 Ratio			
U.S.		METRIC	
GAS	OL	GAS	OL
Gallons	Fl. oz.	Liter	cc.
1	2.6	4	80
2	5.2	8	160
5	13	20	400

**IMPORTANT**

Stored fuel ages. Do not mix more fuel than you expect to use in thirty (30) days, ninety (90) days when a fuel stabilizer is added.

**IMPORTANT**

Stored two-stroke fuel may separate. ALWAYS shake fuel container thoroughly before each use.

**STARTING COLD ENGINE**



**WARNING**

The attachment will operate immediately when the engine starts, and could result in possible serious injury. Keep movable parts of the attachment away from objects that could become entangled or thrown, and surfaces that could cause loss of control.

1. *Stop Switch*  
Move stop switch button (A) forward away from the STOP position.
2. *Choke*  
Move choke lever (B) to Cold Start Position (I). 
3. *Purge Bulb*  
Pump purge bulb (C) until fuel is visible and flows freely in the clear fuel tank return line. Pump bulb an additional 4 or 5 times.

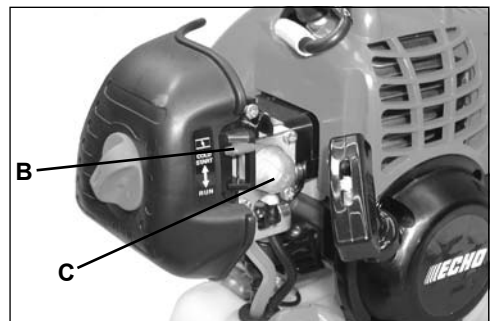
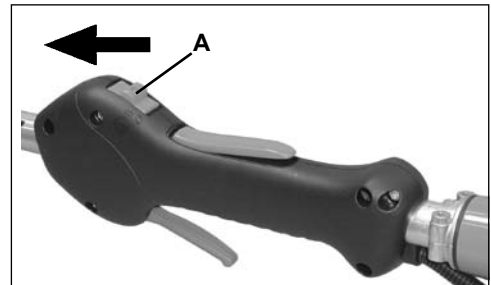

#### 4. Recoil Starter

Lay the unit on a flat area and keep movable attachment parts clear of all obstacles. Firmly grasp right hand grip and throttle trigger lockout with left hand and fully depress throttle trigger to wide open position. Rapidly pull recoil starter handle/rope (D) until engine fires (or maximum five [5] pulls).

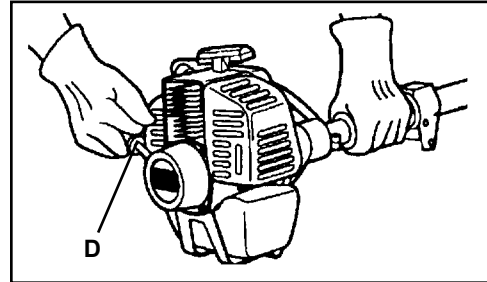

#### 5. Choke

After engine fires (or 5 pulls), move choke lever back to Run (↑) position. Hold throttle trigger and throttle trigger lockout fully depressed, and pull recoil starter handle/rope until engine starts and runs. Release throttle trigger, and allow unit to warm up at idle for several minutes.

#### NOTE

If engine does not start with choke in “Run” position after 5 pulls, repeat instructions 2 - 5.

#### 6. Throttle Trigger

After engine warm-up, gradually depress throttle trigger to increase engine RPM to operating speed.

## STARTING WARM ENGINE

The starting procedure is the same as Cold Start except DO NOT close the choke, and do not depress throttle trigger to wide open position.



### WARNING

The attachment should not move at idle, otherwise serious personal injury may result.

#### NOTE

If attachment moves, readjust carburetor according to “Carburetor Adjustment” instructions in this manual or see your ECHO Dealer.

#### 1. Stop Switch

Move stop switch button/lever (A) away from the STOP position.

#### 2. Purge Bulb

Pump purge bulb (C) until fuel is visible and flows freely in the clear fuel tank return line. Pump bulb an additional 4 or 5 times.

#### 3. Recoil Starter

Lay the unit on a flat area and keep movable attachment parts clear of all obstacles. Rapidly pull recoil starter handle/rope (D) until engine fires.

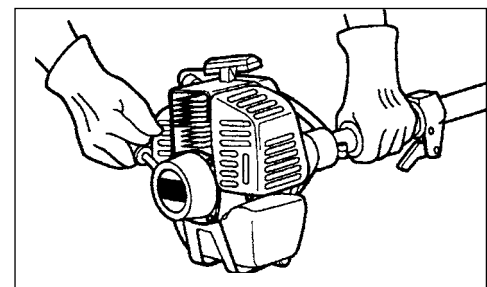
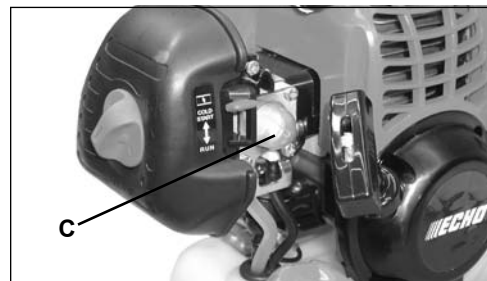
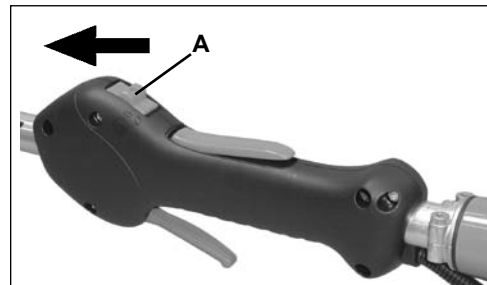

#### NOTE

If engine does not start after 5 pulls, use Cold Start Procedure.

## STOPPING ENGINE

1. *Throttle*  
Release throttle, and allow engine to return to idle before shutting engine off.
2. *Stop Switch*  
Move stop switch button (A) backward to STOP position.

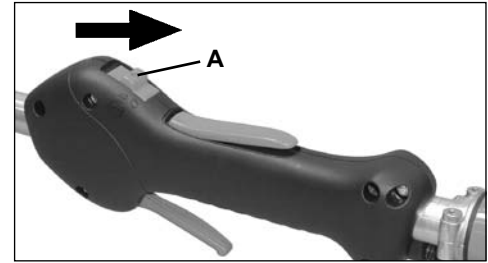

### WARNING

If engine does not stop when stop switch is moved to STOP position, close choke - COLD START position - to stall engine. Have your ECHO dealer repair stop switch before using trimmer again.

## MAINTENANCE



### WARNING

Moving parts can amputate fingers or cause severe injuries. Keep hands, clothing and loose objects away from all openings. Always stop engine, disconnect spark plug, and make sure all moving parts have come to a complete stop before removing obstructions, clearing debris, or servicing unit. Allow unit to cool before performing service. Wear gloves to protect hands from sharp edges and hot surfaces.

Your ECHO unit is designed to provide many hours of trouble-free service. Regular scheduled maintenance will help your unit achieve that goal. If you are unsure or are not equipped with the necessary tools, you may want to take your unit to an ECHO Service Dealer for maintenance. To help you decide whether you want to DO-IT-YOURSELF or have the ECHO Dealer do it, each maintenance task has been graded. If a task is not listed, see your ECHO Dealer for repairs.

## SKILL LEVELS

- Level 1 = Easy to do. Common tools may be required.
- Level 2 = Moderate difficulty. Some specialized tools may be required.

ECHO offers **REPOWER™** Maintenance Kits and Parts to make your maintenance job easier.

## MAINTENANCE INTERVALS

COMPONENT/ SYSTEM	MAINTENANCE PROCEDURE	REQ'D SKILL LEVEL	DAILY OR BEFORE USE	EVERY REFUEL	3 MONTHS OR 90 HOURS	YEARLY 600 HOURS
Air Filter	Inspect/Clean	1	I / C *		R *	
Choke Shutter	Inspect/Clean	1	I / C			
Fuel Filter	Inspect/Replace	1			I *	I / R *
Fuel Cap Gasket	Inspect/Replace	1			I *	R *
Fuel System	Inspect/Replace	1	I (3) *	I (3) *		
Spark Plug	Inspect/Clean	1			I / C / R *	
Cooling System	Inspect/Clean	2	I / C			
Muffler Spark Arrestor	Inspect/Clean/Replace	2			I / C / R *	
Cylinder Exhaust Port	Inspect/Clean/Decarbon	2			I / C	
Drive Shaft (Flex Cable Models)	Grease	2			I (1)	
Gear Housing	Grease	2			I (2)	
Recoil Starter Rope	Inspect/Clean	1	I / C *			
Screws/Nuts/Bolts	Inspect/Tighten/Replace	1	I *			

**MAINTENANCE PROCEDURE LETTER CODES: I = INSPECT, R = REPLACE, C = CLEAN**

**IMPORTANT NOTE** - Time intervals shown are maximum. Actual use and your experience will determine the frequency of required maintenance.

**MAINTENANCE PROCEDURE NOTES:**

(1) Apply POWER BLENDX™ grease every 25 hours of use.

(2) Apply POWER BLENDX™ grease every 50 hours of use.

(3) Low evaporative fuel tanks DO NOT require regular maintenance to maintain emission integrity.

\* Replacement is recommended based on the finding of damage or wear during inspection.

## AIR FILTER

### Level 1.

*Parts required:* REPOWER™ AIR & FUEL FILTER KIT.

1. Close choke (Cold Start Position [↔]). This prevents dirt from entering the carburetor throat when the air filter is removed. Brush accumulated dirt from air cleaner area.
2. Remove air filter cover. Brush dirt from inside cover.
3. Remove air filter and lightly brush debris from filter. Replace filter if it is damaged, fuel soaked, very dirty, or the rubber sealing edges are deformed.
4. If filter can be reused, be certain it:
  - Fits tightly in the air filter cavity.
  - Is installed with the original side out.
5. Install air filter cover.



## FUEL FILTER

### Level 1.

*Parts required:* REPOWER™ AIR & FUEL FILTER KIT.



### DANGER

Fuel is **VERY** flammable. Use extreme care when mixing, storing or handling, or serious personal injury may result.

1. Use a clean rag to remove loose dirt from around fuel cap and empty fuel tank.
2. Use the “fuel line hook” to pull the fuel line and filter from the tank.
3. Remove the filter from the line and install the new filter.



## SPARK PLUG

### Level 2.

*Parts Required:* REPOWER™ Tune-Up Kit

### IMPORTANT

Use only NGK BPM-8Y spark plug (BPMR-8Y in Canada) otherwise severe engine damage may occur.

1. Remove spark plug and check for fouling, worn and rounded center electrode.
2. Clean the plug or replace with a new one. DO NOT sand blast to clean. Remaining sand will damage engine.
3. Adjust spark plug gap by bending outer electrode.
4. Tighten spark plug to 150-170 kgf • cm (130-150 in • lbf).

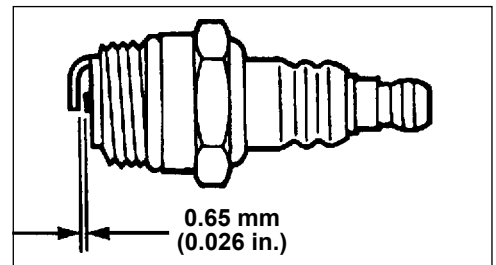

## COOLING SYSTEM

### Level 2.

*Parts Required:* None if you are careful.

#### IMPORTANT

To maintain proper engine operating temperatures, cooling air must pass freely through the cylinder fin area. This flow of air carries combustion heat away from the engine.

Overheating and engine seizure can occur when:

- Air intakes are blocked, preventing cooling air from reaching the cylinder.
- Dust and grass build up on the outside of the cylinder. This build up insulates the engine and prevents the heat from leaving.

Removal of cooling passage blockages or cleaning of cooling fins is considered "Normal Maintenance." Any failure attributed to lack of maintenance is not warranted.

1. Remove spark plug lead.
2. Remove air cleaner cover.
3. Remove engine cover (B).

#### IMPORTANT

DO NOT use a metal scraper to remove dirt from the cylinder fins.

4. Use brush to remove dirt from the cylinder fins.
5. Remove ignition wires from clip for cleaning.
6. Remove grass and leaves from the grid between the recoil starter and fuel tank.
7. Assemble components in reverse order.

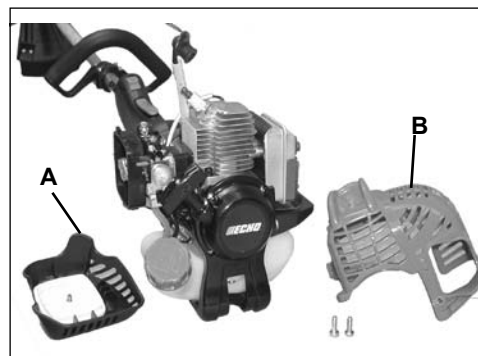
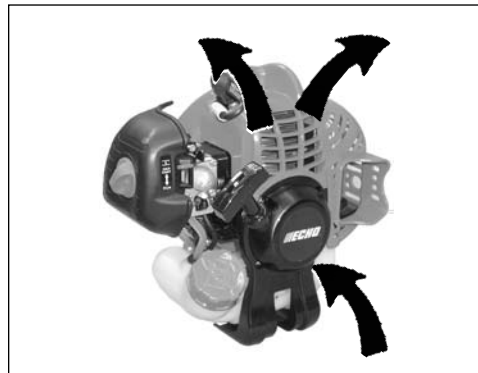

## EXHAUST SYSTEM

### *Spark Arrestor Screen*

#### Level 2.

*Parts Required:* Spark Arrestor Screen, Gasket

1. Remove engine cover (B).
2. Place piston at Top Dead Center (TDC) to prevent carbon/dirt from entering cylinder.
3. Remove spark arrestor screen cover (C,D), gasket (E), and screen (F), from muffler body.
4. Clean carbon deposits from muffler components.

#### **NOTE**

When cleaning carbon deposit, be careful not to damage the catalytic element inside muffler.

5. Replace screen if it is cracked, plugged, or has holes burned through.
6. Assemble components in reverse order.

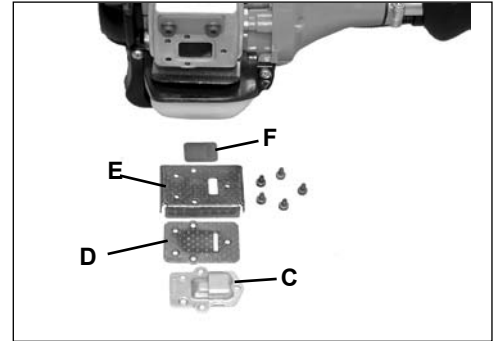

### *Exhaust Port Cleaning*

#### Level 2.

*Parts Required:* As needed: Heat Shield

1. Remove spark plug lead from spark plug, and remove engine cover.
2. Place piston at top dead center. Remove muffler (A) and heat shield (B).
3. Use a wood or plastic scraping tool to clean deposits from cylinder exhaust port.

#### **IMPORTANT**

Never use a metal tool to scrape carbon from the exhaust port. Do not scratch the cylinder or piston when cleaning the exhaust port. Do not allow carbon particles to enter the cylinder.

4. Inspect heat shield, and replace if damaged.
5. Install heat shield and muffler.
6. Tighten muffler mounting bolts (or nuts) to 80-95 in•lbf (90-110 kgf•cm).
7. Install engine cover and attach spark plug lead.
8. Start engine, and warm to operating temperature.
9. Stop engine, and re-tighten mounting bolts (or nuts) to specifications.

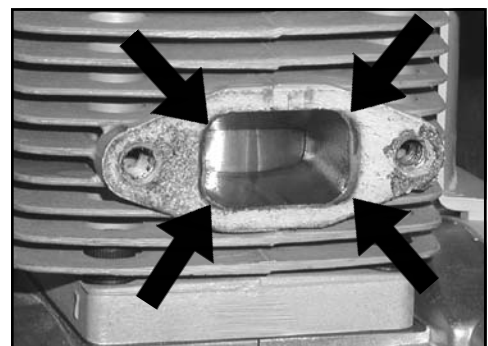
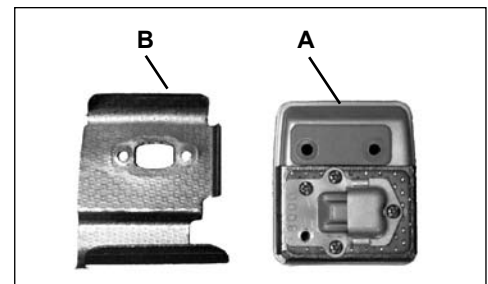

## CARBURETOR ADJUSTMENT

### *Engine Break-In*

New engines must be operated a minimum duration of two tanks of fuel break-in before carburetor adjustments can be made. During the break-in period your engine performance will increase and exhaust emissions will stabilize. Idle speed can be adjusted as required.

### *High Altitude Operation*

This engine has been factory adjusted to maintain satisfactory starting, emission, and durability performance up to 1,100 feet above sea level (ASL) (96.0 kPa). To maintain proper engine operation and emission compliance above 1,100 feet ASL the carburetor may need to be adjusted by an authorized ECHO service dealer.

#### **IMPORTANT**

If the engine is adjusted for operation *above* 1,100 feet ASL, the carburetor must be re-adjusted when operating the engine *below* 1,100 feet ASL, otherwise severe engine damage may result.

#### **Level 2.**

*Parts required:* None.

#### **NOTE**

Every unit is run at the factory and the carburetor is set in compliance with emission regulations. Carburetor adjustments, other than idle speed, must be performed by an authorized ECHO dealer.

1. Check idle speed and reset if necessary. If a tachometer is available, idle speed screw (A) should be set to the specifications found on "Specifications page" of this manual. Turn idle screw (A) clockwise to increase idle speed; counter clockwise to decrease idle speed.



#### **WARNING**

When carburetor adjustment is completed, the cutting attachment should not move at idle, otherwise serious personal injury may result.





## LUBRICATION

### Level 1.

*Parts Required:* POWER BLENDX™ 8 oz. (P/N 91014) or Lithium Base Grease.

### *Gear Housing*

1. Clean all loose debris from gear box.
2. Remove plug (A) and check level of grease.
3. Add grease if necessary. DO NOT over-fill.

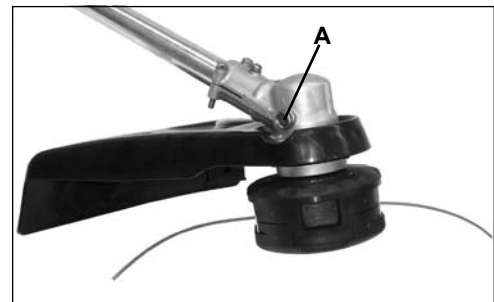

### *Drive Shaft (Lower)* *(Trimmer Attachment Only)*

#### **IMPORTANT**

Lower and upper drive shaft must be lubricated with high temperature automotive grease every 25 hours of operation, otherwise drive shaft assembly overheating and failure can result.

1. Loosen two (2) screws (B) and remove center locating screw (C). Pull gear box and shield from drive shaft housing.
2. Pull flexible cable from the drive shaft housing, wipe clean and re-coat with a thin coating [15 ml (1/2 oz.)] of POWER BLENDX™.
3. Slide the flexible cable back in the drive housing. DO NOT get dirt on the flex cable.
4. Install the gear housing and shield assembly.

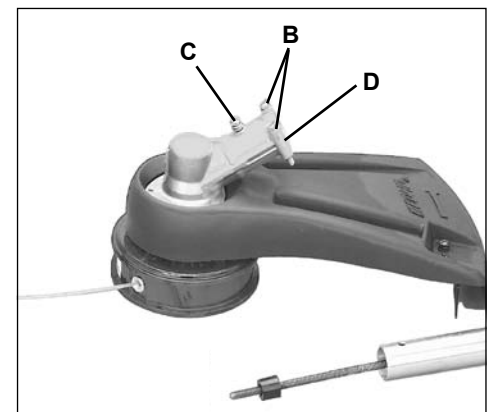

#### **IMPORTANT**

Flat edge of washers (D) must be against drive shaft.

## *Drive Shaft Upper*

1. Loosen clamping knob (A).
2. Pull locator pin (B) and rotate 1/4 turn counter clockwise to lockout position.
3. Remove attachment.
4. Remove coupler (E) from upper drive shaft assembly by loosening clamping screw (C) and removing set screw (D).
5. Remove upper flex cable (F), wipe clean, and apply a thin coating of 1/2 oz. (15ml) of grease.
6. Install cable. Make sure that the flex cable fully engages into the clutch square drive socket.
7. Slide coupler on upper drive shaft until fully seated, and align set screw hole in coupling with hole in upper drive shaft.
8. Install and tighten set screw (D), and tighten clamping screw (C).

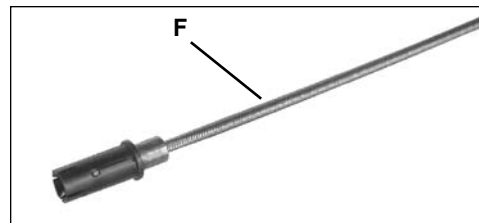
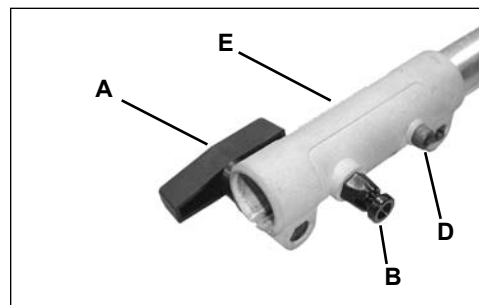
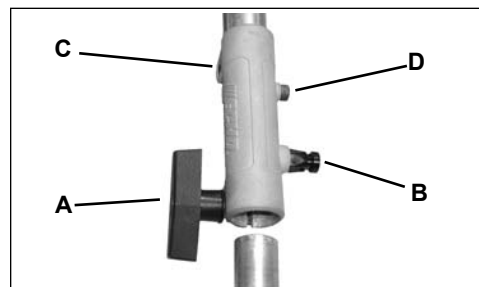

## **NYLON LINE REPLACEMENT**

1. Cut one piece of line to recommended length.  
**.080 (2.0 MM) DIA. - 10' (3 M)**  
**.095 (2.4 MM) DIA. - 10' (3 M)**
2. Align arrows on top of knob with openings in eyelets.
3. Insert one end of trimmer line into an eyelet, and push line equal distance through trimmer head.

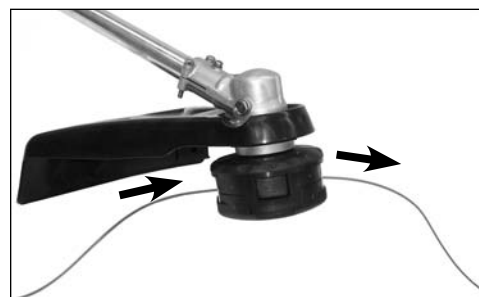
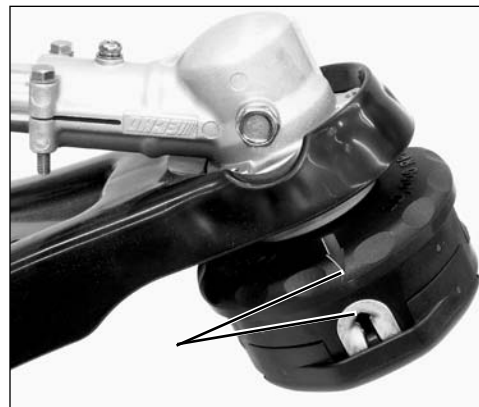

4. Hold trimmer head while turning knob clockwise to wind line onto spool until about 5" (13 cm) of each line remains exposed.

TRIMMER HEAD IS NOW FULLY LOADED AND READY FOR OPERATION.

**NOTE:**

Trimmer head is pre-wound with .095" (2.4mm) Crossfire™ trimmer line.



## SHARPENING METAL BLADES - TRIMMERS

Three styles of metal blades are approved for use on the ECHO Brush Cutter. The 8-tooth blade can be sharpened during normal maintenance. The clearing blade and 80 tooth blade require professional service.

Before sharpening, CLOSELY inspect blade for cracks (look at the bottom of each tooth and the center mounting hole closely), missing teeth and bending. If ANY of these problems are discovered, replace the blade.

When sharpening a blade, always remove the same amount of materials from each tooth to maintain balance. A blade that is not balanced will cause unsafe handling due to vibration and can result in blade failure.

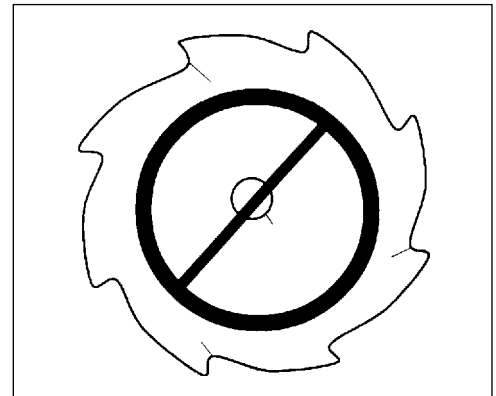

### 8-tooth Blade

1. File each tooth at a 30 degree angle a specific number of times, eg. 4 strokes per tooth. Work your way around the blade until all teeth are sharp.
2. DO NOT file the 'gullet' (radius) of the tooth with the flat file. The radius must remain. A sharp corner will lead to a crack and blade failure.

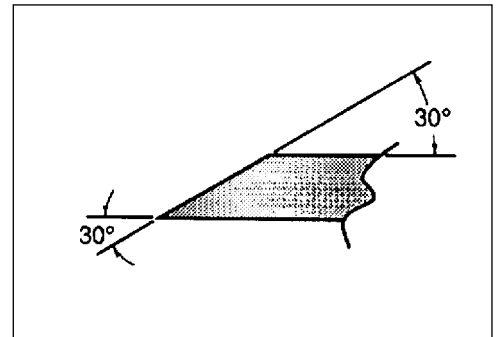

**IMPORTANT**

If an electric grinder is used, use care not to overheat teeth, do not allow tips/tooth to glow red or turn blue. DO NOT place blade in cooling water. This will change the temper of the blade and could result in blade failure.

3. After sharpening teeth, check each tooth radius for evidence of a square (sharp) corner. Use the round (rat tail) file to renew the radius.

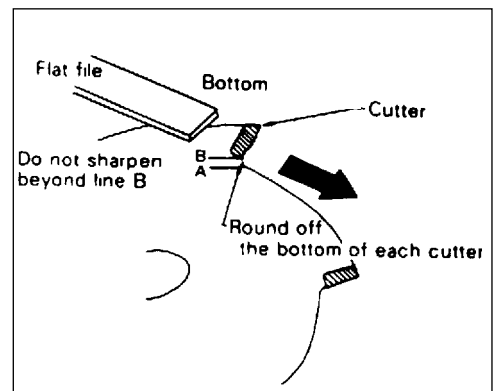

## TROUBLESHOOTING

ENGINE PROBLEM TROUBLESHOOTING CHART

Problem	Check	Status	Cause	Remedy
Engine cranks - starts hard/ doesn't start	Fuel at carburetor	No fuel at carburetor	Fuel strainer clogged Fuel line clogged Carburetor	Clean or replace Clean or replace See your Echo dealer
	Fuel at cylinder	No fuel at cylinder	Carburetor	See your Echo dealer
		Muffler wet with fuel	Fuel Mixture too rich	Open choke Clean/replace air filter Adjust carburetor See your Echo dealer
	Spark at end of plug wire	No spark	Stop switch off Electrical problem Interlock switch	Turn switch to ON See your Echo dealer See your Echo dealer
	Spark at plug	No spark	Spark gap incorrect Covered with carbon Fouled with fuel Plug defective	Adjust to .65mm (0.026 in.) Clean or replace Clean or replace Replace plug
Engine runs, but dies or does not accelerate properly	Air filter	Air filter dirty	Normal wear	Clean or replace
	Fuel filter	Fuel filter dirty	Contaminants/residues in fuel	Replace
	Fuel vent	Fuel vent plugged	Contaminants/residues in fuel	Clean or replace
	Spark Plug	Plug dirty/worn	Normal wear	Clean and adjust or replace
	Carburetor	Improper adjustment	Vibration	Adjust
	Cooling System	Cooling system dirty/plugged	Extended operation in dirty/dusty locations	Clean
	Spark Arrestor Screen	Spark arrestor screen plugged	Normal wear	Replace
Engine does not crank	N/A	N/A	Internal engine problem	See your Echo dealer



### DANGER

Fuel vapors are **extremely** flammable and may cause fire and/or explosion. **Never** test for ignition spark by grounding spark plug near cylinder plug hole, otherwise serious personal injury may result.

## STORAGE

### *Storage Hook Installation*

1. Insert small end of hook into locating hole on attachment shaft.
2. Slide plastic cap onto end of attachment shaft.



### *Long Term Storage (over 30 days)*



#### **WARNING**

During operation the muffler or catalytic muffler and surrounding cover become hot. Always keep exhaust area clear of flammable debris during transportation or when storing, otherwise serious property damage or personal injury may result.

Do not store your unit for a prolonged period of time (30 days or longer) without performing protective storage maintenance which includes the following:

1. Store unit in a dry, dust free place, out of the reach of children.



#### **DANGER**

Do not store in enclosure where fuel fumes may accumulate or reach an open flame or spark.

2. Place the stop switch in the "OFF" position.
3. Remove accumulation of grease, oil, dirt and debris from exterior of unit.
4. Perform all periodic lubrication and services that are required.
5. Tighten all the screws and nuts.
6. **Drain** the fuel tank **completely** and pull the recoil starter handle several times to remove fuel from the carburetor.
7. Remove the spark plug and pour 7 cc (1/4 oz.) of fresh, clean, two-stroke engine oil into the cylinder through the spark plug hole.
  - A. Place a clean cloth over the spark plug hole.
  - B. Pull the recoil starter handle 2-3 times to distribute the oil inside the engine.
  - C. Observe the piston location through the spark plug hole. Pull the recoil starter handle slowly until the piston reaches the top of it's travel and leave it there.
8. Install the spark plug (do not connect spark plug cable).

## SPECIFICATIONS

<b>MODEL</b> -----	<b>PAS-225 Value Pack</b>
Unit Length -----	1793mm (70.6 in.)
Unit Width -----	251 mm (9.88 in.)
Unit Height -----	328 mm (12.9 in.)
Weight (dry) w/cutting attachment -----	5.75 kg (12.68 lb.)
Engine Type -----	Air cooled, two-stroke, single cylinder gasoline engine
Bore -----	32.2 mm (1.27 in.)
Stroke -----	26.0 mm (1.02 in.)
Displacement -----	21.2 cc (1.29 cu. in.)
Exhaust System -----	Spark arrestor muffler or spark arrestor muffler with catalyst
Carburetor -----	Diaphragm model w/purge
Ignition System -----	CDI (capacitor discharge ignition)
Spark Plug -----	NGK BPM-8Y Gap 0.65 mm (0.026 in.)
Fuel -----	Mixed (Gasoline and Two-stroke Oil)
Fuel/Oil Ratio -----	50 : 1 Power Blend X™ ISO-L-EGD (ISO/CD 13738) and J.A.S.O. M345- <u>FD</u> , two-stroke, air-cooled engine oil.
Gasoline -----	Use 89 Octane unleaded. Do not use fuel containing methyl alcohol, more than 10% ethyl alcohol or 15% MTBE. Do not use alternative fuels such as E-15 or E-85.
Oil -----	Power Blend X™ Premium Universal 2-Stroke Oil
Fuel Tank Capacity -----	0.44 lit. (14.9 US fl. oz.)
Starter System -----	<b>i-30</b> Automatic Recoil Starter
Clutch -----	Centrifugal Type
Drive Shaft (upper & lower) -----	1/4 in. Flex Shaft
Rotating Direction -----	Counter clockwise viewed from top
Trimmer Attachment -----	Nylon line head with .095 in. Cross Fire™ line capacity 3 m (10 ft.)
Handles* -----	Front - Loop, Rear Handle (w/rubber), when operating with standard line head
Shoulder Harness -----	Optional
Power Blower Attachment	
- Length -----	635 mm (25.01 in.)
- Width -----	231 mm (9.10 in.)
- Height -----	212 mm (8.35 in.)
- Weight -----	1.76 kg (3.89 lbs.)
- Drive Shaft -----	6.35 mm (1/4 in.) Steel Shaft
- Maximum Air Speed (MPH) -----	100 mph
- Maximum Air Volume -----	317cu. ft./min.
- Sound Level at 50 ft. dB(A) scale per ANSI B175.2 -----	69 dB(A)
Idle Speed -----	2,750 RPM
Clutch Engagement Speed -----	3,850 RPM
Wide Open Throttle Speed (W.O.T.)	
w/Nylon Line Head -----	8,150 RPM
Wide Open Throttle Speed (W.O.T.)	
w/Blade -----	10,750 RPM
Wide Open Throttle Speed (W.O.T.)	
w/Blower Attachment -----	7,800 RPM

## ECHO APPROVED OPTIONAL ATTACHMENTS



### **WARNING**

Use only ECHO approved attachments for these models. Serious injury may result from the use of non approved attachment combinations. Read and comply with all safety instructions listed in this manual and attachment manual.

ECHO, INC. will not be responsible for the failure of cutting devices, attachments or accessories which have not been tested and approved by ECHO for use with these units.

## RECOMMENDED OPTIONAL ATTACHMENTS

•Articulating Hedge Trimmer	99944200590
•Articulating Hedge Trimmer	99944200595
•Brushcutter	99944200600
•Curved Shaft Edger	99944200470
•Hedge Trimmer	99944200480
•Hedge Trimmer	99944200485
•Tiller/Cultivator	99944200510
•Tiller/Cultivator	99944200513
•PowerPruner™	99944200530
•PowerPruner™	99944200532
•Rapid Loader Trimmer	99944200610
•Rapid Loader Curved Shaft Trimmer	99944200615
•Pro-Torque Trimmer	99944200545
•3 Foot Extension*	99944200535

\* For use with: Articulating Hedge Trimmer, Hedge Trimmer, and Power Pruner Attachments ONLY.

## WARRANTY STATEMENTS

### ECHO LIMITED WARRANTY STATEMENT FOR PRODUCT SOLD IN USA AND CANADA BEGINNING 01/01/2010

#### ECHO'S RESPONSIBILITY

ECHO Incorporated's Limited Warranty, provides to the original purchaser that this ECHO product is free from defects in material and workmanship. Under normal use and maintenance from date of purchase, ECHO agrees to repair or replace at ECHO's discretion, any defective product free of charge at any authorized ECHO servicing dealer within listed below application time periods, limitations and exclusions. **THIS LIMITED WARRANTY IS ONLY APPLICABLE TO ECHO PRODUCTS SOLD BY AUTHORIZED ECHO DEALERS. IT IS EXTENDED TO THE ORIGINAL PURCHASER ONLY, AND IS NOT TRANSFERABLE TO SUBSEQUENT OWNERS EXCEPT FOR EMISSION RELATED PARTS.** Repair parts and accessories replaced under this warranty are warranted only for the balance of the original unit or accessory warranty period. Any damage caused by improper installation or improper maintenance is not covered by this warranty. All parts or products replaced under warranty become the property of ECHO, Inc. This warranty is separate from the Emission control warranty statement supplied with your new product. Please consult the Emission Control Warranty Statement for details regarding emission related parts. For a list of Authorized ECHO Dealers refer to [WWW.ECHO-USA.COM](http://WWW.ECHO-USA.COM) or call **1-800-432-ECHO**.

#### OWNER'S RESPONSIBILITY

To ensure trouble free warranty coverage it is important that you register your ECHO equipment on-line at [WWW.ECHO-USA.COM](http://WWW.ECHO-USA.COM) or by filling out the warranty registration card supplied with your unit. Registering your product confirms your warranty coverage and provides a direct link if we find it necessary to contact you.

The owner shall demonstrate reasonable care and use, and follow preventative maintenance, storage, fuel and oil usage as prescribed in the operator's manual. Should a product difficulty occur, you must, at your expense, deliver or ship your ECHO unit to an authorized ECHO servicing dealer for warranty repairs (within the applicable warranty period), and arrange for pick-up or return of your unit after the repairs have been made. For your nearest authorized ECHO servicing dealer, call ECHO's Dealer Referral Center, at 1-800-432-ECHO or you can locate an ECHO servicing dealer at [WWW.ECHO-USA.COM](http://WWW.ECHO-USA.COM). Should you require assistance or have questions concerning ECHO's Warranty Statement, you can contact our Consumer Product Support Department at 1-800-673-1558 or contact us through the web at [WWW.ECHO-USA.COM](http://WWW.ECHO-USA.COM).

#### PRODUCT WARRANTY PERIOD

##### RESIDENTIAL APPLICATION

- **5 YEAR WARRANTY** - All units for residential, or non-income producing use will be covered by this limited warranty for **five (5) years** from date of purchase.

##### EXCEPTIONS:

- For two-stroke engine powered products, the electronic ignition module, flexible drive cables, SRM solid drive shafts, and TC tines are warranted for the **life\*** of the product on parts only.
- Cutting attachments such as, but not limited to, bars, chains, sprockets, blades, and nylon trimmer heads for residential or non-income producing use will be covered for failures due to defects in material or workmanship for a period of **60 days** from original product purchase date. Any misuse from contact with concrete, rocks, or other structures is not covered by this warranty.
- ECHO's Rapid Loader String Head carries a lifetime warranty on the line locking system, parts only; no labor. Refer to your operator's manual for string head installation and maintenance instructions.
- All SB-Series and PRO ATTACHMENT SERIES Split Shaft attachments carry the same warranty duration as the units they are designed to fit.

##### COMMERCIAL APPLICATION

- **1 YEAR WARRANTY** - All Chain Saws, QuikVent Saws, and Cut-Off Saws for commercial, institutional, agricultural, industrial, or income producing use will be covered by this limited warranty for one **(1) year** from the date of purchase.
- **2 YEAR WARRANTY** - All other units for commercial, institutional, agricultural, industrial, or income producing use will be covered by this limited warranty for two **(2) years** from the date of purchase.

##### EXCEPTIONS:

- For two-stroke engine powered products, the electronic ignition module, flexible drive cables, SRM solid drive shafts and TC tines, are warranted for the **life\*** of the product on parts only.
- Cutting attachments such as, but not limited to, bars, chains, sprockets, blades, and nylon trimmer heads for commercial, institutional, agricultural, industrial, rental, or income producing will be covered for failures due to defects in material or workmanship for a period of **30 days** from original product purchase date. Any misuse from contact with concrete, rocks, or other structures is not covered by this warranty.
- ECHO's Rapid Loader String Head carries a lifetime warranty on the line locking system, parts only; no labor. Refer to your operator's manual for string head installation and maintenance instructions.
- All SB-Series and PRO ATTACHMENT SERIES Split Shaft attachments carry the same warranty duration as the units they are designed to fit.

##### RENTAL APPLICATION - 90 DAYS WARRANTY

- Units for rental use will be covered against defects in material and workmanship for a period of 90 days from the date of purchase.

\* ECHO's liability under the "Lifetime" coverage is limited to furnishing parts specified under the PRODUCT WARRANTY PERIOD section of this warranty statement for "Life" free of charge for a period of ten (10) years after the date of the complete unit's final production.



**PURCHASED REPAIR PARTS, SHORT BLOCKS AND ACCESSORIES**

- 90-day residential, or non-income producing warranty
- 30-day commercial, institutional, agricultural, industrial, income producing, or rental application warranty

**ATTENTION TWO-STROKE ENGINE POWER PRODUCT OWNERS**

This ECHO two-stroke engine power product is a quality-engineered unit which has been manufactured to exact tolerances to provide superior performance. To help ensure the performance of the unit, it is required to use two-stroke oil which meets the ISO-L-EGD Standard per ISO/CD 13738 and JASO M345/FC/FD Standards. **ECHO Power Blend™ Two-Stroke Oil** is a premium two-stroke oil specifically formulated to meet ISO-L-EGD (ISO/CD 13738) and JASO M345/FC/FD Standards. The use of two-stroke oils designed for other applications, such as for outboard motors or lawnmowers can result in severe engine damage, and will void your two-stroke engine limited warranty.

**THIS WARRANTY DOES NOT COVER DAMAGE CAUSED BY:**

- Lack of lubrication or engine failure, due to the use of two-stroke oils that do not meet the ISO-L-EGD (ISO/CD 13738) and JASO M345/FC/FD Standards. Engine problems due to inadequate lubrication caused by failure to use an ISO-L-EGD compliant and JASO M345/FC/FD registered oil, will void the two-stroke engine limited warranty. **ECHO Power Blend™ Two-Stroke Oil** meets the ISO-L-EGD and JASO M345/FC/FD Standard. Emission related parts are covered for 5 years residential use or 2 years commercial use regardless of two-stroke oil used, per the statement listed in the EPA or California Emission Defect Warranty Explanation.
- Damage caused by use of gasohol, containing methanol (wood alcohol), or gasoline containing less than 89 octane. Only use gasoline which contains 89 octane or higher. Gasohol which contains a **maximum** 10% ethanol (grain alcohol) or 15% MTBE (methyl/tertiary/butyl/ether) is also approved. The prescribed mixing ratio of gasoline to oil is listed on the ECHO oil label and covered in your operator's manual.
- Engine damage caused by use of ether or any starting fluids.
- Damage caused by tampering with engine speed governor or emission components, or running engines above specified and recommended engine speeds as listed in your operator's manual.
- Operation of the unit with improperly maintained/removed cutting shield or removed/damaged air filter.
- Damage caused by dirt, pressure or steam cleaning the unit, salt water, corrosion, rust, varnish, abrasives, and moisture.
- Defects, malfunctions or failures resulting from abuse, misuse, neglect, modifications, alterations, normal wear, improper servicing, or use of unauthorized attachments.
- Incorrect storage procedures, stale fuel, including failure to provide or perform required maintenance services as prescribed in the operator's manual. Preventative maintenance as outlined in the operators manual is the customer's responsibility.
- Failures due to improper set-up, pre-delivery service or repair service by anyone other than authorized ECHO servicing dealer during the warranty period.
- Certain parts and other items are not warranted, including but not limited to: lubricants, starter cords, and engine tune-ups.
- Use of spark plugs other than those meeting performance and durability requirements of the OEM spark plug listed in the Operator's Manuals.
- Overheating or carbon scoring failures due to restricted, clogged exhaust port or combustion chamber, including damage to spark arrester screen.
- Adjustments after the first (30) thirty days and beyond, such as carburetor adjustment and throttle cable adjustment.
- Damage to gears or gear cases caused by contaminated grease or oil, use of incorrect type or viscosity of lubricants, and/or failure to comply with recommended grease or oil change intervals.
- Damage caused by loading SHRED 'N' VAC® beyond recommended capacity.
- Damage caused by pump or sprayer running dry, pumping or spraying caustic or flammable materials, or lack of or broken strainers.
- Additional damage to parts or components due to continued use after operational problem or failure occurs. Should operational problem or failure occur, the product should not be used, but delivered as is to an authorized ECHO servicing dealer.

It is a dealer's and/or customer's responsibility to complete and return the warranty registration card supplied with your ECHO product or by visiting [WWW.ECHO-USA.COM](http://WWW.ECHO-USA.COM). Your receipt of purchase including date, model and serial number must be maintained and presented to an authorized ECHO servicing dealer for warranty service. Proof of purchase rests solely with the customer. Some states do not allow limitations on how long an implied warranty lasts, so the above limitations may not apply to you. Some states do not allow the exclusion or limitation of incidental or consequential damages, so you may also have other specific legal rights which vary from state to state. This limited warranty is given by ECHO Incorporated, 400 Oakwood Rd., Lake Zurich, IL 60047.

**DISCLAIMER OF IMPLIED WARRANTIES**

This limited warranty is in lieu of all other expressed or implied warranties, including any warranty of FITNESS FOR A PARTICULAR PURPOSE OR USE and any implied warranty of **MERCHANTABILITY** otherwise applicable to this product. ECHO and its affiliated companies shall not be liable for any special incidental or consequential damage, including lost profits. There are no warranties extended other than as provided herein. This limited warranty may be modified only by ECHO.

99922201032  
12/03/09

## ECHO INCORPORATED EMISSION CONTROL WARRANTY STATEMENT FOR ECHO AND SHINDAIWA BRANDS

The Environmental Protection Agency (EPA) and the California Air Resources Board (C.A.R.B.) and ECHO Incorporated (ECHO Inc.) are pleased to explain the emission control system warranty on your 2010 and later equipment/small off-road engine (SORE). New equipment/SORE must be designed, built and equipped to meet stringent EPA and C.A.R.B. anti-smog standards. ECHO Inc. must warrant the emission control system on your equipment/SORE for the periods of time listed below, provided there has been no abuse, neglect or improper maintenance of your equipment/SORE. Your emission control system may include parts such as: carburetor, fuel-injection system, ignition system, catalytic converter/muffler, fuel tank, fuel feed lines, fuel cap assembly, spark plug, air filters, and other associated components. Where a warrantable condition exists, ECHO Inc will repair your equipment/SORE at no cost to you including diagnosis, parts and labor. The Emission Control System warranty is extended to the original owner including all subsequent owners.

### MANUFACTURER'S WARRANTY COVERAGE:

The emission control system is warranted for 2 years or the length of the ECHO Inc. warranty, whichever is longer. If any emission-related part on your equipment is defective, the part will be repaired or replaced by ECHO Inc. or its Authorized Service Representative.

### OWNER'S WARRANTY RESPONSIBILITIES:

As the equipment/SORE owner, you are responsible for the performance of the required maintenance listed in your Operator's Manual. ECHO Inc. recommends that you retain all receipts covering maintenance on your equipment/SORE however, ECHO Inc. cannot deny warranty solely for the lack of receipts or for your failure to ensure the performance of all scheduled maintenance. As the equipment/SORE owner, you should be aware that ECHO Inc. may deny you warranty coverage if your equipment/SORE or a part has failed due to abuse, neglect, improper maintenance or unapproved modifications.

You are responsible for presenting your equipment/SORE to an ECHO Inc. authorized service representative as soon as a problem exists. The warranty repairs should be completed in a reasonable amount of time, not to exceed 30 days. If a warrantable condition exists and there is no Authorized Dealer within 100 miles, ECHO Inc. will pay to ship the unit to the nearest authorized dealer. If you have questions regarding your warranty coverage, you should contact ECHO Inc. at 1-800-673-1558, web site WWW.ECHO-USA.COM or contact Shindaiwa at 1-877-986-7783, web site WWW.SHINDAIWA.COM.

### WHAT DOES THIS WARRANTY COVER?

ECHO Inc. warrants that your equipment/SORE was designed, built and equipped to conform with applicable EPA and C.A.R.B. emissions standards and that your equipment/SORE is free from defects in material and workmanship that would cause it to fail to conform with applicable requirements for 2 years or the length of the ECHO Inc. warranty, whichever is longer. The warranty period begins on the date the product is purchased by an end user.

### HOW WILL A COVERED PART BE CORRECTED?

If there is a defect in a part covered by this warranty, any ECHO Inc. Authorized Service Dealer will correct the defect. You will not have to pay anything to have the part adjusted, repaired or replaced. This includes any labor and diagnosis for warranted repairs performed by the dealer. In addition, engine parts not expressly covered under this warranty but whose failure is a result of a failure of a covered part will be warranted.

### WHAT PARTS ARE COVERED?

Any applicable emission related part not scheduled for "required maintenance" will be repaired or replaced within the warranty period. The repaired or replaced part will be warranted for the remaining ECHO Inc. warranty period.

Any warranted part that is scheduled only for regular inspection in the written instructions supplied is warranted for the warranty period stated above. Any such part repaired or replaced under warranty will be warranted for the remaining ECHO Inc. warranty period.

Any emission related part scheduled for replacement during "required maintenance" is warranted for the period of time prior to the first scheduled replacement point for that part. Any such part repaired or replaced under warranty shall be warranted for the remainder of the period prior to the first scheduled replacement point for that part.

Any manufacturer-approved replacement part may be used in the performance of any warranty maintenance or repairs on emission related parts, and must be provided without charge if the part is still under warranty.

Any replacement part that is equivalent in performance and durability may be used in non-warranty maintenance or repairs, and shall not reduce the warranty obligations of the manufacturer.

Throughout the equipment/SORE warranty period, ECHO Inc. will maintain a supply of warranted parts sufficient to meet the expected demand for such parts.

### SPECIFIC EMISSION RELATED WARRANTED PARTS:

- Electronic Ignition System
- Catalytic Converter / Muffler Assembly
- Choke
- Fuel Tank
- Air Filter
- Spark Plug
- Carburetor (complete assembly or replaceable components)
- Fuel-Injection Assembly (or replaceable components)
- Fuel Cap Assembly
- Fuel Feed Line (and associated clamps/connectors as applicable)

### WHAT IS NOT COVERED?

Any failure caused by abuse, neglect, improper maintenance, unapproved modifications, use of unapproved add-on parts/modified parts or unapproved accessories.

This Emission Control Warranty is valid only for the U.S.A., it's Territories, and Canada.

99922201033  
01/2010

NOTES

## SERVICING INFORMATION

### PARTS/SERIAL NUMBER

Genuine ECHO Parts and ECHO REPOWER™ Parts and Assemblies for your ECHO products are available only from an Authorized ECHO Dealer. When you do need to buy parts **always** have the Model Number, Type and Serial Number of the unit with you. You can find these numbers on the engine housing. For future reference, write them in the space provided below.

Model No. \_\_\_\_\_ SN. \_\_\_\_\_

### SERVICE

Service of this product during the warranty period must be performed by an Authorized ECHO Service Dealer. For the name and address of the Authorized ECHO Service Dealer nearest you, ask your retailer or call: 1-800-432-ECHO (3246). Dealer information is also available on our Web Site. When presenting your unit for Warranty service/repairs, proof of purchase is required.

### ECHO CONSUMER PRODUCT SUPPORT

If you require assistance or have questions concerning the application, operation or maintenance of this product you may call the ECHO Consumer Product Support Department at 1-800-673-1558 from 8:30 am to 4:30 pm (Central Standard Time) Monday through Friday. Before calling, please know the model and serial number of your unit.

### WARRANTY REGISTRATION

To ensure trouble free warranty coverage it is important that you register your ECHO equipment on-line at [www.echo-usa.com](http://www.echo-usa.com) or by filling out the warranty registration card supplied with your unit. Registering your product confirms your warranty coverage and provides a direct link between you and ECHO if we find it necessary to contact you.

### ADDITIONAL OR REPLACEMENT MANUALS

Replacement Operator, Safety Manuals, and Parts Catalogs are available from your ECHO dealer or at [www.echo-usa.com](http://www.echo-usa.com) or by contacting ECHO Inc., 400 Oakwood Road, Lake Zurich, IL 60047 (800-673-1558). Always check the ECHO Web Site for updated information.

Safety Videos are available from your Echo dealer. A \$5.00 shipping charge will be required for each video.



### DEALER?

Call  
**1-800-432-ECHO**  
**1-800-432-3246**  
or  
[www.echo-usa.com](http://www.echo-usa.com)

### CONSUMER PRODUCT SUPPORT

**1-800-673-1558**  
**8:30 - 4:30 Mon - Fri C.S.T.**

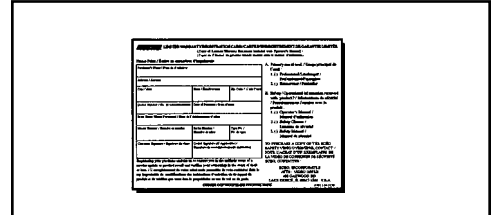

# ECHO®

ECHO, INCORPORATED  
400 OAKWOOD ROAD  
LAKE ZURICH, IL 60047-1564

[WWW.ECHO-USA.COM](http://WWW.ECHO-USA.COM)

PAS-225  
S59511001001/S59511999999  
S59612001001/S59612999999  
Trimmer  
S06400001001/S06400999999  
Blower  
S68600001001/S68600999999