

PRELIMINARY

# OWNER'S MANUAL

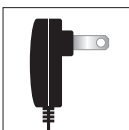
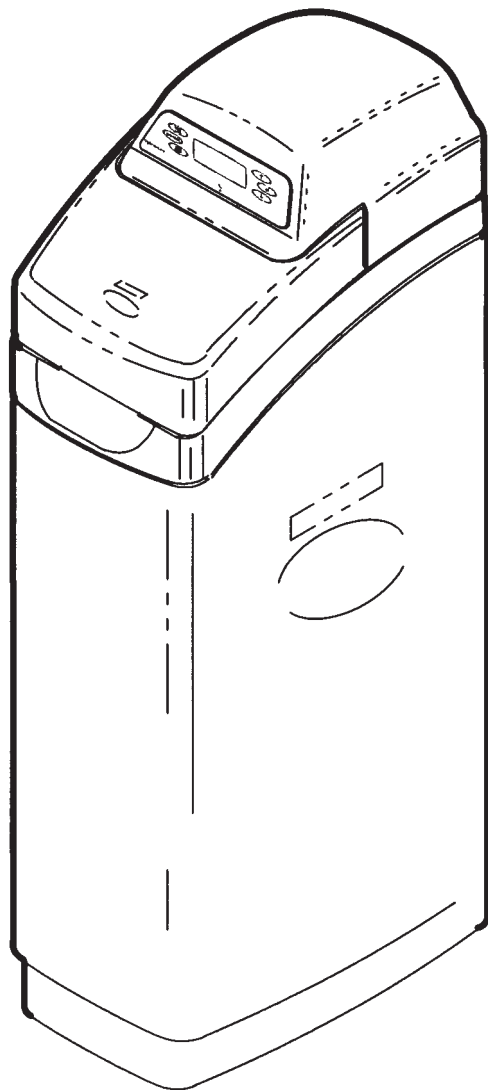
How to operate your  
EcoWater Systems  
Water Conditioner



**EcoWater Systems Conditioner  
with Remote (ECR)**

**EcoWater Systems Conditioner  
with Remote (ECR)**

**SERIES  
3500 & 3502**



Powered by an  
ENERGY STAR®  
qualified adapter  
for a better  
environment

EcoWater Systems  
P.O. Box 64420, St. Paul MN 55164-0420

## SAFETY GUIDES

Follow the installation instructions carefully. Failure to install the EcoWater Systems conditioner properly **voids the warranty.**

Before you begin installation, read this entire manual. Then, obtain all the materials and tools you will need to make the installation.

**Check local plumbing and electrical codes.** The installation must conform to them.

**Use only lead-free solder and flux** for all sweat-solder connections, as required by state and federal codes.

Use care when handling the EcoWater Systems conditioner. Do not turn upside down, drop, or set on sharp protrusions.

Do not locate the EcoWater Systems conditioner where freezing temperatures occur. Do not attempt to treat water over 120°F. **Freezing, or hot water damage voids the warranty.**

Avoid installing in direct sunlight. Excessive sun heat may cause distortion or other damage to non-metallic parts.

The EcoWater Systems conditioner requires a minimum water flow of 3 gallons per minute at the inlet. **Maximum allowable inlet water pressure is 125 psi.** If daytime pressure is over 80 psi, nighttime pressure may exceed the maximum. Use a pressure reducing valve if necessary (Adding a pressure reducing valve may reduce the flow).

**The EcoWater Systems conditioner works on 24 volt-60 hz electrical power only.** Be sure to use the included transformer and plug it into a nominal 120V, 60 Hz household outlet that is grounded and properly protected by an over current device such as a circuit breaker or fuse. If transformer is replaced, use only the authorized service, Class II, 24V, 10 VA transformer.

This system is not intended to be used for treating water that is microbiologically unsafe or of unknown quality without adequate disinfection before or after the system.

If conditioner is being used to remove barium and/or radium 226 and 228, please verify performance by contacting 612-607-1700, ext. 6470 for testing treated water supply or check the water testing section of your local phone directory.



European Directive 2002/96/EC requires all electrical and electronic equipment to be disposed of according to Waste Electrical and Electronic Equipment (WEEE) requirements. This directive or similar laws are in place nationally and can vary from region to region. Please refer to your state and local laws for proper disposal of the equipment.

**NOTE:** This equipment has been tested and found to comply with the limits for a Class B digital device, pursuant to Part 15 of the **FCC** Rules. These limits are designed to provide reasonable protection against harmful interference in a residential installation. This equipment generates, uses, and can radiate radio frequency energy and, if not installed and used in accordance with the instructions may cause harmful interference to radio communications. However, there is no guarantee that interference will not occur in a particular installation. If this equipment does cause harmful interference to radio or television reception, which can be determined by turning the equipment off and on, the user is encouraged to try to correct the interference by one or more of the following measures:

- Reorient or relocate the receiving antenna.
- Increase the separation between the equipment and receiver.
- Connect the equipment into an outlet on a circuit different from that to which the receiver is connected.
- Consult the dealer or an experienced radio/TV technician for help.

Changes or modifications not expressly approved by EcoWater Systems could void the user's authority to operate the equipment.

This device complies with **Industry Canada** Standard RSS-310. Operation is subject to the following two conditions: (1) this device may not cause interference, and (2) this device must accept any interference, including interference that may cause undesired operation of the device.

Ce dispositif est conforme avec la norme **CNR-310 d'Industrie Canada**. Le fonctionnement du dispositif est sujet aux deux conditions suivantes: (1) le dispositif ne doit pas causer de brouillage, et (2) le dispositif doit accepter tous brouillages, incluant tous brouillages qui peut nuire au bon fonctionnement du dispositif.

**LIMITED WARRANTY**  
**EcoWater Systems, Inc.**  
**Advantage Warranty**  
**Series ECR & ERR 3000 Water System**

Congratulations! You have just purchased the highest quality water conditioning product on the market. To register your warranty, complete the enclosed Warranty Registration Card and mail it within 30 days of purchase.

**To whom is this warranty extended?**

EcoWater Systems, Inc. warrants its products to the original owner and guarantees that the products will be free from defects in materials and workmanship from the original date of installation.

**How does my warranty work?**

If, during the respective warranty period, a part proves, after inspection by EcoWater, to be defective, EcoWater will, at its sole option repair or replace that part at no charge, other than normal shipping, installation or service charges.

**What is covered by the warranty?**

EcoWater Systems, Inc. guarantees that, for the LIFETIME of the original owner, the SALT TANK and the MINERAL TANK will not rust, corrode, leak, burst, or in any other manner fail to perform their proper functions and that, for a period of TEN YEARS, the VALVE BODY will be free of defects in materials and workmanship and will perform its proper function and that, for a period of FIVE YEARS, the ELECTRONIC FACEPLATE and ALL OTHER PARTS, including the REMOTE MONITOR will be free of defects in materials and workmanship and will perform their normal functions. Only on models designated as ERR on the rating decal, is the resin bed guaranteed, for the lifetime of the original owner, to be free of defects in materials and workmanship and to remove chlorine taste and odor from a municipal water supply.

**How do I obtain warranty service?**

Should you need service, your local, independent EcoWater Dealer is only a phone call away.

PHONE: \_\_\_\_\_

To obtain warranty service, notice must be given, within thirty (30) days of the discovery of the defect, to your local EcoWater Systems dealer.

**If I need a part replaced after the factory warranty expires, is the replacement part warranted?**

Yes, EcoWater Systems, Inc. warrants FACTORY REPAIRS as well as all REPLACEMENT PARTS for a period of 90 DAYS. This warranty does not include normal shipping, installation or service charges.

**Are any additional warranties available?**

We are pleased to say, YES! EcoWater Systems, Inc. sells an EXTENDED, PARTS ONLY WARRANTY for the ELECTRONICS portion of your product. This warranty is called the "Perfect Ten" and extends the five year warranty on the electronic FACEPLATE, WIRING HARNESS, DRIVE MOTOR, TRANSFORMER, POWER CORD, SENSOR HOUSING, and MICRO SWITCHES to a total of TEN YEARS from the date of original installation. Your local dealer will provide details regarding this warranty or will refer you to the factory for additional information. In addition, the 3000 SERIES product carries the CREST OF EXCELLENCE GUARANTEE that, should you experience a repetitive problem that remains uncorrected, EcoWater will, during the FIRST YEAR OF INSTALLATION, replace the product with the exact or comparable product.\* This guarantee may be subject to normal shipping and installation or service charges.

**General Provisions**

The above warranties are effective provided the water conditioner is operated at water pressures not exceeding 125 psi, and at water temperatures not exceeding 120SF (and on a municipal chlorinated water supply - models designated as ERR on the rating decal); provided further that the water conditioner is not subject to abuse, misuse, alteration, neglect, freezing, accident or negligence; and provided further that the water conditioner is not damaged as the result of any unusual force of nature such as, but not limited to, flood, hurricane, tornado or earthquake. EcoWater Systems, Inc., is excused if failure to perform its warranty obligations is the result of strikes, government regulation, materials shortages, or other circumstances beyond its control.

\*THERE ARE NO WARRANTIES ON THE WATER CONDITIONER BEYOND THOSE SPECIFICALLY DESCRIBED ABOVE. ALL IMPLIED WARRANTIES, INCLUDING ANY IMPLIED WARRANTY OF MERCHANTABILITY OR OF FITNESS FOR A PARTICULAR PURPOSE, ARE DISCLAIMED TO THE EXTENT THEY MIGHT EXTEND BEYOND THE ABOVE PERIODS. THE SOLE OBLIGATION OF ECOWATER SYSTEMS, INC. UNDER THESE WARRANTIES IS TO REPLACE OR REPAIR THE COMPONENT OR PART WHICH PROVES TO BE DEFECTIVE WITHIN THE SPECIFIED TIME PERIOD, AND ECOWATER IS NOT LIABLE FOR CONSEQUENTIAL OR INCIDENTAL DAMAGES. NO ECOWATER DEALER, AGENT, REPRESENTATIVE, OR OTHER PERSON IS AUTHORIZED TO EXTEND OR EXPAND THE WARRANTIES EXPRESSLY DESCRIBED ABOVE.

Some states do not allow limitations on how long an implied warranty lasts or exclusions or limitations of incidental or consequential damage, so the limitations and exclusions in this warranty may not apply to you. This warranty gives you specific legal rights, and you may have other rights which vary from state to state. This warranty applies to consumer-owned installations only.

**GUARANTEE**  
**BOND**

The Safeco Insurance Company of America has issued it's bond in the form shown below, guaranteeing full performance by EcoWater Systems, Inc.

SAFECO INSURANCE COMPANY OF AMERICA, hereinafter called "Surety," guarantees unto Bank of New York as Trustee holding said Guarantee Bond under the terms of a Trust Agreement dated April 9, 2003, for the use and benefit of original purchasers of residential EcoWater Systems Units within the Continental United States, as described herein, that EcoWater Systems, Inc., will discharge the obligations of the "EcoWater Bonded Parts and Service Guarantee Policy."

PROVIDED, HOWEVER, that:

1. Liability of Surety hereunder shall not exceed the sum of FIVE HUNDRED AND 00/100th DOLLARS (\$500.00) as to any one installation, and shall not exceed the sum of FIVE HUNDRED THOUSAND AND 00/100th DOLLARS (\$500,000.00) in the aggregate, and
2. There shall be no liability hereunder as to any purchaser to whom there has not been issued at the time of installation and purchase completed registration card which is enclosed with a facsimile of this bond, and who has not returned such card in accordance with this guarantee.
3. Claim must be made by such original purchaser in writing within 30 days from the expiration of these guarantees upon EcoWater Systems, Inc., PO Box 64420, St. Paul, MN 55164, to perform the terms of said guarantee, and notice of any default on such guarantee must be sent to Surety at its address by Registered Mail.

SAFECO INSURANCE COMPANY OF AMERICA

This is to certify that the original of the above guarantee and bond is on file with Bank of New York.

BANK OF NEW YORK

As Trustee

## WATER CONDITIONING

Water conditioning is the treatment of several conditions in household water. The conditions treated by the unit you have purchased are: (1) Hardness, (2) Iron, (3) Sediments, (4) Barium and (5) Radium 226 and 228. These are described below:

**1. HARDNESS** is a term to describe the presence of calcium and magnesium minerals in water. A chemical analysis accurately measures the amount of minerals in grain weight. For example, one gallon of water with 5 grains per gallon (gpg) hardness has dissolved minerals that, if solidified, about equals the size of one ordinary aspirin tablet. One gallon of water, 25 gpg hard, has a mineral content equal in size to 5 aspirin tablets. Water hardness varies greatly across the country. It generally contains from 3 to 100 gpg.

Hard water affects living in general. Hardness minerals combine with soap to make a soap curd. The curd greatly reduces the cleaning action of soap. Precipitated hardness minerals form a crust on cooking utensils, appliances, and plumbing fixtures. Even the tastes of foods are affected. A water softener removes the hardness minerals to eliminate these problems, and others.

**IMPORTANT:** Water softeners using sodium chloride (NaCl) salt for regeneration add sodium to the water. Persons on sodium restricted diets should consider the added sodium as part of their overall intake. Water softeners using potassium chloride (KCl) salt for regeneration add potassium to the water. Persons on potassium restricted diets should consider the added potassium as part of their overall intake.

**2. IRON** in water is measured in parts per million (ppm). The total\* ppm of iron, and type or types\*, is determined by chemical analysis. Three different types of iron in water are: (a) Ferrous (clear water), (b) Ferric (red water), and (c) Bacterial and organically bound iron.

\*Water may contain one or more of the three types of iron and any combination of these. Total iron is the sum of the contents.

**a. Ferrous** (clear water) iron is soluble and dissolves in water. It is usually detected by taking a sample of water in a clear bottle or glass. Immediately after taking, the sample is clear. As the water sample stands, it gradually clouds and turns slightly yellow or brown as air oxidizes the iron. This usually occurs in 15 to 30 minutes. An EcoWater Systems conditioner will remove moderate amounts of this type of iron (see specifications).

**b. Ferric** (red water), and **c. Bacterial and organically bound** irons are insoluble. This iron is visible immedi-

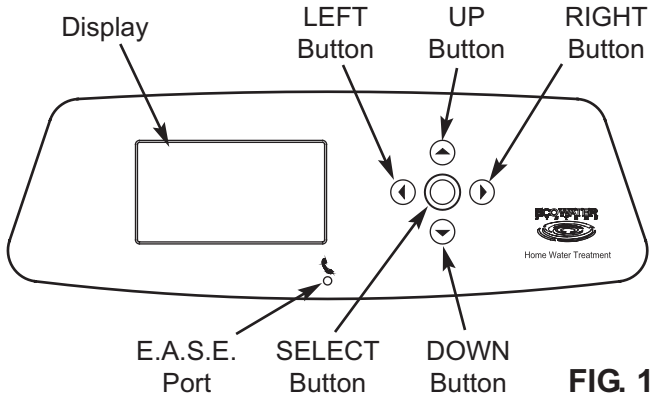
ately when drawn from a faucet because it has oxidized before reaching the home. It appears as small cloudy yellow, orange, or reddish suspended particles. After the water stands for a period of time, the particles settle to the bottom of the container. Generally these irons are removed from water by filtration. Chlorination is also recommended for bacterial iron. An EcoWater Systems conditioner will remove minimal quantities (see specifications) of ferric iron.

**3. SEDIMENT** is fine, foreign material particles suspended in water. This material is most often clay or silt. Extreme amounts of sediment may give the water a cloudy appearance. A sediment filter normally corrects this condition.

**4. BARIUM** is a naturally occurring metal that makes its way into water through drilling wastes, smelting copper, and producing motor vehicle parts. The Environmental Protection Agency (EPA) has the authority to determine chemicals that cause health effects and at what levels. EPA created a list of harmful chemicals and their maximum contaminant levels (MCL), to set limits for public water supplies to maintain. Barium's MCL is 2 parts per million (PPM). The level of barium in water can be determined through chemical analysis.

**5. RADIUM** is a naturally occurring radioactive metal that can be found in most drinking water at low levels. Higher levels occur when ground water passes through bedrock containing high concentrations of radium. Radium 226 and 228 are also regulated by EPA with an MCL of 5 picocuries per liter (pCi/l). A chemical analysis is needed to measure the concentration of Radium 226 and 228.

This section is not yet complete.



**FIG. 1**

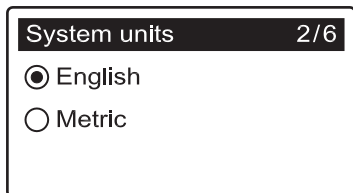
**SETUP PROCEDURE**

When the EcoWater Systems softener is plugged in for the first time, the display briefly shows a logo, followed by model information. Next, a series of six “wizard” screens prompts you to enter basic operating information:



**FIG. 2**

- 1. LANGUAGE** Press the softener’s DOWN (▼) or UP (▲) buttons to highlight the desired language (See Figure 43). The choices are: English, Spanish, French, Italian, German, Dutch, Polish, Russian, Hungarian, Turkish, Lithuanian, Greek or Romanian.
- Press the SELECT (○) button to advance to the next “wizard” screen. All menus and messages will be in the selected language from this point on.



**FIG. 3**

- 3. SYSTEM UNITS** Press the DOWN (▼) or UP (▲) buttons to highlight the desired units (See Figure 3).
- Press the SELECT (○) button.

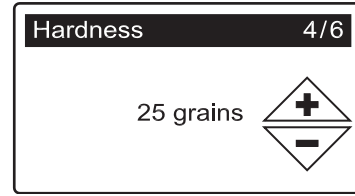


**FIG. 4**

- 5. CURRENT TIME** Press the DOWN (▼) or UP (▲) buttons to set the current time (See Figure 4). Hold

the button down to rapidly advance. Be sure that AM or PM is correct.

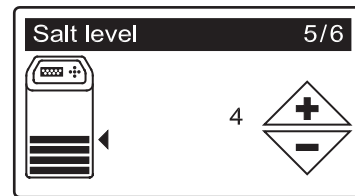
- Press the SELECT (○) button.



**FIG. 5**

- 7. HARDNESS** Press the UP (▲) or DOWN (▼) buttons to set the value of your water’s hardness (See Figure 5).

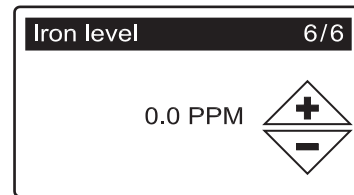
- Press the SELECT (○) button.



**FIG. 6**

- 9. SALT LEVEL** Press the UP (▲) or DOWN (▼) buttons to set the salt level (See Figure 6). It should match the lowest number visible on the brinewell decal above the salt.

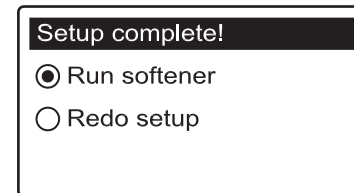
- Press the SELECT (○) button.



**FIG. 7**

- 11. IRON LEVEL** Press the UP (▲) or DOWN (▼) buttons to set the value for iron in your water (See Figure 7).

- Press the SELECT (○) button. The screen will show “Setup complete!” (See Figure 8).



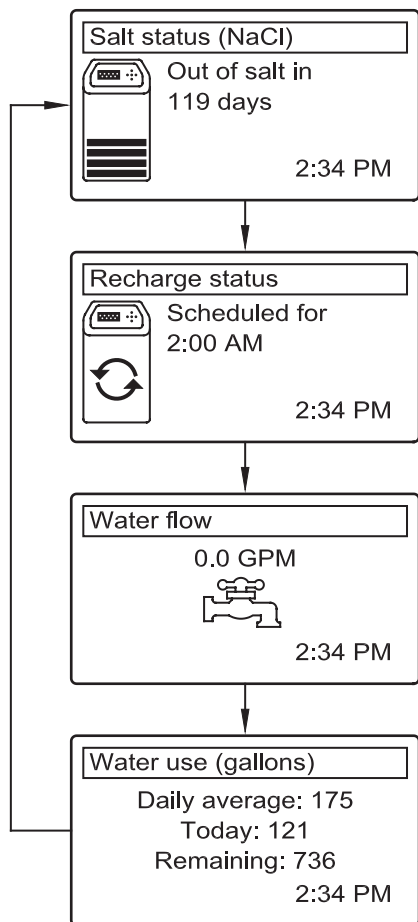
**FIG. 8**

- If, at this point, you want to go back and make changes, press the DOWN (▼) button to highlight **Redo setup**, then press SELECT (○) to repeat the six “wizard” screens.

- If no changes are desired, make sure **Run softener** is highlighted (See Figure 8) and press the SELECT (○) button. The softener begins normal operation, described on the next page.

**SOFTENER STATUS SCREENS**

During normal operation, the EcoWater Systems softener’s display shows a rolling series of four status screens. Each is shown for 6 seconds, in a rolling sequence (See Figure 9).



**FIG. 9**

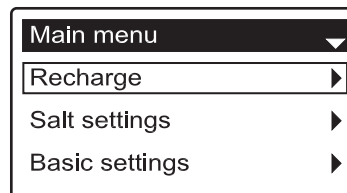
Pressing the softener’s RIGHT (▶) button manually advances to the next screen in the sequence. Pressing the LEFT (◀) button manually returns to the previous status screen. If no buttons are pressed for 30 seconds, the rolling sequence resumes.

**ERROR MESSAGES, ALARMS AND REMINDERS**

The softener status screens described above will not be displayed in a rolling sequence when one of the following messages is displayed:

- **Error detected** (contact your dealer for service)
- **Service reminder** (See Page 18)
- **Recharge status** (Displayed during recharges, showing valve position and time remaining)
- **Low salt alarm** (See Page 9)

**MAIN MENU**



**FIG. 10**

During normal operation (status screens rolling), press the softener’s SELECT (○) button to display the Main menu (See Figure 10). This menu and its subsidiary screens are used to control these softener operations:

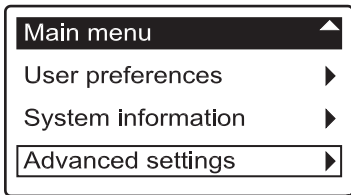
- **Recharge**
- **Salt settings**
  - Salt level
  - Low Salt alarm
  - Salt type
- **Basic settings**
  - Current time
  - Hardness
  - Iron level
  - Recharge time
  - Rolling screens
- **User preferences**
  - Language
  - Time format
  - Volume units
  - Hardness units
  - Weight units
- **System information**
  - Model information
  - Water available
  - Daily avg. water used
  - Water used today
  - Total water used
  - Current water flow
  - Days powered up
  - Last recharge
  - Total recharges
- **Advanced settings**
  - **Cycle times**
    - Backwash time
    - 2nd backwash
    - 2nd backwash time
    - Fast rinse time
  - **Special features**
    - Efficiency mode
    - Max. days between recharges
    - Auxiliary control
    - Chemical feed volume\*
    - Chemical feed time\*
    - 97% feature
    - Service reminder
  - **Troubleshooting**
    - Send E.A.S.E. message
    - Diagnostics
    - Setup changes
  - **Connect to remote**

\*Only displayed if Auxiliary control is set to Chemical feed.

**CONNECTING TO REMOTE**

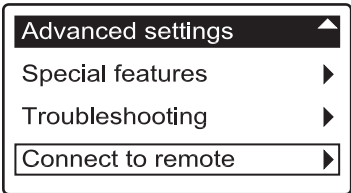
When the softener’s electronic control is first powered up, it is not yet in communication with the remote. To establish a link between the two:

1. Make sure the remote is powered up (See “Installing Batteries” on Page 21).
2. From any of the rolling status screens, press the softener’s SELECT (O) button to display the Main menu.
3. Press the softener’s DOWN (▼) button to scroll through the menu options until **Advanced settings** is highlighted (See Figure 11).



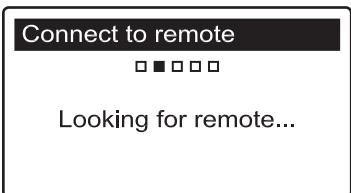
**FIG. 11**

4. Press the softener’s SELECT (O) button to display the Advanced settings menu (See Figure 12).



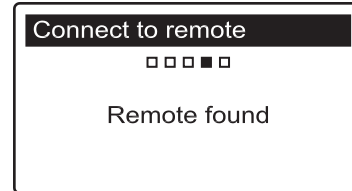
**FIG. 12**

5. Press the softener’s DOWN (▼) button to scroll through the menu options until **Connect to remote** is highlighted.
6. Press the remote’s SELECT (O) button to display a menu screen. The header will turn black (See Figure 87 on Page 22).
7. Press the remote’s DOWN (▼) button to scroll through the menu options until **Add new device** is highlighted in a box (See Figure 88).
8. Press the remote’s SELECT (O) button, and the “Waiting for new device...” screen appears (See Figure 89). The remote waits 30 seconds for the softener to be activated (in the next step).
9. Make sure the softener’s display still shows the screen in Figure 12. Press the softener’s SELECT (O) button to display the “Looking for remote” screen (See Figure 13).



**FIG. 13**

10. Within 5 seconds the screen should change to show “Remote found” (See Figure 14). If the screen instead reads “Remote not found,” press the softener’s LEFT (◀) button to return to the screen in Figure 12. Repeat this procedure from Step 7. If the remote is not found after several tries, contact your dealer for service.

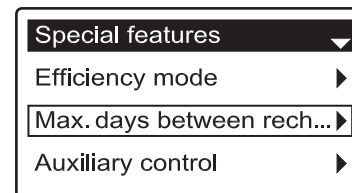


**FIG. 14**

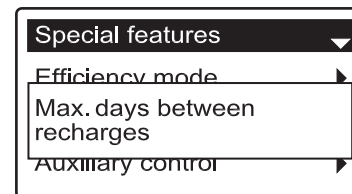
11. Press the softener’s SELECT (O) button. The display will go back to the Advanced settings menu (Figure 12).
12. Press the softener’s LEFT (◀) button twice to return to the rolling status screens.

**LONG DISPLAY SCREEN MESSAGES**

Most messages in the softener’s display screens are short enough to be shown as a single line. Longer messages will be truncated (See Figure 15 for an example) until you highlight them. One second after being highlighted, the viewing box expands (See Figure 16) to show the entire message. After three seconds the view resets (Figure 15).



**FIG. 15**



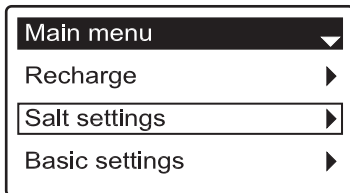
**FIG. 16**



**SETTING SALT LEVEL**

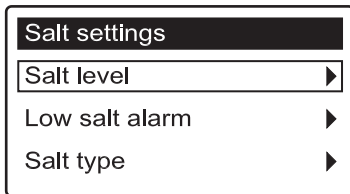
Use this feature when adding salt to the softener:

1. From any of the rolling status screens, press the SELECT (O) button to display the Main menu.
2. Press the DOWN (▼) button to scroll through the menu options until **Salt settings** is highlighted (See Figure 17).



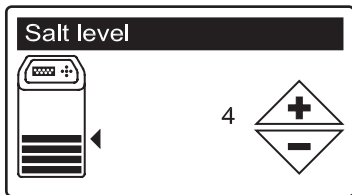
**FIG. 17**

3. Press the SELECT (O) button to display the Salt settings menu (See Figure 18).



**FIG. 18**

4. If necessary, press the DOWN (▼) button to scroll through the menu options until **Salt level** is highlighted.
5. Press the SELECT (O) button to display the Salt level screen (See Figure 19). The light inside the salt tank will turn on.



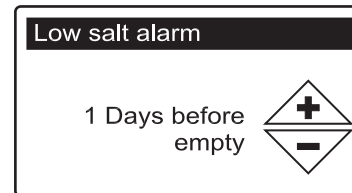
**FIG. 19**

6. Press the UP (▲) or DOWN (▼) buttons to change the salt level. It should match the lowest number visible on the brine well decal above the salt.
7. Press the SELECT (O) button. The display will go back to the "Salt settings" menu (Figure 18).
8. Press the LEFT (◀) button twice to return to the rolling status screens. It will also reset automatically if no buttons are pressed for 4 minutes.

**LOW SALT ALARM**

Use this feature to program when the electronic control will display a low salt alarm. The number of days can be customized, or the feature can be turned off:

- 1-3. Go to the **Salt settings** menu by following Steps 1-3 in the "Setting Salt Level" procedure at left.
4. Press the DOWN (▼) button to scroll through the menu options until **Low salt alarm** is highlighted.
5. Press the SELECT (O) button to display the Low salt alarm screen (See Figure 20).



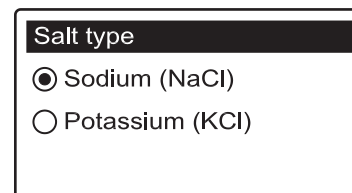
**FIG. 20**

6. Press the UP (▲) or DOWN (▼) buttons to change the number of days. Setting the number of days below 1 turns the alarm feature off.
7. Press the SELECT (O) button. The display will go back to the Salt settings menu (Figure 18).
8. Press the LEFT (◀) button twice to return to the rolling status screens.

**SETTING SALT TYPE**

Use this feature to program the electronic control with which type of salt is used:

- 1-3. Go to the **Salt settings** menu by following Steps 1-3 in the "Setting Salt Level" procedure at left.
4. Press the DOWN (▼) button to scroll through the menu options until **Salt type** is highlighted.
5. Press the SELECT (O) button to display the Salt type menu (See Figure 21).



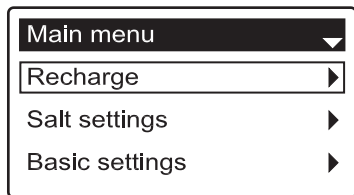
**FIG. 21**

6. Press the DOWN (▼) or UP (▲) buttons to highlight the type of salt being used.
7. Press the SELECT (O) button. The display will go back to the Salt settings menu (Figure 18).
8. Press the LEFT (◀) button twice to return to the rolling status screens.

## INITIATING MANUAL RECHARGE

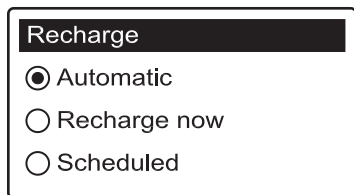
This feature may be used to assure an adequate supply of softened water at times of unusually high water use. For example, if you have guests and the "Water available" screen is at or below 50%, you could deplete softened water capacity before the next automatic recharge. Initiating a manual recharge will restore 100% softened water capacity after complete:

1. From any of the rolling status screens, press the SELECT (O) button to display the Main menu.



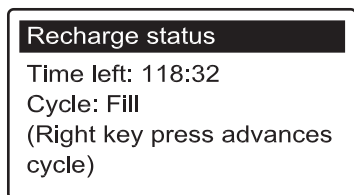
**FIG. 22**

2. If necessary, press the DOWN (▼) button to scroll through the menu options until **Recharge** is highlighted (See Figure 22).
3. Press the SELECT (O) button to display the Recharge menu (See Figure 23).



**FIG. 23**

4. Press the DOWN (▼) or UP (▲) buttons to highlight the desired option. Selecting **Recharge now** begins a recharge immediately after the SELECT (O) button is pushed. Selecting **Scheduled** sets a recharge to begin at the preset recharge time (set according to the instructions on Page 11). Selecting **Automatic** cancels a scheduled extra recharge (if it has not already begun) and lets the electronic control determine when to recharge next.
7. Press the SELECT (O) button. If **Recharge now** is selected, the display immediately goes to the Recharge status screen (See Figure 24). If **Automatic** or **Scheduled** are selected, the display goes back to the Main menu (Figure 22).



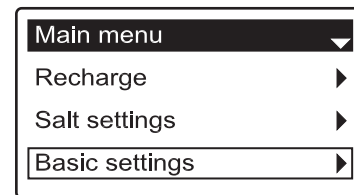
**FIG. 24**

8. Press the LEFT (◀) button (twice from the Recharge status screen) to return to the rolling status screens.

## SETTING THE CURRENT TIME

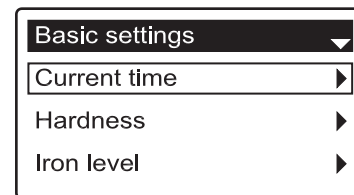
When the softener's electronic control is first powered up, a "wizard" screen prompts you to set the current time (See Page 6). To change the time at a later date, such as after an extended power loss:

1. From any of the rolling status screens, press the SELECT (O) button to display the Main menu.
2. Press the DOWN (▼) button to scroll through the menu options until **Basic settings** is highlighted (See Figure 25).



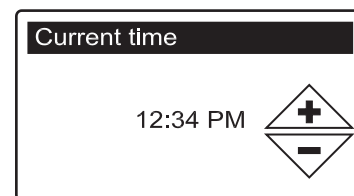
**FIG. 25**

3. Press the SELECT (O) button to display the Basic settings menu (See Figure 26).



**FIG. 26**

4. If necessary, press the DOWN (▼) button to scroll through the menu options until **Current time** is highlighted.
5. Press the SELECT (O) button to display the Current time screen (See Figure 27).



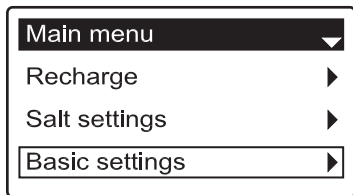
**FIG. 27**

6. Press the UP (▲) or DOWN (▼) buttons to change the time. Hold the button down to rapidly advance. Be sure that AM or PM is correct.
7. Press the SELECT (O) button. The display will go back to the Basic settings menu (Figure 26).
8. Press the LEFT (◀) button twice to return to the rolling status screens.

### SETTING RECHARGE TIME

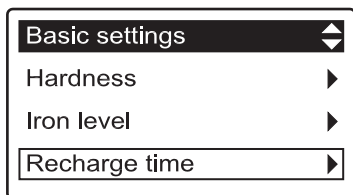
When the softener's electronic control is first powered up, the default time for starting regenerations is 2:00 a.m. This is a good time in most households because water is not being used. To change this time:

1. From any of the rolling status screens, press the SELECT (O) button to display the Main menu.
2. Press the DOWN (▼) button to scroll through the menu options until **Basic settings** is highlighted (See Figure 28).



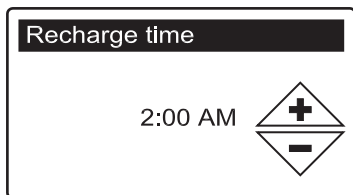
**FIG. 28**

3. Press the SELECT (O) button to display the Basic settings menu (See Figure 29).



**FIG. 29**

4. Press the DOWN (▼) button to scroll through the menu options until **Recharge time** is highlighted.
5. Press the SELECT (O) button to display the Recharge time screen (See Figure 30).



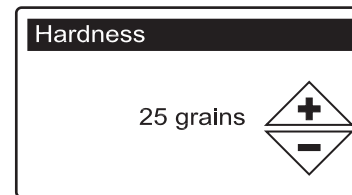
**FIG. 30**

6. Press the UP (▲) or DOWN (▼) buttons to change the recharge time. Hold the button down to rapidly advance. Be sure that AM or PM is correct.
7. Press the SELECT (O) button. The display will go back to the Basic settings menu.
8. Press the LEFT (◀) button twice to return to the rolling status screens.

### SETTING HARDNESS

When the softener's electronic control is first powered up, a "wizard" screen prompts you to enter your water's hardness (See Page 6). To change it:

- 1-3. Go to the **Basic settings** menu by following Steps 1-3 in the "Setting Recharge Time" procedure at left.
4. Press the DOWN (▼) button to scroll through the menu options until **Hardness** is highlighted.
5. Press the SELECT (O) button to display the Hardness screen (See Figure 31).



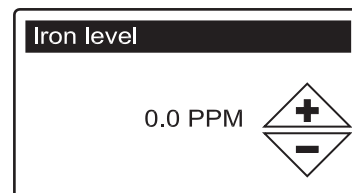
**FIG. 31**

6. Press the UP (▲) or DOWN (▼) buttons to set the value for your water's hardness. Hold the button down to rapidly advance.
7. Press the SELECT (O) button. The display will go back to the Basic settings menu.
8. Press the LEFT (◀) button twice to return to the rolling status screens.

### SETTING IRON LEVEL

When the softener's electronic control is first powered up, a "wizard" screen prompts you to enter your water's iron level (See Page 6). To change it:

- 1-3. Go to the **Basic settings** menu by following Steps 1-3 in the "Setting Recharge Time" procedure at left.
4. Press the DOWN (▼) button to scroll through the menu options until **Iron level** is highlighted.
5. Press the SELECT (O) button to display the Iron level screen (See Figure 32).



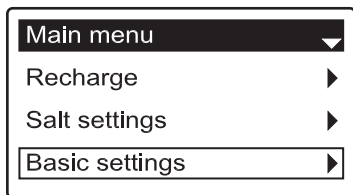
**FIG. 32**

6. Press the UP (▲) or DOWN (▼) buttons to set the value for iron in your water. Hold the button down to rapidly advance.
7. Press the SELECT (O) button. The display will go back to the Basic settings menu.
8. Press the LEFT (◀) button twice to return to the rolling status screens.

**ROLLING SCREENS**

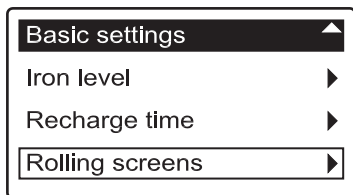
During normal softener operation, four status screens are shown in sequence (See “Softener Status Screens” on Page 7). When the softener’s electronic control is first powered up, the default is to show all four. You can turn on/off individual screens\*:

1. From any of the rolling status screens, press the SELECT (O) button to display the Main menu.
2. Press the DOWN (▼) button to scroll through the menu options until **Basic settings** is highlighted (See Figure 33).



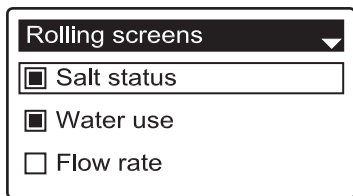
**FIG. 33**

3. Press the SELECT (O) button to display the Basic settings menu (See Figure 34).



**FIG. 34**

4. Press the DOWN (▼) button to scroll through the menu options until **Rolling screens** is highlighted.
5. Press the SELECT (O) button to display the Rolling screens menu (See Figure 35).



**FIG. 35**

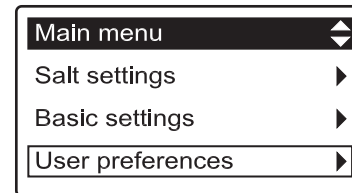
6. Press the DOWN (▼) or UP (▲) buttons to scroll through the list. Items with a black square next to them will be displayed during normal operation.
7. To un-select a screen, make sure its name is highlighted in a box. Then press the SELECT (O) button. The black square will disappear. Pressing SELECT (O) again makes the black square reappear and re-selects the highlighted item. At least one screen must be selected/highlighted.
8. When selections are complete, exit this menu by pressing the LEFT (◀) button. The display will go back to the Basic settings menu.
9. Press the LEFT (◀) button twice to return to the rolling status screens.

\*This does not include service reminders, errors, alarms or Recharge status screens.

**SETTING THE LANGUAGE**

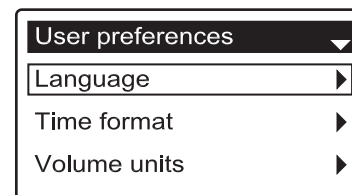
When the softener’s electronic control is first powered up, a “wizard” screen prompts you to set the language (See Page 6). To change the language:

1. From any of the rolling status screens, press the SELECT (O) button to display the Main menu.
2. Press the DOWN (▼) button to scroll through the menu options until **User preferences** is highlighted (See Figure 36).



**FIG. 36**

3. Press the SELECT (O) button to display the User preferences menu (See Figure 37).



**FIG. 37**

4. If necessary, press the DOWN (▼) button to scroll through the menu options until **Language** is highlighted.
5. Press the SELECT (O) button to display the Language menu (See Figure 38).



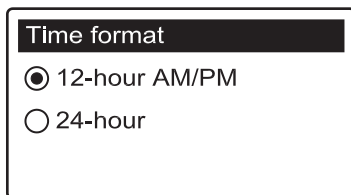
**FIG. 38**

6. Press the DOWN (▼) or UP (▲) buttons to highlight the desired language. The choices are: English, Spanish, French, Italian, German, Dutch, Polish, Russian, Hungarian, Turkish, Lithuanian, Greek or Romanian.
7. Press the SELECT (O) button. The display will go back to the User preferences menu (Figure 37).
8. Press the LEFT (◀) button twice to return to the rolling status screens.

**SETTING TIME FORMAT**

Use this feature to select a 12-hour (AM/PM) or 24-hour clock:

1. From any of the rolling status screens, press the SELECT (O) button to display the Main menu.
2. Press the DOWN (▼) button to scroll through the menu options until **User preferences** is highlighted.
3. Press the SELECT (O) button to display the User preferences menu.
4. Press the DOWN (▼) button to scroll through the menu options until **Time format** is highlighted.
5. Press the SELECT (O) button to display the Time format menu (See Figure 39).



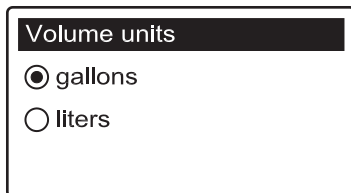
**FIG. 39**

6. Press the DOWN (▼) or UP (▲) buttons to highlight the desired time format.
7. Press the SELECT (O) button. The display will go back to the User preferences menu.
8. Press the LEFT (◀) button twice to return to the rolling status screens.

**SETTING VOLUME UNITS**

Use this feature to select English or Metric volume units:

1. From any of the rolling status screens, press the SELECT (O) button to display the Main menu.
2. Press the DOWN (▼) button to scroll through the menu options until **User preferences** is highlighted.
3. Press the SELECT (O) button to display the User preferences menu.
4. Press the DOWN (▼) button to scroll through the menu options until **Volume units** is highlighted.
5. Press the SELECT (O) button to display the Volume units menu (See Figure 40).



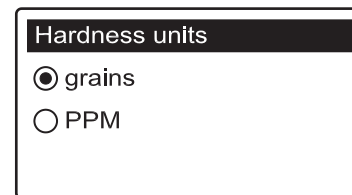
**FIG. 40**

6. Press the DOWN (▼) or UP (▲) buttons to highlight the desired volume units.
7. Press the SELECT (O) button. The display will go back to the User preferences menu.
8. Press the LEFT (◀) button twice to return to the rolling status screens.

**SETTING HARDNESS UNITS**

Use this feature to select grains or parts per million (ppm) as hardness units:

1. From any of the rolling status screens, press the SELECT (O) button to display the Main menu.
2. Press the DOWN (▼) button to scroll through the menu options until **User preferences** is highlighted.
3. Press the SELECT (O) button to display the User preferences menu.
4. Press the DOWN (▼) button to scroll through the menu options until **Hardness units** is highlighted.
5. Press the SELECT (O) button to display the Hardness units menu (See Figure 41).



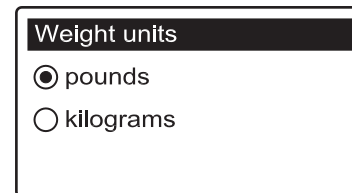
**FIG. 41**

6. Press the DOWN (▼) or UP (▲) buttons to highlight the desired hardness units.
7. Press the SELECT (O) button. The display will go back to the User preferences menu.
8. Press the LEFT (◀) button twice to return to the rolling status screens.

**SETTING WEIGHT UNITS**

Use this feature to select English or Metric weight units:

1. From any of the rolling status screens, press the SELECT (O) button to display the Main menu.
2. Press the DOWN (▼) button to scroll through the menu options until **User preferences** is highlighted.
3. Press the SELECT (O) button to display the User preferences menu.
4. Press the DOWN (▼) button to scroll through the menu options until **Weight units** is highlighted.
5. Press the SELECT (O) button to display the Weight units menu (See Figure 42).



**FIG. 42**

6. Press the DOWN (▼) or UP (▲) buttons to highlight the desired weight units.
7. Press the SELECT (O) button. The display will go back to the User preferences menu.
8. Press the LEFT (◀) button twice to return to the rolling status screens.

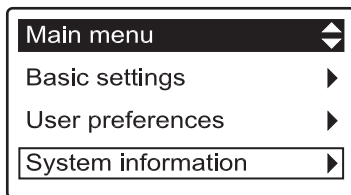
**SYSTEM INFORMATION**

Use these features to look up the following information about the softener and its operations:

- **Model information** (model number and software version)
- **Water available** (softened water ready for use)
- **Daily average water used**
- **Water used today**
- **Total water used** (explained in Step 6, below)
- **Current water flow**
- **Days powered up**
- **Last recharge**
- **Total recharges**

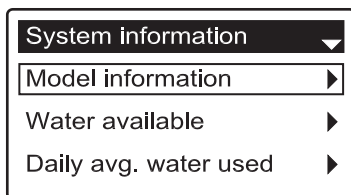
To display one of these screens:

1. From any of the rolling status screens, press the SELECT (O) button to display the Main menu.
2. Press the DOWN (▼) button to scroll through the menu options until **System information** is highlighted (See Figure 43).



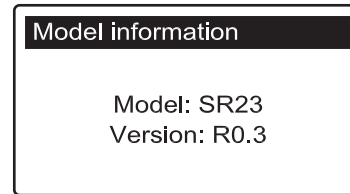
**FIG. 43**

3. Press the SELECT (O) button to display the System information menu (See Figure 44).

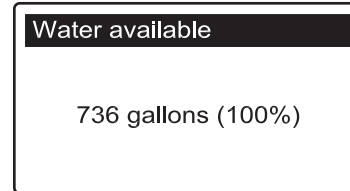


**FIG. 44**

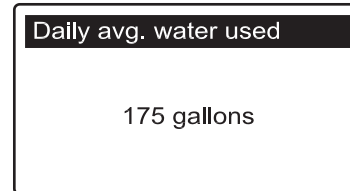
4. Press the DOWN (▼) button to scroll through the menu options until the desired option is highlighted (See list at the top of this column).
5. Press the SELECT (O) button to display the desired information screen (See Figures 45-53).
6. The **Total water used** screen (See Figure 49) shows the volume of water used since it was last reset (it works like the trip odometer in a car). To reset the value to 0, press the RIGHT (▶) button while this screen is displayed.
7. When finished viewing an information screen, press the SELECT (O) button. The display will go back to the System information menu (Figure 44). It will also reset automatically if no buttons are pressed for 4 minutes.
8. Press the LEFT (◀) button twice to return to the rolling status screens.



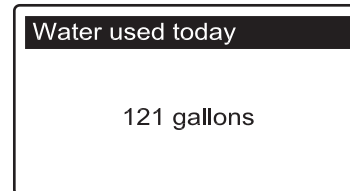
**FIG. 45**



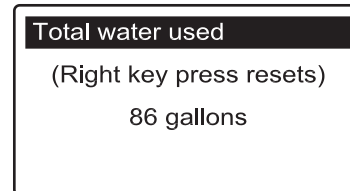
**FIG. 46**



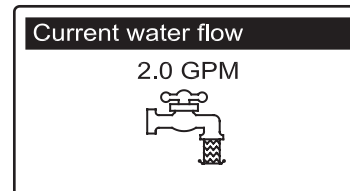
**FIG. 47**



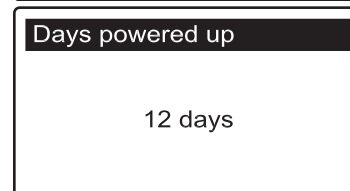
**FIG. 48**



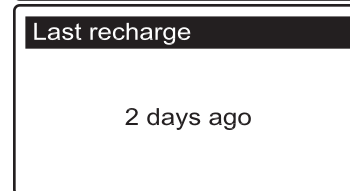
**FIG. 49**



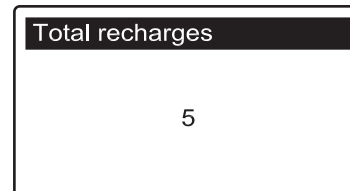
**FIG. 50**



**FIG. 51**



**FIG. 52**



**FIG. 53**

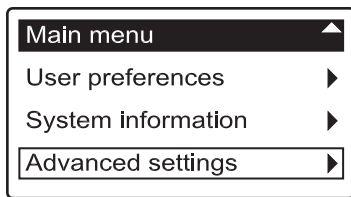
**CYCLE TIMES**

Use these features to change the following softener operations:

- **Backwash time**
- **Second backwash** (turn on or off)
- **Second backwash time**
- **Fast rinse time**

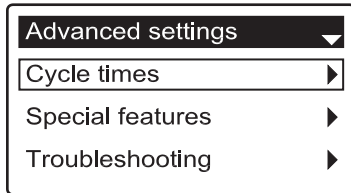
To display these screens:

1. From any of the rolling status screens, press the SELECT (O) button to display the Main menu.
2. Press the DOWN (▼) button to scroll through the menu options until **Advanced settings** is highlighted (See Figure 54).



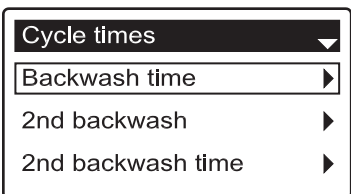
**FIG. 54**

3. Press the SELECT (O) button to display the Advanced settings menu (See Figure 55).



**FIG. 55**

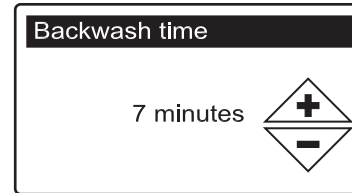
4. If necessary, press the DOWN (▼) button to scroll through the menu options until **Cycle times** is highlighted.
5. Press the SELECT (O) button to display the Cycle times menu (See Figure 56).



**FIG. 56**

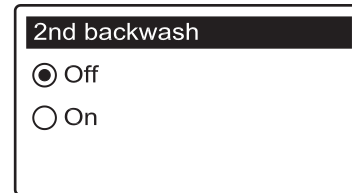
6. Press the DOWN (▼) button to scroll through the menu options until the desired option is highlighted (See list at the top of this column).
7. Press the SELECT (O) button to display the desired information screen (See Figures 57-60).
8. **See the right column on this page for specific instructions on each cycle time screen.**
9. Press the SELECT (O) button. The display will go back to the Cycle times menu (Figure 56).
10. Press the LEFT (◀) button three times to return to the rolling status screens.

- 8a. **Backwash time:** Press the UP (▲) or DOWN (▼) buttons to change the backwash time. Hold the button down to rapidly advance. The backwash time can be set from 1 to 30 minutes (See Figure 57).



**FIG. 57**

- 8b. **Second backwash:** This feature adds a second backwash and rinse to the recharge cycle. Default is Off. Set this feature On if your water supply contains a lot of sediment or iron. Press the DOWN (▼) or UP (▲) buttons to select on or off (See Figure 58).



**FIG. 58**

- 8c. **Second backwash time:** Press the UP (▲) or DOWN (▼) buttons to change the second backwash time. Hold the button down to rapidly advance. The time can be set from 1 to 30 minutes (See Figure 59).



**FIG. 59**

- 8d. **Fast rinse time:** Press the UP (▲) or DOWN (▼) buttons to change the fast rinse time. Hold the button down to rapidly advance. The fast rinse time can be set from 1 to 30 minutes (See Figure 60).



**FIG. 60**

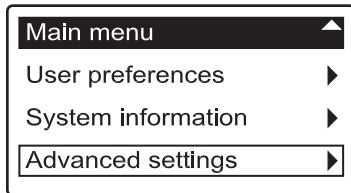
**SPECIAL FEATURES**

Use these features to change the following softener operations:

- **Efficiency mode**
- **Maximum days between recharges**
- **Auxiliary control** (described on Page 17)
- **Chemical feed volume** (described on Page 17)
- **Chemical feed timer** (described on Page 17)
- **97% feature**
- **Service reminder** (described on Page 18)

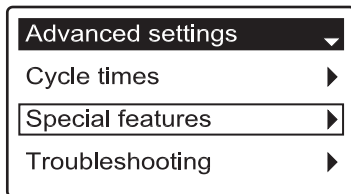
To display one these screens:

1. From any of the rolling status screens, press the SELECT (O) button to display the Main menu.
2. Press the DOWN (▼) button to scroll through the menu options until **Advanced settings** is highlighted (See Figure 61).



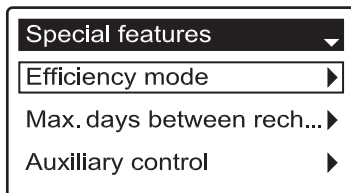
**FIG. 61**

3. Press the SELECT (O) button to display the Advanced settings menu (See Figure 62).



**FIG. 62**

4. Press the DOWN (▼) button to scroll through the menu options until **Special features** is highlighted.
5. Press the SELECT (O) button to display the Special features menu (See Figure 63).

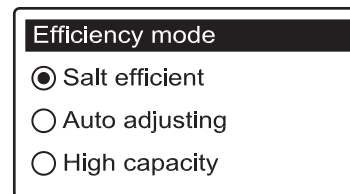


**FIG. 63**

6. Press the DOWN (▼) button to scroll through the menu options until the desired option is highlighted (See list at the top of this column).
7. Press the SELECT (O) button to display the desired information screen (See Figures 64-66).
8. **See the right column on this page for specific instructions on each cycle time screen.**
9. Press the SELECT (O) button. The display will go back to the Special features menu (Figure 63).

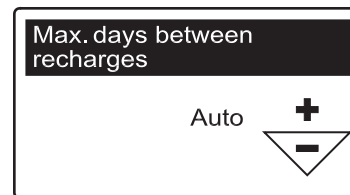
10. Press the LEFT (◀) button three times to return to the rolling status screens.

**8a. Efficiency mode:** The default is **Auto adjusting**, which has a minimum efficiency of 3350 grains/lb. of salt. **High capacity** increases the regeneration salt doses for applications requiring 1.5 PPM or less soft water, or to handle problem water conditions. **Salt efficient** operates at 4000 grains/lb. of salt. Press the UP (▲) or DOWN (▼) buttons to highlight the desired efficiency mode (See Figure 64).



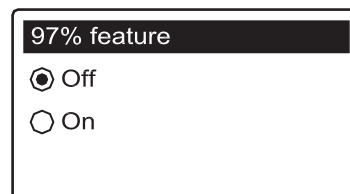
**FIG. 64**

**8b. Maximum days between recharges:** The feature can be set from 1 to 15 days. Setting the number of days below 1 turns the feature off and defaults to automatic control of recharging. Press the UP (▲) or DOWN (▼) buttons to change the number of days (See Figure 65).



**FIG. 65**

**8c. 97% feature:** Default is off. If this feature is on, the softener will automatically regenerate when 97% of capacity is used, at any time of day. Press the DOWN (▼) or UP (▲) buttons to turn the feature on or off (See Figure 66).



**FIG. 66**



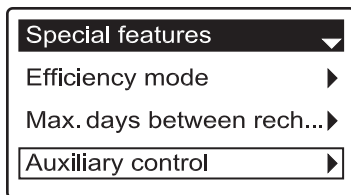
**AUXILIARY CONTROL**

The electronic control has an output which can control external devices for a number of purposes. Such devices may include:

- Chlorine generation
- Bypass function
- Chemical feed equipment
- Water use indication

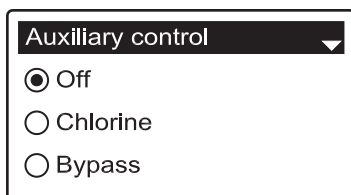
To select one of these auxiliary control modes:

1. From any of the rolling status screens, press the SELECT (O) button to display the Main menu.
2. Press the DOWN (▼) button to scroll through the menu options until **Advanced settings** is highlighted.
3. Press the SELECT (O) button to display the Advanced settings menu.
4. Press the DOWN (▼) button to scroll through the menu options until **Special features** is highlighted.
5. Press the SELECT (O) button to display the Special features menu (See Figure 67).



**FIG. 67**

6. Press the DOWN (▼) button to scroll through the menu options until **Auxiliary control** is highlighted.
7. Press the SELECT (O) button to display the Auxiliary control menu (See Figure 68).



**FIG. 68**

8. Press the DOWN (▼) or UP (▲) buttons to highlight the auxiliary control mode. Default is off.
9. Press the SELECT (O) button. The display will go back to the Special features menu.
10. Press the LEFT (◀) button three times to return to the rolling status screens.

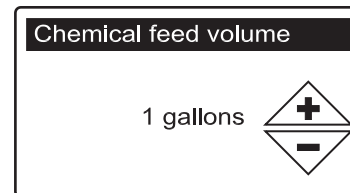
**CHEMICAL FEED**

If the auxiliary control mode has been set to **Chemical feed**, as described in the previous section, two additional lines will appear on the Special features menu:

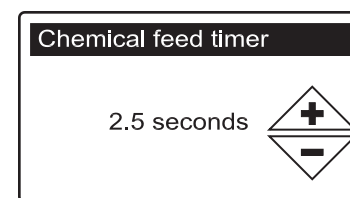
- Chemical feed volume
- Chemical feed timer

To view one of these screens:

1. From any of the rolling status screens, press the SELECT (O) button to display the Main menu.
2. Press the DOWN (▼) button to scroll through the menu options until **Advanced settings** is highlighted.
3. Press the SELECT (O) button to display the Advanced settings menu.
4. Press the DOWN (▼) button to scroll through the menu options until **Special features** is highlighted.
5. Press the SELECT (O) button to display the Special features menu (See Figure 67).
6. Press the DOWN (▼) button to scroll through the menu options until **Chemical feed volume** or **Chemical feed timer** is highlighted.
7. Press the SELECT (O) button to display the Chemical feed volume or Chemical feed timer menu (See Figures 69 & 70).



**FIG. 69**

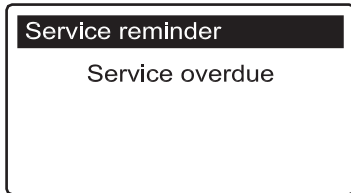


**FIG. 70**

8. Press the UP (▲) or DOWN (▼) buttons to change the value. Hold the button down to rapidly advance. **Chemical feed volume** is the amount of water which will pass through the softener between each activation of the chemical feed equipment. **Chemical feed timer** is how long the output to the chemical feed equipment is energized each time it is activated.
9. Press the SELECT (O) button. The display will go back to the Special features menu.
10. Press the LEFT (◀) button three times to return to the rolling status screens.

**SERVICE REMINDER**

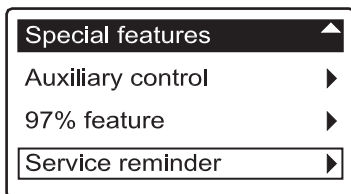
Use this feature to program the number of months (up to 24) before a “Service overdue” message will appear instead of the rolling status screens (See Figure 71).



**FIG. 71**

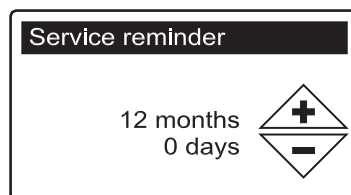
This will be a reminder to call your dealer for service. Once it has been programmed, this screen displays the number of months and days left until the service reminder:

1. From any of the rolling status screens, press the SELECT (O) button to display the Main menu.
2. Press the DOWN (▼) button to scroll through the menu options until Advanced settings is highlighted.
3. Press the SELECT (O) button to display the Advanced settings menu.
4. Press the DOWN (▼) button to scroll through the menu options until **Special features** is highlighted.
5. Press the SELECT (O) button to display the Special features menu (See Figure 72).



**FIG. 72**

6. Press the DOWN (▼) button to scroll through the menu options until **Service reminder** is highlighted.
7. Press the SELECT (O) button to display the Service reminder screen (See Figure 73).



**FIG. 73**

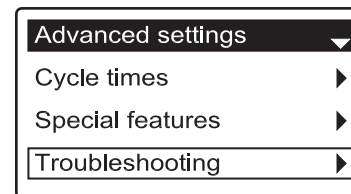
8. Press the UP (▲) or DOWN (▼) buttons to set the number of months until the service reminder appears. Repeatedly pressing the DOWN (▼) button until the display reads “Off” turns this feature off and zeros the number of months and days.
9. Press the SELECT (O) button. The display will go back to the Special features menu (Figure 72).
10. Press the LEFT (◀) button twice to return to the rolling status screens.

**SEND E.A.S.E. MESSAGE**

With E.A.S.E. (Electronic Automated Service Evaluation), a homeowner or service technician can transmit operational data via a phone line for diagnostic purposes. Ask your participating EcoWater Systems dealer for more information.

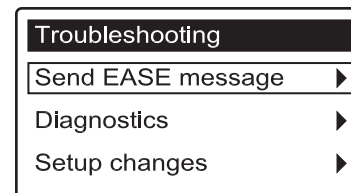
To send an E.A.S.E. message:

1. From any of the rolling status screens, press the SELECT (O) button to display the Main menu.
2. Press the DOWN (▼) button to scroll through the menu options until **Advanced settings** is highlighted.
3. Press the SELECT (O) button to display the Advanced settings menu (See Figure 74).



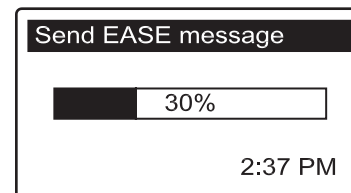
**FIG. 74**

4. Press the DOWN (▼) button to scroll through the menu options until **Troubleshooting** is highlighted.
5. Press the SELECT (O) button to display the Troubleshooting menu (See Figure 75).



**FIG. 75**

6. If necessary, press the DOWN (▼) button to scroll through the menu options until **Send EASE message** is highlighted.
7. Press the SELECT (O) button to display the Send EASE message screen and begin transmission (See Figure 76).



**FIG. 76**

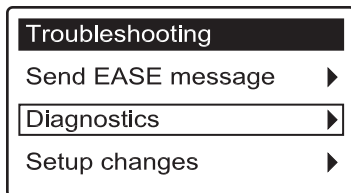
8. A bar is displayed showing the transmission’s progress. Once completed, the Troubleshooting screen immediately reappears (Figure 75).
9. Press the LEFT (◀) button twice to return to the rolling status screens.

**DIAGNOSTICS**

This feature allows a service technician to check the operating state of individual components in the softener (e.g. valve position) to troubleshoot problems. **If an error code is displayed in place of the rolling status screens, call your dealer for service.**

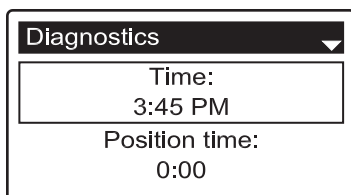
To view the Diagnostics screen:

1. If an error code is displayed, skip Steps 2-7 and go directly to Step 8.
2. To display the Diagnostics screen from any of the rolling status screens (when an error code is not displayed), press the SELECT (O) button to display the Main menu.
3. Press the DOWN (▼) button to scroll through the menu options until **Advanced settings** is highlighted.
4. Press the SELECT (O) button to display the Advanced settings menu.
5. Press the DOWN (▼) button to scroll through the menu options until **Troubleshooting** is highlighted.
6. Press the SELECT (O) button to display the Troubleshooting menu (See Figure 77).



**FIG. 77**

7. Press the DOWN (▼) button to scroll through the menu options until **Diagnostics** is highlighted.
8. Press the SELECT (O) button to display the Diagnostics menu (See Figure 78).



**FIG. 78**

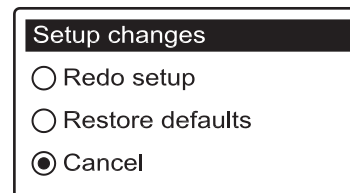
9. Press the DOWN (▼) or UP (▲) buttons to scroll through the list. The following items are displayed:
  - **Time** (current)
  - **Position time** (counts down the time remaining in the current valve position)
  - **Current position** (of the valve: service, fill, brine, backwash, fast rinse or moving)
  - **Requested position** (of the valve)
  - **Motor state** (on or off)
  - **Valve position switch** (open or closed)
  - **Turbine count** (indicates water flow)
  - **Tank light switch** (open or closed)
  - **RF module** (detected or not)
  - **Error code** (call for service if displayed)

10. When finished viewing the Diagnostics screen, press the SELECT (O) button. The display will go back to the Troubleshooting menu.
11. Press the LEFT (◀) button three times to return to the rolling status screens (or error code screen if an error condition exists).

**SETUP CHANGES**

This feature allows a service technician to repeat the setup procedure (See Page 6) or restore the softener's default operating values:

1. From any of the rolling status screens, press the SELECT (O) button to display the Main menu.
2. Press the DOWN (▼) button to scroll through the menu options until **Advanced settings** is highlighted.
3. Press the SELECT (O) button to display the Advanced settings menu.
4. Press the DOWN (▼) button to scroll through the menu options until **Troubleshooting** is highlighted.
5. Press the SELECT (O) button to display the Troubleshooting menu (See Figure 77).
6. Press the DOWN (▼) button to scroll through the menu options until **Setup changes** is highlighted.
7. Press the SELECT (O) button to display the Setup changes menu (See Figure 79).



**FIG. 79**

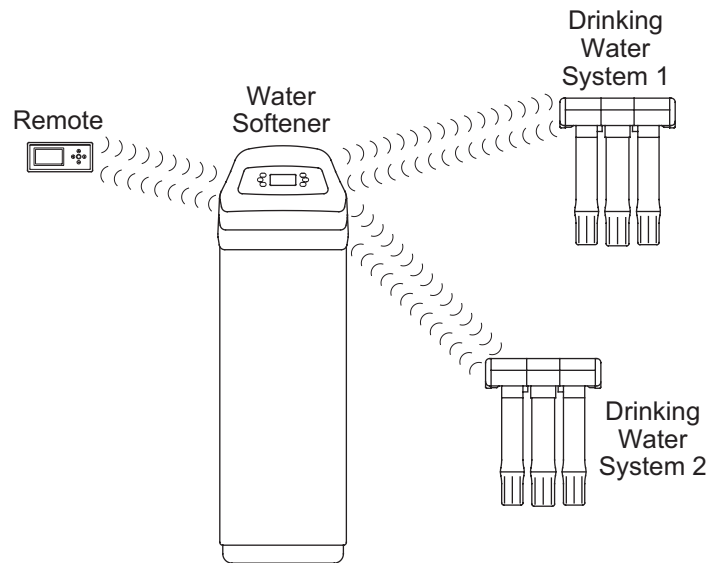
8. Press the UP (▲) or DOWN (▼) buttons to highlight the desired option. **Redo setup** allows you to select a different model (intended to be used for upgrades or retrofits of existing softeners). **Restore defaults** will take you through the "wizard" screen setup procedure (See Page 6). **Cancel** will return to the Troubleshooting menu (Figure 77).
9. Press the SELECT (O) button.

**HOW IT WORKS**

The EcoWater Systems remote monitor is part of a wireless communication system (operating at a radio frequency) which monitors multiple water treatment devices in a home. These water treatment devices include water softener(s) and drinking water filter(s) equipped to communicate with this type of system (See Figure 80). The remote can display, in a convenient, central location, useful operating information.

Once devices capable of communicating with the system have been added to the remote (See “Adding a Device” on Page 22), the remote’s normal operating mode displays a sequence of screens showing the status of each device in the system (See Figure 81), and any active alerts, such as “Low salt.”

In addition to monitoring water treatment devices, the remote can also control some water softener operations, such as initiating a manual recharge.

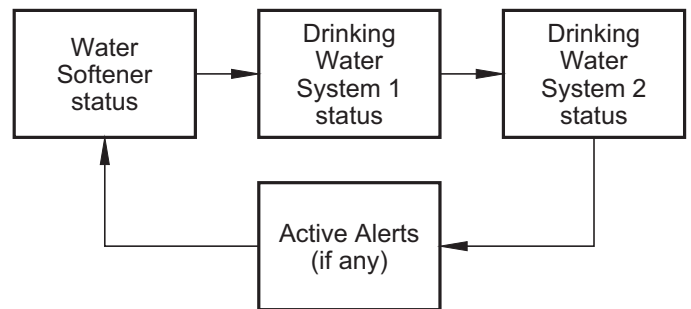


**FIG. 80**

**“GOSSIP” SYSTEM**

The devices in the system exchange information in a loosely coupled “gossip” network. AC powered devices, such as softeners, listen for new data all the time and act as data hubs. Battery powered devices like the remote check for information at regular intervals, to conserve battery life. Battery powered devices like drinking water systems do not communicate directly with each other or the remote, but pass along information through AC powered devices. At least one AC powered device must be part of any network (usually a water softener).

It is not necessary for every device in a network to be in radio range of all others. Information one device communicates to any other device will be passed along (like gossip) to all devices in the network.



**FIG. 81**

**FCC CLASS B DEVICE STATEMENT**

**NOTE:** This equipment has been tested and found to comply with the limits for a Class B digital device, pursuant to Part 15 of the FCC Rules. These limits are designed to provide reasonable protection against harmful interference in a residential installation. This equipment generates, uses, and can radiate radio frequency energy and, if not installed and used in accordance with the instructions may cause harmful interference to radio communications. However, there is no guarantee that interference will not occur in a particular installation. If this equipment does cause harmful interference to radio or television reception, which can be determined by turning the equipment off and on, the user is encouraged to try to correct the interfer-

ence by one or more of the following measures:

- Reorient or relocate the receiving antenna.
- Increase the separation between the equipment and receiver.
- Connect the equipment into an outlet on a circuit different from that to which the receiver is connected.
- Consult the dealer or an experienced radio/TV technician for help.

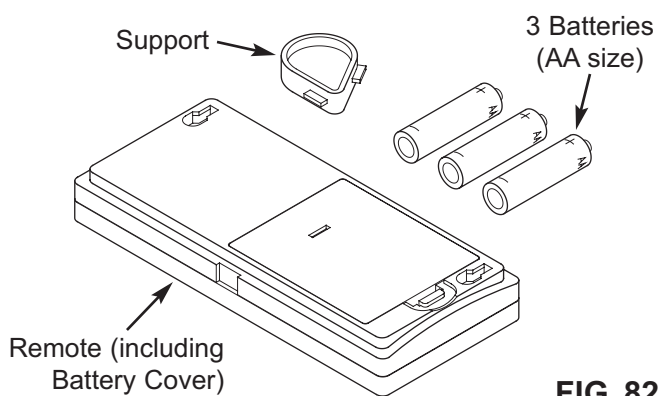
Changes or modifications not expressly approved by EcoWater Systems could void the user’s authority to operate the equipment.

**UNPACKING**

The EcoWater Systems remote monitor is shipped from the factory in one carton. Thoroughly check for possible shipping damage and parts loss. Also note any damage to the shipping carton. Notify the transportation company if damage is present. EcoWater Systems is not responsible for in-transit damages.

Remove and discard (RECYCLE) all packing materials.

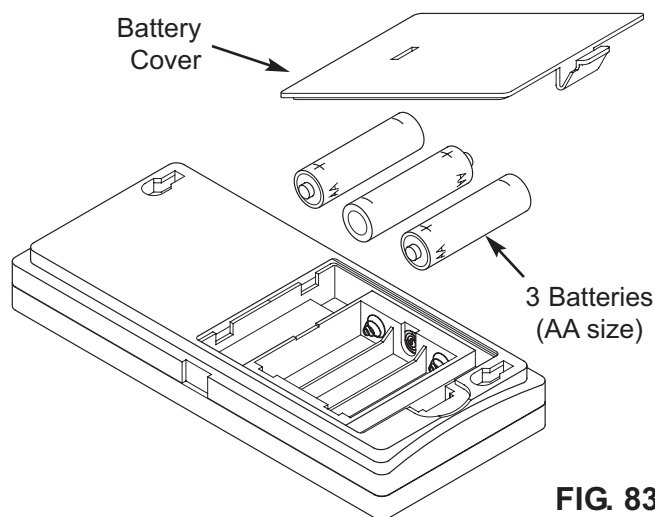
**ITEMS INCLUDED WITH SHIPMENT**



**FIG. 82**

**INSTALLING BATTERIES**

1. Remove the battery cover from the back of the remote.
2. Install three (3) AA size batteries, making sure that they are oriented to match the + and - markings inside the battery compartment (See Figure 83).
3. Snap the battery cover back in place.

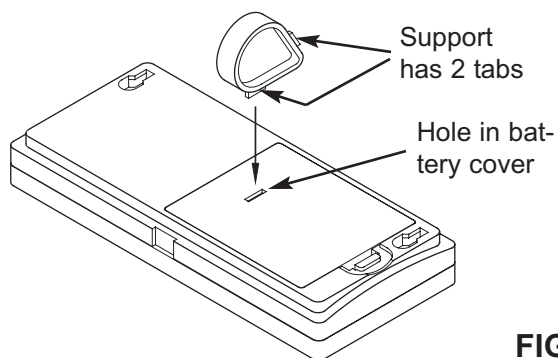


**FIG. 83**

**INSTALLING THE SUPPORT**

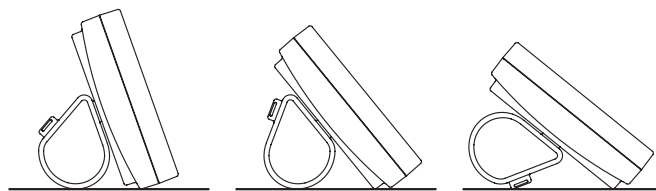
The EcoWater Systems remote monitor is shipped with a teardrop-shaped support to hold the unit at an angle when placed on a horizontal surface.

1. Snap one of the support's two tabs into the rectangular hole on the back of the remote's case (See Figure 84).



**FIG. 84**

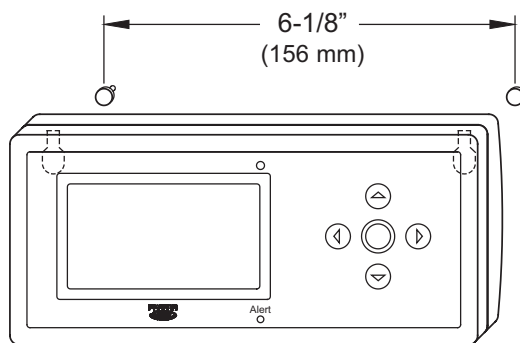
2. The angle may be adjusted by reorienting the support in the battery cover (See Figure 85).



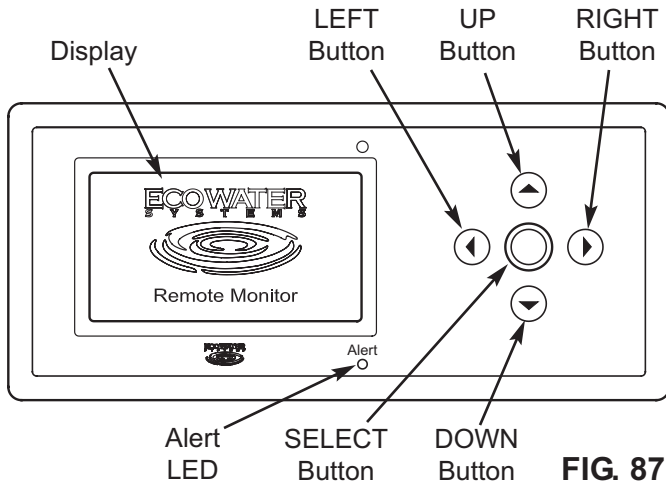
**FIG. 85**

**OPTIONAL WALL MOUNTING**

The EcoWater Systems remote monitor (without the support) may also be mounted on a wall. If this option is desired, install two fasteners (not included) at a convenient height, spaced 6-1/8" (156 mm) apart (See Figure 86).



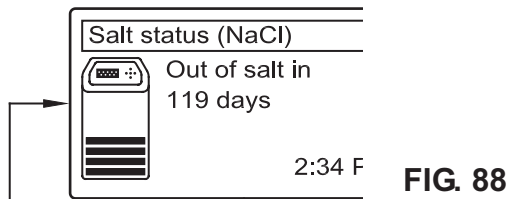
**FIG. 86**



**FIG. 87**

**NAVIGATING THE SCREENS**

When the remote is powered up (by installing the batteries), a logo will briefly appear in the display. The display will then automatically cycle between screens showing the status of any water treatment devices (softener, drinking water system) communicating with the remote. To manually go to the next screen in the sequence, press the LEFT (◀) or RIGHT (▶) buttons.



**FIG. 88**

Some screens have more information than can be shown at one time (for example, the softener status display shown in Figure 88). A down arrow (▼) in the lower right corner indicates that there is more information below. Use the DOWN (▼) button to scroll through the additional lines.

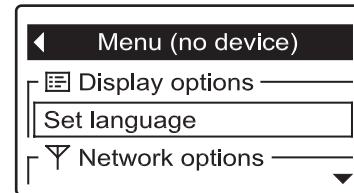
**NAVIGATING MENUS**

Menus are lists of options that program how the system will operate and how information will be displayed. When a menu is displayed, one item in the list is highlighted. Press the DOWN (▼) button to move to the next item in the list, and the UP (▲) button to go back. To select the item currently highlighted, press the SELECT button (See Figure 87). To exit a menu without selecting anything, press the LEFT (◀) button.

**ADDING A DEVICE**

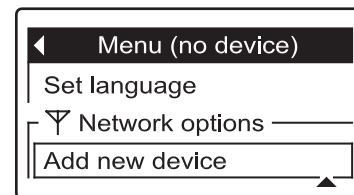
To initiate communication between the remote and a device such as a water softener, it is necessary to add the device to the remote by doing the following:

1. Press the remote's SELECT (○) button to display a menu screen. The header will turn black (See Figure 89).



**FIG. 89**

2. Press the DOWN (▼) button to scroll through the menu options until **Add new device** is highlighted in a box (See Figure 90).



**FIG. 90**

3. Press the SELECT (○) button, and the screen shown in Figure 91 appears. The remote waits 30 seconds for the device to be activated (following the instructions in that device's manual). For complete instructions on adding the softener, refer to "Connecting to Remote" on Page 8 of this manual.



**FIG. 91**

4. When the remote detects a signal from the device, the display will change to show the device's name and that it has been added to the remote (See Figure 92).



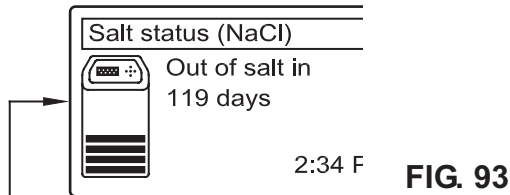
**FIG. 92**

5. To exit this screen, press the LEFT (◀) button or wait 30 seconds for it to reset automatically.

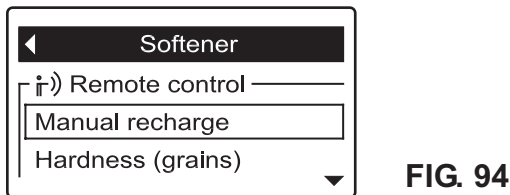
**REMOVING A DEVICE**

To remove a device from the remote:

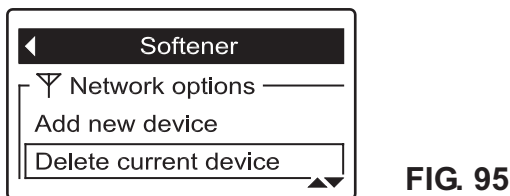
1. Press the remote's LEFT (◀) or RIGHT (▶) buttons to manually advance to the status screen for the device to remove. The device name will show in the header. (See Figure 93).



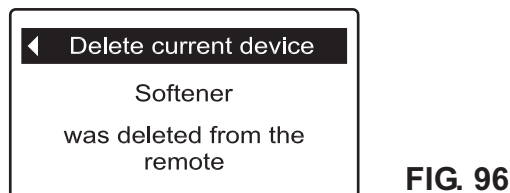
2. Press the remote's SELECT (○) button to display a menu screen. The header will turn black (See Figure 94).



3. Press the DOWN (▼) button to scroll through the menu options until **Delete current device** is highlighted in a box (See Figure 95).



4. Press the SELECT (○) button, and the screen shown in Figure 96 should appear.

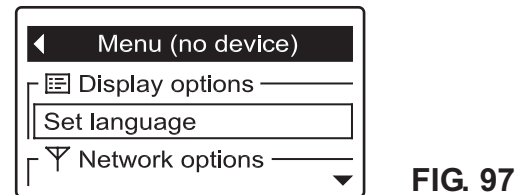


5. To exit this screen, press the LEFT (◀) button or wait 30 seconds for it to reset automatically.

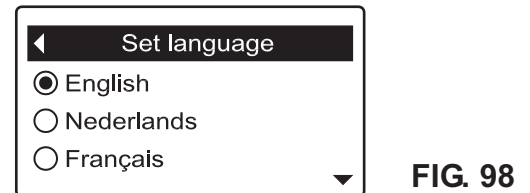
**CHANGING THE LANGUAGE**

The EcoWater Systems remote monitor can display menus and system status messages in one of several languages. To change to a different language:

1. Press the remote's SELECT (○) button to display a menu screen. The header will turn black (See Figure 97).
2. If necessary, press the DOWN (▼) button to scroll through the menu options until **Set language** is highlighted in a box (See Figure 97).



3. Press the SELECT (○) button to display the Set language menu (See Figure 98). The current language is highlighted with a dot.



4. Press the DOWN (▼) or UP (▲) buttons to scroll through the list of languages until the desired language is highlighted (See Figure 99).



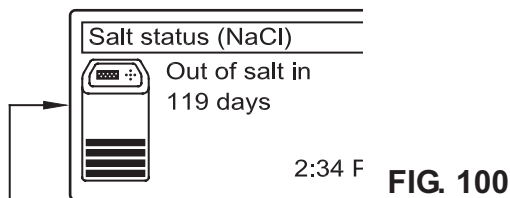
5. Press the SELECT (○) button. The display will go back to the menu shown in Figure 97, in the newly set language.
6. To exit this menu, press the LEFT (◀) button or wait 30 seconds for it to reset automatically.

**CHECKING RF SIGNAL STRENGTH**

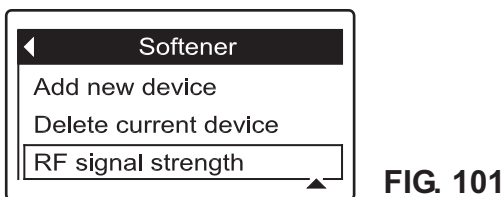
During installation of a system, it is useful to check the strength of the signal from the water treatment device. The signal detected by the remote may be checked on a device-by-device basis. As described on Page 20 (“Gossip” System), the remote receives direct signals from AC powered devices, such as softeners. Battery powered devices like drinking water systems pass their information along indirectly, by way of the AC devices. If you check the signal strength of a device not in direct communication with the remote, the display will show the strength of the “weakest link” in the chain of communication to the remote.

To check the signal strength for a particular device

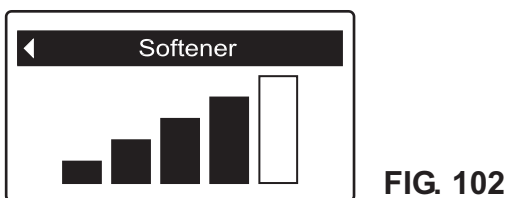
1. Press the remote’s LEFT (◀) or RIGHT (▶) buttons to manually advance to the status screen for the device you want to check. The device name will show in the header. (See Figure 100).



2. Press the remote’s SELECT (○) button to display a menu screen. The header will turn black.
3. Press the DOWN (▼) button to scroll through the menu options until **RF signal strength** is highlighted in a box (See Figure 101).



4. Press the SELECT (○) button, and the screen shown in Figure 102 will appear. The more bars that are filled in black, the stronger the signal.



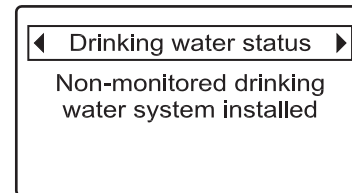
5. To exit this screen, press the LEFT (◀) button.

**DRINKING WATER STATUS MESSAGE**

If a communications-capable drinking water filtration system has been added to the remote, it will have its own status screen displayed during normal operation. Otherwise, a drinking water status screen will display one of the two messages shown in Figure 105.

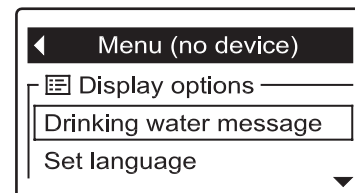
If the message displayed is not appropriate to your system, change it as follows:

1. Press the remote’s LEFT (◀) or RIGHT (▶) buttons to manually advance to the Drinking water status screen (See Figure 103).



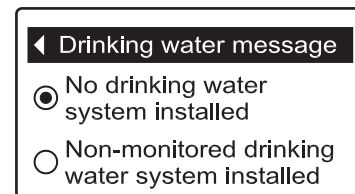
**FIG. 103**

2. Press the remote’s SELECT (○) button to display a menu screen. The header will turn black (See Figure 102).
3. If necessary, press the DOWN (▼) button to scroll through the menu options until **Drinking water message** is highlighted in a box (See Figure 104).



**FIG. 104**

4. Press the SELECT (○) button to display the Drinking water message menu (See Figure 105).



**FIG. 105**

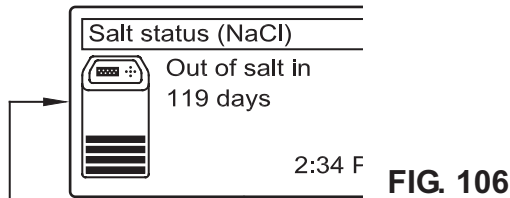
5. Press the DOWN (▼) or UP (▲) buttons to scroll between the two messages until the desired message is highlighted.
6. Press the SELECT (○) button. The display will go back to the menu shown in Figure 104.
7. Press the LEFT (◀) button to exit this menu, or wait 30 seconds for it to reset automatically.



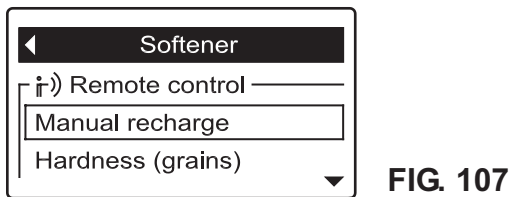
**MANUALLY RECHARGING THE SOFTENER**

To initiate a manual recharge of the softener using the remote, or to schedule one for tonight:

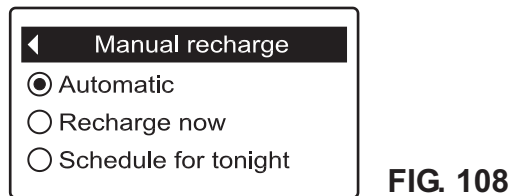
1. Press the remote's LEFT (◀) or RIGHT (▶) buttons to manually advance to the Softener status screen (See Figure 106).



2. Press the remote's SELECT (○) button to display a menu screen. The header will turn black (See Figure 107).
3. If necessary, press the DOWN (▼) button to scroll through the menu options until **Manual recharge** is highlighted in a box (See Figure 107).



4. Press the SELECT (○) button to display the Manual recharge menu (See Figure 108).



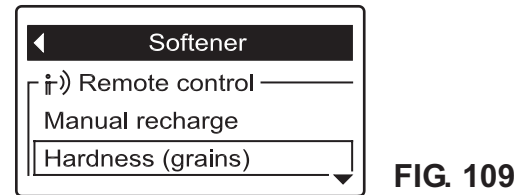
5. Press the DOWN (▼) or UP (▲) buttons to scroll between the options until the desired option is highlighted with a dot.
6. Press the SELECT (○) button. The display will go back to the Softener menu (Figure 107).
7. Press the LEFT (◀) button to exit this menu, or wait 30 seconds for it to reset automatically.

**SETTING THE SOFTENER HARDNESS**

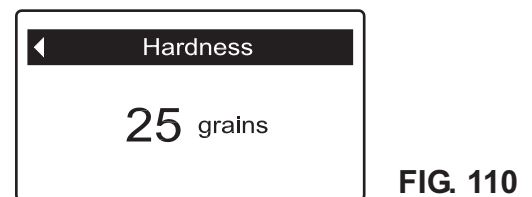
The softener uses a computer program to calculate when it performs automatic recharges. Water usage and hardness are factored into this calculation. The softener measures water usage, but a value of hardness from the local water supply must be entered manually. This is important, as it will optimize the softener's efficiency and prevent it from either using too much salt or not softening the water.

To change the water hardness setting of the softener using the remote:

1. Press the remote's LEFT (◀) or RIGHT (▶) buttons to manually advance to the Softener status screen (See Figure 106).
2. Press the remote's SELECT (○) button to display a menu screen. The header will turn black (See Figure 107).
3. Press the DOWN (▼) button to scroll through the menu options until **Hardness** is highlighted in a box (See Figure 109).



4. Press the SELECT (○) button to display the "Hardness" screen (See Figure 110).

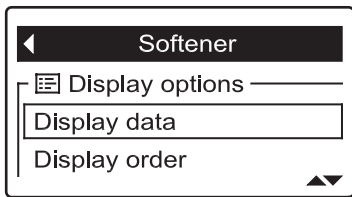


5. Press the UP (▲) or DOWN (▼) buttons to increase or decrease the hardness setting, until the desired value is displayed.
6. Press the SELECT (○) button. The display will go back to the softener menu (Figure 107).
7. Press the LEFT (◀) button to exit this menu, or wait 30 seconds for it to reset automatically.

**CHANGING WHICH DATA ITEMS ARE DISPLAYED IN THE STATUS SCREENS**

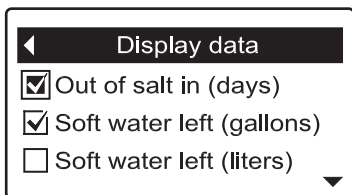
Each device (softener, filter, etc.) has a status screen which the remote displays during normal operation. The data displayed may be customized, as follows:

1. Press the remote's LEFT (◀) or RIGHT (▶) buttons to manually advance to the status screen you want to customize. For example, to change the data for the softener, manually advance to the Softener status screen.
2. Press the remote's SELECT (○) button to display a menu screen. The header will turn black.
3. Press the DOWN (▼) button to scroll through the menu options until **Display data** is highlighted in a box (See Figure 111).



**FIG. 111**

4. Press the SELECT (○) button to display the Display data screen (See Figure 112).



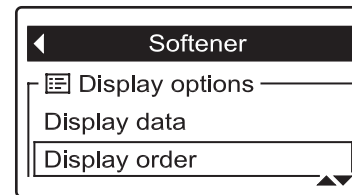
**FIG. 112**

5. Press the DOWN (▼) or UP (▲) buttons to scroll through the list of display data items. Items with a check mark in the box next to them will be displayed during normal operation.
6. To select an unchecked display data item, make sure the box next to the item's name is highlighted (box is black). Then press the SELECT (○) button. The check mark will appear in the box.
7. To un-select a checked display data item, make sure the box next to the item's name is highlighted (box is black). Then press the SELECT (○) button. The check mark will disappear.
8. When selections are complete, exit this menu by pressing the LEFT (◀) button. The display will go back to the device menu.
9. Press the LEFT (◀) button to exit this menu, or wait 30 seconds for it to reset automatically.

**CHANGING THE ORDER OF DATA ITEMS DISPLAYED IN THE STATUS SCREENS**

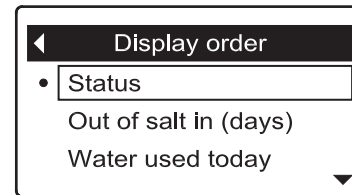
In addition to changing which data items the remote displays during normal operation, the order of these items may be customized, as follows:

1. Press the remote's LEFT (◀) or RIGHT (▶) buttons to manually advance to the status screen you want to customize. For example, to change the order of the softener's screen, manually advance to the Softener status screen.
2. Press the remote's SELECT (○) button to display a menu screen. The header will turn black.
3. Press the DOWN (▼) button to scroll through the menu options until **Display order** is highlighted in a box (See Figure 113).



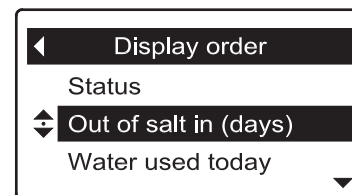
**FIG. 113**

4. Press the SELECT (○) button to display the Display order screen (See Figure 114).



**FIG. 114**

5. Press the DOWN (▼) or UP (▲) buttons to scroll through the list of display data items. Stop when the item you want to move is highlighted in a box.
6. Press the SELECT (○) button. Arrows will appear next to the item (See Figure 115).



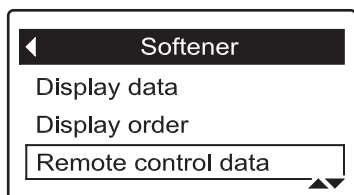
**FIG. 115**

7. Press the UP (▲) or DOWN (▼) buttons to move the item higher or lower in the list.
8. When the item is where you want it in the list, press the SELECT (○) button. The arrows next to the item will disappear.
9. To move another item, return to Step 5. When finished moving items, press the LEFT (◀) button. The display will go back to the device menu.

## CHANGING WHICH DATA ITEMS MAY BE REMOTELY CONTROLLED

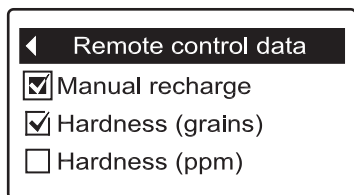
Some devices (softeners, for example) have a list of data items which may be controlled by the remote. Remote control items may be customized, as follows:

1. Press the remote's LEFT (◀) or RIGHT (▶) buttons to manually advance to the status screen of the device you want to customize. For example, to change the data for the softener, manually advance to the Softener status screen.
2. Press the remote's SELECT (○) button to display a menu screen. The header will turn black.
3. Press the DOWN (▼) button to scroll through the menu options until **Remote control data** is highlighted in a box (See Figure 116).



**FIG. 116**

4. Press the SELECT (○) button to display the Remote control data screen (See Figure 117).



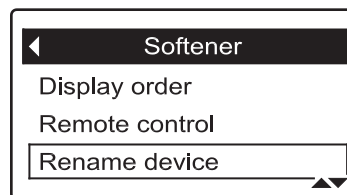
**FIG. 117**

5. Press the DOWN (▼) or UP (▲) buttons to scroll through the list of remote control items. Items with a check mark in the box next to them will be controllable using the remote.
6. To select an unchecked remote control item, make sure the box next to the item's name is highlighted (box is black). Then press the SELECT (○) button. The check mark will appear in the box.
7. To un-select a checked remote control item, make sure the box next to the item's name is highlighted (box is black). Then press the SELECT (○) button. The check mark will disappear.
8. When selections are complete, exit this menu by pressing the LEFT (◀) button. The display will go back to the device menu.
9. Press the LEFT (◀) button to exit this menu, or wait 30 seconds for it to reset automatically.

## RENAMING A DEVICE

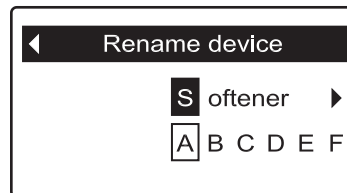
Each device (softener, filter, etc.) in the system has a default name in the header of its status screen. The name may be customized (up to 20 characters long), as follows:

1. Press the remote's LEFT (◀) or RIGHT (▶) buttons to manually advance to the status screen of the device you want to rename. For example, to rename the softener, manually advance to the Softener status screen.
2. Press the remote's SELECT (○) button to display a menu screen. The header will turn black.
3. Press the DOWN (▼) button to scroll through the menu options until **Rename device** is highlighted in a box (See Figure 118).



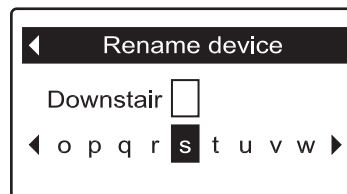
**FIG. 118**

4. Press the SELECT (○) button to display the Rename device screen (See Figure 119).



**FIG. 119**

5. Two lines are displayed below the header. The upper line shows the device name. The lower line is the list of available characters (upper and lower case alphabets, space character, numbers and common punctuation marks). Use the RIGHT (▶) or LEFT (◀) buttons to highlight the first character you want to replace in the old device name.
6. Press DOWN (▼) to switch to the lower line.
7. Press the RIGHT (▶) or LEFT (◀) buttons to scroll through the character list. Stop when the character you want to select is highlighted (See Fig. 120).



**FIG. 120**

8. Press the SELECT (○) button. The character you picked is added to the upper line.
9. To select the next character, return to Step 7. When finished entering the device name, press the UP (▲) button to switch to the upper line, then press SELECT (○) to go back to the device menu.



EcoWater Systems  
P.O. Box 64420, St. Paul, MN 55164-0420  
1-800-86WATER

---