



Motion Sensor with Pet Immunity Installation Instructions

Product Overview

- Z-Wave+™ enabled device which transmits upon detection of movement
- Configurable to be less sensitive to the movement of small and medium size household pets
- Reports tamper condition if cover is removed

Product Specifications

- For indoor use only
- Operating frequency: 908.42 MHz
- Operating range: Up to 100 feet (30.5 meters) line-of-sight
- Operating temperature: 0°C to 49°C, 32°F to 120°F (ambient temperature)
- Detection radius: 39 feet (see detection region diagram)
- Detection angle: 45 degrees in either direction from the sensor's center (see detection region diagram)
- Battery type: 3V Lithium CR123A
- Battery life: approximately 3 years
- Passive Infrared (PIR) based technology



Network Inclusion

The sensor must be added to a Z-Wave network prior to use. To include the sensor in a network both the sensor and the network controller must be in inclusion mode at the same time. *Refer to the instructions provided by the manufacturer of your specific controller for details on initiating the controller's inclusion mode.*

STEP ONE Start by placing the controller into inclusion mode.

STEP TWO Activate inclusion mode for the sensor by removing the battery isolation pull tab, or by inserting the battery (see next section for battery installation tips). When the inclusion process is complete the red LED will turn on for approximately 10 seconds and then it will go out. If the LED continues to flash repeat the inclusion process.

STEP THREE Test the motion sensor before mounting it. Place the sensor in an unoccupied room. Leave the room for at least 4 minutes. Return to the room and pass in front of the sensor lens. The LED will flash once to indicate that motion was detected.



Notes:

- Sensor inclusion mode can also be initiated by inserting a pin or paper clip into the small round hole on the back side of the sensor.
- The sensor also features a test mode so that motion detection can be tested without waiting 4 minutes. For more information refer to the “Test Mode” section of these instructions.

Network Inclusion: Key Points to Remember

- *Controller inclusion mode must be activated BEFORE starting sensor inclusion mode.*
- *The sensor can only be included into one controller network at a time, and must be excluded from one network before inclusion in another.*
- *Removing the pull tab connects the battery and initiates sensor inclusion mode. Inclusion mode can also be initiated by removing the battery for at least 5 seconds, reinstalling the battery, then replacing the sensor cover.*
- *The plastic pull tab must be removed to enable sensor operation.*
- *The sensor automatically enters inclusion mode at power-up.*
- **Exclusion mode** on the sensor is initiated following the same exact procedure as inclusion.

Battery Installation Tips

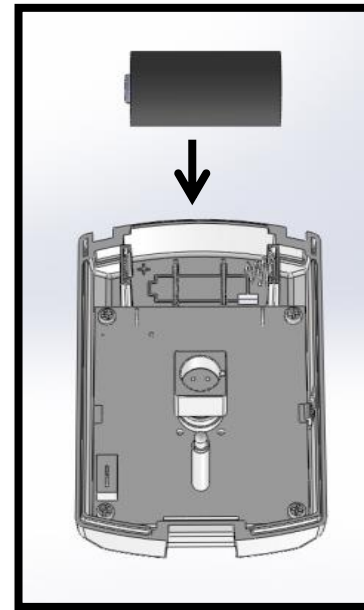
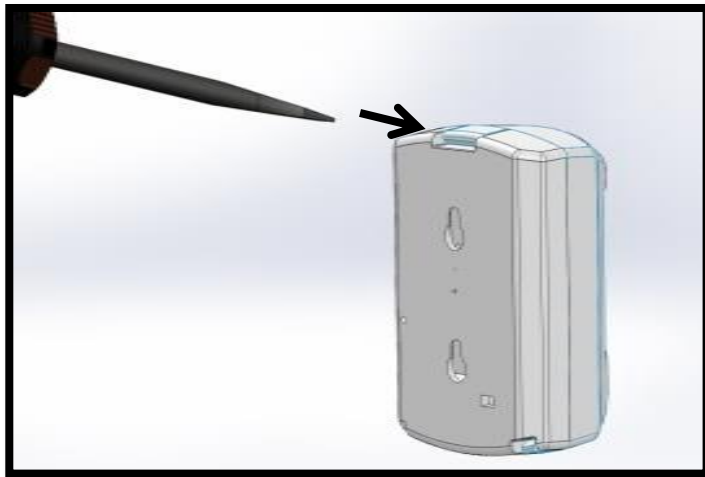

Installation

The package contains the following:

© 2015 Ecolink Intelligent Technology Inc.

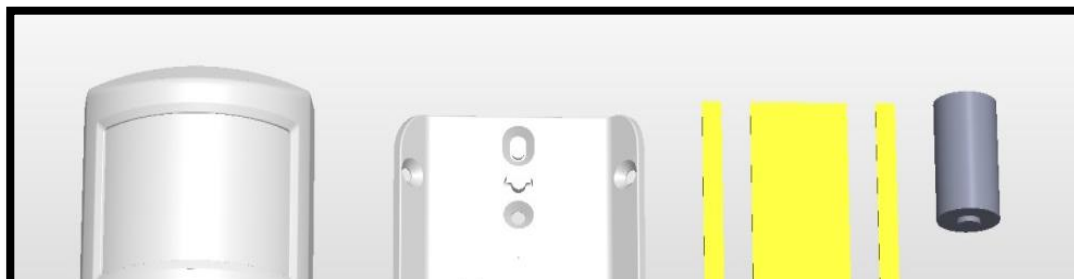

VE2 R1.03



- 1x Sensor
- 1x Sensor mounting bracket
- 4x screws
- 2x jumper
- 1x battery
- 3x pieces of adhesive tape

STEP ONE Mount bracket to wall

First attach the sensor mounting bracket to the wall using either adhesive tape OR screws (optional). For best performance mount the bracket 6.5 to 7.5 feet above the floor (2 to 2.3 meters).

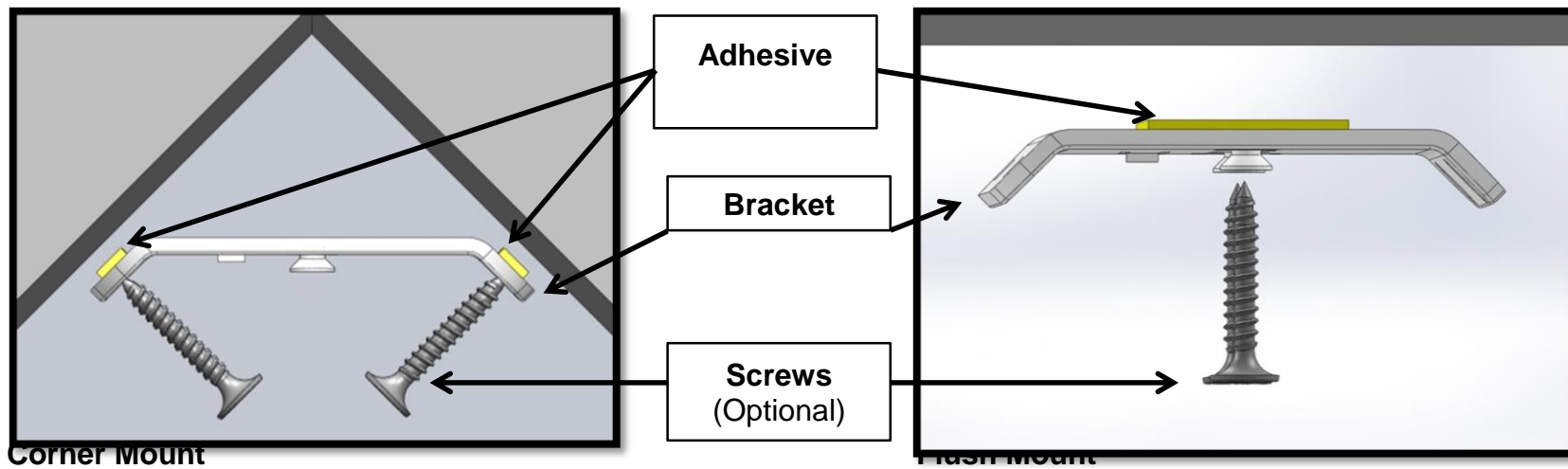

Note: For best results, attach adhesive tape to bracket FIRST, then position on wall. Adhesive tape is VERY STRONG so moving the bracket after attaching will be difficult.

STEP TWO Attach Motion Detector to Bracket

Once the mounting bracket is in place, align the holes on the back of the motion detector with the key on the bracket. Slide the sensor down on the keys until it snaps tight.

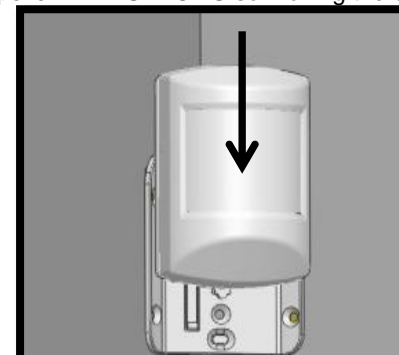



ADDITIONAL NOTES AND SUMMARY:

- BEFORE attaching the bracket to a surface note how the bracket will need to be oriented in order for the tab to engage the sensor. The required orientation of the sensor determines the bracket orientation. The large clip that holds the case together is located on the TOP. Please be advised that adhesive tape may damage the surfaces to which it is attached and then removed from.
- The sensor slides onto the bracket until the tab engages and CLICKS.
- The distribution pattern of the motion detector is approximately +/- 50 degrees left and right of center, and at maximum sensitivity will reach a maximum of approximately 45 feet. See example distribution pattern below.

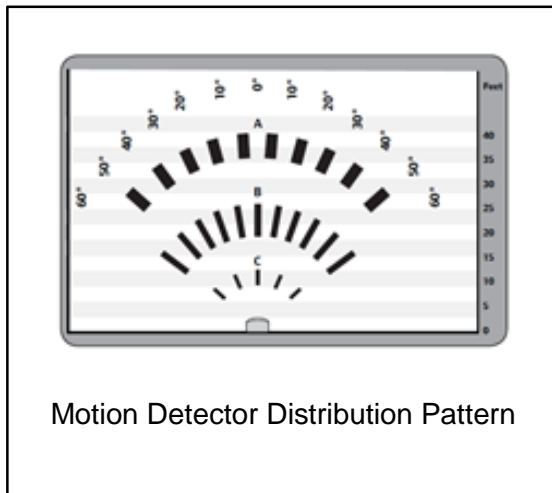

Adjusting the Sensitivity of the Motion Sensor

The motion sensor has sensitivity adjustment via jumper placement on a pair of pins on the circuit board of the sensor. Refer to the battery replacement section to open the case and find the jumper pins inside the case.

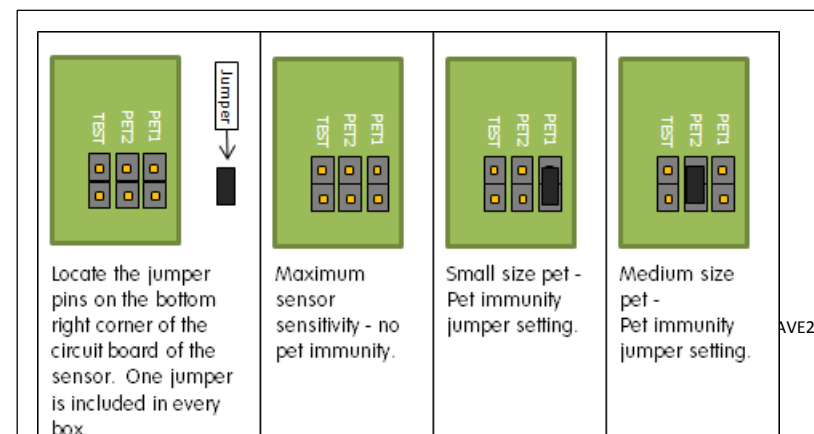



Test Mode

The amount of time it takes for the sensor to reset after motion has been detected can be shortened for quicker motion sensor testing. To enter test mode remove the cover from the sensor. Find the pair of metal pins on the lower right hand side of the circuit board labeled “TEST”. Connect these two pins together using the provided jumper. Replace the sensor cover. After approximately ten seconds the red LED will go out. The sensor is now in test mode. In test mode the LED will flash once when motion is detected and again when motion detector is ready again. In this mode you can wave your hand in front of the sensor or walk around the room and see where motion is detected. Note that there must be a length of time without motion before motion detect is enabled again. To restore normal operation simply remove the test jumper and replace the sensor cover.

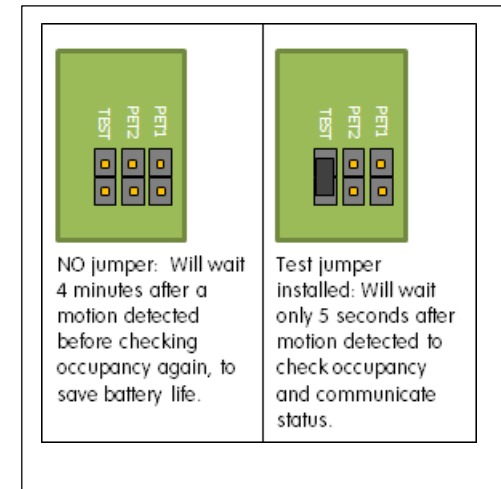

What is Z-Wave?

The Z-Wave protocol is an interoperable, wireless, RF-based communications technology designed specifically for control, monitoring and status reading applications in residential and light commercial environments. Mature, proven and broadly deployed (with over 35 million products sold worldwide), Z-Wave is by far the world market leader in wireless control, bringing affordable, reliable and easy-to-use 'smart' products to many millions of people in every aspect of daily life. Certified Z-Wave devices regardless of manufacturer can work together to form a Z-Wave mesh network. Always on Z-Wave devices can act as repeaters in the mesh increasing range and redundancy.

For a more complete look at Z-Wave technology for non-technologists, and to learn more about Z-Wave's role as a key enabling technology for the Internet of Things and connected objects, please visit www.z-wave.com.



Z-Wave Device Class and Command Class Information

This Z-Wave sensor is a Z-Wave generic Device Class of `GENERIC_TYPE_SENSOR_NOTIFICATION`, and a specific device class of `SPECIFIC_TYPE_NOTIFICATION_SENSOR`, and the supported command classes are `COMMAND_CLASS_ZWAVEPLUS_INFO`, `COMMAND_CLASS_VERSION`, `COMMAND_CLASS_MANUFACTURER_SPECIFIC`, `COMMAND_CLASS_POWERLEVEL`, `COMMAND_CLASS_BATTERY`, `COMMAND_CLASS_NOTIFICATION_V4`, `COMMAND_CLASS_ASSOCIATION`, `COMMAND_CLASS_ASSOCIATION_GRP_INFO`, `COMMAND_CLASS_WAKE_UP`, `COMMAND_CLASS_SENSOR_BINARY`, `COMMAND_CLASS_CONFIGURATION`, `COMMAND_CLASS_BASIC`.

Manufacturer Specific

Manufacturer ID: 0x014A

Product Type: 4

Product ID: 1

Factory Default

To restore this sensor to factory default settings, follow the instructions in this manual to exclude this sensor from the Z-Wave network. Upon completion of removal from the network the sensor will restore itself to factory default settings automatically. Use this procedure only in the event that the network primary controller is missing or otherwise inoperable.

Keeping Awake for Testing and Configuration

To save power, this sensor sleeps most of the time and is therefore not awake to receive messages from a gateway for testing. Removing the top case from the sensor will put in device into a tampered mode in which the sensor will stay awake and able to receive messages. Most of the time an end user would not do this, but if the sensor needs to be configured after inclusion, an end user can follow the instructions below for sending Wake-Up notifications.

Association

This sensor has two Association groups of 5 nodes each. Group one is a lifeline group who will receive unsolicited messages relating to motion detection notifications, case tampering notifications, low-battery notifications, and sensor binary reports. Group 2 is intended for devices that are to be controlled i.e. turned on or off (on only by default) with a Basic Set. On inclusion the controller should put its node ID in group 1 but not group 2.

Network Wide Inclusion

This sensor also supports Network Wide Inclusion such that the Sensor can be included into the Z-Wave network over the mesh network and not directly near the main controller. This mode is automatically activated after regular inclusion was not successful.



SENSOR CONDITION	COMMAND CLASS and VALUE	ASSOCIATION GROUP	CONFIGURABLE?
Motion Detected	Notification Report of Home Security (0x07), Motion Detection Unknown Location(0x08)	1	Yes via Notification Set of notificationType (0x07) and status of 0x00: This type of notification turned off 0xFF: This type of notification turned on
	Sensor Binary Report of 0xFF Sensor Type: 0xFF	1	Yes via Configuration Command Class Parameter Number: 2 Size: 1 A Configuration Value: 0xFF (On) / 0x00 (Off)
	Basic set of 0xFF (On)	2	No
No More Motion Detected	Notification Report of Home Security (0x07), Event inactive(0x00)	1	Yes via Notification Set of notificationType (0x07) and status of 0x00: This type of notification turned off 0xFF: This type of notification turned on
	Sensor Binary Report of 0x00 Sensor Type: 0xFF	1	Yes via Configuration Command Class Parameter Number: 2 Size: 1 A Configuration Value: 0xFF (On) / 0x00 (Off)
	Basic Set of 0x00 (Off) By factory default this feature is disabled and must be enabled via Configuration Command Class.	2	Yes via Configuration Command Class Parameter Number: 1 Size: 1 A Configuration Value: 0xFF (On) / 0x00 (Off) Parameter Number: 2
			Yes via Notification Set of notificationType (0x07) and status of



Sensor Case Removed	Notification Report of Home Security (0x07), Tampering product cover removed (0x03)	1	0x00: This type of notification turned off 0xFF: This type of notification turned on
Sensor Case Fastened	Wake-Up Notification	1	Yes via Wake-Up Notification Command Class
Battery Level Dipped Below 2.6v	Notification Report of Power Management (0x08), Replace battery now (0x0B)	1	Yes via Notification Set of notificationType (0x08) and status of 0x00: This type of notification turned off 0xFF: This type of notification turned on

Wake-Up Notification

The sensor will wake up every so often and when the case is closed to send a Wake-Up Notification to allow the life line master node controller that the sensor is now available for any queued messages that the controller may have for the sensor. The time between Wake-Up Notifications can be configured with the Wake-Up Notification command class to be between 1 hour and 1 week with interval steps of 200 seconds.

Configuration

The sensor has two configuration parameters. Parameter 1 configures the sensor to send or not send Basic Set commands of 0x00 to nodes in Association group 2 turning the devices off when the sensor is in a restored state i.e. motion not detected. By default the sensor does NOT send Basic Set commands of 0x00. Parameter 2 configures the sensor to either to send or not to send Sensor Binary Report commands to Association Group 1 when the sensor is faulted and restored. If the controller is fully compatible with the Notification Command Class thereby making the Sensor Binary Reports redundant, the controller can disable the Sensor Binary Report Commands completely. The following table shows the values to enable and disable the two configuration parameters.

Configuration Set Values	Effect
Parameter Number: 1 Size: 1 Configuration Value: 0x00	(Default) Sensor does NOT send Basic Sets to Node IDs in Association Group 2 when the sensor is restored (i.e. Motion Not Detected).
Parameter Number: 1 Size: 1 Configuration Value: 0xFF	Sensor sends Basic Sets of 0x00 to nodes in Association Group2 when sensor is restored.



Parameter Number: 2 Size: 1 Configuration Value: 0x00	(Default) Sensor sends Sensor Binary Reports when sensor is faulted and restored for backwards compatibility in addition to Notification Reports.
Parameter Number: 2 Size: 1 Configuration Value: 0xFF	Sensor will send only Notification Reports and NOT Sensor Binary Reports when the sensor is faulted and restored.

FCC Compliance Statement

This device complies with part 15 of the FCC Rules. Operation is subject to the following two conditions: (1) This device may not cause harmful interference, and (2) this device must accept any interference received, including interference that may cause undesired operation.

This equipment has been tested and found to comply with the limits for Class B digital devices, pursuant to Part 15 of the FCC Rules. These limits are designed to provide reasonable protection against harmful interference in a residential installation. This equipment generates uses and can radiate radio frequency energy and, if not installed and used in accordance with the instruction manual, may cause harmful interference to radio communications. However, there is no guarantee that interference will not occur in a particular installation. If this equipment does cause harmful interference to radio or television reception, which can be determined by turning the equipment off and on, the user is encouraged to try to correct the interference by one or more of the following measures:

- Re-orient or relocate the receiving antenna
- Increase the separation between the equipment and receiver
- Connect the equipment to an outlet on a different circuit from the receiver
- Consult the dealer or an experienced radio/TV contractor for help.

Warning: Changes or modifications not expressly approved by Ecolink Intelligent Technology Inc. could void the user's authority to operate the equipment.

This device complies with Industry Canada licence-exempt RSS standard(s). Operation is subject to the following two conditions: (1) this device may not cause interference, and (2) this device must accept any interference, including interference that may cause undesired operation of the device.

C'et appareil est conforme la norme d'Industrie Canada exempts de licence RSS. Son fonctionnement est soumis aux deux conditions suivantes: (1) c'et appareil ne peut pas provoquer d'interférences, et (2) c'et appareil doit accepter toute interférence, y compris les interférences qui peuvent causer un mauvais fonctionnement de la dispositif.

FCC ID: XQC-PIRZ25 IC: 9863B-PIRZ25

Warranty

Ecolink Intelligent Technology Inc . warrants that for a period of 3 years from the date of purchase that this product is free from defects in material and workmanship. This warranty does not apply to damage caused by shipping or handling, or damage caused by accident, abuse, misuse, misapplication, ordinary wear, improper maintenance, failure to follow instructions or as a result of any unauthorized modifications.

If there is a defect in materials and workmanship under normal use within the warranty period Ecolink Intelligent Technology Inc. shall, at its option, repair or replace the defective equipment upon return of the equipment to the original point of purchase.



The foregoing warranty shall apply only to the original buyer, and is and shall be in lieu of any and all other warranties, whether expressed or implied and of all other obligations or liabilities on the part of Ecolink Intelligent Technology Inc. neither assumes responsibility for, nor authorizes any other person purporting to act on its behalf to modify or to change this warranty, nor to assume for it any other warranty or liability concerning this product. The maximum liability for Ecolink Intelligent Technology Inc. under all circumstances for any warranty issue shall be limited to a replacement of the defective product. It is recommended that the customer check their equipment on a regular basis for proper operation.



Designed in Carlsbad, CA www.discoverecolink.com