

# IC-7113W

## User Manual

11-2014 / v1.0

---

### **Edimax Technology Co., Ltd.**

No.3, Wu-Chuan 3rd Road, Wu-Gu, New Taipei City 24891, Taiwan

Email: [support@edimax.com.tw](mailto:support@edimax.com.tw)

---

### **Edimax Technology Europe B.V.**

Fijenhof 2, 5652 AE Eindhoven, The Netherlands

Email: [support@edimax.nl](mailto:support@edimax.nl)

---

### **Edimax Computer Company**

3350 Scott Blvd., Bldg.15 Santa Clara, CA 95054, USA

Live Tech Support: 1(800) 652-6776

Email: [support@edimax.com](mailto:support@edimax.com)



Copyright © Edimax Technology Co., Ltd. all rights reserved. No part of this publication may be reproduced, transmitted, transcribed, stored in a retrieval system, or translated into any language or computer language, in any form or by any means, electronic, mechanical, magnetic, optical, chemical, manual or otherwise, without the prior written permission from Edimax Technology Co., Ltd.

Edimax Technology Co., Ltd. makes no representations or warranties, either expressed or implied, with respect to the contents hereof and specifically disclaims any warranties, merchantability, or fitness for any particular purpose. Any software described in this manual is sold or licensed as is. Should the programs prove defective following their purchase, the buyer (and not this company, its distributor, or its dealer) assumes the entire cost of all necessary servicing, repair, and any incidental or consequential damages resulting from any defect in the software. Edimax Technology Co., Ltd. reserves the right to revise this publication and to make changes from time to time in the contents hereof without the obligation to notify any person of such revision or changes.

The product you have purchased and the setup screen may appear slightly different from those shown in this QIG. For more information about this product, please refer to the user manual on the CD-ROM. The software and specifications are subject to change without notice. Please visit our website [www.edimax.com](http://www.edimax.com) for updates. All brand and product names mentioned in this manual are trademarks and/or registered trademarks of their respective holders.

**Edimax Technology Co., Ltd.**

Add: No. 3, Wu-Chuan 3rd Rd., Wu-Ku Industrial Park, New Taipei City, Taiwan

Tel: +886-2-77396888

Email: [sales@edimax.com.tw](mailto:sales@edimax.com.tw)

**Notice According to GNU General Public License Version 2**

Certain Edimax products include software code developed by third parties, software code is subject to the GNU General Public License ("GPL") or GNU Lesser General Public License ("LGPL"). Please see the [GNU](http://www.gnu.org) (www.gnu.org) and [LPGL](http://www.gnu.org) (www.gnu.org) Websites to view the terms of each license.

The GPL Code and LGPL Code used in Edimax products are distributed without any warranty and are subject to the copyrights of their authors. For details, see the GPL Code and LGPL Code licenses. You can download the firmware-files at <http://www.edimax.com> under "Download" page.

<b>I. Product Information.....</b>	<b>6</b>
I-1. Package Contents.....	6
I-2. System Requirements.....	6
I-3. LED Status .....	8
I-4. Product Label .....	9
I-5. Reset .....	10
I-6. Back Panel.....	11
<b>II. Camera Setup.....</b>	<b>12</b>
II-1. EdiView II App .....	14
II-2. EdiView Finder .....	17
II-2-1. Windows .....	17
II-2-2. Mac .....	23
II-2-3. Using EdiView Finder .....	26
II-3. WPS (Wi-Fi Protected Setup).....	28
<b>III. Mounting Stand .....</b>	<b>29</b>
<b>IV. Web-Based Management Interface .....</b>	<b>30</b>
IV-1. Basic .....	36
IV-1-1. Network .....	37
IV-1-2. Wireless.....	39
IV-1-2-1. Smartphone .....	40
IV-1-2-2. Computer .....	43
IV-1-2-3. WPS.....	44
IV-1-3. Dynamic DNS.....	45
IV-1-4. RTSP .....	46
IV-1-5. Date & Time .....	47
IV-1-6. Users .....	48
IV-1-7. UPnP.....	50
IV-1-8. Bonjour .....	51
IV-2. Video .....	52
IV-2-1. Video Settings .....	53
IV-2-2. Image Appearance .....	55
IV-2-3. Night Vision.....	56
IV-3. Audio.....	57
IV-3-1. Music Settings.....	57
IV-4. Events.....	59
IV-4-1. Motion Detection.....	59
IV-4-1-1. Motion Detection.....	59

- IV-4-1-2. Detection Region .....62
- IV-4-1-3. Schedule Settings.....64
- IV-4-2. Sound Detection .....66
- IV-4-2-1. Sound Detection .....66
- IV-4-3. Notification .....69
- IV-4-3-1. Mail Settings .....69
- IV-4-3-2. FTP.....71
- IV-4-3-3. Push.....72
- IV-5. Storage Settings .....73
- IV-5-1. Storage Directory .....73
- IV-5-2. Schedule Settings.....74
- IV-5-3. NAS Settings.....75
- IV-5-4. SD Card Settings.....76
- IV-5-5. File Management .....77
- IV-6. Pan & Tilt.....79
- IV-6-1. Pan & Tilt Settings.....79
- IV-6-2. Preset .....80
- IV-6-3. Home.....81
- IV-7. System.....82
- IV-7-1. Basic .....82
- IV-7-2. Advanced .....83
- IV-7-3. Cloud Service.....85
- IV-7-4. Environment Sensor .....85
- IV-8 Status .....87
- IV-8-1. System Information .....88
- IV-8-2. System Log .....89
- IV-8-3. Environment Sensor Log.....90

**V. Myedimax.com .....91**

**VI. 16 Channel Viewer for Windows.....94**

- VI-1. Installation .....94
- VI-2. Using the 16 Channel Viewer.....98
- VI-3. Configuring the 16 Channel Viewer .....101
- VI-3-1. Add Camera/Camera Configuration .....101
- VI-3-1-1. Camera.....102
- VI-3-1-2. Scheduled Recording .....104
- VI-3-1-3. Audio.....107
- VI-3-1-4. Motion Recording .....108
- VI-3-2. General Options.....110
- VI-3-2-1. General.....110

VI-3-2-2. Email Settings.....	112
VI-3-2-3. Security .....	114
VI-3-2-4. About .....	116
VI-4. Changing the Display Layout.....	117
VI-5. Full Screen Mode .....	120
VI-6. Scan.....	121
VI-7. Zoom In/Out .....	122
VI-8. Pan & Tilt.....	123
VI-9. Snapshot .....	124
VI-10. Recording.....	125
VI-11. Video Playback.....	126

# I. Product Information

---

## I-1. Package Contents

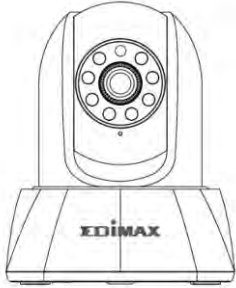

**IC-7113W**



**QIG**



**CD-ROM**



**Power  
Adapter**

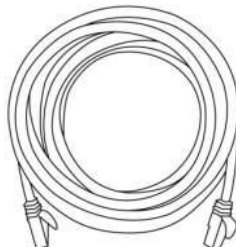

**Ethernet  
Cable**

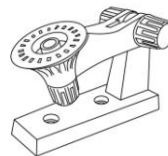

**Mounting  
Stand**



**Screws**

## **I-2. System Requirements**

- Intel Pentium 4 2.4GHz (above or similar)
- VGA card (1024\*768 or above)
- CD-ROM Drive
- At least 128MB hard disk space (256 MB recommended)
- Windows XP, Vista, 7, 8 or above
- Web browser (Internet Explorer 8, Firefox 3.6, Chrome 10, Opera 11, Safari 5 or above)

### I-3. LED Status

LED Color	LED Status	Description
Red	On	Network camera is not connected to Internet.
	Quick Flashing	Camera starting up <b>or</b> resetting to factory default status.
	Slow Flashing (1 x per second)	Camera is in installation mode.
Green	On	Network camera is connected to the Internet <b>or</b> WPS connection successful.
	Slow Flashing (1 x per 2 seconds)	WPS is active.
Off	Off	Camera is off.





## I-5. Reset

If you experience problems with your network camera, you can reset the camera back to its factory default settings. This resets **all** settings back to default.

1. Press and hold the WPS/Reset button found on the back panel for at least 10 seconds. Release the button when the LED is **flashing quickly red**.

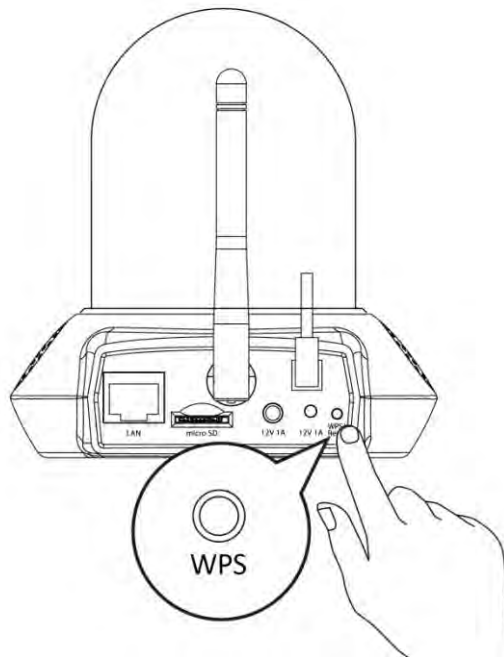

2. Wait for the network camera to restart. The camera is ready when the LED is **flashing slowly red** and plays an audio tone from its speaker.

## I-6. Back Panel

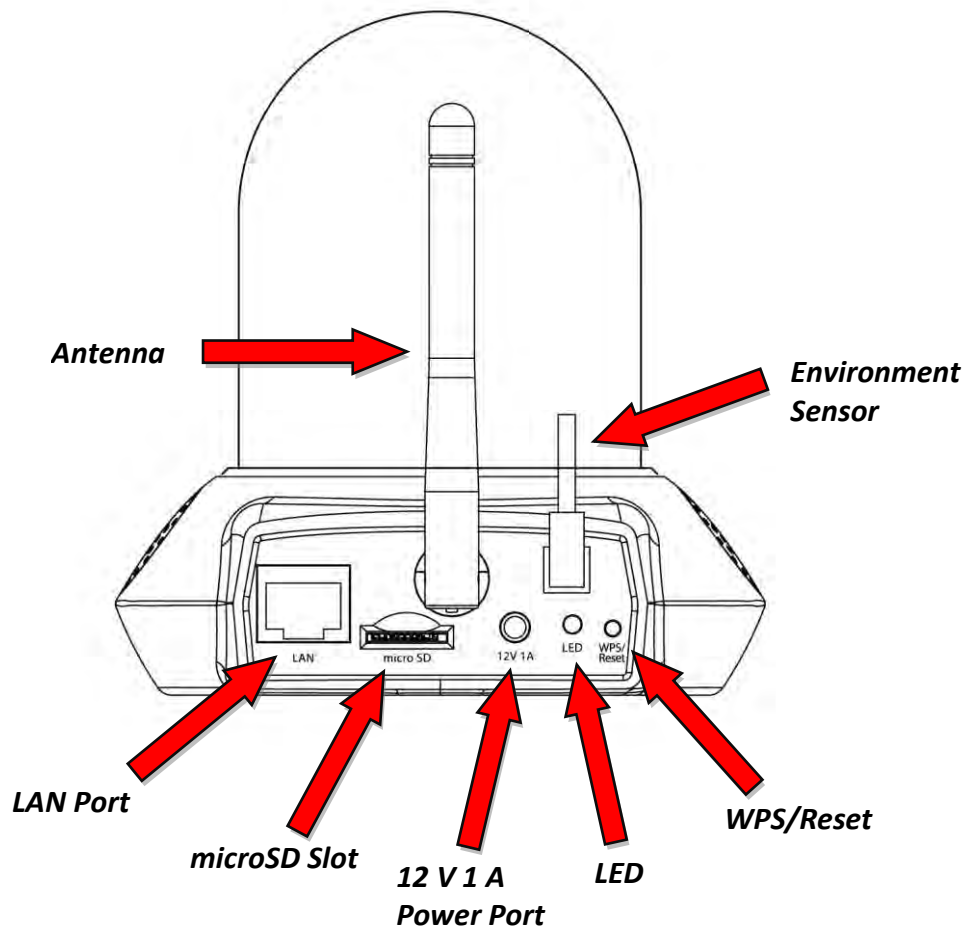

## II. Camera Setup

---



Your network camera's unique SSID is displayed on the product label on the product's indoor main unit and consists of "EdiView.Setup\*\*" where \*\* are the last two characters of your camera's unique MAC address.

1. Connect the network camera to a power supply using the included power adapter.

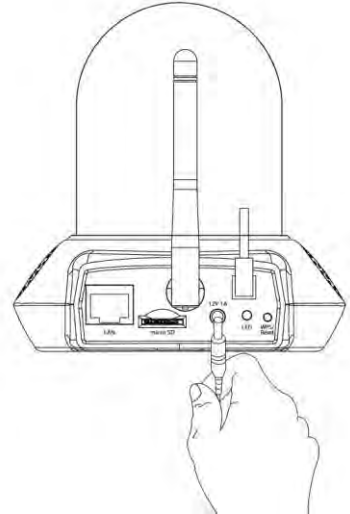

2. Wait a moment for the camera to power on. The LED on the back of the camera will **flash red** to indicate installation mode when it's ready, and the camera will play a tone from its speaker.

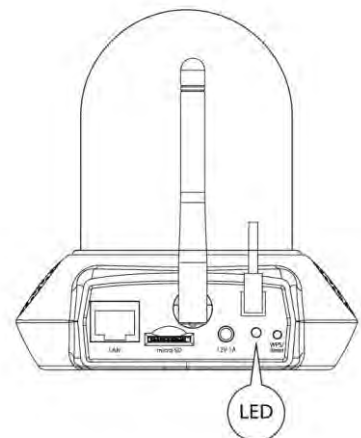

3. If you have a microSD card, insert the card into the microSD slot on the back on the network camera:

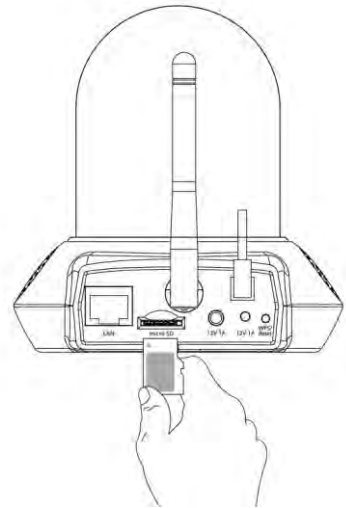

 ***A folder named “Music” will automatically be created when you insert a new microSD card into the network camera. Refer to IV-3-1. for more information.***

Now you need to connect your network camera to your network. There are three easy ways:

- A. With the free EdiView II app on Android or iPhone: **II-1. EdiView II App.**
- B. Using a computer and EdiView Finder: **II-2. EdiView Finder.**
- C. Using WPS (Wi-Fi Protected Setup), a simple method to connect your camera to your wireless network. Refer to **II-4. WPS.**

After connecting your camera to your network using one of the methods above, you can view your camera’s live image or configure its settings:

***Local network:***

- A. Using the web based management interface (see **IV. Web Based Management Interface.**).
- B. Using the 16 channel viewer software (see **VI. 16 Channel Viewer Software.**).

***Remotely (from any Internet connection):***

- A. Using the camera’s cloud ID (see **V. Myedimax.com.**).
- B. Using the EdiView II app.

## II-1. EdiView II App

1. Use a smartphone or tablet to search, download and install the EdiView II app from Google Play or the Apple App Store.



2. For **iOS users**, go to your iPhone's Wi-Fi settings and connect to your network camera's SSID (EdiView.Setup\*\*), before opening the EdiView II app. Continue to **Step 4**.

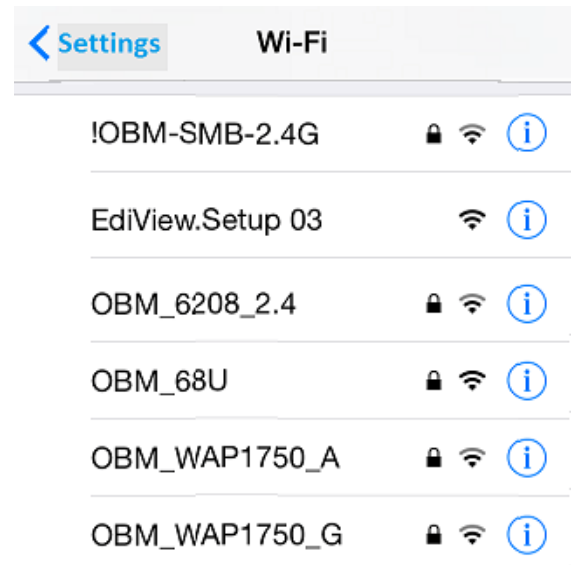

3. **Android** users ensure your Android device's Wi-Fi is switched on, and open the EdiView II app. Select your network camera and click "OK" to continue.

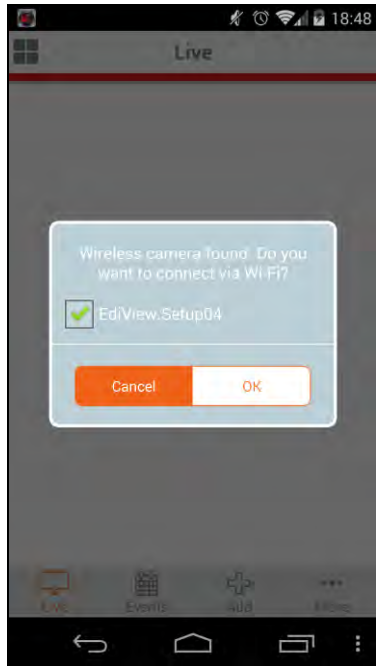

**4. Android & iOS users select your Wi-Fi network from the list and then enter your Wi-Fi password, before clicking “OK”.**



***If prompted to allow push notifications, please select “Yes”. Click the refresh icon to refresh the Wi-Fi list.***

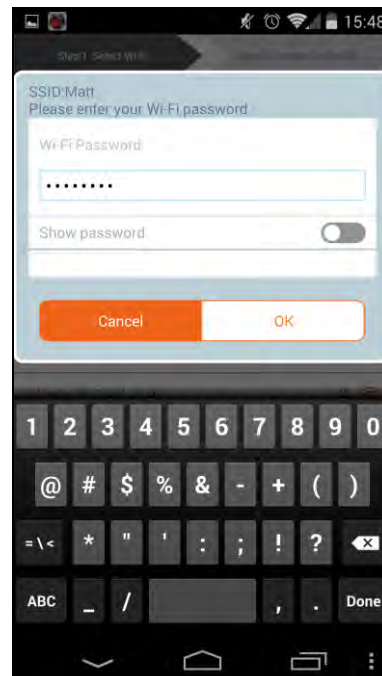
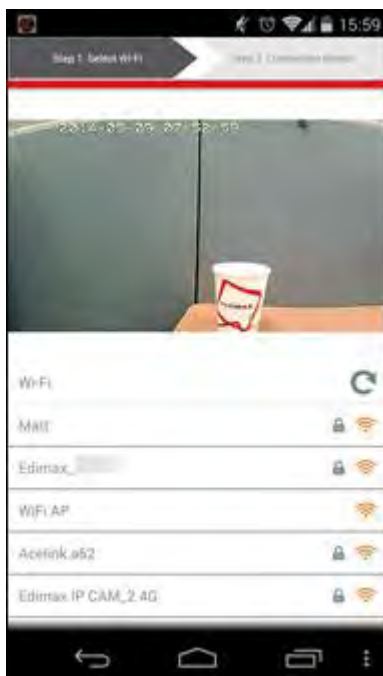

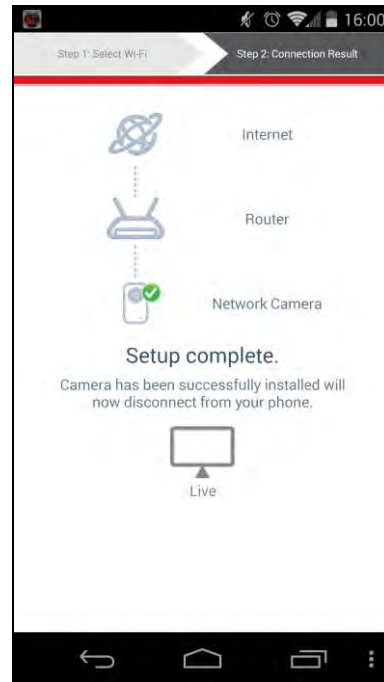
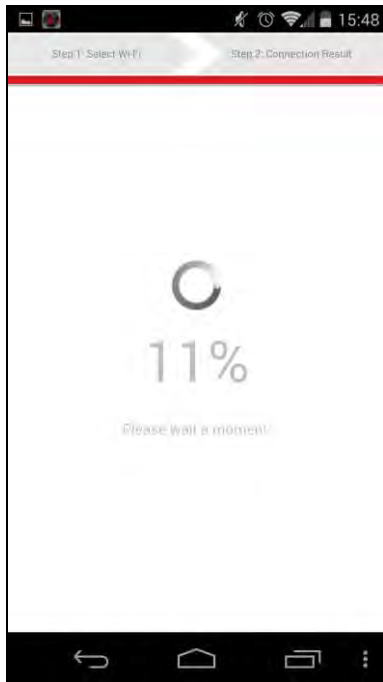

**5. Please wait a moment while your camera connects to your Wi-Fi. When you see the “Setup complete” screen, click the “Live” icon to continue or wait for a few seconds to continue automatically.**

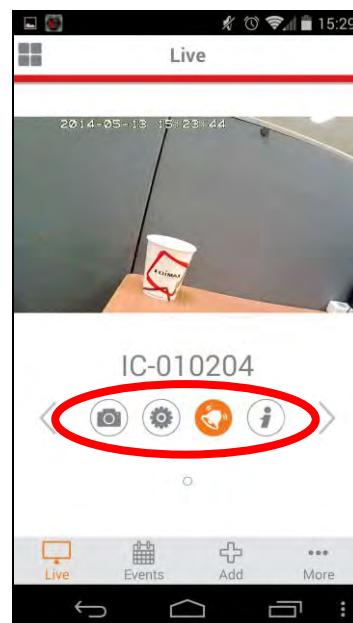
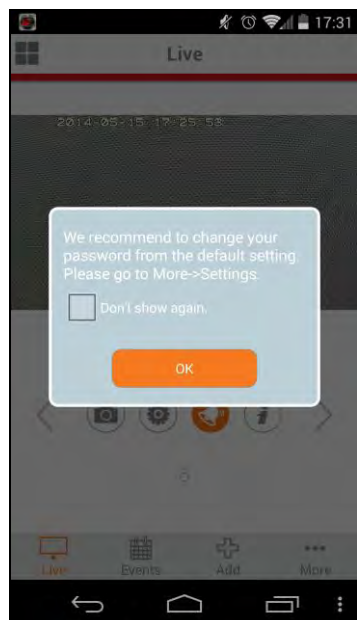

**6.** Setup is complete. The camera's LED should display **on** and **green**. You should see a live stream from your network camera which you can view anytime you are connected to the Internet.

 ***It is recommended that you change your camera's password. Go to "More" in the bottom right corner and select "Settings".***



 ***You can configure your camera's settings and functions using the icons below the live image.***



## II-2. EdiView Finder



**Ensure your computer is connected to the same router as the network camera using an Ethernet cable.**

### II-2-1. Windows

1. Insert the included CD into your CD-ROM drive and if the setup utility does not automatically open, please locate and open the “Autorun.exe” file in the “Autorun” folder.
2. Click “Setup Utility” to install the EdiView Finder software utility.

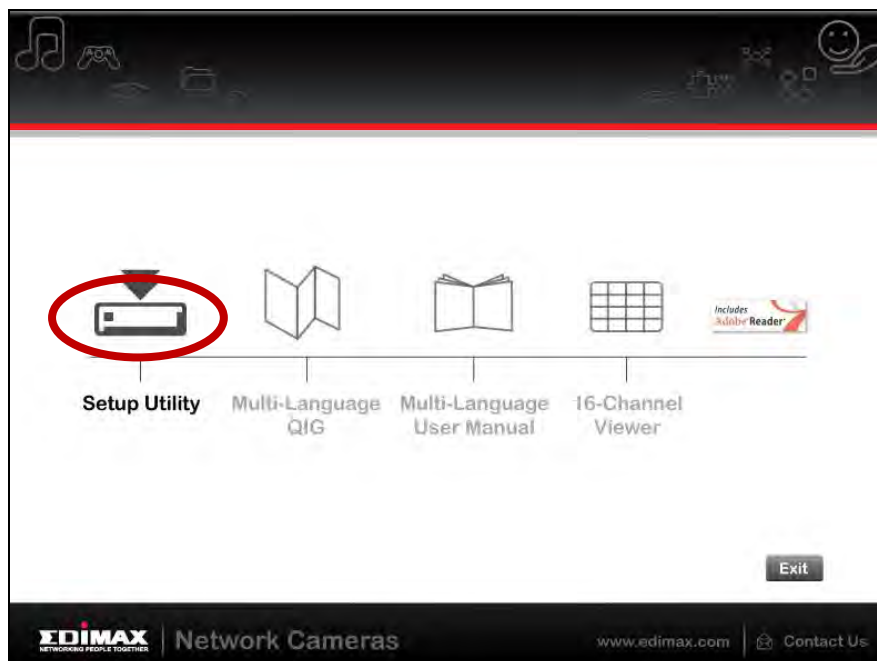

3. Click “Next” and follow the on-screen instructions to install the EdiView Finder software utility.

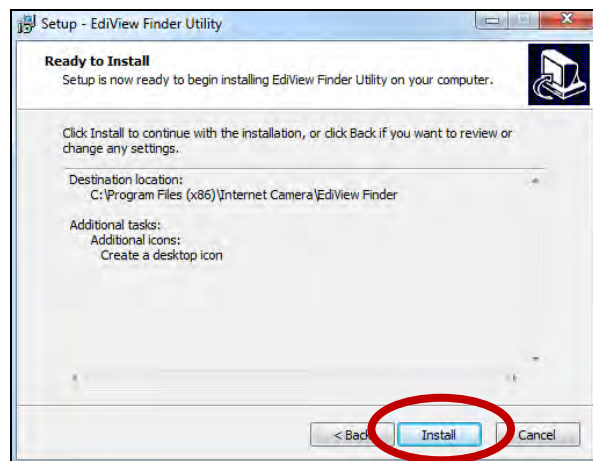
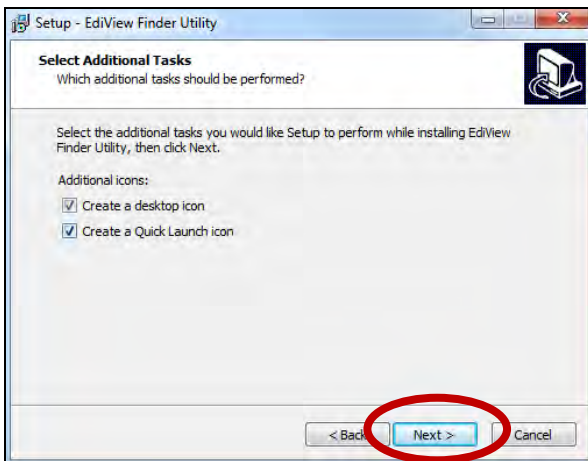
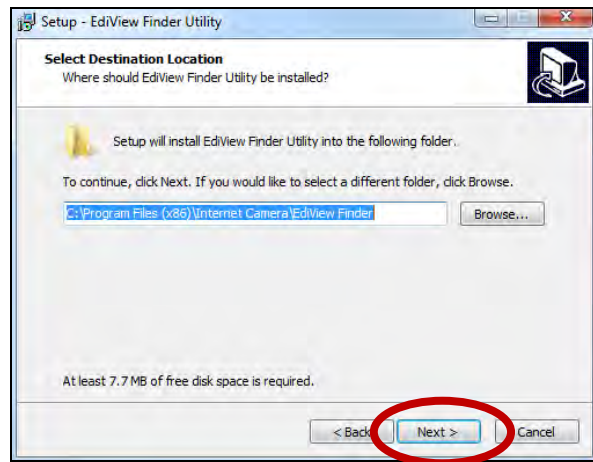
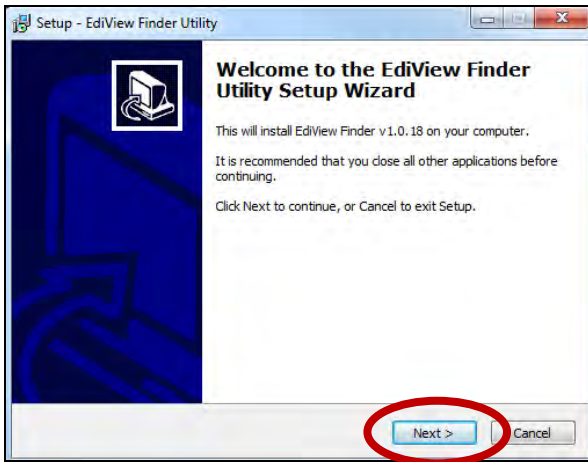

4. When installation is complete, select "Launch EdiView Finder Utility" before clicking "Finish". Or double click the "EdiView Finder Utility" icon on your desktop to launch EdiView Finder.

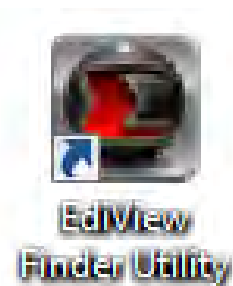
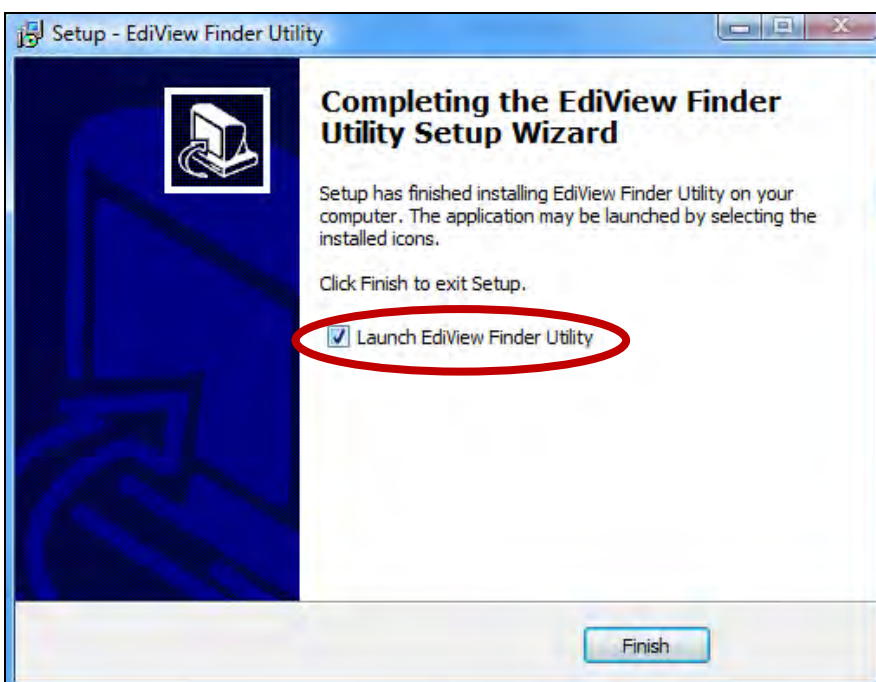

5. EdiView Finder will list all cameras on your local network, along with each camera's name, model, IP address and MAC address.



***Click the search icon to refresh the list if your camera is not displayed.***



***The network camera's IP address is displayed on this screen. After setup, you can enter this IP address into the URL bar of a web browser on the same local network to access your network camera's web-based configuration interface.***

6. Double click your camera and then choose "Yes" or "No" if you wish to set up a wireless connection. If you choose "No" please go to **step 10**.



***The IC-7113W is a wireless camera, you can choose "Yes" to set up your wireless connection.***



7. Select your wireless network from the list and enter the correct password in the "Password" field, before clicking "OK". This is the wireless network which your camera will connect to.

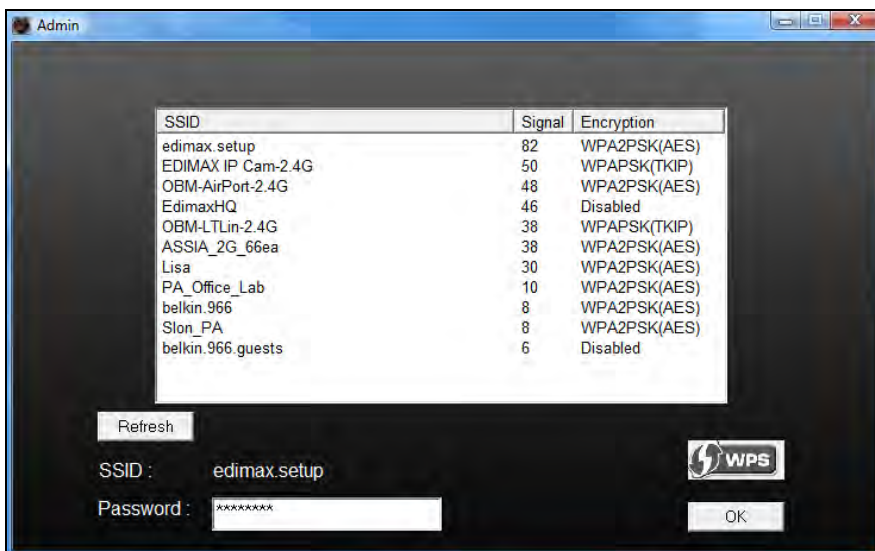

8. Unplug the Ethernet cable from your network camera and click "Next". Please wait a moment for the camera to detect the connection.

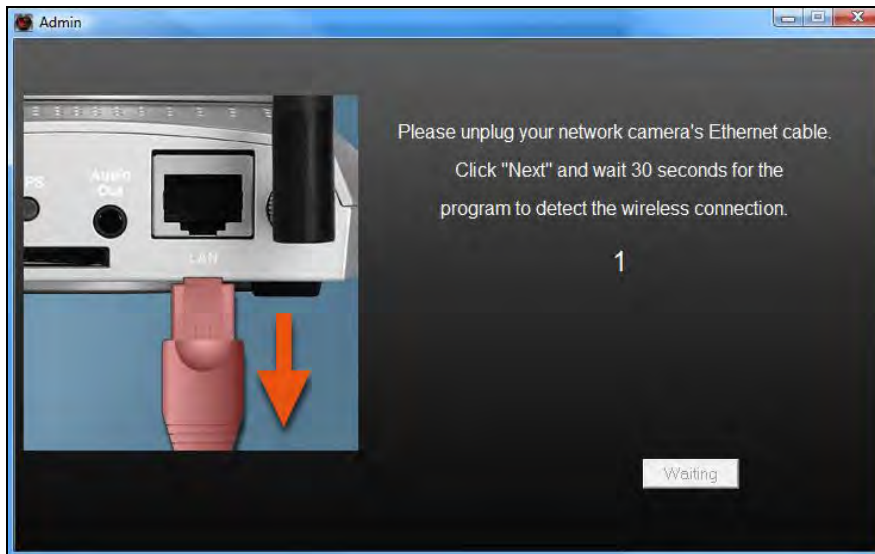

**9.** When the connection is detected as shown below, please click “Next”.

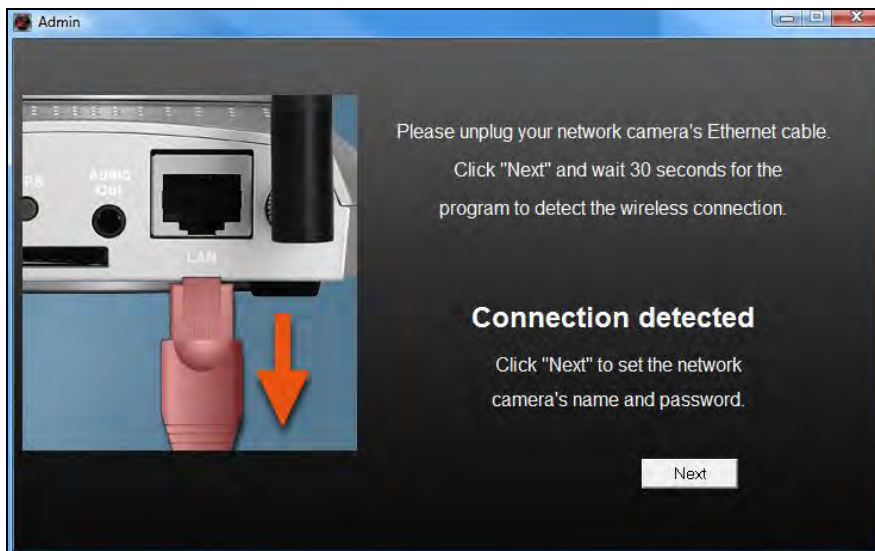

**10.** Enter a name and password for your camera. The password will be used later to log in to your camera remotely via its cloud ID, web interface or via the EdiView II smartphone app. Click “OK” to continue.

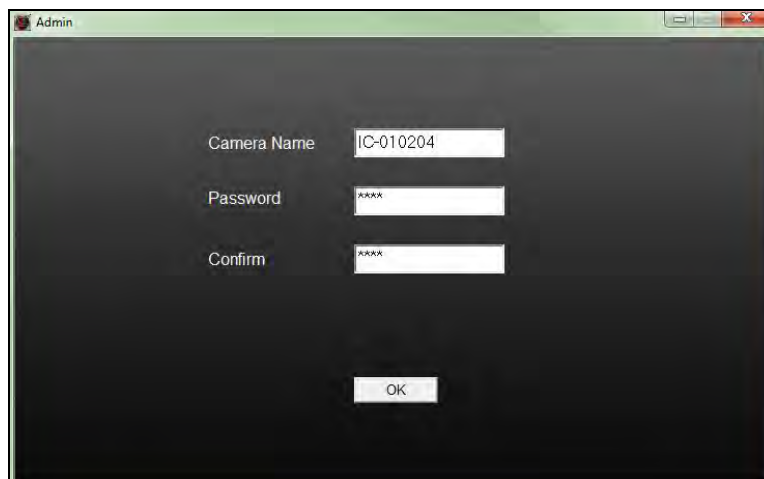

**11.** The next screen will indicate that setup is complete. The camera is operational and ready for use. Click “OK” or click the URL and a preview window showing a live stream from your camera may open.





## II-2-2. Mac



***EdiView Finder for Mac will not set up your network camera's wireless connection. After this chapter, please continue to IV-1-2. Wireless to set up the camera's wireless connection.***

1. Insert the included CD into your CD-ROM drive and browse to the "Mac" folder.



2. Copy the "EdiView Finder" file to your desktop and double click the icon to open EdiView Finder.



***EdiView Finder is also available for download from the Edimax website:***

**<http://www.edimax.com/EdiViewFinder.htm>**



3. EdiView Finder will list all cameras on your local network, along with each camera's name, model, IP address and MAC address.



**Click the search icon to refresh the list if your camera is not displayed.**

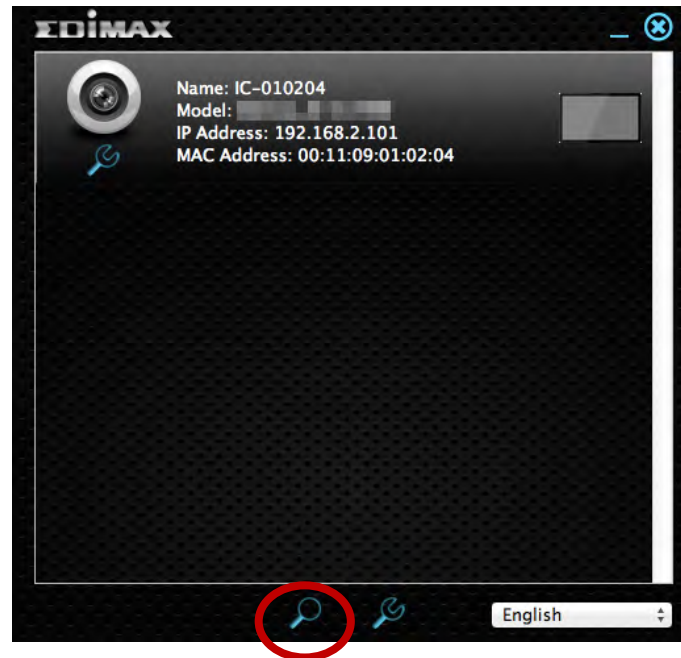

**The network camera's IP address is displayed on this screen. After setup, you can enter this IP address into the URL bar of a web browser on the same local network to access your network camera's web-based configuration interface.**

4. Double click your network camera and wait a moment for the network camera to obtain an IP address and test the cloud connection. EdiView should display "Success" as shown below.

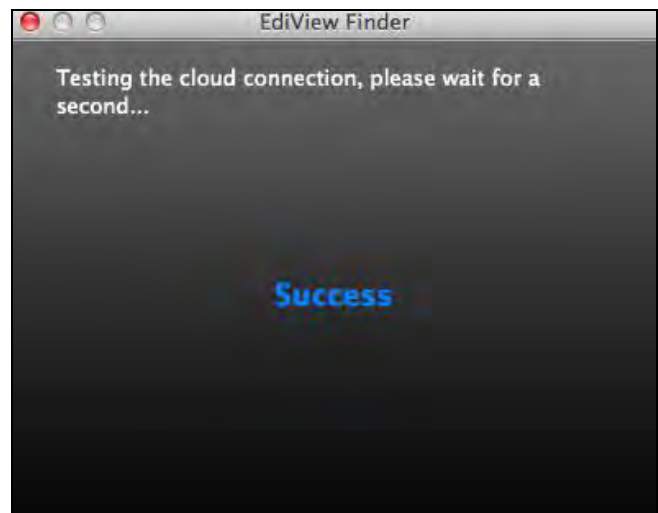
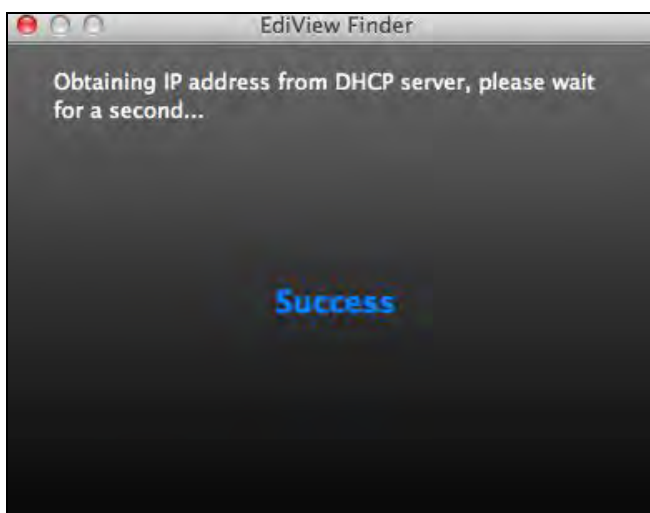



5. Enter a name and password for your camera. The password will be used later to log in to your camera remotely via its cloud ID, web interface or via the EdiView II smartphone app. Click “Next” to continue.



6. The next screen will indicate that setup is complete. The camera is operational and ready to be configured for a wireless connection. Click “Finish” and a preview window showing a live stream from your camera may open.

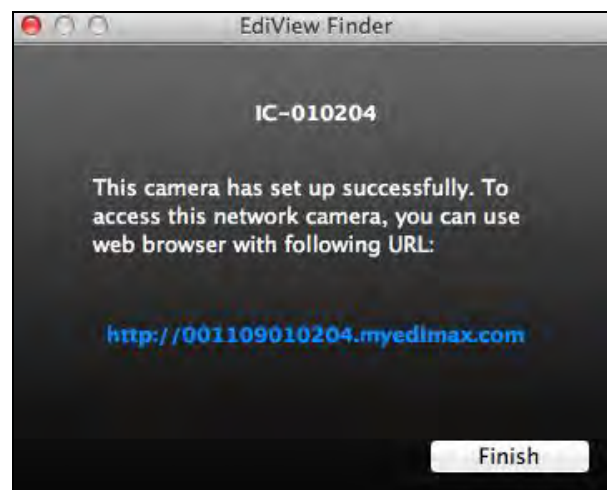

7. To setup your network camera’s wireless connection, please follow **IV-1-2. Wireless.**

### II-2-3. Using EdiView Finder

You can also use EdiView Finder to find your network camera's IP address, view a live stream, or modify the network camera's IP address. Double click the TV icon on the right side to view a live stream in a pop-up window, or click the wrench icon to open a new window with the network camera's IP address settings:

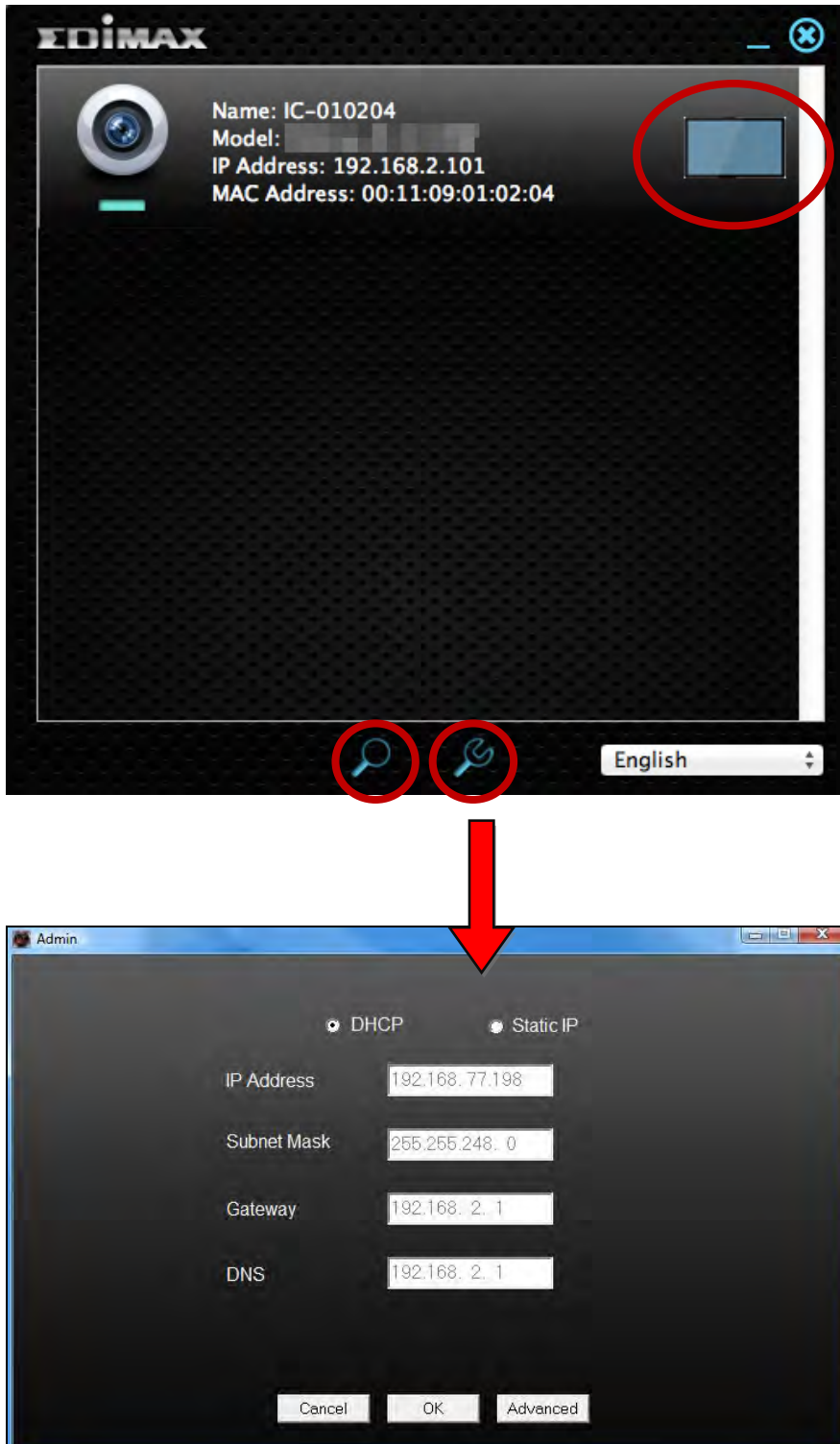



***EdiView Finder will locate your network camera as long as you are on the same local network. Static IP users who may be using a different IP address subnet to the network camera should still be able to locate the network camera with EdiView Finder. If you encounter difficulties, it is recommended that you use a DHCP server – though you can manually set the network camera’s IP address using EdiView Finder (above) or using the web-based configuration interface (see IV-1-1. Network) if you need.***

## II-3. WPS (Wi-Fi Protected Setup)

The WPS (Wi-Fi Protected Setup) button is a quick and easy alternative to establish a secure wireless connection between your network camera and your wireless router/access point.

1. Press and hold the WPS button on your **wireless router/access point** for the correct length of time to activate its WPS.



***Please check the instructions for your wireless router/access point for how long you need to hold down its WPS button to activate WPS.***

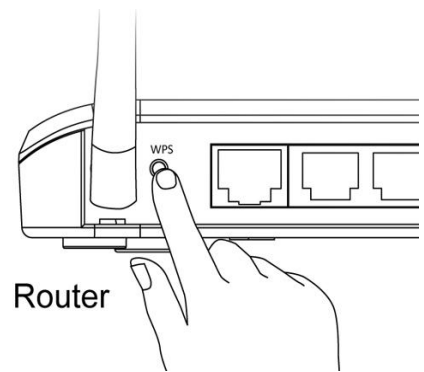

2. Within two minutes, press the WPS/Reset button on the network camera for 2 – 5 seconds to activate WPS. The LED will **flash slowly green** to indicate that WPS is active.



***Take care not to hold the WPS/Reset button too long and reset your network camera.***

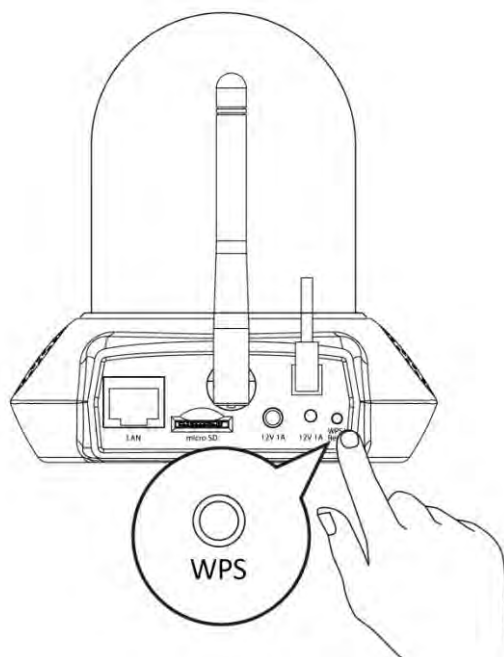

3. The devices will establish a secure wireless connection. The LED will display **on green** for two minutes to indicate a successful WPS connection.

### III. Mounting Stand

---

A stand for your network camera is included in the package contents. The stand requires some assembly.



***The mounting stand is for mounting the network camera to a wall. The camera can stand by itself on a flat surface without the mounting stand.***

- 1.** Attach the included mounting stand to a wall using the included screws as shown below:

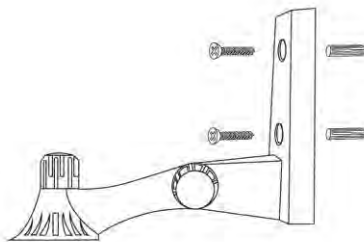

- 2.** Attach the underside of the network camera to the mounting stand and tighten into place, as shown below:

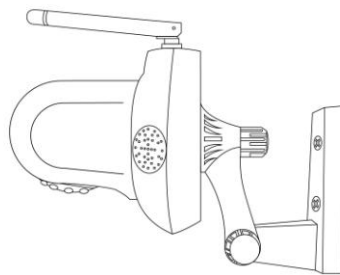

## IV. Web-Based Management Interface

---

When you are using the **same local** network as your camera, you can use the web-based management interface to view or configure the camera and to use the camera's functions such as music player and temperature and humidity sensor.

You can access the web-based management interface with a web browser on a smartphone or computer. For smartphone users, the appearance of the interface will vary slightly to that which is displayed here, though the menu functions which are described later from **IV-1. Basic** onwards are the same.

1. Enter the network camera's IP address into the URL bar of a web browser. The camera's IP address can be found by opening EdiView Finder, as displayed below:

 **Internet Explorer is recommended.**

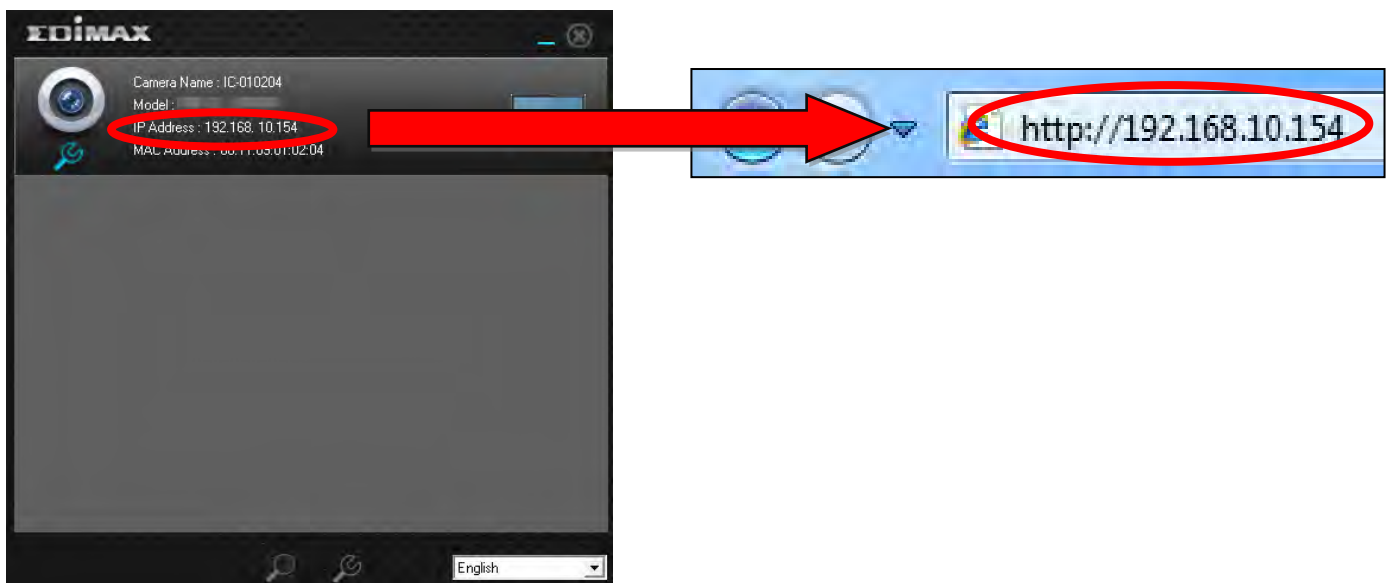

2. You may be prompted to allow a Java add-on to run. Please click the message where it says “click here” and then click “Run Add-on”.

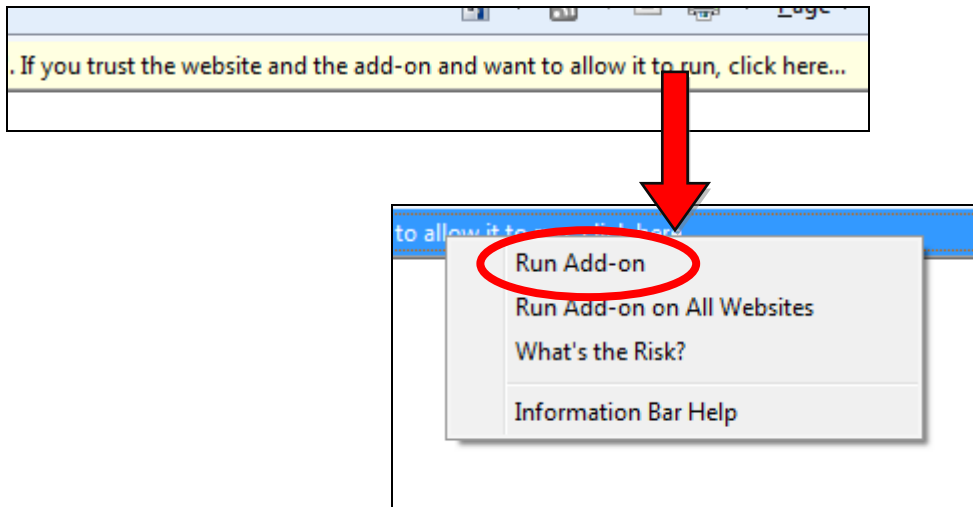

 ***If any other security warnings/prompts appear, please select “Run” or “Allow” or similar, depending on your browser.***

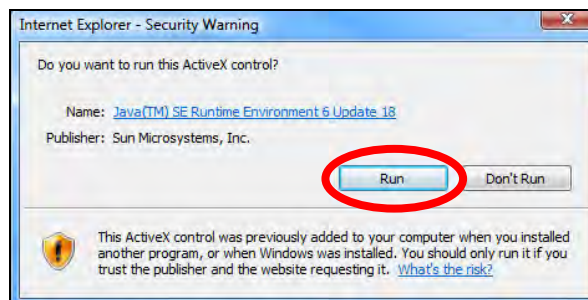



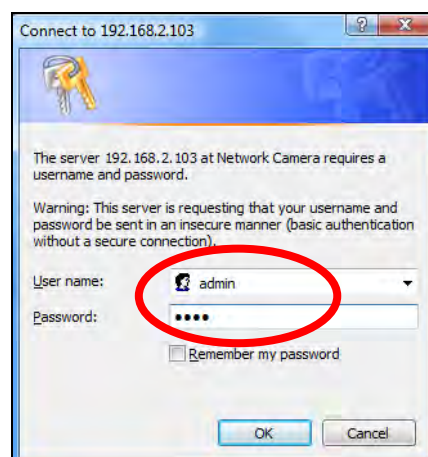

3. Enter the username and password for your network camera (default username: *admin* default password: *1234*). The network camera’s web-based management interface will then be displayed in your browser.

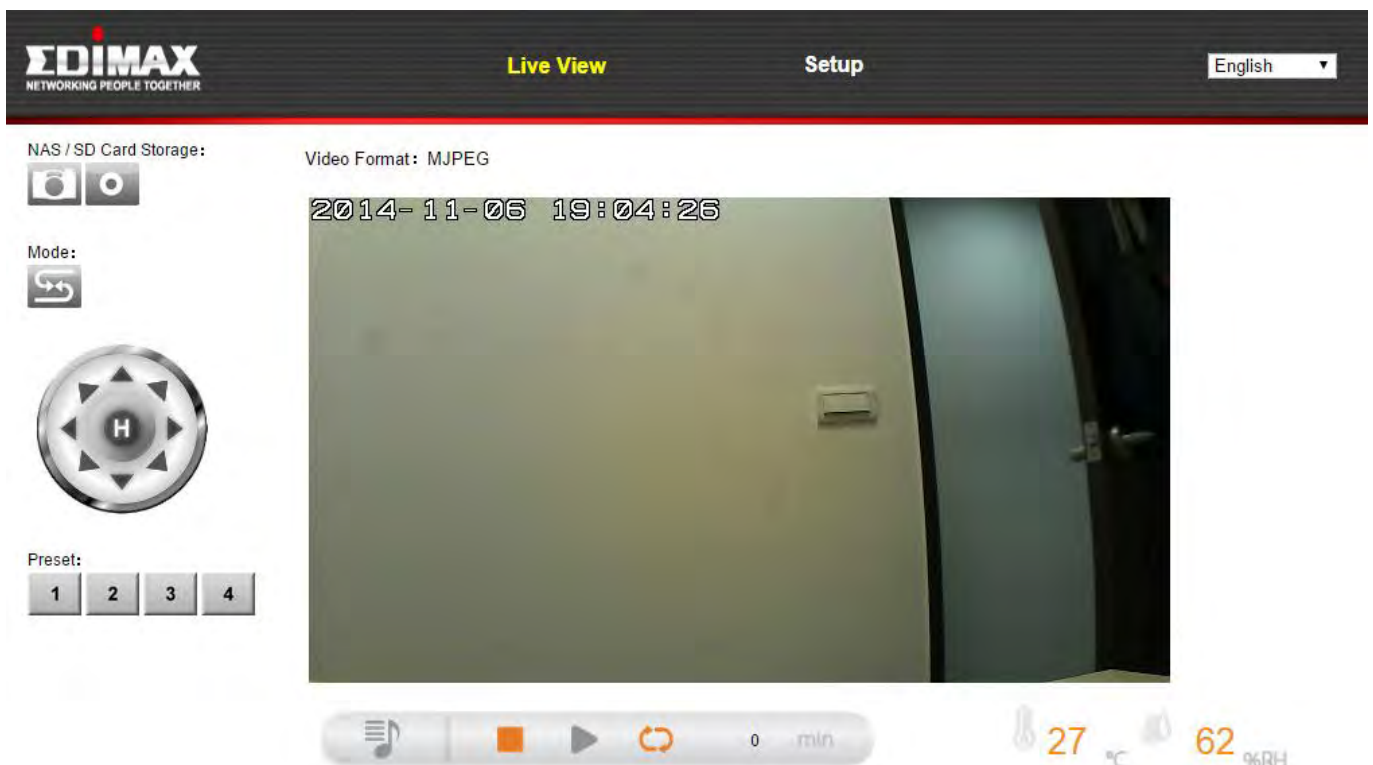

4. For computer users, the “Live View” screen will be displayed, as shown below. On the live view screen you can see a live stream from your camera and use the icons on the left side to pan, tilt and take snapshots or recordings. You can also control the network camera’s music player from here and view temperature and humidity information.

Environment sensor settings can be configured in **System > Environment Sensor**. A log of environment sensor data can be found in **Status > Environment Sensor Log**.



<b>Snapshot</b> 	Save a snapshot (image) of the network camera’s current view. You will be prompted to select a location to save the image.
<b>Record</b> 	Record video. You will be prompted to select a location to save the recording. The icon will display blue while recording, click the icon again to stop recording.
<b>Mode</b> 	Click the icon to reverse the direction of the controls on the remote control.
<b>Remote Control</b> 	Use the remote control to pan/tilt the camera and adjust the viewing position.



<b>Preset</b>				Adjust the camera's viewing position to any of four preset viewing points. Presets can be configured in Pan & Tilt → Preset (refer to IV-4-2. Preset)
1	2	3	4	

## Music Player

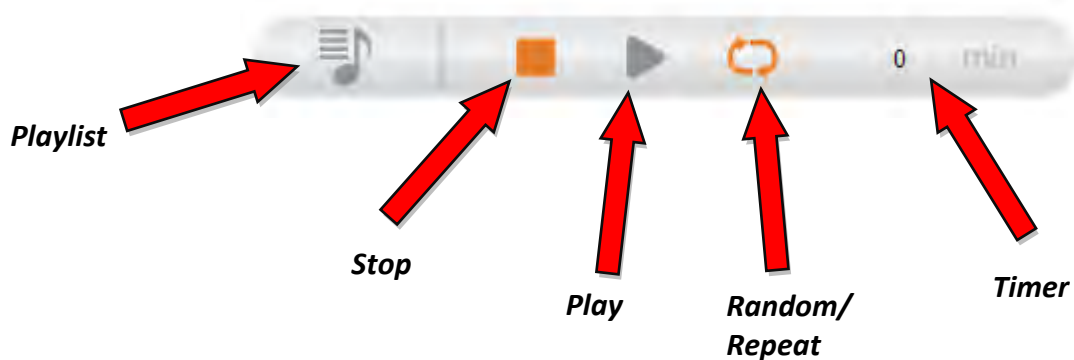

## Playlist

Click the playlist icon to open the menu:

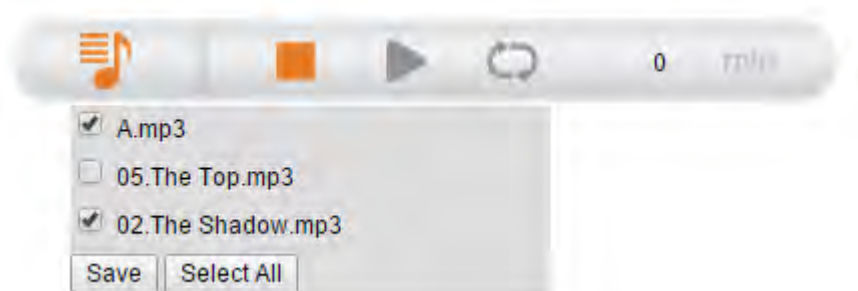

Check the boxes to include songs in the playlist and click "Save". The playlist can consist of a maximum six songs – including the default song stored in the network camera.

To add additional songs (up to five), go to "Audio > Music Settings" (refer to IV-3-1.)

## Random/Repeat



Repeat

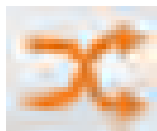

Random

Click the icon to select random, repeat or none. Random will select the next song from the playlist randomly, while repeat will play the next song in the playlist and continue to play the list in a loop.

## Timer

Set the time for use with “Random” and “Repeat” functions. Select from 0, 5, 15, 30 or 60 minutes to continue playing music for that duration.



5. Select “Setup” at the top center and use the menu down the left side to navigate to the network camera’s various settings. Each menu item is described in the following chapters.

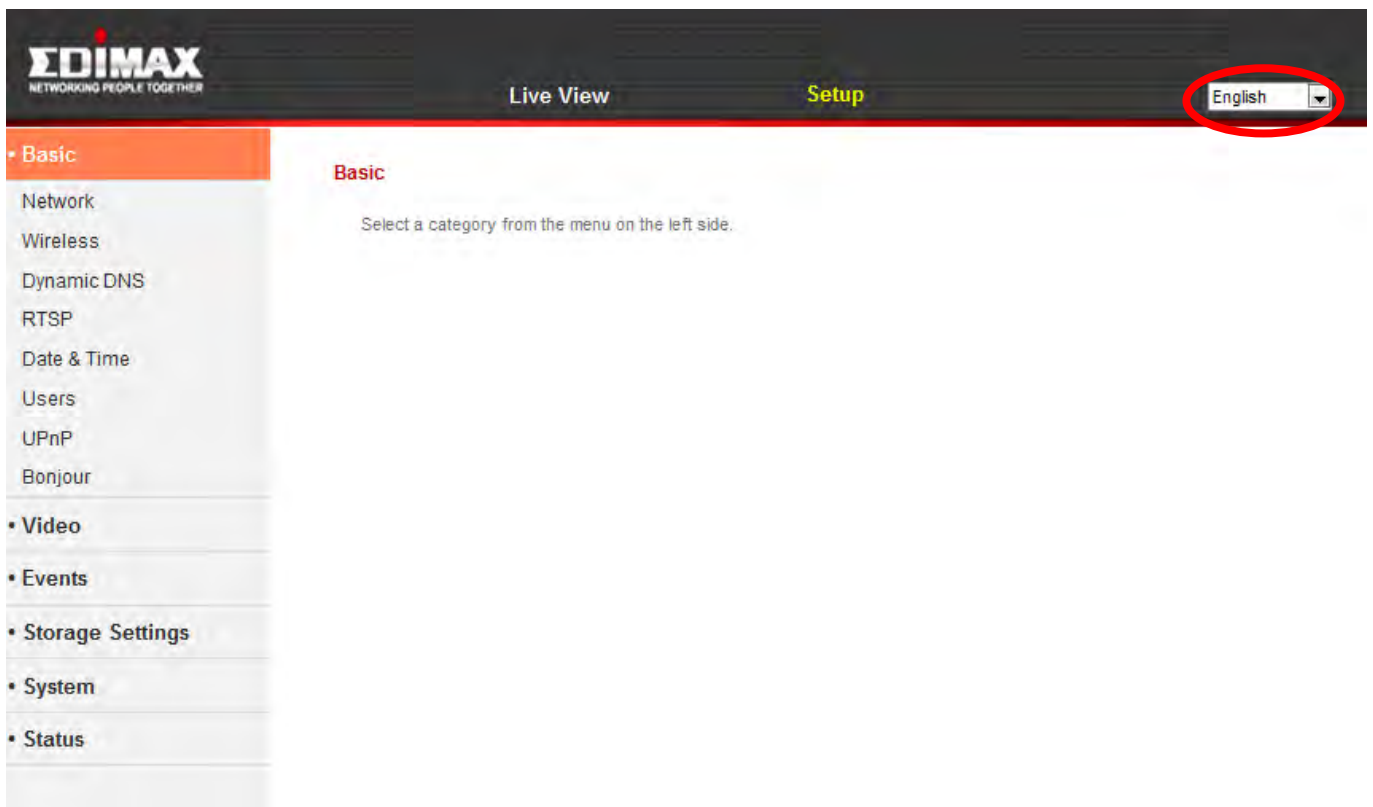

6. After making any changes, click “Save Settings” to save the settings and bring the changes into effect.

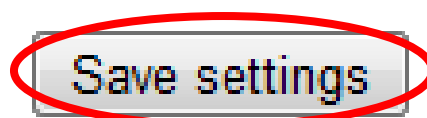

## IV-1. Basic

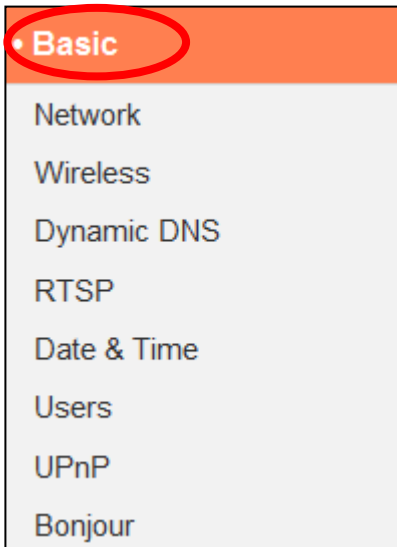

The “Basic” menu opens a submenu with eight categories of settings for your network camera’s basic operation. Select a category and refer to the appropriate chapter.

## IV-1-1. Network

Network settings are displayed on this page, as shown below. You can configure your network camera to dynamically receive a local IP address from your router's DHCP server or you can specify a local static IP address for your network camera. Additionally, advanced users can configure the camera using PPPoE.

**Network**

Network Type:

**Static IP**

IP Address:

Subnet Mask:

Gateway:

Primary DNS:

Secondary DNS:

HTTP Port:

<b>Network Type</b>	Select “DHCP” to automatically assign an IP address to your network camera from your router or “Static IP” to manually set a static IP address using the fields below.
---------------------	--

<b>IP Address</b>	Static IP users specify an IP address here, which will be the IP address of your network camera.
<b>Subnet Mask</b>	Enter the subnet mask of the IP address.
<b>Gateway</b>	Enter the gateway address of your network.
<b>Primary DNS</b>	Enter the IP address of your primary DNS server.
<b>Secondary DNS</b>	Enter the IP address of your secondary DNS server (optional).
<b>HTTP Port</b>	You can edit the HTTP port number to any value between 1024 – 65535. The default value is 80.

## IV-1-2. Wireless

The wireless page allows you to configure settings for your network camera's wireless connection. For Windows users, your wireless connection should have been set up already using EdiView Finder, though you can still use this page to revise the settings if you need.

Mac users need to configure these settings manually since EdiView Finder on Mac will not set up your camera's wireless connection. A quick guide to set up your network camera's wireless connection using a smartphone or a computer is included below.



***Mac users setting their network camera's wireless connection for the first time please ensure your network camera is connected to your router/access point/switch via Ethernet cable.***

You can also use the "wireless" page for Wi-Fi Protected Setup (WPS): to either activate push-button WPS (the same effect as physically pushing the hardware WPS button built into the camera), or PIN code WPS (using a PIN code for verification between the two wireless devices for additional security.)

## IV-1-2-1. Smartphone

1. Select “Basic” from the menu on the left side and then select “Wireless”.

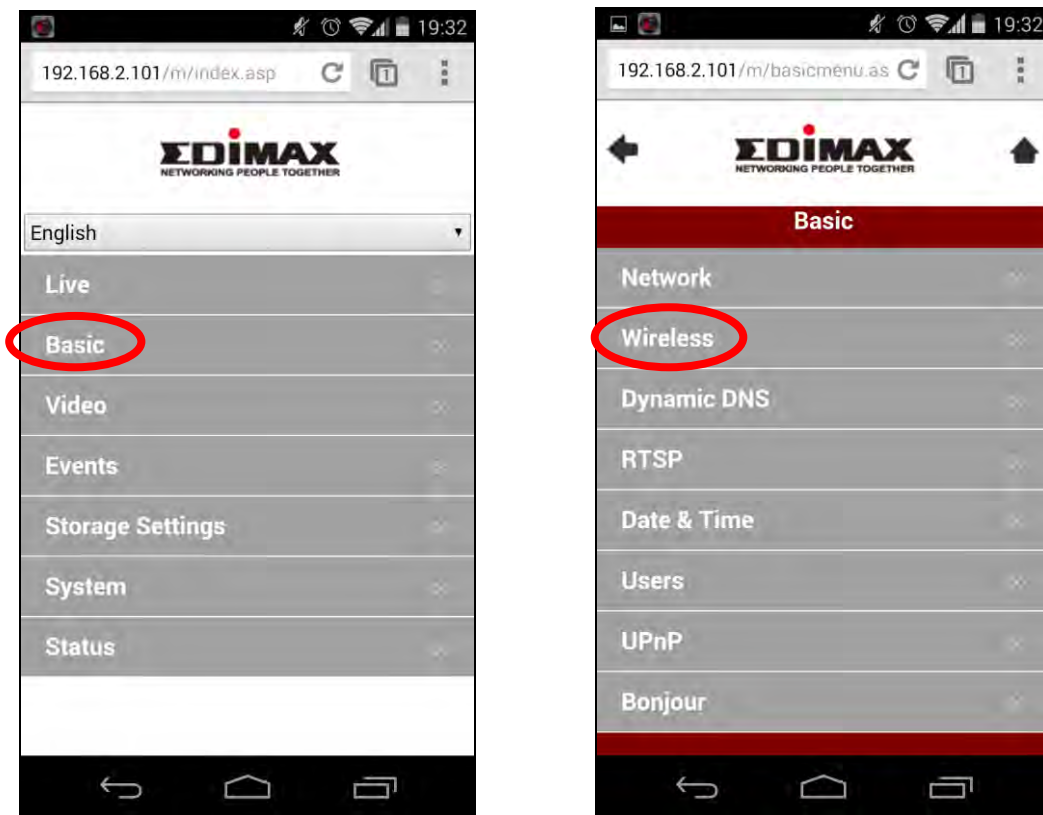

2. Configure the wireless settings **A – E** shown in the table below:



A  
B

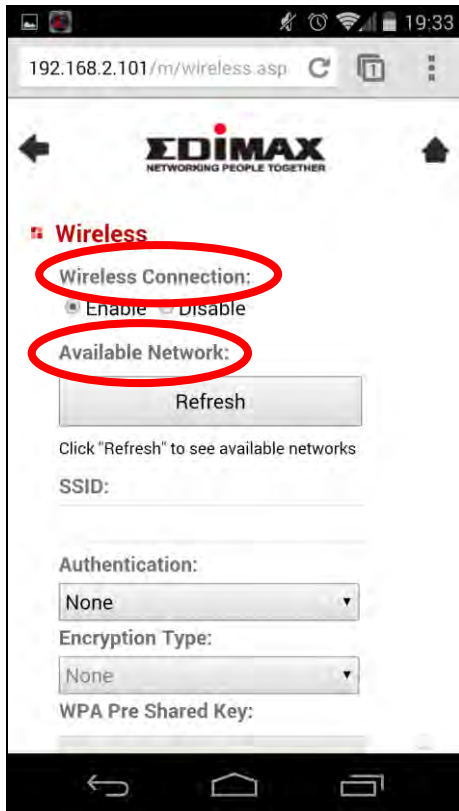

C

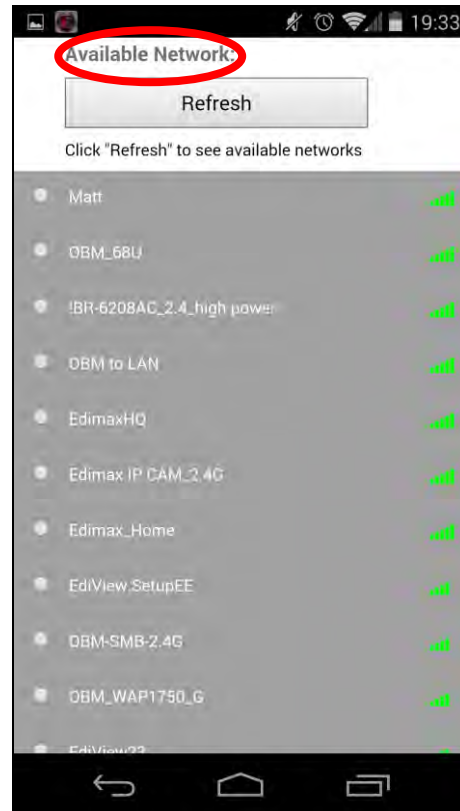

D

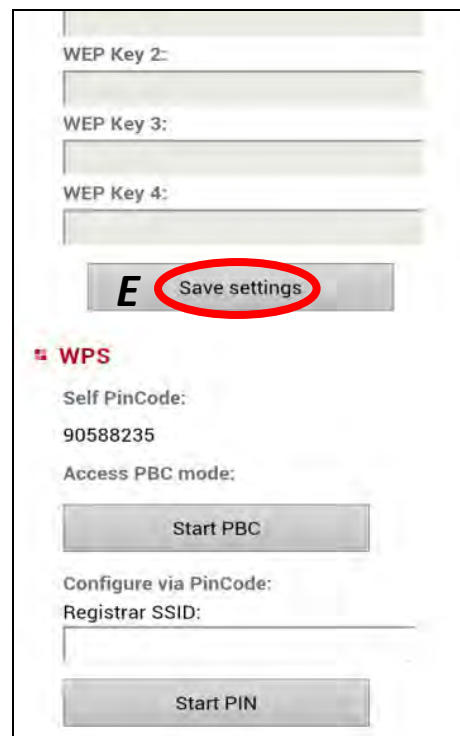
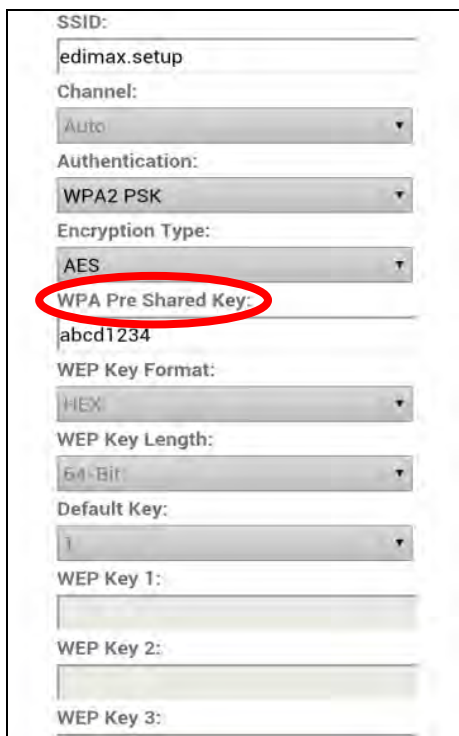

<b>A</b>	<b>Wireless Connection</b>	Select "Enable" to enable the wireless connection.
<b>B</b>	<b>Available Network (1)</b>	Click "Refresh" to display all available Wi-Fi networks.
<b>C</b>	<b>Available Network (2)</b>	Select your Wi-Fi network from the list. This is the wireless network which your camera will connect to.
<b>D</b>	<b>WPA Pre Shared Key</b>	Enter your Wi-Fi password.
<b>E</b>	<b>Save Settings</b>	Click "Save Settings" to save your settings.

**3.** After the settings are saved, remove the Ethernet cable from your network camera. Your camera should now be connected to your Wi-Fi.

## IV-1-2-2. Computer

1. Configure the wireless settings **A – E** shown in the table below:

Wireless

**A** Wireless Connection:  Enable  Disable

Mode: 2.4GHz (B+G+N)

Band: 20 MHz

**B** Available Network:  Click "Refresh" to see available networks

Connected	SSID	BSSID	Signal	Channel	Encryption
<b>C</b> <input checked="" type="radio"/>	chichi	74:DA:38:03:61:50		1	WPA2PSK(AES)
<input type="radio"/>		FC:75:16:EC:F9:88		11	WPA2PSK(AES)

SSID: chichi

Channel: 1

Authentication: WPA2 PSK

Encryption Type: AES

**D** WPA Pre Shared Key:   Show

WEP Key Format: HEX

WEP Key Length: 64-Bit

Default Key: 1

WEP Key 1:   Show

WEP Key 2:

WEP Key 3:

WEP Key 4:

**E**

<b>A</b>	<b>Wireless Connection</b>	Select "Enable" to enable the wireless connection.
<b>B</b>	<b>Available Network</b>	Click "Refresh" to display all available Wi-Fi networks.
<b>C</b>	<b>Connected</b>	Select your Wi-Fi network from the list. This is the wireless network which your camera will connect to.
<b>D</b>	<b>WPA Pre Shared Key</b>	Enter your Wi-Fi password.
<b>E</b>	<b>Save Settings</b>	Click "Save Settings" to save your settings.

2. After the settings are saved, remove the Ethernet cable from your network camera. Your camera should now be connected to your Wi-Fi.

### IV-1-2-3. WPS

WPS (Wi-Fi Protected Setup) is a quick and easy way to set up wireless connections between compatible devices. Use the “Start PBC” or “Start PIN” button to activate WPS on your network camera. Your network camera’s WPS PIN code is also listed next to “Self PinCode”.

**WPS**

Self PinCode: 90588235

Access PBC mode:

Configure via PinCode: Registrar SSID:

<b>Self PinCode</b>	Your network camera’s WPS PIN code is listed here.
<b>Access PBC Mode</b>	Click “Start PBC” to activate push-button WPS on your network camera. This has the same effect as physically pushing the built-in hardware WPS button.
<b>Configure via PinCode</b>	Enter the SSID you wish to connect to and click “Start PIN” to activate PIN code WPS. You will then need to enter the network camera’s “Self PinCode” into your wireless router’s web U.I. and activate your router’s PIN code WPS.



***Please refer to your wireless router’s instructions for help accessing its web-based interface and activating WPS.***

### IV-1-3. Dynamic DNS

Dynamic DNS (DDNS) is a service which provides a hostname-to-IP service for dynamic IP users. If your Internet service provider didn't issue a fixed IP address, you can use a third-party dynamic DNS provider to map your current IP address to a fixed IP address. Several free or paid DDNS services are available online, please use the information provided by your DDNS provider to configure the settings on this page.

#### Dynamic DNS

Enable DDNS:  Enable  Disable

Provider:  

Host Name:

Username:

Password:

<b>Enable DDNS</b>	Select "Enable" to enable DDNS functionality, or select "Disable" to disable DDNS functionality.
<b>Provider</b>	Select your dynamic DNS service provider from the dropdown menu.
<b>Host Name</b>	Enter the hostname you registered with the DDNS service provider.
<b>User Name</b>	Enter the user name you registered with the DDNS service provider.
<b>Password</b>	Enter the password you registered with the DDNS service provider.

## IV-1-4. RTSP

Real Time Streaming Protocol (RTSP) enables the network camera to be used with a streaming media server. Enter the required RTSP settings.

### RTSP Settings

RTSP Port:	<input type="text" value="554"/>
MJPEG RTSP Path:	<input type="text" value="ipcam_mjpeg"/> .sdp
H.264 RTSP Path (HD):	<input type="text" value="ipcam_h264"/> .sdp
H.264 RTSP Path (SD):	<input type="text" value="ipcam_h264s1"/> .sdp
H.264 RTSP Path (Mobile):	<input type="text" value="ipcam_h264s2"/> .sdp
RTP Port Range:	<input type="text" value="50000"/> - <input type="text" value="60000"/>
Verification:	<input type="text" value="Account"/>

<b>RTSP Port</b>	Enter the RTSP port.
<b>MJPEG RTSP Path</b>	Enter the MJPEG RTSP path.
<b>H.264 RTSP Path (HD)</b>	Enter the H.264 High Definition (HD) RTSP path.
<b>H.264 RTSP Path (SD)</b>	Enter the H.264 Standard Definition (SD) RTSP path.
<b>H.264 RTSP Path (Mobile)</b>	Enter the H.264 Mobile RTSP path.
<b>RTP Port Range</b>	Enter the RTP port range.
<b>Verification</b>	Select a verification type from the drop down menu.

## IV-1-5. Date & Time

You can set and adjust the network camera's system time and date on this page. Maintaining a correct system time is particularly important for recorded video organization/playback.

### Date & Time

Mode:  NTP  Manual Setting

Set Time & Date Manually:  /  /   :  :

NTP Server:

Time Zone:

Daylight Saving:  Enable  Disable

<b>Mode</b>	Select "NTP" or "Manual Setting". NTP (Network Time Protocol) can set and maintain the time and date automatically via an NTP server on the local network, if available.
<b>Set Time &amp; Date Manually</b>	For manual setting mode, enter the correct time and date in the following format: YYYY/MM/DD HH:MM:SS
<b>Synchronize to PC time</b>	Click here to automatically enter the same time and date as your computer.
<b>NTP Server</b>	For NTP mode, enter the NTP server's hostname or IP address.
<b>Time Zone</b>	Select the correct time zone.
<b>Daylight Saving</b>	Enable or disable daylight saving according your local time zone.

## IV-1-6. Users

In addition to the default administrator account, you can configure several different login accounts for the network camera, with two different levels of access – operator and guest.

Operator accounts can configure partial functions of the network camera similar to the administrator account, while guest accounts can only view the camera's image.

### Users

User List: Edimax : Operator

User Name:

Password:

Confirm Password:

Authority:  Operator  Guest

Anonymous Login:  Enable  Disable

<b>User List</b>	Existing users are listed here. Select a user here to modify the settings.
<b>User Name</b>	Input user's name here.
<b>Password</b>	Input user's password here.
<b>Confirm password</b>	Input user's password here again for confirmation.



<b>Authority</b>	Select the user's authority: Operators can view video and configure some settings, while guests can only view video.
<b>Add</b>	Add a new user.
<b>Modify</b>	Save the changes to an existing, selected user.
<b>Remove</b>	Remove selected user.
<b>Anonymous Login</b>	Enable or disable anonymous login. Anonymous login allows anyone to login to the network camera and view images. This function is useful if you want to setup a remote video server.

## IV-1-7. UPnP

Universal plug-and-play (UPnP) is a set of networking protocols which enables network devices to communicate and automatically establish working configurations with each other. When enabled, Windows computers can automatically discover the network camera on the local area network. The network camera also supports IGD.

### UPnP

Enable  Disable

Save settings

### IGD (UPnP Port Forward)

IGD Enable (UPnP Port Forward):  Enable  Disable

IGD Configuration (External Port):  IGD Fully Automation (Auto)  IGD Semi Automation (Manually)

External HTTP Port:

External RTSP Port:

<b>Enable/Disable</b>	Enable or disable UPnP.
<b>IGD Enable (UPnP Port Forward)</b>	Enable or disable Internet Gateway Device (IGD).
<b>IGD Configuration (External Port)</b>	Select fully-automated or semi-automated IGD.
<b>External HTTP Port</b>	Enter an external HTTP port.
<b>External RTSP Port</b>	Enter an external RTSP port.

#### IV-1-8. Bonjour

Bonjour is a feature of Mac computers which allows Safari web browser to discover devices and services on the local network and provide a quick shortcut for access. When enabled, Safari users on the local network can find a shortcut to the network camera under Safari's "Bonjour" menu. Select "Enable" or "Disable".

Bonjour

Enable  Disable

## IV-2. Video

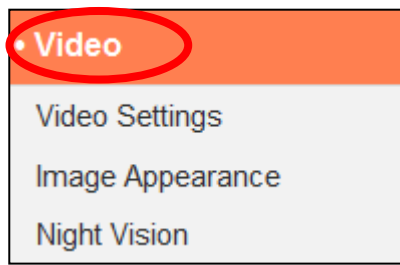

The “Video” menu consists of three categories for configuring the network camera’s video settings. Select an item from the submenu and refer to the appropriate following chapter.

## IV-2-1. Video Settings

The “Video Settings” page enables you to modify the network camera’s resolution and frame rate settings for different profiles: HD, SD, Small (mobile) & MJPEG.

**HD Profile (HD Quality Setting)**

H264 Resolution : 1280x720

Maximum Frame Rate : 15 ▼

H264 Maximum Bit Rate : 1Mbps ▼

**SD Profile (SD Quality Setting)**

H264 Resolution : 640x360

Maximum Frame Rate : 15 ▼

H264 Maximum Bit Rate : 1Mbps ▼

**Small Profile (Mobile Quality Setting)**

H264 Resolution : 320x176

Maximum Frame Rate : 15

H264 Maximum Bit Rate : 0.25Mbps ▼

**MJPEG Profile (Picture Quality Setting)**

MJPEG Resolution : 640x360

Maximum Frame Rate : 15

MJPEG Quality : High ▼

Power Frequency : 60 HZ ▼

Rotate Image : 0° ▼

OSD : On ▼

<b>H264 Resolution</b>	Select a H264 video resolution from the dropdown menu. A higher resolution provides more detailed video but requires more bandwidth.
<b>H264 Maximum Bit</b>	Select a maximum bit rate for H264 videos

<b>Rate</b>	from the dropdown menu. A higher bit rate provides more detailed video but requires more bandwidth. The bit rate is accurate $\pm 20\%$ .
<b>MJPEG Resolution</b>	Select a MJPEG video resolution from the dropdown menu. A higher resolution provides more detailed video but requires more bandwidth.
<b>Maximum Frame rate</b>	Select the maximum video frame rate. A higher frame rate provides smoother video, but also requires more bandwidth.
<b>MJPEG Quality</b>	Select a quality level for MJPEG videos from the drop down menu. Higher quality requires more bandwidth.
<b>Power frequency</b>	Adjust the power frequency to 50 Hz or 60 Hz frequency depending on your local region, in order to reduce flicker/improve playback in your videos.
<b>Rotate Image</b>	Rotate the camera's image by the specified angle.
<b>OSD</b>	Set the network camera's on-screen display (OSD) consisting of time & date to on or off for all live video and video recordings.

## IV-2-2. Image Appearance

The “Image Appearance” page allows you to adjust various parameters relating to the network camera’s image appearance using the sliders shown below.

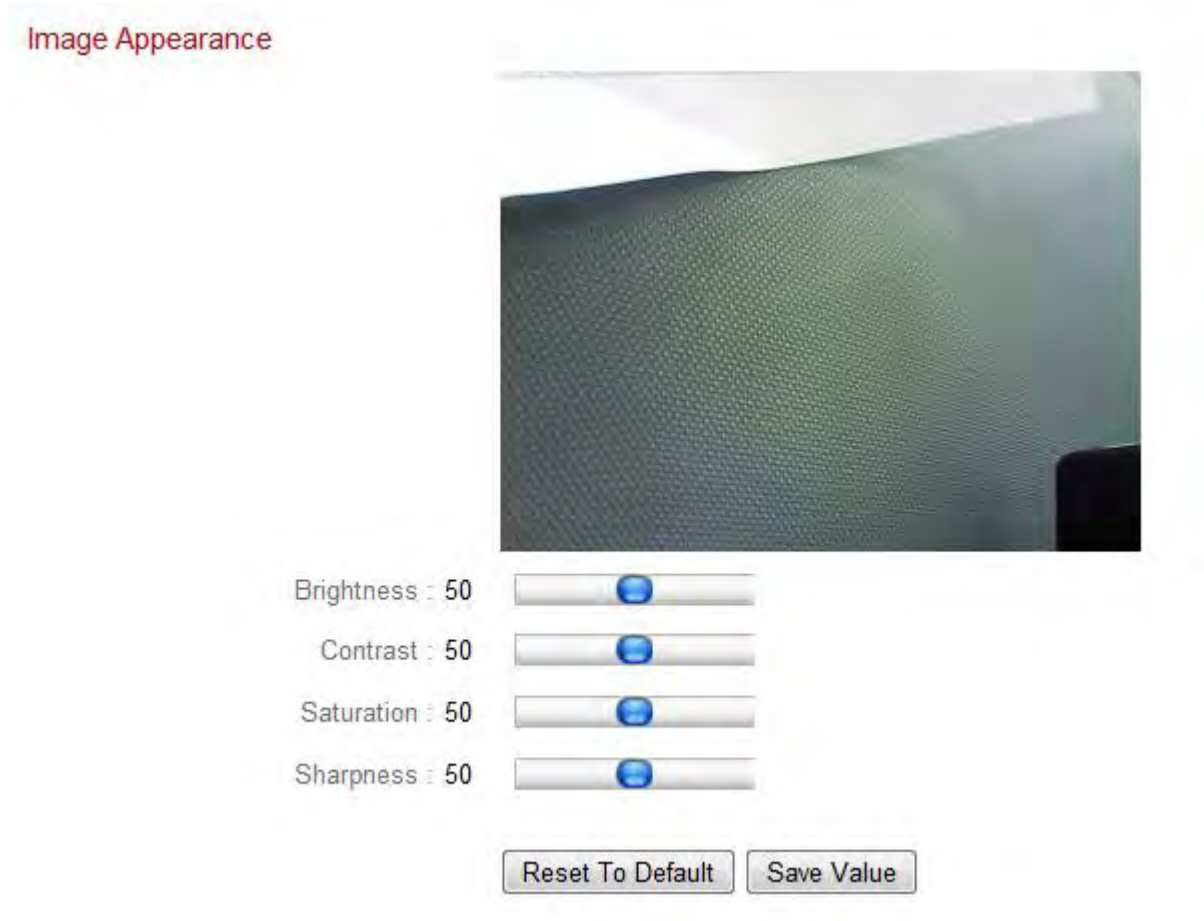

<b>Brightness/ Contrast/ Saturation/ Sharpness/</b>	Click and drag the blue lever to change the value according to your preference for each category.
<b>Reset to default</b>	Click to reset all settings back to the default value of 50.
<b>Save value</b>	Save changes.

### IV-2-3. Night Vision

Night-vision allows your network camera to capture images in dark environments by using infra-red LEDs. Auto-switch will detect light levels in your network camera's environment and automatically switch to night-vision in low light. Select "Enable" or "Disable" for night-vision auto-switch.

#### Night Vision

Auto Switch :  Enable  Disable



## IV-3. Audio

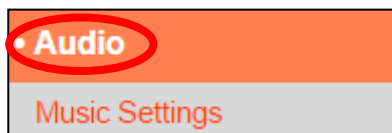

The network camera includes an audio feature to play music from a microSD card. Configure the settings using the “Music Settings” page:

### IV-3-1. Music Settings

When you insert a microSD card into the network camera, a folder named “Music” will automatically be created. Move your music to the “Music” folder of the SD card using the “Upload mp3 file” function and then use the “Show mp3 files” button to add music to your playlist.



***Music files must be .mp3 files with 8KHz – 48KHz sampling rate.***

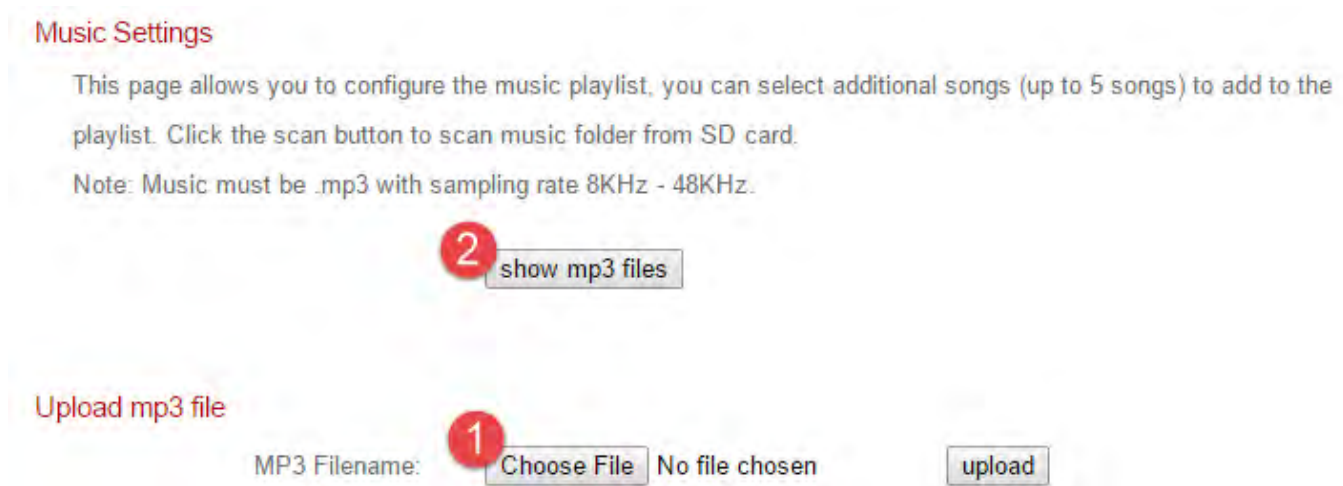

1. Click “Choose File” and browse your computer for the music file you wish to upload to the microSD card.



***You can also manually move music files to the microSD card’s “Music” folder using your computer’s file browser/explorer.***

2. Click “Show mp3 files” to scan the microSD card’s “Music” folder and display all available music files:

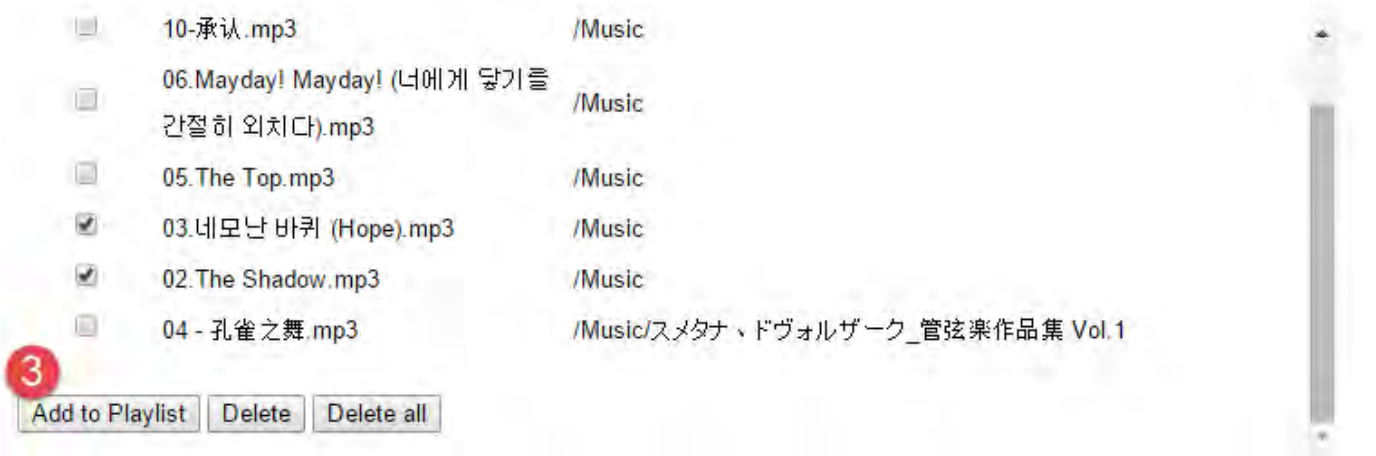

3. Use the checkboxes to select music files and click “Add to Playlist” to add selected files to the playlist.

The music files will now be available using the music player in the “Live View” screen:

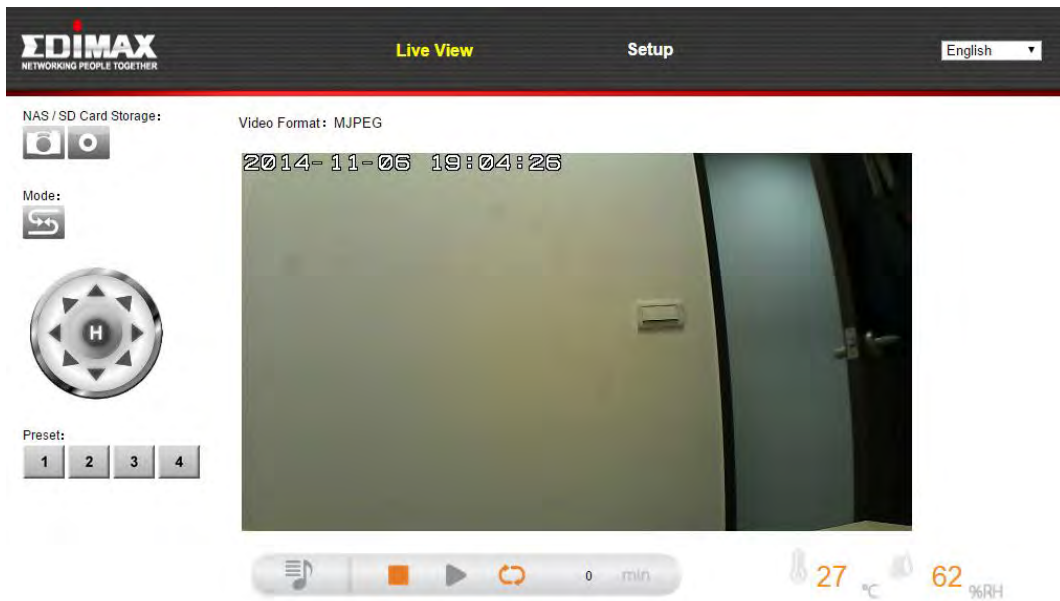

Click the playlist icon to open the menu:

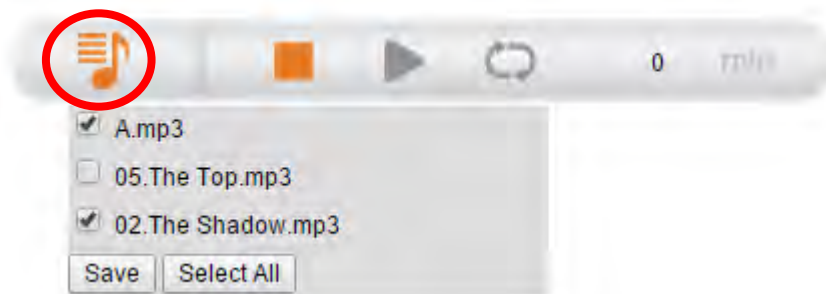

Check the boxes to include songs in the playlist and click “Save’. The playlist can consist of a maximum six songs – including the default song stored in the network camera.

## IV-4. Events

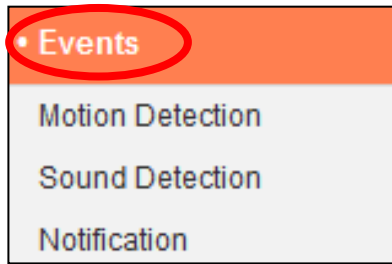

Select an item from the “Events” menu and refer to the appropriate following chapter. You can configure settings for motion detection, scheduling, SMTP and FTP.

### IV-4-1. Motion Detection

#### IV-4-1-1. Motion Detection

The network camera features a motion detection function and various options for (motion detection) events notification. When motion is detected, it is defined as an “event” and the camera will record for a specified length of time. You can set the camera to send this recording as a notification via email or FTP, and/or to local storage such as a NAS or microSD card inside the camera.

You can also set the camera to send a push notification for each event to a smartphone with EdiView II installed. You can view a 10 second recording of the event, which is automatically stored in the network camera’s memory, from the app’s “Events” menu.



***Recordings stored automatically in the network camera are limited to 10 seconds and only a limited quantity can be stored. These recordings are separate from any recordings saved to local storage or sent via email/FTP, and will be overwritten as new recordings are created.***

## Motion Detection

Motion Detection :  Enable  Disable

Interval Time To Detect : 10 second ▼

## FTP / Email Notification

Upload Event File to FTP :  Enable  Disable

Send Event File to Email :  Enable  Disable

Video Recording Time : 10 second ▼

## Save Video To Local Storage

Save Event Files to NAS or SD :  Enable  Disable

Video Recording Time : 5 Minute ▼

<b>Motion Detection</b>	Enable or disable the motion detection function of your network camera.
<b>Interval Time To Detect</b>	After motion is detected, the network camera will not detect motion again for this length of time. For example, using an “Interval Time To Detect” of 20 seconds means that after motion is detected, the camera will not detect any further motion for 20 seconds. Then after 20 seconds, the camera will detect motion again.
<b>Upload Event File to FTP</b>	A video recording of a detected event can be sent to a designated FTP server. Select “Enable” or “Disable” for this function. When enabled, you need to configure the FTP server information on the “FTP” page of the “Events → Notification” menu.
<b>Send Event File to Email</b>	A video recording of a detected event can be sent to a designated email recipient. Select “Enable” or “Disable” for this function. When enabled, you need to configure email settings in the “Events → Notifications → Mail Settings” menu.
<b>Video Recording Time</b>	Specify the length of time for the email or FTP video recording here.
<b>Save Event Files to NAS or SD</b>	Enable or disable the camera’s function to save video files to NAS or MicroSD card. When enabled, you need to configure the settings in the “Storage Settings” menu.
<b>Video Recording Time</b>	Specify the length of time for the NAS or microSD video recording here.

## IV-4-1-2. Detection Region

When using the network camera's motion detection function, you can specify the area in the video where the network camera should be sensitive to motion. Motion outside of the detection region will be ignored by the network camera. This is useful to avoid false alarms.

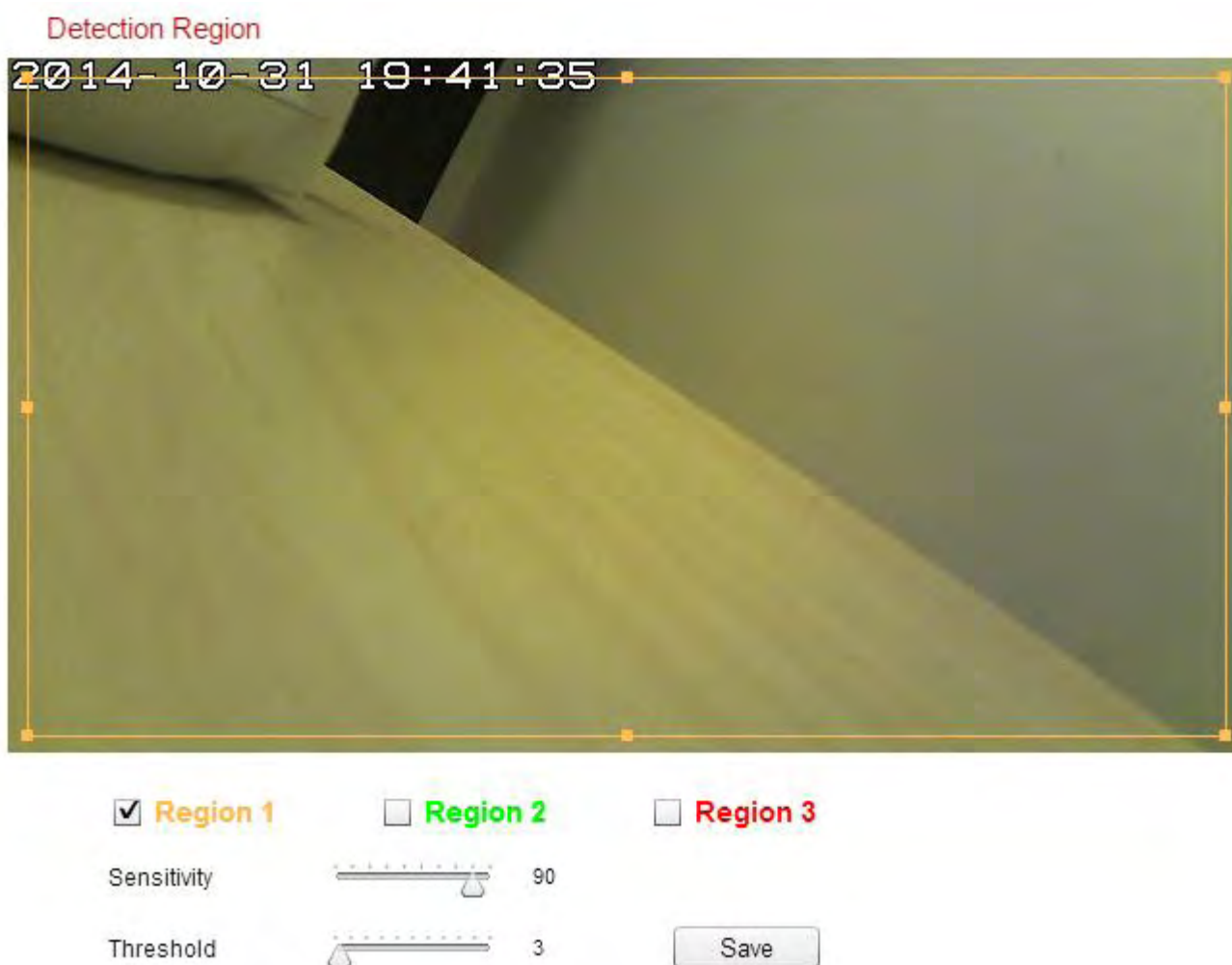

<b>Region 1 / Region 2 / Region 3</b>	Check the box to enable up to three motion detection regions. A color-coded rectangle will appear on the video view for each enabled region. Adjust the size and position of each box according to your preference by clicking and dragging inside the box (move) or on the edges (resize).
---	---

<b>Sensitivity</b>	Adjust the sensitivity level of motion detection for each region. A higher value will trigger the alarm for minor motion in the video and vice-versa. You can reduce the sensitivity level if you receive unnecessary event notifications.
<b>Threshold</b>	Adjust the motion detection threshold level for each region. A higher value will trigger the alarm for large objects in the video, a lower value will trigger the alarm for smaller objects.
<b>Save</b>	Save your settings.

### IV-4-1-3. Schedule Settings

The network camera’s motion detection function can be scheduled to be active on/at specified times and days. Select “Enable” to enable this feature and then define which times the network camera’s motion detection will be active using the table below.

For each day, click and drag across the timeline on the times which you want motion detection to be active. A blue box indicates a scheduled recording. In the example below, motion detection is scheduled for 8am – 6pm Monday to Saturday.

 **By default, the schedule may be full. Delete existing entries if necessary. For scheduled recording, see Storage Settings → Schedule Settings.**

#### Schedule Settings

Schedule :  Enable  Disable

	00:00	03:00	06:00	09:00	12:00	15:00	18:00	21:00	24:00
Sunday	[Timeline]								
Monday	[Timeline]			[Active]				[Timeline]	
Tuesday	[Timeline]			[Active]				[Timeline]	
Wednesday	[Timeline]			[Active]				[Timeline]	
Thursday	[Timeline]			[Active]				[Timeline]	
Friday	[Timeline]			[Active]				[Timeline]	
Saturday	[Timeline]			[Active]				[Timeline]	

Buttons: Delete, Delete all, Select all, Store

Start : 08 : 00  
End : 18 : 00



<b>Delete</b>	Delete the selected blue recording block on the timeline.
<b>Delete All</b>	Delete all blue recording blocks on the timeline.
<b>Select All</b>	Select all blue recording blocks.
<b>Store</b>	Store the recording settings on the timeline.

## IV-4-2. Sound Detection

### IV-4-2-1. Sound Detection

The network camera features a sound detection function and various options for (sound detection) events notification. When sound is detected, it is defined as an “event” and the camera will record for a specified length of time. You can set the camera to send this recording as a notification via email or FTP, and/or to local storage such as a NAS or microSD card inside the camera.

You can also set the camera to send a push notification for each event to a smartphone with EdiView II installed. You can view a 10 second recording of the event, which is automatically stored in the network camera’s memory, from the app’s “Events” menu.



***Recordings stored automatically in the network camera are limited to 10 seconds and only a limited quantity can be stored. These recordings are separate from any recordings saved to local storage or sent via email/FTP, and will be overwritten as new recordings are created.***

## Sound Detection

Sound Detection :  Enable  Disable

Interval Time To Detect :

## FTP / Email Notification

Upload Event File to FTP :  Enable  Disable

Send Event File to Email :  Enable  Disable

Video Recording Time :

## Save Video To Local Storage

Save Event Files to NAS or SD :  Enable  Disable

Video Recording Time :

Save settings

## Sound Level

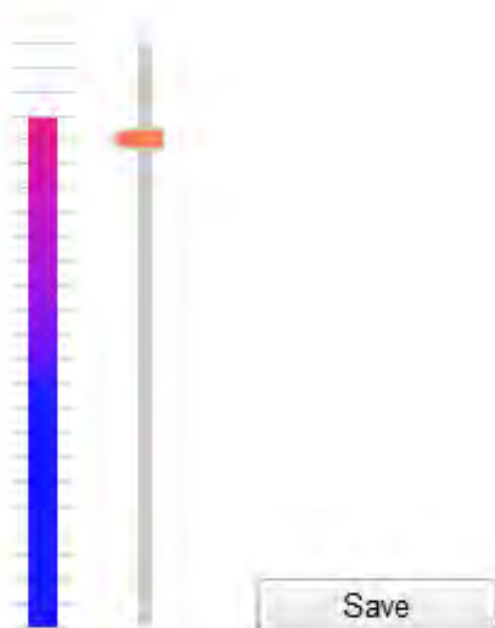

<b>Sound Detection</b>	Enable or disable the sound detection function of your network camera.
<b>Interval Time To Detect</b>	After sound is detected, the network camera will not detect sound again for this length of time. For example, using an “Interval Time To Detect” of 20 seconds means that after sound is detected, the camera will not detect any further sound for 20 seconds. Then after 20 seconds, the camera will detect sound again.
<b>Upload Event File to FTP</b>	A video recording of a detected event can be sent to a designated FTP server. Select “Enable” or “Disable” for this function. When enabled, you need to configure the FTP server information on the “FTP” page of the “Events → Notification” menu.
<b>Send Event File to Email</b>	A video recording of a detected event can be sent to a designated email recipient. Select “Enable” or “Disable” for this function. When enabled, you need to configure the SMTP server information on the “SMTP” page of the “Events → Notification” menu.
<b>Video Recording Time</b>	Specify the length of time for the email or FTP video recording here.
<b>Save Event Files to NAS or SD</b>	Enable or disable the camera’s function to save video files to NAS or MicroSD card. When enabled, you need to configure the settings in the “Storage Settings” menu.
<b>Video Recording Time</b>	Specify the length of time for the NAS or microSD video recording here.
<b>Sound Level</b>	Set the level of sound which will trigger a detection event. Adjust the slider up/down to your preferred sound level. The vertical display to the left of the slider indicates the current sound level picked up by the camera’s built-in microphone.

### IV-4-3. Notification

#### IV-4-3-1. Mail Settings

Recordings of events (motion or sound detected) can be sent to a designated email recipient. This function must be enabled in “Motion Detection” or “Sound Detection” settings in the “Events” menu. Enter the required information about your sender and recipient email accounts as shown below.

**Mail Settings**

Email Service Provider:

SMTP Server:

SMTP Port:

Recipient Email Address:

Sender Email Address:

SSL/TLS:

SMTP Authentication:  Enable  Disable

Account:

Password:

<b>Email Service Provider</b>	Select “Manual Settings” to enter the information manually or select a common email provider to enter some of the information automatically.
<b>SMTP Server</b>	Input the host name or IP address of the SMTP server for the email sender. This information can be provided by your email service provider.
<b>SMTP Port</b>	Input the SMTP port number for the email sender. Most SMTP servers use port number 25, while some SMTP servers use encrypted connections with a port number of 465. This

	information can be provided by your email service provider.
<b>Recipient E-Mail Address</b>	Enter the email recipient's email address here.
<b>Sender E-Mail Address</b>	Enter the sender's email address here to avoid spam filter issues.
<b>SSL/TLS</b>	Select 'SSL or TLS' when your SMTP server requires encryption.  Consult your mail server administrator when in doubt.
<b>SMTP Authentication</b>	Select 'Enable' when your SMTP server requires authentication. This information can be provided by your email service provider.
<b>Account</b>	Input the SMTP account name when your SMTP server requires authentication. This information can be provided by your email service provider.
<b>Password</b>	Input the password used for SMTP server authentication.
<b>Send Test Email</b>	Click here to send a test email with the current settings.



***Gmail users please ensure that “Less Secure Apps” is enabled in your Google account “Security” settings, otherwise your email password may be rejected.***

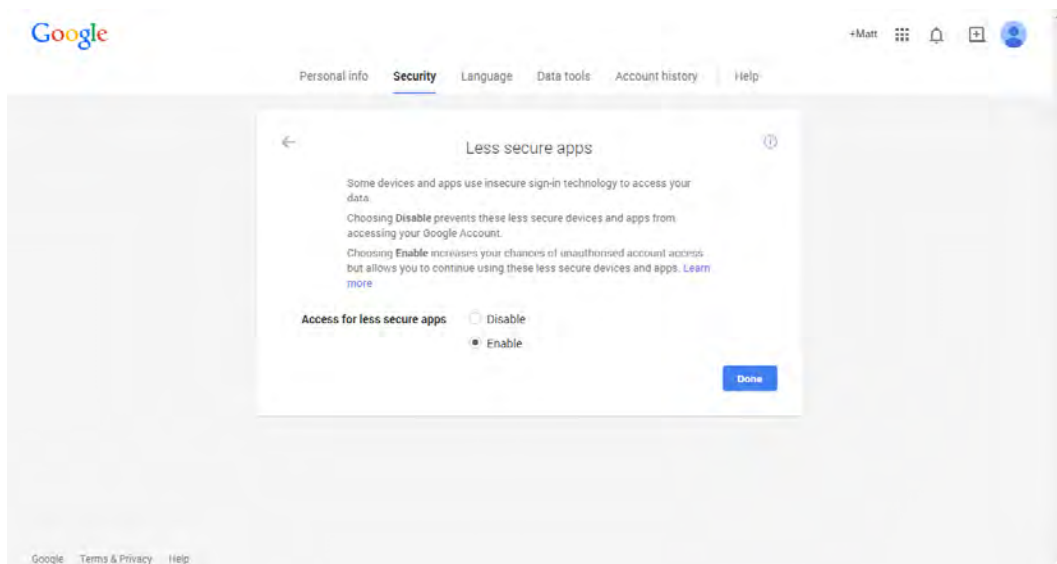

## IV-4-3-2. FTP

Recordings of events (motion or sound detected) can be sent to a designated FTP server. This function must be enabled in “Motion Detection” or “Sound Detection” settings in the “Events” menu. Enter the required information about your FTP server as shown below.

### FTP

FTP Server:

Username:

Password:

Port:

Path:

Passive mode:  Enable  Disable

<b>FTP Server</b>	Enter the IP address or host name of the FTP server.
<b>User Name</b>	Enter the user name required by the FTP server.
<b>Password</b>	Enter the password of the FTP server.
<b>Port</b>	Enter the port number of the FTP server. This value should be an integer between 1 and 65535. Please don't change this value unless advised by the FTP server's administrator.
<b>Path</b>	Enter a path (folder) to save files on the FTP server. If blank, files will be saved in the FTP server's default root folder.
<b>Passive mode</b>	Enable or disable passive mode according to your FTP server.

### IV-4-3-3. Push

The network camera can send push notifications to your smartphone if you have the EdiView II app installed. Push notifications can be sent based on motion detection and sound detection events, and also when your camera reconnects to the Internet after a disconnection.



**Reconnection alerts are sent when the camera actually reconnects to the Internet, not when a disconnection occurs.**



<b>Push notification</b>	Enable or disable all push notifications.
<b>Sound alert</b>	Switch push notifications for sound alerts on or off.
<b>Video/Human motion alert</b>	Switch push notifications for motion detection events on or off.
<b>Reconnected to Internet alert</b>	Switch push notifications for Internet reconnection on or off.
<b>Environment Sensor Alert</b>	Switch push notifications for environment sensor alerts on or off.



## IV-5. Storage Settings

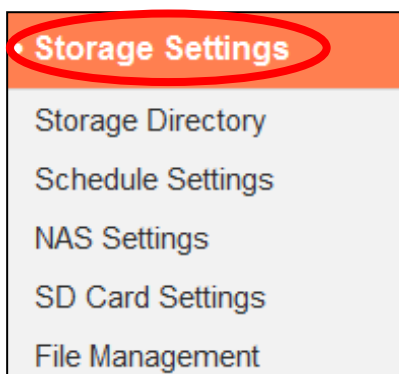

The “Storage Settings” menu enables you to configure the settings for local storage of motion or sound detection events/recordings. You can also configure scheduled recording.

### IV-5-1. Storage Directory

The network camera can store recordings of motion detection events to local storage: NAS or MicroSD.

Select a video profile for the recordings (HD, SD or Small) and select your storage location and click “Save settings”.

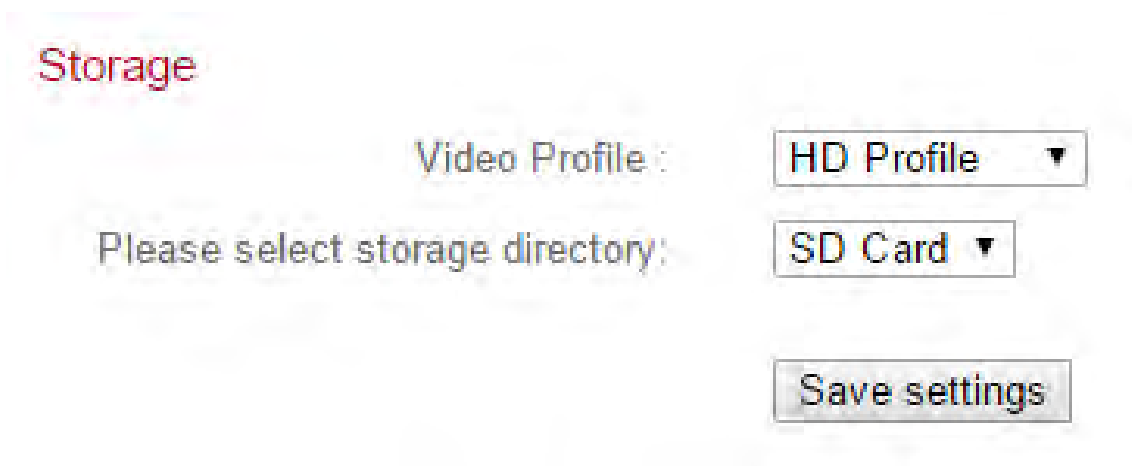

***A MicroSD card must be installed in the network camera to use this function.***



***Configure the settings for your NAS or MicroSD card in the “NAS Settings” or “SD Card Settings” menu respectively.***



### IV-5-3. NAS Settings

If using a NAS server for local storage, configure the settings on this page according to your NAS.

#### NAS Settings

Status: Disconnected

NAS IP & Sharing Resource : \\  \  \

Notification for space full :  Enable  Disable

Cycle Recording :  Enable  Disable

Max Recording File Time :  ▼

Authentication :  ▼

Username :

Password :

<b>Status</b>	Displays the status (connected or disconnected) of your network camera and NAS server.
<b>NAS IP &amp; Sharing Resource</b>	Enter the local IP address of your NAS and the path of a shared folder to store your network camera's recordings.
<b>Notification for space full</b>	Enable or disable email notifications when your storage space is full.
<b>Cycle Recording</b>	Enable or disable cycle recording. When enabled, cycle recording will overwrite the earliest recordings when the storage space becomes full. When disabled, recording will stop when storage is full.
<b>Max Recording File Time</b>	Set the maximum recording time for each file. This applies to scheduled recordings only. For motion or sound detection recording file times, refer to "Events → Motion/Sound Detection".
<b>Authentication</b>	Select "Account" and enter the username and password in the fields below if your NAS server requires authentication. Select

	“Anonymous” if no authentication is required.
<b>Username</b>	Enter the username if “Account” is selected above.
<b>Password</b>	Enter the password if “Account” is selected above.

#### IV-5-4. SD Card Settings

The “Basic” menu enables you to set the camera’s name and administrator password, as well as switch the LED(s) on/off according to your preference.



***Unmount your MicroSD card using the “Unmount” button before removing the card from your network camera.***

#### SD Card Settings

Status : No SD card available

Availbale Space :

Notify when space is not enough :  Enable  Disable

Cycle Recording :  Enable  Disable

Max Recording File Time : 5 Minute ▼

<b>Status</b>	Displays the MicroSD card status of your network camera: available or unavailable.
<b>Available Space</b>	Displays the available space on the MicroSD card in your network camera.
<b>Notify when space is not enough</b>	Enable or disable email notifications when your storage space is full.
<b>Cycle Recording</b>	Enable or disable cycle recording. When enabled, cycle recording will overwrite the earliest recordings when the storage space becomes full. When disabled, recording will

	stop when storage is full.
<b>Max Recording File Time</b>	Set the maximum recording time for each file. This applies to scheduled recordings only. For motion or sound detection recording file times, refer to “Events → Motion/Sound Detection”.
<b>Format SD Card</b>	Click to format your MicroSD card. This will erase all data on your MicroSD card.
<b>Unmount</b>	Click to unmount your MicroSD card from the network camera. This is recommended before removing the MicroSD card from the camera.

#### IV-5-5. File Management

<b>File Management</b>
Event
Schedule
Manual

The file management tool enables you to browse, download and delete recording files on your MicroSD card. Files are grouped according to the following categories:

**Event:** Recordings or images from motion detection events are displayed here.





**Schedule:** Recordings from scheduled recording are displayed here.

**Manual:** Manual recordings are displayed here.

Select Event, Schedule or Manual and use the file browser to navigate. Folders are organized by date, and then grouped chronologically beginning with 001. Individual file names consist of the date and time of the recording.

##### File List

1 - 4 File ( Total 4 )

Select	File Name
<input type="checkbox"/>	 <a href="#">1970_01_01</a>
<input type="checkbox"/>	 <a href="#">2014_05_07</a>
<input type="checkbox"/>	 <a href="#">2014_05_08</a>
<input type="checkbox"/>	 <a href="#">2014_05_22</a>

<b>Back</b>	Go back to the previous page in the file browser.
<b>First Page</b>	Go back to the first page in the file browser.
<b>Previous Page</b>	Go back to the previous page in the file browser.
<b>Next Page</b>	Go to the next page in the file browser.
<b>Last Page</b>	Go to the last page in the file browser.
<b>Select All</b>	Select all files or folders visible in the file browser.
<b>Select None</b>	Deselect all selected files or folders.
<b>Delete</b>	Delete selected files or folders.

## IV-6. Pan & Tilt



The network camera features pan and tilt capability which can be configured using the “Pan & Tilt” menu. Select a category from the submenu and refer to the appropriate following chapter.

### IV-6-1. Pan & Tilt Settings

Adjust the settings for your network camera’s pan/tilt function according to your preference. You can adjust the pan/tilt speed, distance and auto-calibration settings.

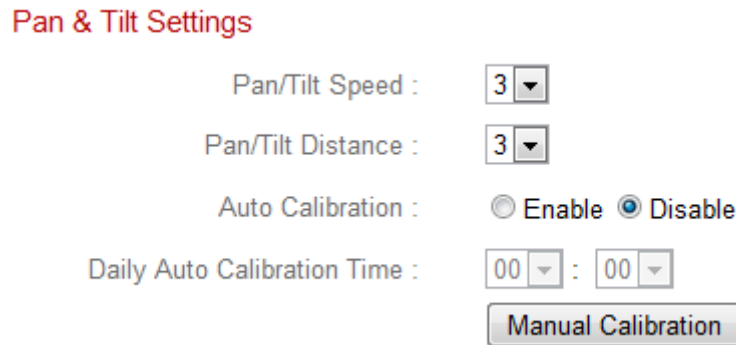

<b>Pan/Tilt Speed</b>	Select a pan/tilt speed from 1 (slowest) to 3 (fastest). This is the speed at which the camera will move when you use the remote control in “Live View”.
<b>Pan/Tilt Distance</b>	Select a pan/tilt distance from 1 (smallest) to 3 (largest). This is the distance which the camera will move with each command when you use the remote control in “Live View”.
<b>Auto Calibration</b>	Calibration is when the camera performs a brief pan/tilt motion for self-maintenance. Enable or disable auto-calibration.
<b>Daily Auto Calibration Time</b>	Set the time at which the camera should auto-calibrate each day, when auto-calibrate is enabled (above). Auto-calibration takes a

	few minutes.
<b>Manual Calibration</b>	Click here to command the camera to calibrate itself immediately.

#### IV-6-2. Preset

The network camera can save up to four preset points within its range of motion, which can then be viewed using the 1 – 4 shortcut icons in “Live View”. This function allows you to avoid manually adjusting the camera’s viewing position each time and instead provides a convenient shortcut to the viewing positions which you use the most.

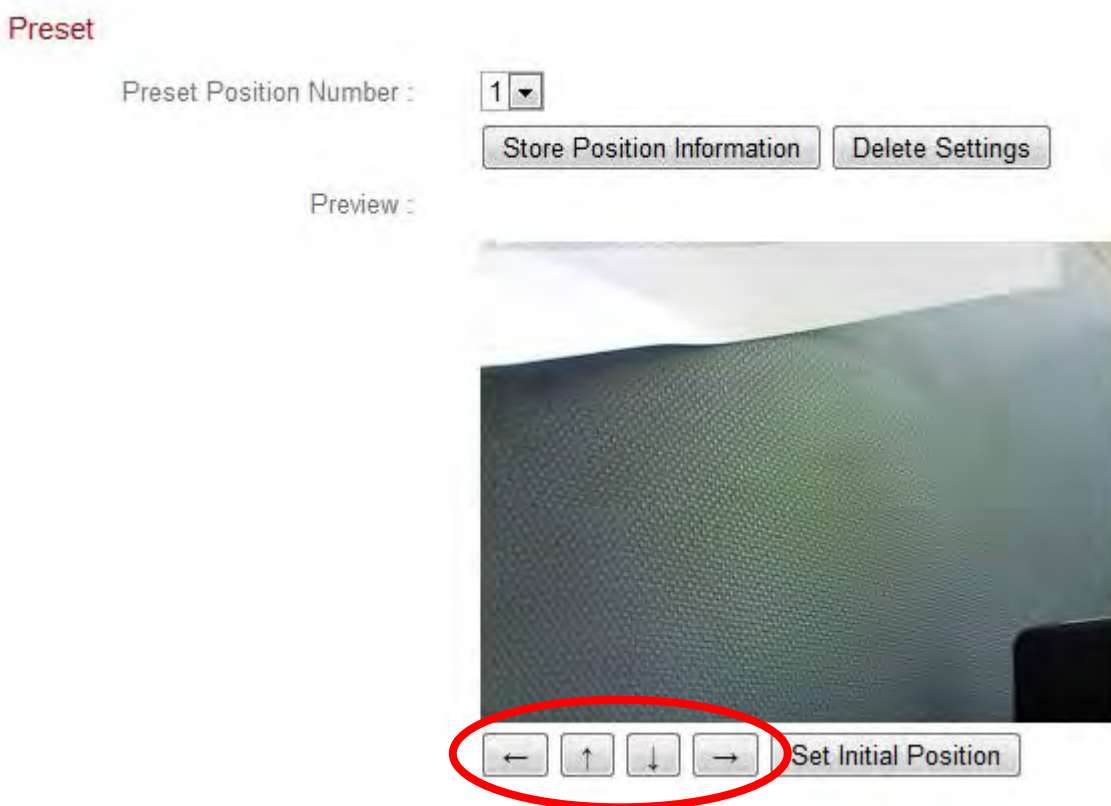

<b>Preset Position Number</b>	Select a preset 1 – 4 from the drop down menu.
<b>Store Position Information</b>	Click to save the current position shown in the “Preview” window as the selected preset point.
<b>Delete Settings</b>	Delete the settings for the selected preset.
<b>Preview</b>	Displays a preview of the network camera’s viewing position. Adjust the position using the arrows below the preview window according



	to your preference, and then click “Store Position Information” (above) to save the position as a selected preset.
<b>Set Initial Position</b>	Reset the preview window/viewing position back to the network camera’s default position.

### IV-6-3. Home

Set the network camera’s default “home” position – select a preset from 1 – 4. You can adjust preset positions in **Pan & Tilt > Preset**.



## IV-7. System

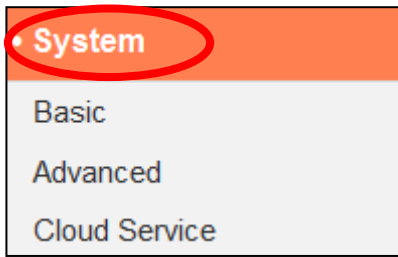

The “System” menu consists of three categories, “Basic”, “Advanced” and “Cloud Service”. Select a category and follow the appropriate chapter for more information.

### IV-7-1. Basic

The “Basic” menu enables you to set the camera’s name and administrator password, as well as switch the LED(s) on/off according to your preference.

#### Basic

Network Camera Name:

Administrator Password:

Confirm Password:

LED Indicators:  On  Off

<b>Network Camera Name</b>	Set the name of the network camera for reference/identification purposes. This is especially useful when managing multiple network cameras.
<b>Administrator Password</b>	Enter your desired administrator password here. This is the password used to log into the camera with the “admin” account. The default password is 1234.
<b>Confirm Password</b>	Confirm your desired administrator password here.
<b>LED Indication</b>	Select “On” or “Off” to switch the network camera’s LED(s) on or off. Switching off the LEDs can be a power saving measure or can be for security purposes, so that anybody who can see the network camera is unaware if the camera is active.

## IV-7-2. Advanced

The “Advanced” page allows you to upgrade the network camera’s firmware, backup or restore the network camera’s settings, and reset or restart the network camera. Please check the Edimax website for the latest firmware for your network camera.



***Do not switch off or disconnect the device during a firmware upgrade, as this could damage the device.***

**Upgrade Firmware**

Firmware Filename:  No file chosen

---

**Backup/Restore Settings**

Backup Settings:

Restore Settings:  No file chosen

---

**Reset**

Restart:

Reset to Default:  Keep Network Settings  Default Settings  Environment Sensor Data

<b>Firmware Filename</b>	Click “Browse” to locate the firmware file on your computer.
<b>Upgrade Firmware</b>	Click to upgrade the firmware to your selected file.
<b>Backup Settings</b>	Click “Apply” to save the current settings on your computer as config.bin file.
<b>Restore Settings</b>	Click “Browse” to find a previously saved config.bin file and then click “Upload” to replace your current settings.
<b>Restart</b>	Click “Restart Network Camera” to restart the network camera. Please wait a couple of minutes for network camera to boot up after

	<p>a restart. Restarting will not affect the camera's current configuration.</p>
<b>Reset to default</b>	<p>Select "Keep Network Settings" or "Default Settings" and then click "Reset to Default".</p> <p>When the camera resets, "Keep Network Settings" will reset all settings but keep the current network settings. The network camera's IP address will remain the same.</p> <p>"Default Settings" will reset all of the camera's settings, including network settings, back to the factory default status.</p> <p>"Environment Sensor Data" will reset only environment sensor data. Environment sensor data consists of temperature and humidity level, recorded every hour for up to one year.</p>

### IV-7-3. Cloud Service

Edimax Plug & View is a function to allow you to view your network camera remotely via a cloud server (see **V. Myedimax.com**). You can enable or disable this feature here.

#### Plug & View

Enable  Disable

### IV-7-4. Environment Sensor

Your network camera includes an environment sensor which can detect the temperature and humidity level, and trigger email alerts and push notifications when temperature or humidity exceeds or drops below specified levels.

#### Environment Sensor

Temperature Sensor:      Display By  Fahrenheit °F  Celsius °C  
When Temperature Exceeds  °C  
When Temperature is Below  °C  
Send an Alert to Email  Enable  Disable

Humidity Sensor:      RH%  
Send a Notice When Humidity Exceeds  RH%  
Send a Notice When Humidity is Below  RH%  
Send an Alert to Email  Enable  Disable

Temperature Sensor	
<b>Display By</b>	Display temperature information in “ <b>Live View</b> ” in degrees Fahrenheit (F) or Celsius (C).
<b>When Temperature Exceeds</b>	When email alerts are enabled (below), specify a temperature which must be exceeded to trigger an alert.
<b>When Temperature is Below</b>	When email alerts are enabled (below), specify a temperature under which alerts will

	be triggered.
<b>Send An Alert to Email</b>	Enable or disable email alerts. When enabled, you need to configure email settings in <b>Events &gt; Notification &gt; Mail Settings</b> .

Humidity Sensor	
<b>Send a Notice When Humidity Exceeds</b>	When email alerts are enabled (below), specify a humidity level which must be exceeded to trigger an alert.
<b>Send a Notice When Humidity is Below</b>	When email alerts are enabled (below), specify a humidity level under which alerts will be triggered.
<b>Send An Alert to Email</b>	Enable or disable email alerts. When enabled, you need to configure email settings in <b>Events &gt; Notification &gt; Mail Settings</b> .

## IV-8      Status

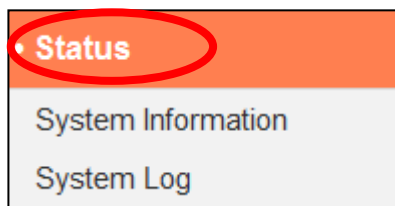

The “Status” menu provides important information about the status of the network camera. This information is useful for troubleshooting purposes or for network configuration.

## IV-8-1. System Information

A summary of system-wide information about the network camera is displayed on this page, displayed under four categories: System, LAN, Wireless LAN and IGD (UPnP Port Forward).

### System

Firmware Version :	v1.00 demo (Oct 2 2014 16:15:22)
Activex Version :	v1.0.1.0
Device Uptime :	1 hours 53 min 44 sec
System Time :	2014/10/31 19:51:18

### LAN

IP Address :	192.168.0.107
Subnet Mask :	255.255.255.0
Gateway :	192.168.0.1
DNS Server 1 :	192.168.0.1
DNS Server 2 :	0.0.0.0
MAC Address :	80:1F:02:DA:C8:DF
HTTP Port :	80

### Wireless LAN

Link Status :	Connected
SSID :	chichi
Channel :	1
Encryption :	WPA2 PSKAES
Access Point MAC Address :	74:DA:38:03:61:50

### IGD (UPnP Port Forward)

Link Status :	UPNP port forward successful
External IP Address :	114.45.202.85
External HTTP Port :	24755
External RTSP Port :	26224



## IV-8-2. System Log

A system log provides information about the network camera's usage and actions. The system log can also be sent to a remote server for archiving.

### System Log

Log Level:

Remote Log:  Enable  Disable

Remote Log Server:

```

May 22 06:26:25 VideoServer[1510]: <eventID>4</eventID><eventTime>2014/05/22 06:26:25</eventTime><det
May 22 06:26:25 recorder[1470]: [recorder.c:4867] Get Event (4)
May 22 06:26:25 pushNotifier[1390]: [pushNotifier.c:456] event.eventID = 4
May 22 06:26:25 pushNotifier[1390]: [pushNotifier.c:194] now - timestamp[IPCAM_EVENT_PIR] = 1400739985
May 22 06:26:25 pushNotifier[1390]: [pushNotifier.c:332] curl 'https://54.251.97.30:55443/push/notify.php' -d '<f
May 22 06:26:25 recorder[1472]: Storage media was not has enough space!! (0)
May 22 06:26:25 recorder[1472]: No enough space.
May 22 06:26:26 recorder[1470]: [recorder.c:4900] remove /tmp/eventRec/ImagePIR/2014-05-22-06-23-46-PIRE
May 22 06:26:26 recorder[1470]: [recorder.c:4906] remove /tmp/eventRec/ImagePIR/2014-05-22-06-23-46-PIRE
May 22 06:26:26 recorder[7424]: [recorder.c:1113] Connect socket: /tmp/mjpegPreRecStream
May 22 06:26:26 recorder[7424]: [recorder.c:1113] Connect socket: /tmp/audioMJPEGPreStream
May 22 06:26:26 recorder[7424]: [recorder.c:4019] Initial record file, start reocrd
May 22 06:26:26 VideoServer[1517]: [videoServer.c:1394] AudioMJPEG PreRec accept client sock=36
May 22 06:26:26 VideoServer[1517]: AudioMPJEG PreRec current connected socket: 175
May 22 06:26:26 VideoServer[1513]: [videoServer.c:1218] mjpeg PreRec accept client sock=46
May 22 06:26:26 VideoServer[1513]: mjpeg PreRec current connected socket: 116
May 22 06:26:26 recorder[1470]: [recorder.c:4941] (1/475139)thread record file /tmp/eventRec/ImagePIR/2014-0
May 22 06:26:28 recorder[1472]: Storage media was not has enough space!! (0)
May 22 06:26:28 recorder[1472]: No enough space.
May 22 06:26:31 recorder[1472]: Storage media was not has enough space!! (0)
May 22 06:26:31 recorder[1472]: No enough space.
May 22 06:26:34 recorder[1472]: Storage media was not has enough space!! (0)

```

<b>Log Level</b>	Select a level of detail for the log from the dropdown list, from 0 - 4. 0 (minimum) will only log critical information, while 4 (maximum) will log everything.
<b>Remote Log</b>	Enable or disable the network camera's remote log function, to send the log to a remote server for archiving. The network camera supports syslog log servers.
<b>Remote Log Server</b>	Enter the IP address or host name of the log server you wish to use.

### IV-8-3. Environment Sensor Log

The environment sensor log displays graphical information from the environment sensor every hour for the past 48 hours, and the text log below displays information for the previous 1 year. You can also click “Export Log File” to save the text log as a file on your computer.

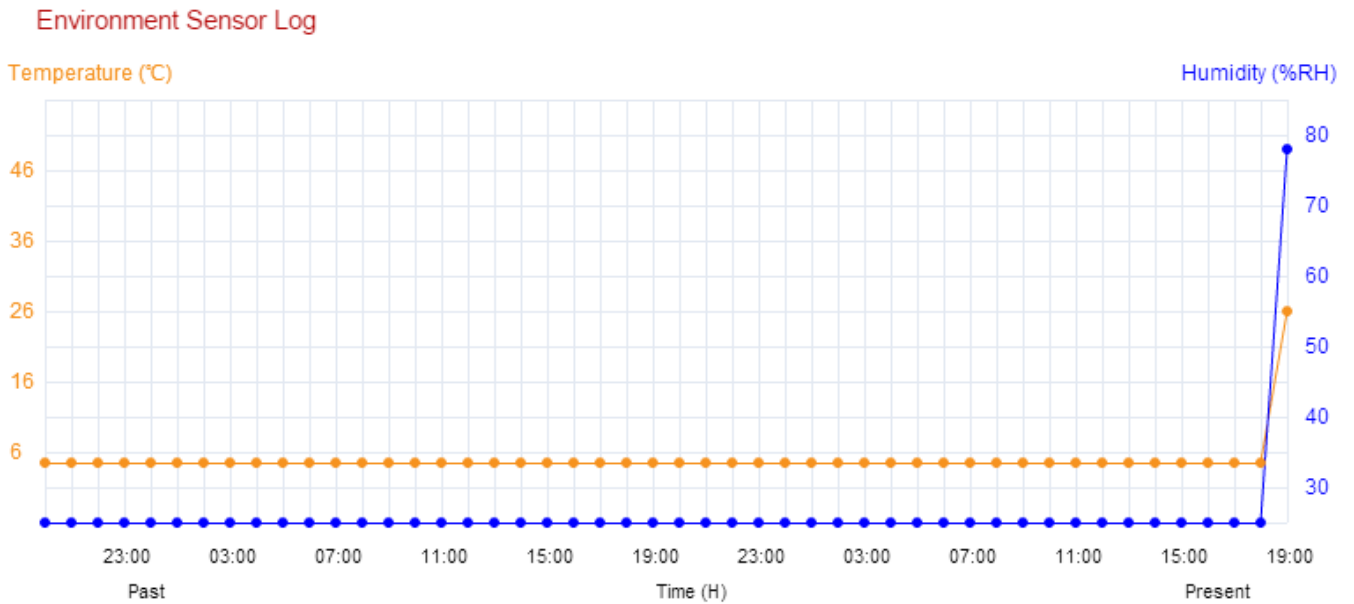

[2014/11/20 19:00]Temperature=26. Humidity=78.

Export log file

## V. Myedimax.com

---

You can use your network camera's Myedimax.com cloud ID to monitor your camera remotely using a web browser from any Internet connection. The network camera's **green** power LED must display **on** to indicate a successful cloud connection, in order for this function to work.

1. Identify your network camera's cloud ID. The cloud ID is displayed in EdiView Finder (see **II-2. EdiView Finder**) and on the product label on the back of the network camera (see **I-4. Product Label**).

 **The cloud ID is a string of 12 characters consisting of numbers 0 – 9 and letters A – F which is unique to your network camera.**



MAC/Cloud ID  
C3  
Setup SSID: EdiView.SetupC3

2. Enter **cloudID.myedimax.com** into the URL bar of a web browser.

For example, if your cloud ID is **001109010204** then enter **001109010204.myedimax.com** into your web browser.

 **Internet Explorer is recommended.**

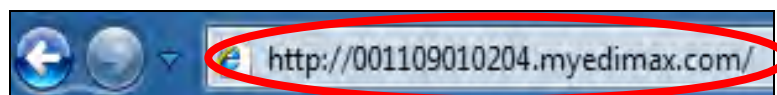

3. You may be prompted to allow a Java add-on to run. Please click the message where it says “click here” and then click “Run Add-on”.

. If you trust the website and the add-on and want to allow it to run, click here...

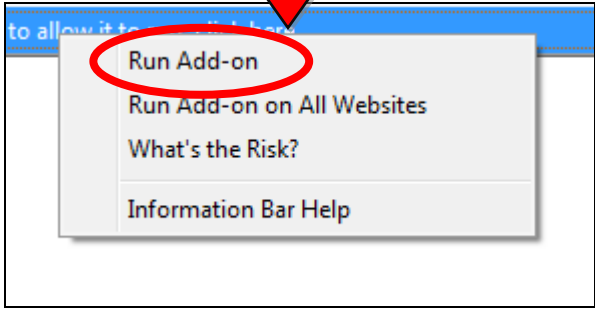

***If any other security warnings/prompts appear, please select "Run" or "Allow" or similar, depending on your browser.***



**4.** Enter your camera's password (default password: 1234) and click "OK" to see a live stream from your network camera.

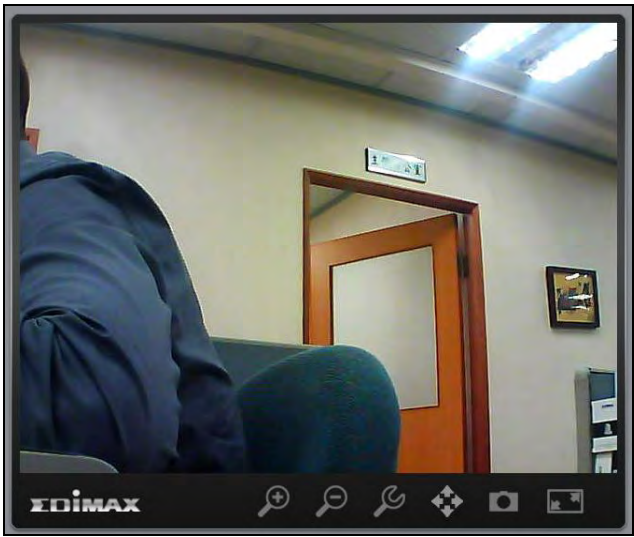
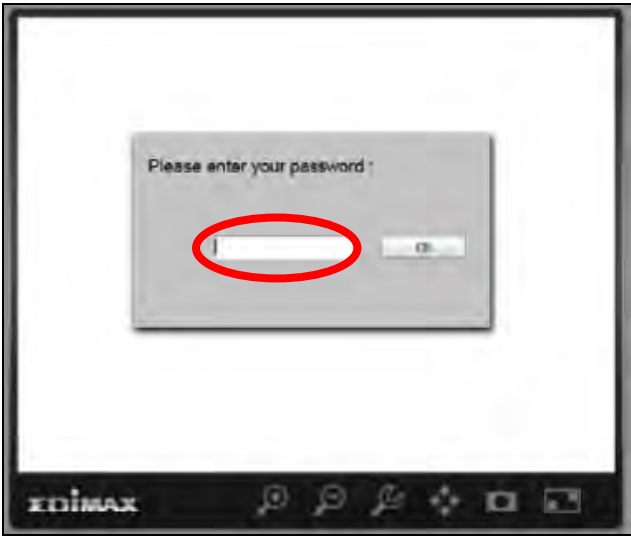

5. The network camera can be operated and configured using the icons in the toolbar located below the image.

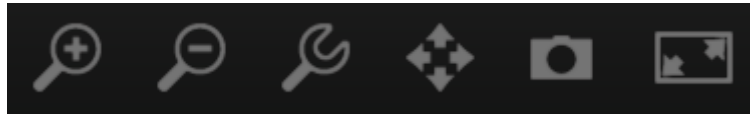

To configure the network camera, click  to show the configuration menu window:

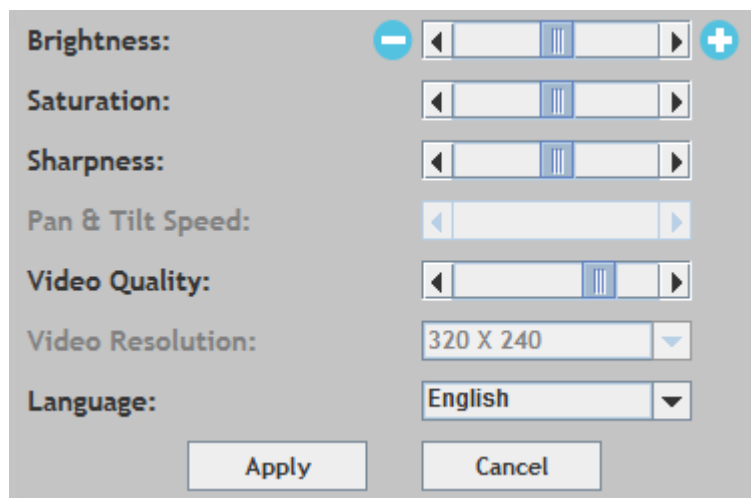

6. Use the slider controls to change the image brightness, saturation, sharpness, video quality and pan & tilt speed. Use the dropdown lists to change the video resolution and operating language, and click “Apply” when finished.



**Functionality of myedimax.com may vary according to version.**

## VI. 16 Channel Viewer for Windows

---

The included 16 channel viewing software provides powerful access to your network camera's functions, along with the capability to view and manage up to 16 network camera simultaneously.

### VI-1. Installation

1. Insert the included CD into your CD-ROM drive and if the setup utility does not automatically open, please locate and open the "Autorun.exe" file in the "Autorun" folder.
2. Click "16 Channel Viewer" to install the EdiView Finder software utility.

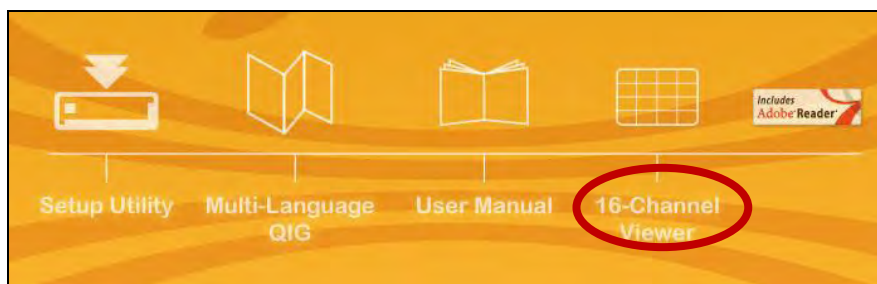

3. Click "Next" and follow the on-screen instructions to install the 16 channel viewer software.

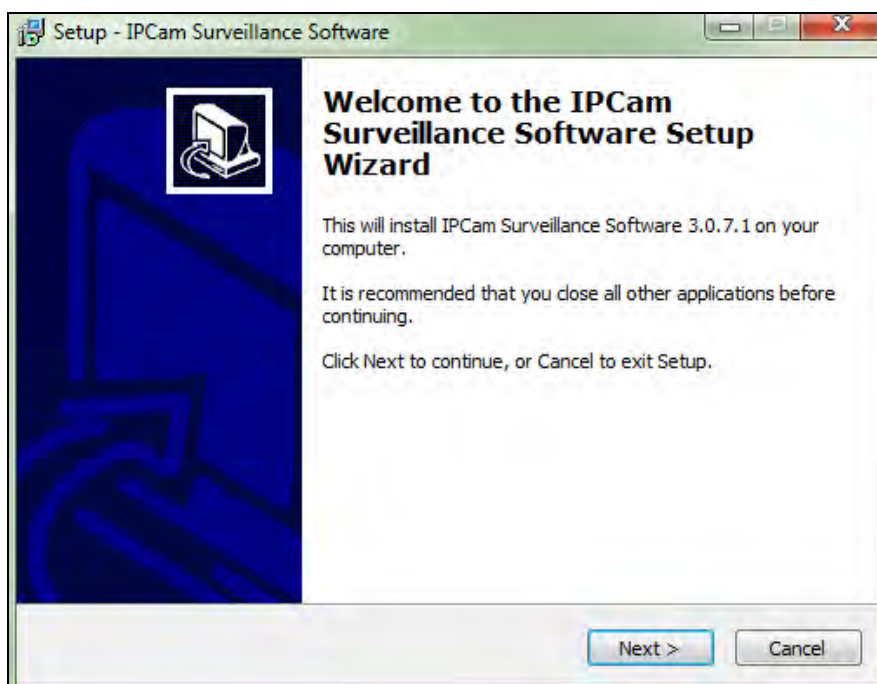



**4.** Check the installation location and click 'Next' to continue.

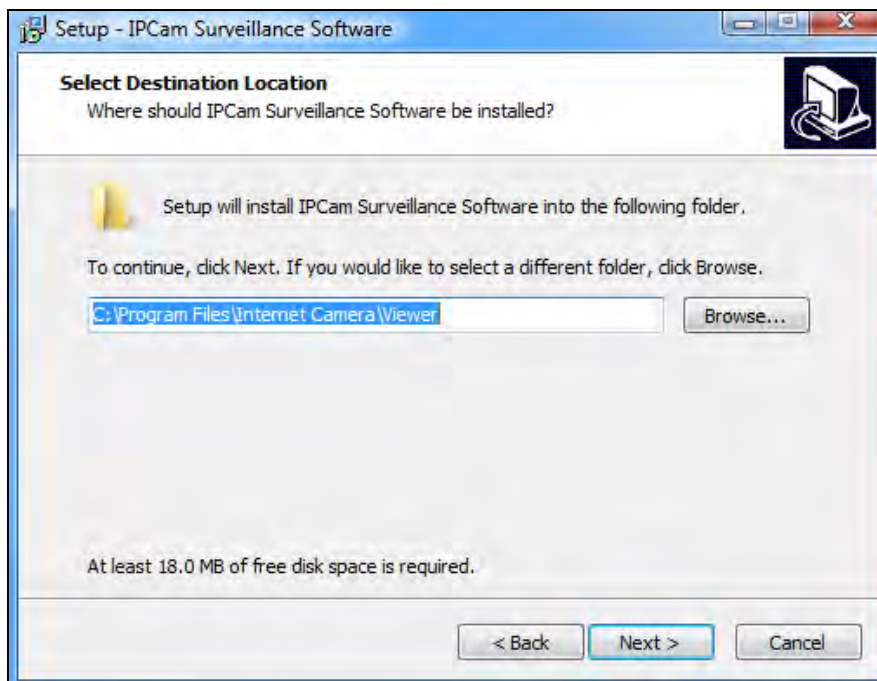

**5.** Click "Next" to continue.

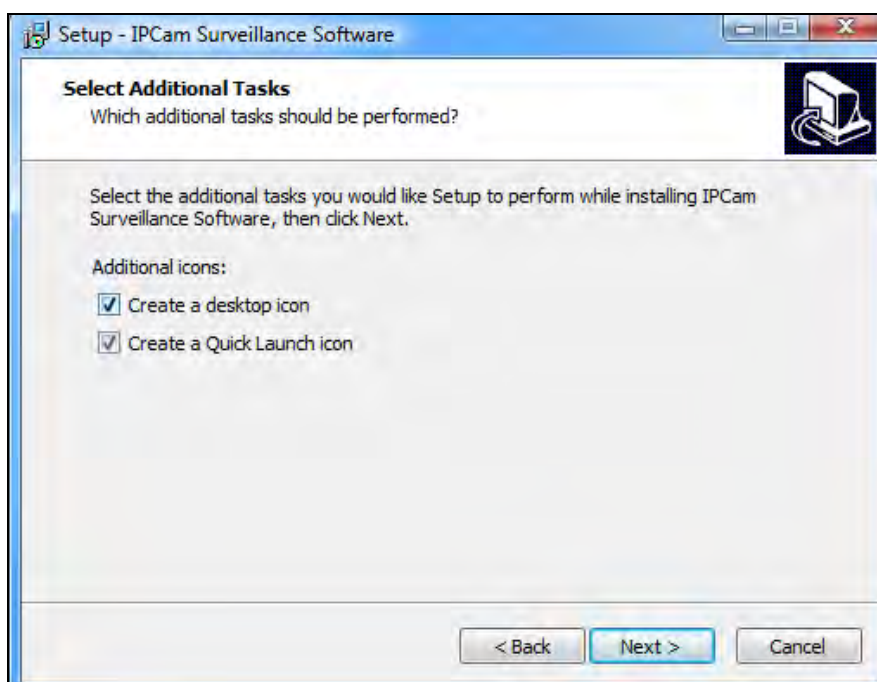

**6.** A summary of your installation will be displayed. Please check everything is correct and click "Install" to begin the installation.

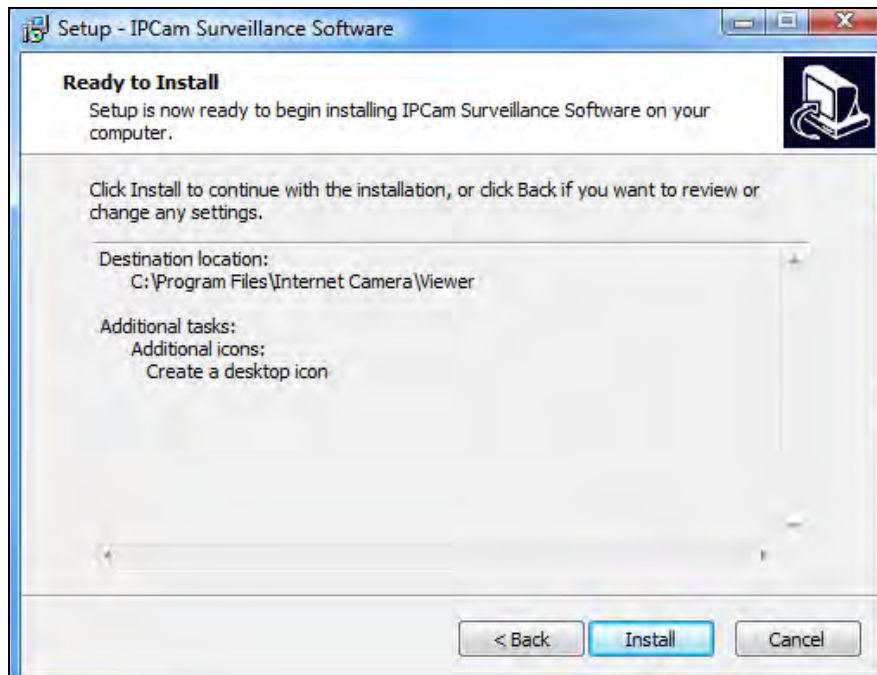

**7.** Please wait a moment for the installation to complete.

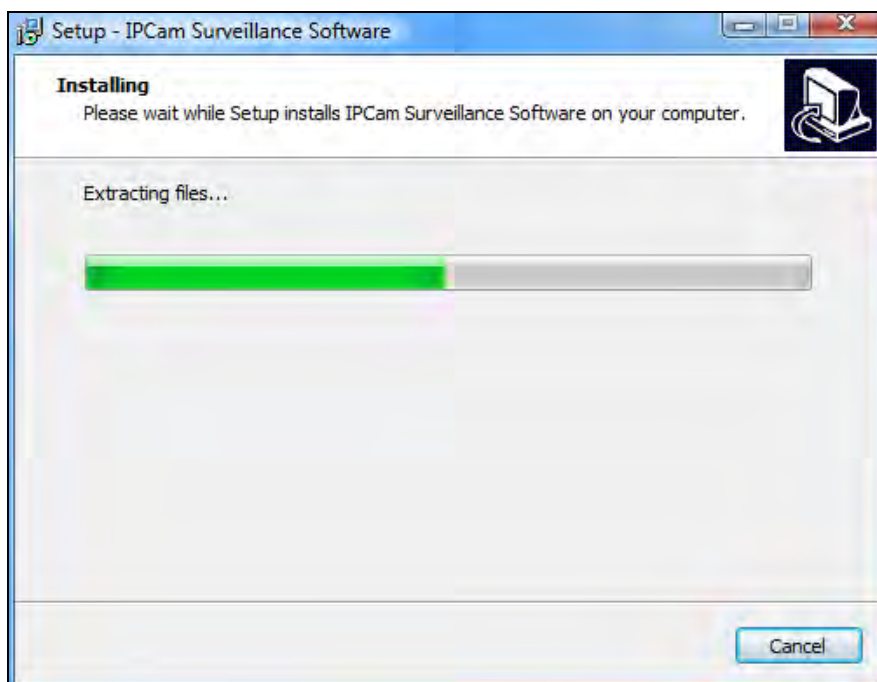

**8.** Click “Finish” and then double click the “IPCam Surveillance Software” icon on your desktop to open the software.



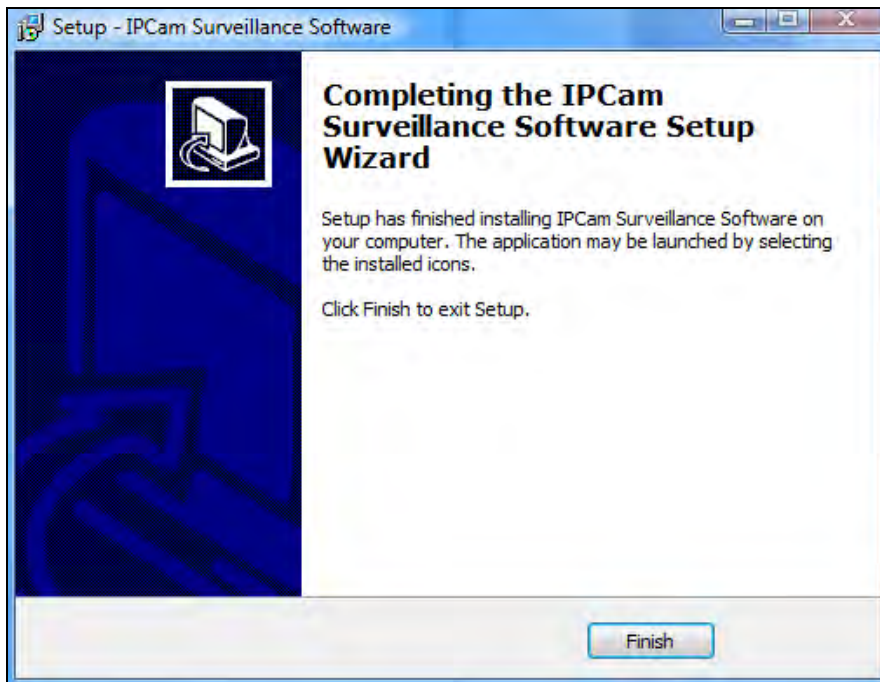







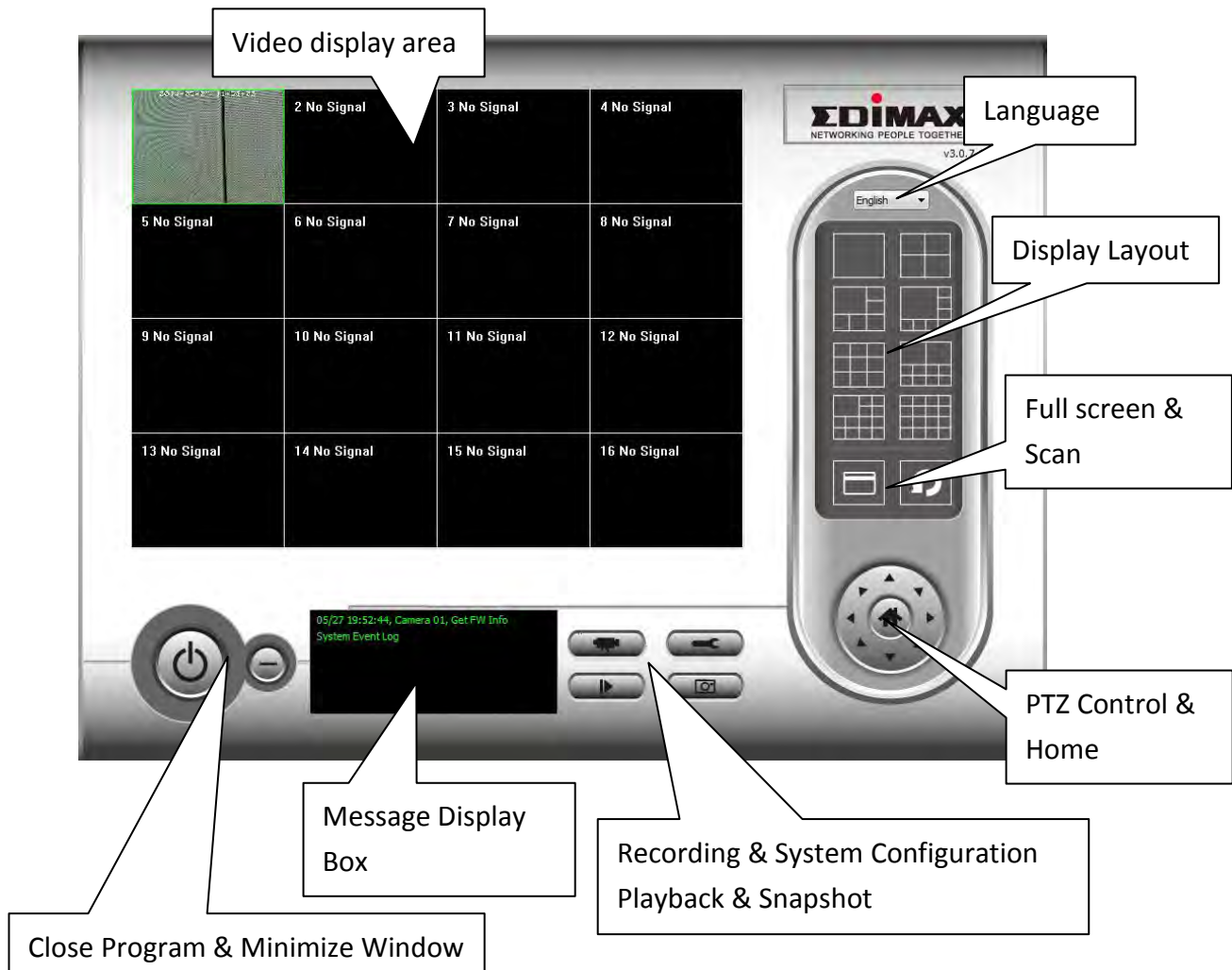







## VI-2. Using the 16 Channel Viewer

 **Your monitor's resolution must be "1024 x 768" for the 16 channel viewer to work properly. Please set your monitor's resolution to "1024 x 768".**

The main screen of the 16 channel viewer is described below:



<b>Video display area</b>	A live image of up to 16 connected cameras will be displayed in this area.
<b>Language</b>	Select a language from this dropdown menu to change the display language.
<b>Display layout</b> 	Change camera image display layout (click a layout icon to change camera display layout). There are 8 kinds of display layouts available.
<b>Full screen</b> 	Click this button to switch to full screen mode (only display all camera's image), press "ESC" key to quit full screen mode.
<b>Scan</b> 	Click this button and the network camera surveillance software will switch through the images of all connected camera automatically. Click this button once to activate the scan function (scan icon will become blue  ) , click again to stop scanning (scan icon will become white  ).
<b>PTZ control</b> 	There are 8 directions in the Pan Tilt Zoom (PTZ) control ring. If the camera you connect to supports PTZ, you can use the PTZ control ring to change the direction that the camera faces.  This function is only available for supported cameras.
<b>Home</b> 	Click this button to return the camera to "Home" (default) position.  This function is only available for supported cameras.
<b>Recording</b> 	Start video recording.
<b>System Configuration</b> 	Camera configuration and general options.
<b>Playback</b> 	Play back a recorded video file. A new window will open to locate recorded files.
<b>Snapshot</b>	Take a snapshot of current the camera image.

	
<b>Message display</b>	Displays all system messages.
<b>Close window (stop surveillance)</b>	Terminates network camera surveillance software.
	
<b>Minimize window</b>	Minimizes network camera surveillance software window.
	

## VI-3. Configuring the 16 Channel Viewer

### VI-3-1. Add Camera/Camera Configuration

In order to use the 16 channel viewer software, you must configure/add each camera(s) that you wish to connect. Please click the wrench icon (  ) and a popup menu will appear:

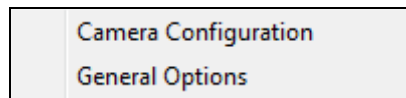

Please select “Camera Configuration” to configure/add cameras:

 ***Please select “Unblock” if you are prompted by Windows Security Alert that “IPCamViewer” has been blocked, or similar.***



## VI-3-1-1. Camera

In the “Camera Configuration” tab you can add and configure all the cameras you wish to connect to the viewer software. To connect a camera to the viewer software, you need to enter the required information in the “Camera Configuration” box. You can do this automatically by selecting your camera listed in the “Camera Search” box and clicking “Select” (recommended) or you can enter the information manually.



***All of the information required to add your network camera can be completed automatically by selecting your camera listed in the “Camera Search” box and clicking “Select”.***

<b>Channel</b>	Select the channel number you wish to use.
<b>Camera Search</b>	All cameras found on your local network will be displayed in the “Camera Search” box.
<b>Select</b>	Select a camera listed in the “Camera Search” box, and click the “Select” button to automatically enter the required information

	to connect the selected camera in the “Camera Configuration” box.
<b>Refresh</b>	Refresh the list of cameras on your local network.
<b>Name</b>	Enter a reference name for the camera here. The default name is the first 6 characters of the camera’s MAC address. The camera name can be used to easily identify its location for example.
<b>Model</b>	Displays the model of the selected camera.
<b>IP Address</b>	Input the IP address of the camera.
<b>Username</b>	Input the user name of the camera.
<b>Web Port</b>	Input the web port of the camera. The default value is “80”.
<b>Password</b>	Input the password of the camera. The default password is “1234”. If you changed the password of the selected camera, enter the new password.
<b>Video Format**</b>	Select the video encoding format of this camera (MJPEG or H.264).
<b>Reset</b>	Clear all fields in the ‘Camera Configuration’ section.

\*\* Only available for cameras which support this function.

Click “OK” to save the settings and your network camera’s image will be displayed in your selected channel on the 16 channel viewer’s main screen:



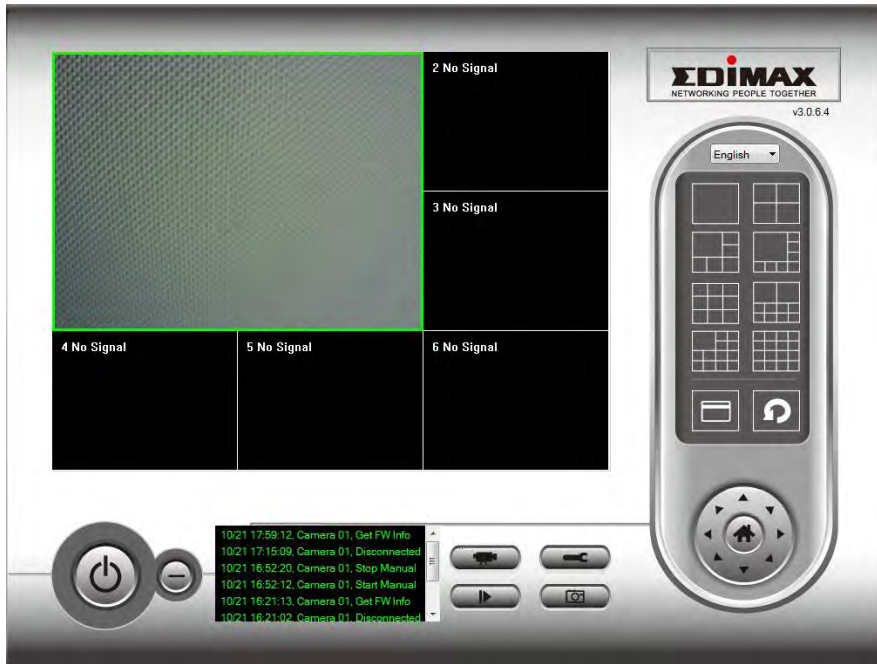

### VI-3-1-2. Scheduled Recording

You can schedule your network camera(s) to record automatically according to weekly schedules, or unique “one-time” schedules.

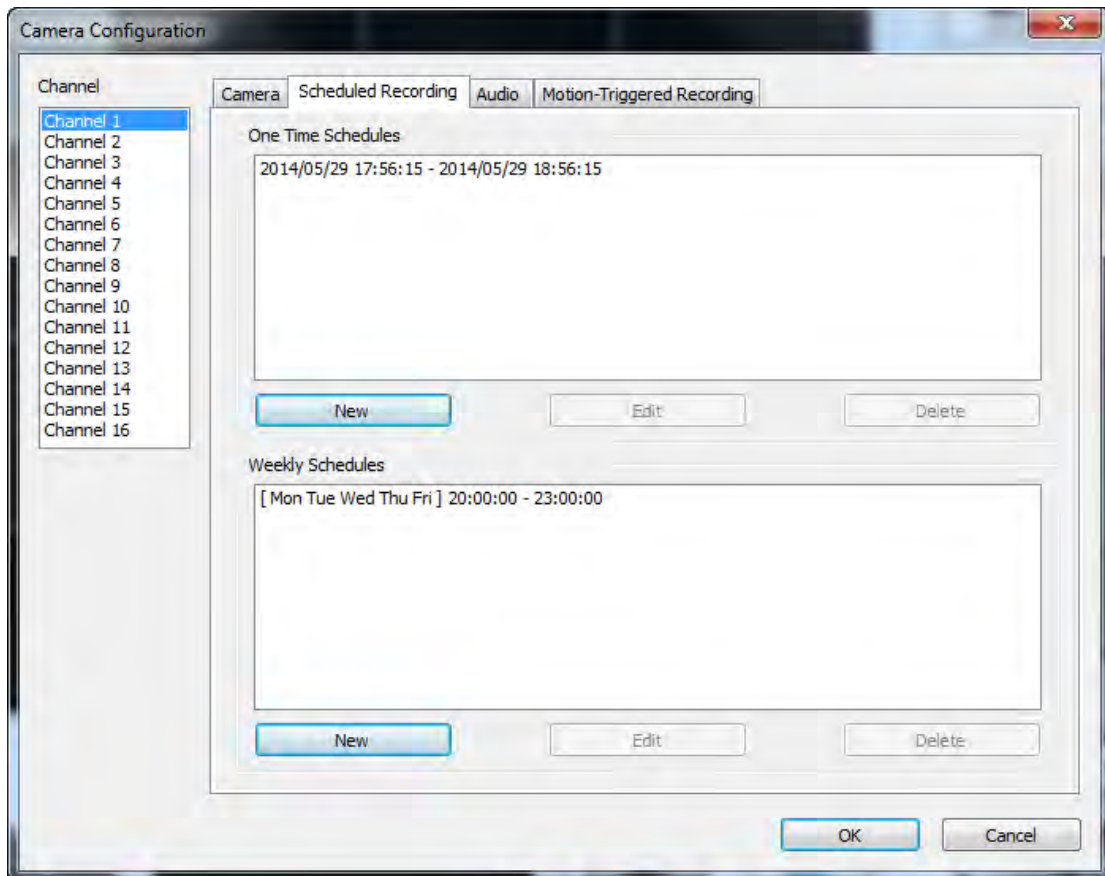

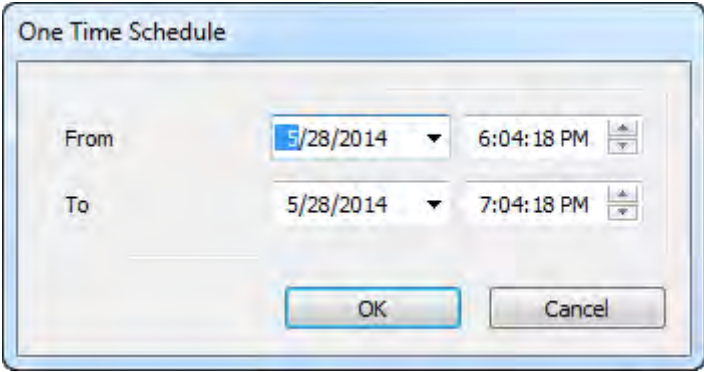
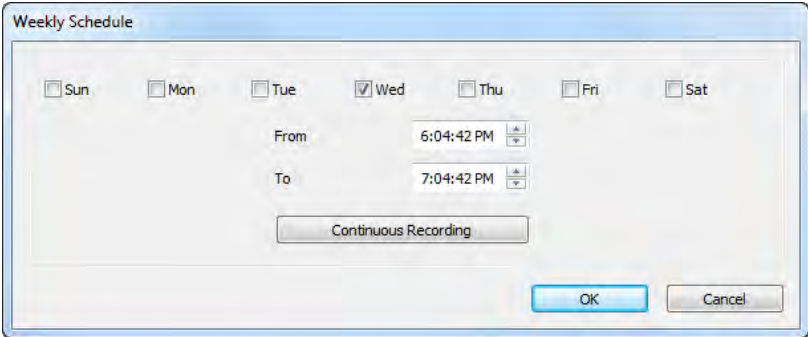

<b>Channel</b>	Select the channel number you wish to set.
<b>One Time Schedules</b>	You can specify the one-time schedule for a selected camera; this schedule will be executed once only.
<b>New (One Time Schedules)</b>	 <p>Please specify the time duration of this one-time schedule (the date and time of 'From' and 'To'), then click 'OK' to save settings.</p> <p>Please note you must set a schedule that will happen in the future, you cannot set a schedule in the past.</p>
<b>Edit</b>	You can modify a scheduled recording item. Select a schedule in 'One Time Schedules' list, and click the 'Edit' button to edit the start and end time of this schedule.
<b>Delete</b>	Delete a selected schedule item.
<b>New (Weekly Schedules)</b>	 <p>You can define a weekly recording schedule for specified times and days. Check the days to include in the schedule, and set the daily</p>

	start and finish time in the “From” and “To” fields (format HH:MM:SS). The “Continuous Recording” button will set the schedule to record everyday from 12:00:00AM to 11:59:59PM i.e. continuously.
<b>Edit</b>	You can modify a scheduled recording item. Select a schedule in the ‘One Time Schedules’ list, and click the ‘Edit’ button to edit the start and end time of this schedule.
<b>Delete</b>	Delete a selected schedule item.

### VI-3-1-3. Audio

For cameras that support audio, you can use this tab to decide if you wish to hear the audio captured by the selected camera.

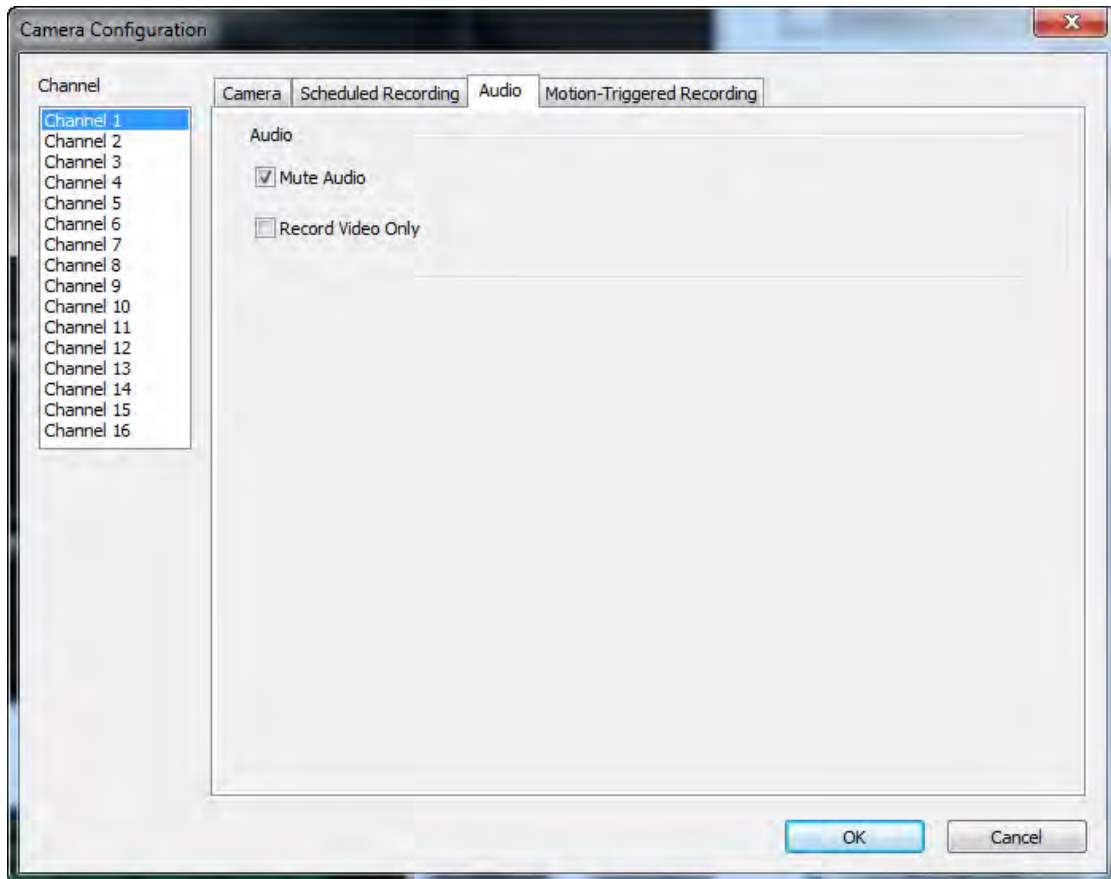

<b>Channel</b>	Select the channel number you wish to set.
<b>Mute Audio</b>	Check this box and the network camera surveillance software will not play the audio captured by this camera.
<b>Record Video Only</b>	Check this box and the network camera surveillance software will not record the audio captured by this camera.

## VI-3-1-4. Motion Recording

The network camera features a motion detection function and various options for (motion detection) events notification. On this page you can enable or disable motion detection and set the camera to send an email or trigger an alarm when motion is detected.



***Please note that when using the camera for security purposes, it is important to monitor the camera's stream even when using motion detection. Motion detection may not be 100% accurate.***

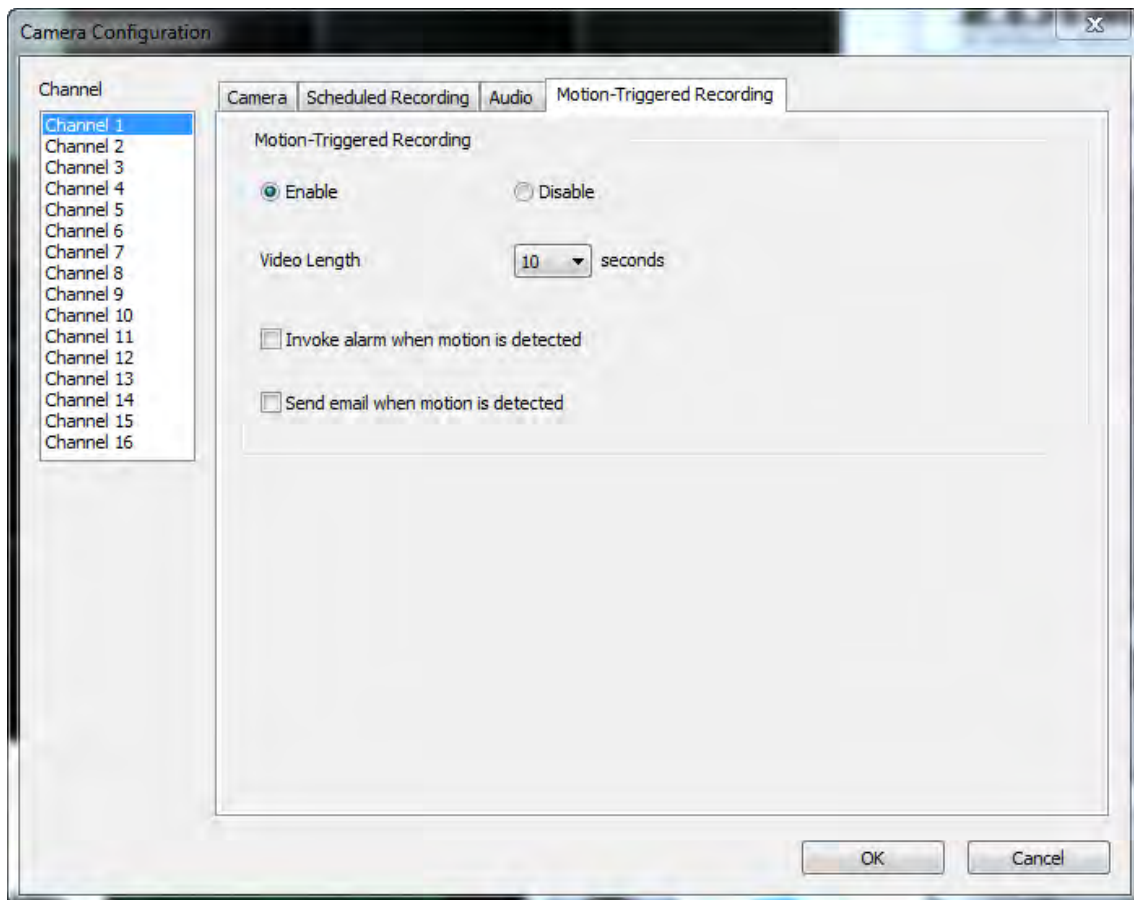

<b>Channel</b>	Select the channel number you wish to set.
<b>Enable</b>	Enable motion record function.
<b>Disable</b>	Disable motion record function.
<b>Video Length</b>	Select the time duration from the dropdown menu, in seconds, that the camera will record when a motion has been detected.
<b>Invoke alarm when motion is triggered</b>	Send an alarm when a motion has been detected by the camera.

**Send email when motion is triggered**

Send an email to a pre-defined address when a motion has been detected by the camera.

## VI-3-2. General Options

Click the wrench icon(  ) and a popup menu will appear:

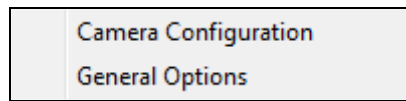

When you select “General Options”, please refer to the appropriate following chapter:

### VI-3-2-1. General

All general settings such as the file storage directory and recording spaces can be set here.

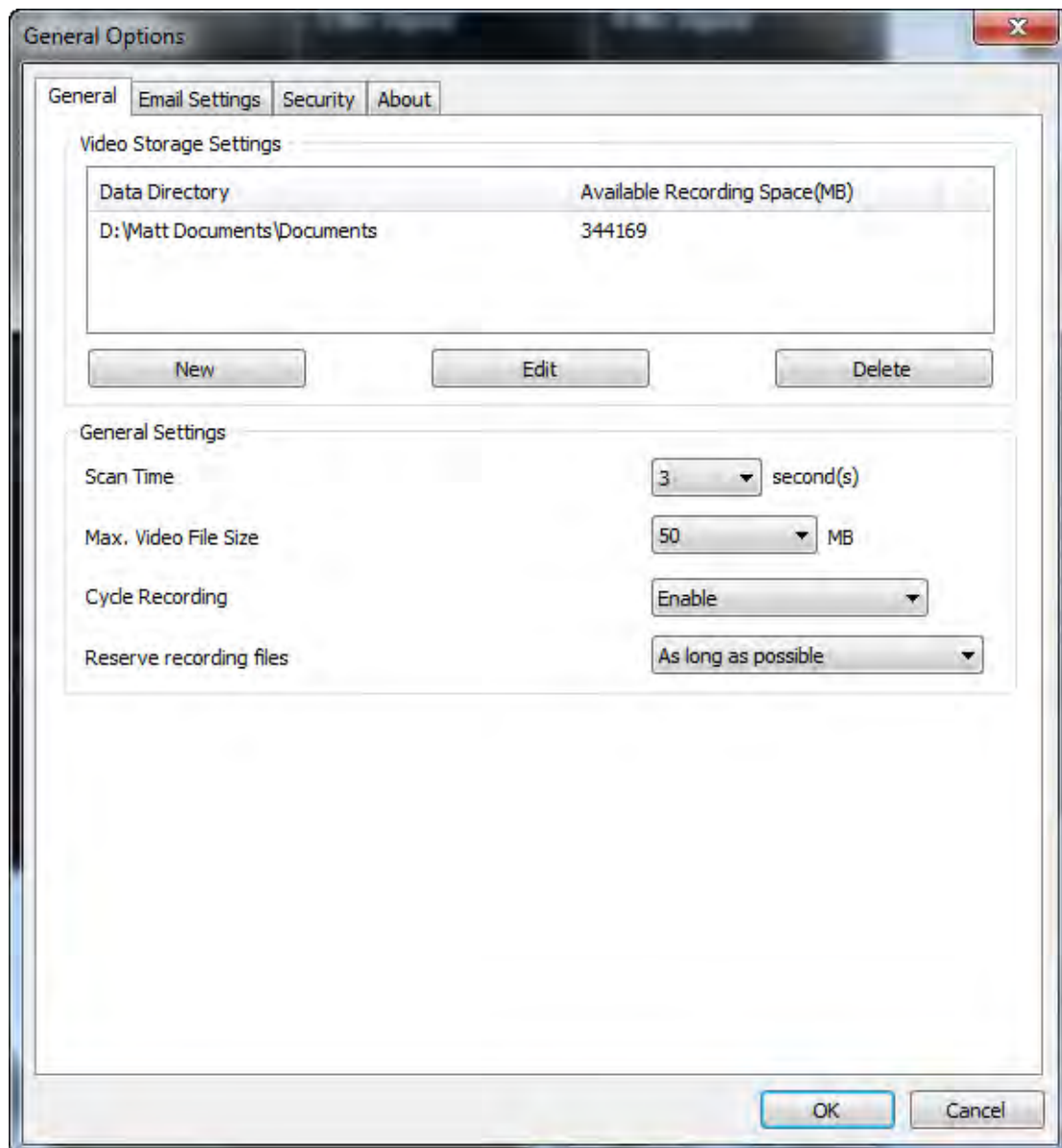

<b>Video Storage Settings</b>	Use the “New”, “Edit” and “Delete” buttons to set the directory for local video storage. Available space in the specified directory will be displayed.
<b>Scan Time</b>	Define the time period to pause between every camera switch when you activate the ‘Scan’ function.
<b>Max Video File Size</b>	Set the maximum file size of every video file. When the size of the file exceeds this value, the network camera surveillance software will open another file to record the video.
<b>Cycle Recording</b>	Enable or disable cycle recording. When enabled, cycle recording will overwrite the earliest recordings when the storage space becomes full. When disabled, recording will stop when storage is full.

## VI-3-2-2. Email Settings

If you set your network camera to send email notifications for motion detection events (see **VI-3-1-4. Motion Detection**), you need to configure your email settings here.

The screenshot shows a window titled "General Options" with a close button (X) in the top right corner. The window has four tabs: "General", "Email Settings", "Security", and "About". The "Email Settings" tab is selected. The "Email Subject" field contains a single character. The "Recipient Email Address" field is empty, with "New", "Edit", and "Delete" buttons below it. The "Sender Email Address" field is empty. The "SMTP Server" field is empty. The "SMTP Port" field contains the number "25". The "SMTP Authentication" section has two radio buttons: "Enable" (unselected) and "Disable" (selected). The "SMTP Account" field is empty. The "SMTP Password" field is empty. The "SMTP SSL/TLS" dropdown menu is set to "None". At the bottom right, there are "OK" and "Cancel" buttons.

<b>E-Mail Subject</b>	Specify the subject of the email notification you will receive.
<b>Recipient E-Mail Address</b>	Use the “New”, “Edit” and “Delete” buttons to enter the email address for the recipient(s) of the email notification.
<b>Sender E-Mail</b>	Specify the email address which will send the



<b>Address</b>	notification email.
<b>SMTP Server</b>	Specify the IP address or host name of the SMTP server for the sender email. Your ISP can provide this information if you are unsure.
<b>SMTP port</b>	Specify the port number of the SMTP server you wish to use here. The default value is 25.
<b>SMTP Authentication</b>	Enable or disable SMTP authentication. If you are unsure, check with your ISP.
<b>SMTP Account</b>	If using SMTP authentication (above), then enter the SMTP account (username) of your SMTP server here. In most cases, it's the same as your POP3 username (the one you use to receive email). Contact your ISP if you are unsure.
<b>SMTP Password</b>	Enter the SMTP password of your SMTP server here. In most cases, it's the same as your POP3 password (the one you use to receive email). Contact your ISP if you are unsure.

### VI-3-2-3. Security

You can set a password to protect the 16 channel viewer software. When enabled, the password will be required each time to open the 16 channel viewer software.

To set the password, please use the 'Security' tab in the 'General Options' menu:

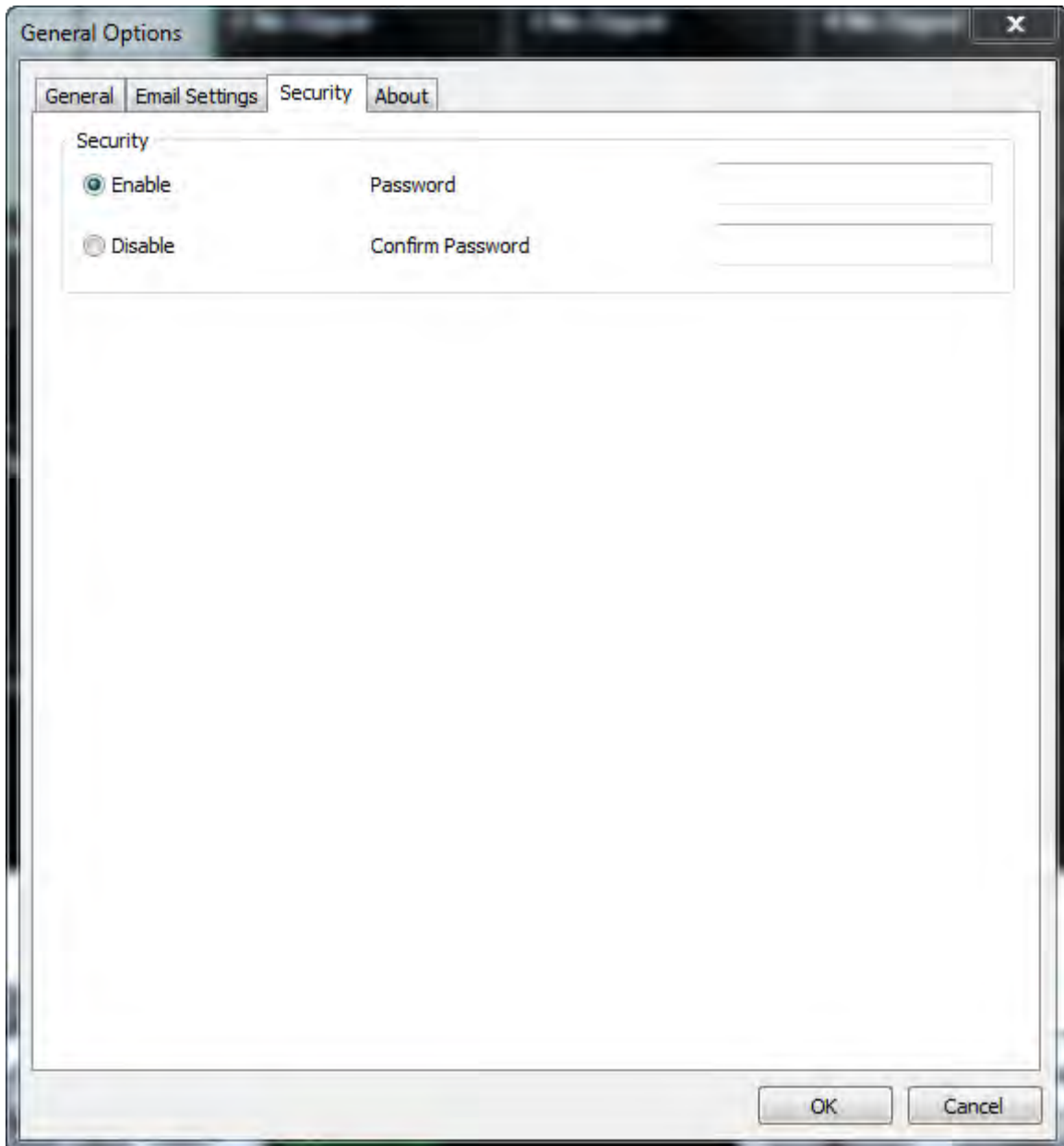

<b>Enable</b>	When enabled, the password is required to open the 16 channel viewer software.
<b>Disable</b>	No password is required when disabled.

<b>Password</b>	Enter the password you wish to use here.
<b>Confirm Password</b>	Enter the password you wish to use here again.

When you open the 16 channel viewer software, you will be prompted to enter the password:

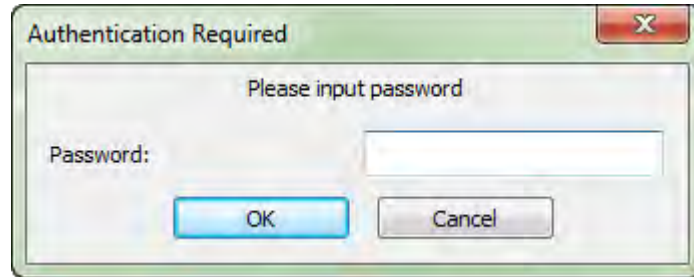

#### VI-3-2-4. About

The “About” tab displays the software version number.

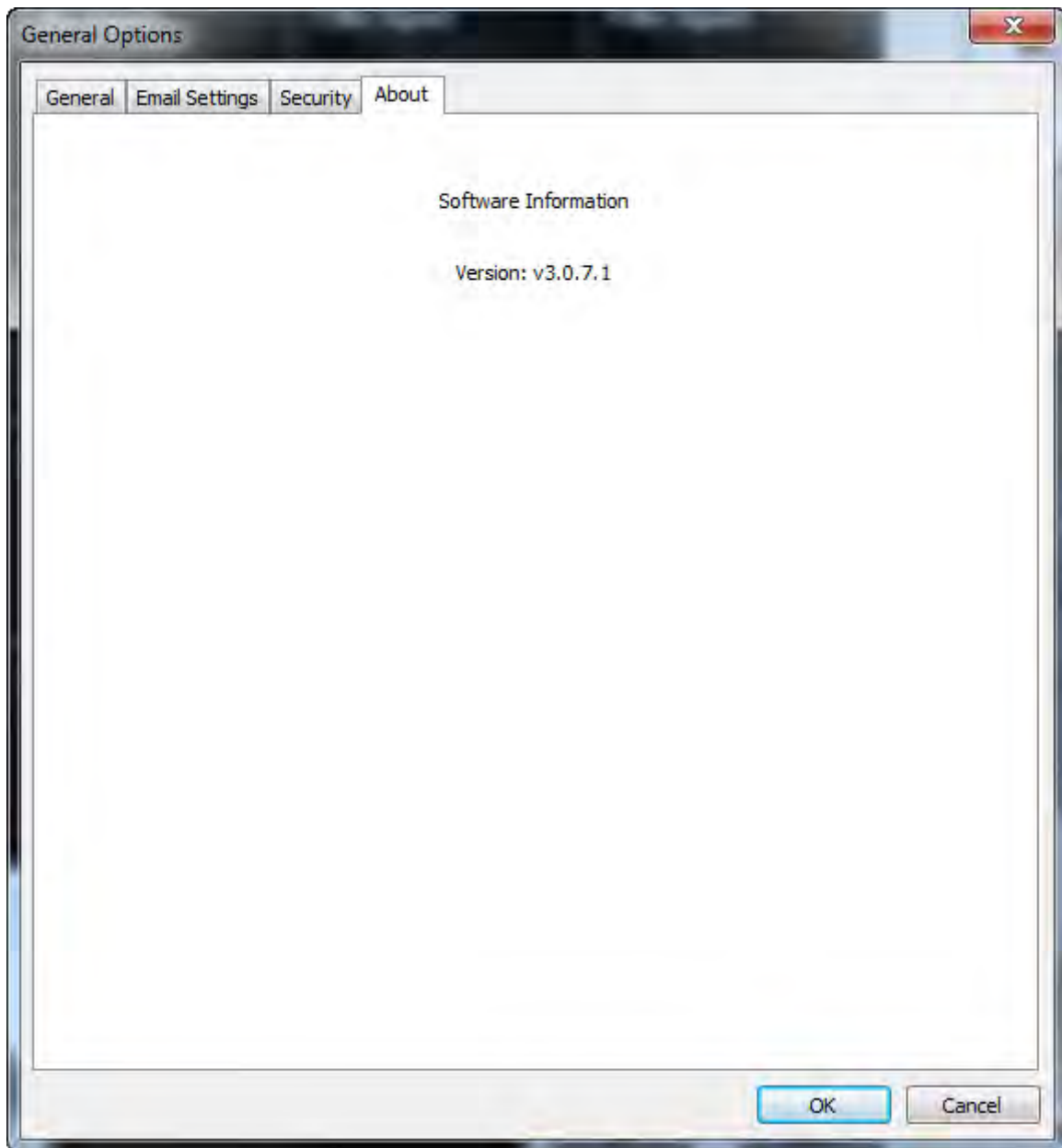





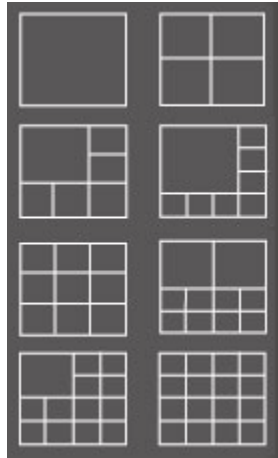

## VI-4. Changing the Display Layout

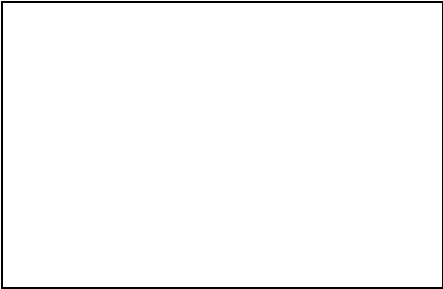
This network camera surveillance software provides eight display layouts:

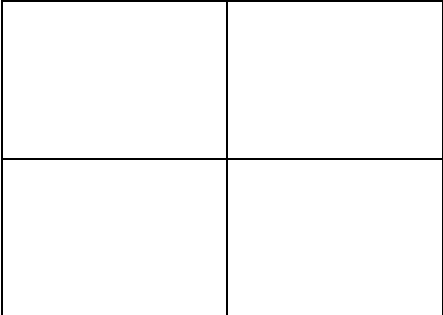

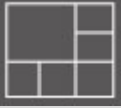
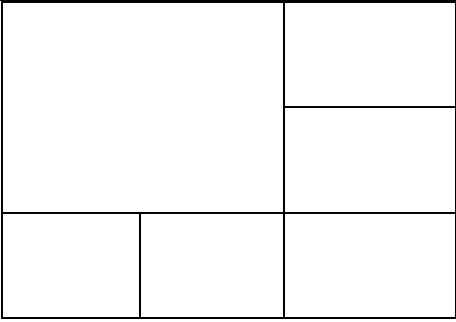
Each layout displays a different number of cameras in different arrangements. Click the icon which represents your preferred layout and the video display area will change accordingly.

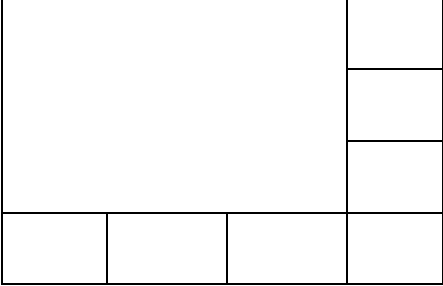
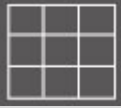
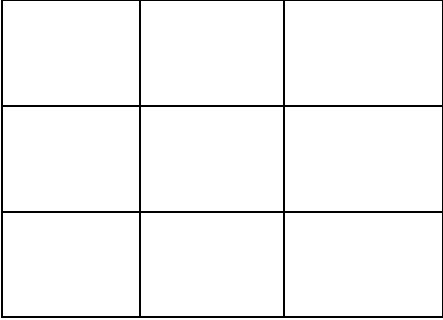
<p><b>Layout style 1: 1 Camera only</b></p> 	<p>Displays the video of 1 camera only.</p> 
<p><b>Layout style 2: 4 Cameras</b></p> 	<p>Displays the video of up to 4 cameras.</p> 
<p><b>Layout style 3: 6 Cameras</b></p>	<p>Displays the video of up to 6 cameras.</p>

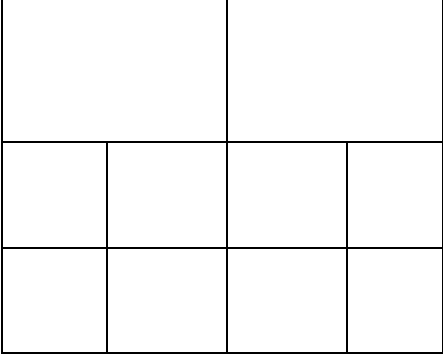
	
<p><b>Layout style 4: 8 Cameras</b></p> 	<p>Displays the video of up to 8 cameras.</p> 
<p><b>Layout style 5: 9 Cameras</b></p> 	<p>Displays the video of up to 9 cameras.</p> 
<p><b>Layout style 6: 10 Cameras</b></p> 	<p>Displays the video of up to 10 cameras.</p> 

**Layout style 7: 13  
Cameras**

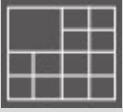

Displays the video of up to 13 cameras.

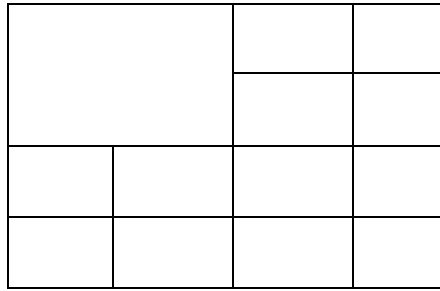

**Layout style 8: 16  
Cameras**

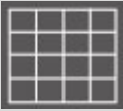

Displays the video of up to 16 cameras.

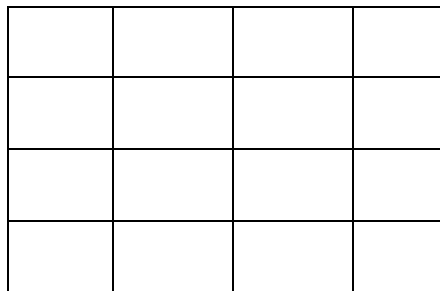

## VI-5. Full Screen Mode

Click the 'Full Screen' button to switch the display mode to full-screen mode. This uses all available space on your monitor to display the surveillance image. Press the "ESC" key to exit full-screen mode.







## VI-6. Scan

If you have more than one camera configured, the “Scan” button will switch the display between cameras.



***“Disconnected” will be displayed in the image window when a configured camera is disconnected.***





Click the ‘Scan’ button once to activate the scan function (the scan icon will become blue ) , click again to stop scanning (the scan icon will become white ) .

## VI-7. Zoom In/Out

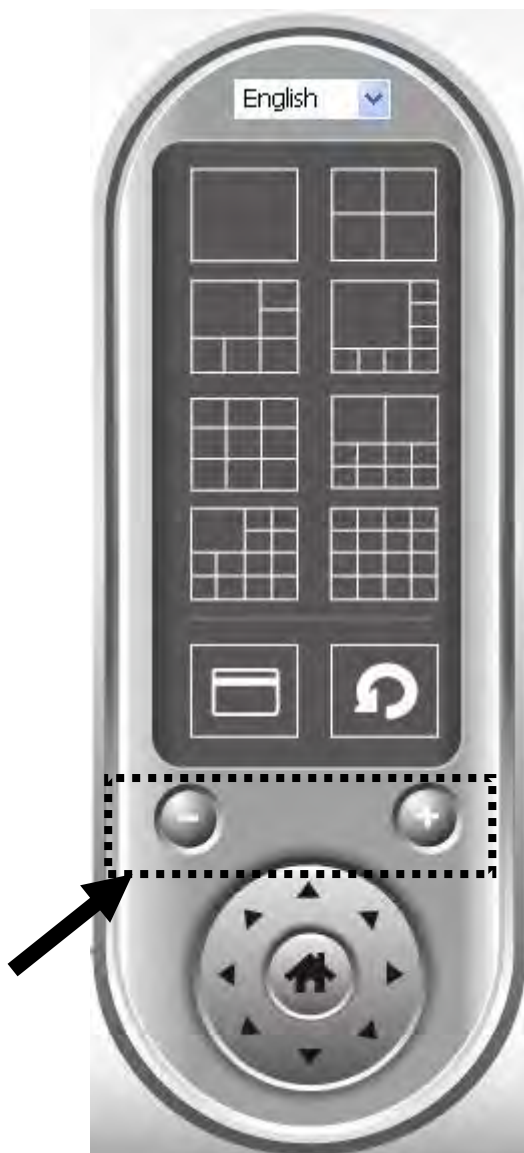
For cameras which support the zoom-in/zoom-out function, you can use this function to enlarge or reduce the image size according to your requirements e.g. to see a certain object in greater detail.



Please select a camera in the video display area by clicking on its image, then click the  button to see more objects within the camera's view, or click  to enlarge the image size of a certain object to see it in more detail (before zooming in, you may need to use the PTZ buttons - described in the next section - to find the object you wish to see in detail).

## VI-8. Pan & Tilt

For cameras which support pan & tilt functions, you can adjust the direction the network camera is facing.



Please select a camera in the video display area by clicking on its image, and then click the directions you wish the camera to move to (total 8 directions available). Click the 'Home' button (🏠) to return to the camera's home (default) position.

## VI-9. Snapshot

You can take a snapshot of a selected camera and save it to a 'Snapshot' sub-folder in a pre-defined data directory.



Click the snapshot button once to take a snapshot; you can take as many snapshots as you want until the hard disk is full.

## VI-10. Recording

You can start video recording a selected camera's image by clicking the 'Start Recording' button:



When recording starts, you'll see a message displayed in the message display box, such as '1/1 10:00:00, Camera 2 Start Manual', which means camera 2 started recording manually on 1/1 at 10:00:00.

To stop recording, click the 'Start Recording' button again, and you'll see a message displayed in the message display box such as '1/1 10:00:00, Camera 2 Stop Manual'.

## VI-11. Video Playback

You can playback all recorded video by clicking this button.



A new window will appear:

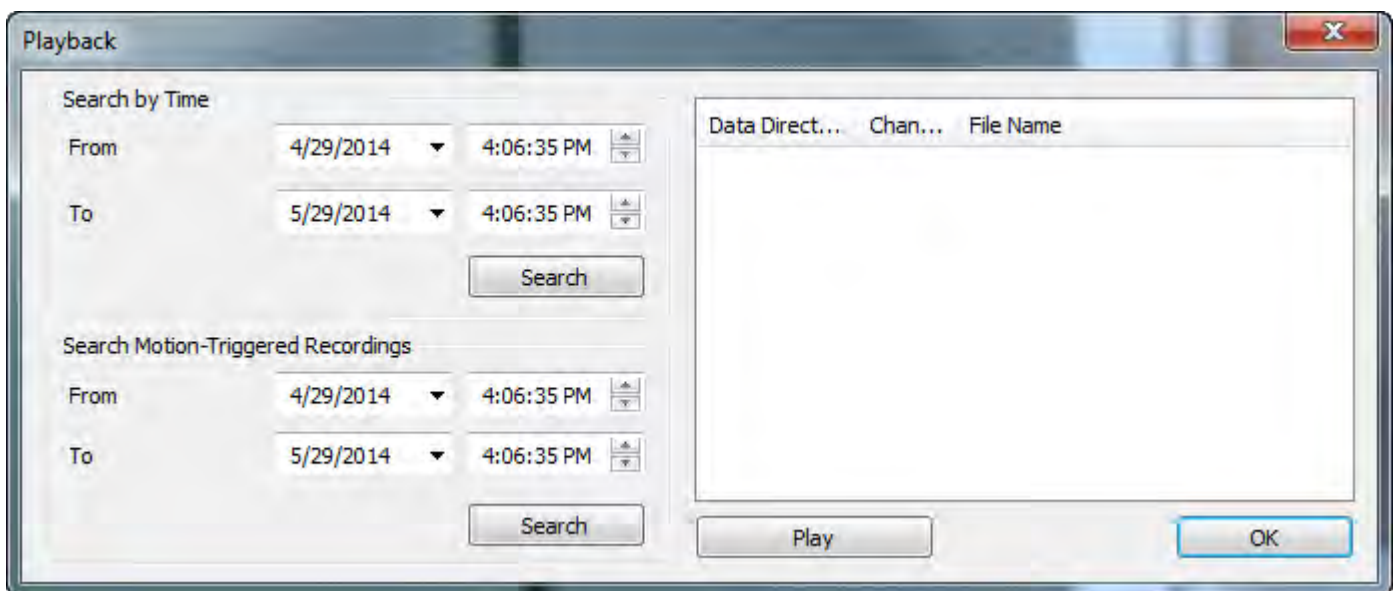

You have to search the video file before you can play it. There are two kinds of video search: Time Search (search all videos file that fall within a specific period of time) and Motion Search (search all videos recorded by the motion detection function and fall within a specific period of time).

Please define the start and end date / time of the time period you wish to search, and then click the 'Search' button (under 'Time Search' or 'Motion Search'). All found videos will be displayed, select the video you wish to play and click the 'Play' button to playback.

## Federal Communication Commission Interference Statement

This equipment has been tested and found to comply with the limits for a Class B digital device, pursuant to Part 15 of FCC Rules. These limits are designed to provide reasonable protection against harmful interference in a residential installation. This equipment generates, uses, and can radiate radio frequency energy and, if not installed and used in accordance with the instructions, may cause harmful interference to radio communications. However, there is no guarantee that interference will not occur in a particular installation. If this equipment does cause harmful interference to radio or television reception, which can be determined by turning the equipment off and on, the user is encouraged to try to correct the interference by one or more of the following measures:

1. Reorient or relocate the receiving antenna.
2. Increase the separation between the equipment and receiver.
3. Connect the equipment into an outlet on a circuit different from that to which the receiver is connected.
4. Consult the dealer or an experienced radio technician for help.

### FCC Caution

Any changes or modifications not expressly approved by the party responsible for compliance could void the authority to operate equipment.

This device complies with Part 15 of the FCC Rules. Operation is subject to the following two conditions: (1) this device may not cause harmful interference, and (2) this device must accept any interference received, including interference that may cause undesired operation.

### FCC Radiation Exposure Statement:

This equipment complies with FCC radiation exposure limits set forth for an uncontrolled environment. This equipment should be installed and operated with minimum distance 20cm between the radiator & your body. For product available in the USA/Canada market, only channel 1~11 can be operated. Selection of other channels is not possible. This device and its antenna(s) must not be co-located or operating in conjunction with any other antenna or transmitter.

### R&TTE Compliance Statement

This equipment complies with all the requirements of DIRECTIVE 1999/5/EC OF THE EUROPEAN PARLIAMENT AND THE COUNCIL of March 9, 1999 on radio equipment and telecommunication terminal equipment and the mutual recognition of their conformity (R&TTE). The R&TTE Directive repeals and replaces in the directive 98/13/EEC (Telecommunications Terminal Equipment and Satellite Earth Station Equipment) As of April 8, 2000.

### Safety

This equipment is designed with the utmost care for the safety of those who install and use it. However, special attention must be paid to the dangers of electric shock and static electricity when working with electrical equipment. All guidelines of this and of the computer manufacture must therefore be allowed at all times to ensure the safe use of the equipment.

### EU Countries Intended for Use

The ETSI version of this device is intended for home and office use in Austria, Belgium, Bulgaria, Cyprus, Czech, Denmark, Estonia, Finland, France, Germany, Greece, Hungary, Ireland, Italy, Latvia, Lithuania, Luxembourg, Malta, Netherlands, Poland, Portugal, Romania, Slovakia, Slovenia, Spain, Sweden, Turkey, and United Kingdom. The ETSI version of this device is also authorized for use in EFTA member states: Iceland, Liechtenstein, Norway, and Switzerland.

### EU Countries Not Intended for Use

None

## EU Declaration of Conformity

- English:** This equipment is in compliance with the essential requirements and other relevant provisions of Directive 1995/95/EC, 2011/65/EC.
- Français:** Cet équipement est conforme aux exigences essentielles et autres dispositions de la directive 1995/95/CE, 2011/65/CE.
- Čeština:** Toto zařízení je v souladu se základními požadavky a ostatními příslušnými ustanoveními směrnic 1995/95/ES, 2011/65/ES.
- Polski:** Urządzenie jest zgodne z ogólnymi wymaganiami oraz szczególnymi warunkami określonymi Dyrektywą UE 1995/95/EC, 2011/65/EC..
- Română:** Acest echipament este în conformitate cu cerințele esențiale și alte prevederi relevante ale Directivei 1995/95/CE, 2011/65/CE.
- Русский:** Это оборудование соответствует основным требованиям и положениям Директивы 1995/95/EC, 2011/65/EC.
- Magyar:** Ez a berendezés megfelel az alapvető követelményeknek és más vonatkozó irányelveknek (1995/95/EK, 2011/65/EK).
- Türkçe:** Bu cihaz 1995/95/EC, 2011/65/EC direktifleri zorunlu istekler ve diğer hükümlerle ile uyumludur.
- Українська:** Обладнання відповідає вимогам і умовам директиви 1995/95/EC, 2011/65/EC.
- Slovenčina:** Toto zariadenie spĺňa základné požiadavky a ďalšie príslušné ustanovenia smerníc 1995/95/ES, 2011/65/ES.
- Deutsch:** Dieses Gerät erfüllt die Voraussetzungen gemäß den Richtlinien 1995/95/EC, 2011/65/EC.
- Español:** El presente equipo cumple los requisitos esenciales de la Directiva 1995/95/EC, 2011/65/EC.
- Italiano:** Questo apparecchio è conforme ai requisiti essenziali e alle altre disposizioni applicabili della Direttiva 1995/95/CE, 2011/65/CE.
- Nederlands:** Dit apparaat voldoet aan de essentiële eisen en andere van toepassing zijnde bepalingen van richtlijn 1995/95/EC, 2011/65/EC..
- Português:** Este equipamento cumpre os requisitos essenciais da Directiva 1995/95/EC, 2011/65/EC.
- Norsk:** Dette utstyret er i samsvar med de viktigste kravene og andre relevante regler i Direktiv 1995/95/EC, 2011/65/EC.
- Svenska:** Denna utrustning är i överensstämmelse med de väsentliga kraven och övriga relevanta bestämmelser i direktiv 1995/95/EG, 2011/65/EG.
- Dansk:** Dette udstyr er i overensstemmelse med de væsentligste krav og andre relevante forordninger i direktiv 1995/95/EC, 2011/65/EC.
- suomen kieli:** Tämä laite täyttää direktiivien 1995/95/EY, 2011/65/EY oleelliset vaatimukset ja muut asiaankuuluvat määräykset.

FOR USE IN 



---

### WEEE Directive & Product Disposal



At the end of its serviceable life, this product should not be treated as household or general waste. It should be handed over to the applicable collection point for the recycling of electrical and electronic equipment, or returned to the supplier for disposal.



## Declaration of Conformity

We, Edimax Technology Co., Ltd., declare under our sole responsibility, that the equipment described below complies with the requirements of the European R&TTE directive (1999/5/EC, 2006/95/EC) .

**Equipment:** 720p Wireless Day & Night PT Network Camera  
**Model No.:** IC-7113W

The following European standards for essential requirements have been followed:

**Spectrum:** ETSI EN 300 328 V1.8.1 (2012-06)  
**EMC:** EN 301 489-1 V1.9.2 (2011-09);  
EN 301 489-17 V2.2.1 (2012-09)  
**EMF:** EN 62311:2008  
**Safety (LVD):** IEC 60950-1:2005 (2nd Edition);Am1:2009  
EN-60950-1:2006+A11:2009+A1:2010+A12:2011

Edimax Technology Europe B.V.  
Nijverheidsweg 25,  
5683 CJ BEST  
THE NETHERLANDS

a company of :  
Edimax Technology Co., Ltd.,  
No. 3, Wu Chuan 3<sup>rd</sup> Road,  
Wu-Ku Industrial Park,  
New Taipei City, Taiwan

Signature:

Printed Name: Vivian Ma  
Title: Director  
Edimax Technology Europe B.V.

Date of Signature: Dec. 30, 2014

Signature:



Printed Name: Albert Chang

Title:

Director

Edimax Technology Co., Ltd.



## Notice According to GNU General Public License Version 2

This product includes software that is subject to the GNU General Public License version 2. The program is free software and distributed without any warranty of the author. We offer, valid for at least three years, to give you, for a charge no more than the costs of physically performing source distribution, a complete machine-readable copy of the corresponding source code.

Das Produkt beinhaltet Software, die den Bedingungen der GNU/GPL-Version 2 unterliegt. Das Programm ist eine sog. „Free Software“, der Autor stellt das Programm ohne irgendeine Gewährleistungen zur Verfügung. Wir bieten Ihnen für einen Zeitraum von drei Jahren an, eine vollständige maschinenlesbare Kopie des Quelltextes der Programme zur Verfügung zu stellen – zu nicht höheren Kosten als denen, die durch den physikalischen Kopiervorgang anfallen.

### GNU GENERAL PUBLIC LICENSE

Version 2, June 1991

Copyright (C) 1989, 1991 Free Software Foundation, Inc. 51 Franklin Street, Fifth Floor, Boston, MA 02110-1301, USA  
Everyone is permitted to copy and distribute verbatim copies of this license document, but changing it is not allowed.

### Preamble

The licenses for most software are designed to take away your freedom to share and change it. By contrast, the GNU General Public License is intended to guarantee your freedom to share and change free software--to make sure the software is free for all its users. This General Public License applies to most of the Free Software Foundation's software and to any other program whose authors commit to using it. (Some other Free Software Foundation software is covered by the GNU Lesser General Public License instead.) You can apply it to your programs, too.

When we speak of free software, we are referring to freedom, not price. Our General Public Licenses are designed to make sure that you have the freedom to distribute copies of free software (and charge for this service if you wish), that you receive source code or can get it if you want it, that you can change the software or use pieces of it in new free programs; and that you know you can do these things.

To protect your rights, we need to make restrictions that forbid anyone to deny you these rights or to ask you to surrender the rights. These restrictions translate to certain responsibilities for you if you distribute copies of the software, or if you modify it.

For example, if you distribute copies of such a program, whether gratis or for a fee, you must give the recipients all the rights that you have. You must make sure that they, too, receive or can get the source code. And you must show them these terms so they know their rights.

We protect your rights with two steps: (1) copyright the software, and (2) offer you this license which gives you legal permission to copy, distribute and/or modify the software.

Also, for each author's protection and ours, we want to make certain that everyone understands that there is no warranty for this free software. If the software is modified by someone else and passed on, we want its recipients to know that what they have is not the original, so that any problems introduced by others will not reflect on the original authors' reputations.

Finally, any free program is threatened constantly by software patents. We wish to avoid the danger that redistributors of a free program will individually obtain patent licenses, in effect making the program proprietary. To prevent this, we have made it clear that any patent must be licensed for everyone's free use or not licensed at all.

The precise terms and conditions for copying, distribution and modification follow.

### TERMS AND CONDITIONS FOR COPYING, DISTRIBUTION AND MODIFICATION

0. This License applies to any program or other work which contains a notice placed by the copyright holder saying it may be distributed under the terms of this General Public License. The "Program", below, refers to any such program or work, and a "work based on the Program" means either the Program or any derivative work under copyright law: that is to say, a work containing the Program or a portion of it, either verbatim or with modifications and/or translated into another language. (Hereinafter, translation is included without limitation in the term "modification".) Each licensee is addressed as "you".

Activities other than copying, distribution and modification are not covered by this License; they are outside its scope. The act of running the Program is not restricted, and the output from the Program is covered only if its contents constitute a work based on the Program (independent of having been made by running the Program). Whether that is true depends on what the Program does.

1. You may copy and distribute verbatim copies of the Program's source code as you receive it, in any medium, provided that you conspicuously and appropriately publish on each copy an appropriate copyright notice and disclaimer of warranty; keep intact all the notices that refer to this License and to the absence of any warranty; and give any other recipients of the Program a copy of this License along with the Program.

You may charge a fee for the physical act of transferring a copy, and you may at your option offer warranty protection in exchange for a fee.

2. You may modify your copy or copies of the Program or any portion of it, thus forming a work based on the Program, and copy and distribute such modifications or work under the terms of Section 1 above, provided that you also meet all of these conditions:

- a) You must cause the modified files to carry prominent notices stating that you changed the files and the date of any change.
- b) You must cause any work that you distribute or publish, that in whole or in part contains or is derived from the Program or any part thereof, to be licensed as a whole at no charge to all third parties under the terms of this License.
- c) If the modified program normally reads commands interactively when run, you must cause it, when started running for such interactive use in the most ordinary way, to print or display an announcement including an appropriate copyright notice and a notice that there is no warranty (or else, saying that you provide a warranty) and that users may redistribute the program under these conditions, and telling the user how to view a copy of this License. (Exception: if the Program itself is interactive but does not normally print such an announcement, your work based on the Program is not required to print an announcement.)

These requirements apply to the modified work as a whole. If identifiable sections of that work are not derived from the Program, and can be reasonably considered independent and separate works in themselves, then this License, and its terms, do not apply to those sections when you distribute them as separate works. But when you distribute the same sections as part of a whole which is a work based on the Program, the distribution of the whole must be on the terms of this License, whose permissions for other licensees extend to the entire whole, and thus to each and every part regardless of who wrote it.

Thus, it is not the intent of this section to claim rights or contest your rights to work written entirely by you; rather, the intent is to exercise the right to control the distribution of derivative or collective works based on the Program.

In addition, mere aggregation of another work not based on the Program with the Program (or with a work based on the Program) on a volume of a storage or distribution medium does not bring the other work under the scope of this License.

3. You may copy and distribute the Program (or a work based on it, under Section 2) in object code or executable form under the terms of Sections 1 and 2 above provided that you also do one of the following:

- a) Accompany it with the complete corresponding machine-readable source code, which must be distributed under the terms of Sections 1 and 2 above on a medium customarily used for software interchange; or,
- b) Accompany it with a written offer, valid for at least three years, to give any third party, for a charge no more than your cost of physically performing source distribution, a complete machine-readable copy of the corresponding source code, to be distributed under the terms of Sections 1 and 2 above on a medium customarily used for software interchange; or,
- c) Accompany it with the information you received as to the offer to distribute corresponding source code. (This alternative is allowed only for noncommercial distribution and only if you received the program in object code or executable form with such an offer, in accord with Subsection b above.)

The source code for a work means the preferred form of the work for making modifications to it. For an executable work, complete source code means all the source code for all modules it contains, plus any associated interface definition files, plus the scripts used to control compilation and installation of the executable. However, as a special exception, the source code distributed need not include anything that is normally distributed (in either source or binary form) with the major components (compiler, kernel, and so on) of the operating system on which the executable runs, unless that component itself accompanies the executable.

If distribution of executable or object code is made by offering access to copy from a designated place, then offering equivalent access to copy the source code from the same place counts as distribution of the source code, even though third parties are not compelled to copy the source along with the object code.

4. You may not copy, modify, sublicense, or distribute the Program except as expressly provided under this License. Any attempt otherwise to copy, modify, sublicense or distribute the Program is void, and will automatically terminate your rights under this License. However, parties who have received copies, or rights, from you under this License will not have their licenses terminated so long as such parties remain in full compliance.

5. You are not required to accept this License, since you have not signed it. However, nothing else grants you permission to modify or distribute the Program or its derivative works. These actions are prohibited by law if you do not accept this License.

Therefore, by modifying or distributing the Program (or any work based on the Program), you indicate your acceptance of this License to do so, and all its terms and conditions for copying, distributing or modifying the Program or works based on it.

6. Each time you redistribute the Program (or any work based on the Program), the recipient automatically receives a license from the original licensor to copy, distribute or modify the Program subject to these terms and conditions. You may not impose any further restrictions on the recipients' exercise of the rights granted herein. You are not responsible for enforcing compliance by third parties to this License.

7. If, as a consequence of a court judgment or allegation of patent infringement or for any other reason (not limited to patent issues), conditions are imposed on you (whether by court order, agreement or otherwise) that contradict the conditions of this License, they do not excuse you from the conditions of this License. If you cannot distribute so as to satisfy simultaneously your obligations under this License and any other pertinent obligations, then as a consequence you may not distribute the Program at all. For example, if a patent license would not permit royalty-free redistribution of the Program by all those who receive copies directly or indirectly through you, then the only way you could satisfy both it and this License would be to refrain entirely from distribution of the Program.

If any portion of this section is held invalid or unenforceable under any particular circumstance, the balance of the section is intended to apply and the section as a whole is intended to apply in other circumstances.

It is not the purpose of this section to induce you to infringe any patents or other property right claims or to contest validity of any such claims; this section has the sole purpose of protecting the integrity of the free software distribution system, which is implemented by public license practices. Many people have made generous contributions to the wide range of software distributed through that system in reliance on consistent application of that system; it is up to the author/donor to decide if he or she is willing to distribute software through any other system and a licensee cannot impose that choice.

This section is intended to make thoroughly clear what is believed to be a consequence of the rest of this License.

8. If the distribution and/or use of the Program is restricted in certain countries either by patents or by copyrighted interfaces, the original copyright holder who places the Program under this License may add an explicit geographical distribution limitation excluding those countries, so that distribution is permitted only in or among countries not thus excluded. In such case, this License incorporates the limitation as if written in the body of this License.

9. The Free Software Foundation may publish revised and/or new versions of the General Public License from time to time. Such new versions will be similar in spirit to the present version, but may differ in detail to address new problems or concerns.

Each version is given a distinguishing version number. If the Program specifies a version number of this License which applies to it and "any later version", you have the option of following the terms and conditions either of that version or of any later version published by the Free Software Foundation. If the Program does not specify a version number of this License, you may choose any version ever published by the Free Software Foundation.

10. If you wish to incorporate parts of the Program into other free programs whose distribution conditions are different, write to the author to ask for permission. For software which is copyrighted by the Free Software Foundation, write to the Free Software Foundation; we sometimes make exceptions for this. Our decision will be guided by the two goals of preserving the free status of all derivatives of our free software and of promoting the sharing and reuse of software generally.

#### **NO WARRANTY**

11. BECAUSE THE PROGRAM IS LICENSED FREE OF CHARGE, THERE IS NO WARRANTY FOR THE PROGRAM, TO THE EXTENT PERMITTED BY APPLICABLE LAW. EXCEPT WHEN OTHERWISE STATED IN WRITING THE COPYRIGHT HOLDERS AND/OR OTHER PARTIES PROVIDE THE PROGRAM "AS IS" WITHOUT WARRANTY OF ANY KIND, EITHER EXPRESSED OR IMPLIED, INCLUDING, BUT NOT LIMITED TO, THE IMPLIED WARRANTIES OF MERCHANTABILITY AND FITNESS FOR A PARTICULAR PURPOSE. THE ENTIRE RISK AS TO THE QUALITY AND PERFORMANCE OF THE PROGRAM IS WITH YOU. SHOULD THE PROGRAM PROVE DEFECTIVE, YOU ASSUME THE COST OF ALL NECESSARY SERVICING, REPAIR OR CORRECTION.

12. IN NO EVENT UNLESS REQUIRED BY APPLICABLE LAW OR AGREED TO IN WRITING WILL ANY COPYRIGHT HOLDER, OR ANY OTHER PARTY WHO MAY MODIFY AND/OR REDISTRIBUTE THE PROGRAM AS PERMITTED ABOVE, BE LIABLE TO YOU FOR DAMAGES, INCLUDING ANY GENERAL, SPECIAL, INCIDENTAL OR CONSEQUENTIAL DAMAGES ARISING OUT OF THE USE OR INABILITY TO USE THE PROGRAM (INCLUDING BUT NOT LIMITED TO LOSS OF DATA OR DATA BEING RENDERED INACCURATE OR LOSSES SUSTAINED BY YOU OR THIRD PARTIES OR A FAILURE OF THE PROGRAM TO OPERATE WITH ANY OTHER PROGRAMS), EVEN IF SUCH HOLDER OR OTHER PARTY HAS BEEN ADVISED OF THE POSSIBILITY OF SUCH DAMAGES.



**ΣDIMAX**  
NETWORKING PEOPLE TOGETHER