

# *300N Wireless LAN Repeater*

## *User Manual*

**Version: 1.0**  
**(October, 2011)**

# COPYRIGHT

Copyright ©2011/2012 by this company. All rights reserved. No part of this publication may be reproduced, transmitted, transcribed, stored in a retrieval system, or translated into any language or computer language, in any form or by any means, electronic, mechanical, magnetic, optical, chemical, manual or otherwise, without the prior written permission of this company

This company makes no representations or warranties, either expressed or implied, with respect to the contents hereof and specifically disclaims any warranties, merchantability or fitness for any particular purpose. Any software described in this manual is sold or licensed "as is". Should the programs prove defective following their purchase, the buyer (and not this company, its distributor, or its dealer) assumes the entire cost of all necessary servicing, repair, and any incidental or consequential damages resulting from any defect in the software. Further, this company reserves the right to revise this publication and to make changes from time to time in the contents thereof without obligation to notify any person of such revision or changes.

# Federal Communication Commission Interference Statement

## FCC Part 15

This equipment has been tested and found to comply with the limits for a Class B digital device, pursuant to Part 15 of FCC Rules. These limits are designed to provide reasonable protection against harmful interference in a residential installation. This equipment generates, uses, and can radiate radio frequency energy and, if not installed and used in accordance with the instructions, may cause harmful interference to radio communications. However, there is no guarantee that interference will not occur in a particular installation. If this equipment does cause harmful interference to radio or television reception, which can be determined by turning the equipment off and on, the user is encouraged to try to correct the interference by one or more of the following measures:

1. Reorient or relocate the receiving antenna.
2. Increase the separation between the equipment and receiver.
3. Connect the equipment into an outlet on a circuit different from that to which the receiver is connected.
4. Consult the dealer or an experienced radio technician for help.

## FCC Caution

This equipment must be installed and operated in accordance with provided instructions and a minimum 20 cm spacing must be provided between computer mounted antenna and person's body (excluding extremities of hands, wrist and feet) during wireless modes of operation.

This device complies with Part 15 of the FCC Rules. Operation is subject to the following two conditions: (1) this device may not cause harmful interference, and (2) this device must accept any interference received, including interference that may cause undesired operation.

Any changes or modifications not expressly approved by the party responsible for compliance could void the authority to operate equipment.

## **Federal Communication Commission (FCC) Radiation Exposure Statement**

This equipment complies with FCC radiation exposure limits set forth for an uncontrolled environment. In order to avoid the possibility of exceeding the FCC radio frequency exposure limits, human proximity to the antenna shall not be less than 20cm (8 inches) during normal operation.

The antenna(s) used for this transmitter must not be co-located or operating in conjunction with any other antenna or transmitter.

The equipment version marketed in US is restricted to usage of the channels 1-11 only.

# **R&TTE Compliance Statement**

This equipment complies with all the requirements of DIRECTIVE 1999/5/EC OF THE EUROPEAN PARLIAMENT AND THE COUNCIL of March 9, 1999 on radio equipment and telecommunication terminal Equipment and the mutual recognition of their conformity (R&TTE).

The R&TTE Directive repeals and replaces in the directive 98/13/EEC (Telecommunications Terminal Equipment and Satellite Earth Station Equipment) As of April 8, 2000.

## **Safety**

This equipment is designed with the utmost care for the safety of those who install and use it. However, special attention must be paid to the dangers of electric shock and static electricity when working with electrical equipment. All guidelines of this and of the computer manufacture must therefore be allowed at all times to ensure the safe use of the equipment.

## **EU Countries Intended for Use**

The ETSI version of this device is intended for home and office use in Austria, Belgium, Denmark, Finland, France, Germany, Greece, Ireland, Italy, Luxembourg, the Netherlands, Portugal, Spain, Sweden, and the United Kingdom.

The ETSI version of this device is also authorized for use in EFTA member states: Iceland, Liechtenstein, Norway, and Switzerland.

## **EU Countries Not intended for use**

None.

# CATALOG

<b>Chapter I: Product Information .....</b>	<b>1</b>
1-1 Introduction and safety information .....	1
1-2 Safety Information .....	2
1-3 System Requirements .....	3
1-4 Package Contents.....	4
1-5 Familiar with your new wireless repeater.....	5
<b>CHAPTER II: Repeater mode.....</b>	<b>8</b>
2-1 Repeater mode Quick Installation Guide.....	8
2-1-1 Hardware WPS button setup .....	10
2-1-2 Web browser quick setup .....	13
2-2 Repeater mode Advanced Settings .....	17
2-2-1 Setup IP address .....	17
<i>Windows XP IP address setup:</i> .....	17
<i>Windows Vista/7 IP address setup:</i> .....	18
2-2-2 Connect to web configuration menu .....	20
2-2-3 Home .....	22
2-2-4 WPS Setting .....	24
2-2-5 Advanced Settings.....	27
2-2-6 MAC Address Filtering.....	31
2-2-7 System Utility .....	38
<b>CHAPTER III: Client mode .....</b>	<b>44</b>
3-1 Client mode Quick Installation Guide .....	44
3-1-1 Hardware WPS button setup .....	46
3-1-2 Web browser quick setup .....	49
3-2 Client mode Advanced Settings.....	52
3-2-1 Setup IP address .....	52
<i>Windows XP IP address setup:</i> .....	52
<i>Windows Vista/7 IP address setup:</i> .....	53
3-2-2 Connect to web configuration menu .....	55
3-2-3 Home .....	56
3-2-4 WPS Setting .....	57
3-2-5 Advanced Settings.....	60
3-2-6 System Utility .....	63
<b>CHAPTER IX: AP mode.....</b>	<b>69</b>
4-1 AP mode Quick Installation Guide .....	69

4-1-1 Hardware WPS button setup .....	71
4-1-2 Web browser quick setup .....	73
4-2 AP mode Advanced Settings.....	77
4-2-1 Setup IP address .....	77
<i>Windows XP IP address setup:</i> .....	77
<i>Windows Vista/7 IP address setup:</i> .....	78
4-2-2 Connect to web configuration menu .....	80
4-2-3 Home .....	81
4-2-4 WPS Setting .....	83
4-2-5 Advanced Settings.....	86
4-2-6 MAC Address Filtering.....	90
4-2-7 System Utility .....	97
<b>Chapter X: Appendix.....</b>	<b>105</b>
5-1 Configuring TCP/IP on PC.....	105
5-2 Specification .....	109
5-3 Glossary .....	110

## **Chapter I: Product Information**

### 1-1 Introduction and safety information

Thank you for purchasing this mini 802.11b/g/n wireless repeater! The ultra-compact design with power built-in allows you to install this repeater everywhere, and still providing excellent network performance to extend the Wi-Fi signal and wireless coverage.

*Other features of this wireless repeater including:*

- Extend the wireless signal inside your home or office.
- Ultra-compact design while maintaining excellent network performance.
- LED signal indicator to easily realize the best location placement to extend WiFi signal and secure better wireless performance.
- The device can support Repeater mode, AP mode and AP client mode
- Hardware switch button for user to change operation mode quickly without logging into web firmware.
- WPS (Wi-Fi Protected Setup) hardware button for easy installation and secure wireless security.



## **1-2 Safety Information**

In order to keep the safety of users and your properties, please follow the following safety instructions:

1. This wireless repeater is designed for indoor use only. **DO NOT** expose this device to direct sun light, rain, or snow.
2. **DO NOT** put this at or near hot or humid places, like kitchen or bathroom. Also, do not left this Wireless repeater in the car in summer.
3. Do not allow kids to put any small parts of this wireless repeater in their mouth, and it could cause serious injury or could be fatal. If they throw this wireless repeater, it will be damaged. **PLEASE KEEP THIS WIRELESS REPEATER OUT THE REACH OF CHILDREN!**
4. This Wireless repeater will become hot when being used for long time (***This is normal and is not a malfunction***). **DO NOT** put the Wireless repeater on a paper, cloth, or other flammable objects after the Wireless repeater has been used for a long time.
5. There's no user-serviceable part inside the Wireless repeater. If you found that the Wireless repeater is not working properly, please contact your dealer of purchase and ask for help. **DO NOT** disassemble the Wireless repeater by yourself, warranty will be void.
6. If the Wireless repeater falls into water, **DO NOT USE IT AGAIN BEFORE YOU SEND THE CARD TO THE DEALER OF PURCHASE FOR INSPECTION.**

### 1-3 System Requirements

- Wireless network card which is compatible with 802.11b/g/n wireless network standard.
- Windows 2000, 2003, XP, Vista, or Windows 7 operating system
- CD-ROM drive
- At least 100MB of available disk space

## 1-4 Package Contents

Before you start to use this wireless repeater, please check if there's anything missing in the package, and contact your dealer of purchase to claim for missing items:

- Wireless Repeater (1 pcs) ..... 1
- Quick Installation Guide (1 pcs) ..... 2
- User Manual CDROM (1 pcs) ..... 3

## 1-5 Familiar with your new wireless repeater

### *Interface Descriptions*

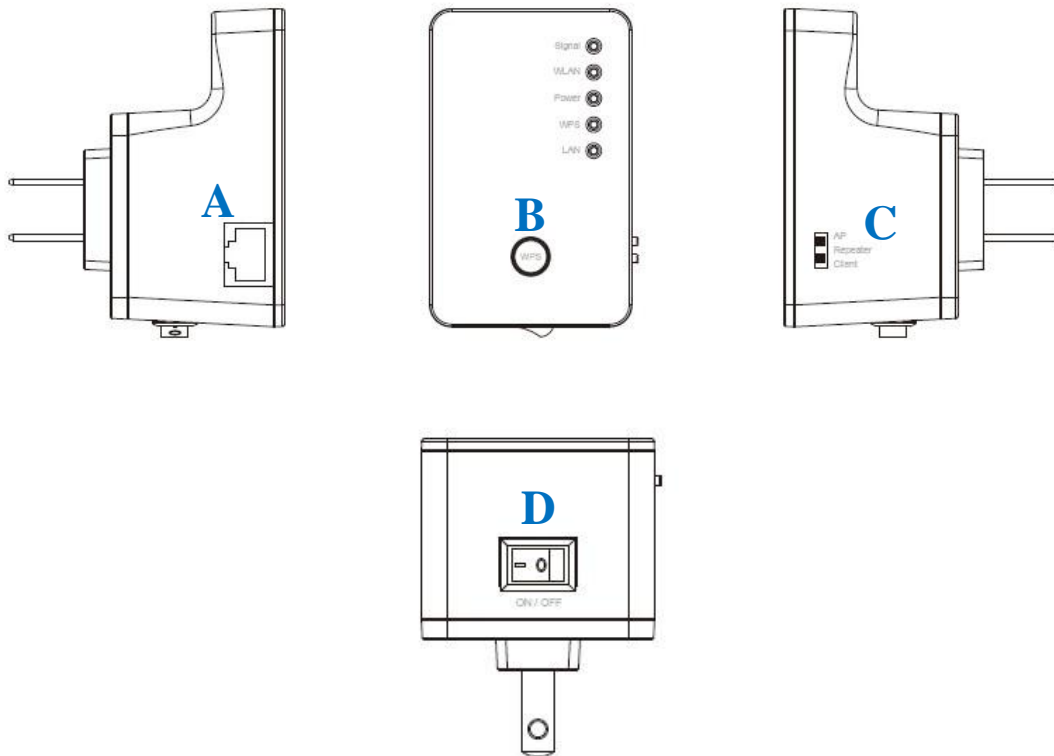

Item	Item Name	Description
A	LAN	10/100M Ethernet LAN Port with Auto-MDI/MDI-X. Connecting to computer, switch or hub for local network sharing.
B	Reset / WPS	Reset the repeater to factory default settings (clear all settings) or start WPS function. Press this button and hold for 10 seconds to restore all settings to factory defaults, and press this button for less than 5 seconds to start WPS function.
C	AP/Repeater/Client	Switch the button to change operating mode to Access Point or Repeater or Client mode.
D	ON/OFF	This is power on/off slide switch. If you want to switch off the repeater, switch it to Off mode.

## LED Definitions

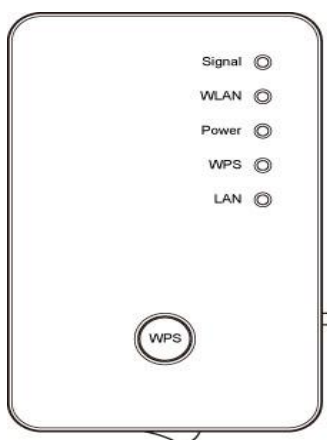

LED	Color	LED Status	Description
Signal	Amber	Steady ON	Good signal reception (signal strength 100%~50%).
		Blinking	Normal signal reception Slow blinking (50%~25%)  Poor signal reception Quick blinking (<25%)
		Off	Out of signal or disconnected/ or LED off mode.
WLAN	Green	Blinking	Connect to wireless Router/or AP, wireless function is active (transferring or receiving data)
		Off	Wireless network is switched off/ or LED off mode.
Power	Green	Steady ON	Power is turned on. In LED off mode. (except power LED is on, other LEDs are off *)  <i>*If user selects to enable “LED OFF mode”, power LED On/Off depends on user’s selection, user can select to leave only power LED on or turn off all LEDs including this power LED.</i>
		Slow Blinking	Ready for “Reset to factory default”, power LED is blinking.

		Off	power is turned off.
WPS	Green	Steady ON	When WPS connection is successful, turn on for 5 minutes.
		Blinking	WPS is in progress of waiting another WPS device's connection, blinking (0.2 second on, 0.1 second off) for 2 minutes.
		Quick blinking	WPS error, blinking (0.1 second on, 0.1 second off)
		Off	NO WPS is in progress/ LED off mode
LAN	Green	Steady ON	LAN port is connected.
		Blinking	LAN port is active (transferring or receiving data).
		Off	LAN port is not connected/ or LED off mode

## CHAPTER II: Repeater mode

Repeater mode is your Wi-Fi range extender!

It can extend your wireless signal and coverage and help you to solve wireless dead zone problem.

This chapter will show you how to quickly install this device by using quick setup and show you the each detailed setting on web UI page of repeater mode.

### 2-1 Repeater mode Quick Installation Guide

For the first time setup and easy installation, you can move this device close to the Wireless Broadband Router or Access point you wish to connect, after installation done and wireless connection is built, you can move this repeater device to the place you wish to use.

Switch mode selector to '**Repeater**'.

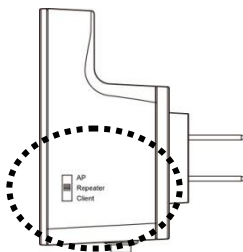

Insert this device into power outlet on the wall, and switch wireless repeater's power switch to '**ON**' (1). You should see '**Power**' LED light up in few seconds (2). If not, please check if the power outlet you're using is working.

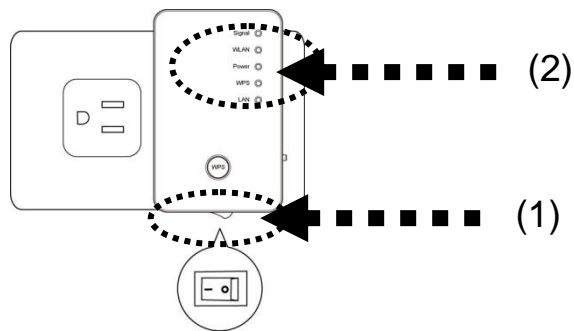

You can build wireless connection via ‘Hardware WPS button’ or ‘Software web browser’.

If your broadband router or access point also supports ‘WPS button’, we recommend you to use WPS button to establish connection, it is the fast and secure way without computer.

**Using WPS button**

**- please go to section 2-1-1**

**Using Web browser**

**- please go to section 2-1-2**



## 2-1-1 Hardware WPS button setup

(1) Press and hold **WPS button** on repeater for 2 seconds, '**WPS**' LED will start flashing.

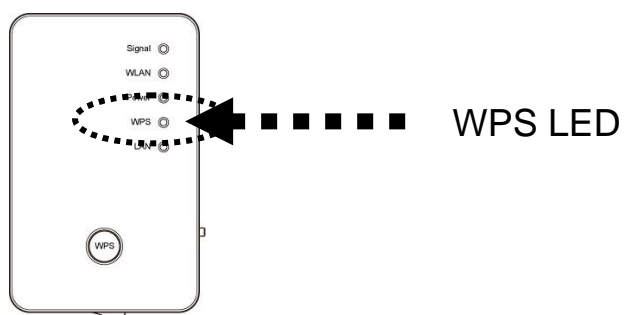
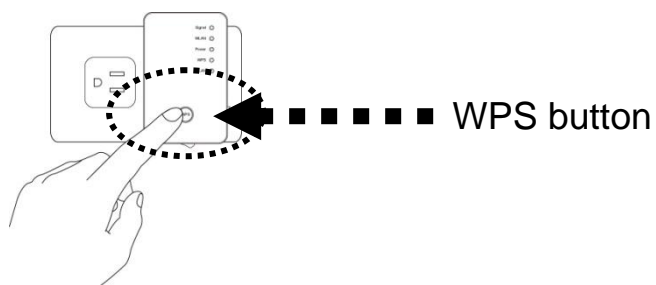

(2) Press **WPS button** on the wireless broadband router or access point you wish to connect within 2 minutes.

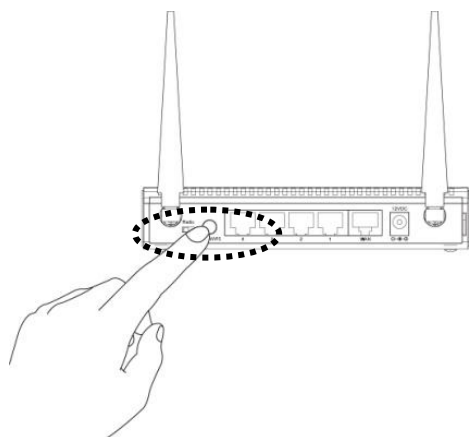

**NOTE: this WPS button position on access point is for example, different device may have different WPS button position.**

**TIP: If the access point you wish to connect does not have hardware WPS button, you can also use its web configuration menu's WPS function to establish connection. Or you can login this repeater web UI to have quick setup (detailed setup refers to '2-1-2 Web browser quick setup' manual)**

(3) If WPS connection is successfully established, '**WPS**' LED will light for 5 minutes; if '**WPS**' LED flashes fast, there's something error, please wait for 2 minutes until '**WPS**' LED off, and try from step(1) again.

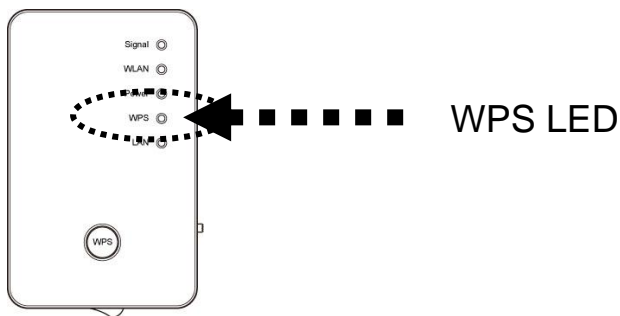

When quick installation is successfully done, '**Signal**' LED will turn on.

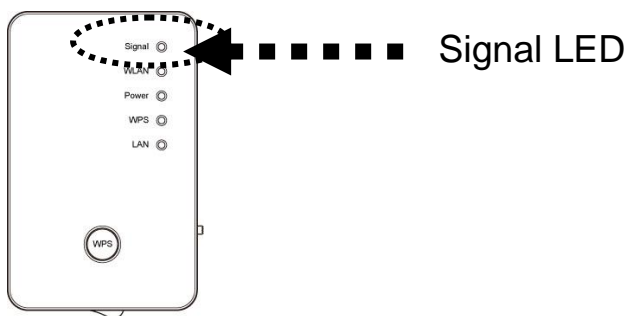

(4) Please move repeater to the place you wish to use (a better place will be the center of your house) and insert this repeater into power outlet on the wall, the wireless connection will be established automatically. You can check '**Signal**' LED status to understand signal reception level. Steady light: Excellent, Flash: Good, Fast flash: poor.

**NOTE: If the Signal LED is off, it means this place is out of wireless signal of your wireless broadband router or access point, please move this repeater closer to broadband router until repeater device can receive signal from broadband router and extend its signal.**

The quick installation setup is completely done, you can refer to '2-2 Repeater mode Advanced Settings' to login in web UI for other advanced settings.

## 2-1-2 Web browser quick setup

Before you can connect to the repeater and start configuration procedures, your computer must be able to get an IP address automatically (use dynamic IP address). If it's set to use static IP address, or you're unsure, please refer to '*Chapter X: Appendix, 5-1 Configuring TCP/IP on PC*' to set your computer to use dynamic IP address.

(1) Use Ethernet cable to connect your computer's Ethernet port and wireless repeater's Ethernet port.

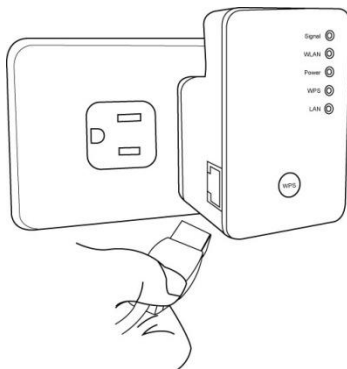

Or use your computer's wireless configuration utility to search for access point named '**repeater**' and get connected. (The default SSID of this repeater device is 'repeater')

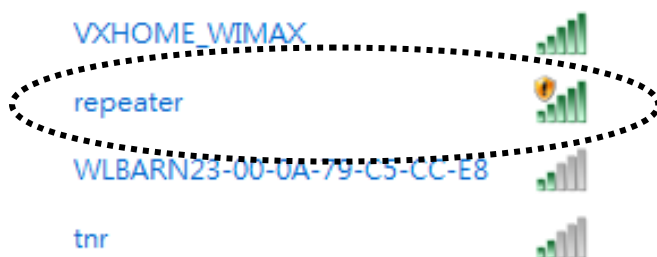

(2) Open web browser and input '**http://repeater**' in address bar. (or you can input the default IP address '192.168.2.254')

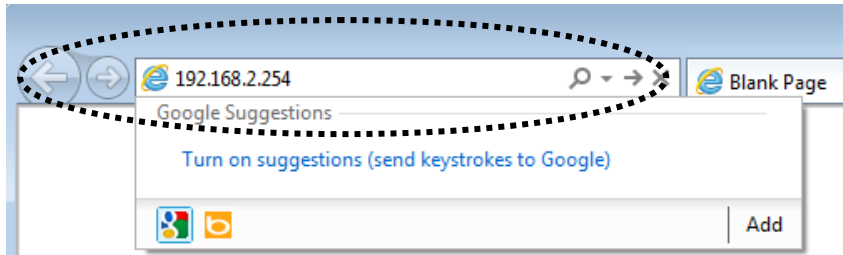

(3) Wireless repeater will prompt you to input username and password. Default username is **'admin'** and password is **'1234'**. Click **'OK'** button to continue.

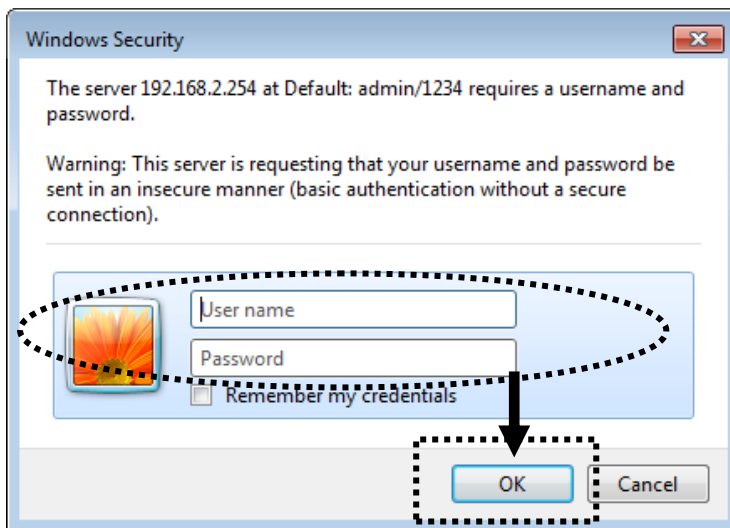

(4) All wireless access points nearby will be displayed on the list. Select one access point you want to connect and click **'Next'** button to continue. If the access point you wish to connect does not appear here, please click **'Refresh'** until it appears on the list, or try to move wireless repeater closer to the access point you wish to connect.

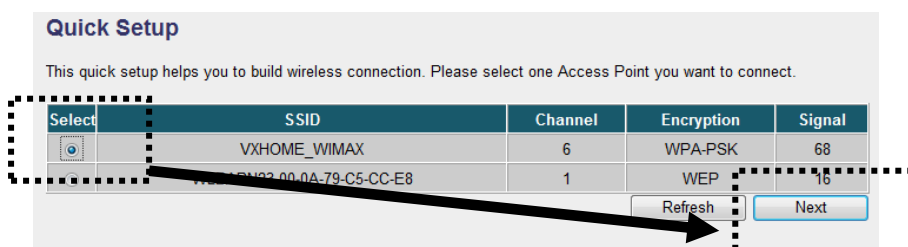

(5) You'll be prompted to input access point's wireless security key, input it in 'KEY' field and click 'Next' to continue.



The image shows a web interface titled "Security". Below the title, it says "Please input wireless security key of your connected Access Point." There is a text input field with the label "KEY:" and a "Next" button to its right.

(6) Wireless repeater will display the connection information for you, if everything's correct, please click 'APPLY' button to get connected.

'Device SSID' will be the same of the access point's SSID you connected in this step. You can change it to a different SSID if you want.

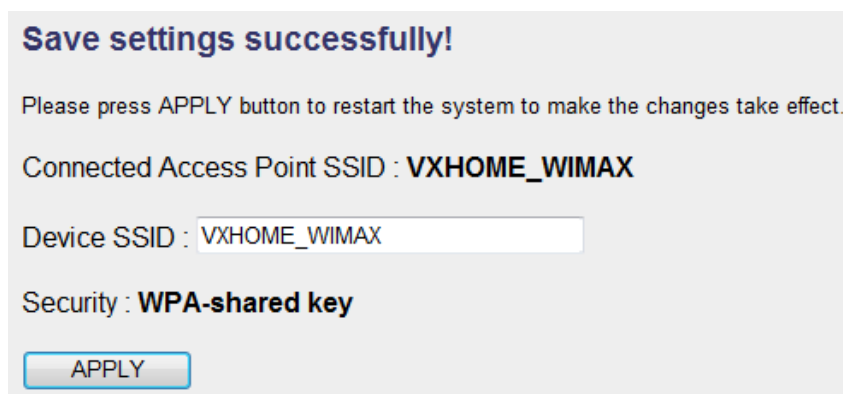

The image shows a web interface titled "Save settings successfully!". Below the title, it says "Please press APPLY button to restart the system to make the changes take effect." It displays the following information: "Connected Access Point SSID : VXHOME\_WIMAX", "Device SSID : VXHOME\_WIMAX", and "Security : WPA-shared key". There is an "APPLY" button at the bottom.

(7) Please wait for few seconds for wireless repeater to reboot.

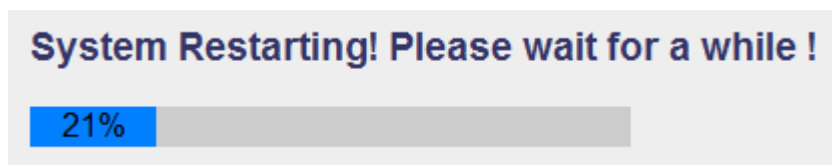

The image shows a web interface titled "System Restarting! Please wait for a while !". Below the title, there is a progress bar showing 21% completion.

(8) After reboot complete, web browser will login repeater's home page of Web UI. You can close browser and use your computer to connect to wireless access point by the SSID you set in last step and start using network.

**NOTE: After wireless connection of this repeater and wireless broadband router is built, repeater is DHCP client and will get IP address from broadband router automatically. If you want to login Web UI of repeater, please refer to '2-2 Repeater mode Advanced Settings' for more functions or learn how to login web UI again.**

## 2-2 Repeater mode Advanced Settings

### 2-2-1 Setup IP address

Default IP address of this Wireless repeater is **192.168.2.254**, please make sure your PC's IP is within the range of 192.168.2.2~192.168.2.252.

Before you can login web UI, you can set your computer's IP address to any IP within this subnet. If you don't know how to do this, please refer to following instructions.

*Windows XP IP address setup:*

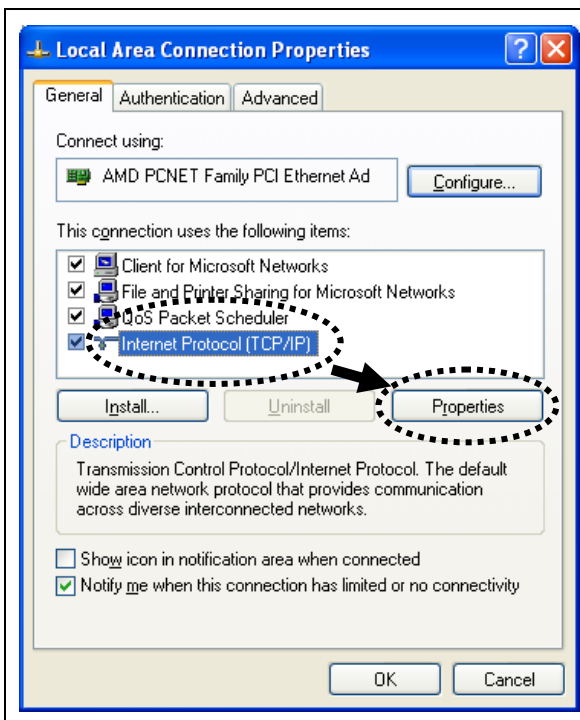

Click 'Start' button (it should be located at lower-left corner of your computer), then click control panel. Double-click **Network and Internet Connections** icon, click **Network Connections**, and then double-click **Local Area Connection, Local Area Connection Status** window will appear, and then click 'Properties'



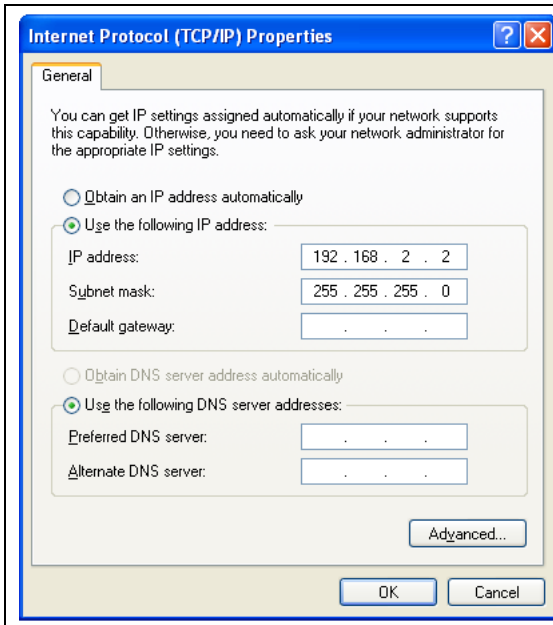

Select 'Use the following IP address', then input the following settings in respective field:

IP address: 192.168.2.x (where x is an integer greater or less than 200, if there's more than one computer need to use this wireless presentation gateway on the same network, every computer should use an unique number)  
 Subnet Mask: 255.255.255.0  
 Click 'OK' when finish.

*Windows Vista/7 IP address setup:*

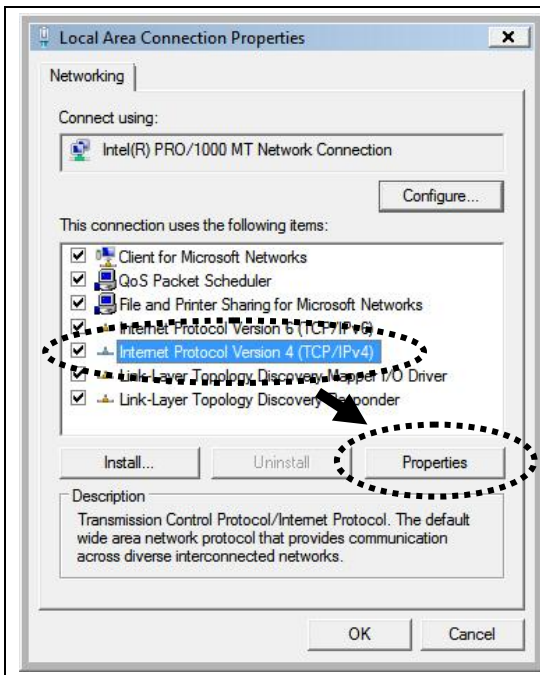

Click 'Start' button (it should be located at lower-left corner of your computer), then click control panel. Click **View Network Status and Tasks**, then click **Manage Network Connections**..Right-click **Local Area Network**, then select **'Properties'**. **Local Area Connection Properties** window will appear, select 'Internet Protocol Version 4 (TCP / IPv4)', and then click 'Properties'

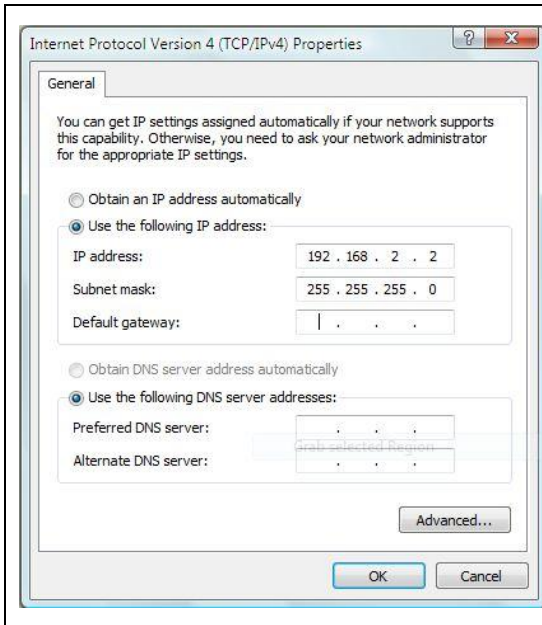

Select 'Use the following IP address', then input the following settings in respective field:

IP address: 192.168.2.x (where x is an integer greater or less than 200, if there's more than one computer need to use this wireless presentation gateway on the same network, every computer should use an unique number)

Subnet Mask: 255.255.255.0

Click 'OK' when finish.

## 2-2-2 Connect to web configuration menu

Please open web browser (IE, firefox, chrome etc.) and input **192.168.2.254** in address bar then press ENTER key:

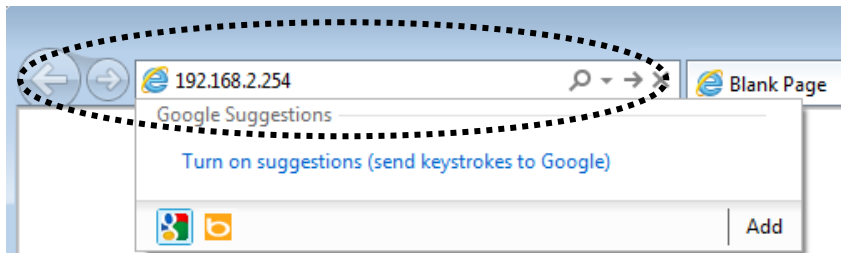

Wireless repeater will prompt you to input username and password. Default username is '**admin**' and password is '**1234**'. Click 'OK' button to continue.

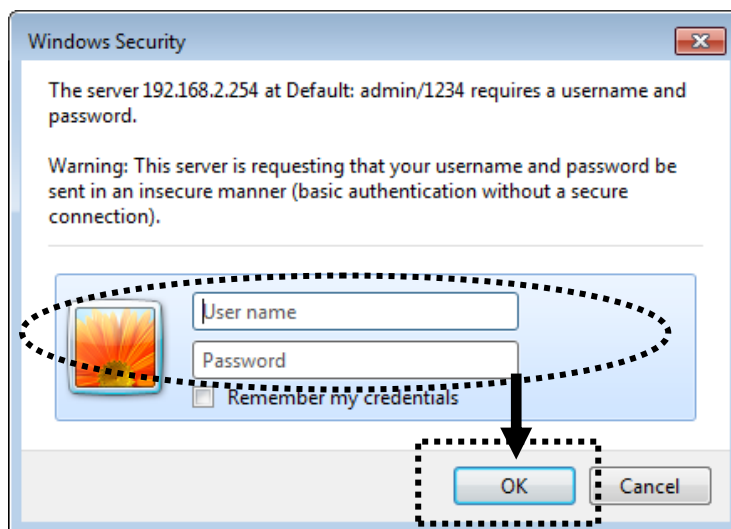

You should be able to see the configuration manual of Wireless repeater in very short time:

- Quick Setup
- WPS Setting
- Advanced Settings
- Home

### Status and Information

You can refer to following information to check the MAC address, runtime code, hardware version and its network configuration status of this device.

System	
Uptime	0day:2h:46m:36s
Hardware Version	Rev. A
Runtime Code Version	1.02d

Wireless Configuration	
Mode	Universal Repeater
ESSID	Super
Channel Number	6
Security	WPA-shared key
BSSID(MAC)	80:1f:02:00:00:03
Associated Clients	0 <input type="button" value="Show Active Clients"/>

LAN Configuration	
IP Address	192.168.2.254
Subnet Mask	255.255.255.0
Default Gateway	0.0.0.0

Detailed operation instructions will be given to following manual.

## 2-2-3 Home

The status and information of this wireless repeater will be displayed here.

To access 'Home' menu, click 'Home' on the left.

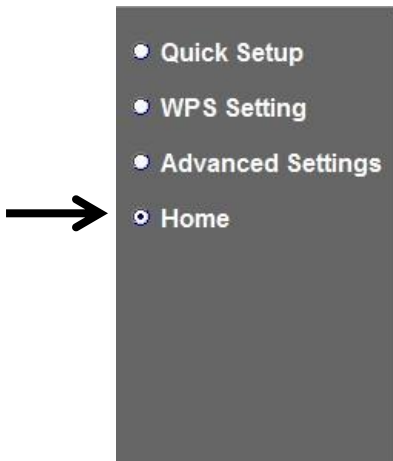

You should see the screen looks like this (the contents will vary depending on your actual setting):

System	
Uptime	0day:2h:46m:36s
Hardware Version	Rev. A
Runtime Code Version	1.02d
Wireless Configuration	
Mode	Universal Repeater
ESSID	Super
Channel Number	6
Security	WPA-shared key
BSSID(MAC)	80:1f:02:00:00:03
Associated Clients	0 <input type="button" value="Show Active Clients"/>
LAN Configuration	
IP Address	192.168.2.254
Subnet Mask	255.255.255.0
Default Gateway	0.0.0.0
MAC Address	80:1f:02:00:00:03

You can click 'Show Active Clients' button to show all connected

wireless clients.

***Please note: By clicking 'Show Active Clients' button, a new browser window will appear. If your browser prevents pop-up window from appearing, please disable this function or you will not be able to use 'Show Client' function.***

## 2-2-4 WPS Setting

You can configure WPS (Wi-Fi Protected Setup) here. By using WPS, you can establish secure connection between this wireless repeater with other wireless devices which also support WPS in a fast and secure manner.

To access 'WPS Setting' menu, click 'WPS Settings' on the left.



The following setup page will appear:

The screenshot shows a web interface for WPS configuration. At the top, there is a checkbox labeled 'Enable WPS' which is checked. Below this is a section titled 'Wi-Fi Protected Setup Information' containing several rows of configuration data: 'WPS Status' is 'Configured', 'Self PinCode' is '35544357', 'SSID' is 'Super', 'Authentication Mode' is 'WPA pre-shared key', and 'Passphrase Key' is masked with asterisks. A second section titled 'Device Configure' offers three methods: '(Device is be a AP/router) Config Mode:' with a dropdown menu set to 'Registrar', 'Configure via Push Button:' with a 'Start PBC' button, and 'Input client PIN code :' with an empty text box and a 'Start PIN' button.

The description of every setup item is listed as follow:

Item	Description
Enable WPS	You can enable or disable WPS function. Disabling WPS function is included hardware WPS button function. Default is 'enable WPS'.
WPS Status	Shows the security setting status of WPS. You must setup the security setting of this wireless repeater manually and the WPS status will become 'Configured'. Currently only WPA encryption is supported, if you select other encryption method, WPS status will remain 'Unconfigured'.
Self PinCode	Here displays an 8-digit number for WPS PIN-style configuration. When other WPS-compatible device wish to connect to this wireless repeater and supports Self-PIN type WPS, input this number to the wireless device to establish connection.
SSID	Shows the SSID of this wireless repeater.



Authentication Mode	Shows the authentication mode of this wireless repeater.
Passphrase Key	Here shows asterisks (*) to indicate wireless security is properly set.
Config Mode	There are 'Registrar' and 'Enrollee' modes for the WPS connection. When 'Registrar' is enabled, the wireless clients will follow the repeater's wireless settings for WPS connection. When 'Enrollee' mode is enabled, the repeater will follow the wireless settings of wireless router for WPS connection.
Start PBC	Click 'Start PBC' to start Push-Button style WPS setup procedure. This wireless repeater will wait for WPS requests from another wireless device for 2 minutes. The 'WPS' LED on the wireless repeater will be blinking for 2 minutes when this wireless repeater is waiting for incoming WPS request.
Start PIN	Please input the PIN code of the wireless client you wish to connect, and click 'Start PIN' button. The 'WPS' LED on the wireless repeater will be blinking when this wireless repeater is waiting for incoming WPS request.

**NOTE: For WPS2.0 compliance specification, WEP and WPA-PSK can't support WPS connection, some of wireless devices may follow this latest WPS2.0 specification, so we recommend you not to use WEP and WPA-PSK to avoid WPS interoperability problem.**

## 2-2-5 Advanced Settings

You can configure advanced wireless settings in this page. Please note that these settings are not safe to be configured by novice users. Configure these settings only when you understand what you're doing.

To access 'Advanced Setting' menu, click 'Advanced Setting' on the left.

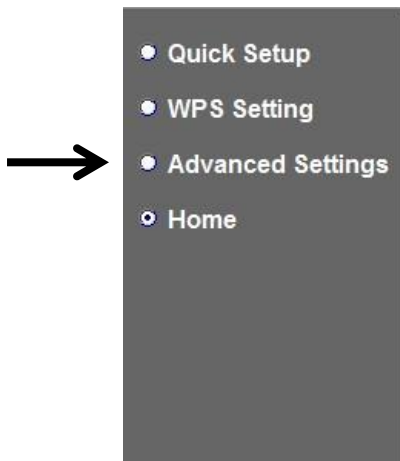

The following setup page will appear:

Fragment Threshold:	<input type="text" value="2346"/>	(256-2346)
RTS Threshold:	<input type="text" value="2347"/>	(0-2347)
Beacon Interval:	<input type="text" value="100"/>	(20- 1024 ms)
DTIM Period:	<input type="text" value="3"/>	(1-10)
Data Rate:	Auto ▾	
N Data Rate:	Auto ▾	
Channel Width:	<input checked="" type="radio"/> Auto 20/40 MHz <input type="radio"/> 20 MHz	
Preamble Type:	<input checked="" type="radio"/> Short Preamble <input type="radio"/> Long Preamble	
Broadcast ESSID:	<input checked="" type="radio"/> Enable <input type="radio"/> Disable	
WMM:	<input type="radio"/> Enable <input checked="" type="radio"/> Disable	
CTS Protect:	<input checked="" type="radio"/> Auto <input type="radio"/> Always <input type="radio"/> None	
TX Power:	100 % ▾	

Enable LED OFF mode

- Turn off all LED
- Turn off all LED except POWER LED

The description of every setup item is listed as follow:

Item	Description
Fragment Threshold	Set the Fragment threshold of wireless radio. Threshold. Do not modify default value if you don't know what it is, default value is 2346.
RTS Threshold	Set the RTS threshold of wireless radio. Do not modify default value if you don't know what it is, default value is 2347.
Beacon Interval	Set the beacon interval of wireless radio. Do not modify default value if you don't know what it is, default value is 100.
DTIM Period	Configures DTIM (Delivery Traffic Indication Message) send period. Default value is 3.
Data Rate	Select wireless data transfer speed. When you select a value here, this repeater will refuse to

	<p>establish connection with wireless clients by other speed.</p> <p>It's recommended to select 'Auto' and this wireless repeater will adjust the speed automatically.</p>
N Data Rate	<p>Select wireless data transfer speed by MCS0 to MCS7. MCS stands for Modulation and Coding Scheme, which represents different speed when bandwidth is 20MHz or 40MHz.</p> <p>It's recommended to select 'Auto' and this wireless repeater will adjust the speed automatically.</p>
Channel Width	<p>Select the wireless channel width, 20MHz or 40MHz. 40MHz provides better network speed for 802.11n wireless clients.</p> <p>However, if there're 802.11b / g clients connecting to this wireless repeater, it will switch to 20MHz mode automatically.</p>
Preamble Type	<p>Set the type of preamble of wireless radio, Do not modify default value if you don't know what it is, default setting is 'Short Preamble'.</p>
Broadcast ESSID	<p>When set to 'enabled', every wireless devices can scan and found this wireless repeater; when set to 'disabled', only wireless clients who know exact SSID can get connected with this wireless repeater. Set to disabled will help to improve security.</p>
WMM	<p>Enable or disable Wireless Multi-Media. When enabled, wireless repeater will give priority to multimedia related network applications so they will have better performance.</p>
CTS Protect	<p>This function provides CTS (Clear to Send) protection when transferring data. It's recommended to select 'Auto' for this option.</p>
TX Power	<p>Select wireless transmitting power level, from 10% to 100%. When wireless clients are not too</p>

	far from this wireless repeater, you don't have to select a higher power level, since this may cause some people to try to break into your wireless network when you have a bad password or no password.
Enable LED off mode	<p>You can enable or disable LED lights</p> <p>Check '<b>Enable LED OFF</b>' mode to setup LED behavior:</p> <p>Turn off all LED: disabled all LED lights</p> <p>Turn off all LED except POWER LED: all LED lights will be disabled, except 'POWER' LED</p>

When you finish settings in this page, click 'Apply' button. You'll see the following message:

**Save settings successfully!**

You may press CONTINUE button to continue configuring other settings or press APPLY button to restart the system to make the changes take effect.

If you still need to configure this wireless repeater, click 'CONTINUE' button; if you want to save changes and make it work now, click 'APPLY' button.

**System Restarting! Please wait for a while !**

13%

You'll be prompted to wait for 30 seconds before you can reconnect to this wireless repeater.

## 2-2-6 MAC Address Filtering

Besides using wireless security to only allow permitted wireless users to use this wireless repeater, you can also use MAC address filter to allow wireless users with certain MAC address to use this wireless repeater.

This will enhance security because you can make a 'white list' to allow users on the list to use this wireless repeater only in advance. For those clients who don't list on this white list can't get connected, even he or she know the password.

To access 'MAC Filtering' menu, click 'MAC Filtering' on the left.

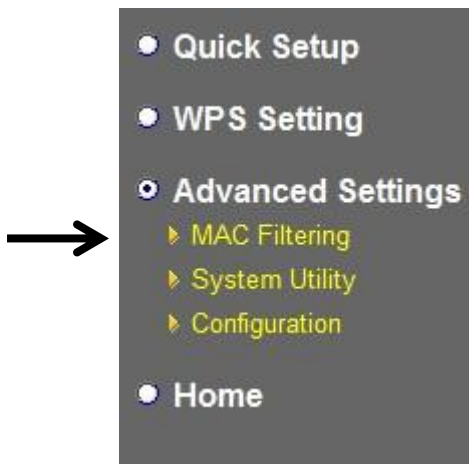

The following setup page will appear:

• **MAC Address Filtering Table**  
It allows to entry 20 sets address only.

NO.	MAC Address	Comment	Select
1	11:22:33:44:55:66	Allowed client	<input type="checkbox"/>

**Enable Wireless Access Control**

MAC Address: 
 Comment:

The description of every setup item is listed as follow:

Item	Description
Enable Wireless Access Control	Check this box to enable MAC filtering. If you didn't check this box, anyone who knows the wireless password can get connected to this wireless repeater.
MAC Address	Input the MAC address of the clients you wish to deny or accept to access the repeater into the MAC address list. Please input 12 HEX characters here, and you don't have to add : (colon) or - (dash) characters every 2 characters.  <i>If you don't know how to get the MAC address of a network client, see tips below.</i>
Comment	Input any descriptive text about this rule, so you can remember the purpose of this rule. You can input up to 20 alphanumerical characters in this field.
Add	Add this MAC address to the list.
Clear	Clear 'MAC Address' and 'Comment' field.
Delete Selected	Delete MAC address(es) you selected which

	'Select' box is checked.
Delete All	Delete all MAC addresses in the list. You'll be prompted to confirm deletion first.
Reset	Uncheck all checked boxes.
Select	All existing MAC addresses will be listed here. To delete a MAC address from the list, check the box of the MAC address you wish to delete first. You can select more than one MAC addresses here.

When you finish settings in this page, click 'Apply' button. You'll see the following message:

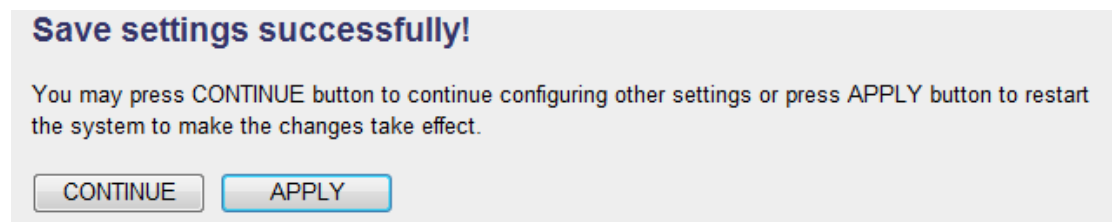

If you still need to configure this wireless repeater, click 'CONTINUE' button; if you want to save changes and make it work now, click 'APPLY' button. You'll be prompted to wait for 30 seconds before you can reconnect to this wireless repeater.

TIPS: If you don't know the MAC address of your computer or wireless device, you can follow the following procedure:

For wireless devices and computers which are connected to this wireless repeater already, you can click 'Show Active Clients' button in 'Home' setting page.



Wireless Configuration	
Mode	Universal Repeater
ESSID	Super
Channel Number	6
Security	WPA-shared key
BSSID(MAC)	80:1f:02:00:00:03
Associated Clients	0 <input type="button" value="Show Active Clients"/>

Their MAC address will be displayed at 'MAC Address' field.

If you still can't identify the MAC address of computer, you can follow the following procedure:

Click the network icon located at the lower-right corner, then click 'Open Network and Sharing Center'.

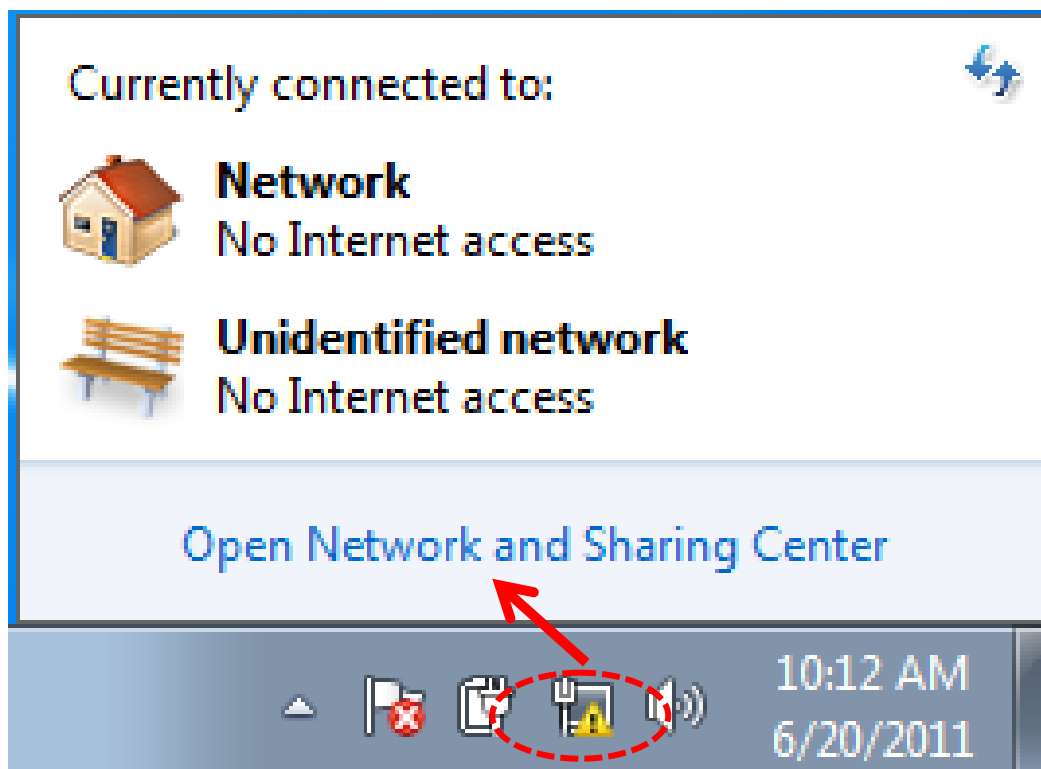



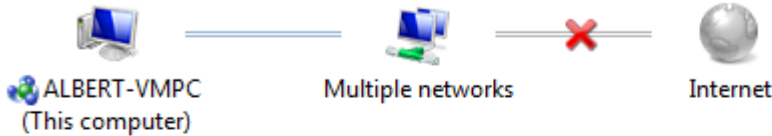

Click the connection that you'll be used to connect the wireless repeater (in this example, 'Local Area Connection'):

View your basic network information and set up connections 



[See full map](#)

View your active networks [Connect or disconnect](#)

 <b>Network</b> Home network	Access type: No Internet access HomeGroup: <a href="#">Joined</a> Connections:  <a href="#">Local Area Connection</a>
 <b>Unidentified network</b> Public network	Access type: No Internet access Connections:  <a href="#">Local Area Connection 2</a>

Click 'Details...' button.

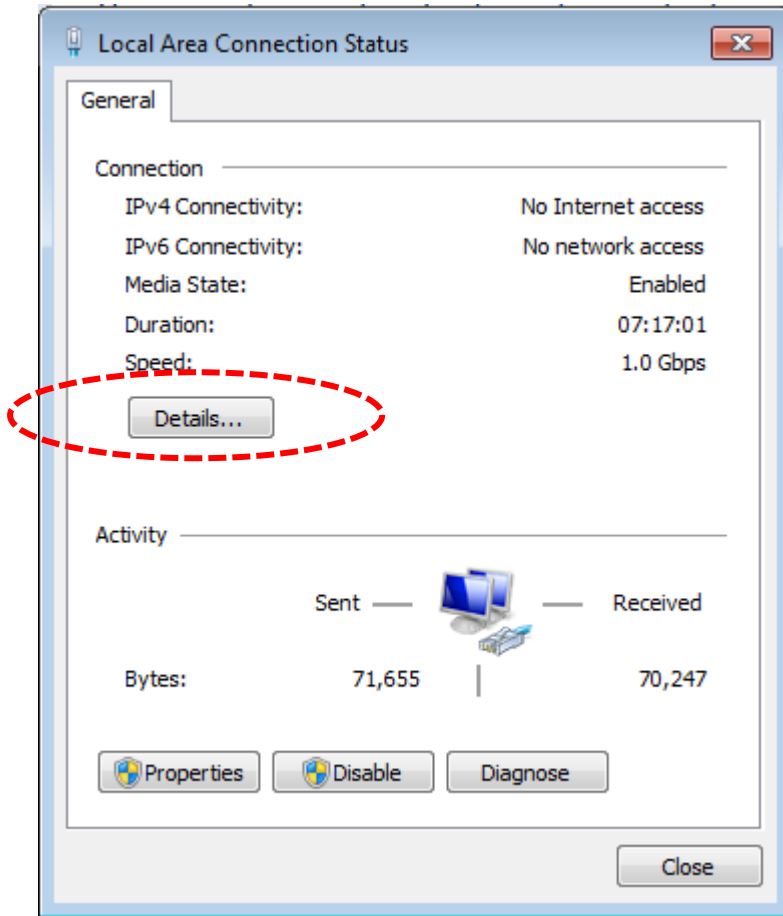

The MAC address of selected network connection will be displayed here as 'Physical Address'.

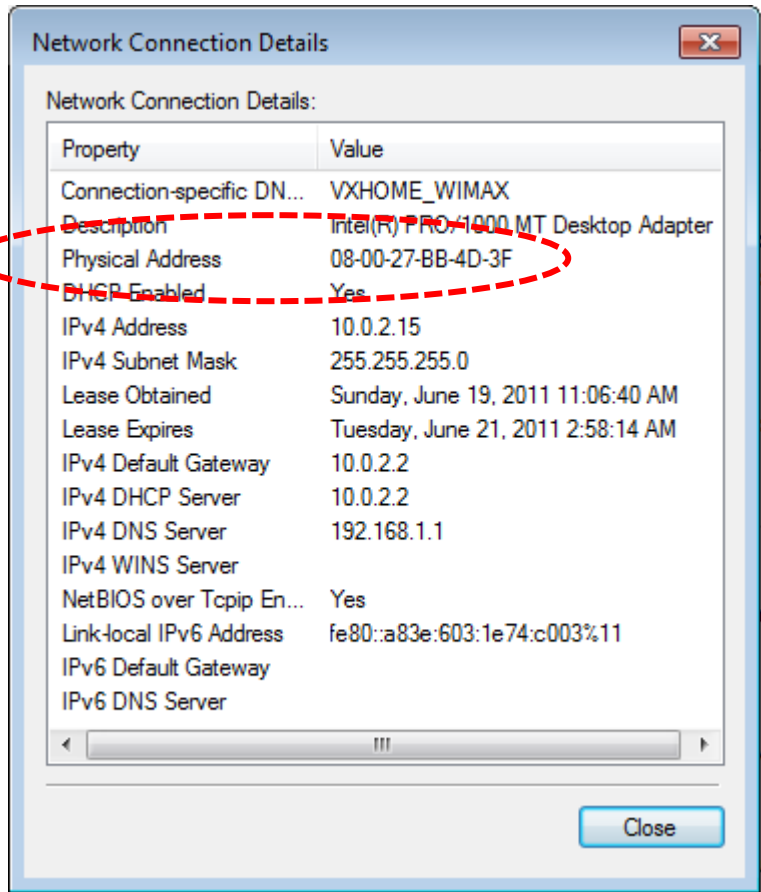

## 2-2-7 System Utility

You can change the settings of several system-level parameters in this page, including administrator's password, and IP address.

To access 'System Utility' menu, click 'System Utility' on the left.

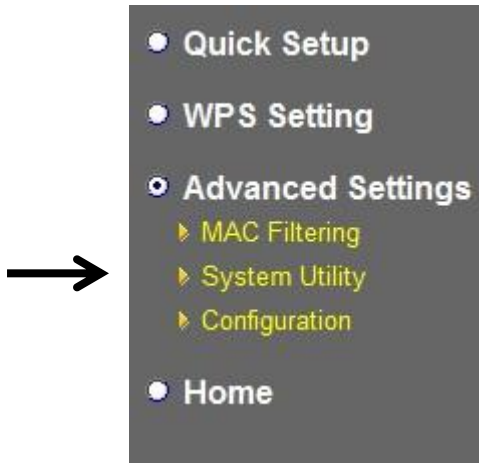

The following setup page will appear:

The screenshot shows a web interface with two main sections. The first section is titled "Password Settings" and contains three input fields: "Current Password", "New Password", and "Re-Enter Password". The second section is titled "Management IP" and contains three input fields: "IP Address" (with the value 192.168.2.254), "Subnet Mask" (with the value 255.255.255.0), and "Gateway Address" (with the value 0.0.0.0).

The description of every setup item is listed as follow:

### Password Settings

Default password of this repeater is 1234, and it's displayed on the login prompt when accessed from web browser. There's a security risk if you don't change the default password, since everyone can see it. This is very important when you have wireless function enabled.

Here are descriptions of every setup items:

Item	Description
Current Password	To change password, you have to input current password first.
New Password	Input new password here. You can use the combination of alphabets, number, and symbols for up to 20 characters.
Re-Enter Password	Input new password again for conformation.

## Management IP

To set up the IP address of this wireless repeater, please see the following description.

Item	Description
IP Address	<p>Input the IP address of LAN / Wi-Fi port of this wireless repeater.</p> <p><i>NOTE: Please remember this IP address. If you forget this IP address and you didn't use DHCP server function to assign IP address to clients, you'll not be able to connect to this wireless repeater and you'll need to clear all settings and password to reset the IP address back to default value '192.168.2.254'.( Press WPS button and hold for 10 seconds to restore all settings to factory defaults)</i></p>
Subnet Mask	<p>Input the subnet mask of the IP address you're using.</p>
Gateway Address	<p>Input the gateway's IP address of your network. Generally you can use '0.0.0.0' (default value) since this wireless repeater will access Internet via WAN port.</p>

When you finish settings in this page, click 'Apply' button. You'll see the following message:

**Save settings successfully!**

You may press CONTINUE button to continue configuring other settings or press APPLY button to restart the system to make the changes take effect.

If you still need to configure this wireless repeater, click 'CONTINUE' button; if you want to save changes and make it work now, click 'APPLY' button. You'll be prompted to wait for 30 seconds before you can reconnect to this wireless repeater.

## 2-2-8 Configuration

You can backup and restore the configuration of this wireless repeater, so you can recall all settings back in very short time, without doing configuration again.

This function is especially useful when you need to use this mini Wi-Fi repeater in different places, like home and hotel.

To access 'Configuration' menu, click 'Configuration' on the left.

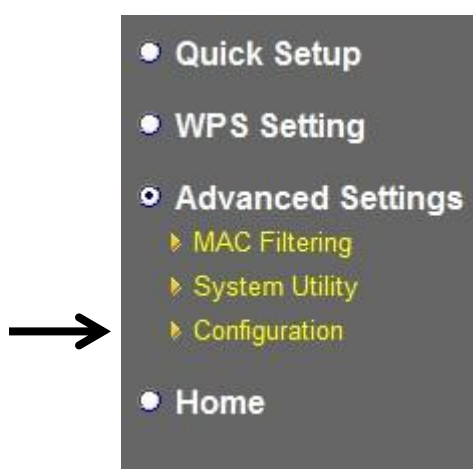

## Configuration Tool

The following setup page will appear:



The description of every setup item is listed as follow:

Item	Description
Backup Settings	Click 'Save' button to save the current settings to a file on your computer.



Restore Settings	If you want to upload a saved configuration file to wireless repeater, please click 'Browse' button to select a saved configuration file on your computer. Then click 'Upload' button to restore the current settings to new one.
Reset to Factory Default	<p>To reset all settings of this wireless repeater to factory defaults, including password. You'll be prompted to confirm the settings reset:</p> <div data-bbox="496 645 1350 987" data-label="Image"> </div> <p>Click 'OK' if you really want to restore all settings, or click 'Cancel' to abort.</p>

## WEB Upgrade

The software running in this wireless repeater (i.e. 'Firmwre') can be upgraded to improve the functionality of this wireless repeater.

You can access our website to look for latest firmware file. Then download the latest firmware file and save on your computer and upload to this wireless repeater.

### WEB Upgrade

This tool allows you to upgrade the Access Point's system firmware. It is recommended that upgrading the firmware from wired stations. Enter the path and name of the upgrade file and then click the APPLY button below. You will be prompted to confirm the upgrade.

The description of every setup item is listed as follow:

Item	Description
Browse	Select a firmware file saved on your computer.

When you are ready, click ‘Apply’ button to start firmware upgrade procedure.

## Reset

When you think this wireless repeater is not working properly, resetting it may help.



To reset this wireless repeater, click ‘Apply’ button. You’ll be prompted to confirm reset:

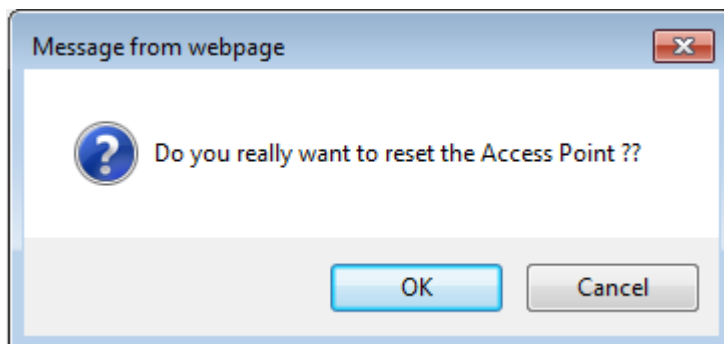

Click ‘OK’ button to reset wireless repeater, or click ‘Cancel’ to abort.

## CHAPTER III: Client mode

Client mode can let your networking device have wireless capability; it will become your networking device's wireless network card. You can connect this device to Ethernet port of your existing internet TV or DVD player or game console device with Ethernet cable.

This chapter will show you how to quickly install this device by using quick setup and show you the each detailed setting on web UI page of client mode.

### 3-1 Client mode Quick Installation Guide

Switch mode selector to '**Client**'.

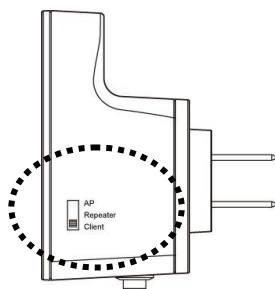

Insert this device into power outlet on the wall, and switch wireless repeater's power switch to '**ON**' (1). You should see '**Power**' LED light up in few seconds (2). If not, please check if the power outlet you're using is working.

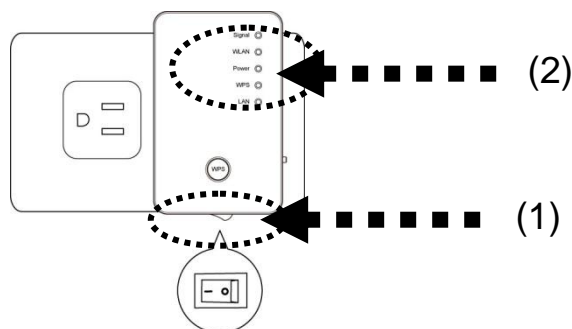

Connect your wired networking device(wired PC, or internet TV, or game console..etc.) and this device by Ethernet cable.

***NOTE: You must set your networking device as DHCP client (obtain IP automatically from DHCP server)***

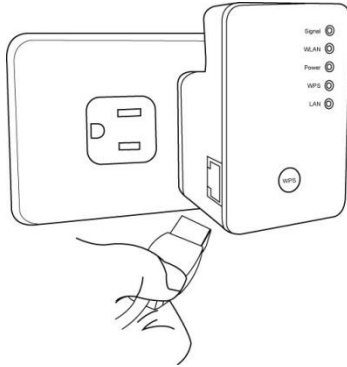

You can build wireless connection via ‘Hardware WPS button’ or ‘Software web browser’.

If your broadband router or access point also supports ‘WPS button’, we recommend you to use WPS button to establish connection, it is the fast and secure way without computer.

**Using WPS button**

**- please go to section 3-1-1**

**Using Web browser**

**- please go to section 3-1-2**

### 3-1-1 Hardware WPS button setup

(1) Press and hold **WPS button** on repeater for 2 seconds, 'WPS' LED will start flashing.

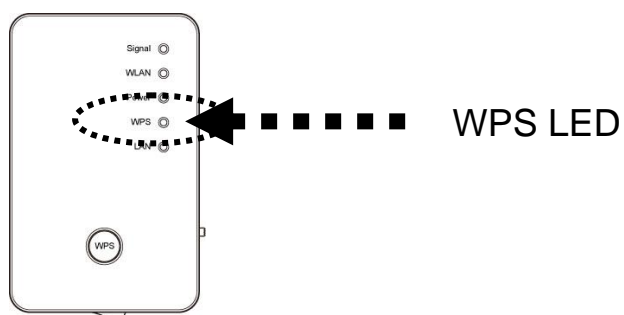
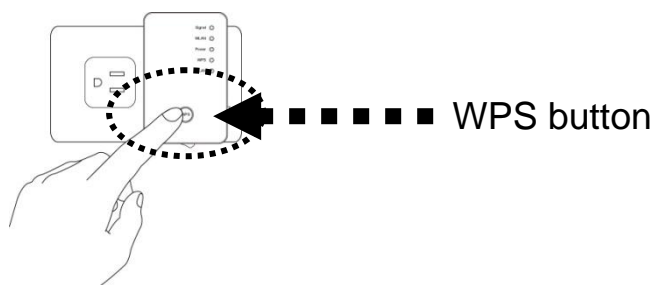

(2) Press **WPS button** on the wireless broadband router or access point you wish to connect within 2 minutes.

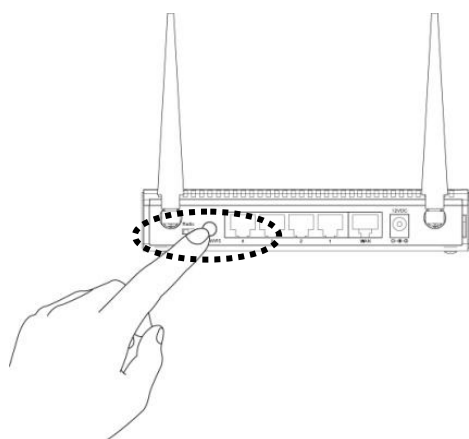

**NOTE: this WPS button position on access point is for example, different device may have different WPS button position.**

**TIP: If the access point you wish to connect does not have hardware WPS button, you can also use its web configuration menu's WPS function to establish connection. Or you can login this repeater web UI to have quick setup (detailed setup refers to '3-1-2 Web browser quick setup' manual)**

(3) If WPS connection is successfully established, '**WPS**' LED will light for 5 minutes; if '**WPS**' LED flashes fast, there's something error, please wait for 2 minutes until '**WPS**' LED off, and try from step(1) again.

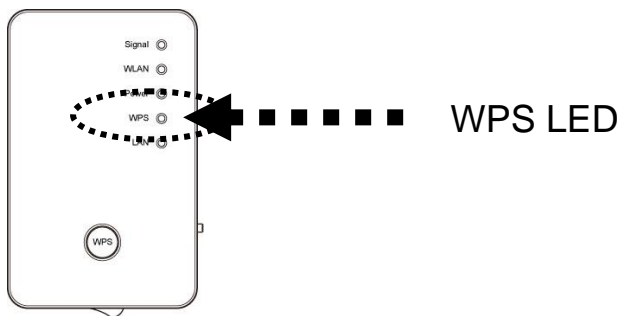

When quick installation is successfully done, '**Signal**' LED will turn on.

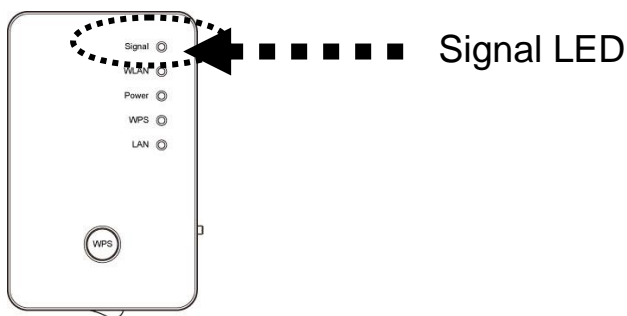

(4) Connecting this device and your networking device (internet TV or game console etc.) with Ethernet cable, the wireless connection will be established automatically.

You can check '**Signal**' LED status to understand signal reception level. Steady light: Excellent, Flash: Good, Fast flash: poor.

**NOTE: If the Signal LED is off, it means this place is out of wireless signal of your wireless broadband router or access point, please move this repeater closer to broadband router until repeater device can receive signal from broadband router.**

The quick installation setup is completely done, you can refer to '3-2 Client mode Advanced Settings' to login in web UI for other advanced settings.

### 3-1-2 Web browser quick setup

Before you can connect to the repeater and start configuration procedures, your computer must be able to get an IP address automatically (use dynamic IP address). If it's set to use static IP address, or you're unsure, please refer to '*Chapter X: Appendix, 5-1 Configuring TCP/IP on PC*' to set your computer to use dynamic IP address.

(1) Use Ethernet cable to connect your computer's Ethernet port and this wireless repeater's Ethernet port.

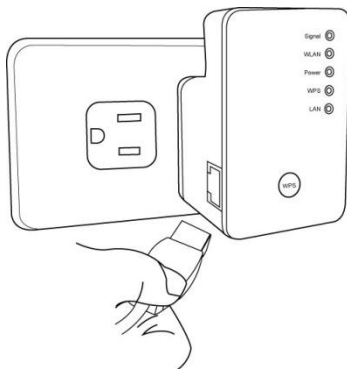

(2) Open web browser and input '**http://repeater**' in address bar. (or you can input the default IP address '192.168.2.253')

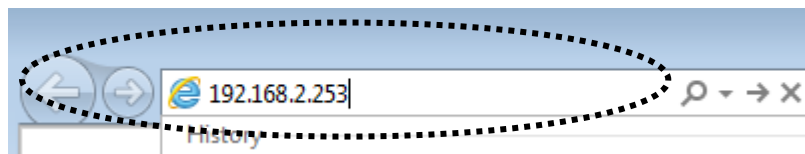

(3) Wireless repeater will prompt you to input username and password. Default username is '**admin**' and password is '**1234**'. Click 'OK' button to continue.



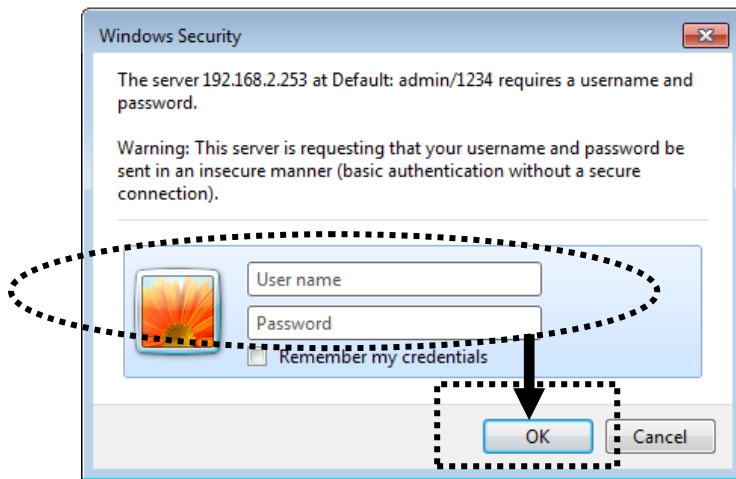

(4) All wireless access points nearby will be displayed on the list. Select one access point you want to connect and click 'Next' button to continue. If the access point you wish to connect does not appear here, please click 'Refresh' until it appears on the list, or try to move this wireless repeater closer to the access point you wish to connect.

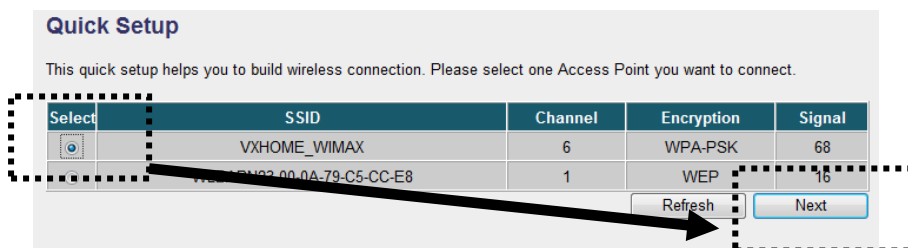

(5) You'll be prompted to input access point's wireless security key, input it in 'KEY' field and click 'Next' to continue.

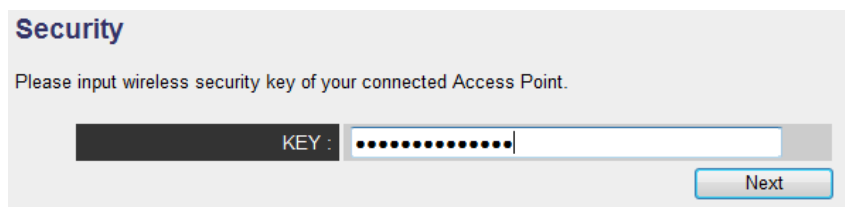

(6) Wireless repeater will display the connection information for you, if everything's correct, please click 'APPLY' button to get connected.

‘Connected Access Point SSID’ is the SSID of your access point that you selected to connect in previous step, please double confirm all information is correct, if you want to change it, you can press ‘Back’ to select again or press ‘APPLY’ to take this change effect.

**Save settings successfully!**

Please press APPLY button to restart the system to make the changes take effect.

Connected Access Point SSID : **varioxmnet**

Security : **WPA-shared key**

(7) Please wait for few seconds for wireless repeater to reboot.

**System Restarting! Please wait for a while !**

21%

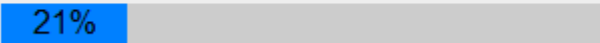

(8) After reboot complete, web browser will login client mode’s home page of Web UI. You can close browser and start using network.

**NOTE:** After wireless connection of this repeater and wireless broadband router is built, this device becomes DHCP client and will get IP address from your broadband router automatically. If you want to login Web UI of this repeater again, please refer to ‘3-2 Client mode Advanced Settings’ for more functions setup or learn how to login web UI again.

## 3-2 Client mode Advanced Settings

### 3-2-1 Setup IP address

Default IP address of Client mode is **192.168.2.253**, please make sure your PC's IP is within the range of 192.168.2.2~192.168.2.252.

Before you can login web UI, you can set your computer's IP address to any IP within this subnet. If you don't know how to do this, please refer to following instructions.

*Windows XP IP address setup:*

	<p>Click 'Start' button (it should be located at lower-left corner of your computer), then click control panel. Double-click <b>Network and Internet Connections</b> icon, click <b>Network Connections</b>, and then double-click <b>Local Area Connection, Local Area Connection Status</b> window will appear, and then click 'Properties'</p>
--	---

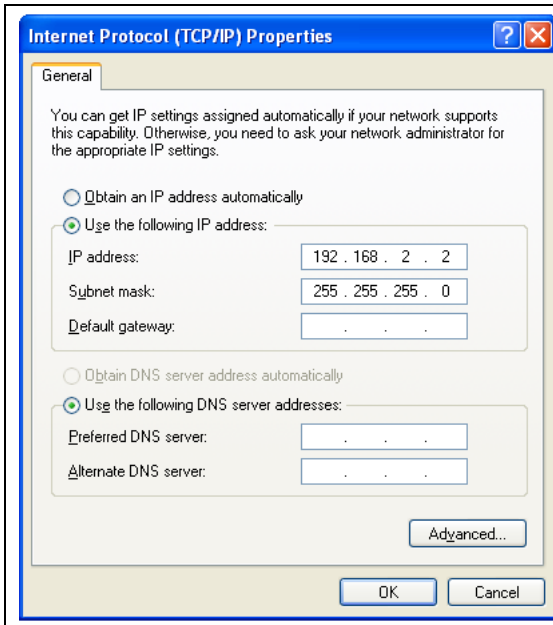

Select 'Use the following IP address', then input the following settings in respective field:

IP address: 192.168.2.x (where x is an integer greater or less than 200, if there's more than one computer need to use this wireless presentation gateway on the same network, every computer should use an unique number)  
 Subnet Mask: 255.255.255.0  
 Click 'OK' when finish.

*Windows Vista/7 IP address setup:*

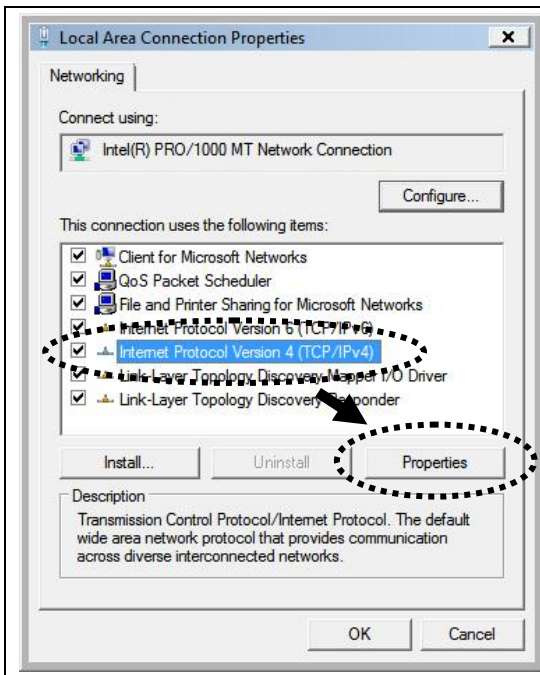

Click 'Start' button (it should be located at lower-left corner of your computer), then click control panel. Click **View Network Status and Tasks**, then click **Manage Network Connections..** Right-click **Local Area Network**, then select **'Properties'**. **Local Area Connection Properties** window will appear, select 'Internet Protocol Version 4 (TCP / IPv4)', and then click 'Properties'

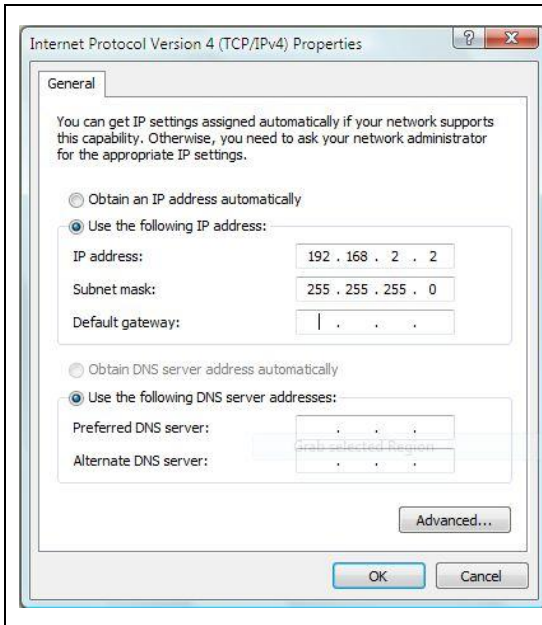

Select 'Use the following IP address', then input the following settings in respective field:

IP address: 192.168.2.x (where x is an integer greater or less than 200, if there's more than one computer need to use this wireless presentation gateway on the same network, every computer should use an unique number)

Subnet Mask: 255.255.255.0

Click 'OK' when finish.

### 3-2-2 Connect to web configuration menu

Please open web browser (IE, firefox, chrome etc.) and input **192.168.2.253** in address bar then press ENTER key:

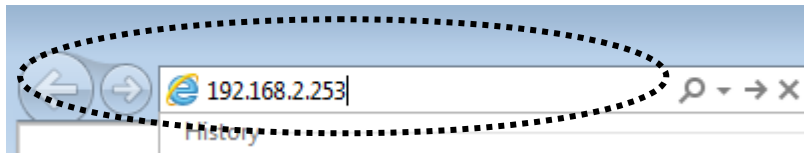

Wireless repeater will prompt you to input username and password. Default username is '**admin**' and password is '**1234**'. Click 'OK' button to continue.

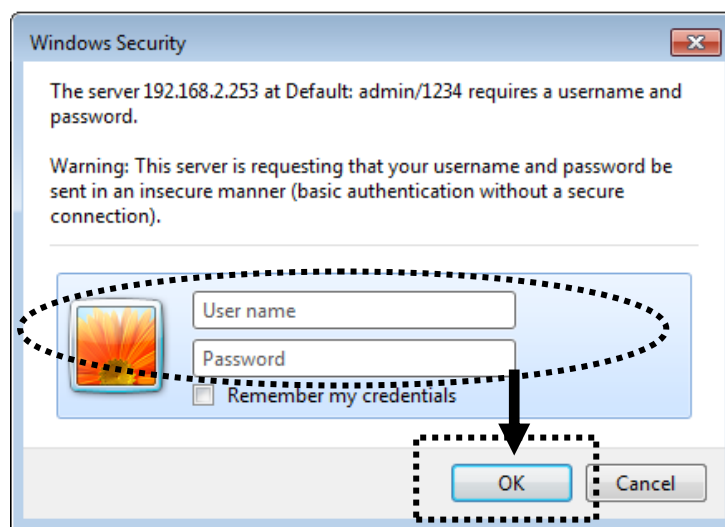

You should be able to see the configuration manual of Client mode in very short time:

Detailed operation instructions will be given to following manual.

### 3-2-3 Home

The status and information of client mode will be displayed here.

To access 'Home' menu, click 'Home' on the left.

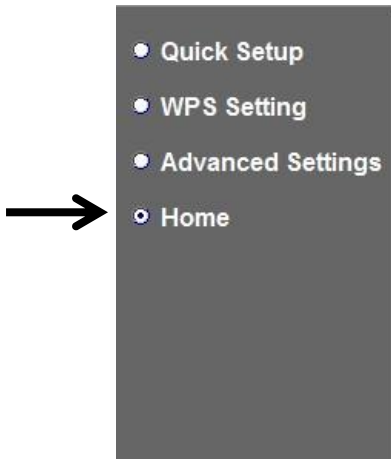

You should see the screen looks like this (the contents will vary depending on your actual setting):

System	
Uptime	0day:0h:6m:28s
Hardware Version	Rev. A
Runtime Code Version	1.02d
Wireless Configuration	
Mode	Station-Infrastructure
ESSID	si
Channel Number	10
Security	Disable
BSSID(MAC)	80:1f:02:00:00:03
State	Scanning
LAN Configuration	
IP Address	192.168.2.253
Subnet Mask	255.255.255.0
Default Gateway	0.0.0.0
MAC Address	80:1f:02:00:00:03

### 3-2-4 WPS Setting

You can configure WPS (Wi-Fi Protected Setup) here. By using WPS, you can establish secure connection between this wireless repeater with other wireless devices which also support WPS in a fast and secure manner.

To access 'WPS Setting' menu, click 'WPS Settings' on the left.

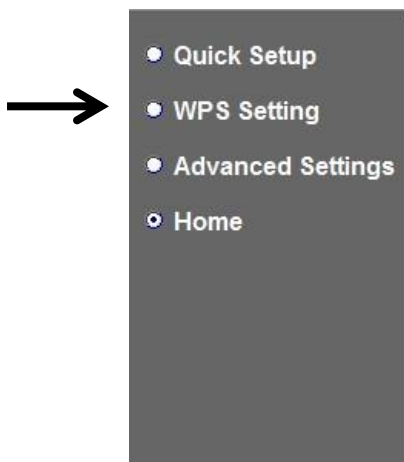



The following setup page will appear:

The description of every setup item is listed as follow:

Item	Description
Enable WPS	You can enable or disable WPS function. Disabling WPS function is included hardware WPS button function. Default is 'enable WPS'.
WPS Status	Shows the security setting status of WPS. You must setup the security setting of this wireless repeater device manually and the WPS status will become 'Configured'. Currently only WPA encryption is supported, if you select other encryption method, WPS status will remain 'Unconfigured'.
Self PinCode	Here displays an 8-digit number for WPS PIN-style configuration. When other WPS-compatible device wish to connect to this wireless repeater and supports Self-PIN type WPS, input this number to the wireless device to establish connection.
SSID	Shows the SSID of this wireless repeater.
Authentication Mode	Shows the authentication mode of this wireless repeater.

Passphrase Key	Here shows asterisks (*) to indicate wireless security is properly set.
Config Mode	Client mode only supports 'Enrollee' mode, you can input this client mode's PIN code to AP/Router.
Start PBC	Click 'Start PBC' to start Push-Button style WPS setup procedure. This wireless repeater device will wait for WPS requests from another wireless device for 2 minutes. The 'WPS' LED on the wireless repeater will be blinking for 2 minutes when this wireless repeater is waiting for incoming WPS request.
Start PIN	Please click 'Start PIN' button and input this PIN code to the wireless broadband router or Access point you wish to connect. The 'WPS' LED on the wireless repeater will be blinking when this wireless repeater is waiting for incoming WPS request.

**NOTE: For WPS2.0 compliance specification, WEP and WPA-PSK can't support WPS connection, some of wireless devices may follow this latest WPS2.0 specification, so we recommend you not to use WEP and WPA-PSK to avoid WPS interoperability problem.**

### 3-2-5 Advanced Settings

You can configure advanced wireless settings in this page. Please note that these settings are not safe to be configured by novice users. Configure these settings only when you understand what you're doing.

To access 'Advanced Setting' menu, click 'Advanced Setting' on the left.



The following setup page will appear:

Fragment Threshold:	<input type="text" value="2346"/>	(256-2346)
RTS Threshold:	<input type="text" value="2347"/>	(0-2347)
Channel Width:	<input checked="" type="radio"/> Auto 20/40 MHz <input type="radio"/> 20 MHz	
WMM:	<input type="radio"/> Enable <input checked="" type="radio"/> Disable	
TX Power:	<input type="text" value="100 %"/> ▼	
<input type="checkbox"/> Enable LED OFF mode		
<input type="radio"/> Turn off all LED		
<input type="radio"/> Turn off all LED except POWER LED		

The description of every setup item is listed as follow:

Item	Description
Fragment Threshold	Set the Fragment threshold of wireless radio. Threshold. Do not modify default value if you don't know what it is, default value is 2346.
RTS Threshold	Set the RTS threshold of wireless radio. Do not modify default value if you don't know what it is, default value is 2347.
Channel Width	Select the wireless channel width, 20MHz or 40MHz. 40MHz provides better network speed for 802.11n wireless clients.
WMM	Enable or disable Wireless Multi-Media. When enabled, this device will give priority to multimedia related network applications so they will have better performance.
TX Power	Select wireless transmitting power level, from 10% to 100%. When wireless clients are not too far from this wireless repeater, you don't have to select a higher power level, since this may cause some people to try to break into your wireless network when you have a bad password or no password.
Enable LED off mode	You can enable or disable LED lights Check 'Enable LED OFF' mode to setup LED behavior: Turn off all LED: disabled all LED lights.  Turn off all LED except POWER LED: all LED lights will be disabled, except 'POWER' LED.

When you finish settings in this page, click 'Apply' button. You'll see the following message:

**Save settings successfully!**

You may press CONTINUE button to continue configuring other settings or press APPLY button to restart the system to make the changes take effect.

If you still need to configure this device, click ‘CONTINUE’ button; if you want to save changes and make it work now, click ‘APPLY’ button.



You’ll be prompted to wait for 30 seconds before you can reconnect to Web UI of this device.

### 3-2-6 System Utility

You can change the settings of several system-level parameters in this page, including administrator's password, and IP address.

To access 'System Utility' menu, click 'System Utility' on the left.

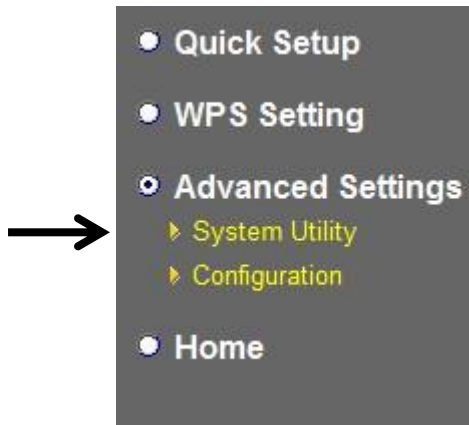

The following setup page will appear:

The screenshot shows a web interface with two main sections. The first section is titled "Password Settings" and contains three input fields: "Current Password", "New Password", and "Re-Enter Password". The second section is titled "Management IP" and contains three input fields: "IP Address" (with the value 192.168.2.253), "Subnet Mask" (with the value 255.255.255.0), and "Gateway Address" (with the value 0.0.0.0).

The description of every setup item is listed as follow:

### **Password Settings**

Default password of this repeater is 1234, and it's displayed on the login prompt when accessed from web browser. There's a security risk if you don't change the default password, since everyone can see it. This is very important when you have wireless function enabled.

Here are descriptions of every setup items:

Item	Description
Current Password	To change password, you have to input current password first.
New Password	Input new password here. You can use the combination of alphabets, number, and symbols for up to 20 characters.
Re-Enter Password	Input new password again for conformation.

## Management IP

To set up the IP address of this wireless repeater, please see the following description.

Item	Description
IP Address	<p>Input the IP address of LAN / Wi-Fi port of this wireless repeater.</p> <p><i>NOTE: Please remember this IP address. If you forget this IP address and you didn't use DHCP server function to assign IP address to clients, you'll not be able to connect to this wireless repeater device and you'll need to clear all settings and password to reset the IP address back to default value '192.168.2.253' on Client mode. ( Press WPS button and hold for 10 seconds to restore all settings to factory defaults)</i></p>
Subnet Mask	Input the subnet mask of the IP address you're using.
Gateway Address	Input the gateway's IP address of your network. Generally you can use '0.0.0.0' (default value) since this wireless repeater will access Internet via WAN port.

When you finish settings in this page, click 'Apply' button. You'll see the following message:

**Save settings successfully!**

You may press CONTINUE button to continue configuring other settings or press APPLY button to restart the system to make the changes take effect.

If you still need to configure this device, click 'CONTINUE' button; if you want to save changes and make it work now, click 'APPLY' button. You'll be prompted to wait for 30 seconds before you can reconnect to Web UI of this device.



### 3-2-7 Configuration

You can backup and restore the configuration of this device, so you can recall all settings back in very short time, without doing configuration again.

This function is especially useful when you need to use this mini Wi-Fi repeater in different places, like home and hotel.

To access 'Configuration' menu, click 'Configuration' on the left.

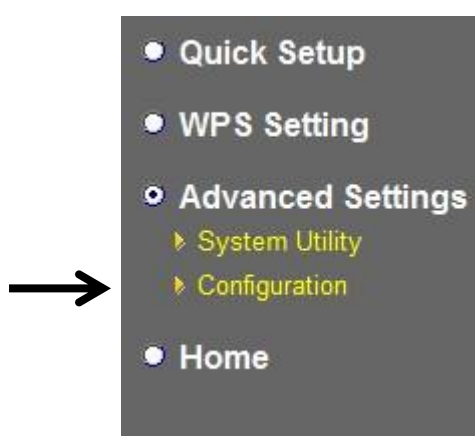

### Configuration Tool

The following setup page will appear:



The description of every setup item is listed as follow:

Item	Description
Backup Settings	Click 'Save' button to save the current settings to a file on your computer.
Restore	If you want to upload a saved configuration file to

Settings	wireless repeater, please click 'Browse' button to select a saved configuration file on your computer. Then click 'Upload' button to restore the current settings to new one.
Reset to Factory Default	<p>To reset all settings of this wireless repeater to factory defaults, including password. You'll be prompted to confirm the settings reset:</p> <div data-bbox="496 600 1350 943" data-label="Image"> </div> <p>Click 'OK' if you really want to restore all settings, or click 'Cancel' to abort.</p>

## WEB Upgrade

The software running in this wireless repeater (i.e. 'Firmwre') can be upgraded to improve the functionality of this wireless repeater.

You can access our website to look for latest firmware file. Then download the latest firmware file and save on your computer and upload to this wireless repeater.

**WEB Upgrade**

This tool allows you to upgrade the Access Point's system firmware. It is recommended that upgrading the firmware from wired stations.

Enter the path and name of the upgrade file and then click the APPLY button below. You will be prompted to confirm the upgrade.

The description of every setup item is listed as follow:

Item	Description
Browse	Select a firmware file saved on your computer.

When you are ready, click 'Apply' button to start firmware upgrade procedure.

## Reset

When you think this wireless repeater is not working properly, resetting it may help.



To reset this wireless repeater, click 'Apply' button. You'll be prompted to confirm reset:

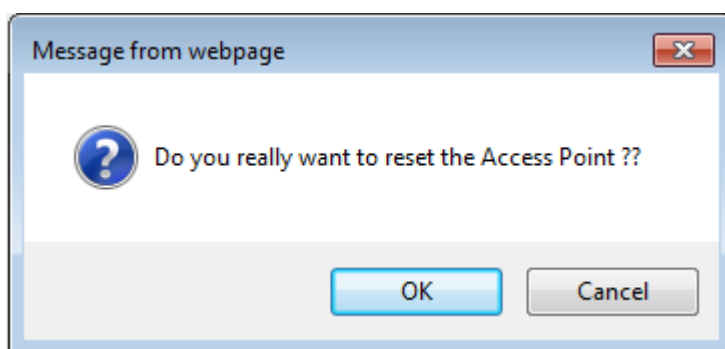

Click 'OK' button to reset wireless repeater, or click 'Cancel' to abort.

## CHAPTER IX: AP mode

You can build a wireless networking environment for home or small office, please switch this device to wireless access point mode and connect it to your wired router. Then your wireless client users can access internet by wirelessly connecting to this AP without wired cable burden.

This chapter will show you how to quickly install this device by using quick setup and show you the each detailed setting on web UI page of AP mode.

### 4-1 AP mode Quick Installation Guide

Switch mode selector to '**AP**'.

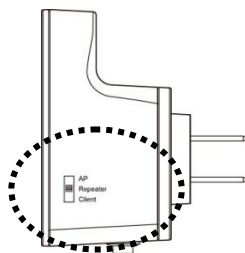

Insert this device into power outlet on the wall, and switch wireless repeater's power switch to '**ON**' (1). You should see '**Power**' LED light up in few seconds (2). If not, please check if the power outlet you're using is working.

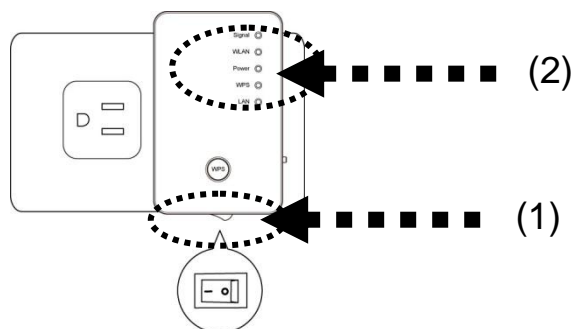

You can build wireless connection via 'Hardware WPS button' or

‘Software web browser’.

If your wireless client also supports ‘WPS button’, we recommend you to use WPS button to establish connection, it is the fast and secure way without computer.

<b>Using WPS button</b>	<b>- please go to section 4-1-1</b>
<b>Using Web browser</b>	<b>- please go to section 4-1-2</b>

## 4-1-1 Hardware WPS button setup

(1) Press **WPS button** twice on repeater, '**WPS**' LED will start flashing.

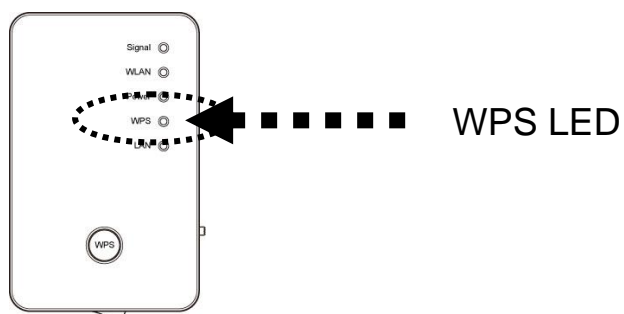
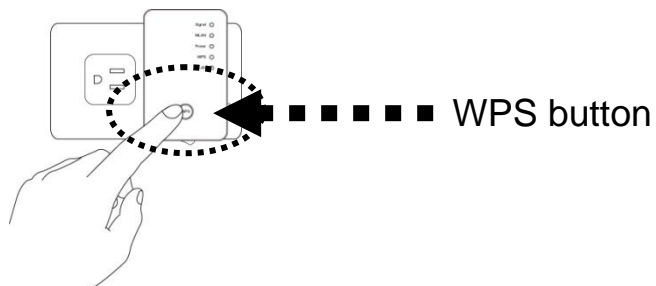

(2) Press **WPS button** on the wireless client you wish to connect within 2 minutes.



**NOTE:** this WPS button position on client card is for example, different device may have different WPS button position.

**TIP:** If your wireless client card does not have hardware WPS button, you can also use its web configuration menu's WPS function to establish connection. Or you can login this repeater web UI to have quick setup (detailed setup refers to '4-1-2 Web browser quick setup' manual)

(3) If WPS connection is successfully established, '**WPS**' LED will light for 5 minutes; if '**WPS**' LED flashes fast, there's something error, please wait for 2 minutes until '**WPS**' LED off, and try from step(1) again.

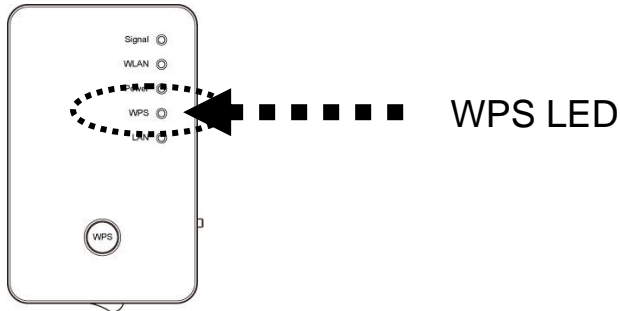

When quick installation is successfully done, '**Signal**' LED will turn on.

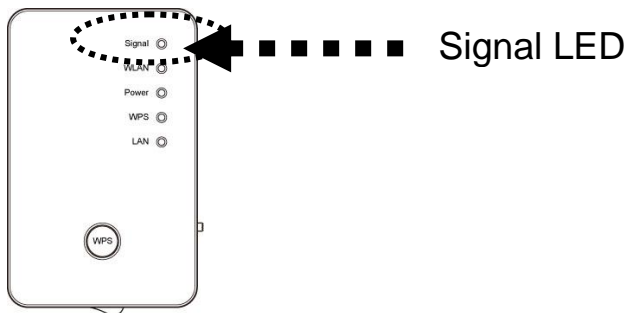

(4) '**Signal**' LED in AP mode is Steady light to provide wireless clients the best signal.

(5) Connect this access point to ADSL modem, wired router, or switch/hub in your network through the LAN port of the access point by Ethernet cable.

The quick installation setup is completely done, you can refer to '4-2 AP mode Advanced Settings' to login in web UI for other advanced settings.

## 4-1-2 Web browser quick setup

Before you can connect to the repeater and start configuration procedures, your computer must be able to get an IP address automatically (use dynamic IP address). If it's set to use static IP address, or you're unsure, please refer to '*Chapter X: Appendix, 5-1 Configuring TCP/IP on PC*' to set your computer to use dynamic IP address.

(1) Use Ethernet cable to connect your computer's Ethernet port and wireless repeater's Ethernet port.

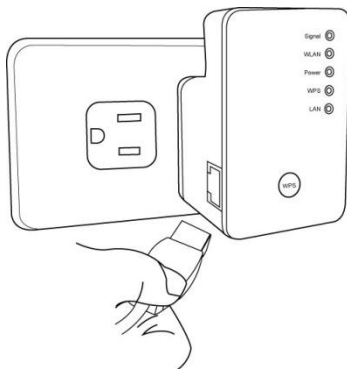

Or use your computer's wireless configuration utility to search for access point named '**repeater**' and get connected. (The default SSID of this repeater device is 'repeater')

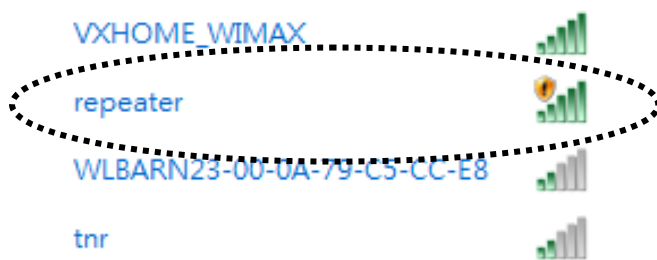

(2) Open web browser and input '**http://repeater**' in address bar. (or you can input the default IP address '192.168.2.1')



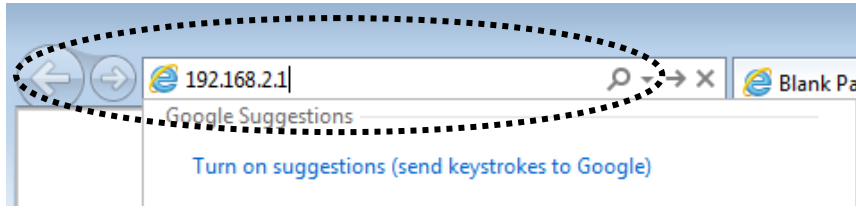

(3) Wireless repeater will prompt you to input username and password. Default username is '**admin**' and password is '**1234**'. Click 'OK' button to continue.

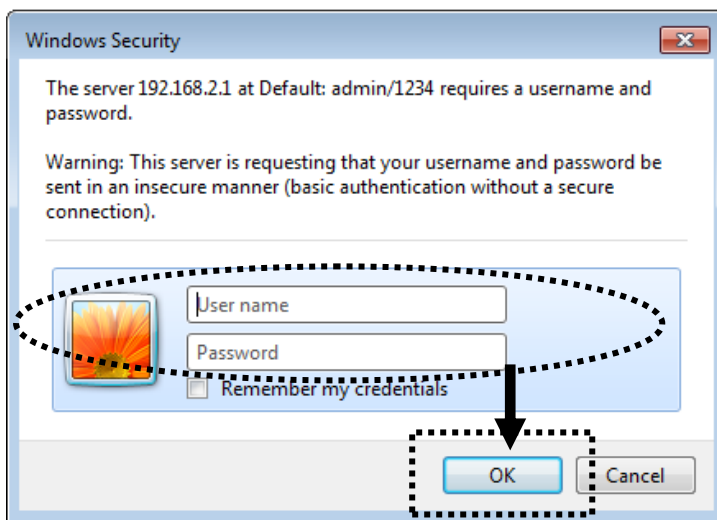

(4) Please input a SSID (a name used to identify this access point) in 'Device SSID' field, then click 'Next' button. Default SSID is repeater, you can change this default SSID if you want.

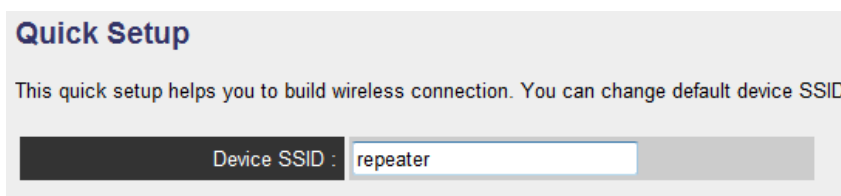

(5) Select security type of wireless link:  
Encryption: Disable (no security), WEP, WPA pre-shared key, or WPA RADIUS

**Security**

Please input wireless security key of your connected Access Point.

Encryption :	WPA pre-shared key ▾
WPA Unicast Cipher Suite :	<input checked="" type="radio"/> WPA(TKIP) <input type="radio"/> WPA2(AES) <input type="radio"/> WPA2 Mixed
Pre-shared Key Format :	Passphrase ▾
KEY :	<input type="text"/>

**Note: WEP encryption: Select key length (64 or 128bit), key format (Hex or ASCII characters), Default Tx Key (usually use 'Key 1'), and input key characters (refer to 'Key Format' you selected for number of characters)**

**WPA pre-shared key: Select one WPA Unicast Cipher Suite (usually use default setting 'WPA(TKIP)'), Pre-shared Key Format: Passphrase (alphanumeric characters) or Hex (64 Hex Characters), and input key characters in 'KEY' field.**

(6) Please recheck settings you made, and click 'Apply' to continue.

**Save settings successfully!**

Please press APPLY button to restart the system to make the changes take effect.

device SSID : **repeater**

Security : **Disable**

(7) Please wait for few seconds for device to reboot.

**System Restarting! Please wait for a while !**

21%

(8) After reboot complete, web browser will login access point's home page of Web UI. You can close browser to finish this quick setup and connect this access point to ADSL modem, wired router, or switch/hub in your network through the LAN port of the access point by Ethernet cable.

**NOTE: After quick installation is successfully finished and you want to login Web UI of repeater, please refer to '5-2 AP mode Advanced Settings' for more functions or learn how to login web UI again.**

## 4-2 AP mode Advanced Settings

### 4-2-1 Setup IP address

Default IP address of this device in AP mode is **192.168.2.1**, please make sure your PC's IP is within the range of 192.168.2.2~192.168.2.252.

Before you can login web UI, you can set your computer's IP address to any IP within this subnet. If you don't know how to do this, please refer to following instructions.

*Windows XP IP address setup:*

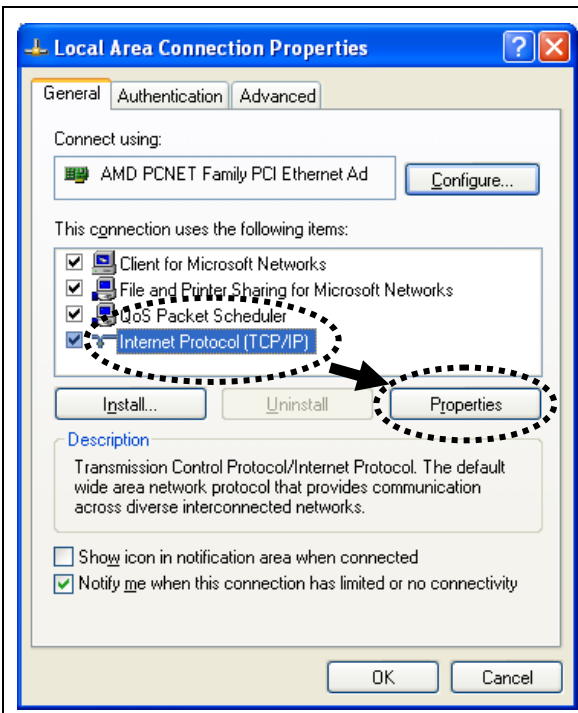
	<p>Click 'Start' button (it should be located at lower-left corner of your computer), then click control panel. Double-click <b>Network and Internet Connections</b> icon, click <b>Network Connections</b>, and then double-click <b>Local Area Connection, Local Area Connection Status</b> window will appear, and then click 'Properties'</p>
--	---

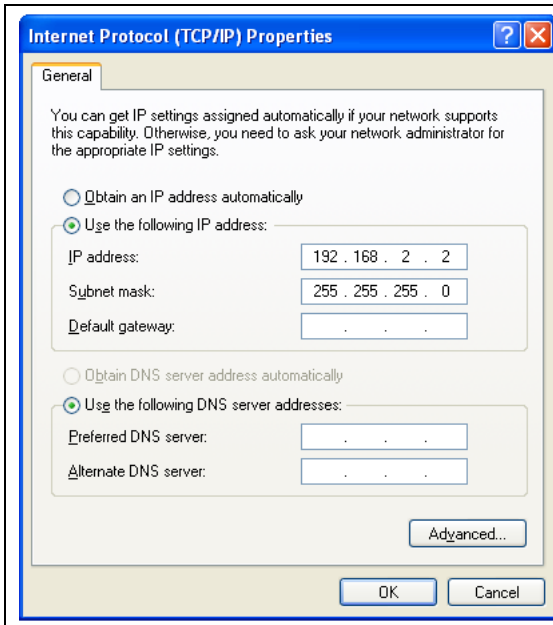

Select 'Use the following IP address', then input the following settings in respective field:

IP address: 192.168.2.x (where x is an integer greater or less than 200, if there's more than one computer need to use this wireless presentation gateway on the same network, every computer should use an unique number)  
 Subnet Mask: 255.255.255.0  
 Click 'OK' when finish.

*Windows Vista/7 IP address setup:*

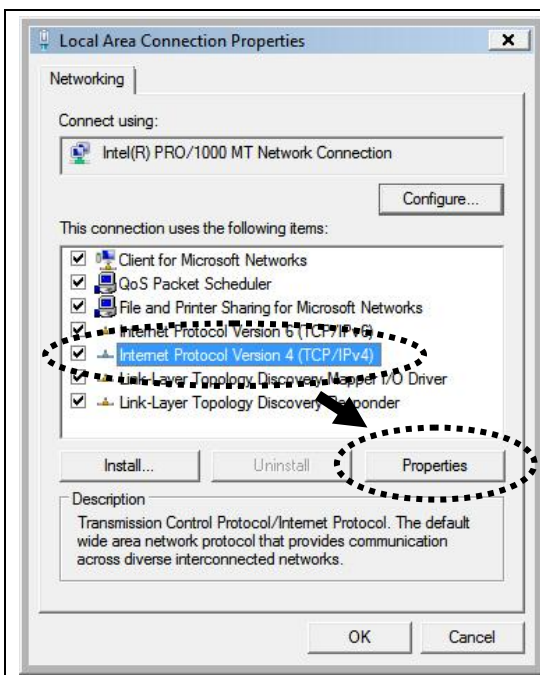

Click 'Start' button (it should be located at lower-left corner of your computer), then click control panel. Click **View Network Status and Tasks**, then click **Manage Network Connections..** Right-click **Local Area Network**, then select **'Properties'**. **Local Area Connection Properties** window will appear, select 'Internet Protocol Version 4 (TCP / IPv4)', and then click 'Properties'

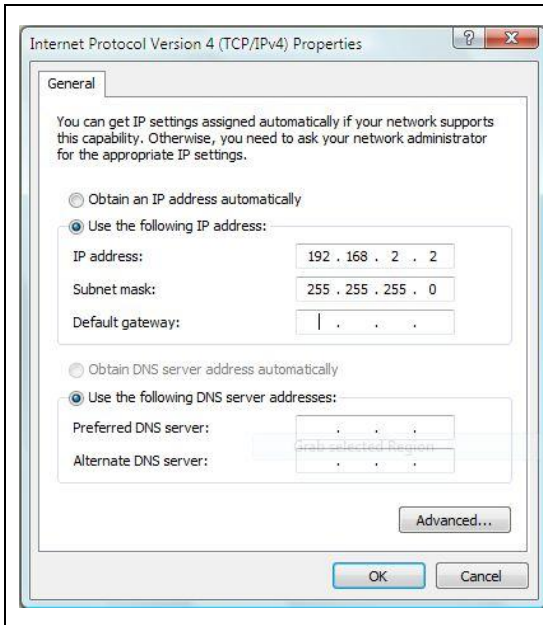

Select 'Use the following IP address', then input the following settings in respective field:

IP address: 192.168.2.x (where x is an integer greater or less than 200, if there's more than one computer need to use this wireless presentation gateway on the same network, every computer should use an unique number)

Subnet Mask: 255.255.255.0

Click 'OK' when finish.

## 4-2-2 Connect to web configuration menu

Please open web browser (IE, firefox, chrome etc.) and input **192.168.2.1** in address bar then press ENTER key:

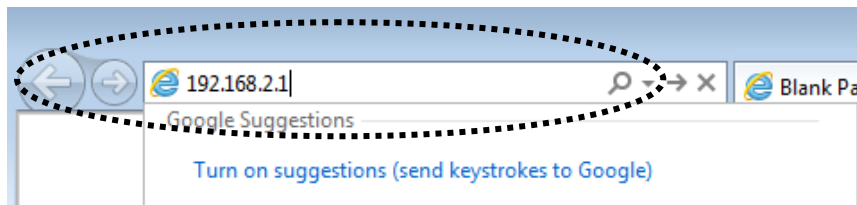

Wireless repeater will prompt you to input username and password. Default username is '**admin**' and password is '**1234**'. Click 'OK' button to continue.

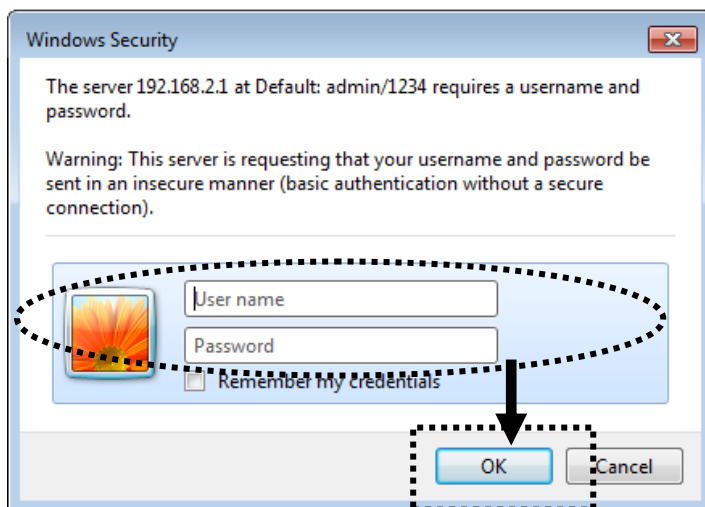

You should be able to see the configuration manual of this Access Point mode in very short time:

Detailed operation instructions will be given to following manual.

### 4-2-3 Home

The status and information of this access point will be displayed here.

To access 'Home' menu, click 'Home' on the left.

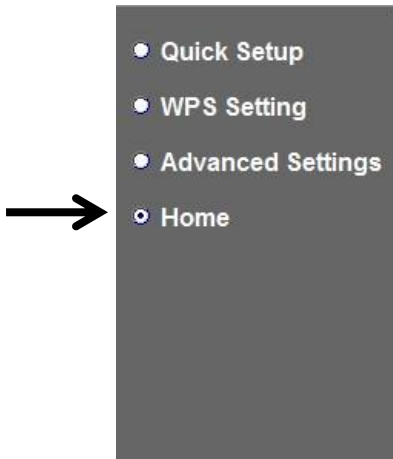

You should see the screen looks like this (the contents will vary depending on your actual setting):

System	
Uptime	0day:0h:6m:48s
Hardware Version	Rev. A
Runtime Code Version	1.02d
Wireless Configuration	
Mode	AP
ESSID	repeater
Channel Number	10
Security	WEP
BSSID(MAC)	80:1f:02:00:00:03
Associated Clients	0 <input type="button" value="Show Active Clients"/>
LAN Configuration	
IP Address	192.168.2.1
Subnet Mask	255.255.255.0
Default Gateway	0.0.0.0
MAC Address	80:1f:02:00:00:03



You can click 'Show Active Clients' button to show all connected wireless clients.

***Please note: By clicking 'Show Active Clients' button, a new browser window will appear. If your browser prevents pop-up window from appearing, please disable this function or you will not be able to use 'Show Client' function.***

#### 4-2-4 WPS Setting

You can configure WPS (Wi-Fi Protected Setup) here. By using WPS, you can establish secure connection between this wireless repeater with other wireless devices which also support WPS in a fast and secure manner.

To access 'WPS Setting' menu, click 'WPS Settings' on the left.



The following setup page will appear:

Enable WPS

- **Wi-Fi Protected Setup Information**

WPS Status:	Configured
Self PinCode:	35544357
SSID:	repeater
Authentication Mode:	WEP
Passphrase Key:	
- **Device Configure**

Config Mode:	Registrar ▼
Configure via Push Button:	Start PBC
Input client PIN code :	<input type="text"/> Start PIN

The description of every setup item is listed as follow:

Item	Description
Enable WPS	You can enable or disable WPS function. Disabling WPS function is included hardware WPS button function. Default is 'enable WPS'.
WPS Status	Shows the security setting status of WPS. You must setup the security setting of this wireless repeater manually and the WPS status will become 'Configured'. Currently only WPA encryption is supported, if you select other encryption method, WPS status will remain 'Unconfigured'.
Self PinCode	Here displays an 8-digit number for WPS PIN-style configuration. When other WPS-compatible device wish to connect to this wireless repeater and supports Self-PIN type WPS, input this number to the wireless device to establish connection.
SSID	Shows the SSID of this wireless access point.
Authentication Mode	Shows the authentication mode of this wireless access point.

Passphrase Key	Here shows asterisks (*) to indicate wireless security is properly set.
Config Mode	There are 'Registrar' and 'Enrollee' modes for the WPS connection. When 'Registrar' is enabled, the wireless clients will follow the access point's wireless settings for WPS connection. When 'Enrollee' mode is enabled, the access point will follow the wireless settings of wireless router for WPS connection.
Start PBC	Click 'Start PBC' to start Push-Button style WPS setup procedure. This wireless repeater will wait for WPS requests from another wireless device for 2 minutes. The 'WPS' LED on this device will be blinking for 2 minutes when this access point is waiting for incoming WPS request.
Start PIN	Please input the PIN code of the wireless client you wish to connect, and click 'Start PIN' button. The 'WPS' LED on the wireless repeater will be blinking when this wireless repeater is waiting for incoming WPS request.

**NOTE: For WPS2.0 compliance specification, WEP and WPA-PSK can't support WPS connection, some of wireless devices may follow this latest WPS2.0 specification, so we recommend you not to use WEP and WPA-PSK to avoid WPS interoperability problem.**

## 4-2-5 Advanced Settings

You can configure advanced wireless settings in this page. Please note that these settings are not safe to be configured by novice users. Configure these settings only when you understand what you're doing.

To access 'Advanced Setting' menu, click 'Advanced Setting' on the left.



The following setup page will appear:

Fragment Threshold:	<input type="text" value="2346"/>	(256-2346)
RTS Threshold:	<input type="text" value="2347"/>	(0-2347)
Beacon Interval:	<input type="text" value="100"/>	(20- 1024 ms)
DTIM Period:	<input type="text" value="3"/>	(1-10)
Data Rate:	Auto ▾	
N Data Rate:	Auto ▾	
Channel Width:	<input checked="" type="radio"/> Auto 20/40 MHz <input type="radio"/> 20 MHz	
Preamble Type:	<input checked="" type="radio"/> Short Preamble <input type="radio"/> Long Preamble	
Broadcast ESSID:	<input checked="" type="radio"/> Enable <input type="radio"/> Disable	
WMM:	<input type="radio"/> Enable <input checked="" type="radio"/> Disable	
CTS Protect:	<input checked="" type="radio"/> Auto <input type="radio"/> Always <input type="radio"/> None	
TX Power:	100 % ▾	

Enable LED OFF mode  
 Turn off all LED  
 Turn off all LED except POWER LED

The description of every setup item is listed as follow:

Item	Description
Fragment Threshold	Set the Fragment threshold of wireless radio. Threshold. Do not modify default value if you don't know what it is, default value is 2346.
RTS Threshold	Set the RTS threshold of wireless radio. Do not modify default value if you don't know what it is, default value is 2347.
Beacon Interval	Set the beacon interval of wireless radio. Do not modify default value if you don't know what it is, default value is 100.
DTIM Period	Configures DTIM (Delivery Traffic Indication Message) send period. Default value is 3.
Data Rate	Select wireless data transfer speed. When you select a value here, this repeater will refuse to establish connection with wireless clients by

	<p>other speed.</p> <p>It's recommended to select 'Auto' and this wireless repeater will adjust the speed automatically.</p>
N Data Rate	<p>Select wireless data transfer speed by MCS0 to MCS7. MCS stands for Modulation and Coding Scheme, which represents different speed when bandwidth is 20MHz or 40MHz.</p> <p>It's recommended to select 'Auto' and this wireless repeater will adjust the speed automatically.</p>
Channel Width	<p>Select the wireless channel width, 20MHz or 40MHz. 40MHz provides better network speed for 802.11n wireless clients.</p> <p>However, if there're 802.11b / g clients connecting to this wireless repeater, it will switch to 20MHz mode automatically.</p>
Preamble Type	<p>Set the type of preamble of wireless radio, Do not modify default value if you don't know what it is, default setting is 'Short Preamble'.</p>
Broadcast ESSID	<p>When set to 'enabled', every wireless devices can scan and found this wireless repeater; when set to 'disabled', only wireless clients who know exact SSID can get connected with this wireless repeater. Set to disabled will help to improve security.</p>
WMM	<p>Enable or disable Wireless Multi-Media. When enabled, wireless repeater will give priority to multimedia related network applications so they will have better performance.</p>
CTS Protect	<p>This function provides CTS (Clear to Send) protection when transferring data. It's recommended to select 'Auto' for this option.</p>
TX Power	<p>Select wireless transmitting power level, from 10% to 100%. When wireless clients are not too far from this wireless repeater, you don't have to</p>

	select a higher power level, since this may cause some people to try to break into your wireless network when you have a bad password or no password.
Enable LED off mode	<p>You can enable or disable LED lights</p> <p>Check <b>‘Enable LED OFF’</b> mode to setup LED behavior:</p> <p>Turn off all LED: disabled all LED lights</p> <p>Turn off all LED except POWER LED: all LED lights will be disabled, except ‘POWER’ LED</p>

When you finish settings in this page, click ‘Apply’ button. You’ll see the following message:

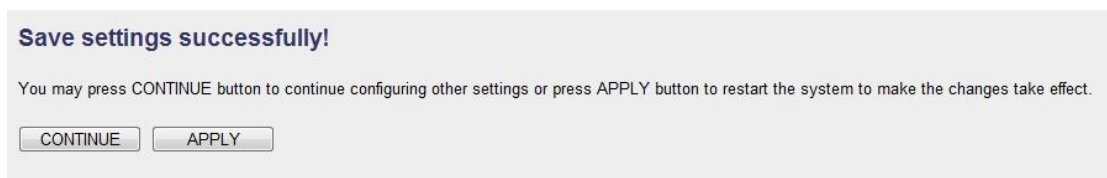

If you still need to configure this wireless repeater, click ‘CONTINUE’ button; if you want to save changes and make it work now, click ‘APPLY’ button.

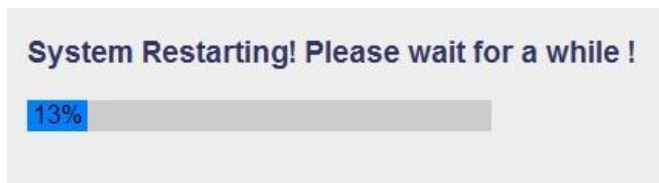

You’ll be prompted to wait for 30 seconds before you can reconnect to Web UI of this access point.



## 4-2-6 MAC Address Filtering

Besides using wireless security to only allow permitted wireless users to use this wireless access point, you can also use MAC address filter to allow wireless users with certain MAC address to use this access point.

This will enhance security because you can make a 'white list' to allow users on the list to use this wireless repeater only in advance. For those clients who don't list on this white list can't get connected, even he or she know the password.

To access 'MAC Filtering' menu, click 'MAC Filtering' on the left.

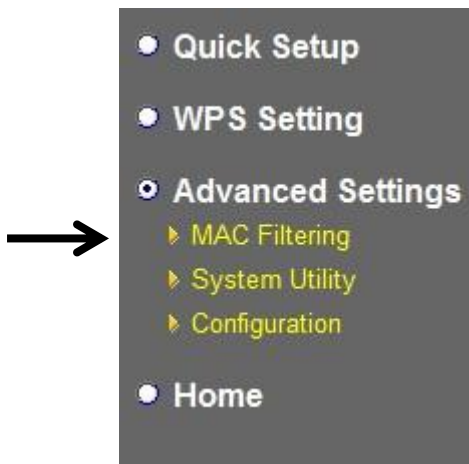

The following setup page will appear:

• **MAC Address Filtering Table**  
It allows to entry 20 sets address only.

NO.	MAC Address	Comment	Select
1	11:22:33:44:55:66	Allowed client	<input type="checkbox"/>

**Enable Wireless Access Control**

MAC Address: 
 Comment:

The description of every setup item is listed as follow:

Item	Description
Enable Wireless Access Control	Check this box to enable MAC filtering. If you didn't check this box, anyone who knows the wireless password can get connected to this access point.
MAC Address	Input the MAC address of the clients you wish to deny or accept to access this AP into the MAC address list. Please input 12 HEX characters here, and you don't have to add : (colon) or - (dash) characters every 2 characters.  <i>If you don't know how to get the MAC address of a network client, see tips below.</i>
Comment	Input any descriptive text about this rule, so you can remember the purpose of this rule. You can input up to 20 alphanumerical characters in this field.
Add	Add this MAC address to the list.
Clear	Clear 'MAC Address' and 'Comment' field.
Delete Selected	Delete MAC address(es) you selected which

	'Select' box is checked.
Delete All	Delete all MAC addresses in the list. You'll be prompted to confirm deletion first.
Reset	Uncheck all checked boxes.
Select	All existing MAC addresses will be listed here. To delete a MAC address from the list, check the box of the MAC address you wish to delete first. You can select more than one MAC addresses here.

When you finish settings in this page, click 'Apply' button. You'll see the following message:

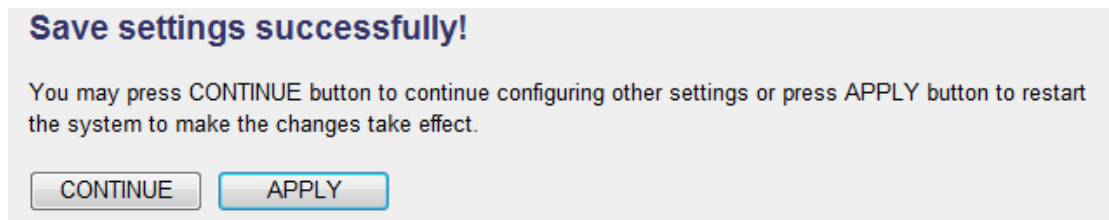

If you still need to configure this wireless repeater, click 'CONTINUE' button; if you want to save changes and make it work now, click 'APPLY' button. You'll be prompted to wait for 30 seconds before you can reconnect to this access point.

TIPS: If you don't know the MAC address of your computer or wireless device, you can follow the following procedure:

For wireless devices and computers which are connected to this wireless repeater already, you can click 'Show Active Clients' button in 'Home' setting page.

Wireless Configuration	
Mode	AP
ESSID	repeater
Channel Number	10
Security	WEP
BSSID(MAC)	80:1f:02:00:00:03
Associated Clients	0 <input type="button" value="Show Active Clients"/>

Their MAC address will be displayed at 'MAC Address' field.



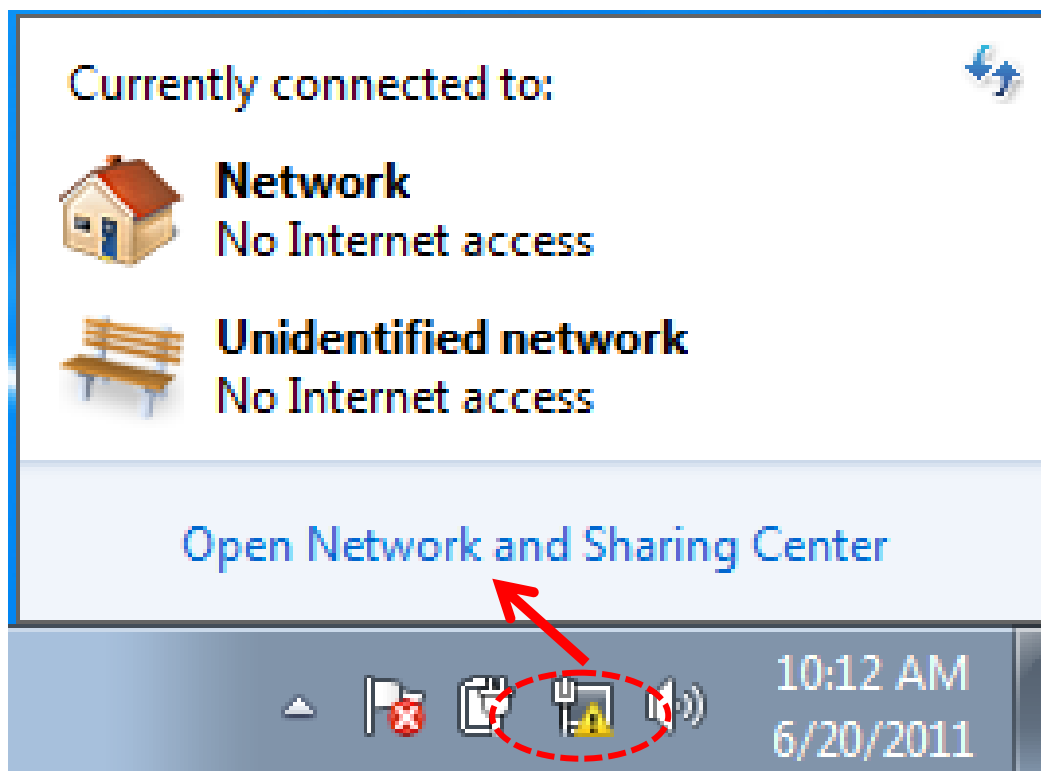

If you still can't identify the MAC address of computer, you can follow the following procedure:

Click the network icon located at the lower-right corner, then click 'Open Network and Sharing Center'.







Click the connection that you'll be used to connect the wireless AP (in this example, 'Local Area Connection'):

View your basic network information and set up connections 

    [See full map](#)

 ALBERT-VMPC  
(This computer)      Multiple networks      Internet

View your active networks [Connect or disconnect](#)

 <b>Network</b> Home network	Access type: No Internet access HomeGroup: <a href="#">Joined</a> Connections:  <a href="#">Local Area Connection</a>
 <b>Unidentified network</b> Public network	Access type: No Internet access Connections:  <a href="#">Local Area Connection 2</a>

Click 'Details...' button.

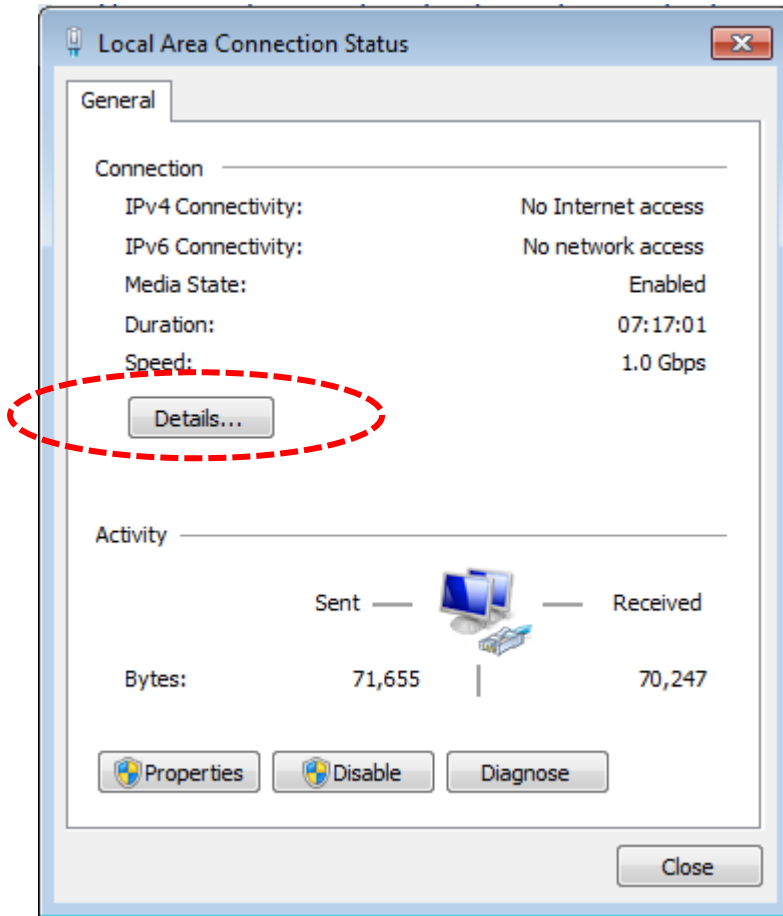

The MAC address of selected network connection will be displayed here as 'Physical Address'.

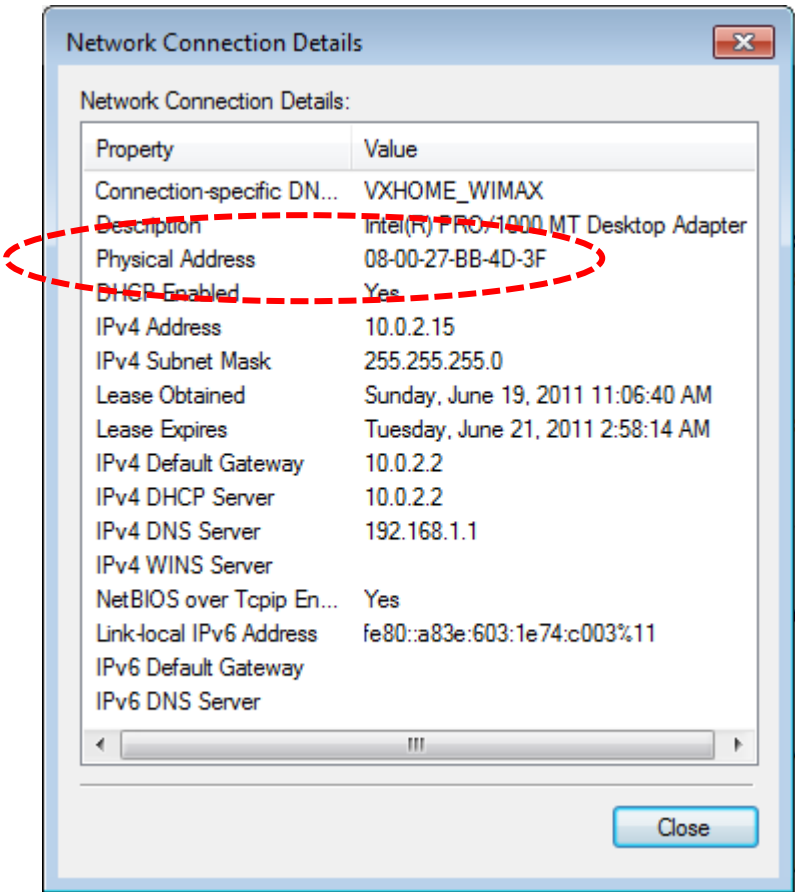

## 4-2-7 System Utility

You can change the settings of several system-level parameters in this page, including administrator's password, and IP address.

To access 'System Utility' menu, click 'System Utility' on the left.

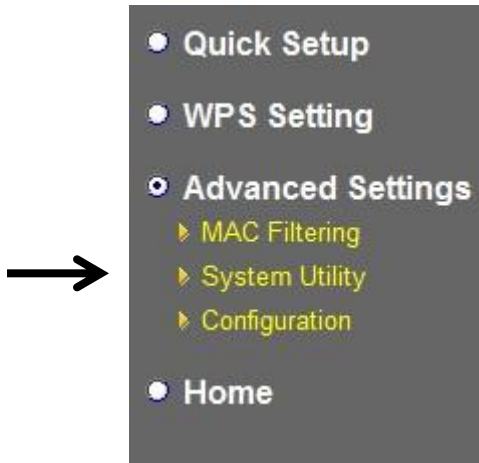



The following setup page will appear:

The image shows a web-based configuration interface for a repeater, divided into three main sections:

- Password Settings**
  - Current Password :
  - New Password :
  - Re-Enter Password :
- Management IP**
  - IP Address :
  - Subnet Mask :
  - Gateway Address :
- DHCP Server**
  - DHCP Server :  ▼
  - Default Gateway IP :
  - Domain Name Server IP :
  - Start IP :
  - End IP :
  - Domain Name :
  - Lease Time :  ▼

The description of every setup item is listed as follow:

### **Password Settings**

Default password of this repeater is 1234, and it's displayed on the login prompt when accessed from web browser. There's a security risk if you don't change the default password, since everyone can see it. This is very

important when you have wireless function enabled.

Here are descriptions of every setup items:

Item	Description
Current Password	To change password, you have to input current password first.
New Password	Input new password here. You can use the combination of alphabets, number, and symbols for up to 20 characters.
Re-Enter Password	Input new password again for conformation.

## Management IP

To set up the IP address of this wireless repeater, please see the following description.

Item	Description
IP Address	<p>Input the IP address of LAN / Wi-Fi port of this access point.</p> <p><i>NOTE: Please remember this IP address. If you forget this IP address and you didn't use DHCP server function to assign IP address to clients, you'll not be able to connect to this device and you'll need to clear all settings and password to reset the IP address back to default value '192.168.2.1'.( Press WPS button and hold for 10 seconds to restore all settings to factory defaults)</i></p>
Subnet Mask	Input the subnet mask of the IP address you're using.
Gateway Address	Input the gateway's IP address of your network. Generally you can use '0.0.0.0' (default value) since this wireless repeater will access Internet via WAN port.

## DHCP Server

This wireless access point is capable to act as a DHCP server for your network, and it's disabled by default. If you want to activate this function, please select 'Enabled' in 'DHCP Server' option, and see next detailed instructions; if you don't want to use DHCP server function of this wireless access point, or there's another DHCP server on the network this access point connects to, please select 'Disable'.

**NOTE: If you select 'Disable' in 'DHCP Server' option, all DHCP-related fields will be grayed out, and you will not be able to input any DHCP parameter.**

Here are descriptions of every setup item:

<i>Default Gateway IP</i>	<i>Please input the IP address of default gateway of your network here.</i>
<i>Domain Name Server IP</i>	<i>Please input the IP address of domain name server (DNS) here.</i>
<i>Start IP</i>	<i>Please input the start IP address of the IP range.</i>
<i>End IP</i>	<i>Please input the end IP address of the IP range.</i>
<i>Domain Name</i>	<i>If you wish, you can also optionally input the domain name for your network. This is optional.</i>
<i>Lease Time</i>	<i>Please choose a lease time (the duration that every computer can keep a specific IP address) of every IP address assigned by this access point from dropdown menu.</i>

When you finish settings in this page, click ‘Apply’ button. You’ll see the following message:

**Save settings successfully!**

You may press CONTINUE button to continue configuring other settings or press APPLY button to restart the system to make the changes take effect.

If you still need to configure this wireless repeater, click ‘CONTINUE’ button; if you want to save changes and make it work now, click ‘APPLY’ button. You’ll be prompted to wait for 30 seconds before you can reconnect to this device.

## 4-2-8 Configuration

You can backup and restore the configuration of this access point, so you can recall all settings back in very short time, without doing configuration again.

This function is especially useful when you need to use this mini Wi-Fi AP in different places, like home and hotel.

To access 'Configuration' menu, click 'Configuration' on the left.

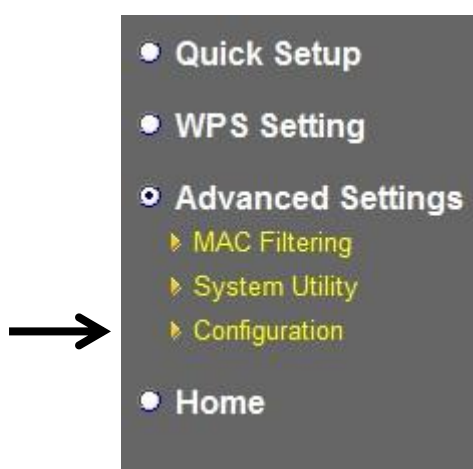

## Configuration Tool

The following setup page will appear:

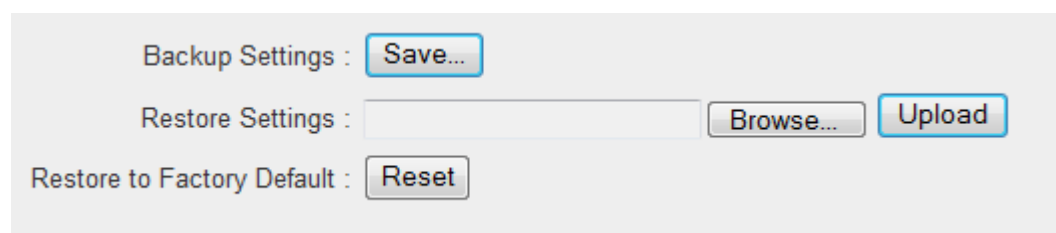

The description of every setup item is listed as follow:

Item	Description
Backup Settings	Click 'Save' button to save the current settings to a file on your computer.

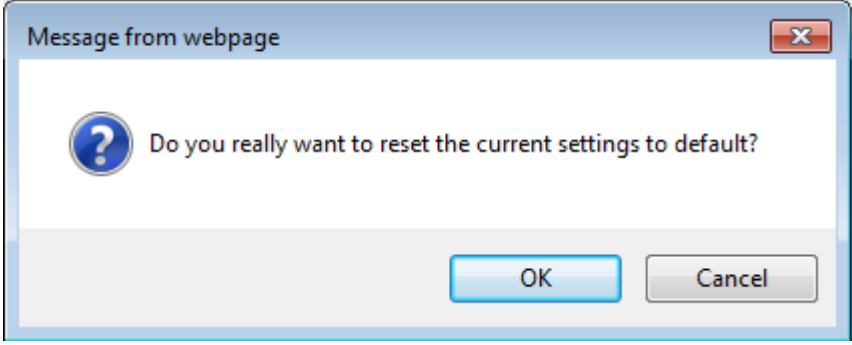
Restore Settings	If you want to upload a saved configuration file to this device, please click 'Browse' button to select a saved configuration file on your computer. Then click 'Upload' button to restore the current settings to new one.
Reset to Factory Default	<p>To reset all settings of this device to factory defaults, including password. You'll be prompted to confirm the settings reset:</p> <div data-bbox="496 600 1350 943" style="border: 1px solid gray; padding: 10px; margin: 10px 0;">  </div> <p>Click 'OK' if you really want to restore all settings, or click 'Cancel' to abort.</p>

## WEB Upgrade

The software running in this device (i.e. 'Firmwre') can be upgraded to improve the functionality of this access point.

You can access our website to look for latest firmware file. Then download the latest firmware file and save on your computer and upload to this wireless AP.

**WEB Upgrade**

This tool allows you to upgrade the Access Point's system firmware. It is recommended that upgrading the firmware from wired stations.  
Enter the path and name of the upgrade file and then click the APPLY button below. You will be prompted to confirm the upgrade.

The description of every setup item is listed as follow:

Item	Description
Browse	Select a firmware file saved on your computer.

When you are ready, click 'Apply' button to start firmware upgrade procedure.

## Reset

When you think this wireless AP is not working properly, resetting it may help.



To reset this wireless repeater, click 'Apply' button. You'll be prompted to confirm reset:

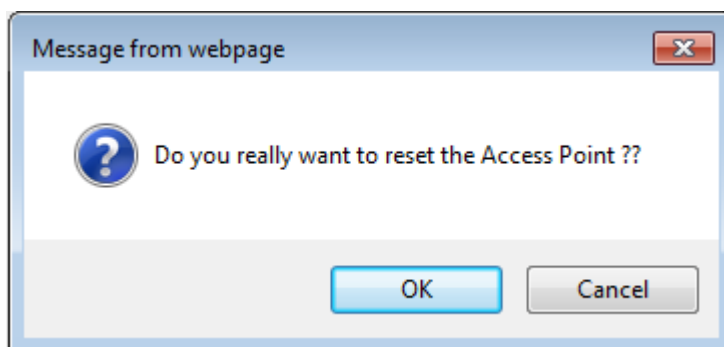

Click 'OK' button to reset wireless repeater, or click 'Cancel' to abort.

## Chapter X: Appendix

### 5-1 Configuring TCP/IP on PC

#### 5-1-1 Windows XP IP address setup:

1. Click 'Start' button (it should be located at lower-left corner of your computer), then click control panel. Double-click *Network and Internet Connections* icon, click *Network Connections*, then double-click *Local Area Connection*, *Local Area Connection Status* window will appear, and then click 'Properties'

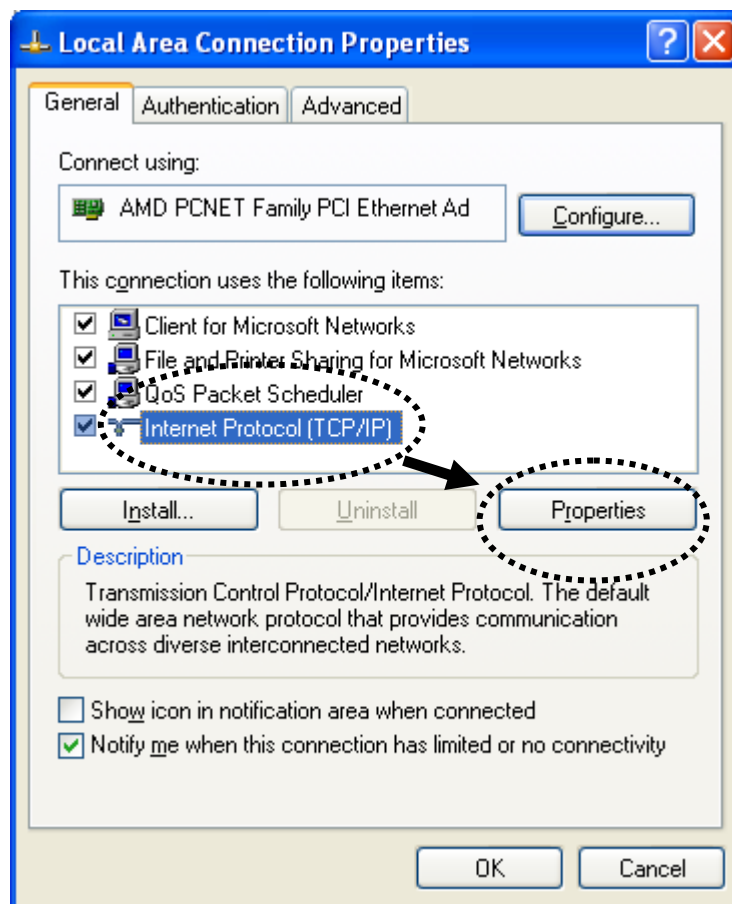

2. Select 'Obtain an IP address automatically' and 'Obtain DNS server address automatically', then click 'OK'.



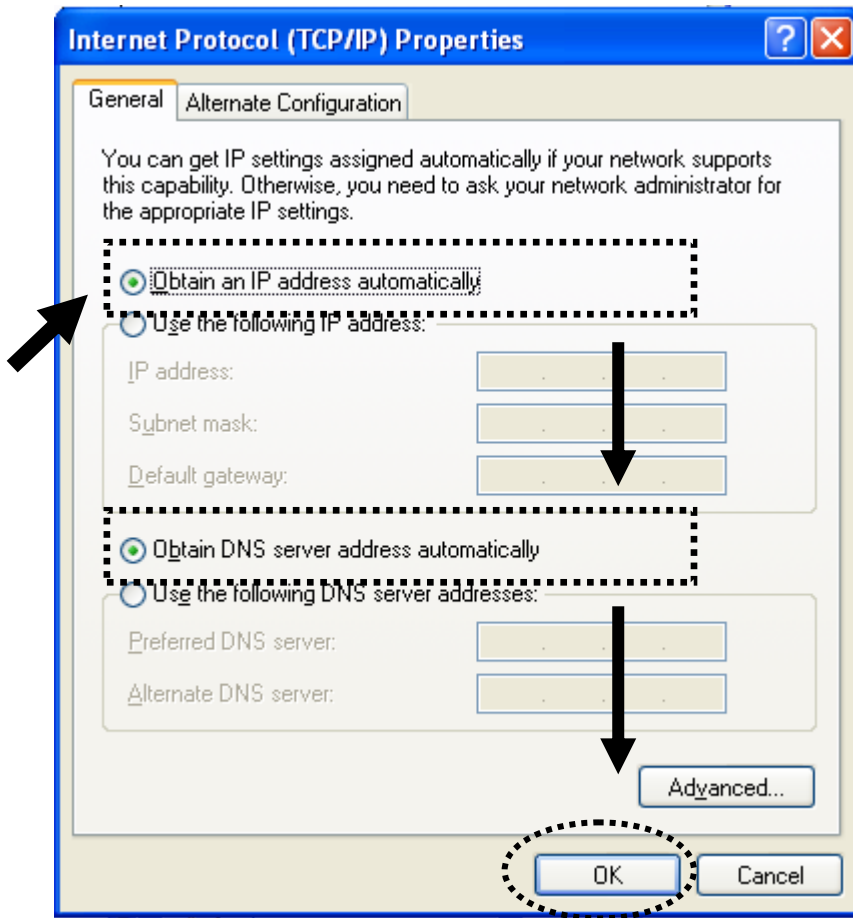

### ***5-1-2 Windows Vista/Windows 7 IP address setup:***

1. Click 'Start' button (it should be located at lower-left corner of your computer), then click control panel. Click ***View Network Status and Tasks***, and then click ***Manage Network Connections***. Right-click ***Local Area Network***, then select ***'Properties'***. ***Local Area Connection Properties*** window will appear, select 'Internet Protocol Version 4 (TCP / IPv4)', and then click 'Properties'

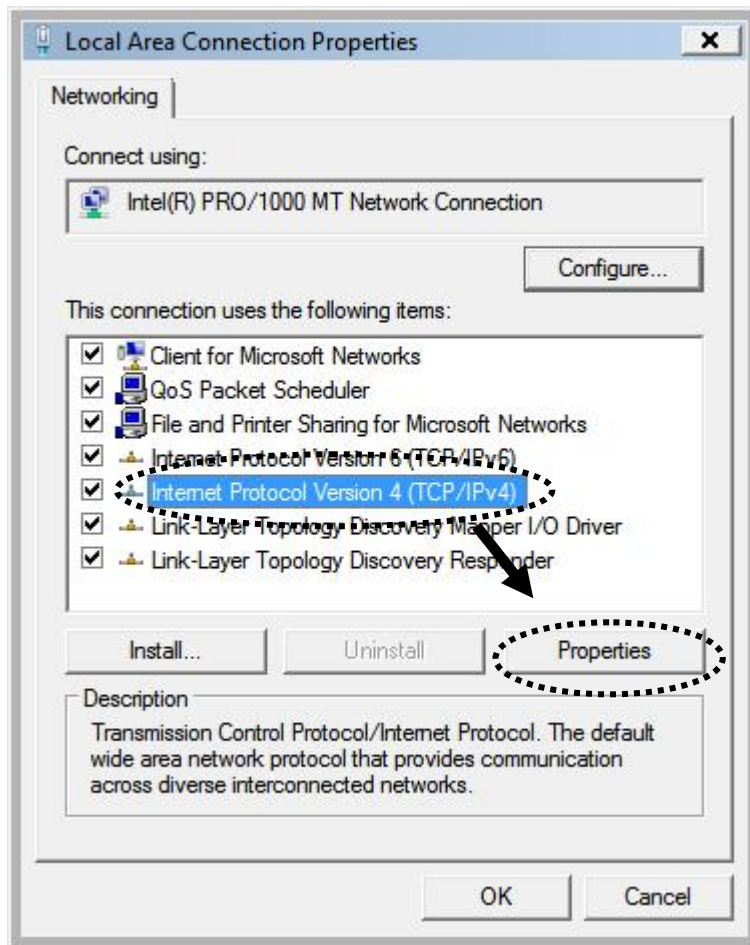

2. Select 'Obtain an IP address automatically' and 'Obtain DNS server address automatically', then click 'OK'.

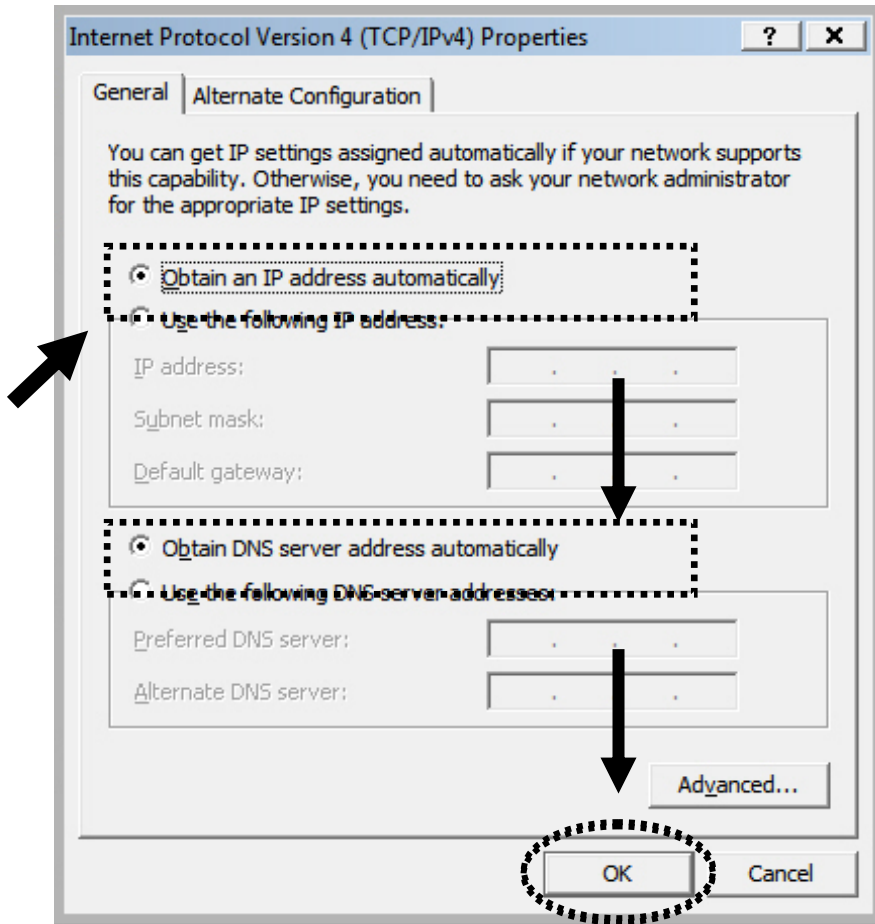

## 5-2 Specification

SoC + RF: Realtek RTL8196CS+ RTL8192CE

Flash: 2MB

SDRAM: 16MB

LAN Port: 10/100M UTP Port x 1

Power: 5VDC, 1A Switching Power Module Inside

Dimension: 46.5(W) x 73(H) x 41(D) mm excluding power plug

Transmit Power: 11n: 13dBm±1.5dBm, 11g: 14dBm±1.5dBm, 11b: 17dBm±1.5dBm

Temperature: 32~104°F (0 ~ 40°C)

Humidity: 10-90% (NonCondensing)

Certification: FCC, CE

## 5-3 Glossary

### 1. What is the IEEE 802.11g standard?

802.11g is the new IEEE standard for high-speed wireless LAN communications that provides for up to 54 Mbps data rate in the 2.4 GHz band. 802.11g is quickly becoming the next mainstream wireless LAN technology for the home, office and public networks. 802.11g defines the use of the same OFDM modulation technique specified in IEEE 802.11a for the 5 GHz frequency band and applies it in the same 2.4 GHz frequency band as IEEE 802.11b. The 802.11g standard requires backward compatibility with 802.11b.

The standard specifically calls for:

- A. A new physical layer for the 802.11 Medium Access Control (MAC) in the 2.4 GHz frequency band, known as the extended rate PHY (ERP). The ERP adds OFDM as a mandatory new coding scheme for 6, 12 and 24 Mbps (mandatory speeds), and 18, 36, 48 and 54 Mbps (optional speeds). The ERP includes the modulation schemes found in 802.11b including CCK for 11 and 5.5 Mbps and Barker code modulation for 2 and 1 Mbps.
- B. A protection mechanism called RTS/CTS that governs how 802.11g devices and 802.11b devices interoperate.

### 2. What is the IEEE 802.11b standard?

The IEEE 802.11b Wireless LAN standard subcommittee, which formulates the standard for the industry. The objective is to enable wireless LAN hardware from different manufactures to communicate.

### 3. What does IEEE 802.11 feature support?

The product supports the following IEEE 802.11 functions:

- CSMA/CA plus Acknowledge Protocol
- Multi-Channel Roaming
- Automatic Rate Selection
- RTS/CTS Feature
- Fragmentation
- Power Management

### 4. What is Ad-hoc?

An Ad-hoc integrated wireless LAN is a group of computers, each has a Wireless LAN card, Connected as an independent wireless LAN. Ad hoc wireless LAN is applicable at a departmental scale for

a branch or SOHO operation.

**5. What is Infrastructure?**

An integrated wireless and wireless and wired LAN is called an Infrastructure configuration. Infrastructure is applicable to enterprise scale for wireless access to central database, or wireless application for mobile workers.

**6. What is BSS ID?**

A specific Ad hoc LAN is called a Basic Service Set (BSS). Computers in a BSS must be configured with the same BSS ID.

**7. What is WEP?**

WEP is Wired Equivalent Privacy, a data privacy mechanism based on a 40 bit shared key algorithm, as described in the IEEE 802 .11 standard.

**8. What is TKIP?**

TKIP is a quick-fix method to quickly overcome the inherent weaknesses in WEP security, especially the reuse of encryption keys. TKIP is involved in the IEEE 802.11i WLAN security standard, and the specification might be officially released by early 2003.

**9. What is AES?**

AES (Advanced Encryption Standard), a chip-based security, has been developed to ensure the highest degree of security and authenticity for digital information, wherever and however communicated or stored, while making more efficient use of hardware and/or software than previous encryption standards. It is also included in IEEE 802.11i standard. Compare with AES, TKIP is a temporary protocol for replacing WEP security until manufacturers implement AES at the hardware level.

**10. Can Wireless products support printer sharing?**

Wireless products perform the same function as LAN products. Therefore, Wireless products can work with Netware, Windows 2000, or other LAN operating systems to support printer or file sharing.

**11. Would the information be intercepted while transmitting on air?**

WLAN features two-fold protection in security. On the hardware side, as with Direct Sequence Spread Spectrum technology, it has the inherent security feature of scrambling. On the software side, WLAN series offer the encryption function (WEP) to enhance security and Access Control. Users can set it up depending upon

their needs.

**12. What is DSSS? What is FHSS? And what are their differences?**

Frequency-hopping spread-spectrum (FHSS) uses a narrowband carrier that changes frequency in a pattern that is known to both transmitter and receiver. Properly synchronized, the net effect is to maintain a single logical channel. To an unintended receiver, FHSS appears to be short-duration impulse noise. Direct-sequence spread-spectrum (DSSS) generates a redundant bit pattern for each bit to be transmitted. This bit pattern is called a chip (or chipping code). The longer the chip is, the greater the probability that the original data can be recovered. Even if one or more bits in the chip are damaged during transmission, statistical techniques embedded in the radio can recover the original data without-the need for retransmission. To an unintended receiver, DSSS appears as low power wideband noise and is rejected (ignored) by most narrowband receivers.

**13. What is Spread Spectrum?**

Spread Spectrum technology is a wideband radio frequency technique developed by the military for use in reliable, secure, mission-critical communication systems. It is designed to trade off bandwidth efficiency for reliability, integrity, and security. In other words, more bandwidth is consumed than in the case of narrowband transmission, but the trade off produces a signal that is, in effect, louder and thus easier to detect, provided that the receiver knows the parameters of the spread-spectrum signal being broadcast. If a receiver is not tuned to the right frequency, a spread –spectrum signal looks like background noise. There are two main alternatives, Direct Sequence Spread Spectrum (DSSS) and Frequency Hopping Spread Spectrum (FHSS).

**14. What is WPS?**

WPS stands for Wi-Fi Protected Setup. It provides a simple way to establish unencrypted or encrypted connections between wireless clients and access point automatically. User can press a software or hardware button to activate WPS function, and WPS-compatible wireless clients and access point will establish connection by themselves. There are two types of WPS: PBC (Push-Button Configuration) and PIN code.