



Print Server

Print Server

User's Manual

ΣDiMAX

1. INTRODUCTION	4
1.1 Product Introduction	4
1.2 Product Models	5
1.3 Product Package.....	6
1.4 Network Printing Architecture	7
1.5 Network Printing Environment	11
1.6 Contents of the User's Manual.....	14
1.7 Firmware & Printing Function.....	15
2. HARDWARE INSTALLATION	17
3. WINDOWS PEER-TO-PEER NETWORK.....	18
3.1 System Architecture	18
3.2 Administrator Installation and Setup	20
3.3 Administrator Utilities	28
3.4 Client Installation and Setup	30
3.5 Client Utilities	35
4. WINDOWS NT/2000 NETWORK	40
4.1 System Architecture	40
4.2 Windows NT/2000 Server Installation and Setup.....	41
4.3 User Installation and Setup	42
5. NETWARE NETWORK.....	44
5.1 System Architecture	44
5.2 NetWare 3.x Installation & Setup	47
5.3 NetWare 4.x/5.x Installation & Setup	60
6. UNIX SYSTEM NETWORK.....	70
6.1 Introduction	70
6.2 Enable PrintSir's TCP/IP Support	71
6.3 Setup PrintSir's IP Address.....	71
6.4 Verify PrintSir's IP Address	75
6.5 Configure Remote lpd Printing on the Host.....	75

6.6	Print a Test Page	77
7.	CONFIGURATION UTILITY	79
7.1	Introduction	79
7.2	General - General Information of PrintSir.....	80
7.3	PrintSir Status - PrintSir Network Status.....	81
7.4	Printer Status - Attached Printer Status	81
7.5	IP Cfg - IP Address Configuration.....	82
7.6	NW PS Cfg - NetWare Print Server Configuration	82
7.7	NW RP Cfg - NetWare Remote Printer Configuration.....	84
7.8	NW Information - NetWare Printing Summary	84
7.9	PrintSir Cfg - PrintSir Network Ability Setting.....	85
7.10	Restore Default - Restore to Default.....	86
7.11	Upgrade - Firmware Upgrade / Update.....	86
7.12	DHCP Cfg - DHCP Server Configure.....	87
7.13	DHCP Information - DHCP Information.....	89
7.14	Mail Print Cfg - Email Printing Setting	90
7.15	SNMP Cfg - SNMP Parameter Setting.....	91
8.	WEB MANAGEMENT	93
8.1	Introduction	93
8.2	WebDESK Utility	93
8.3	Web Management of PrintSir	95
9.	EMAIL PRINTING	106
9.1	Introduction	106
9.2	System Requirement	106
9.3	System Setup.....	107

1. Introduction

1.1 Product Introduction

Thank you for purchasing and using Edimax's PrintSir series print server. PrintSir allows your printer to become a shared device on the network. It offers printing flexibility and manageability on your Local Area Network at an extremely low cost and with an absolute minimum setup and maintenance required.

PrintSir provides a network port (10Mbps or 10/100Mbps Ethernet) and one or three printer's parallel ports. Please refer to the information of various types of PrintSir in the following sections for more detailed explanation.

PrintSir supports IPX, TCP/IP, and NetBEUI protocols. It is the best network printing solutions for various common network operating systems, such as Windows 95/98/Me Peer-to-Peer Printing, Windows NT/2000, NetWare, Unix/Linux, etc.

With the help of Installation Wizard, you can easily and instantly complete the settings for your printing environment, and start enjoying the fantastic features provided by PrintSir.

In the following chapters, we will introduce in detail the printing features, installation methods, and system configuration for different network environments.

If you would like to set up and install PrintSir quickly, please refer to the Quick Installation Guide that comes along with this PrintSir.

1.2 Product Models

Model	PS-901	PS-1001	PS-1101	PS-1201	PS-3101	PS-3101P
Hardware						
Size	Pocket	Pocket	Palmtop	Pocket	Desktop	Desktop
Direct Attached	Yes	Yes	No	Yes	No	No
Number of Printer Ports	1	1	1	1	3	3
Printer Connector	Centronics	Centronics	DB25	Centronics	DB25	DB25
Network Speed	10M	10M	10/100M	10/100M	10/100M	10/100M
Network Connector	UTP	UTP/BNC	UTP	UTP	UTP	UTP
Bi-Directional	No	No	Yes	Yes	Yes	Yes
Flash Memory Size	512K	512K	512K	512K	512K	512K
Network LED	Yes	Yes	Yes	Yes	Yes	Yes
Status LED	Yes	Yes	Yes	Yes	Yes	Yes
Firmware Upgrade	Yes	Yes	Yes	Yes	Yes	Yes
Power-On-Self-Test	Yes	Yes	Yes	Yes	Yes	Yes
Network Protocol Support						
IPX/SPX	Yes	Yes	Yes	Yes	Yes	Yes
TCP/IP	Yes	Yes	Yes	Yes	Yes	Yes
NetBEUI	Yes	Yes	Yes	Yes	Yes	Yes
Network Environment						
Windows Peer-to-Peer Printing	Yes	Yes	Yes	Yes	Yes	Yes
Windows Server-Based Printing	Yes	Yes	Yes	Yes	Yes	Yes
NetWare Bindary Mode Printing	Yes	Yes	Yes	Yes	Yes	Yes
NetWare NDS Mode Printing	Yes	Yes	Yes	Yes	Yes	Yes
NetWare Remote Printer	Yes	Yes	Yes	Yes	No	No
TCP/IP Remote Printing	Yes	Yes	Yes	Yes	Yes	Yes
Unix LPR Printing	Yes	Yes	Yes	Yes	Yes	Yes
Administration						
Windows Configuration Utility	Yes	Yes	Yes	Yes	Yes	Yes
Web Management Server	Yes	Yes	Yes	Yes	Yes	Yes
Web Management Utility	Web	Web	Web	Web	Web	Web
SNMP Protocol	Yes	Yes	Yes	Yes	Yes	Yes
Printer Port Management	Yes	Yes	Yes	Yes	Yes	Yes
IP Assignment						
ARP & Ping	Yes	Yes	Yes	Yes	Yes	Yes
DHCP Server	Yes	Yes	Yes	Yes	Yes	Yes
DHCP Client	Yes	Yes	Yes	Yes	Yes	Yes
BOOTP	Yes	Yes	Yes	Yes	Yes	Yes
RARP	Yes	Yes	Yes	Yes	Yes	Yes
DOS Utility	Yes	Yes	Yes	Yes	Yes	Yes
Others						
Email Printing	Yes	Yes	Yes	Yes	Yes	Yes
Direct Print	Yes	Yes	Yes	Yes	Yes	Yes
Logical Printer	Yes	Yes	Yes	Yes	Yes	Yes
Language	English Chinese	English Chinese	English Chinese	English Chinese	English Chinese	English Chinese
CD-ROM	Yes	Yes	Yes	Yes	Yes	Yes

1.3 Product Package

This package contains the following components:

- PrintSir Print Server x 1
- Power Adapter x 1
- CD x 1
- Quick Installation Guide x 1

1.4 Network Printing Architecture

This section illustrates how PrintSir functions and operates on the network. Before you install and use PrintSir, it is strongly suggested that you read this section completely, and select only the chapters you need according to your network operating system by “Contents of the User’s Manual” in next section.

This section will first introduce the role every component plays in the network-printing environment.

- **PrintSir Print Server**
- **Client User**
- **Network Server (optional)**

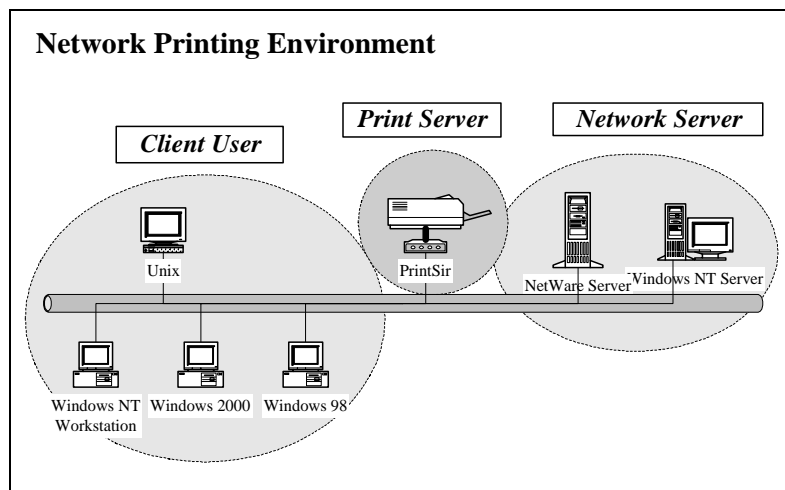

Detailed examples will then be illustrated through actual network environment.

1.4.1 Print Server Network Functions

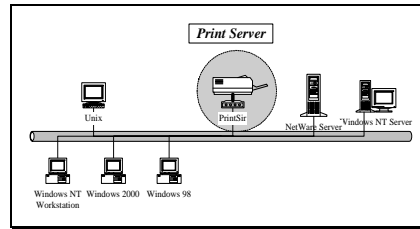

Because PrintSir supports IPX, TCP/IP, and NetBEUI network protocols, any networked computer can directly print to the print server from any of its installed protocol.

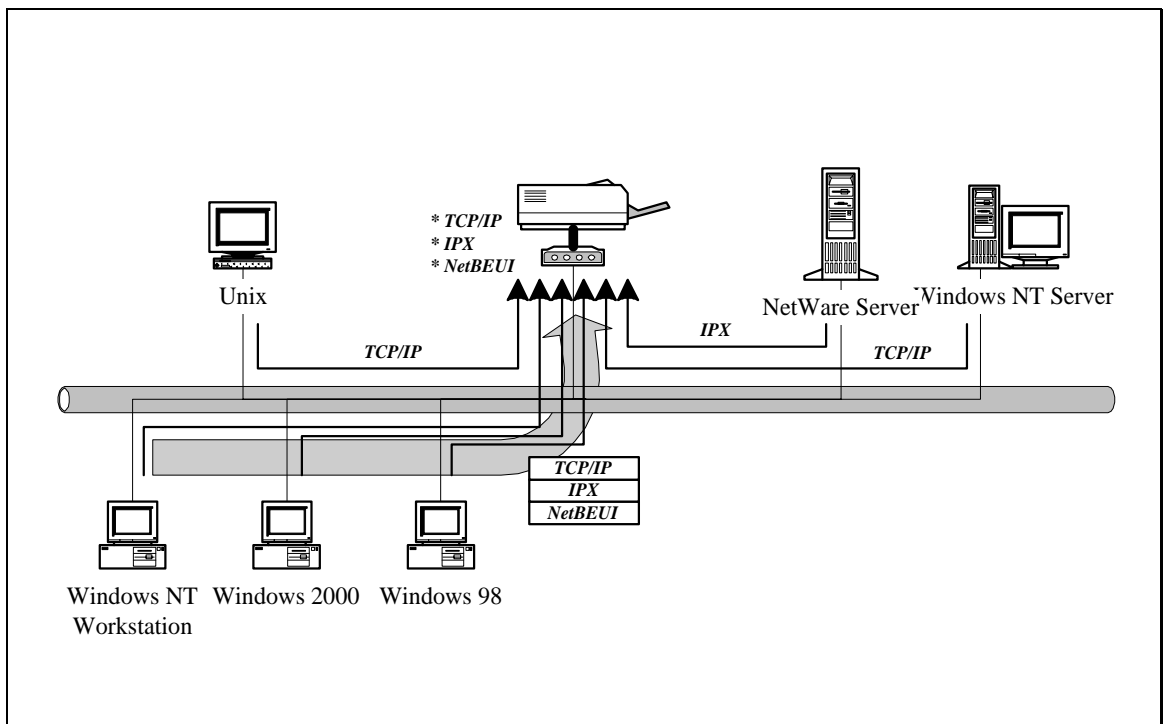

1.4.2 Network Printing Functions for Clients

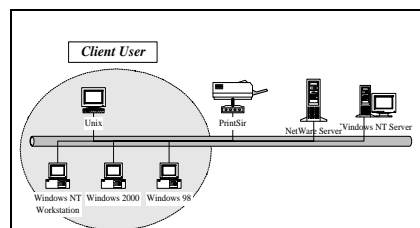

Common operating systems for clients are classified as following:

- **Windows 95/98/Me/NT/2000**

- Our print server system provides PTPP (Peer-to-Peer Printing) driver and utilities for Windows 95/98/NT/2000 users. PTPP (Peer-to-Peer Printing) supports IPX, TCP/IP, and NetBEUI protocols. While printing after installation, PTPP will automatically select the proper transport protocol to connect to the print server depending on the protocols installed in each computer (client computer may only have IPX or TCP/IP installed).

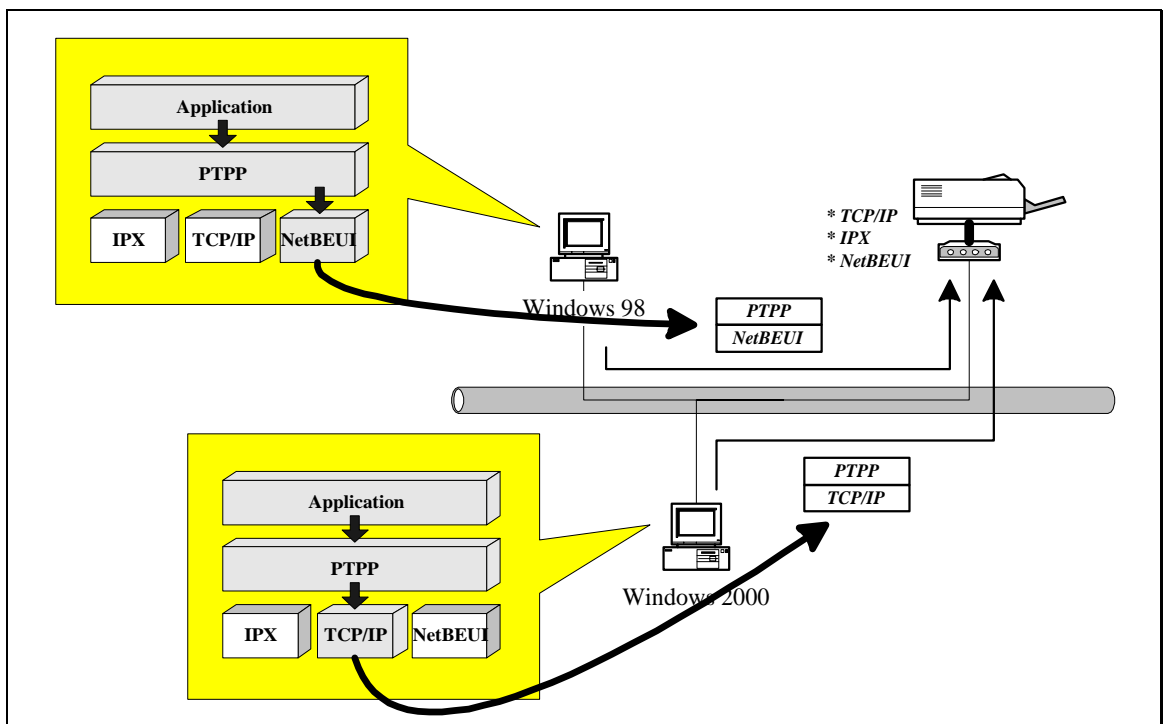

- In the client installation procedure, after PTPP (Peer-to-Peer Printing Driver) is installed into Windows, the system will

automatically (manual configuration is also allowed) search through all the PrintSir print servers on the network, and then add their printing ports into Windows' printing port. (See below)

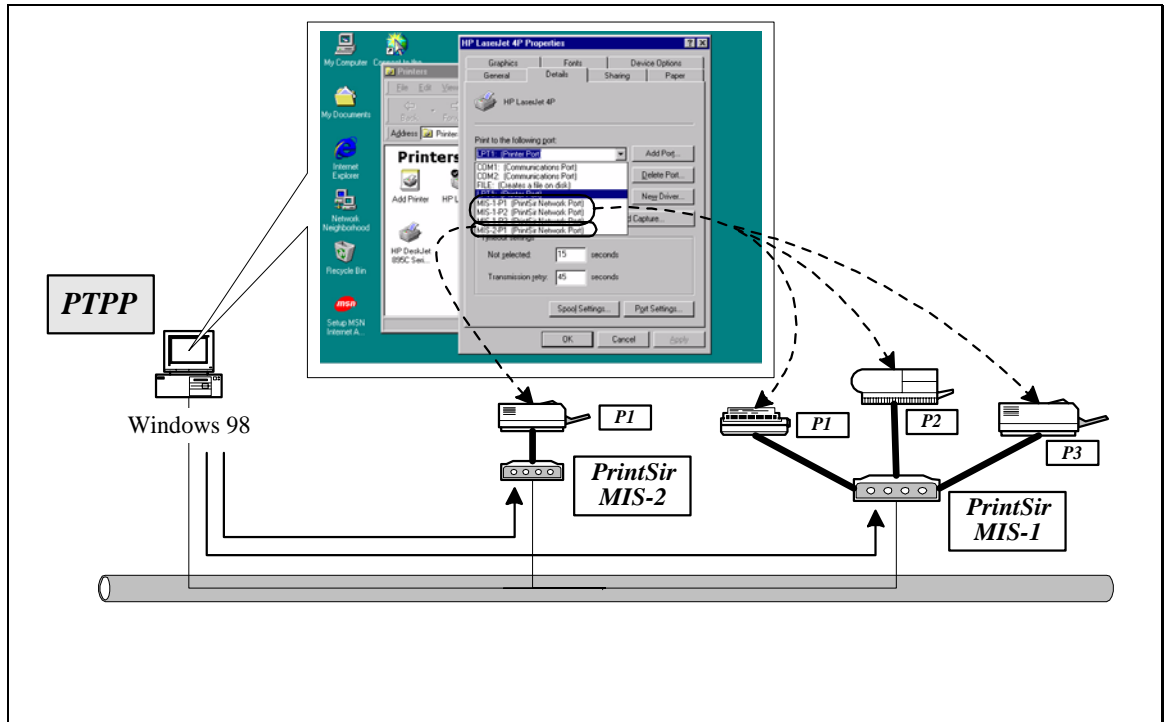

- **UNIX / Linux**

- UNIX (include HP/UX, SCO Unix, SunOS, Solaris, Unixware DECUnix, IBM AIX and others) and Linux use the system-standard LPR to print to PrintSir.

1.4.3 Network Printing Functions for Network Server

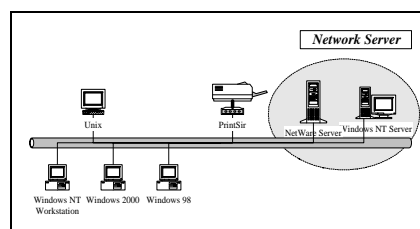

Common network servers are classified as following:

- **Windows NT/2000**

- Our print server system provides PTPP (Peer-to-Peer Printing) driver and utilities for Windows NT/2000. After PTPP is installed, the server can directly print to PrintSir. Adding this printing function into Windows NT/2000 Server allows print queue, user authority management, and many other advanced features to be used.

- **NetWare 3.x/4.x/5.x**

- In NetWare environment, PrintSir offers various printing modes like print queue, remote printer, etc.

1.5 Network Printing Environment

Common network environment are classified as following:

- **Windows Peer-to-Peer Network**

Since both the PrintSir and client's PTPP driver fully support IPX, TCP/IP, and NetBEUI protocols, when printing, the PTPP driver will automatically search and match up the protocol for both client and print server's sides.

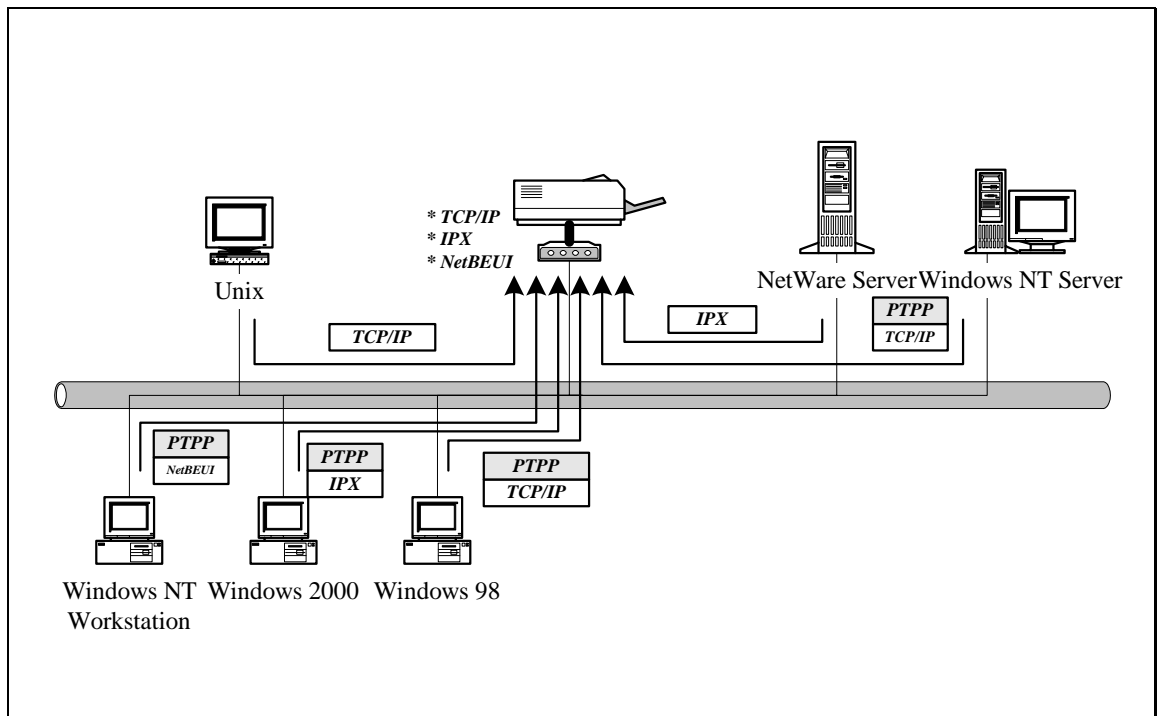

- **Windows NT/2000 Network**

Network printing function will become available after PTPP driver is installed into Windows NT/2000. Adding this printing function into Windows NT/2000 Server allows print queue, user authority management, and many other advanced features to be used.

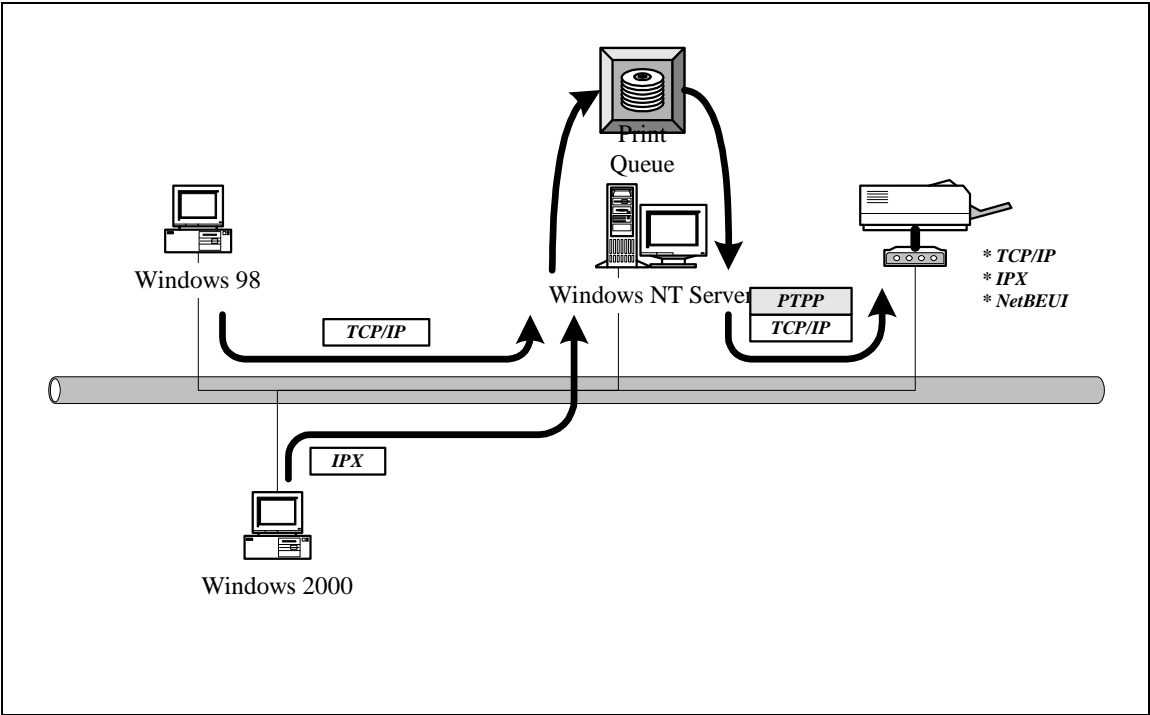

● **NetWare Network (see below)**

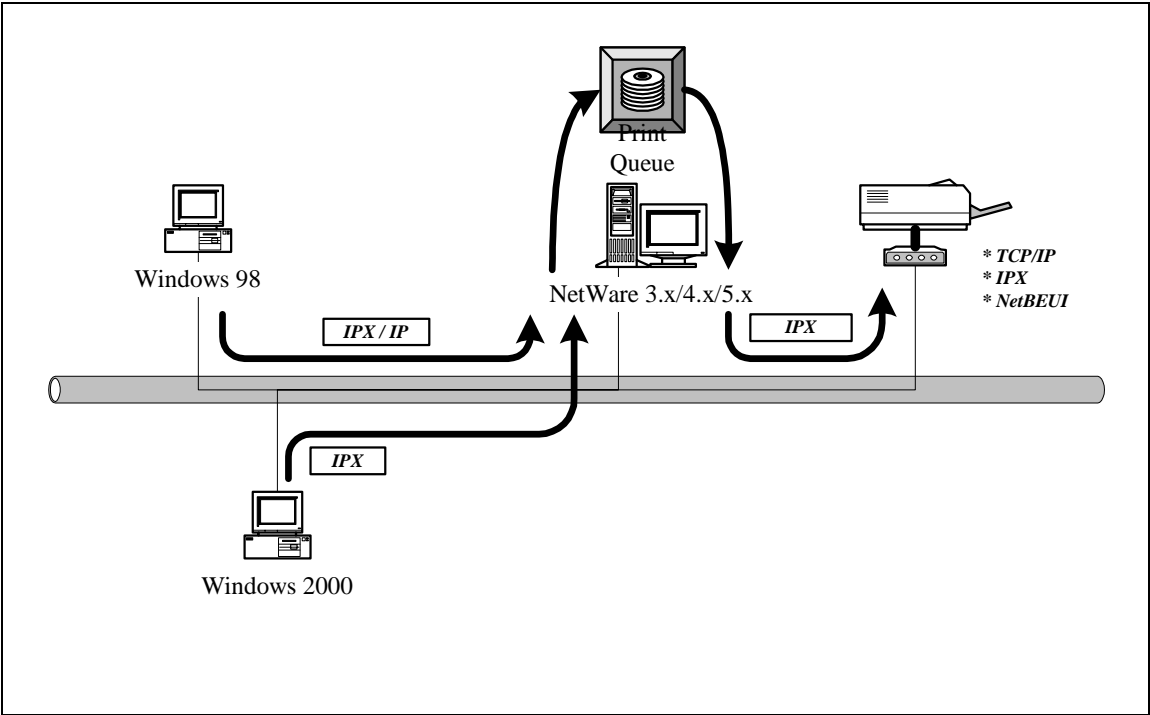

1.6 Contents of the User's Manual

Chapter 2 explains PrintSir's hardware installation and configuration. It is strongly recommended for you to read.

The following chapters 3, 4, 5, and 6 introduces:

Chapter 3. Windows Peer-to-Peer Network

Chapter 4. Windows NT/2000 Server-Based Network

Chapter 5. NetWare Network

Chapter 6. UNIX System Network

You may select the appropriate chapters and sections to read depending on your network printing's requirement.

Chapter 7 and chapter 8 introduce PrintSir's management and configuration utilities on Windows and Web Browser's environment respectively. You may select the appropriate management utility according to the administrator's computer platform.

Chapter 9 introduces PrintSir's Email Printing function and setup procedure. The Email Printing provides a new way to print documents across the Internet by the Email.

1.7 Firmware & Printing Function

In order to provide a complete network printing solution, PrintSir supports *Multiple Feature Sets* function for users to select the appropriate **Printing Feature Set** to use depending on individual's printing requirement. Currently, the system provides two **Feature Sets** for users to choose:

Standard Feature Set

- PTPP (Peer-to-Peer-Printing)
 - TCP/IP (LPR)
 - NetBEUI
 - IPX
- Email Printing
- NetWare Bindary Printing

NetWare Enhancement Feature Set

- TCP/IP Printing (LPR)
- NetWare Bindary Printing
- NetWare NDS Printing
- NetWare Remote Printer

(Single Port PrintSir Only)

All feature sets are included in PrintSir CD's firmware file.

<CD Driver>\FLASHROM\<<Model Name>\PSxxROM.BIN

Please refer to section 7.11 for instructions on how to select and setup the **Feature Set**.

For example, if you need to use NetWare NDS Printing, then you must change the system's default **Standard Feature Set** to the **NetWare Enhancement Feature Set**. In the meantime, PrintSir will support NetWare NDS / Remote Printer and other printing functions; however, it will not support NetBEUI, Email Printing and other **Standard Feature Set**'s special functions.

2. Hardware Installation

1. Unpack the print server package and check all the items listed in section 1.3.
2. Connect the print server to the printer you want to share on the network
 - For direct attach models, plug the print server directly to the printer's centronics port.
 - For palmtop/desktop models, connect the printer to print server by the standard printer cable.
3. Connect the power adapter to the print server.
4. The print server will perform the Power-On-Self-Test (POST) after it is powered on. The Status LED will flash 6 times to indicate that the print server is ready.

NOTE1: MUST use the power adapter shipped with the print server, do NOT use any other power adapter from any sources.

NOTE2: To prevent the compatibility problem between PrintSir and a few printers, it is recommend that you power on the PrintSir before the printer.

3. Windows Peer-to-Peer Network

3.1 System Architecture

PrintSir supports Windows Peer-to-Peer network printing mode, which is suitable for most medium and small network environments. Through quick and simple installation procedure, users can immediately enjoy the convenience of network printing.

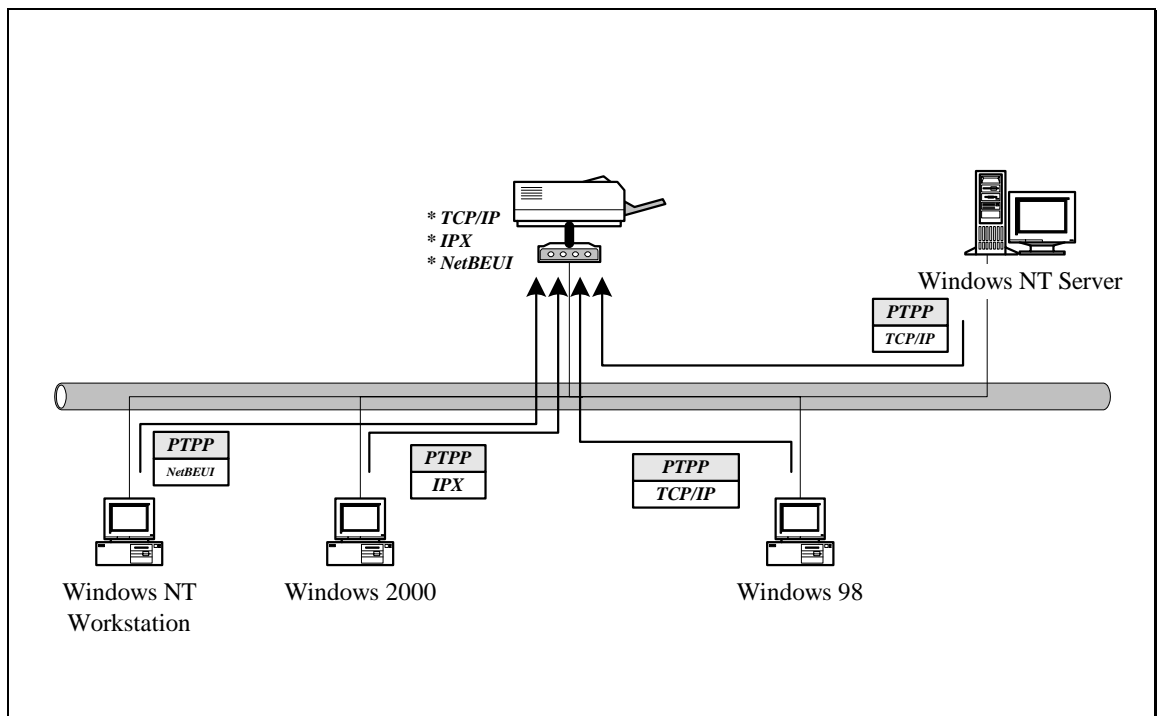

Installation procedure is separated into following two parts:

1. Administrator Installation and Setup (refer to section 2 for more detailed information).

System administrators must:

- Install administrator's utilities into his/her computer.
- Configure PrintSir from administrator's configuration utility.

2. Client Installation and Configuration (refer to section 3 for more detailed information).

Client users must install Windows PTPP driver (Peer-to-Peer Printing) for network printing.

In addition, after PTPP is installed, the system will automatically search for all print servers on the network, and add all printing ports (P1/P2/P3) of the print servers into Windows' printing port (refer to Network Printing Architecture in section 1.4 for more detailed information).

3.2 Administrator Installation and Setup

The Administrator Installation can be performed on Windows 95/98/Me/NT/2000 with the same user interface. Before the installation, please verify that your network protocol is installed on your PC (TCP/IP, IPX and/or NetBEUI). It will be helpful in your installation process.

1. Insert the CD shipped along with the print server into your CD-ROM drive. The Autorun.exe program should be executed automatically by Windows. If not, run Autorun.exe manually from CD-ROM drive's root directory.
2. The "Installation Manager" will be displayed on the screen as following.

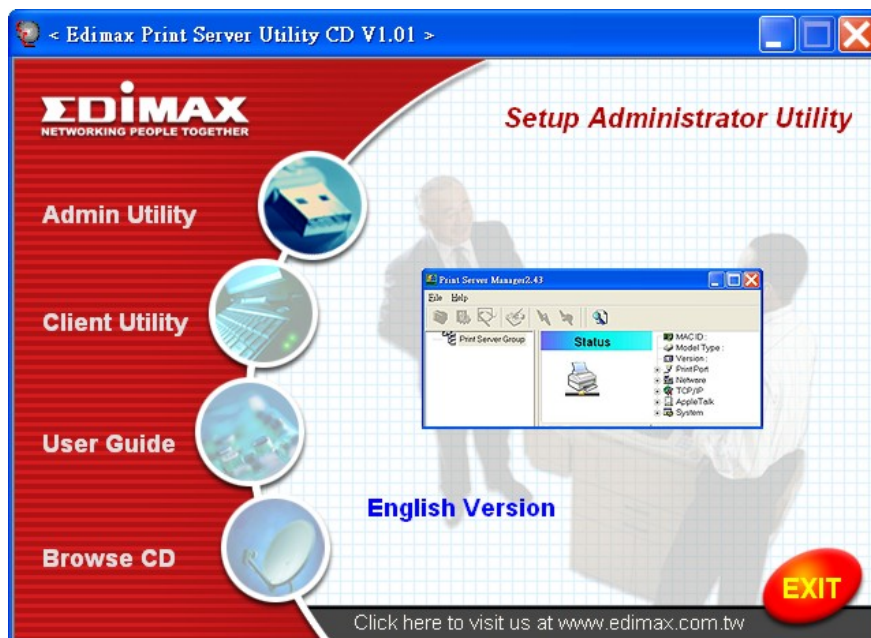

3. Click "Administrator Installation" and the "Utilities Setup" window will be displayed.

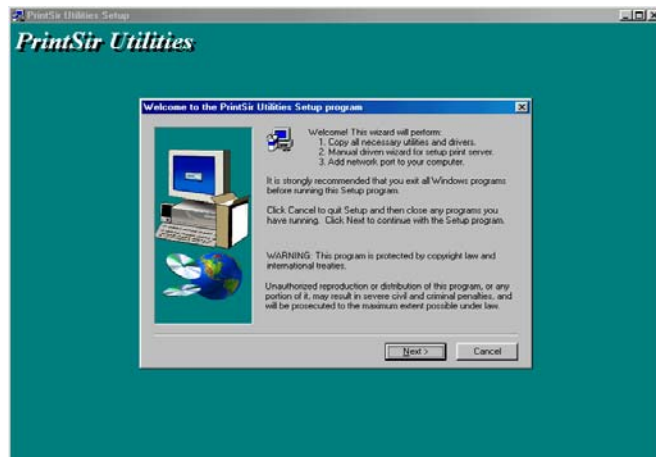

4. Click “Next”, and specify the destination folder where the utilities will be installed.

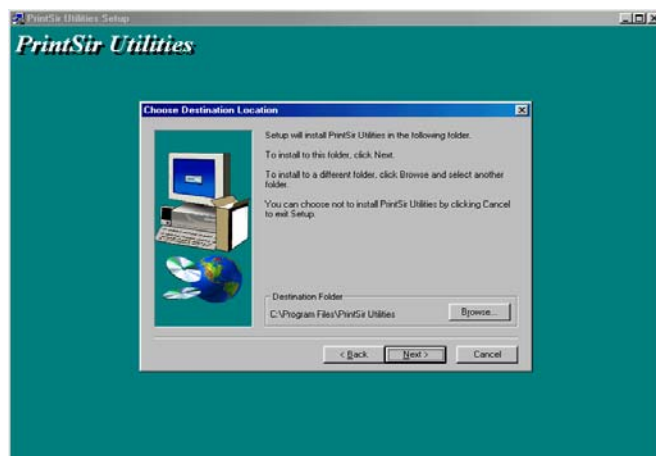

5. Click “Next”, and select the components you want to install. It is highly recommended to install all provided components.

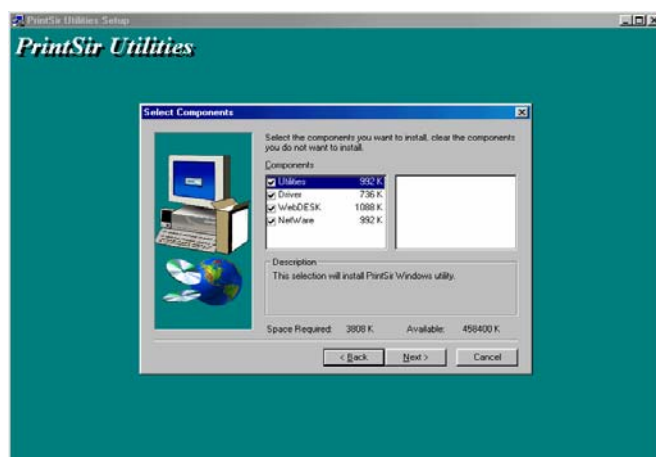

6. Click “*Next*”, and specify the program folder where the program icons will be added.

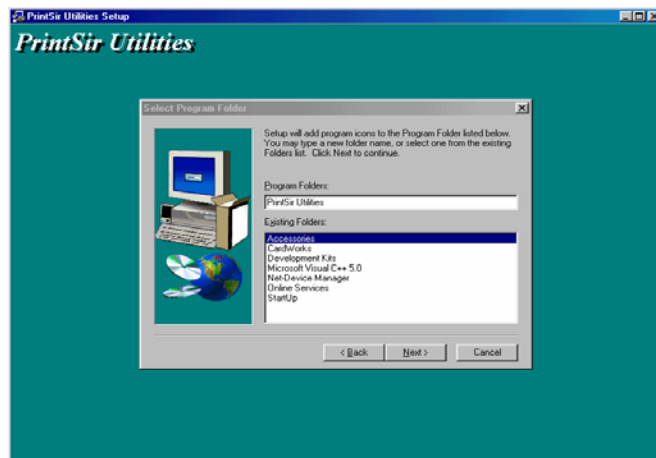

7. Click “*Next*” to start installation.

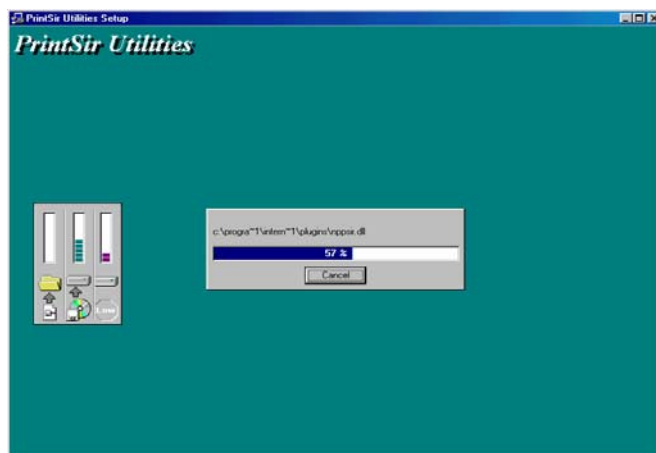

8. In a while, the program will finish installing all the utilities and drivers you selected. Thus far you have completed the installation phase and prepare to configure the Print Server. Click “*Next*”, and the “*Choose Print Server*” dialog box will be displayed as following.

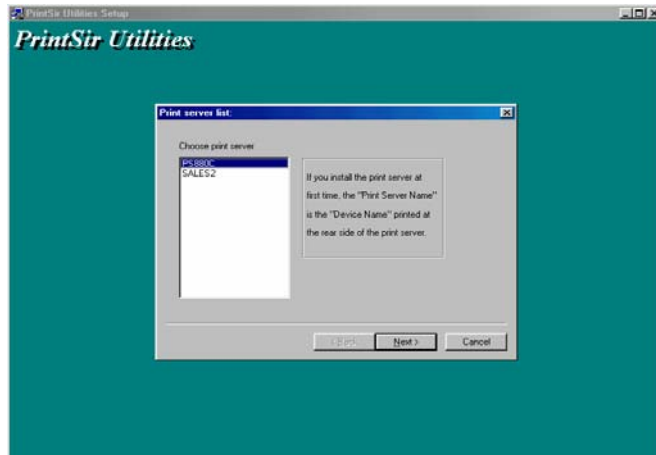

NOTE: If this is the first time you configure the print server, the “Print Server Name” is the same as the “Device Name” printed at the rear side of the print server.

9. Click “Next”, and the “Name the print Server” dialog box will be displayed as following,

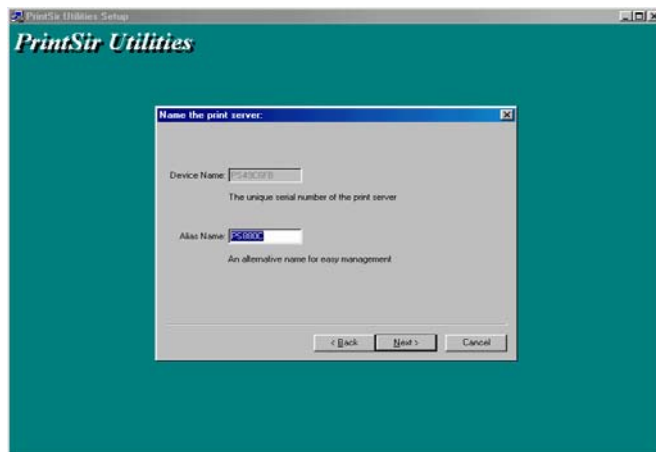

You can assign a meaningful name for the management consideration. But note that, this name will be the “Identifier” for the Peer-to-Peer Printing (PTPP).

10. Click “Next” to configure network protocol in the following screen.

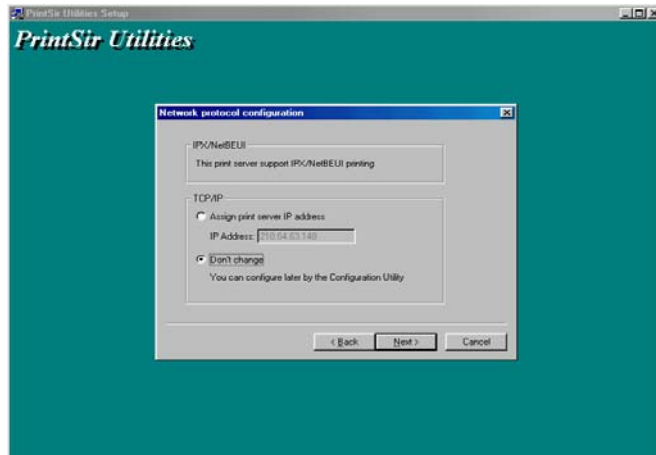

In the system default, IPX and NetBEUI protocols are enabled.

About the TCP/IP, you can either (1) assign a fixed IP address for the print server or (2) configure it later by the configuration utility.

11. Click “*Next*”, and the configuration summary is displayed in the window. Now, you have completed the “*Print Server Setup*”. By clicking “*Next*”, your system will perform “*Add network port*” of the print server to your PC.

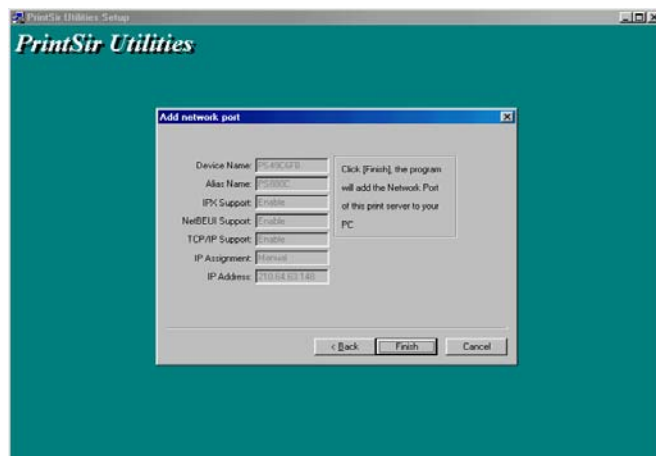

12. Finally, the “*Installation complete*” window is displayed to indicate that the Administrator Installation procedure is finished.



After the installation, you have completed the following tasks,

- Install all utilities and drivers to the administrator's PC.
- Configure the print server (including the print server name and network protocol)
- Add the network port of the print server to the administrator's PC.

Now, you have completed the administrator's setup for most of the network environment. You can then perform the "*Client Installation*" procedure (Section 3.4) on all clients' sides of the network.

If you want to print from this administrator's PC to the print server, all you need to do is to perform Windows' standard "Add Printer" procedure as described below.

Step1. Click "*Start*" button, choose *Setting* => *Printers*

Step2. Double click "*Add New Printer*"

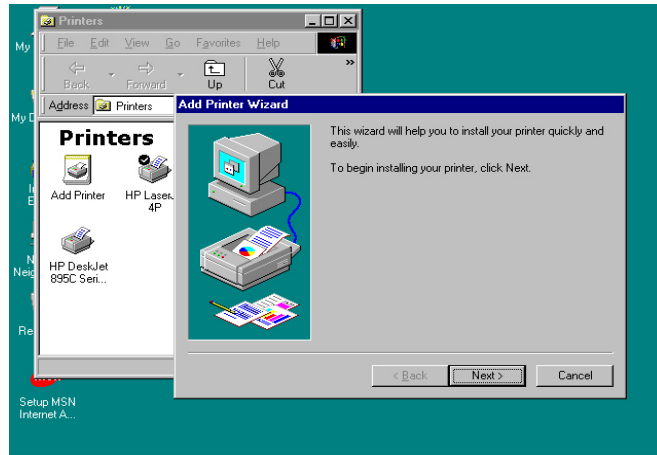

Step3. Select “*Local printer*” => click “*Next*”.



Step4. Select a suitable printer manufacturer and model, then click “*Next*”.

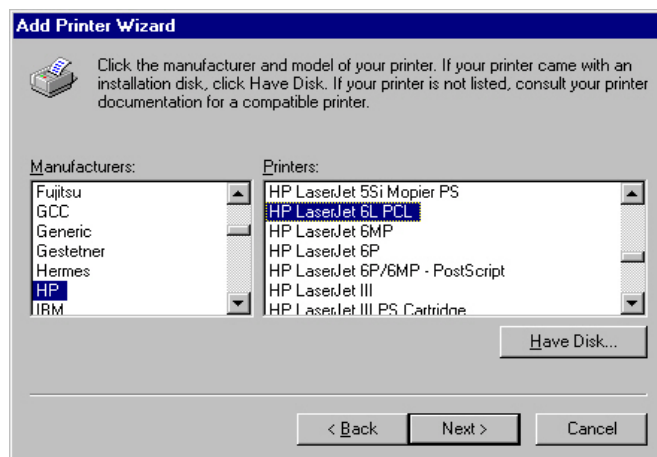

Step5. Choose the “*Print Server’s Network Port*” which was created by the administrator installation process and click “*Next*”.



Step6. Complete the rest of the questions to finish the network printer setup.

3.3 Administrator Utilities

After Administrator Installation is completed, there will be six utilities in PrintSir's Program folder.

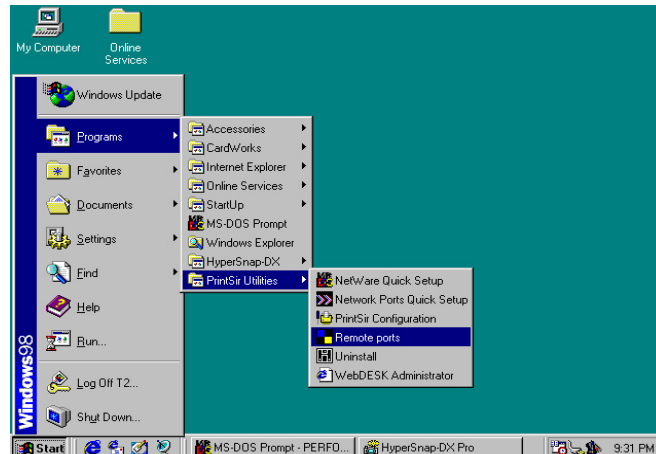

- Network Ports Quick Setup
 - ❖ Local printer port management tool (see section 3.5).
- Remote Ports
 - ❖ Remote printer port management tool (see section 3.5).
- NetWare Quick Setup
 - ❖ NetWare quick installation software (see chapter 5).
- PrintSir Configuration
 - ❖ Complete PrintSir management tool (see chapter 7 – PrintSir Configuration).
- Uninstall

- ❖ Assistant for removing all installed administrator software.
- WebDESK Administrator
 - ❖ Web based management tool (see chapter 8 – WebDESK Configuration).

3.4 Client Installation and Setup

The Client Installation can be performed on Windows 95/98/Me/NT/2000 with the same user interface. Before the installation procedure, please confirm that your PC has connected to the network and installed at least one network protocol.

1. Insert the CD shipped along with the print server into your CD-ROM drive. The Autorun.exe program should be executed automatically by Windows. If not, run Autorun.exe manually from CD-ROM drive's root directory.
2. The "*Installation Manager*" will be displayed on the screen as following.

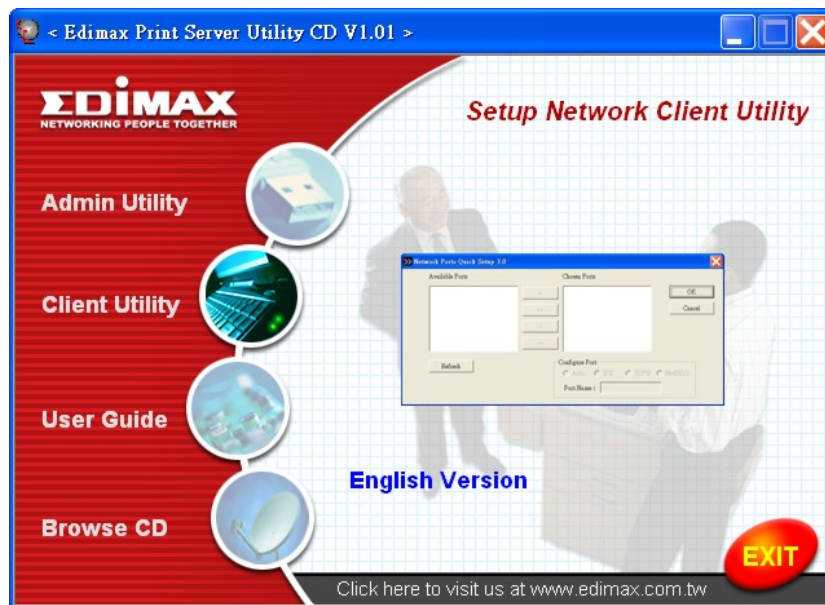

3. Click "*Client Installation*", and the "*Utilities Setup*" window will be displayed.



4. Click “*Next*”, and specify the destination folder where the utilities will be installed.



5. Click “*Next*”, and specify the program folder where the program icons will be added.

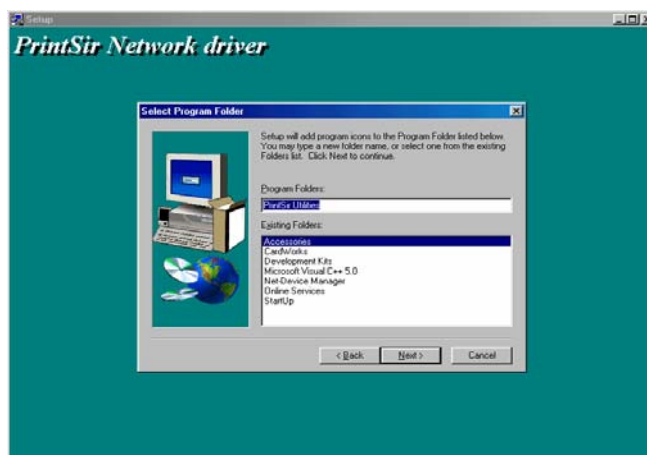

6. Click “*Next*” to start installation.

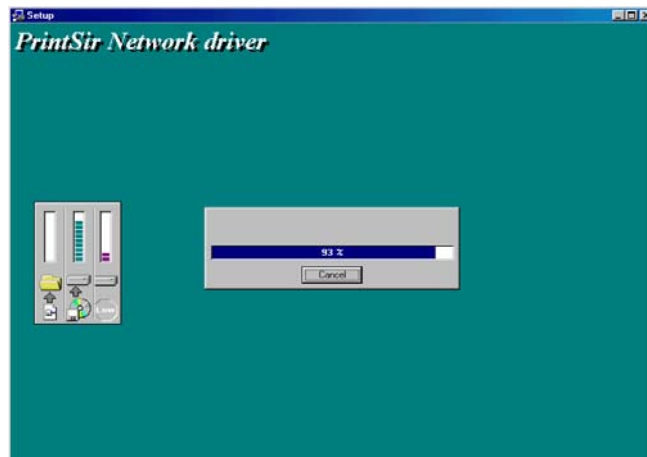

7. Now, the *installation procedure* is completed, and the next step is to set up the client's computer. Click "Continue", and all the print server's network ports detected on the network will be added to your PC.

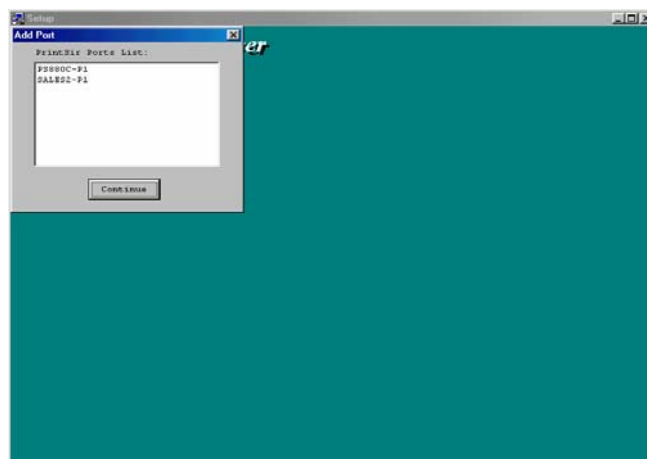

8. Finally, the "Installation complete" window is displayed to indicate that the Client Installation procedure is finished.

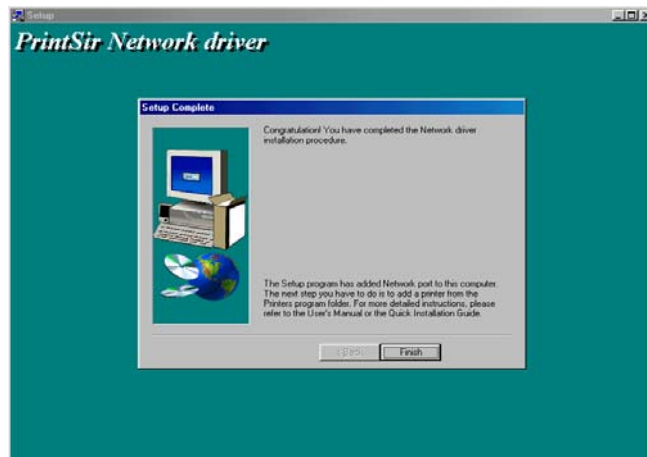

After the installation, you have completed the following tasks:

- Install all utilities and drivers to the client's PC.
- Add all the print server's network ports of the network to the client's PC.

You can then perform the Windows' standard "Add Printer" procedure as described below to add network printers to your PC.

Step1. Click "Start" button, choose *Setting* => *Printers*

Step2. Double click "Add New Printer".

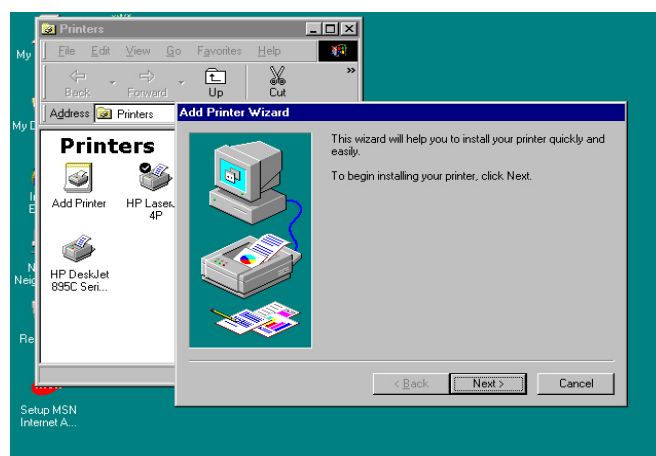

Step3. Select "Local printer" => click "Next".

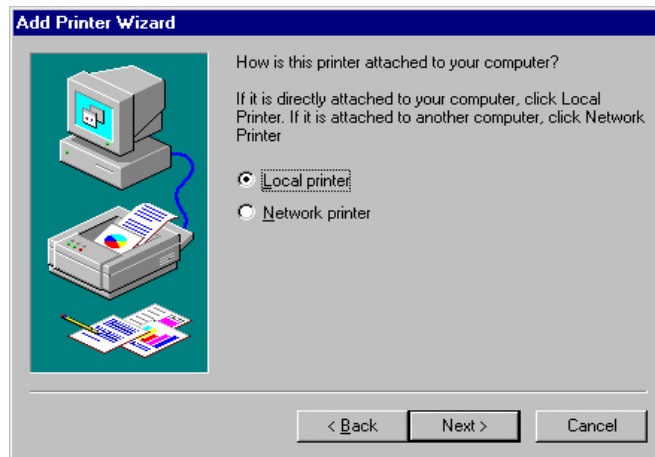

Step4. Select the suitable printer manufacturer and model, then click “Next”.

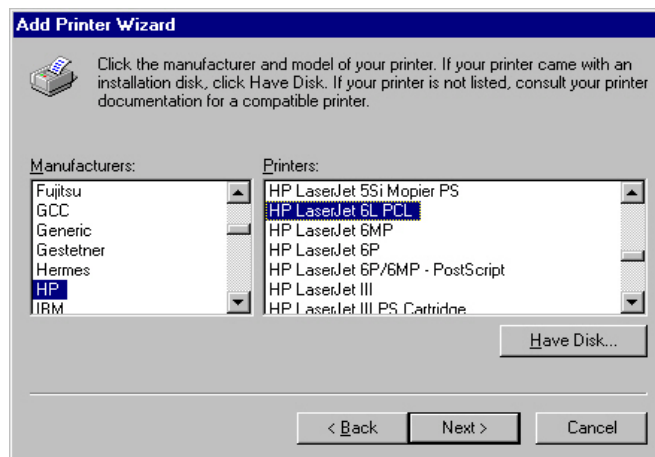

Step5. Choose the “*Print Server’s Network Port*” which has been created in the client installation process and then click “Next”.



Step6. Complete the rest of the questions to finish the network printer setup.

3.5 Client Utilities

After Client Installation is completed, there will be three tools in PrintSir's Program folder (see below).

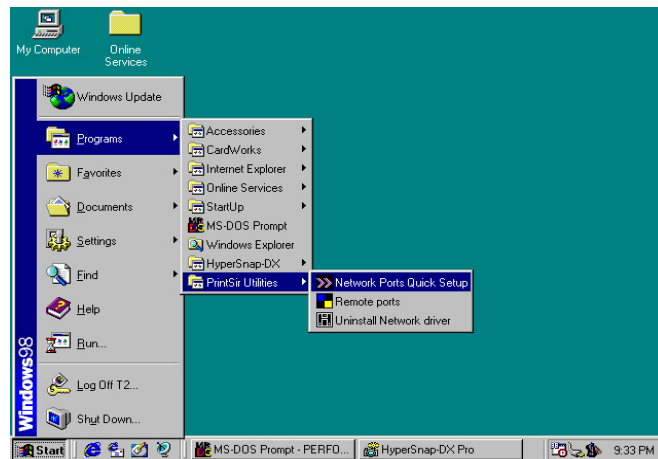

- Network Ports Quick Setup
- Remote Ports
- Uninstall Network Driver

The Uninstall Network Driver will assist you in removing all installed client software. The other two tools are described as following:

3.5.1 Network Ports Quick Setup

Network Ports Quick Setup Utility offers a very simple method to add or remove print server's printer port from the client's computer.

During the client's installation procedure, the system will automatically search for all PrintSir print servers on the network,

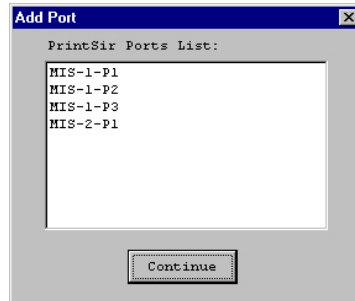

and add them into the printer ports of the client's computer. (see below)

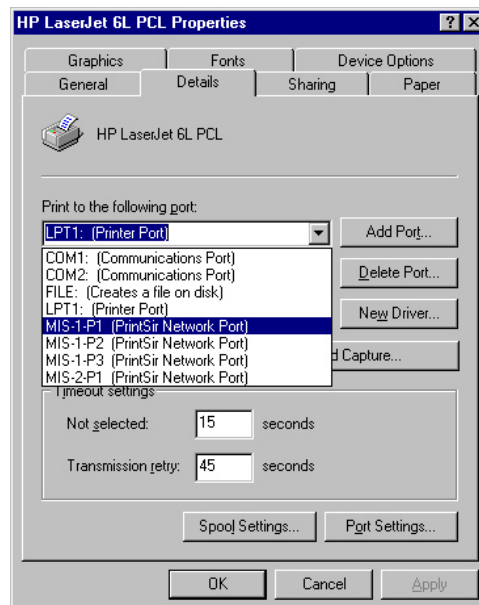

If you have just installed another new PrintSir on the network, you must run this program first. This program will search for new print servers and allow you to add the new network printer port into client's computer conveniently. Perform the standard Add Printer procedure, then you can print directly to the printer through the newly installed PrintSir.

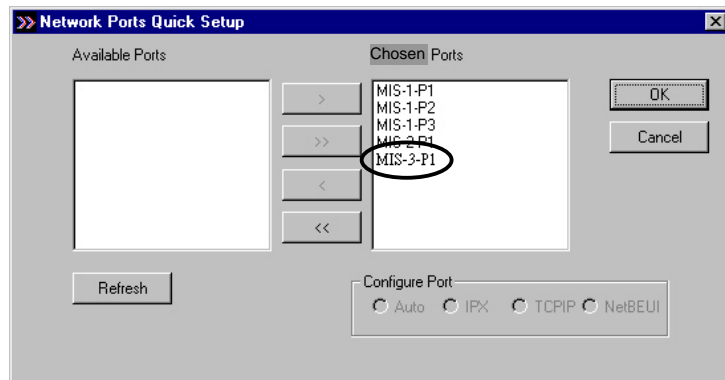
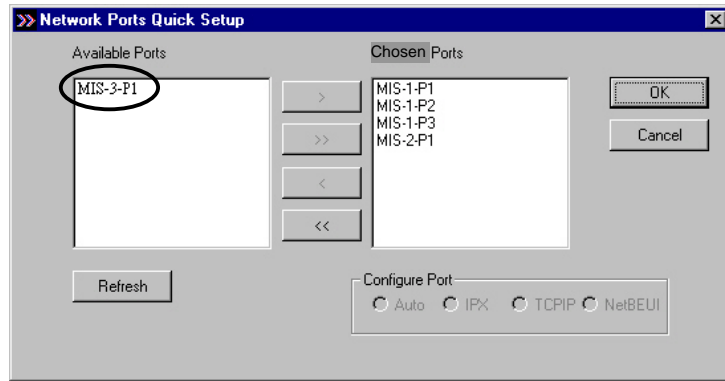

Please be aware that Network Ports Quick Setup Utility can only detect and configure all PrintSir print servers on the same network, it cannot search and configure print servers on other subnets across network segments. You must use Remote Ports Utility described in the next section to manage remote (across network segments) PrintSir print servers.

3.5.2 Remote Ports (Utility)

Remote Ports Utility offers a convenient way for you to manage and add printer port of the remote PrintSir. From the assistant of this utility, you can print to other PrintSir print servers outside the subnet across network segments. However, please note that this function only supports TCP/IP network protocol.

Please follow the procedures described below:

Step1. Run Remote Ports Utility

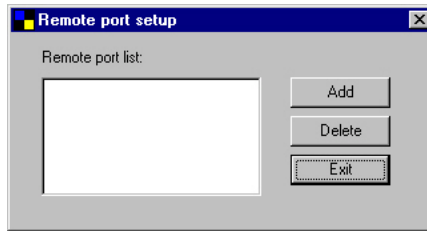

Step2. Press Add, then enter the print server's name, IP address, and port number.

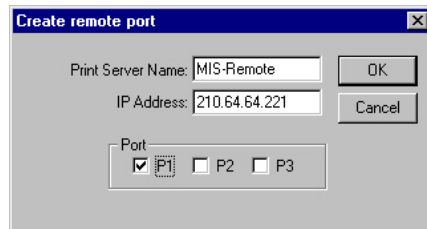

Step3. Press OK to add the remote printer port into your computer's printer ports.

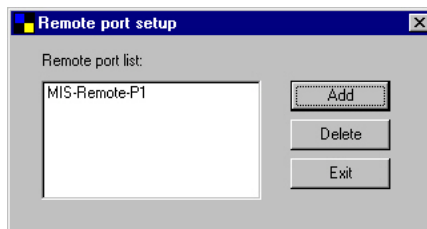

In order to use the remote printing function, you will have to proceed with normal Add Printer procedure and select your printer port as the newly added remote printer port.

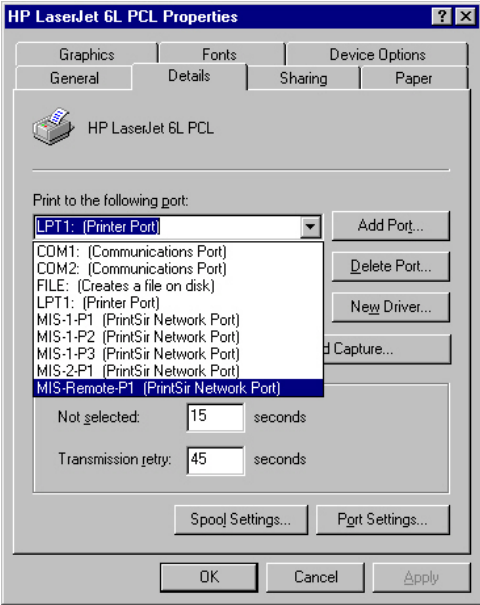

4. Windows NT/2000 Network

4.1 System Architecture

In Windows network environment, other than the Peer-to-Peer network printing architecture described in the previous chapter, we also offer the Server-Based Printing architecture for Windows NT/2000 server. Only one Windows NT/2000 is required to have Windows PTPP (Peer-to-Peer Printing) driver installed and share the printing service on the network. Other network users can simply connect to the server and access the shared printer. (see below)

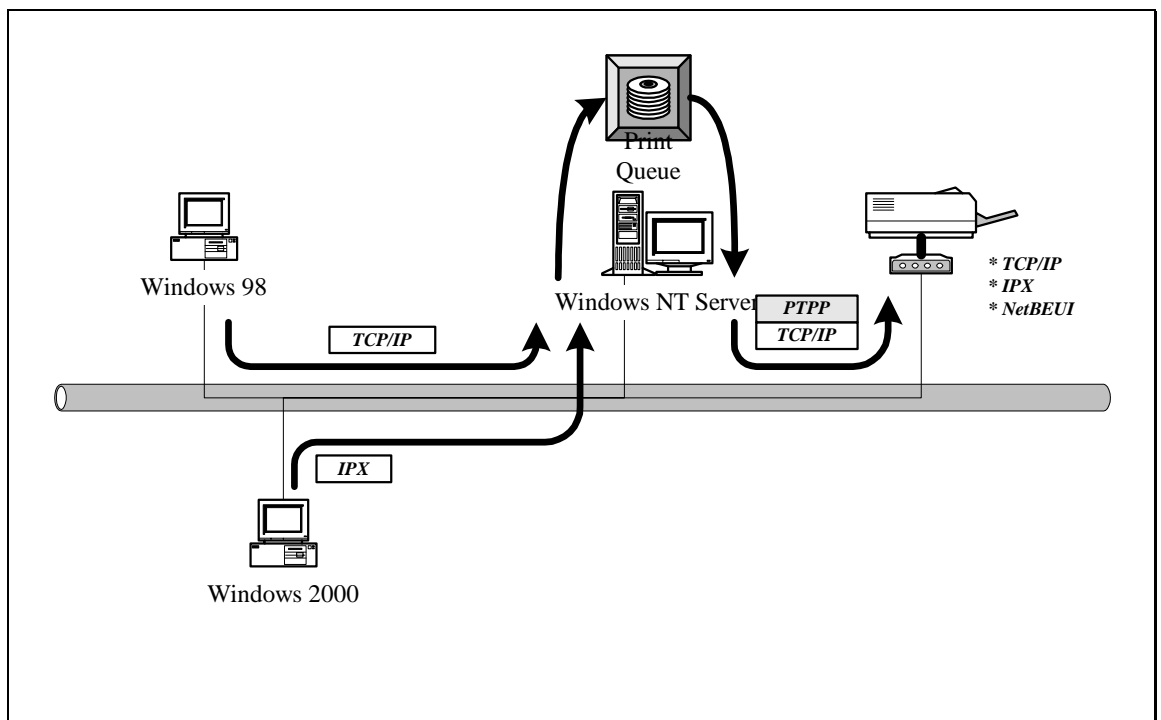

4.2 Windows NT/2000 Server Installation and Setup

Please follow the procedures described below for installation and construct a peer-to-peer connection (PTPP) between Windows NT/2000 Server and PrintSir Print Server.

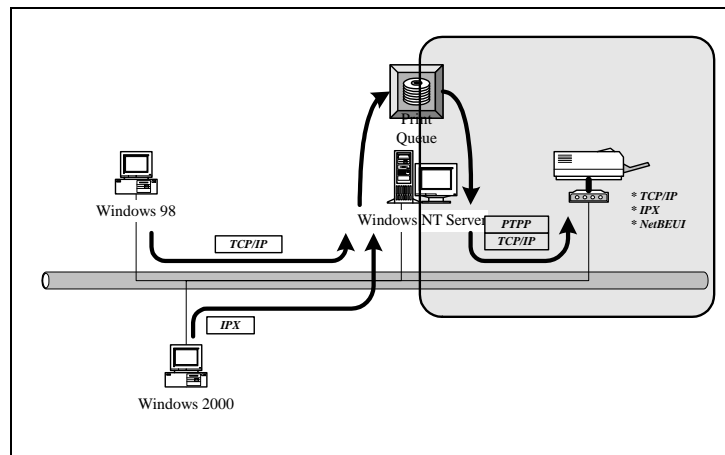

Step1.

If this is your first time installing PrintSir print server, please install the administrator software on Windows NT/2000 server first. Refer to section 3.2 for installation instructions.

If your network has already installed a working PrintSir print server and your Windows NT/2000 server has not yet installed PrintSir PTPP driver, please install the client software. Refer to section 3.4 and 3.5 for installation instructions.

Step2.

Please add/configure the Peer-to-Peer Printing of the Windows NT/2000 network printer and verify that you can print from Windows NT/2000 to the PrintSir by the installed PTPP driver.

Step3.

Share the above server's printer to the network by performing the standard Windows printer sharing process.

4.3 User Installation and Setup

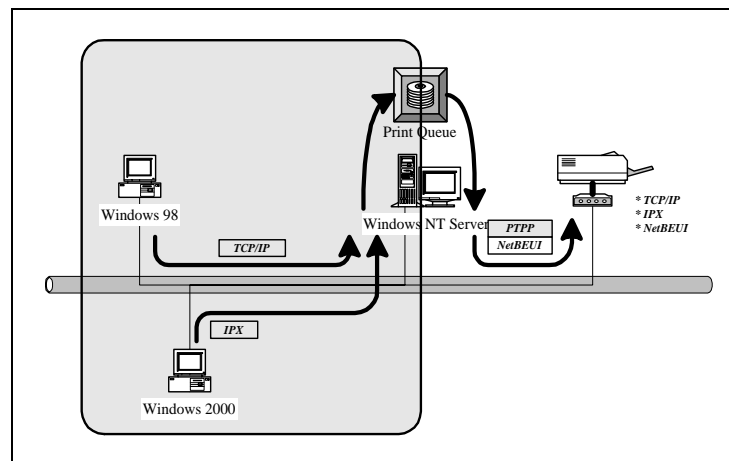

After server side's installation is completed, client side will be able to find the server's shared printer in Network Neighborhood. You only need to perform Window's standard *Add New Printer* procedure, select "*Network Printer*" shown in the screen below, and complete the configurations afterwards to access the shared printer.

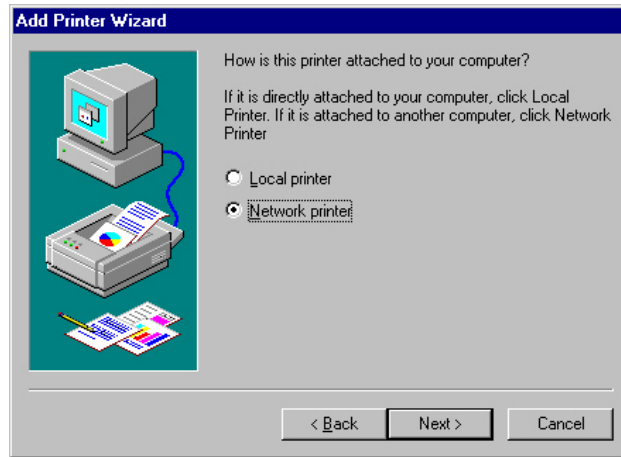

5. NetWare Network

5.1 System Architecture

We implement NetWare printer sharing functionality into the PrintSir itself, thus allowing one or more printers attached by a PrintSir to be connected to the network. We have developed the PrintSir to support both NetWare print server and remote printer functions:

- ❑ Embedded print server, which emulates the “*queue management functionality*” of NetWare print server, PSERVER program running on the NetWare server. A user first prints a job at a workstation, the job is routed to a NetWare server, the NetWare server stores the job in a print queue, then the print server gets the print job from the queue to printers.

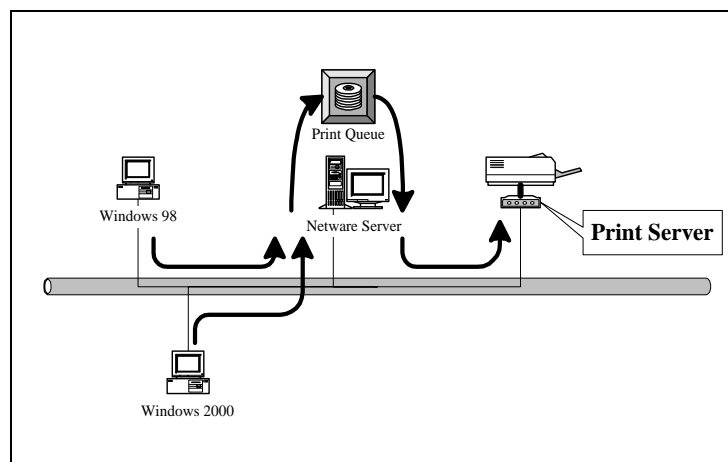

- ❑ Embedded remote printer, which allows a printer to function identically to a DOS workstation running NPRINTER.EXE program, but without the DOS workstation. A user first prints a job at a workstation, the job is routed to a NetWare server, the NetWare server stores the job in a print queue,

then the print server moves the print job from the queue to the remote printer then to the printer.

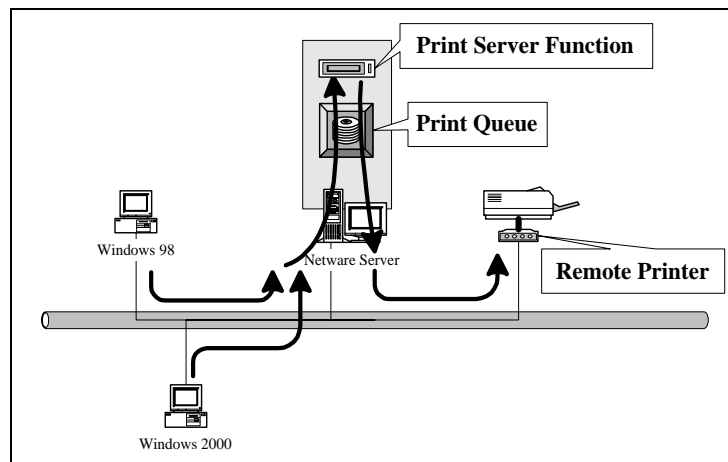

Compare with NetWare printing functionality, the advantages of embedding the NetWare network printing functionality in the PrintSir include:

- Installation is easier and quicker.
- Network management is easier.
- Printing performance is enhanced.
- Relieve NetWare file server's burden.
- Relieve the need of a workstation running the remote printer utility.
- Improve productivity by locating the printer near the workgroup.

The PrintSir can operate either in print server mode or in remote printer mode. Each print server should log into a NetWare server before servicing the print jobs. Each print server will occupy a user account with which it can log into the NetWare server. A remote printer will not log into

a NetWare server; it will connect to a NetWare print server and get the print jobs from the print server. A remote printer does not occupy any user account. A NetWare print server can control many remote printers; thus a print server account can be shared to many remote printers as your requirement. But the printing performance of a remote printer will be slower than a print server's, because a remote printer does not get a print job directly from the print queue, it gets a print job from the print server. Summarize the comparison between a print server and a remote printer as follows:

❑ The Advantage of a Print Server

- ❑ Easy configuration.
- ❑ Better printing performance.

❑ The Advantage of a Remote Printer

- ❑ Save user licenses.

NOTE: *This remote printer feature is not available for the 10/100Mbps 3-port PrintSir models.*

5.2 NetWare 3.x Installation & Setup

Once your PrintSir is connected to your Ethernet network, you can set it up for use with your networking software. There are two methods you can use to do this easily:

Please note that, you need install the IPX protocol before the following procedure,

1. On DOS environment or DOS box of Windows, use the “*INSTALL*” quick-installation program found on the <CD-ROM Drive>\DOSUTIL of CD-ROM included with the PrintSir.
2. On DOS environment or DOS box of Windows, use the “*PSETUP*” configuration program found on the included <CD-ROM Drive>\DOSUTIL, configure the PrintSir to use a particular file server. Then, use NetWare’s PCONSOLE program to create a NetWare print server and print queue with the appropriate names.

5.2.1 Quick Installation Using “Install” program

The *INSTALL* program included on the CD-ROM can be used to quickly set up the PrintSir for use on the NetWare environment. It can only be used to set up the PrintSir as Printer Server mode; it cannot be used to configure the PrintSir as Remote Printer mode. It handles changing the PrintSir’s internal settings, the creation of NetWare print server and print queue objects on the file server, and the assignment of the print server to the queue. Unless you need to configure the NetWare settings to conform to special requirements for your network, you can use the quick installation method.

To use this method,

1. Log into your NetWare server as SUPERVISOR.
2. Insert the CD-ROM included with the PrintSir, and change to the appropriate drive and directory.
Ex. e:\dosutil\
3. Run the INSTALL program

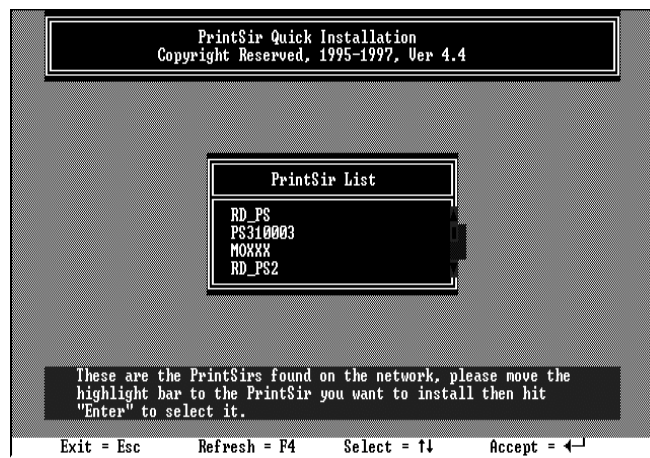

4. Select your new PrintSir from the displayed list and press Enter. The name listed will be the same as the Device Name printed on a label on your PrintSir.
5. A list of defaults will be displayed. If you need to change any of these items, use the arrow keys to choose the item you need to change, then press **Enter** to display a list of choices. When all of the values are correct, select the **Continue Installation** item and press **Enter**.



6. The quick installation program will not only set up the PrintSir, but create and setup all required objects on the file server. When the setup is complete, it will also display an execution command as following that you can run after logging in to the file server to redirect print commands to the new PrintSir. :

capture /S=III /Q=PRINTSIR_Q1 /nt /nff /nb /l=1 /ti=10

This redirects the LPT1 port (/l=1) to the print queue PRINTSIR_Q1 on the file server named III. No banner page will be printed (/nb), no form feed will be added to the end of the job (/nff), and tabs will not be expanded into spaces (/nt). If the program does not explicitly signal end-of-job, the capture facility will wait 10 seconds (/ti=10) before assuming that the print job is complete.

7. Reset the PrintSir to have the changes take effect.

Before printing, you may want to verify that the setup was complete. Using the *PrintSir Status* option of the PSETUP command (as described in the following section), you can verify that the PrintSir is connected to the right

file server, is using the correct network frame type, and so on.

You may also want to use the NetWare PCONSOLE program to verify that:

- A NetWare print server and one, two or three print queue(s) have been created on the file server. The number of print queues created is equal to the number of printer port of your PrintSir.
- Printer 0 (or Printer 1, Printer 2) on the print server is serving the new print queue(s).
- The print queue(s) and print server have the right permissions and notification settings.
- For more detailed information, consult your NetWare manual.

5.2.2 Installation Using PSETUP

5.2.2.1 Configuring as Print Server Mode

For more complex setup needs, you can use the PSETUP program in conjunction with the NetWare PCONSOLE program.

The installation procedure is as follows:

1. From a workstation, log in to your NetWare server as SUPERVISOR.
2. Run the PSETUP program included on the CD-ROM. (Ex. e:\dosutil\psetup.exe)

3. Select your new PrintSir from the list provided.

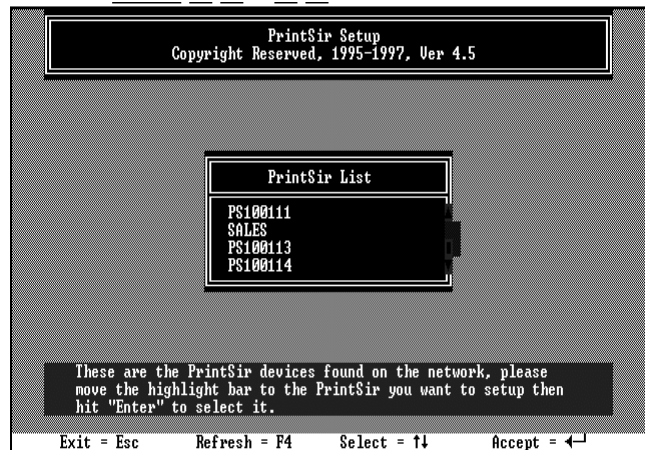

4. Choose NetWare Configuration from the menu.



5. Select Print server in the Printing mode field.

6. Change the Alias name if you want.

7. Set the Primary File Server to be the file server where the PrintSir's queue will be located.

8. Press Escape to exit the PrintSir Configuration screen, confirm that the changes should be saved, and exit PSETUP.

At this point the PrintSir setup is complete, and you can begin setting up the NetWare print server and print queue objects:

9. Run the NetWare PCONSOLE program.
10. Change the current file server, if necessary, using the Change Current File Server menu selection.
11. Choose the Print Queue Information menu selection.
12. Press the Insert key to add a new print queue.
13. Type in a print queue name, such as "PQ" or "Q1".

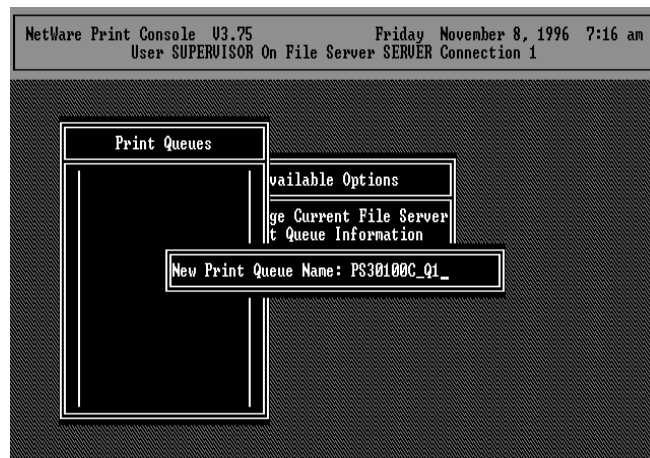

14. You have now successfully created the print queue that your PrintSir will serve. Press the Escape key until the Available Options main menu is displayed.
15. Select Print Server Information.
16. Press the Insert key to add a new NetWare print server object. The print server name can be

identical to the PSxxxxxx name printed on the label of the PrintSir, or you can use an alias name you have assigned using PSETUP.

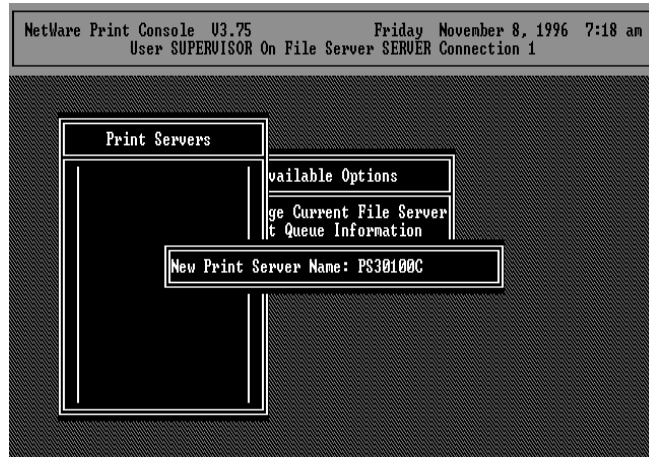

17. Press Enter to select the newly created print server.
18. Select Print Server Configuration.
19. Select Printer Configuration.
20. Select Printer 0 (or Printer 1, Printer 2), and press Enter, then select Parallel LPT1 (or LPT2, LPT3) in the Type field. If your PrintSir is with only one port, you do not need to configure this Type field.

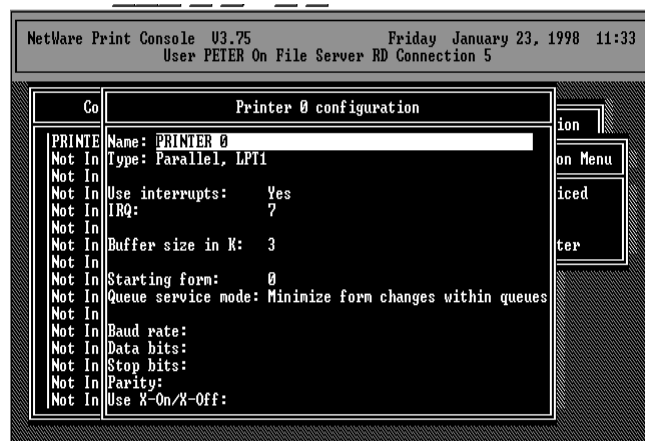

21. Press Escape, and answer Yes to the Save Changes question.
22. Select Queues Serviced by Printer, then select Printer 0 (or Printer 1, Printer 2) and press Enter.
23. Press *Insert* and add your newly created print queue to the list of queues serviced by the printer. Enter a priority number for the queue service, or press Enter to accept the default.

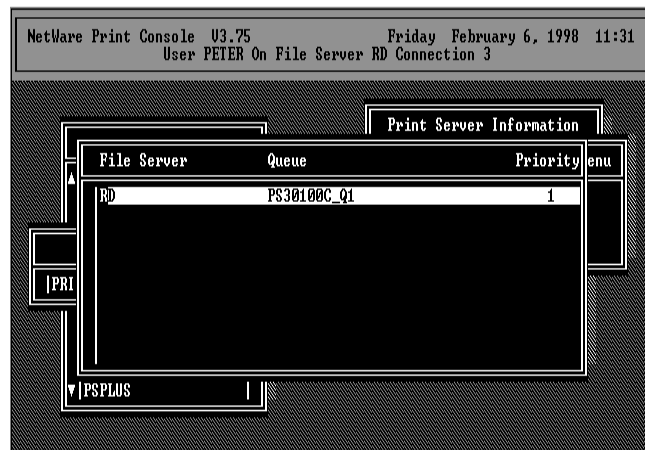

24. Repeatedly press Escape to exit the PCONSOLE program.
25. Reset the PrintSir to have the changes take effect.

NOTE: If the PrintSir you have is with multiple printer connectors, you may create multiple print queues and printer objects.

Your PrintSir should now be ready to use. You should be able to redirect printing to your PrintSir using a CAPTURE command such as the one shown in the previous section.

5.2.2.2 Configuring as Remote Printer Mode

This remote printer feature is not available for the 10/100Mbps 3-port PrintSir models. Make sure that you have created the NetWare print server with Type Remote using PCONSOLE utility before you configure the PrintSir. For more detailed information about PCONSOLE, please refer to NetWare's manual. You can set up the NetWare print server and print queue objects by following the steps below:

1. Run the NetWare PCONSOLE program.
2. Change the current file server, if necessary, using the *Change Current File Server* menu selection.
3. Choose the Print Queue Information menu selection.
4. Press the *Insert* key to add a new print queue.
5. Type in a print queue name, such as "PQ" or "Q1".
6. You have now successfully created the print queue that your NetWare print server will serve. Press the *Escape* key until the Available Options main menu is displayed.
7. Select *Print Server Information*.
8. Press the *Insert* key to add a new NetWare print server.
9. Press *Enter* to select the newly created print server.

10. Select *Print Server Configuration*.
11. Select *Printer Configuration*.
12. Select *Printer 0 (or Printer 1, Printer 2)*, press *Enter*, and then select *Remote Parallel* in the *Type* field.

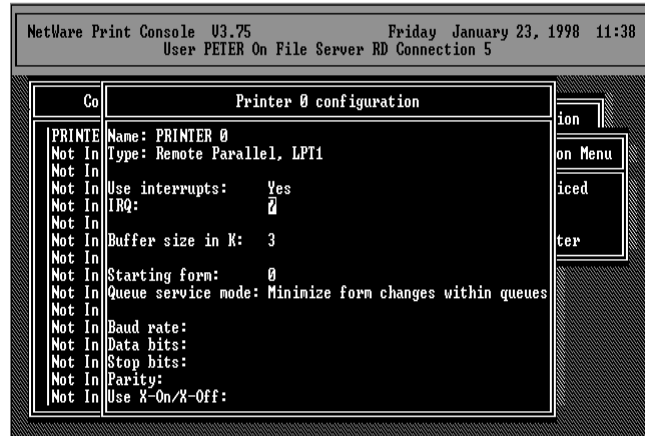

13. Press *Escape*, and answer *Yes* to the *Save Changes* question.
14. Select *Queues Serviced by Printer*, then select Printer 0 and press Enter.
15. Press *Insert* and add your newly created print queue to the list of queues serviced by the printer. Enter a priority number for the queue service, or press *Enter* to accept the default.

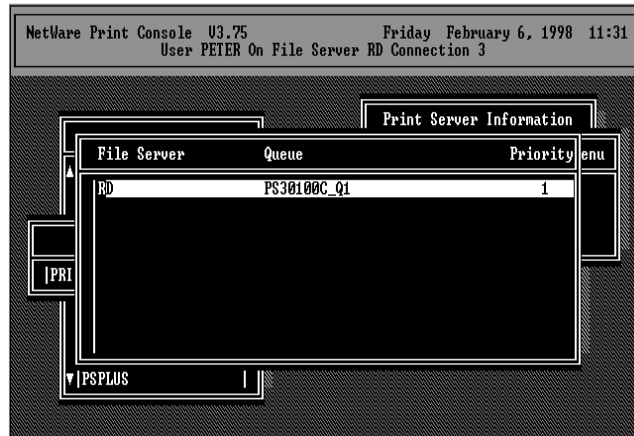

16. Repeatedly press *Escape* to exit the PCONSOLE program.

17. You must load NetWare print server on the NetWare file server so that the PrintSir configured as a remote printer can connect to that print server and service the print jobs. To load the NetWare print server, type "*LOAD PSERVER.NLM PrintServer*" command at the system console of the NetWare file server, where *PrintServer* is the print server name newly created by the PCONSOLE program.

To configure the PrintSir as a NetWare remote printer, perform the following steps:

1. From a workstation, log in to your NetWare server as SUPERVISOR.

2. Run the PSETUP program included on the CD-ROM. (ex. e:\dosutil\psetup.exe)

3. Select your new PrintSir from the list provided.

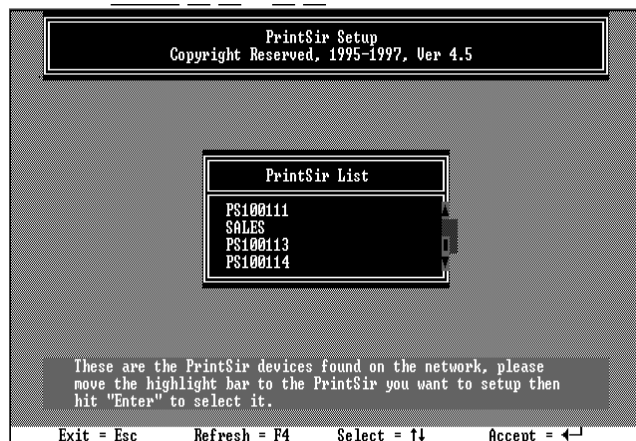

4. Choose *NetWare Configuration* from the menu.

5. Select *Remote Printer* in the *Printing mode* field.

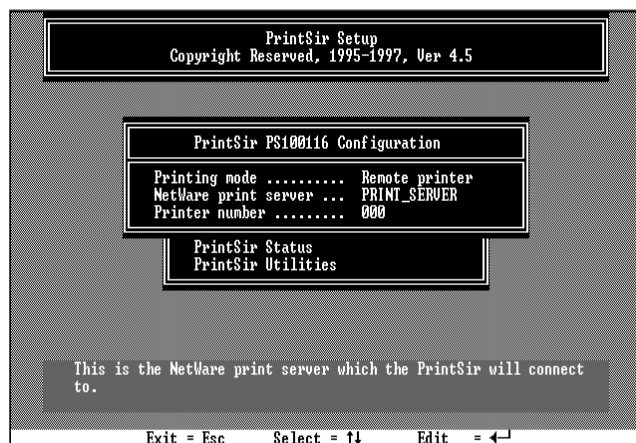

6. Type the print server's name in the *Print server* field. The print server will be serviced by the PrintSir that is being configured as a remote printer now.

7. Type the printer number assigned in PCONSOLE in the *Printer Number* field.

8. Press *Escape* to exit the NetWare Configuration screen, confirm that the changes should be saved, and exit PSETUP.

9. At this point the PrintSir setup is complete.

10. Reset the PrintSir to have the changes take effect.

5.3 NetWare 4.x/5.x Installation & Setup

This chapter tells how to configure your PrintSir for operation with NetWare 4.x/5.x file servers and clients using **NDS (NetWare Directory Services)**. If you need to install NetWare 4.x/5.x **bindery mode** network printing, please refer to the previous chapter. The installation procedure is the same as NetWare 3.x.

How NetWare 4.x/5.x is Different

Novell NetWare version 3.x uses a database called the *bindery* for storing information such as user and group information, server configuration, and information about network services. Each NetWare 3.x file server has its own bindery, which is administrated separately from other file servers using commands such as SYSCON, PCONSOLE, and so on.

NetWare version 4.x/5.x improved on the bindery concept by introducing *NDS*, NetWare Directory Services. NDS is a tree-structured directory that is shared by a group of file servers on a network, allowing centralized administration and easy coordination of users, permissions, and resources between servers.

To make it possible for NetWare 4.x/5.x servers to coexist with NetWare 3.x servers, NetWare 4.x/5.x supports *bindery emulation*, which makes parts of the NDS directory visible to NetWare 3.x clients, just as if the information were stored in a NetWare 3.x bindery. This allows clients to access NetWare 4.x/5.x servers without being upgraded to the NetWare 4.x/5.x software, and for 3.x and 4.x/5.x servers to be mixed on a network.

Your PrintSir can operate either in bindery mode or NDS mode. Bindery mode works with NetWare 3.x servers and with NetWare 4.x/5.x servers using bindery emulation. NDS mode works with NetWare 4.x/5.x servers.

***NOTE :** Though the PrintSir supports both bindery mode and NDS mode, it cannot support both at the same time. If you are using both NetWare 3.x and 4.x/5.x servers, you need to set up the PrintSir to use bindery mode. If you need to install NetWare 4.x/5.x bindery mode network printing, please refer to the previous chapter. The installation procedure is the same as NetWare 3.x.*

5.3.1 Quick Installation Using “Install” program

The INSTALL program included on the CD-ROM can be used to quickly set up the PrintSir for use. It can only be used to set up the PrintSir as Server mode; it cannot be used to configure the PrintSir as Remote Printer mode. To use this method,

1. Log in to your NetWare server as ADMIN.
2. Insert the CD-ROM and change to the appropriate drive and directory. Ex. e:\dosutil\
3. Run the INSTALL program with “NDS” option

E :\`dosutil\install /NDS`

4. Choose your new PrintSir from the displayed list and press Enter. The name listed will be the same as the Device Name printed on a label at the your PrintSir.

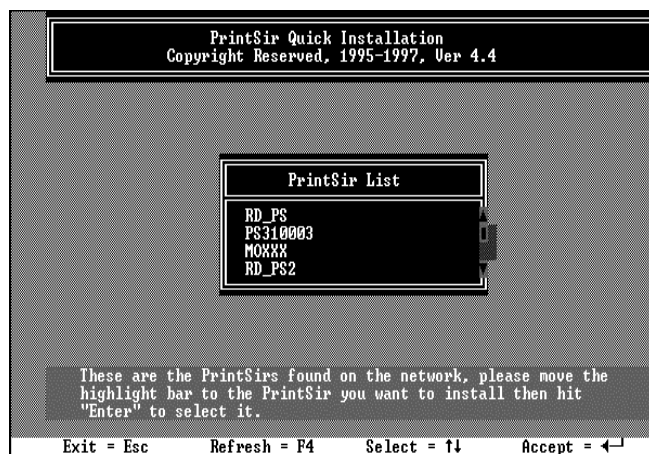

5. A list of defaults will be displayed. If you need to change any of these items, use the arrow keys to choose the item you need to change, then press Enter to display a list of choices. When all of the values are correct, select the Continue Installation item and press Enter.

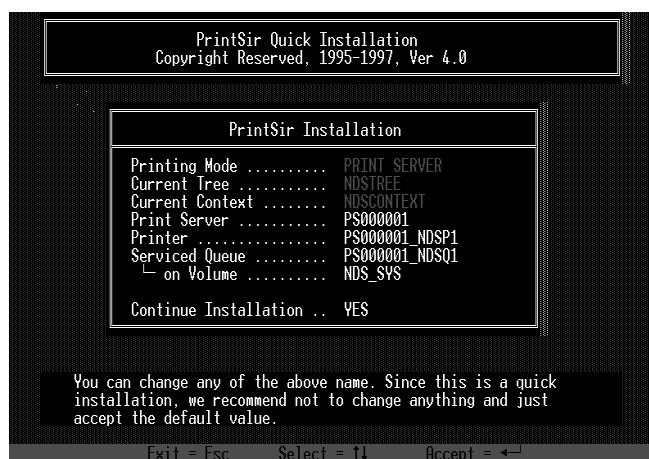

The Current Tree and Current Context settings cannot be changed within the INSTALL program. If you need to change the tree or context where the PrintSir will be installed, use the CX command to change them before starting INSTALL program.

6. The quick installation program will not only set up the PrintSir, but create and setup all required objects on the network. When the setup is complete, it will also display an execution command as

following that you can run after logging in to the file server to redirect print commands to the new PrintSir.

7. Reset the PrintSir to have the changes take effect.

NOTE: The PrintSir may require up to a minute after power-up to log into a NetWare Directory Services context because of the large number of calculations NDS security requires.

5.3.2 NetWare 4.x/5.x Installation Using PSETUP

5.3.2.1 Configuring as Print Server Mode

For more complex setup needs, you can use the PSETUP program in conjunction with the NetWare PCONSOLE program.

To install the PrintSir using NetWare Directory Services (NDS) mode,

1. Log in to your NetWare server as ADMIN.
2. Run the PSETUP program included on the PrintSir CD-ROM. (ex. e:\dosutil\psetup.exe)
3. Select your new PrintSir from the list provided.
4. Choose *NetWare Configuration* from the menu.
5. Select *Print server* in the Printing mode field.
6. Change *Alias name* if you want.
7. Set the NDS tree and NDS context where the PrintSir will be located. Do **NOT** set a Primary file server, as that would force the use of bindery mode.
8. Press *Escape* to exit the PrintSir Configuration screen, confirm that the changes should be saved, and exit PSETUP.
9. Run the NetWare PCONSOLE program.

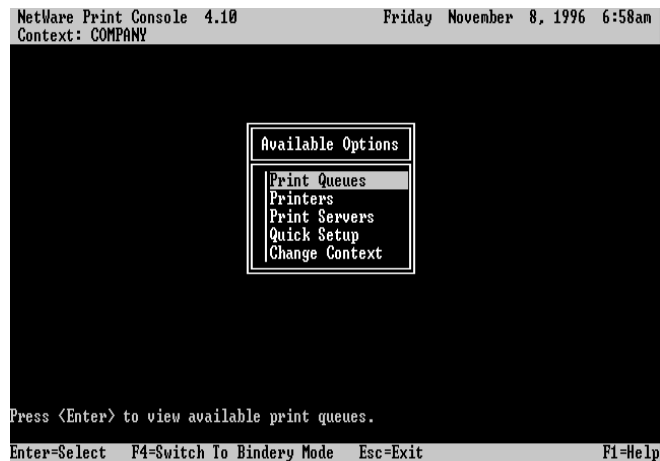

10. Change the current context, if necessary, using the *Change Context* menu selection.
11. Choose Quick Setup from the menu.

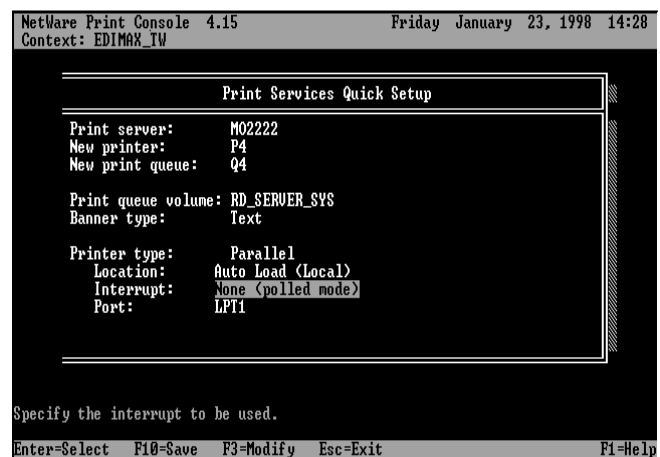

12. Enter the PrintSir name (either the PSxxxxxx name or an alias name you have assigned) in the Print server field.
13. Assign printer and print queue names.
14. Set the *Banner type* to *PostScript* if you are using a PostScript printer, and to Text otherwise.
15. Press F10 to save the new configuration.
16. Reset the PrintSir to have the changes take effect.

NOTE: The PrintSir may require up to a minute after power-up to log into a NetWare Directory Services context because of the large number of calculations NDS security requires.

Your PrintSir should now be ready for use by workstation users. You should be able to redirect printing to your PrintSir using a CAPTURE command.

5.3.2.2 Configuring as Remote Printer Mode

This remote printer feature is not available for the 10/100Mbps 3-port PrintSir models. Make sure that you have created the NetWare print server with Type Remote using PCONSOLE utility before you configure the PrintSir. For more detailed information about PCONSOLE, please refer to NetWare's manual. You can set up the NetWare print server, print queue and printer objects by following the steps below:

1. Run the NetWare *PCONSOLE* program.
2. Change the current context, if necessary, using the *Change Context* menu selection.



3. Choose Quick Setup from the menu.

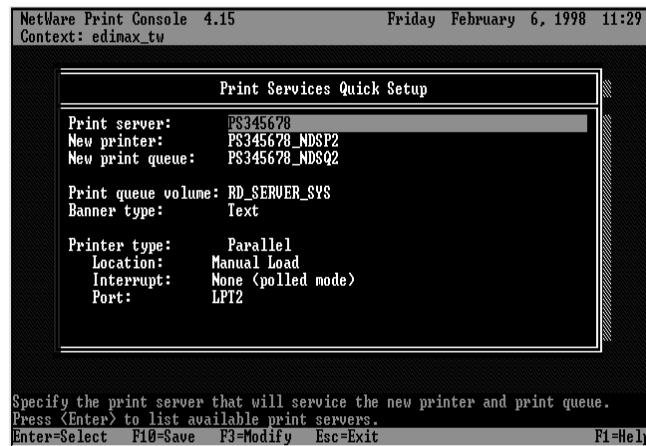

4. Enter the print server name in the Print server field.
5. Assign printer and print queue names.
6. Set the *Banner type* to *PostScript* if you are using a PostScript printer, and to *Text* otherwise.
7. Set the *Location* to Manual Load.
8. Press *F10* to save the new configuration and return to the main menu.
9. Choose *Printers* menu.
10. Select your newly created Printer from the *Printers list*.
11. You can view or edit the Printer number from 0 to 255.
12. Save the new configuration and exit *PCONSOLE*.

You must load NetWare print server on the NetWare file server so that the PrintSir configured as a remote printer can connect to that print server and service the print jobs. To load the NetWare print server, type “**LOAD PSERVER.NLM PrintServer**” command at the system console of the NetWare file server, where *PrintServer* is the print server name newly created by the *PCONSOLE* program.

To configure the PrintSir as a NetWare remote printer, perform the following steps:

1. Log in to your NetWare server as ADMIN.
2. Run the *PSETUP* program included on the CD-ROM. ex: e:\DOSUTIL\psetup.exe
3. Select your new PrintSir from the list provided.
4. Choose *NetWare Configuration* from the menu.
5. Select *Remote Printer* in the Printing mode field.

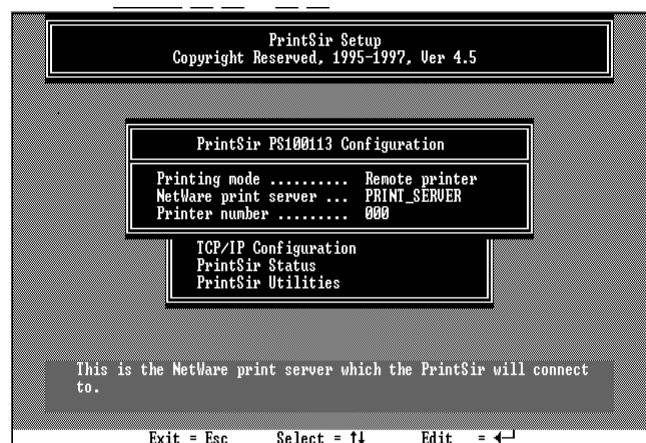

6. Type the print server's name in the *Print server* field. The print server will be serviced by the PrintSir that is being configured as a remote printer now.

7. Type the printer number assigned in *PCONSOLE* in the *Printer Number* field.
8. Press *Escape* to exit the NetWare Configuration screen, confirm that the changes should be saved, and exit *PSETUP*.
9. Reset the PrintSir to have the changes take effect.

6. UNIX System Network

6.1 Introduction

The PrintSir is available for TCP/IP printing by Unix lpd (Line Printer Daemon) protocol. The lpd protocol originated with Unix release is based on the BSD version of Unix and supported under most versions of Unix.

This chapter explains how to configure the PrintSir for TCP/IP operation, and how to modify configuration files on your Unix system to allow printing to the PrintSir. The configuration examples in this manual follow the syntax for BSD based Unix systems. Please refer to the related system documentation for the correct syntax of your systems.

To configure the PrintSir for lpd printing, perform the procedures below:

- 1. Enable PrintSir's TCP/IP Support.**
- 2. Set up PrintSir's IP address.**
- 3. Verify PrintSir's IP Address.**
- 4. Configure remote lpd printing on the host.**
- 5. Print a test page.**

In the next sections, we will describe these five procedures step by step.

6.2 Enable PrintSir's TCP/IP Support

The default configuration of the PrintSir is with TCP/IP support enabled. Anyway, you can configure the PrintSir to enable TCP/IP support using the configuration program or PSETUP program in the CD-ROM included with the PrintSir.

6.3 Setup PrintSir's IP Address

The PrintSir must have a unique IP address in order to be recognized by the network.

You can set up the IP address on the various Unix systems using any one of the following methods:

1. **ARP & Ping Assignment (Recommend for Unix)**
2. **DHCP (Dynamic Host Configuration Protocol)**
3. **BOOTP (Bootstrap Protocol)**
4. **RARP (Reverse Address Resolution Protocol)**

The PrintSir will use the last three methods to obtain its IP address automatically if its IP address is configured as Auto (0.0.0.0).

6.3.1 ARP & Ping Assignment

You can use ARP and Ping commands with a web browser to complete PrintSir's IP address setting.

Parameters for the commands are as follows:

```
arp -s <IP Address> <Ethernet ID>
```

```
ping <IP Address>
```

For example, a PrintSir with the following configuration:

```
Node ID: 0000B4010101
```

(the Node ID is printed on the rear side of the PrintSir)

```
Assign IP address: 203.66.191.12
```

```
arp -s 203.66.191.12 00-00-B4-01-01-01
```

```
ping 203.66.191.12
```

At the mean time, PrintSir's IP will "temporarily" be set to 203.66.191.12 (will restore after reboot). Therefore, you need to run your web browser to set a permanent IP address (refer to section 8.3.7 for detailed IP configuration).

6.3.2 DHCP

There are many Unix systems that support DHCP protocol, and the procedures to configure the DHCP server database are different. This manual does not describe the DHCP server configuration on the Unix systems. It is highly recommended that the DHCP server should be located on the same network as the PrintSir.

6.3.3 BOOTP

If you have the BOOTP daemon, bootpd, running on your UNIX system that is accessible by the PrintSir, you can use the BOOTP protocol to set up the IP address of the PrintSir. We recommend that the BOOTP

server should be located on the same subnet as the PrintSir. If you use Network Information Services (NIS) in your system, you may need to rebuild the NIS map with the BOOTP services before doing the following BOOTP configuration. To rebuild the NIS map, please refer to your system documentation.

To configure the IP address data for the BOOTP server, you will need to log in the host of BOOTP server as the super user (root). Perform the following steps to add address entries,

1. Optionally, assign a name corresponding to the PrintSir's IP address. You can add this address to the /etc/hosts file, by adding a line such as:

```
203.66.191.12          pserver
```

2. Add an entry to the host's /etc/bootptab file, similar to the following:

```
hostname:\  
  
:ht=1:\  
  
:ha=print_server_ethernet_address:\  
  
:ip=print_server_ip_address:
```

Lines should be indented with tabs.

Where `hostname` is the device name of a PrintSir, the `ht=1` tag specifies the hardware type is Ethernet, the `ha=` tag specifies the Ethernet address of a PrintSir, which is the Node ID located on the PrintSir. The `ha` tag must be preceded by the `ht` tag. The `ip=` tag should

correspond to the IP address you want to assign to the PrintSir.

For example, a PrintSir with the following configuration:

Node ID: 0000B4010101 (this implies Ethernet
address is 0000B4010101),

IP address: 203.66.191.12

The entry for this PrintSir in the /etc/bootptab file should be:

```
PS010101:\  
  
:ht=1:\  
  
:ha=0000B4010101:\  
  
:ip=203.66.191.12:
```

6.3.4 RARP

The procedure below enables the RARP daemon running on your system to respond to a RARP request from the PrintSir and to assign the IP address to the PrintSir.

1. Log in the host of RARP server as the superuser (root).
2. Assign a name corresponding to the PrintSir's IP address. You can add this address to the /etc/hosts file, by adding a line such as:

```
203.66.191.12      pserver
```

3. Add the Ethernet address and the host name for the PrintSir to the `/etc/ethers` file, by adding a line such as:

```
00:00:B4:01:01:01    pserver
```

Where the Ethernet address of the PrintSir is the Node ID located on the PrintSir.

4. If your system uses Network Information Services (NIS), you will need to make changes to the NIS host and ethers databases.
5. Check if the RARP daemon is running using the `ps` and `grep` commands. If the RARP daemon is not running on your host, type “`rarpd -a`” to run the RARP server.

6.4 Verify PrintSir's IP Address

To verify that your PrintSir is responding to the newly assigned IP address using a PING command:

```
ping ip-address
```

6.5 Configure Remote lpd Printing on the Host

The procedure you use to configure your Unix host(s) to allow printing to your network remote print server varies between different varieties of Unix. The procedure below can be used for Unix variants that are related to BSD Unix, such as SunOS or Linux. For other versions of Unix, consult your system documentation, keeping in mind that:

- 1. The PrintSir should be treated as a BSD networked print server host.**
- 2. The host name should be the name (or IP address) that you have assigned to the PrintSir.**
- 3. The printer name (or queue name) on the remote host should be lpt1, lpt2 or lpt3, the name of the parallel port on the PrintSir.**

You will need to perform the tasks below, logged in as the superuser (root). To configure your Unix host for printing,

1. Optionally, assign a name corresponding to the PrintSir's IP address. You can add this address to the /etc/hosts file, by adding a line such as:

```
203.66.191.186          pserver
```

2. Create a spool directory for the printer in the same directory where spool directories are normally kept on the machine, such as /var/spool or /var/spool/lpd:

```
mkdir /var/spool/lpd/pserverd
```

```
chown daemon /var/spool/lpd/pserverd
```

```
chgrp daemon /var/spool/lpd/pserverd
```

```
chmod 775 /var/spool/lpd/pserverd
```

3. Add an entry to the host's /etc/printcap file, similar to the following:

```
printer-name:\
```

```
:lp=:\
:rm=203.66.191.186:\
:rp=lpt1:\
:lf=/var/spool/lpd/pserverd.log:\
:sd=/var/spool/lpd/pserverd:\
:mx#0:
```

Lines should be indented with tabs. More than one printer name can be used, with variants separated by vertical bars (name1|name2).

The `rm=` entry should correspond to the IP address you have assigned to the PrintSir. You can also use a host name if you have assigned one in the `/etc/hosts` file.

The `sd=` entry should correspond to the spool directory you created in the previous step.

The `rp=` entry should correspond to the port name of the remote printer. The values should be one of `lpt1`, `lpt2` or `lpt3` depends on the printer port.

The PrintSir should now be available for printing from your Unix host.

6.6 Print a Test Page

To print to the PrintSir, you can use the `lpr` command:

```
lpr -Pprinter-name file ...
```

or, you can use the `lp` command on SCO Open Server:

```
lp -d printer-name file ...
```

Where printer-name is one of the names for the printer in the /etc/printcap file, which you created in the previous step.

Consult your system documentation for more information about printer configuration and administration and about lpr and other printing commands.m

7. Configuration Utility

7.1 Introduction

This chapter introduces PrintSir's system configuration utility in Windows environment. This utility is automatically installed during Windows Administrator Utility installation procedure - refer to section 3.2 and 3.3 (see below).

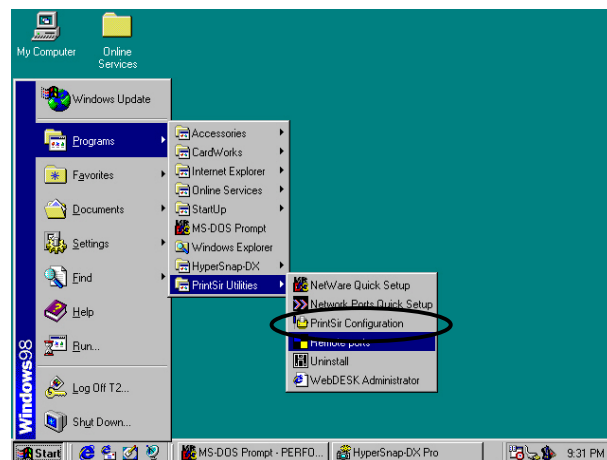

This utility provides the most complete management and configuration functions on the PrintSir server side. This utility only provides configuration functions for PrintSir itself; it does not include configuration functions for client side or other file server or NetWare server in the network environment.

The Configuration Utility provides the following configuration and management functions:

- General** : General Information of PrintSir
- PrintSir Status** : PrintSir Network Status
- Printer Status** : Attached Printer Status
- IP Cfg** : IP Address Configuration

- NW PS Cfg** : NetWare Print Server Configuration
- NW RP Cfg** : NetWare Remote Printer Configuration
- NW Information** : NetWare Printing Summary
- PrintSir Cfg** : PrintSir Network Ability Setting
- Restore Default** : Restore to Default Value
- Upgrade** : Firmware Upgrade / Update
- DHCP Cfg** : DHCP Server Configuration
- DHCP Information** : DHCP Information
- Mail Print Cfg** : Email Printing Setting
- SNMP Cfg** : SNMP Parameter Setting

We will explain each function separately in the following section.

7.2 General - General Information of PrintSir

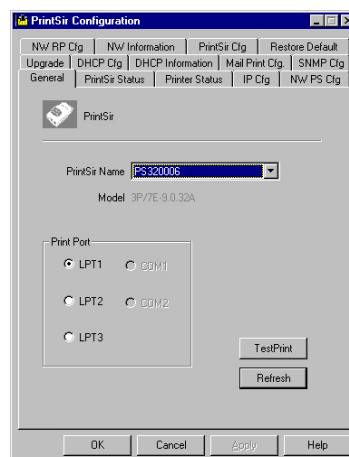

- Every time when you run PrintSir's configuration utility, the system will initially delay for several seconds because the utility is using system's available network protocols to search for all PrintSirs on the network. Therefore, you must first

select the PrintSir you would like to configure from the *PrintSir Name*'s field under the *General* tag. The system will, at the same time, display the selected PrintSir's model number and firmware version.

- You may select any available printer port in the *Printer Port*'s field at the bottom of that page, and then press the “*TestPrint*” button to test print.
- By pressing the “*Refresh*” button, you may manually search again for PrintSirs on the network for you to select a newly added PrintSir.

7.3 PrintSir Status - PrintSir Network Status

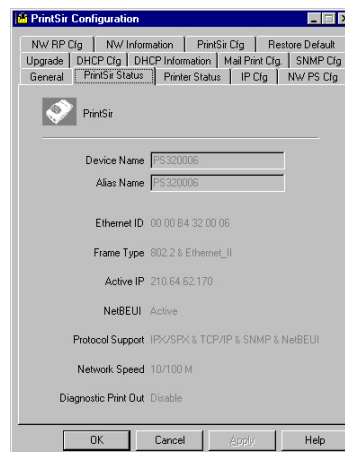

The *PrintSir Status* page displays the network ability and status of the PrintSir in detail.

7.4 Printer Status - Attached Printer Status

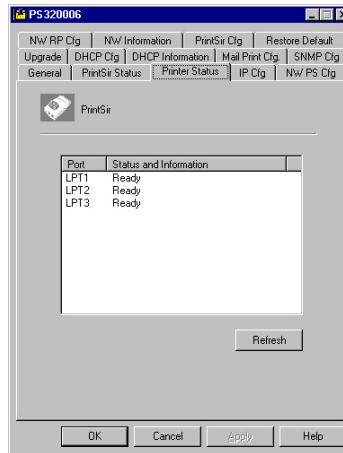

The *Printer Status* page displays the printer status for each port.

7.5 IP Cfg - IP Address Configuration

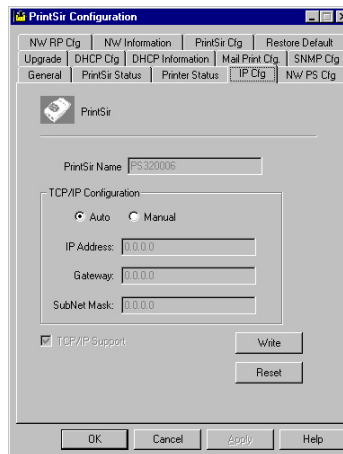

The *IP Cfg* page allows you to configure the IP address where the PrintSir is to be located. The PrintSir will obtain its IP address automatically if you configure the IP address as *Auto*.

Click *Write* button to save the configuration to the PrintSir and Click *Reset* button to reset the PrintSir and have the changes take effect.

7.6 NW PS Cfg - NetWare Print Server Configuration

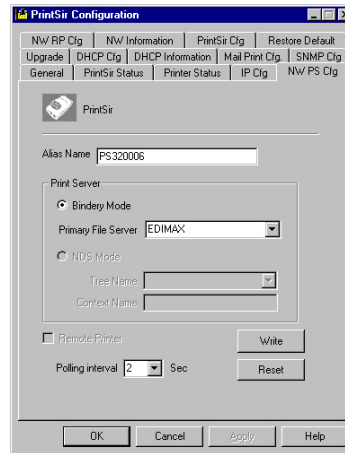

The NW PS Cfg page allows you to set:

- **The Alias name**, a nickname by which the PrintSir can be called (in addition to the PSxxxxxx name printed on the label).
- **The operation mode**, which determines how the PrintSir logs to the network between **Bindery mode** and **NDS mode**.
- **The primary file server** where the NetWare print server object is located, or the print server's NDS tree and context.
- **The remote printer**, which determines if the PrintSir works at remote printer mode.
- **The polling interval**, which determines how often the PrintSir checks the print queues.
- The **Write** button: save the configuration to the PrintSir.
- The **Reset** button: reset the PrintSir to let the changes take effect.

7.7 NW RP Cfg - NetWare Remote Printer Configuration

The *NW RP Cfg* page allows you to set:

- **The Print Server**, which will be serviced by the PrintSir configured as a remote printer.
- **The Printer Number**, which is assigned in PCONSOLE.
- **The remote printer**, which determines if the PrintSir works at remote printer mode.
- **The Write button**: save the configuration to the PrintSir.
- **The Reset button**: reset the PrintSir to let the changes take effect.

7.8 NW Information - NetWare Printing Summary

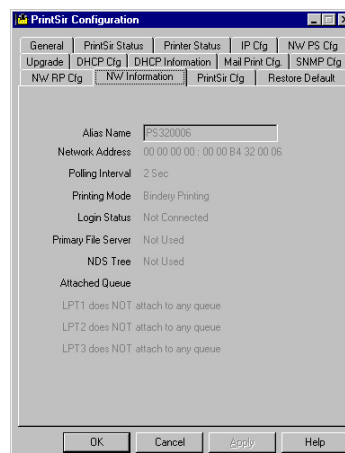

The *NW Information* page displays the PrintSir connection information for NetWare.

7.9 PrintSir Cfg - PrintSir Network Ability Setting

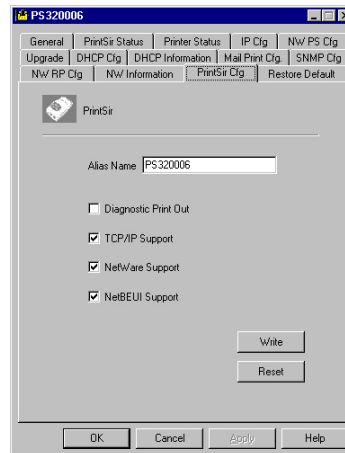

The PrintSir Cfg page allows you to set:

- **The Diagnostic Printout**, which determines whether or not a diagnostic printout should be printed on the printer to which the PrintSir is connected.
- **The TCP/IP Support**, which determines whether or not TCP/IP network printing is supported
- **The NetWare Support**, which determines whether or not NetWare network printing is supported
- **The NetBEUI Support**, which determines whether or not NetBEUI network printing is supported
- **The Write button**: save the configuration to the PrintSir.
- **The Reset button**: reset the PrintSir to let the changes take effect.

7.10 Restore Default - Restore to Default

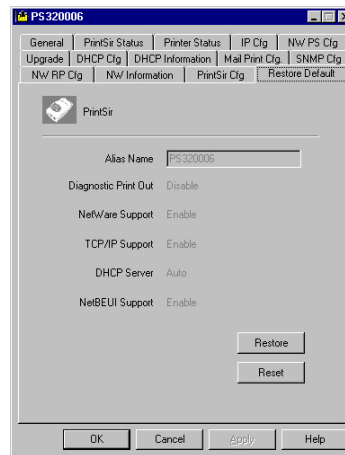

The **Restore Default** page allows you to erase all of the PrintSir's settings and restore them to the default settings the PrintSir had when it was shipped from the factory.

- **The Restore button:** save the default configuration displayed in this page to the PrintSir.
- **The Reset button:** reset the PrintSir to let the changes take effect.

7.11 Upgrade - Firmware Upgrade / Update

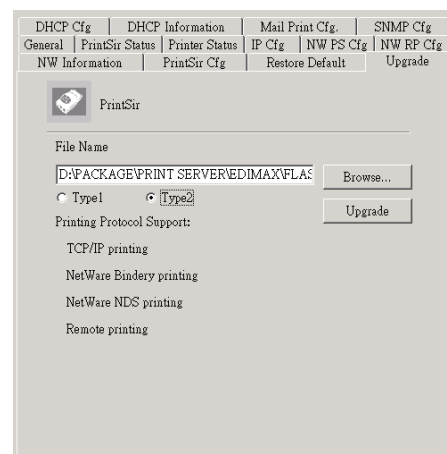
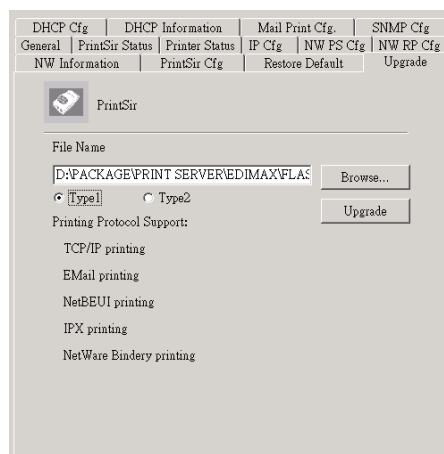

The PrintSir stores its internal programs in “flash” memory, which you can upgrade when new versions of the PrintSir’s software become available or when you want to switch between “*Standard Feature Set - Type 1*” or “*NetWare Enhancement Feature Set – Type 2*” -- The difference between these two feature sets is described at Chapter 1.6.(Contact your dealer for information about software upgrades.) To perform an upgrade,

- Make sure the updated PSxxROM.BIN (depending on your model) file is stored in your computer or CD-ROM.
- Choose the updated firmware in File Name field. For example,

<CD Driver>\FLASHROM\<<Model Name>\PSxxROM.BIN

- Choose the suitable Feature Set (“*Standard Feature Set - Type 1*” or “*NetWare Enhancement Feature Set – Type 2*”) and then click **Upgrade button** to upgrade the PrintSir’s flash memory. The yellow Status LED on the PrintSir should be lit continuously.

7.12 DHCP Cfg - DHCP Server Configure

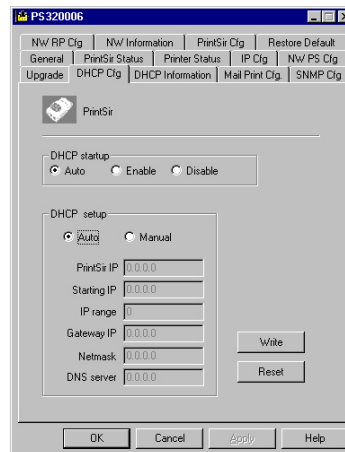

The PrintSir can be configured as DHCP server to provide dynamic IP addresses assignment. The DHCP Cfg page allows you to set:

- **The DHCP startup**, which determine if the PrintSir will act as DHCP server. If this item is set to *Auto*, the PrintSir will detect if there is any DHCP server on the network when it boots up. If there is no DHCP server on the network, then the PrintSir will configure itself as DHCP server; otherwise it will disable this function.
- **DHCP setup** is used to configure TCP/IP parameters that will be assigned to a DHCP client. If this item is set to Auto, the PrintSir will determine all TCP/IP parameters automatically; otherwise you will configure the following parameters:
- **IP Address**: specifies the IP address of PrintSir itself.
- **Starting IP**: specifies the starting IP address for assigning to DHCP clients.

- **IP range:** specifies how many IP addresses are available to DHCP clients.
- **Gateway IP:** gives the IP address of the default gateway.
- **Netmask:** gives the network mask.
- **DNS server:** gives the IP address of the domain name server.
- **The Write button:** save the configuration to the PrintSir.
- **The Reset button:** reset the PrintSir to let the changes take effect.

7.13 DHCP Information - DHCP Information

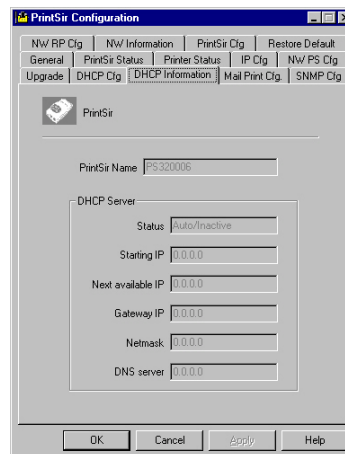

The DHCP Information page can be used to display the DHCP server information when the PrintSir is with DHCP server function.

- **The status:** displays if the PrintSir acts as DHCP server or not.

- **Starting IP:** displays the starting IP address for assigning to DHCP clients.
- **Next available IP:** displays the next available IP address that can be assigned to a DHCP client.
- **Gateway IP:** displays the configured IP address of the default gateway.
- **Netmask:** displays the configured network mask.
- **DNS server:** displays the configured IP address of the domain name server.

7.14 Mail Print Cfg - Email Printing Setting

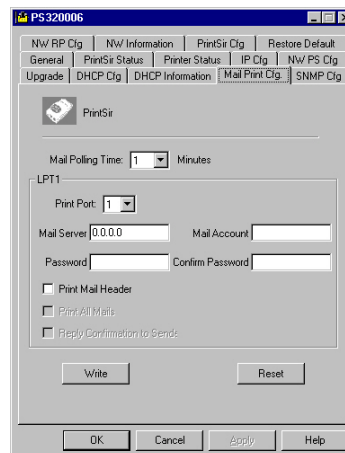

Using PrintSir's email printing function, the client user on the Internet can email the printing file to a dedicate mailbox, PrintSir will automatically get the email from that mailbox and print it to the attached printer. The detail function description is described in the Email Printing Chapter.

The page allows you to set:

- **Mail Polling Time**, default value is zero (1 minute). It means the system polling time for getting the email from mail server.
- **Mail Server**, the mail server IP address of the mailbox located.
- **Mail Account**, the account of the mailbox in the mail server.
- **Mail Password**, the password of the mail account.
- **Confirm Password**, double check the password of the mail account.
- **Print Mail Header**, which determines whether or not the printing job will print out the mail header.

7.15 SNMP Cfg - SNMP Parameter Setting

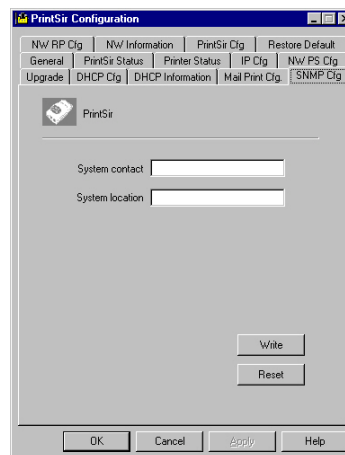

The SNMP Cfg page allows you to configure the SNMP parameters of this PrintSir. These information can be browsed by the SNMP MIB browser.

The page allows you to set:

- **System contact**, the system Administrator information of this PrintSir.
- **System location**, the System location of this PrintSir.

8. Web Management

8.1 Introduction

PrintSir print server can be configured and managed on the Web. Through Local Area Network, or even Internet, administrator can easily configure and manage PrintSir's various main functions in browsers. Simply enter PrintSir's IP address into your browser's address field to manage a print server by PrintSir's built-in Web Server.

In addition, in order to increase the convenience of management, PrintSir provides *WebDESK Utility* to assist you in browsing all PrintSir print servers and managing PrintSir's printing environment on your Local Area Network systematically. Please refer to next section for the instructions of *WebDESK Utility*.

8.2 WebDESK Utility

WebDESK Utility is implemented by WWW Plug-in technology. After the installation of this utility on Windows, you do not need to memorize PrintSir's IP address nor the number of PrintSirs installed on the same network. After executing WebDESK Utility, all PrintSirs on Local Area Network will be detected by the system automatically and listed in the browser. Simply click on the PrintSir you want to configure to access its built-in Web pages.

8.2.1 Installation and Execution

Since WebDESK Utility is a part of Administrator Utility, after installing Windows Administrator Utility, it is already installed. See below for execution of the utility.

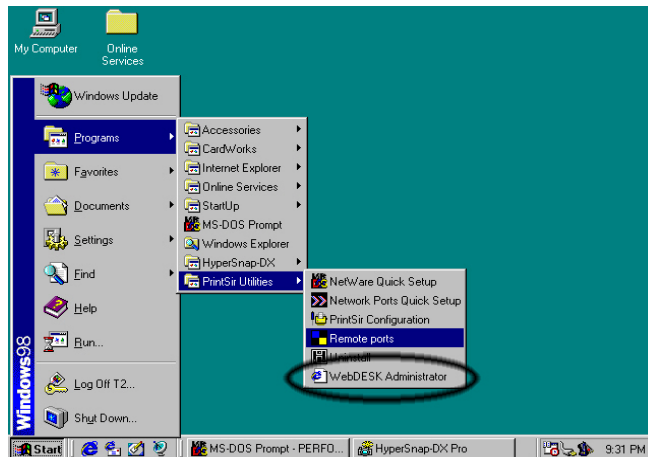

8.2.2 Starting WebDESK Utility

When you execute WebDESK Utility, system will display PrintSir Web Console Page for approximately 5 seconds. At the mean time, system will be searching for all PrintSir print servers on the same subnet.



After searching is completed, the screen will be switched to the following:

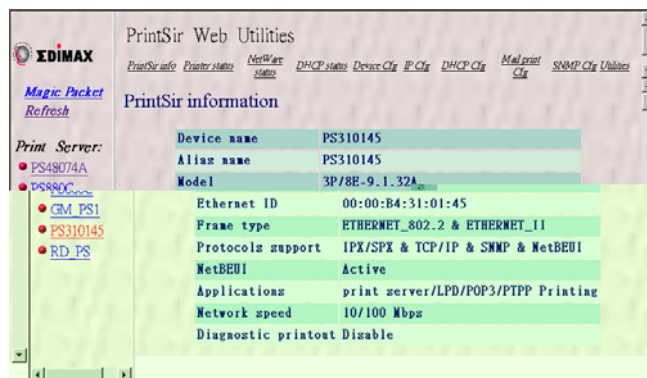

The Window will be split into two parts:

- PrintSir List on the left portion, which lists all PrintSirs found on the same network.
- Web Pages for the selected PrintSir on the right portion, which displays the configuration information for the PrintSir.

In the left frame, click on the PrintSir that you want to manage and configure, then the PrintSir's Web configuration screen will be displayed in the right frame. Instead of executing *WebDESK Utility*, you may also directly enter PrintSir's IP address into the address field of any browser to display its Web management screen. The only difference is that the list in the left frame will not be displayed.

8.3 Web Management of PrintSir

8.3.1 Using Browser

You may use any Web Browser to review the status or configure the settings of the PrintSir. PrintSir's management screen contains three frames:

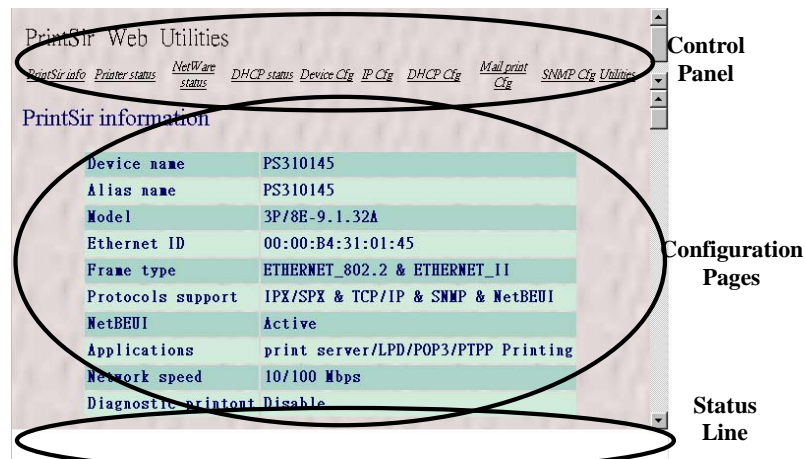

- **Control Panel :**
On the top, which contains several Hypertext links that links to a information or configuration page respectively.
- **Status Line :**
On the bottom, which is used to display warning or error message.
- **Configuration Pages :**
In the middle, which contains several information pages about PrintSir and its attached printer(s), and several configuration pages used to set up PrintSir.

The browser will group the configuration items into the following topics,

- **PrintSir Info:** General Information of PrintSir.
- **Printer Status:** Current status of the attached printers.
- **NetWare Status:** PrintSir connection information of NetWare
- **DHCP status:** Current DHCP server status and information.
- **Device Cfg:** Device configuration
- **IP Cfg:** IP configuration
- **DHCP Cfg:** DHCP parameter configuration
- **Mail Print Cfg:** Email printing configuration
- **SNMP Cfg:** SNMP Information configuration
- **Utilities:** Some utilities to PrintSir

In order to protect your PrintSir, you can get all information pages at any time you like, but you cannot save the configuration pages before password verification. You will be asked to check username and password when you want to save a configuration page and you have not been verified yet. Please ignore the username and enter password at that moment and reload the configuration pages again. The configuration pages will now be displayed in the browser window.

8.3.2 Getting PrintSir Information

Each time you run browser to connect to a PrintSir, you will get this PrintSir information page initially. The PrintSir information page displays some general information of PrintSir.

PrintSir Web Utilities

[PrintSir info](#) [Printer status](#) [NetWare status](#) [DHCP status](#) [Device Cfg](#) [IP Cfg](#) [DHCP Cfg](#) [Mail print Cfg](#) [SNMP Cfg](#) [Utilities](#)

PrintSir information

Device name	PS310145
Alias name	PS310145
Model	3P/8E-9.1.32A
Ethernet ID	00:00:B4:31:01:45
Frame type	ETHERNET_802.2 & ETHERNET_II
Protocols support	IPX/SPX & TCP/IP & SNMP & NetBEUI
NetBEUI	Active
Applications	print server/LPD/POP3/PTPP Printing
Network speed	10/100 Mbps
Diagnostic printout	Disable

8.3.3 Getting Printer Status

The Printer status page can be used to display the status of attached printer(s) for each port.

PrintSir Web Utilities

[PrintSir info](#) [Printer status](#) [NetWare status](#) [DHCP status](#) [Device Cfg](#) [IP Cfg](#) [DHCP Cfg](#) [Mail print Cfg](#) [SNMP Cfg](#) [Utilities](#)

Printer status

Print port	Status
LPT1 Printer status	Ready
LPT2 Printer status	Ready
LPT3 Printer status	Ready
LPT1 Printer info.	No bidirectional information or printer busy
LPT2 Printer info.	No bidirectional information or printer busy
LPT3 Printer info.	No bidirectional information or printer busy

8.3.4 Getting NetWare Information

The NetWare status page displays the NetWare connection information of the PrintSir.

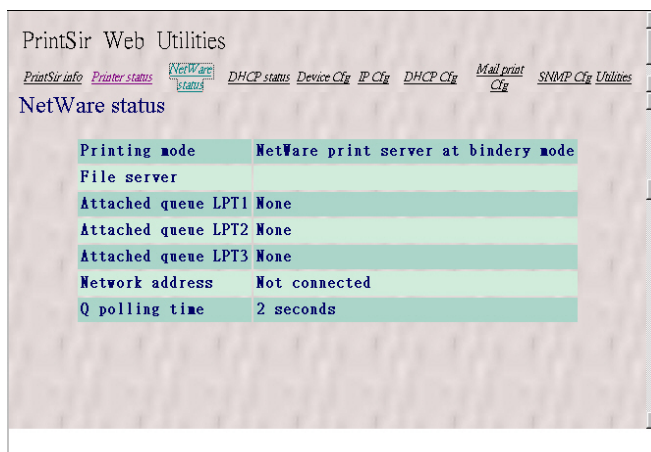

8.3.5 Getting DHCP Status

The DHCP status page can be used to display the DHCP information when the PrintSir's client DHCP function is enabled.

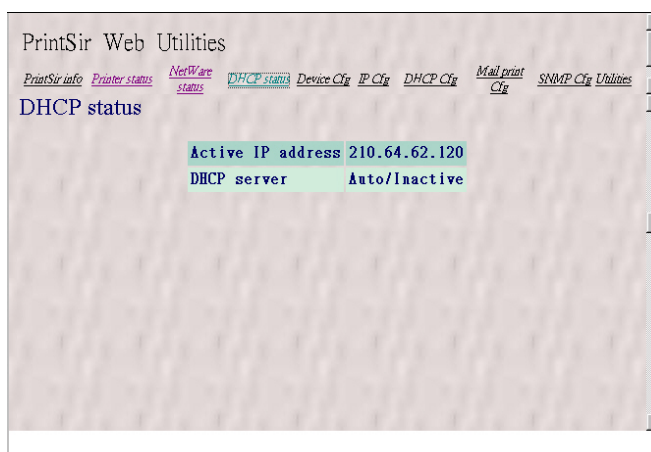

8.3.6 Changing Device Configuration

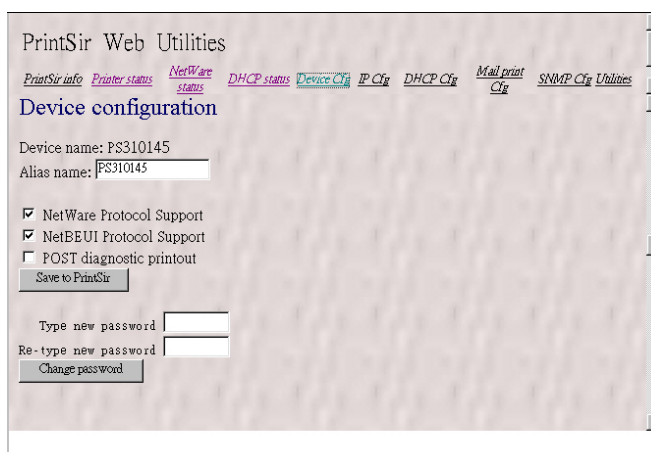

The Device Cfg page allows you to set:

- *Alias name*, an alternate name by which the PrintSir can be called (in addition to the PSxxxxxx name printed on the label).
- *NetWare Protocol Support*, which determines whether or not the PrintSir support NetWare printing function.
- *NetBEUI Protocol Support*, which determines whether or not the PrintSir support NetBEUI network protocol.
- *POST diagnostic printout*, which determines whether or not a diagnostic printout should be printed to the attached printer.
- *Save to PrintSir button*: save the configuration to the PrintSir.
- *Type new password*, change to new password.
- *Re-type new password*, confirm the new password.
- *Change password button*: save the new password to the PrintSir.

The PrintSir will verify your password (it will ignore the User Name item) when you save the configuration.

Make sure to reset the PrintSir (described in section 8.3.11 *System Utilities*) to let the changes take effect.

8.3.7 Setting IP Address

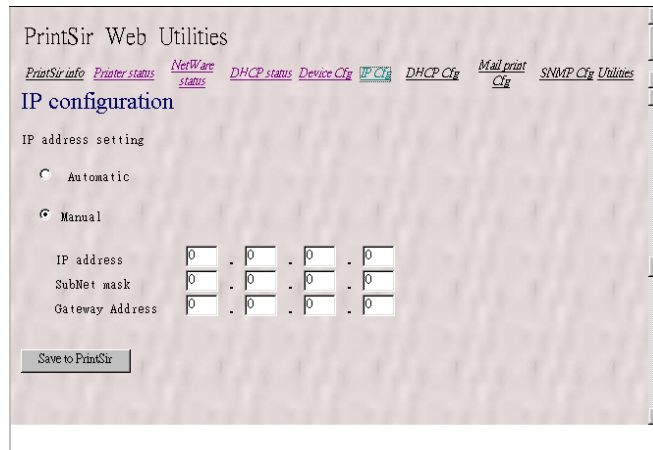

The screenshot shows the 'PrintSir Web Utilities' interface. At the top, there is a navigation menu with links: [PrintSir info](#), [Printer status](#), [NetWare status](#), [DHCP status](#), [Device Cfg](#), [IP Cfg](#) (highlighted), [DHCP Cfg](#), [Mail/print Cfg](#), [SNMP Cfg](#), and [Utilities](#). Below the navigation is the 'IP configuration' section. It features 'IP address setting' with two radio buttons: 'Automatic' (unselected) and 'Manual' (selected). Under the 'Manual' option, there are three rows of input fields: 'IP address', 'SubNet mask', and 'Gateway Address'. Each row contains four individual input boxes, each with the number '0' inside. A 'Save to PrintSir' button is located at the bottom of the form.

The IP Cfg page allows you to configure the IP address where the PrintSir is to be located. The PrintSir will obtain its IP address automatically by the protocol DHCP, BOOTP, RARP if you configure the IP address as Auto. Click Save to PrintSir button to save the configuration to the PrintSir.

The PrintSir will verify your password (it will ignore the User Name item) when you save the configuration. Make sure to reset the PrintSir (described in section 8.3.11 *System Utilities*) to let the changes take effect.

8.3.8 Configuring DHCP Parameters

The PrintSir can be configured as DHCP server to provide dynamic IP addresses assignment. The DHCP Cfg page allows you to set:

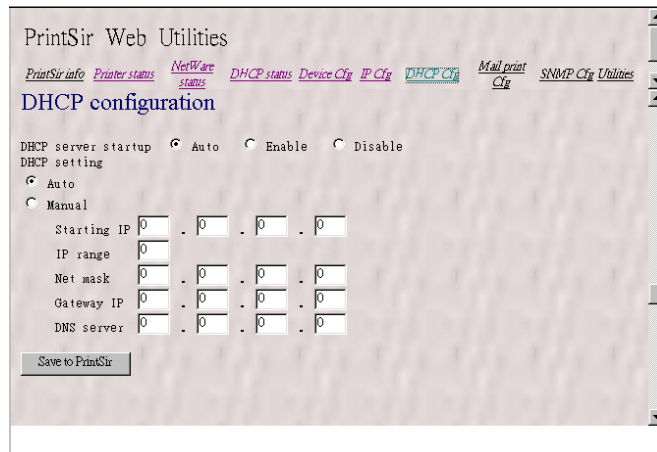

- The DHCP server startup, which determine if the PrintSir will act as DHCP server. If this item is set to Auto, the PrintSir will detect if there is any other DHCP server on the network when it boots up. If there is no DHCP server on the network, then the PrintSir will configure itself as DHCP server; otherwise it will disable this function.
- DHCP setting is used to configure TCP/IP parameters that will be assigned to a DHCP client. If this item is set to Auto, the PrintSir will determine all TCP/IP parameters automatically; otherwise you will configure the following parameters:
 - ❑ Starting IP: specifies the starting IP address for assigning to DHCP clients.
 - ❑ IP range: specifies how many IP addresses are available to DHCP clients.
 - ❑ Net mask: gives the network mask.
 - ❑ Gateway IP: gives the IP address of the default gateway.
 - ❑ DNS server: gives the IP address of the domain name server.

- The Save to PrintSir button: save the configuration to the PrintSir.

Make sure to reset the PrintSir (described in the section 8.3.11) to have the changes take effect.

8.3.9 Configuring E-Mail Printing

PrintSir Web Utilities

[PrintSir info](#) [Printer status](#) [NetWare status](#) [DHCP status](#) [Device Cfg](#) [IP Cfg](#) [DHCP Cfg](#) [Mail print Cfg](#) [SNMP Cfg](#) [Utilities](#)

Mail printing configuration

Mail Polling Time (minute):

LPT1:

Mail server: . . .

Mail account:

Mail Password:

Print mail header

LPT2:

Mail server: . . .

Mail account:

Using PrintSir's email printing function, the client user on the Internet can email the printing file to a dedicate mailbox, PrintSir will automatically get the email from that mailbox and print it to the attached printer. The detail function description is described in the Email Printing Chapter.

The page allows you to set:

- **Mail Polling Time**, default value is zero (1 minute). It means the system polling time for getting the email from mail server.
- **Mail Server**, the mail server IP address of the mailbox located.
- **Mail Account**, the account of the mailbox in the mail server.
- **Mail Password**, the password of the mail account.

- **Print Mail Header**, which determines whether or not the printing job will print out the mail header.

8.3.10 Configuring SNMP Parameters

The SNMP Cfg page allows you to configure the SNMP parameters of this PrintSir. These information can be browsed by the SNMP MIB browser.

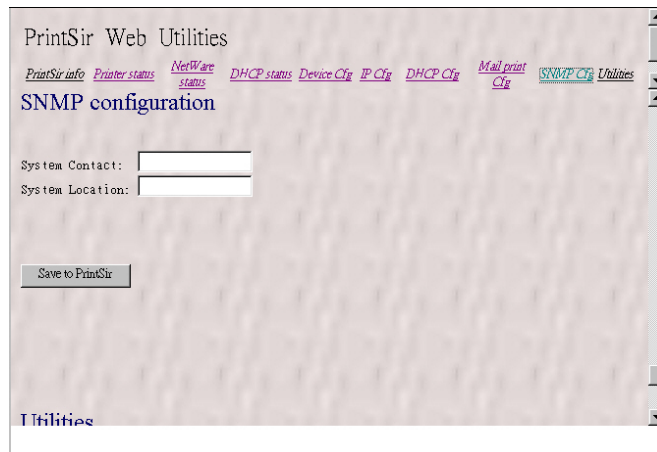

The page allows you to set:

- **System Contact**, the system Administrator information of this PrintSir.
- **System Location**, the System location of this PrintSir.

8.3.11 System Utilities

You can perform several tasks from this Utilities page, as described below:



- The Software reset: which determines whether or not to reset the PrintSir.
- The Restore to factory default: which determines whether or not to erase all of the PrintSir's setting and restore to the default configuration the PrintSir had when it was shipped from the factory.
- The Print diagnostic page: which determines whether or not to print a diagnostic page to a attached printer connected at either LPT1, LPT2 or LPT3 of the PrintSir. This feature can be used to test the PrintSir to make sure it is operating properly, or to isolate any installation problems.
- The Do it button: do the action specified in the above.

9. Email Printing

9.1 Introduction

Email Printing provides a new way of printing service. After installation, Windows will establish a new Printer Driver which will convert the printing document to an Email and send to the mail account assigned by PrintSir. PrintSir will periodically retrieve Emails in the mail account and print it to the attached printer directly.

9.2 System Requirement

9.2.1 Print Server Side

PrintSir must be connected to an Email server that provides an Email account for the PrintSir. At the meantime, the Email server has to permanently connect to the Internet for receiving user's email printing documents.

9.2.2 Client Side

- Client side can be any operating systems with a mailing tool.
- Client Side must be able to connect to an SMTP Email server for sending email. ◦
- Client Side must install and setup TCP/IP protocol for Internet connection.
- If you use the first printing service described in the next section, please install the Printing Driver for Email Printing provided in the CD-ROM.

9.3 System Setup

9.3.1 Print Server Side

Step1.Execute the PrintSir Configuration Utility ◦

Step2.In the IP Cfg page, configure the IP address.

Step3.In the Mail Print Cfg page , configure Mail polling time and Mailbox parameters.

Mail Polling Time : Default is 1 minute;
Intervals for PrintSir to check
Emails in the Mailbox.

Mail Server, Mail Account and Password are
Mailbox's Email server's IP
address, account, and password
respectively.

Step4. Press "Write" then "Reset" button.

9.3.2 Client User Side

At first, please confirm that the client computer has installed and setup the TCP/IP protocol correctly.

Email Printing provides three printing methods, the instructions and installation are described below:

9.3.2.1 Print directly from appellations by using the “Print to Email printing driver”

At first, the client user needs to install and setup the “*Print to Email Printing Driver*” from the CD-ROM shipped with the PrintSir Package. You can deliver the “Email Printing Driver” to any one who will

print email from its Windows to your printer. The “Email Printing Driver” is implemented as a freeware that can be shared with every one. Please note that the “Email Printing Driver” is designed for Windows only, it can’t be run on any other operating systems.

The installation procedure is as following,

1. Insert the CD shipped along with the print server into your CD-ROM drive. Change the directory to “\Email Printing\English\”
2. Execute “*setup.exe*” program



3. Click “*Next*” and choose a installation path or use the default,



4. Click “*Next*” and assign a program folder name,



5. Click “*Next*” and the system will install the “Email Printing Driver”.

After the installation is completed, you need to configure the Printing Driver of Email Printing as following,

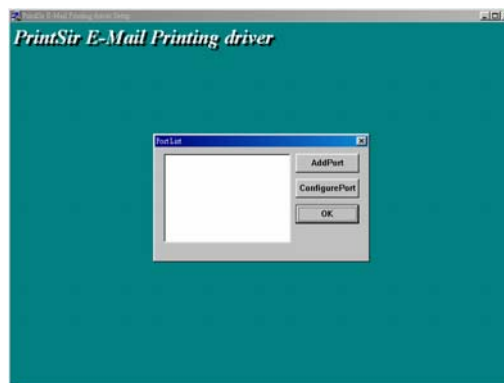

6. Click the “*AddPort*” Button, and you can see the following dialog box,

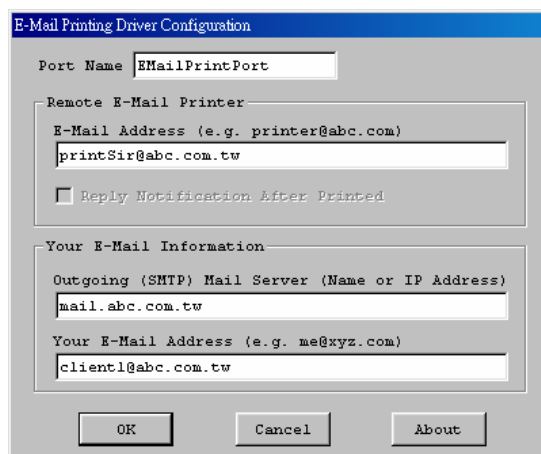

7. Please input the proper value in the fields described as following,

Port Name: The Printer Port Name for Email Printing. It will be used when you execute the “*Add Printer*”

E-Mail Address: The email address serviced by the PrintSir.

Outgoing Mail Server: The mail server of your client computer for sending the email.

Your E-mail address: The information which will be printed at the header of the printing document.

8. Click OK and complete the “*Email printing driver*” installation procedure.

You can then perform the Windows’ standard “**Add Printer**” command and choose the Email Printer Port Name assigned in the above procedure. Please refer section 3.4 for detail “Add Printer” procedure.

9.3.2.2 Directly send an Email to the email account serviced by the PrintSir.

For a client user who want to print a text email to the printer attached by the PrintSir but without the “Email Printing Driver”, he (or she) can, just as usual, run the mailing tool, key in the content and send the email. Please note that the email recipient should be the email address serviced by the PrintSir. The PrintSir will automatically retrieve the email from the email box and print to the attached printer.

9.3.2.3 Send an Email with an attached document to the email account serviced by the PrintSir

For a client user who wants to print a document to the printer attached the PrintSir but without the “Email Printing Driver”, he (or she) can first print the document to a file and send this document file as an email attachment to the email account serviced by the PrintSir. The detailed procedures are described as below:

- Run the application, open the document and select the “Print” function.
- After the Print dialog box appears, click the “Print to File” check box and enter a file name to be saved, then a printing file will be created. The printing file on Windows is with the file extension “.prn”
- Run the mailing tool, create a new email, attach the newly created printing file and enter the Email address serviced by the PrintSir, then send out the email. The PrintSir will automatically retrieve the email from the email box and print the attachment to the attached printer.