

SAFETY SYMBOLS



PRECAUTIONS

1. INTRODUCTION

1-1.Features

1-2.Package Contents

1-3.Controls & Connectors

2. CABLE CONNECTION

2-1.Before Connecting

2-2.Connecting the Signal Cable (D-Sub or DVI)

2-3.Connecting the Signal Cable (ADC)

2-4.Connecting Two PCs to the Monitor

2-5.How to remove the Tilt Stand

3. ScreenManager

3-1.How to use the ScreenManager

3-2.ScreenManager Adjustments and Settings

3-3.FineContrast

3-4.Useful Functions

4. ADJUSTMENT

4-1.Screen Adjustment

4-2.Displaying a low resolution

4-3.Color Adjustment

4-4.Power-save Setup

5. ActiveRotationII Function

6. MAKING USE OF USB (Universal Serial Bus)

7. TROUBLESHOOTING

User's Manual

ColorEdge® CG210

Color Management LCD Monitor

Important

Please read this User's Manual carefully to familiarize yourself with safe and effective usage procedures. Please retain this manual for future reference.

This manual is checked under the browser settings shown below. Text size can change for another one through browser setting.

Microsoft Internet Explorer:

Text size: Medium

Encoding: Western European

8. CLEANING

9. SPECIFICATION

10. GLOSSARY

APPENDIX/ ANHANG/
ANNEXE

About TCO'03(Applicable
gray)





About TCO'99(Applicable
black)

FCC Declaration of
Conformity

Hinweis zur Ergonomie/
Recycling Information/
Hinweise zur Auswahl des
richtigen Schwenkarms für
Ihren Monitor

SAFETY SYMBOLS

This manual uses the safety symbols below. They denote critical information. Please read them carefully.

	WARNING Failure to abide by the information in a WARNING may result in serious injury and can be life threatening.
	CAUTION Failure to abide by the information in a CAUTION may result in moderate injury and/or property or product damage.
	Indicates a prohibited action.
	Indicates to ground for safety.

Copyright© 2005-2006 EIZO NANA O CORPORATION All rights reserved.

No part of this manual may be reproduced, stored in a retrieval system, or transmitted, in any form or by any means, electronic, mechanical, or otherwise, without the prior written permission of EIZO NANA O CORPORATION.

EIZO NANA O CORPORATION is under no obligation to hold any submitted material or information confidential unless prior arrangements are made pursuant to EIZO NANA O CORPORATION's receipt of said information. Although every effort has been made to ensure that this manual provides up-to-date information, please note that EIZO monitor specifications are subject to change without notice.

ENERGY STAR is a U.S. registered mark.

Apple and Macintosh are registered trademarks of Apple Computer, Inc.

VGA is a registered trademark of International Business Machines Corporation.

DPMS is a trademark and VESA is a registered trademark of Video Electronics Standards Association.

Windows is a registered trademark of Microsoft Corporation.

PowerManager is a trademark of EIZO NANA O CORPORATION.

ScreenManager, ColorEdge and EIZO are registered trademarks of EIZO NANA O CORPORATION in Japan and other countries.



As an ENERGY STAR® Partner, EIZO NANA O CORPORATION has determined that this product meets the ENERGY STAR guidelines for energy efficiency.

PRECAUTIONS

IMPORTANT!

- This product has been adjusted specifically for use in the region to which it was originally shipped. If operated outside the region to which it was originally shipped, the product may not perform as stated in the specifications.
- To ensure personal safety and proper maintenance, please read this section and the caution statements on the unit (refer to the figure below).

[Location of the Caution Statements]

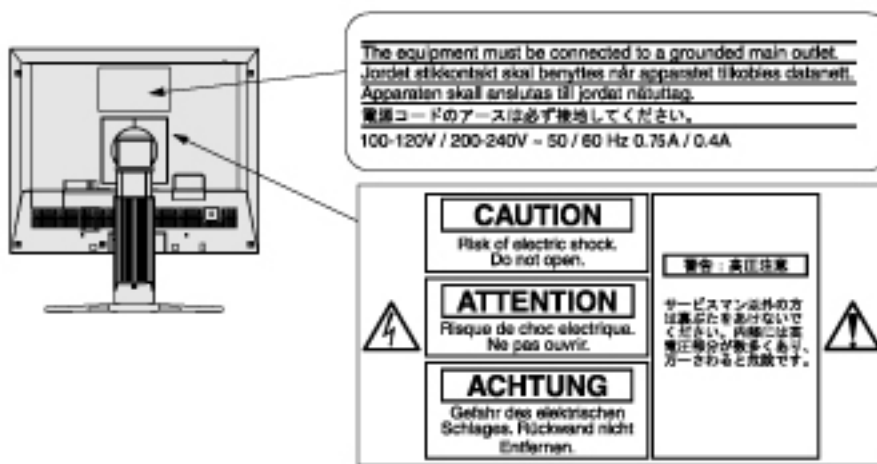

WARNING

If the unit begins to emit smoke, smells like something is burning, or makes strange noises, disconnect all power connections immediately and contact your dealer for advice.

Attempting to use a malfunctioning unit may result in fire, electric shock, or equipment damage.

Do not open the cabinet or modify the unit.

Opening the cabinet or modifying the unit may result in fire, electric shock, or burn.



Refer all servicing to qualified service personnel.

Do not attempt to service this product yourself as opening or removing covers may result in fire, electric shock, or equipment damage.

Keep small objects or liquids away from the unit.

Small objects accidentally falling through the ventilation slots into the cabinet or spillage into the cabinet may result in fire, electric shock, or equipment damage.

If an object or liquid falls/spills into the cabinet, unplug the unit immediately. Have the unit checked by a qualified service engineer before using it again.



Place the unit at the strong and stable place.

A unit placed on an inadequate surface may fall and result in injury or equipment damage.

If the unit falls, disconnect the power immediately and ask your dealer for advice. Do not continue using a damaged unit. Using a damaged unit may result in fire or electric shock.



Set the unit in an appropriate location.

Not doing so may result in fire, electric shock, or equipment damage.

- Do not place outdoors.
- Do not place in the transportation system (ship, aircraft, trains, automobiles, etc.)
- Do not place in a dusty or humid environment.
- Do not place in a location where the steam comes directly on the screen.
- Do not place near heat generating devices or a humidifier.

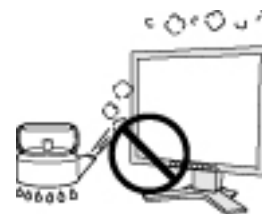

To avoid danger of suffocation, keep the plastic packing bags away from babies and children.

Use the enclosed power cord and connect to the standard power outlet of your country.

Be sure to remain within the rated voltage of the power cord.

Not doing so may result in fire or electric shock.

Power supply: 100-120/200-240 VAC \pm 10 %, 50/60 Hz

To disconnect the power cord, grasp the plug firmly and pull.

Tugging on the cord may damage and result in fire or electric shock.



The equipment must be connected to a grounded main outlet.

Not doing so may result in fire or electric shock.



Use the correct voltage.

* The unit is designed for use with a specific voltage only. Connection to another voltage than specified in this User's Manual may cause fire, electric shock, or equipment damage.

* Do not overload your power circuit, as this may result in fire or electric shock.

Handle the power cord with care.

* Do not place the cord underneath the unit or other heavy objects.

* Do not pull on or tie the cord.



If the power cord becomes damaged, stop using it. Use of a damaged cord may result in fire or electric shock.

Never touch the plug and power cord if it begins to thunder.

Touching them may result in electric shock.

When attaching an arm stand, please refer to the user's manual of the arm stand and install the unit securely.

Not doing so may cause the unit to become unattached, which may result in injury or equipment damage. When the unit is dropped, please ask your dealer for advice. Do not continue using a damaged unit. Using a damaged unit may result in fire or electric shock. When reattaching the tilt stand, please use the same screws and tighten them securely.

Do not touch a damaged LCD panel directly with bare hands.

The liquid crystal that may leak from the panel is poisonous if it enters the eyes or mouth.

If any part of the skin or body comes in direct contact with the panel, please wash thoroughly. If some physical symptoms result, please consult your doctor.



Follow local regulation or laws for safe disposal.

The backlight of the LCD panel contains mercury.

 CAUTION

Handle with care when carrying the unit.

Disconnect the power cord and cables when moving the unit. Moving the unit with the cord attached is dangerous. It may result in injury.

When handling the unit, grip the bottom of the unit firmly with both hands ensuring the panel faces outward before lifting.

Dropping the unit may result in injury or equipment damage.



Do not block the ventilation slots on the cabinet.

- * Do not place any objects on the ventilation slots.
- * Do not install the unit in a closed space.
- * Do not use the unit laid down or upside down.



Blocking the ventilation slots prevents proper airflow and may result in fire, electric shock, or equipment damage.

Do not touch the plug with wet hands.

Doing so may result in electrical shock.



Use an easily accessible power outlet.

This will ensure that you can disconnect the power quickly in case of a problem.

Periodically clean the area around the plug.

Dust, water, or oil on the plug may result in fire.

Unplug the unit before cleaning it.

Cleaning the unit while it is plugged into a power outlet may result in electric shock.

LCD Panel

In order to suppress the luminosity change by long-term use and to maintain the stable luminosity, use of a monitor in lower brightness is recommended.

The LCD panel is manufactured using high-precision technology. However, note that the appearance of any missing pixels or lit pixels does not indicate damage to the LCD monitor.
Percentage of effective pixels:99.9994%or higher.

The backlight of the LCD panel has a fixed life span. When the screen becomes dark or begins to flicker, please contact your dealer.

Do not press on the panel or edge of the frame strongly, as this may result in damage to the screen. There will be prints left on the screen if the pressed image is dark or black. If pressure is repeatedly applied to the screen, it may deteriorate or damage your LCD panel. Leave the screen white to decrease the prints.

Do not scratch or press on the panel with any sharp objects, such as a pencil or pen as this may result in damage to the panel. Do not attempt to brush with tissues as this may scratch the LCD panel.

When the screen image is changed after displaying the same image for extended periods of time, an afterimage may appear. Use the screen saver or timer to avoid displaying the same image for extended periods of time.

When the monitor is cold and brought into a room or the room temperature goes up quickly, dew condensation may occur inside and outside the monitor. In that case, do not turn the monitor on and wait until dew condensation disappears, otherwise it may cause some damages to it.

1. INTRODUCTION

Thank you very much for choosing an EIZO Color Monitor.

1-1. Features

- The exclusive use calibration software calibrates the monitor characteristics and generate color profile.
- Dual inputs compliant
- [DVI](#) Digital input ([TMDS](#)) compliant.
- ADC (Apple Display Connector) inputs compliant.
- [Horizontal scanning frequency]
Analog: 24 - 100 kHz
Digital: 31 - 100 kHz
- [Vertical scanning frequency]
Analog: 49 - 86 Hz (1600 x 1200: 49 - 76 Hz)
Digital: 59 - 61 Hz (VGA text: 69 - 71 Hz)
- [Resolution] 1600 dots x 1200 lines
- Support to [sRGB](#) standard
- The Portrait/Landscape display capability
- [ActiveRotationII function](#) (changing the display orientation of the monitor with the panel rotation) incorporated.
- Attaching the "Adjustment Certificate" to describe the monitor color characteristics individually.
- The height adjustable stand incorporated
- Ultra slim bezel incorporated

1-2. Package Contents

Please contact your local dealer for assistance if any of the listed items are missing or damaged.

- | | |
|---------------------------------|----------------------------------|
| * LCD Monitor | * Setup Guide |
| * Power Cord | * Calibration software |
| * Signal Cable (FD-C39) | "ColorNavigator"(in the CD-ROM) |
| * Signal Cable (FD-C16) | * ColorNavigator Quick Reference |
| * EIZO USB Cable (MD-C93) | * LIMITED WARRANTY |
| * EIZO LCD Utility Disk | * Adjustment Certificate |
| * User's Manual (in the CD-ROM) | |

NOTE

- * Please retain the packing materials for future transference.
- * The "ActiveRotationII Utility" (for Windows) is included in the EIZO LCD Utility Disk. Please refer to the readme.txt in the EIZO LCD Utility Disk for the details.

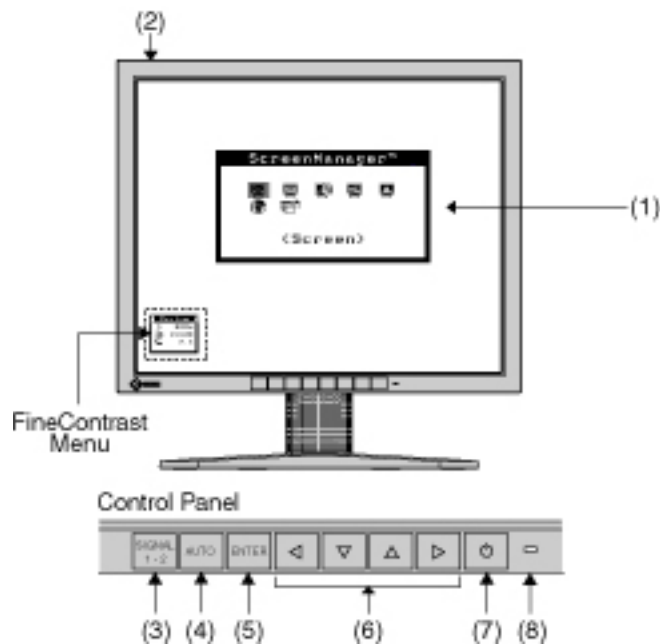
1-3. Controls & Connectors**Front**

- (1) ScreenManager®
- (2) Main Power Switch
- (3) Input Signal Selection Button
- (4) Auto Adjustment Button
- (5) Enter Button
- (6) Control Buttons*¹ (Up, Down, Left, Right)*²
- (7) Power Button
- (8) Power Indicator*³

Blue	Operation
Flashing blue (2 times for each)	Notify that the monitor needs to be recalibrated in CAL mode.
Yellow	Power saving
Flashing yellow slowly	Power is off (Main power is on)

Off	Power off
-----	-----------

- *1 The main menu of ScreenManager and the FineContrast menu cannot be displayed at the same time.
- *2 Directly pressing the left button or the right button allows you to select a FineContrast mode.
Directly pressing the up button or the down button allows you to adjust the brightness of the screen.
- *3 Blue lighting, when the screen is displayed (Operation mode), is made to non-light, see "[Power Indicator](#) "
Regarding the power indicator for the "Off Timer", see "[3-4. Useful Functions](#)".

Rear

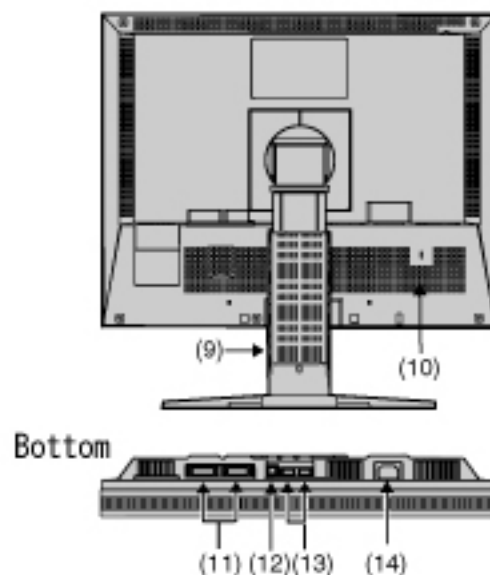

- (9) Height Adjustable Stand (Detachable)*4
- (10) Security Lock Slot*5
- (11) DVI-I Input Connector x 2 (SIGNAL 1 / SIGNAL 2)
- (12) USB Port (1 Upstream)
- (13) USB Port (2 Downstream)
- (14) Power Connector

- *4 The LCD monitor has the capability of the Portrait/Landscape display. (The panel pivots in the clockwise direction 90°.) The LCD monitor can be used with an optional arm stand by removing the stand. (see "[2-5. How to remove the Tilt Stand](#)").

*5 Allows for connection of a security cable. This lock supports Kensington's MicroSaver security system.

For further information, please consult:

Kensington Technology Group

2855 Campus Drive, San Mateo, CA 94403 USA

Tel: 800-650-4242, x3348

Intl: 650-572-2700, x3348 / Fax: 650-572-9675

<http://www.kensington.com>

2. CABLE CONNECTION

2-1. Before Connecting

Before connecting your monitor to the PC, change the display screen settings ([resolution](#) and frequency) in accordance with the [APPENDIX](#) charts.

NOTE

- * When your computer supports VESA DDC, the suitable resolution and the refresh rate are set by just plugging your monitor into the computer without any manual settings.

2-2. Connecting the Signal Cable (For the Computer Employing D-Sub or DVI Connector)

NOTE

- * Be sure that the power switches of both the PC and the monitor are OFF.

1. Plug the signal cable into the connector at the rear of the monitor and the other end of the cable into the video connector on the PC.

After connecting, secure the connection with the screw-in fasteners.

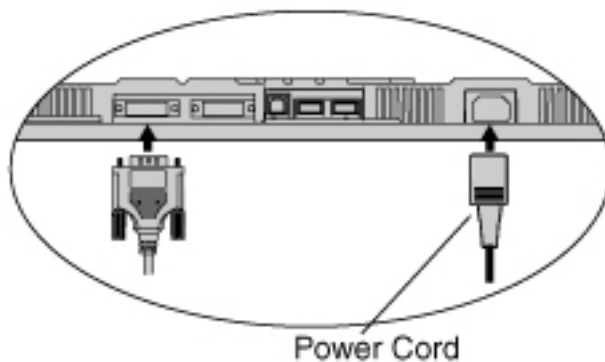

Analog Input

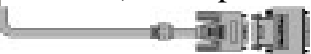
Signal Cable	Connector on PC	PC
Signal Cable (FD-C16 enclosed) 	Video Output Connector / D-Sub mini 15 pin Input Connector (monitor) / DVI	Standard graphics card Macintosh G3 (Blue & White) /Power Mac G4 (VGA)
Signal Cable (FD-C16 enclosed) +Adapter* 	Video Output Connector / D-Sub 15 pin Input Connector (monitor) / DVI	Macintosh

*Macintosh Adapter (Optional)

Digital Input

Signal Cable	Connector on PC	PC
Signal Cable (FD-C39 enclosed) 	Video Output Connector / DVI Input Connector (monitor) / DVI	Digital graphics card Power Mac G4 / G5 (DVI)

2.Plug the power cord into the power connector on the rear of the monitor.

3.Lead the power cord and signal cable into the cable holder at rear of the monitor.

NOTE

- * The cables are recommended to lead with slight sag for the smooth motion of the stand and the Portrait/Landscape display.

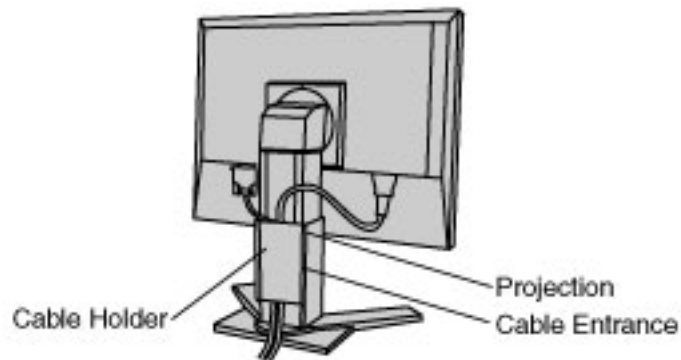

4. Plug the other end of the power cord into a power outlet.

The monitor's power indicator will flash yellow slowly.

WARNING

Use the enclosed power cord and connect to the standard power outlet of your country.

Be sure to remain within the rated voltage of the power cord.
Not doing so may result in fire or electric shock.

The equipment must be connected to a grounded main outlet.



Not doing so may result in fire or electric shock.

5. Turn on the monitor's power button and then switch on the PC's power.

The monitor's power indicator will light up (blue).

If an image does not appear, refer to the "[7. TROUBLESHOOTING](#)" for advice.

Whenever finished, turn off the PC and the monitor.

NOTE

- * When turning on the monitor, the kind of the input signal (Signal 1 or 2/Analog or Digital) is displayed for a few seconds on the right top corner of the screen.
- * Adjust brightness of the screen depending on the brightness of your environment.
- * Be sure to take adequate rests. A 10-minute rest period each hour is suggested.

2-3. Connecting the Signal Cable (For the Computer Employing ADC)

When connecting a Power Mac G4 / G5 through ADC (Apple Display Connector), change the input signal settings of monitor in advance to turn on the Power Mac.

NOTE

- * Be sure that the power switches of both the PC and the monitor are OFF.

1. Plug the signal cable into the connector at the rear of the monitor and the other end of the cable into the video connector on the PC.

After connecting, secure the connection with the screw-in fasteners.

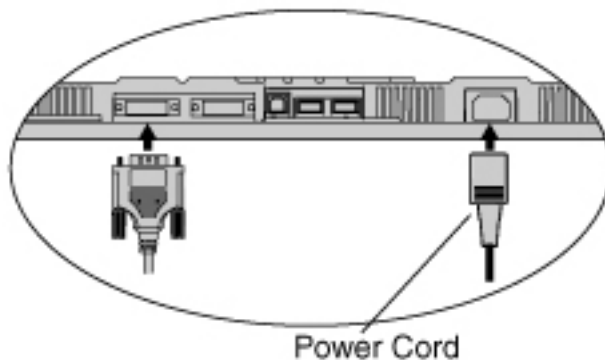

To input the Signal through ADC

Signal Cable	Connector on PC	PC
Signal Cable (FD-C39 enclosed) +ADC-DVI display adapter (commercially available)	Video Output Connector / ADC Input Connector (monitor) / DVI	Power Mac G4 / G5(ADC)

NOTE

* ADC-DVI display adapter is required if the monitor connects to Power Mac G4 / G5. The adapter is commercially available.

2.Plug the power cord into the power connector on the rear of the monitor.

3.Lead the power cord and signal cable into the cable holder at rear of the monitor.

NOTE

* The cables are recommended to lead with slight sag for the smooth motion of the stand and the Portrait/Landscape display.

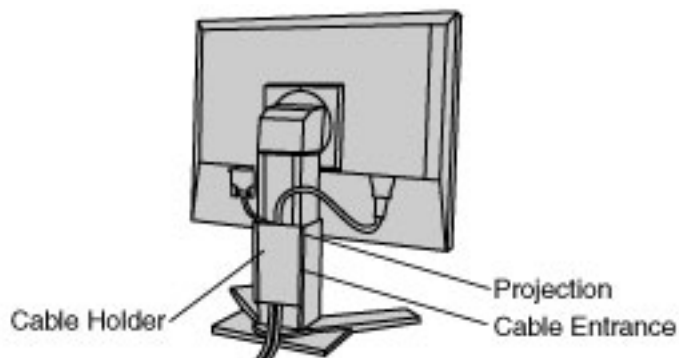

4. Plug the other end of the power cord into a power outlet.

The monitor's power indicator will flash yellow slowly.

WARNING

Use the enclosed power cord and connect to the standard power outlet of your country.

Be sure to remain within the rated voltage of the power cord. Not doing so may result in fire or electric shock.

The equipment must be connected to a grounded main outlet.



Not doing so may result in fire or electric shock.

5. Press the power button while pressing the Input Signal Selection button.

The Input Selection menu is appeared on the screen.

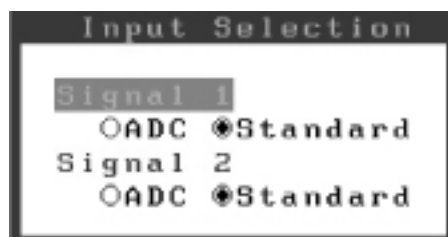
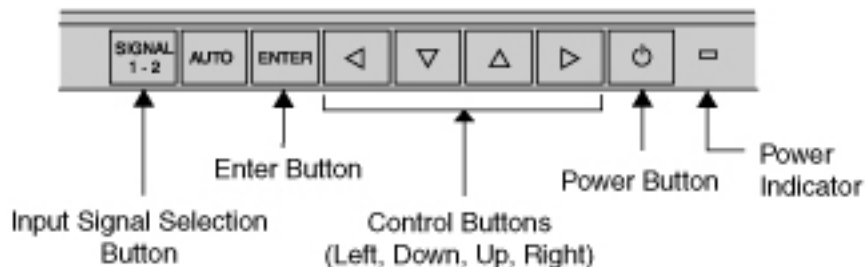

6. Change the input selection setting of the connector in the Input Selection menu to "ADC".

Press Enter button to complete the setting and the menu closes.

7. Switch on the PC's power.

The monitor's power indicator will light up (blue).

If an image does not appear, refer to the "[7. TROUBLESHOOTING](#)" for advice.

Whenever finished, turn off the PC and the monitor.







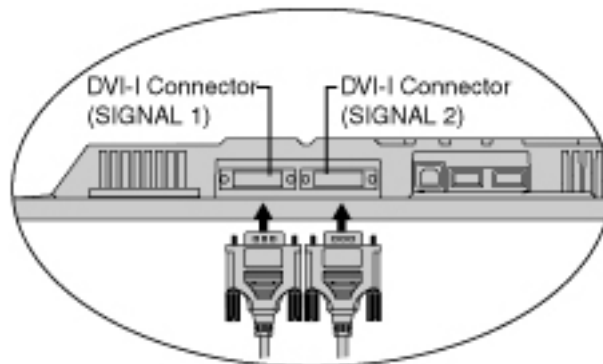

NOTE

- * When turning on the monitor, the kind of the input signal (Signal1 or 2/Analog or Digital) is displayed for a few seconds on the right top corner of the screen.
- * Adjust brightness of the screen depending on the brightness of your environment.
- * Be sure to take adequate rests. A 10-minute rest period each hour is suggested.
- * When changing the signal connector except ADC, open the Input Selection menu again and change the setting to "Standard".
- * To <Reset> the settings in the <Others> menu through ScreenManager, the settings of Input Selection will revert to the default setting.

2-4. Connecting two PCs to the Monitor

Two PCs can be connected to the monitor through DVI-I connectors (SIGNAL 1 / SIGNAL 2) on the back of the monitor.

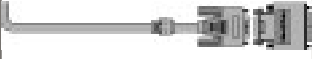

(EX.1)	Digital	ADC	Signal Cable (FD-C39 enclosed) +ADC-DVI display adapter (commercially available) 	Signal Cable DD200 [FD-C39](Optional) 	DVI-D	Digital
(EX.2)	Digital	ADC	Signal Cable (FD-C39 enclosed) +ADC-DVI display adapter (commercially available) 	Signal Cable (FD-C16 enclosed) 	D-Sub mini 15 pin	Analog
(EX.3)	Digital	ADC	Signal Cable (FD-C39 enclosed) +ADC-DVI display adapter (commercially available) 	Signal Cable (FD-C16 enclosed) + Adapter* 	D-Sub 15 pin	Analog
(EX.4)	Digital	DVI-D	Signal Cable (FD-C39 enclosed) 	Signal Cable FD-C16 enclosed) 	D-Sub mini 15 pin	Analog
(EX.5)	Digital	DVI-D	Signal Cable (FD-C39 enclosed) 	Signal Cable (FD-C16 enclosed)+ Adapter* 	D-Sub 15 pin	Analog

*Macintosh Adapter (Optional)

Selecting the Active Input

The Input Signal Selection button on the control panel can be used to select either SIGNAL 1 or SIGNAL 2 as the active input at any time. Every time the button is pressed, the input changes. When switching the signal, the kind of the input signal (Signal 1 or 2/ Analog or Digital) is displayed for a few seconds on the right top corner of the screen.



The Priority Input Signal

This function is used to select which PC will have priority to control the monitor when utilizing two PCs. The monitor constantly checks the input signals and switches automatically in accordance with the "Input Priority" setting (see table below). Once a priority is set, whenever a change of signal is detected at the selected input, the monitor will switch the input to that signal.

In this case of only one signal being present at either input, the monitor automatically detects and displays that signal.

Priority Settings	Performance
1 (SIGNAL1)	If signals from both inputs are present, the monitor gives preference of Signal 1 in the following cases. <ul style="list-style-type: none">• When the power of the monitor is turned ON.• When the signal input to Signal 1 is changed even if active input was Signal 2.
2 (SIGNAL2)	If signals from both inputs are present, the monitor gives preference to Signal 2 in the following cases. <ul style="list-style-type: none">• When the power of the monitor is turned ON.• When the signal input to Signal 2 is changed even if active input was Signal 1.

Manual	The monitor will not detect signals automatically in this mode. Select the active input by pressing the input signal selection button on the monitor's control panel.
--------	---

NOTE

- * When "1" or "2" is selected, the power saving mode of the monitor activates only if both PCs are in power saving mode.

2-5. How to remove the Tilt Stand

The LCD monitor can be used with an arm by removing the tilt stand and attaching the arm or stand to the LCD monitor.

Using our optional arm or stand is recommended. (Ask your local dealer for information.)

NOTE

- * If you will use the arm or stand of other manufacturers, confirm the followings to the manufacturers before selecting.
 - Hole spacing on the arm mounting: 100 mm x 100 mm (VESA compliant)
 - Supportable Weight: Total weight of the monitor (without stand) and attaching equipment such as a cable
 - TÜV/GS approved arm or stand
- * Please connect cables after attaching an arm stand.

1. Hold the center of the stand mounting cover and slide them rightward or leftward to remove the mounting cover.

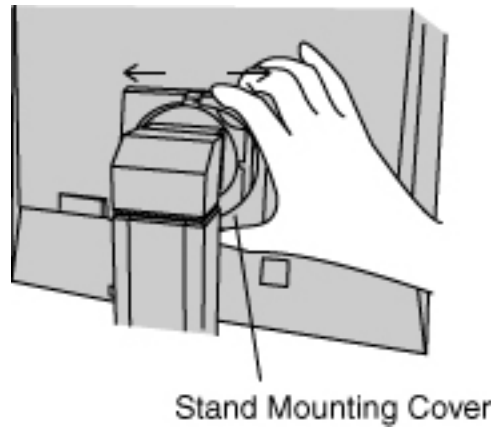

2. Lay the LCD monitor down. Do not scratch the panel.

3. Remove the tilt stand by loosening the screws. (4 pcs of M4 x 15 BZn/Fe)

4. Attach an arm stand to the LCD monitor securely.

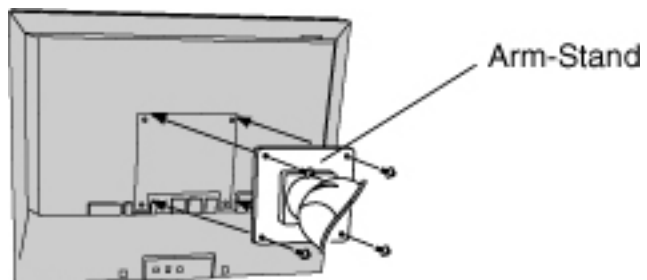

3. ScreenManager

3-1. How to use the ScreenManager

ScreenManager allows you to adjust screen performance through the main menu and select a FineContrast mode easily.

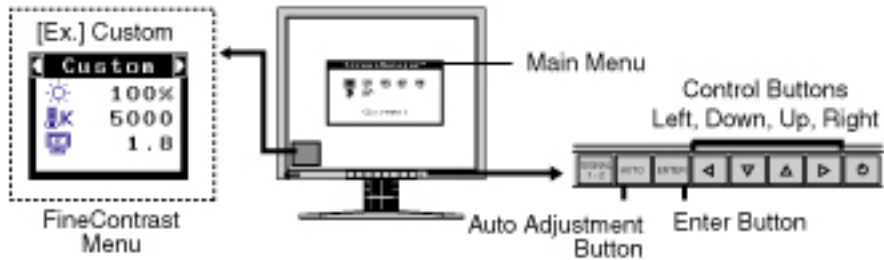

NOTE

* Main Menu and FineContrast menu cannot be activated at the same time.

1. Entering the ScreenManager

Press the Enter button once to display the main menu of the ScreenManager.

2. Making Adjustments and Settings

- (1) Select the desired sub menu icon using the Control buttons and press the Enter button. The sub menu appears.
- (2) Use the Control buttons to select the desired setting icon and press the Enter button. The setting menu appears.
- (3) Use the Control buttons to make all required adjustments and press the Enter button to save the settings.

3.Exiting the ScreenManager

- (1) To return to the main menu, select the <Return> icon or press the Down button twice, followed by the Enter button.
- (2) To exit the ScreenManager, select <Exit> icon or press the Down button twice, followed by the Enter button.

NOTE

* Double clicking the Enter button at any time also exits the ScreenManager menu.

FineContrast menu

Directly pressing the Left or Right button allows you to select the best suited mode for screen display from 3 FineContrast modes; sRGB, Custom and CAL. To exit the menu, press the Enter button.

3-2. ScreenManager Adjustments and Settings

The following table shows all the ScreenManager's adjustment and setting menus. "*" indicates adjustments of analog input only and "***" indicates digital input only.

Main menu	Sub menu	Reference
Screen	Clock	*
	Phase	*
	Position	*
	Resolution	*
	Range Adjustment	*
	Smoothing	
	Signal Filter	*
Color(Custom)*1	Brightness	
	Temperature	
	Gamma	
	Saturation	
	Hue	
	Gain	
	6 Colors	
		4-1. Screen Adjustment
		4-3. Color Adjustment

	Reset			
PowerManager	DVI DMPM		4-4. Power-save Setup	
	VESA DPMS			
	Off			
Others	Screen Size	**	4-2. Displaying a low resolutions	
	Border Intensity	*		
	Input Priority		Select the priority input signal.	
	Off Timer		Set the monitor's off timer to on or off.	
	Beep		Set the monitor's beeper to on or off.	
	Menu Settings	Menu Size		Change the size of the menu.
		Menu Position		Adjust the menu position.
		Menu Off Timer		Set the menu displaying time. *2
		Translucent		Set the transparency of the background.
	ActiveRotation II		5. ActiveRotation II	
	Power Indicator		Make non-light for blue lighting when the screen is displayed (see " Power Indicator setting ").	
Reset		Return to the factory default settings.		
Information	Information		Review the ScreenManager's settings, model name, serial number and usage time. *3	
Language	English, German, French, Spanish, Italian, Swedish and Japanese		Select the ScreenManager's language.	

*1 The adjustable functions on the <Color> menu depend on the selected FineContrast mode. The above table shows the sub menus when the "Custom" mode is selected (see "[4-3. Color Adjustment](#)").

*2 The displaying time of the FineContrast menu cannot be changed.

*3 Due to the inspection on the factory, the usage time may not "0 hour" at shipping.

This function allows you to select the best suited mode for screen display.

To select the Mode

Directly pressing the Left or Right button allows you to select the best suited mode for screen display from 3 FineContrast modes; sRGB, Custom and CAL. Color settings each mode can be adjusted by using the <Color> menu of the ScreenManager.

Exit

Press the Enter button to exit the menu.



FineContrast Mode

Selectable FineContrast modes are as follows.

sRGB	To display the screen images based on those original colors (ex. over the Internet).
Custom	To adjust the color settings according to your preference.
CAL	The mode only for calibration software

Color Adjustment of the Mode Settings

<Brightness>, <Temperature> and <Gamma> settings can be adjusted on the FineContrast menu. Select the desired function icon with the Up/Down Control buttons and adjust with the Left/Right Control buttons. (Setting(s) of <Temperature> and/or <Gamma> is defined as standard default in some modes.

Detailed Adjustments

The detailed color settings of each mode can be adjusted by using the <Color> menu of the ScreenManager.

NOTE

* "CAL" mode can be adjusted only by Calibration Software "ColorNavigator".

3-4. Useful Functions

Adjustment Lock

Use the "Adjustment Lock" function to prevent any accidental changes.

Locked function	<ul style="list-style-type: none">● Settings in the ScreenManager● Auto Adjustment Button
Unlocked function	<ul style="list-style-type: none">● Selecting of the FineContrast mode by the Right or Left buttons, / Adjustments● <Brightness> setting by the Up or Down buttons.● Input Signal Selection Button● Power Button

[To lock]

Switch off the monitor's power by the power button on the front control panel. Press on the Auto Adjustment button while switching on the monitor's power.

[To unlock]

Switch off the monitor's power by the power button on the front control panel, then hold Down the Auto Adjustment button once again and turn the power back on.

Off Timer

The off timer function causes the monitor to automatically enter a power off state after a predetermined amount of time has lapsed. This function was created to reduce afterimage characteristics that are particular to LCD monitors when the monitor screen is left on for a long period without use.

[Procedure]

- (1) Select <Off Timer> in the ScreenManager <Others> menu.
- (2) Select "Enable" and press the Right and Left buttons to adjust the "On Period" (1 to 23 hours).

[Off Timer System]

PC	Monitor	Power Indicator
On Period (1H - 23H)	Operation	Blue
Last 15 min. in "On period"	Advance Notice *1	Blue Flashing
"On period" expired	Power off	Flashing yellow slowly

*1 Advance notice (Power Indicator flashing blue) will be given 15 minutes before the monitor automatically enters the "Power Off" mode.

Pressing the power button during the advanced notice period can reset "On Period" for another 90 minutes. It is possible to reset "On Period" as many times as needed.

[Power Resumption Procedure]

Press the power button to return a normal screen.

NOTE

- * The off timer function works while the PowerManager is active, but there is no advance notice before the monitor's power is switched off.

Power Indicator setting

Light off the power indicator. This function is available for the multiple panels settings.

[Procedure]

- (1) Select <Power Indicator> in the ScreenManager <Others> menu.
- (2) Select "Disable".

EIZO Logo Appearing Function

When switching on the power button on the front control panel, the EIZO logo is displayed for a while. If you desire to display or undisplay this logo, use this function. (Default is logo appearing.)

[To undisplay]

Switch off the monitor's power by the power button, then hold Down the Enter button once again and turn the power back on.

[To display]

Switch off the monitor's power by the power button, then hold Down the Enter button once again and turn the power back on.

4. ADJUSTMENT

The monitor displays the digital input image correctly based on its pre-setting data.

4-1. Screen Adjustment

Analog Input

Screen adjustments for the LCD monitor should be used in suppressing screen flickering and also for adjusting the screen to its proper position. There is only one correct position for each display mode. It is also recommended to use the ScreenManager function when first installing the monitor or whenever changing the system. For convenience, an easy set-up program installed on the utility disk to assist in the set-up procedure is provided.

NOTE

- * Allow the LCD monitor to stabilize for at least 20 minutes before making image adjustments.

Adjustment Procedure

1. Push the Auto Adjustment Button on the control panel.

The message "Your setting will be lost if you press again now." appears and remains on the screen for 5 seconds. While the message is on the screen, press the Auto Adjustment button again to automatically adjust the clock, phase, screen position and resolution. If you do not wish to do adjust the screen, do not press the Auto Adjustment button again.

NOTE

- * The Auto sizing function is intended for use on the Macintosh and on AT-compatible PC running Windows. It may not work properly in either of the following cases.

When running an AT-compatible PC on MS-DOS (Not windows). The background color for the "wall paper" or "desktop" pattern is set to black. It cannot work correctly using with some graphics cards.

If the appropriate screen cannot be made by using the Auto Adjustment button, adjust the screen through the following procedures. If the appropriate screen can be made, proceed to [step 4](#).

2.Run the "Screen Adjustment Program".

Having read the "Readme.txt" file, run the "Screen Adjustment Program" in the enclosed EIZO LCD Utility Disk. Step by step, adjustment is provided by the wizard guide. (If using the Windows, the program can be directly run from the menu screen of the CD-ROM.)

NOTE

- * If the user's operating system has no utility disk (e.g. OS/2), we recommend setting the desktop pattern to that as shown in the diagram on the following.

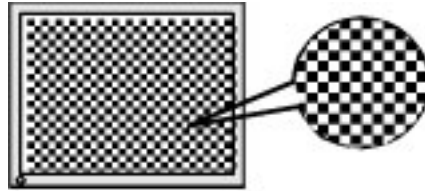

3.Adjust by using <Screen> menu in the ScreenManager.

(1) Vertical bars appear on the screen

=>  Use the <Clock> adjustment.

Select the <Clock> and eliminate the vertical bars by using the Right and Left of the Control buttons.

Do not continuously press the Control buttons, as the adjustment value will change quickly and make it difficult to locate the most suitable adjustment point. If the horizontal flickering, blur or bars appear, proceed to <Phase> adjustment as follows.



(2) Horizontal bars appear on the screen.

=>  Use the **<Phase>** adjustment.

Select the <Phase> and eliminate the horizontal flickering, blurring or bars by using the Right and Left buttons.



NOTE

* Horizontal bars may not completely disappear from the screen depending on the PC.

(3) The screen position is incorrect.

=>  Use the **<Position>** adjustment.

The correct displayed position of the monitor is decided because the number and the position of the pixels are fixed. The <Position> adjustment moves the image to the correct position.

Select <Position> and adjust the position by using the Up, Down, Right and Left buttons.

If vertical bars of distortion appear after finishing the <Position> adjustment, return to <Clock> adjustment and repeat the previously explained adjustment procedure. ("Clock" => "Phase" => "Position").

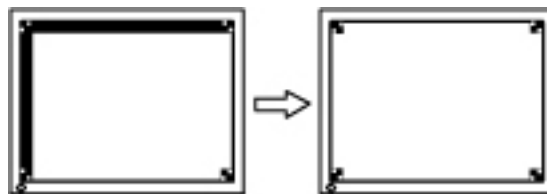

(4) Screen image is smaller or larger than the actual screen images.

=>  Use the **<Resolution>** adjustment.

Adjustment is needed when the input signal resolution and the resolution now being displayed are different.

Select **<Resolution>** and confirm if the resolution now being displayed is the same as the input resolution. If it is not, adjust the vertical resolution using the Up and Down button and adjust the horizontal resolution using the Right and Left buttons.

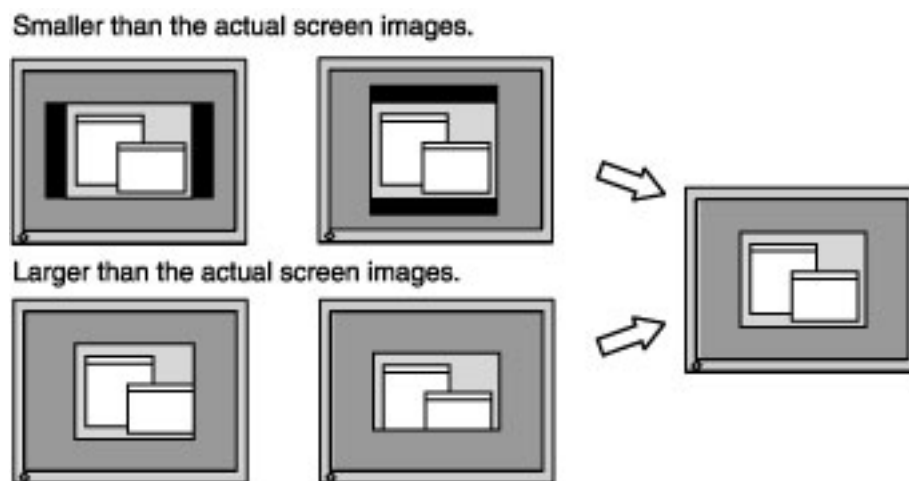

4.Adjust the output signal range (Dynamic Range) of the signal.

=>  Use the **<Range Adjustment>** of **<Screen>** menu.

This controls the level of output signal range to display the whole color gradation (256 colors).

[Procedure]

Select the **<Range Adjustment>** in the ScreenManager. While the message is on the screen, press the Auto Adjustment button on the control panel to adjust the Range Adjustment.

The screen blanks for a moment and adjusts the color range to display the whole color gradation of the current output signal.

The lower resolutions are enlarged to full screen automatically. Using the <Screen Size> function in the <Others> menu enables to change the screen size.

1. Enlarge the screen size when displaying a low resolution.

=>  Select the <Screen Size>.

Select the <Screen Size> in the others menu and select the screen size by using the Up and Down buttons.

Menu	Function
Full	Displays the picture on the screen in full, irrespective of the picture's resolution. Since the vertical resolution and the horizontal resolution are enlarged at different rates, some image may appear distorted.
Enlarged	Displays the picture on the screen in full, irrespective of the picture's resolution. Since the vertical resolution and horizontal resolution are enlarged at the same rates, some horizontal or vertical image may disappear.
Normal	Displays the picture at the actual screen resolution.

Example: Displaying 1280 x 1024

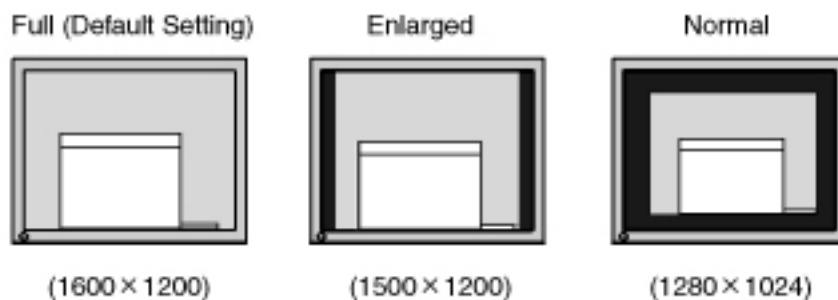

2. Smooth the blurred texts of the enlarged screen.

=>  Switch the <Smoothing> setting.

Select the suitable level 1-5 (Soft-Sharp).

Select <Smoothing> in the <Screen> menu and adjust by using the Right and Left buttons.

NOTE

* <Smoothing> is disabled when the screen is displayed in the following resolutions.

- 1600 x 1200
- The image size is doubled both in horizontally and vertically to (i.e. 1600 x 1200 enlarged from 800 x 600) provide clear focus which does not require this function.

3. Set the brightness of the black area surrounding the displayed image.

=>  Set the <Border Intensity>.

In the "Enlarged" mode or "Normal" mode, the outer area (border) is usually black. Select <Border Intensity> in the <Others> menu and adjust by using the Right and Left buttons.

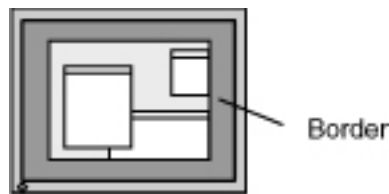

4-3. Color Adjustment

Color settings of each FineContrast mode can be adjusted and saved by using the <Color> menu of the ScreenManager.









In the analog input, perform the [<Range Adjustment>](#) before making the color adjustments.

During color adjustments, the FineContrast mode cannot be changed. Select the mode in advance by using the FineContrast mode.

Adjustment Items

The adjustable items and displayed icons on the <Color> menu depend on the selected FineContrast mode.

"*": Settable/Adjustable "-": Fixed at the factory



Icons	Functions	FineContrast Modes		
		sRGB	Custom	CAL
	Brightness**	*	*	-
	Temperature**	-	*	-
	Gamma**	-	*	-
	Saturation	-	*	-
	Hue	-	*	-
	Gain	-	*	-
	6 colors	-	*	-
	Reset	-	*	-







**These settings can be also adjusted on the FineContrast menu.

NOTE

- * Allow the LCD monitor to stabilize for at least 20 minutes before making image adjustments. (Allow the monitor to warm Up for at least 20 minutes before making adjustments.)
- * Performing the <Reset> of the <Color> menu returns the color settings of the selected mode to the default settings.
- * The values shown in percentages represent the current level within the specific adjustment. They are available only as a reference tool. (To create a uniform white or black screen, the percentages for each will probably not be the same.)

Adjustment Contents

Menu	Function Descriptions	Adjustable Range
Brightness 	To set the brightness of the screen	0 ~ 100%
Temperature 	To set the color temperature	4,000 ~ 10,000 K in 500 K increments (including 9,300 K). Default setting is 5000K

	<p>NOTE</p> <ul style="list-style-type: none"> * The values shown in the Kelvin are available only as a reference tool. * Adjusting the <Gain> turns the <Temperature> adjustment "OFF". * Setting the temperature under 4,000 K or over 10,000 K invalidates the color temperature setting. (The color temperature's setting turns "OFF".) 	
Gamma	To set the gamma value	1.8 ~ 2.6 (in 0.2 increments)
	<p>NOTE</p> <ul style="list-style-type: none"> * If setting the gamma value, the using the monitor in the digital signal input is recommended. If using the monitor in the analog input signal, set the gamma value from 1.8 to 2.2. 	
Saturation	To change the saturation	-100 ~ 100 Setting the minimum level (-100) turns the image to the monochrome.
	<p>NOTE</p> <ul style="list-style-type: none"> * The <Saturation> adjustment may cause undisplayable color tone. 	
Hue	To change the flesh color, etc.	-100 ~ 100
	<p>NOTE</p> <ul style="list-style-type: none"> * The <Hue> adjustment may cause undisplayable color tone. 	
Gain	To change each color (red, green and blue)	0 ~ 100% By adjusting the red, green and blue color tones for each mode, custom colors can be defined. Display a white or gray background image and adjust the <Gain>.
	<p>NOTE</p> <ul style="list-style-type: none"> * The values shown in the percentage are available only as a reference tool. * Setting the <Temperature> invalidates the <Gain> adjustment. <Gain> setting returns to the default setting. 	
6 colors	To adjust <Saturation> and <Hue> in each color (Red, Yellow, Green, Cyan, Blue and Magenta)	Hue: -100 ~ 100 Saturation: -100 ~ 100
		
Reset	To return the color settings of the selected mode to the default settings	Select the <Reset>.
		

4-4. Power-save Setup

The <PowerManager> menu in the ScreenManager enables to set the power-save setup.

NOTE

- * Do your part to conserve energy, turn off the monitor when you are finished using it. Disconnecting the monitor from the power supply is recommended to save energy completely.
- * Even if the monitor is in a power saving mode, USB compliant devices function when they are connected to the monitor's USB (both the Upstream and the Downstream ports). Therefore, power consumption of the monitor will change according to the connected devices even if the monitor is in a power saving mode.

Analog Input

This monitor complies with the "[VESA DPMS](#)" standard.

To use the PC's Power Saving System (VESA DPMS).

[Procedure]

- (1) Set the PC's power saving settings.
- (2) Select "VESA DPMS" in the <PowerManager> menu.

[Power saving system]

PC		Monitor	Power Indicator
Operation		Operation	Blue
Power saving	STAND-BY SUSPEND OFF	Power saving	Yellow

[Power Resumption Procedure]

Operate the mouse or keyboard to return to a normal screen.

Digital Input

This monitor complies with the "[DVI DMPM](#)".

[Procedure]

- (1) Set the PC's power saving settings.
- (2) Select "DVI DMPM" from the <PowerManager> menu.

[Power saving system]

PC	Monitor	Power Indicator
Operation	Operation	Blue
Power saving/Off mode	Power saving	Yellow

[Power Resumption Procedure]

Operate the mouse or keyboard to return to a normal screen .
Power on the PC to return a normal screen from the Off mode of the PC.

5. ActiveRotation II

ActiveRotationII function allows you to change the display orientation of the monitor with the panel rotation.

Refer to Web site of EIZO NANO CORPORATION for the latest information about supported graphics card (<http://www.eizo.com/>).

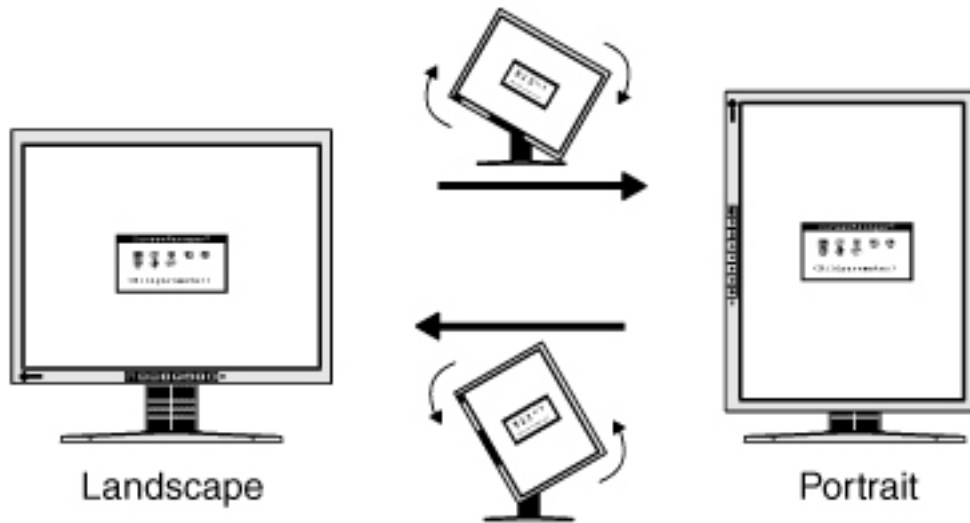

NOTE

- * After changing the display orientation, it may take some time until the screen image is available.
- * The ActiveRotationII function may not work correctly using with some graphics card or OS.
- * If you calibrate the monitor with the provided software, please set a panel in landscape before calibration. The portrait monitor cannot be calibrated with accuracy.
- * When using the ActiveRotationII function with dual display, the screen image of either monitor can disappear. If so, redisplay the image by "Display Properties" (for Windows only).

Operating Procedures

1. Turn the panel 90 degrees.

Since the default setting of <ActiveRotationII> is set to "Enable", the screen image responding to the panel orientation will be available.

NOTE

- * To disable the ActiveRotationII function, select "Disable" on <ActiveRotationII> menu in <Others> menu.

2. When the screen image is expanded or contracted, restart the PC.

The ActiveRotationII function may not work correctly using with some graphics card or OS. When the screen image remains to be expanded or contracted after restarting the PC, please try to change the screen resolution setting of your PC system.

NOTE

- * The "ActiveRotationII Utility" (for Windows) allows you to change the display orientation easily. Please refer to the readme.txt in the EIZO LCD Utility Disk for the details.

6. MAKING USE OF USB (Universal Serial Bus)

This monitor provides a hub which supports the USB standard. When connecting to a USB compliant PC or another hub, the monitor functions as a hub which the USB compliant peripherals can be easily connected.

Required System Environment

- * PC equipped with USB ports or another USB hub connected to the USB compliant PC
- * Windows 98/2000/XP//Mac OS 8.5.1 or later
- * EIZO USB Cable (MD-C93, enclosed)

NOTE

- * The USB hub function may not work properly depending on the PC, OS or peripherals. Please consult the manufacturer of each device about the USB support.
- * Using the USB Rev . 2.0 compatible PC or peripherals is recommended.
- * When the main power of the monitor is not on, the peripherals connected to the downstream ports will not operate.
- * Even if the monitor is in a power saving mode, the devices connected to the monitor's USB ports (both the upstream and the downstream) will function.
- * The followings are procedures for the Windows 98/Me/2000/XP and Mac OS.

Connecting to the HUB USB

- 1.Connect the monitor to the PC with the signal cable first, then turn on the PC.**

2. Connect the upstream port of the monitor to the downstream port of the USB compliant PC or another hub by using the USB cable.

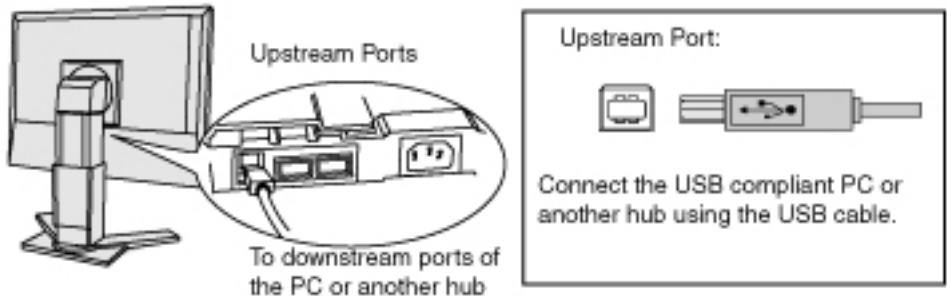

After connecting the USB cable, the USB function can be set up automatically.

3. After setting up, the monitor's USB hub is available for connecting USB compliant peripherals to the downstream ports of the monitor.

Connecting Examples

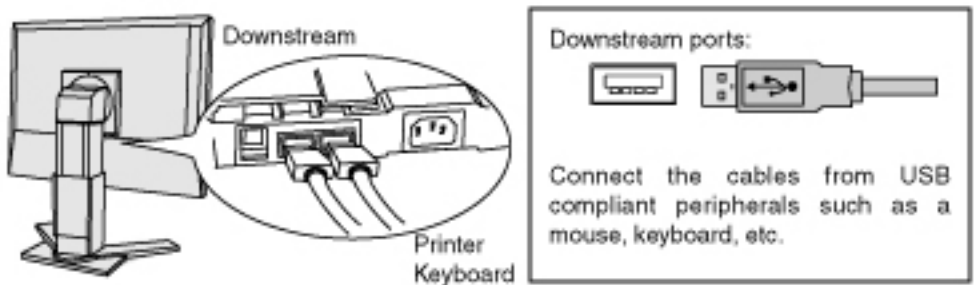
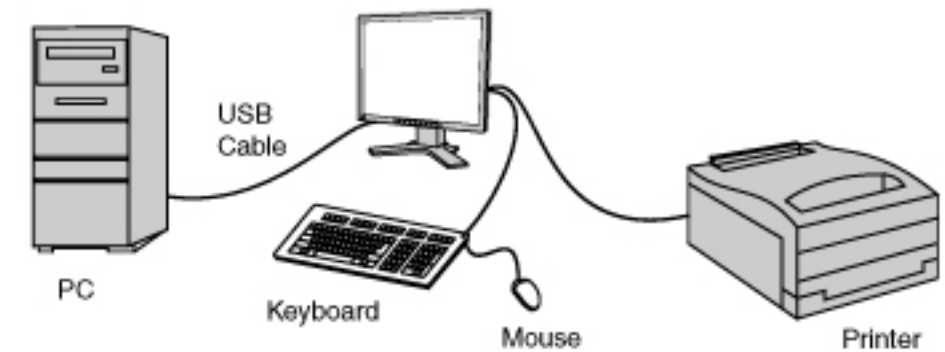

7. TROUBLESHOOTING

If a problem persists even after applying the suggested remedies, contact an EIZO dealer.

- No picture problems : See No.1 ~ No.2
- Imaging problems : See No.3 ~ No.14
- Other problems : See No.15 ~ No.18
- USB problems : See No.19 ~ No.20

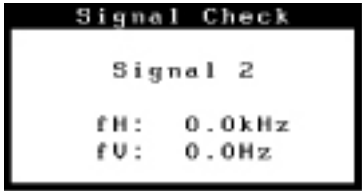
Problems	Points to check with possible solutions
1. No picture Indicator status: Off	<input type="checkbox"/> Check that the power cord is correctly connected. If the problem persists, turn off the monitor power for a few minutes, then turn it back on and try again.
Indicator status: Blue	<input type="checkbox"/> Check the Gain setting.
Indicator status: Yellow	<input type="checkbox"/> Switch the signal Input by pressing the input signal selection button on the front control panel. <input type="checkbox"/> Try pressing a key on the keyboard, or clicking the mouse. <input type="checkbox"/> Try turning the PC on.
Indicator status: Slowly flashing Yellow	<input type="checkbox"/> Try pressing the power button
2. Following messages appear. (Error messages shown below will remain on the screen for 40 seconds.) 	<p>These messages appear when the signal is not inputted correctly, even if the monitor functions properly.</p> <input type="checkbox"/> When the image is displayed correctly after a short time, there is no problem with the monitor. (Some PCs do not output the signal soon after powering on.) <input type="checkbox"/> Check that the PC is turned ON. <input type="checkbox"/> Check that the signal cable is properly connected the PC or graphics board. <input type="checkbox"/> Switch the signal input by pressing the Input Signal Selection button on the front control panel.

Whenever an error signal message appears, the signal frequency will be displayed in red. (Example)

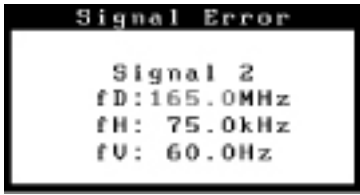

[] Use the graphics board's utility software to change the frequency setting. (Refer to the manual of the graphics board.)

3. Display position is incorrect.



[] Adjust the image position using the [<Position>](#).
[] If the problem persists, use the graphics board's utility software to change the display position if available.

4. Screen image is smaller or larger than the actual screen images.

[] Adjust the resolution using the [<Resolution>](#).

5. Vertical bars of distortion appear.



[] Decrease the vertical bars using the [<Clock>](#).

6. The characters and images have several vertical bars on their right side.

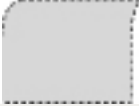

[] Adjust the characters and images using the [<Signal Filter>](#).

<p>7. Horizontal bars of distortion appear.</p> 	<p>[] Decrease the horizontal bars using the Phase.</p>
<p>8. Letters and lines appear blurred.</p>	<p>[] Adjust the blurred lines using Smoothing.</p>
<p>9. Distortion appears like the figure below.</p> 	<p>[] This happens when both composite (X-OR) input signal and separate vertical synchronizing signal are input. Please select one of the two.</p>
<p>10. The screen is too bright or too dark.</p>	<p>[] Adjust the Brightness (The backlight of the LCD monitor has a fixed life span. When the screen becomes dark or begins to flicker, please consult your dealer.)</p>
<p>11. Afterimages appear.</p>	<p>[] When the screen image is changed after displaying the same image for a long period, an afterimage may appear. The "Afterimage" can be removed gradually by changing the displayed image. Use the Off Timer function and avoid keeping the screen on all the time.</p>
<p>12. The screen has defective pixels (e.g. slightly light or dark).</p>	<p>[] This is due to the characteristics of the panel itself, and not the LCD product.</p>
<p>13. Fingerprints remain on the screen.</p>	<p>[] Leaving the screen white may solve the problem.</p>
<p>14. The noise appears on the screen.</p>	<p>[] Change the mode in Signal Filter in the Screen menu.</p>

<p>15.The <Smoothing> cannot be selected.</p>	<p>[] <Smoothing> is disabled when the screen is displayed in the 1600 x 1200.</p> <p>[] <Smoothing> is disabled when "Normal" is selected in the <Screen Size> menu.</p> <p>[] The image size is doubled both in horizontally and vertically to (i.e. 1600 x 1200 enlarged from 800 x 600) provide clear focus which does not require this function.</p>
<p>16.The Main menu of ScreenManager does not operate.</p>	<p>[] The adjustment lock is probably on. To unlock: switch the LCD monitor off. Then, while pressing the Autadjustment button switch, the power on.</p>
<p>17.The FineContrast mode does not operate.</p>	<p>[] Check that the Main menu of ScreenManager is not activated.</p>
<p>18.The Auto adjustment button does not operate.</p>	<p>[] The Auto adjustment button does not operate when the digital signal is input.</p> <p>[] The adjustment lock is probably on. To unlock: switch the LCD monitor off. Then, while pressing the Auto adjustment button, switch the power on.</p>
<p>19.USB function cannot be setup.</p>	<p>[] Check that the USB cable is correctly connected.</p> <p>[] Check that the PC and OS are USB compliant. (For verification of USB support, consult the manufacturer of each system.)</p> <p>[] Check the PC's BIOS setting for USB. (For details, refer to the manual of the PC.)</p>
<p>20.PC is hung up. / The peripherals connected to the downstream ports do not operate.</p>	<p>[] Check that the USB cable is correctly connected.</p> <p>[] Check the downstream ports by connecting the peripherals to other downstream ports. If the problem is solved by doing this, contact an EIZO dealer. (For details, refer to the manual of the PC.)</p> <p>[] Try executing the following method.</p> <ul style="list-style-type: none"> ● Restarting the PC - Restarting the PC ● Connecting the PC and peripherals directly <p>If the problem is solved by doing this, contact an EIZO dealer.</p>

8. CLEANING

Periodic cleaning is recommended to keep the monitor looking new and to prolong its operation lifetime.

NOTE

- * Never use thinner, benzene, alcohol (ethanol, methanol, or isopropyl alcohol), abrasive cleaners, or other strong solvents, as these may cause damage to the cabinet or LCD panel.

Cabinet

To remove stains, wipe the cabinet with a soft, lightly moistened cloth using a mild detergent. Do not spray wax or cleaner directly into the cabinet. (For details, refer to the manual of the PC.)

LCD Panel

- Clean the LCD panel with a soft cloth such as cotton cloth or lens cleaning paper.
- Remove persistent stains gently with a cloth dampened with little water, and then clean the LCD panel again with a dry cloth for better finishing.

9. SPECIFICATION

LCD Panel	54 cm (21.3 inch), TFT color LCD panel with Anti-Glare Hard Coating Viewing Angle: H: 170°, V: 170° (at contrast ratio 1:5) Response Time: approx.30 ms
Dot Pitch	0.270 mm
Horizontal Scan Frequency	Analog: 24 - 100 kHz (Automatic) Digital: 31 - 100 kHz
Vertical Scan Frequency	Analog: 49 - 86 Hz (Automatic) (1600 x 1200: 49 - 76 Hz) Digital: 59 Hz - 61Hz, (VGA Text : 69 - 71 Hz)
Resolution	1600 dots x 1200 lines
Dot Clock (Max.)	Analog: 202.5 MHz, Digital: 162 MHz
Display Colors	16 million colors (max.)
Display Area	432 mm (H) x 324 mm (V) (17.0" (H) x 12.8" (V)) (Viewable image size: 540 mm (21.2"))
Power Supply	100-120VAC±10% 50/60 Hz, 0.75A 200-240 VAC±10%, 50 Hz, 0.4 A
Power Consumption	Min.: 65 W Max: 75 W (With USB) Power Saving Mode : Less than 2 W (for single signal input without USB)
Input Connector	DVI-I × 2
Analog Input Signal (Sync)	a) Separate, TTL, Positive/Negative b) Composite, TTL, Positive/Negative
Analog Input Signal (Video)	0.7Vp-p/75 ohms, Positive
Input Signal (Digital)	TMDS (Single Link)
Signal registration	Analog : 45 Digital : 10
Plug & Play	VESA DDC 2B / EDID structure 1.3
Dimensions	472 mm (W) x 459 - 541 mm (H) x 208.5 mm (D) (18.6"(W) x 18.1"- 21.3"(H) x 8.2"(D))
Dimensions (without stand)	472 mm (W) x 373 mm (H) x 69 mm (D) (15.7"(W) x 14.7"(H) x 2.7"(D))
Weight	10.2 kg (22.5 lbs.)
Weight (without stand)	7.0 kg (15.4 lbs.)
Temperature	Operating: 0 °C - 35 °C (32 °F - 95 ° F) Storage: -20 °C - 60 °C (-4 °F - 140 ° F) Humidity 30% to 80% R.H. Non-condensing

USB standard	USB Specification Revision 2.0
USB ports	Upstream port x 1, Downstream port x 2

Default settings

	Analog input	Digital input
Brightness	100%	100%
Smoothing	3	
Temperature	5,000K	
FineContrast Mode	Custom	
PowerManager	VESA DPMS	DVI DMPM
Screen Size	Full Screen	
Input Priority	Signal 1	
Off Timer	Disable	
Menu Settings	Menu Size	Normal
	Menu Off Timer	45 seconds
ActievRotationII	Enable	
Beep	On	
Language	English	
Input Selection	Standard	

Beeper settings

Short beep	ScreenManager item selected. ScreenManager parameter adjusted to minimum or maximum limit. Input Signal Selection button pressed.
Long beep	Auto Adjustment button pressed. ScreenManager data-save executed.
4 short beeps	Monitor not connected correctly. PC turned off. Monitor received unsupported signal frequency.
2 short beeps every 15 sec.	Monitor is in the advance notice mode of the Off Timer. The power will be off within fifteen minutes.

Dimensions

Unit mm (inches)

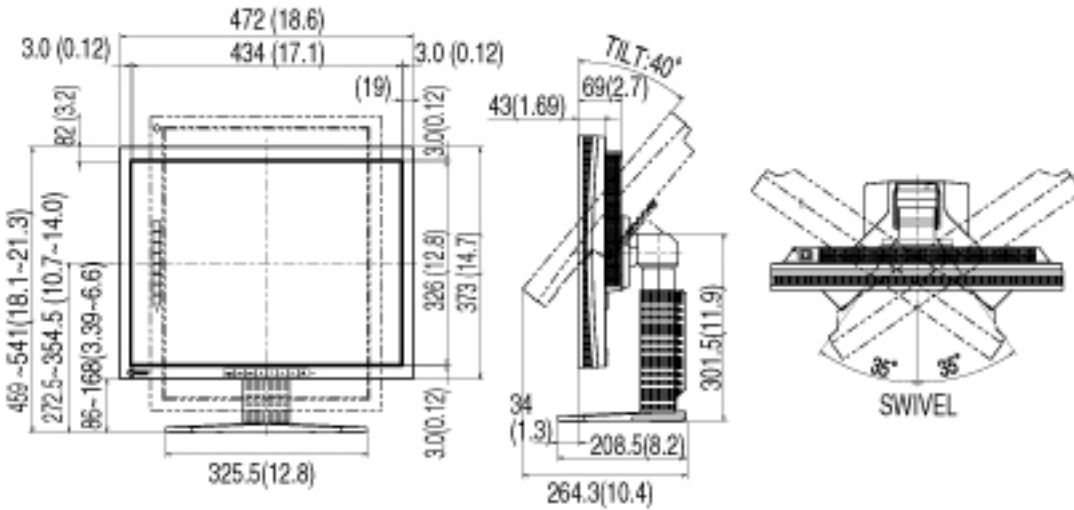

Pin Assignment

DVI-I Connector



Pin No.	Signal	Pin No.	Signal	Pin No.	Signal
1	TMDS Data 2-	11	TMDS Data 1/3 Shield	21	NC
2	TMDS Data 2+	12	NC	22	TMDS Clock Shield
3	TMDS Data 2/4 Shield	13	NC	23	TMDS Clock+
4	NC*	14	+5V Power	24	TMDS Clock-
5	NC	15	Ground (return for +5V, Hsync and Vsync)	C1	Analog Red
6	DDC Clock (SCL)	16	Hot Plug Detect	C2	Analog Green
7	DDC Data (SDA)	17	TMDS Data0-	C3	Analog Blue
8	Analog Vertical Sync	18	TMDS Data0+	C4	Analog Horizontal Sync

9	TMDS Data1-	19	TMDS Data0/5 Shield	C5	Analog Ground (analog R, G, & B return)
10	TMDS Data1+	20	NC		

(*NC: No Connection)

USB Ports

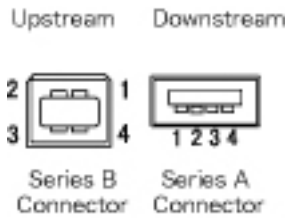

No.	Signal	Remarks
1	VCC	Cable power
2	-Data	Serial data
3	+Data	Serial data
4	Ground	Cable Ground

Afterimage

The Afterimage is particular to LCD monitors when the monitor screen is left on for a long period without use. The "Afterimage" can be removed gradually by changing the displayed image.

Clock

With the analog input signal display, the analog signal is converted to a digital signal by the LCD circuitry. To convert the signal correctly, the LCD monitor needs to produce the same number clock pulse as the dot clock of the graphics system. When the clock pulse is not correctly set, some vertical bars of distortion are displayed on the screen.

Color Temperature (Temperature)

Color Temperature is a method to measure the white color tone, generally indicated in degrees Kelvin. At high temperatures the white tone appears somewhat blue, while at lower temperatures it appears somewhat red. Computer monitors generally give best performance at high temperature settings.

5,000 K: Slightly reddish white.

6,500 K: Warm-white tone, similar to white paper or daylight.

9,300 K: Slightly bluish white.

DVI (Digital Visual Interface)

A digital flat panel interface. DVI can transmit digital data from the PC directly without loss with the signal transition method "TMDS".

There are two kinds of DVI connectors. One is DVI-D connector for digital signal input only. The other is DVI-I connector for both digital and analog signal inputs.

DVI DMPM (DVI Digital Monitor Power Management)

The Power management system for the digital interface. The "Monitor ON" status (operation mode) and the "Active Off" status (power-saving mode) are indispensable for the DVI-DMPM as the monitor's power mode.

Gain Adjustment

Adjusts each color parameter for red, green and blue. The color of the LCD monitor is displayed through the color filter of the LCD panel. Red, green and blue are the three primary colors. The colors on the monitor are displayed by combining these three colors. The color tone can change by adjusting the illumination amount passed through each color's filter.

Gamma

Generally, the relationship that the light intensity values of a monitor change nonlinearly to the input signal level is called "Gamma Characteristic". On the monitor, low gamma values display the whitish images and high gamma values display the high contrast images.

Phase

The phase adjustment decides the sampling timing point for converting the analog input signal to a digital signal. Adjusting the phase after the clock adjustment will produce a clear screen.

Range Adjustment

The Range Adjustment controls the level of output signal range to display the whole color gradation.

Resolution

The LCD panel consists of a fixed number of pixel elements which are illuminated to form the screen image. The EIZO CG210 display panel consists of 1600 horizontal pixels and 1200 vertical pixels. At a resolution of 1600 x 1200, all pixels are displayed as a full screen.

sRGB (Standard RGB)

"International Standard for Red, Green, and Blue color space" A color space was defined with the aim of the color matching between applications and hardware devices, such as monitors, scanners, printers and digital cameras. As a standard default space, sRGB allows Internet users to closely match colors.

TMDS (Transition Minimized Differential Signaling)

A signal transition method for the digital interface.

VESA DPMS (Video Electronics Standards Association - Display Power Management Signaling)

The acronym VESA stands for "Video Electronics Standards Association", and DPMS stands for "Display Power Management Signaling". DPMS is a communication standard that PCs and graphics boards use to implement power savings on the monitor side.

Analog input
Analog Eingang
Analog numerique

Preset Timing Chart
Einstellung des Zeitdiagramms
Diagramme des temps prédéfinis

Based on the signal diagram shown below factory presets have been registered in the monitor's microprocessor.

Der integrierte Mikroprozessor des Monitors unterstützt werkseitige Standardeinstellungen (siehe hierzu die nachfolgenden Diagramme).

Signaux ont été enregistrés en usine dans le microprocesseur du moniteur, conformément au diagramme de synchronisation ci-dessous.

Mode		Dot Clock	Sync Polarity		Frequencies	
Landscape	Portrait	MHz	H	V	fH: kHz	fV: Hz
VGA 640×480	VGA 640×480	25.2 MHz	Nega	Nega	31.5	60.0
VGA TEXT 720×400	VGA TEXT 720×400	28.3 MHz	Nega	Posi	31.5	70.1
Macintosh 640×480	Macintosh 640×480	30.2 MHz	Nega	Nega	35.0	66.7
Macintosh 832×624	Macintosh 832×624	57.3 MHz	Nega	Nega	49.7	74.6
Macintosh 1152×870	Macintosh 1152×870	100.0 MHz	Nega	Nega	68.7	75.1
Macintosh 1280×960	Macintosh 1280×960	126.2 MHz	Posi	Posi	74.8	74.8
VESA 640×480	VESA 640×480	31.5 MHz	Nega	Nega	37.9	72.8
VESA 640×480	VESA 640×480	31.5 MHz	Nega	Nega	37.5	75.0
VESA 640×480	VESA 640×480	36.0 MHz	Nega	Nega	43.3	85.0
VESA 800×600	VESA 800×600	36.0 MHz	Posi	Posi	35.2	56.3

VESA 800×600	VESA 800×600	40.0 MHz	Posi	Posi	37.9	60.3
VESA 800×600	VESA 800×600	50.0 MHz	Posi	Posi	48.1	72.2
VESA 800×600	VESA 800×600	49.5 MHz	Posi	Posi	46.9	75.0
VESA 800×600	VESA 800×600	56.3 MHz	Posi	Posi	53.7	85.1
VESA 1024×768	VESA 1024×768	65.0 MHz	Nega	Nega	48.4	60.0
VESA 1024×768	VESA 1024×768	75.0 MHz	Nega	Nega	56.5	70.1
VESA 1024×768	VESA 1024×768	78.8 MHz	Posi	Posi	60.0	75.0
VESA 1024×768	VESA 1024×768	94.5 MHz	Posi	Posi	68.7	85.0
VESA 1152×864	VESA 1152×864	108.0 MHz	Posi	Posi	67.5	75.0
VESA 1280×960	VESA 1280×960*	108.0 MHz	Posi	Posi	60.0	60.0
VESA 1280×1024	VESA 1280×1024*	108.0 MHz	Posi	Posi	64.0	60.0
VESA 1280×1024	VESA 1280×1024*	135.0 MHz	Posi	Posi	80.0	75.0
VESA 1280×1024	VESA 1280×1024*	157.5 MHz	Posi	Posi	91.2	85.0
VESA 1600×1200	VESA 1600×1200*	162.0 MHz	Posi	Posi	75.0	60.0
VESA 1600×1200	-	175.0 MHz	Posi	Posi	81.3	65.0
VESA 1600×1200	-	189.0 MHz	Posi	Posi	87.5	70.0
VESA 1600×1200	-	202.5 MHz	Posi	Posi	93.8	75.0
Portrait Display 1200×1600*	Portrait Display 1200×1600	162.3 MHz	Nega	Posi	99.4	60.0

*contracted

Digital Input
Digitaler Eingang
Entrée numérique

The monitor supports the following resolutions only.

Der Monitor reklamiert nur die nachfolgend aufgeführten Auflösungen.

Le moniteur ne peut utiliser que les résolutions suivantes.

Mode		Dot Clock	Sync Polarity		Frequencies	
Landscape	Portrait	MHz	H	V	fH: kHz	fV: Hz
VGA 640×480	VGA 640×480	25.2 MHz	Nega	Nega	31.5	60.0
VGA TEXT 720×400	VGA TEXT 720×400	28.3 MHz	Nega	Posi	31.5	70.1
VESA 800×600	VESA 800×600	40.0 MHz	Posi	Posi	37.9	60.3
VESA 1600×1200	VESA 1600×1200*	162.0 MHz	Posi	Posi	75.0	60.0
Portrait Display 1200×1600*	Portrait Display 1200×1600	162.3 MHz	Nega	Posi	99.4	60.0

*contracted

[Applicable to gray cabinet.]



Congratulations!

The display you have just purchased carries the TCO'03 Displays label. This means that your display is designed, manufactured and tested according to some of the strictest quality and environmental requirements in the world. This makes for a high performance product, designed with the user in focus that also minimizes the Impact on our natural environment.

Some of the features of the TCO'03 Display requirements:

Ergonomics

Good visual ergonomics and image quality in order to improve the working environment for the user and to reduce sight and strain problems. Important parameters are luminance, contrast, resolution, reflectance, colour rendition and image stability.

Energy

- Energy-saving mode after a certain time - beneficial both for the user and environment
- Electrical safety

Emissions

- Electromagnetic fields
- Noise emissions

Ecology

- The products must be prepared for recycling and the manufacturer must have a certified environmental management system such as EMAS or ISO 14000
- Restrictions on
 - chlorinated and brominated flame retardants and polymers

- heavy metals such as cadmium, mercury and lead.

The requirements included in this label have been developed by TCO Development in co-operation with scientists, experts, users as well as manufacturers all over the world. Since the end of the 1980s TCO has been involved in influencing the development of IT equipment in a more user-friendly direction. Our labeling system with displays in 1992 and is now requested by users and IT-manufacturers all over the world.

For more information, please visit

www.tcodevelopment.com

[Applicable to black cabinet.]



Congratulations!

You have just purchased a TCO'99 approved and labelled product! Your choice has provided you with a product developed for professional use. Your purchase has also contributed to reducing the burden on the environment and also to the further development of environmentally adapted electronics products

Why do we have environmentally labelled computers?

In many countries, environmental labelling has become an established method for encouraging the adaptation of goods and services to the environment. The main problem, as far as computers and other electronics equipment are concerned, is that environmentally harmful substances are used both in the products and during their manufacture. Since it is not so far possible to satisfactorily recycle the majority of electronics equipment, most of these potentially damaging substances sooner or later enter nature.

There are also other characteristics of a computer, such as energy consumption levels, that are important from the viewpoints of both the work (internal) and natural (external) environments. Since all methods of electricity generation have a negative effect on the environment (e.g. acidic and climate-influencing emissions, radioactive waste), it is vital to save energy. Electronics equipment in offices is often left running continuously and thereby consumes a lot of energy.

What does labelling involve?

This product meets the requirements for the TCO'99 scheme which provides for international and environmental labelling of personal computers. The labelling scheme was developed as a joint effort by the TCO (The Swedish Confederation of Professional Employees), Svenska Naturskyddsforeningen (The Swedish Society for Nature Conservation) and Statens Energimyndighet (The Swedish National Energy Administration).

Approval requirements cover a wide range of issues: environment, ergonomics, usability, emission of electric and magnetic fields, energy consumption and electrical and fire safety.

The environmental demands impose restrictions on the presence and use of heavy metals, brominated and chlorinated flame retardants, CFCs (freons) and chlorinated solvents, among other things. The product must be prepared for recycling and the manufacturer is obliged to

have an environmental policy which must be adhered to in each country where the company implements its operational policy.

The energy requirements include a demand that the computer and/or display, after a certain period of inactivity, shall reduce its power consumption to a lower level in one or more stages. The length of time to reactivate the computer shall be reasonable for the user.

Labelled products must meet strict environmental demands, for example, in respect of the reduction of electric and magnetic fields, physical and visual ergonomics and good usability.

You will find a brief summary of the environmental requirements met by this product on the right. The complete environmental criteria document may be ordered from:

TCO Development

SE-114 94 Stockholm, Sweden

Fax: +46 8 782 92 07

Email (Internet): development@tco.se

Current information regarding TCO'99 approved and labelled products may also be obtained via the Internet, using the address: <http://www.tcodevelopment.com/>

Environmental Requirements

Flame retardants

Flame retardants are present in printed circuit boards, cables, wires, casings and housings. Their purpose is to prevent, or at least to delay the spread of fire. Up to 30% of the plastic in a computer casing can consist of flame retardant substances. Most flame retardants contain bromine or chloride, and those flame retardants are chemically related to another group of environmental toxins, PCBs. Both the flame retardants containing bromine or chloride and the PCBs are suspected of giving rise to severe health effects, including reproductive damage in fish-eating birds and mammals, due to the bio-accumulative* processes. Flame retardants have been found in human blood and researchers fear that disturbances in foetus development may occur.

The relevant TCO'99 demand requires that plastic components weighing more than 25 grams must not contain flame retardants with organically bound bromine or chlorine. Flame retardants are allowed in the printed circuit boards since no substitutes are available.

Cadmium**

Cadmium is present in rechargeable batteries and in the colour-generating layers of certain computer displays. Cadmium damages the nervous system and is toxic in high doses.

The relevant TCO'99 requirement states that batteries, the colour-generating layers of display screens and the electrical or electronics components must not contain any cadmium.

Mercury**

Mercury is sometimes found in batteries, relays and switches. It damages the nervous system and is toxic in high doses.

The relevant TCO'99 requirement states that batteries may not contain any mercury. It also demands that mercury is not present in any of the electrical or electronics components associated with the labelled unit.

CFCs (freons)

The relevant TCO'99 requirement states that neither CFCs nor HCFCs may be used during the manufacture and assembly of the product. CFCs (freons) are sometimes used for washing printed circuit boards. CFCs break down ozone and thereby damage the ozone layer in the stratosphere, causing increased reception on earth of ultraviolet light with e.g. increased risks of skin cancer (malignant melanoma) as a consequence.

Lead**

Lead can be found in picture tubes, display screens, solders and capacitors. Lead damages the nervous system and in higher doses, causes lead poisoning.

The relevant TCO'99 requirement permits the inclusion of lead since no replacement has yet been developed.

* Bio-accumulative is defined as substances which accumulate within living organisms.

** Lead, Cadmium and Mercury are heavy metals which are Bio-accumulative.

For U.S.A, Canada, etc. (rated 100-120 Vac) Only

FCC Declaration of Conformity

We, the Responsible Party EIZO NANAOTECHNOLOGIES INC.
5710 Warland Drive, Cypress, CA 90630
Phone: (562) 431-5011

declare that the product Trade name: EIZO
Model: ColorEdge CG210

is in conformity with Part 15 of the FCC Rules. Operation of this product is subject to the following two conditions: (1) this device may not cause harmful interference, and (2) this device must accept any interference received, including interference that may cause undesired operation.

This equipment has been tested and found to comply with the limits for a Class B digital device, pursuant to Part 15 of the FCC Rules. These limits are designed to provide reasonable protection against harmful interference in a residential installation. This equipment generates, uses, and can radiate radio frequency energy and, if not installed and used in accordance with the instructions, may cause harmful interference to radio communications. However, there is no guarantee that interference will not occur in a particular installation. If this equipment does cause harmful interference to radio or television reception, which can be determined by turning the equipment off and on, the user is encouraged to try to correct the interference by one or more of the following measures.

- * Reorient or relocate the receiving antenna.
- * Increase the separation between the equipment and receiver.
- * Connect the equipment into an outlet on a circuit different from that to which the receiver is connected.
- * Consult the dealer or an experienced radio/TV technician for help.

Changes or modifications not expressly approved by the party responsible for compliance could void the user's authority to operate the equipment.

Note
Use the attached specified cable below or EIZO signal cable with this monitor so as to keep interference within the limits of a Class B digital device.

- AC Cord
- Shielded Signal Cable (enclosed)

Canadian Notice

This Class B digital apparatus complies with Canadian ICES-003.
Cet appareil numérique de la classe B est conforme à la norme NMB-003 du Canada.

Hinweis zur Ergonomie

Dieser Monitor erfüllt die Anforderungen an die Ergonomie nach EK1-ITB 2000 mit dem Videosignal, 1600 Punkte X 1200 Zeilen, RGB digital, 0,7 Vp-p und mindestens 75,0 Hz Bildwiederholffrequenz, non interlaced. Weiterhin wird aus ergonomischen Gründen empfohlen, die Grundfarbe Blau nicht auf dunklem Untergrund zu verwenden (schlechte Erkennbarkeit, Augenbelastung bei zu geringem Zeichenkontrast.)

„Maschinenlärminformations-Verordnung 3. GPSGV:

Der höchste Schalldruckpegel beträgt 70 dB(A) oder weniger demäss EN ISO 7779“

Recycling Information for customers in EU:

All recycling information is placed in the following websites.

Recycling-Information für Kunden in Europa:

Alle Informationen zum Thema Recycling finden Sie auf den folgenden Websites:

Informations sur le recyclage pour les clients dans l'UE:

Vous trouverez toutes les informations sur le recyclage dans les sites Web suivants:

Återvinningsinformation för kunder i EU:

All information om återvinning finns på följande webbsidor:

<http://www.swico.ch>

<http://www.eizo.de>

<http://www.eizo.se>

Recycling Information for customers in USA:

All recycling information is placed in the Eizo Nanao Technologies, Inc.'s website.

<http://www.eizo.com>

Hinweise zur Auswahl des richtigen Schwenkarms für Ihren Monitor

Dieser Monitor ist für Bildschirmarbeitsplätze vorgesehen. Wenn nicht der zum Standardzubehör gehörige Schwenkarm verwendet wird, muss statt dessen ein geeigneter anderer Schwenkarm installiert werden. Bei der Auswahl des Schwenkarms sind die nachstehenden Hinweise zu berücksichtigen:

Der Standfuß muß den nachfolgenden Anforderungen entsprechen:

- a) Der Standfuß muß eine ausreichende mechanische Stabilität zur Aufnahme des Gewichtes vom Bildschirmgerät und des spezifizierten Zubehörs besitzen. Das Gewicht des Bildschirmgerätes und des Zubehörs sind in der zugehörigen Bedienungsanleitung angegeben.
- b) Die Befestigung des Standfusses muß derart erfolgen, daß die oberste Zeile der Bildschirmanzeige nicht höher als die Augenhöhe eines Benutzers in sitzender Position ist.
- c) Im Fall eines stehenden Benutzers muß die Befestigung des Bildschirmgerätes derart erfolgen, daß die Höhe der Bildschirmmitte über dem Boden zwischen 135 - 150 cm beträgt.
- d) Der Standfuß muß die Möglichkeit zur Neigung des Bildschirmgerätes besitzen (max. vorwärts: 5°, min. nach hinten \geq 5°)

- e) Der Standfuß muß die Möglichkeit zur Drehung des Bildschirmgerätes besitzen (max. $\pm 180^\circ$). Der maximale Kraftaufwand dafür muß weniger als 100 N betragen.
- f) Der Standfuß muß in der Stellung verharren, in die er manuell bewegt wurde.
- g) Der Glanzgrad des Standfusses muß weniger als 20 Glanzeinheiten betragen (seidenmatt).
- h) Der Standfuß mit Bildschirmgerät muß bei einer Neigung von bis zu 10° aus der normalen aufrechten Position kippsicher sein.