

User's Manual

FlexScan® EV2316W EV2336W EV2416W EV2436W

Color LCD Monitor

Important

Please read PRECAUTIONS, this User's Manual, and the Setup Guide (separate volume) carefully to familiarize yourself with safe and effective usage.

-
- Please refer to the Setup Guide for basic information ranging from connection of the monitor to a PC to using the monitor.
 - The latest User's Manual is available for download from our web site:
<http://www.eizo.com>
-



Location of Caution Statement

EV2316W / EV2336W (Ex.FlexStand2)

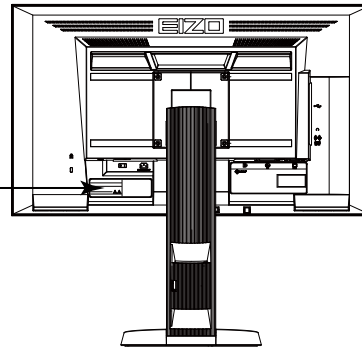

CAUTION
Risk of electric shock. Do not open.
ATTENTION
Risque de choc électrique. Ne pas ouvrir.
ACHTUNG
Gefahr des elektrischen schlages. Rückwand nicht entfernen.
小心
有触电的风险。请勿打开。
警告
感電の恐れあり。カバーをあげないでください。

The equipment must be connected to a grounded main outlet.
Jordet stikkontakt skal benyttes når apparatet tilkobles datanett.
Apparaten skall anslutas till jordat nätuttag.
这设备必须连接至接地主插座。
電源コードのアースは必ず接地してください。

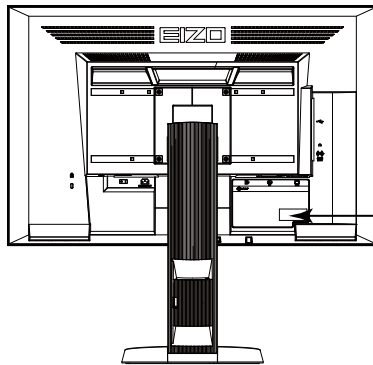

EV2416W / EV2436W (Ex.FlexStand2)



CAUTION
Risk of electric shock. Do not open.
ATTENTION
Risque de choc électrique. Ne pas ouvrir.
ACHTUNG
Gefahr des elektrischen schlages. Rückwand nicht entfernen.
小心
有触电的风险。请勿打开。
警告
感電の恐れあり。カバーをあげないでください。

The equipment must be connected to a grounded main outlet.
Jordet stikkontakt skal benyttes når apparatet tilkobles datanett.
Apparaten skall anslutas till jordat nätuttag.
这设备必须连接至接地主插座。
電源コードのアースは必ず接地してください。

This product has been adjusted specifically for use in the region to which it was originally shipped. If operated outside this region, the product may not perform as stated in the specifications.

No part of this manual may be reproduced, stored in a retrieval system, or transmitted, in any form or by any means, electronic, mechanical, or otherwise, without the prior written permission of EIZO Corporation.

EIZO Corporation is under no obligation to hold any submitted material or information confidential unless prior arrangements are made pursuant to EIZO Corporation's receipt of said information. Although every effort has been made to ensure that this manual provides up-to-date information, please note that EIZO monitor specifications are subject to change without notice.

Notice for this monitor

This product is suited to general purposes like creating documents, viewing multimedia content.

This product has been adjusted specifically for use in the region to which it was originally shipped. If the product is used outside the region, it may not operate as specified in the specifications.

This product may not be covered by warranty for uses other than those described in this manual.

The specifications noted in this manual are only applicable when the following are used:

- Power cords provided with the product
 - Signal cables specified by us
-

Only use optional products manufactured or specified by us with this product.

It takes about 30 minutes for the performance of electrical parts to stabilize. Please wait 30 minutes or more after the monitor power has been turned on, and then adjust the monitor.

Monitors should be set to a lower brightness to reduce changes in luminosity caused by long-term use and maintain a stable display.

When the screen image is changed after displaying the same image for extended periods of time, an afterimage may appear. Use the screen saver or power save function to avoid displaying the same image for extended periods of time.

Periodic cleaning is recommended to keep the monitor looking new and to prolong its operation lifetime (refer to [“Cleaning” \(page 4\)](#)).

The LCD panel is manufactured using high-precision technology. Although, missing pixels or lit pixels may appear on the LCD panel, this is not a malfunction. Percentage of effective dots: 99.9994% or higher.

The backlight of the LCD panel has a fixed lifetime. When the screen becomes dark or begins to flicker, please contact your local EIZO representative.

Do not press on the panel or edge of the frame strongly, as this may result in display malfunctions, such as interference patterns, etc. If pressure is continually applied to the panel, it may deteriorate or damage your panel. (If the pressure marks remain on the panel, leave the monitor with a black or white screen. The symptom may disappear.)

Do not scratch or press on the panel with any sharp objects, as this may result in damage to the panel. Do not attempt to brush with tissues as this may scratch the panel.

When the monitor is cold and brought into a room or the room temperature goes up quickly, dew condensation may occur on the interior and exterior surfaces of the monitor. In that case, do not turn the monitor on. Instead wait until the dew condensation disappears, otherwise it may cause some damage to the monitor.

Cleaning

Attention

- Chemicals such as alcohol and antiseptic solution may cause gloss variation, tarnishing, and fading of the cabinet or panel, and also quality deterioration of the image.
 - Never use any thinner, benzene, wax, and abrasive cleaner, which may damage the cabinet or panel.
-

Note

- The optional ScreenCleaner is recommended for cleaning the cabinet and panel surface.
-

If necessary, the stains on the cabinet and panel surface can be removed by moistening part of a soft cloth with water.

To use the monitor comfortably

- An excessively dark or bright screen may affect your eyes. Adjust the brightness of the monitor according to the environmental conditions.
- Staring at the monitor for a long time tires your eyes. Take a 10-minute rest every hour.

CONTENTS

Cover	1	Chapter 3 Setting Monitor	31
Notice for this monitor	3	3-1. Adjusting Volume.....	31
Cleaning	4	3-2. Selecting sound source while using the DisplayPort signal input.....	31
To use the monitor comfortably	4	3-3. Compensating viewing angle deficiency (EV2316W / EV2416W only)	32
CONTENTS	5	3-4. Enabling / Disabling DDC/CI communication	32
Chapter 1 Introduction	7	3-5. Locking Operation Buttons	33
1-1. Features	7	3-6. Setting Orientation	33
1-2. Controls and Functions	9	3-7. Showing and hiding the EIZO logo	33
● Front	9	3-8. Changing Setting Menu Display Position	34
● Rear.....	10	3-9. Setting Language.....	34
1-3. EIZO LCD Utility Disk.....	11	3-10. Resetting the Monitor to the Default Settings	35
● Disk contents and software overview	11	● To reset the color adjustments.....	35
● To use “ScreenManager Pro for LCD (DDC/CI) / EIZO ScreenSlicer”	11	● To reset “EcoView Sense Settings”	35
1-4. Basic Operations and Functions	12	● To reset all adjustments to the default settings.....	35
● Basic operation of the Setting menu.....	12	Chapter 4 Power Saving Functions	36
● Functions	13	4-1. Setting Power Saving	36
Chapter 2 Adjusting Screens	14	● Monitor	36
2-1. Compatible Resolutions	14	● Audio Output	37
● EV2316W	14	4-2. Setting Power Indicator.....	37
● EV2336W	15	4-3. Enabling / Disabling Automatic Brightness Adjustment	37
● EV2416W.....	16	● Auto EcoView	37
● EV2436W	17	● EcoView Optimizer 2	38
2-2. Setting the Resolution	18	4-4. Setting the power saving mode when a person leaves the monitor	38
● Windows 8 / Windows 7	18	4-5. Checking the power saving level	40
● Windows Vista.....	18	4-6. Enabling / Disabling Auto Power-OFF	40
● Windows XP	18	Chapter 5 Troubleshooting	41
● Mac OS X	18	5-1. No picture	41
2-3. Adjusting Color	19	5-2. Imaging problems (for both digital and analog).....	42
● To select the display mode (FineContrast Mode)	19	5-3. Imaging problems (for digital only)	43
● To perform advanced adjustments	20	5-4. Imaging problems (for analog only)	43
● Adjustable settings in each mode	20	5-5. Other problems	44
● To adjust brightness	20	Chapter 6 Reference	46
● To adjust contrast.....	21	6-1. Attaching the Optional Arm.....	46
● To adjust color temperature	21	6-2. Detaching / Attaching the TriStand2 Stand Base.....	47
● To adjust gamma	22	6-3. Attaching / Detaching the TriStand2 Cable Holder.....	49
● To adjust the color saturation.....	22	6-4. Connecting Multiple PCs	51
● To adjust hue.....	23		
● To set overdrive intensity (EV2336W / EV2436W only)	23		
● To adjust gain	24		
2-4. Screen Adjustment	25		
● Digital Signal Input	25		
● Analog Signal Input.....	25		
2-5. Screen Size Changing	29		
● Screen Size Changing	29		
● To adjust brightness of non-display area	30		

● To switch among input signals	51
● To set input signal selection	52
6-5. Making Use of USB (Universal Serial Bus).....	52
● Required System Environment	52
● Connection Procedure (Setup of USB Function).....	53
6-6. Displaying Monitor Information	53
6-7. Specifications	54
● EV2316W	54
● EV2336W	55
● EV2416W.....	57
● EV2436W	58
● Main Default Settings	60
● Outside Dimensions	60
● Accessories.....	62
6-8. Preset Timing	63
● EV2316W	63
● EV2336W	63
● EV2416W.....	64
● EV2436W	64
6-9. Glossary.....	65
Appendix.....	67
Trademark	67
License	67
ENERGY STAR.....	68
TCO	68
FCC Declaration of Conformity	69
Hinweise zur Auswahl des richtigen Schwenkarms für Ihren Monitor.....	70
Hinweis zur Ergonomie :	70
LIMITED WARRANTY	71
Recycling Information	80
China Measures for RoHS Compliance in ChinaRoHS.....	84

Chapter 1 Introduction

Thank you very much for choosing an EIZO color LCD monitor.

1-1. Features

- 23.0" wide format LCD (EV2316W / EV2336W)
- 24.1" wide format LCD (EV2416W / EV2436W)
- Supports a resolution of 1920 × 1080 (EV2316W / EV2336W)
- Supports a resolution of 1920 × 1200 (EV2416W / EV2436W)
- IPS panel with 89° horizontal and vertical viewing angles (EV2336W / EV2436W only)
- Applicable to DisplayPort (applicable to 8 bit)^{*1}

The DisplayPort input receives both an image signal and an audio signal via a single DisplayPort cable.

^{*1} When transmitting an audio signal using the DisplayPort cable, the graphics board must be compatible with audio output (see "6-7. Specifications" (page 54)).
- The FineContrast function allows the user to select the display mode optimum to the displayed image.
 - The Paper mode reproduces a printed paper effect on the monitor.

See "To select the display mode (FineContrast Mode)" (page 19).
- The software "ScreenManager Pro for LCD (DDC/CI)" to adjust the screen using the mouse and keyboard is included

See "1-3. EIZO LCD Utility Disk" (page 11).

 - EyeCare Filter

Texture of the paper is reproduced by displaying a translucent image in the foreground of the desktop.
By using this function with the Paper mode, the screen looks more like paper.
See "To select the display mode (FineContrast Mode)" (page 19).
- Supports the power management software "EIZO EcoView NET"

For more information, refer to our web site (<http://www.eizo.com>).
- Power saving function

Suppressing the power consumption^{*2} reduces the carbon dioxide emissions. This product is equipped with power saving function.

 - 0 W power consumption when the main power is off

Equipped with main power switch.
When the monitor is not required, the power supply can be shut off using the main power switch.
 - Auto EcoView

The ambient light sensor on the front side of the monitor detects the environmental brightness to adjust the screen brightness automatically and comfortably. Excessively high brightness may increase power consumption and cause unwanted environmental effects. It may also lead to fatigue of your eyes. Use the Auto EcoView to reduce the brightness.
See "Auto EcoView" (page 37).
 - EcoView Optimizer 2

The monitor automatically adjusts the screen brightness according to the white level of the input signal. This function can reduce the power consumption while maintaining the brightness specified by the input signal.
See "EcoView Optimizer 2" (page 38).
 - EcoView Sense

The sensor on the front side of the monitor detects the movement of a person. When a person moves away from the monitor, the monitor shifts to the power saving mode automatically and does not display the images on the screen. Therefore, the function reduces the power consumption. The sensitivity and time until the power saving mode is activated can be set according to the monitor usage environment and movement of the user.
See "4-4. Setting the power saving mode when a person leaves the monitor" (page 38).

*2 Reference values:

EV2316W

Maximum power consumption: 43 W (Brightness Max., when a USB device is connected, speaker working, at default settings)

Standard power consumption: 14 W (Brightness 120 cd/m², when no USB device is connected, speaker not working, at default settings)

EV2336W

Maximum power consumption: 40 W (Brightness Max., when a USB device is connected, speaker working, at default settings)

Standard power consumption: 14 W (100VAC, Brightness 120 cd/m², when no USB device is connected, speaker not working, at default settings)

Standard power consumption: 15 W (200VAC, Brightness 120 cd/m², when no USB device is connected, speaker not working, at default settings)

EV2416W

Maximum power consumption: 40 W (Brightness Max., when a USB device is connected, speaker working, at default settings)

Standard power consumption: 11 W (Brightness 120 cd/m², when no USB device is connected, speaker not working, at default settings)

EV2436W

Maximum power consumption: 60 W (Brightness Max., when a USB device is connected, speaker working, at default settings)

Standard power consumption: 19 W (Brightness 120 cd/m², when no USB device is connected, speaker not working, at default settings)

- Up View (EV2316W / EV2416W only)

The viewing angle is adjusted so that the screen looks like a front view when the screen is looked up.

See “3-3. Compensating viewing angle deficiency (EV2316W / EV2416W only)” (page 32).

- Supports portrait and landscape formats (FlexStand2 only)

- Displays HDCP (High-bandwidth Digital Protection) protected contents.

Note

- This monitor supports the portrait display. This function allows you to change the orientation of the Setting menu when using the monitor screen in vertical display position (see “3-6. Setting Orientation” (page 33)).

- When using the monitor screen in a portrait position, the graphics board supporting portrait display is required. When placing the monitor in a portrait position, the settings of your graphics board need to be changed. Refer to the User’s Manual of the graphics board for details.

1-2. Controls and Functions

● Front

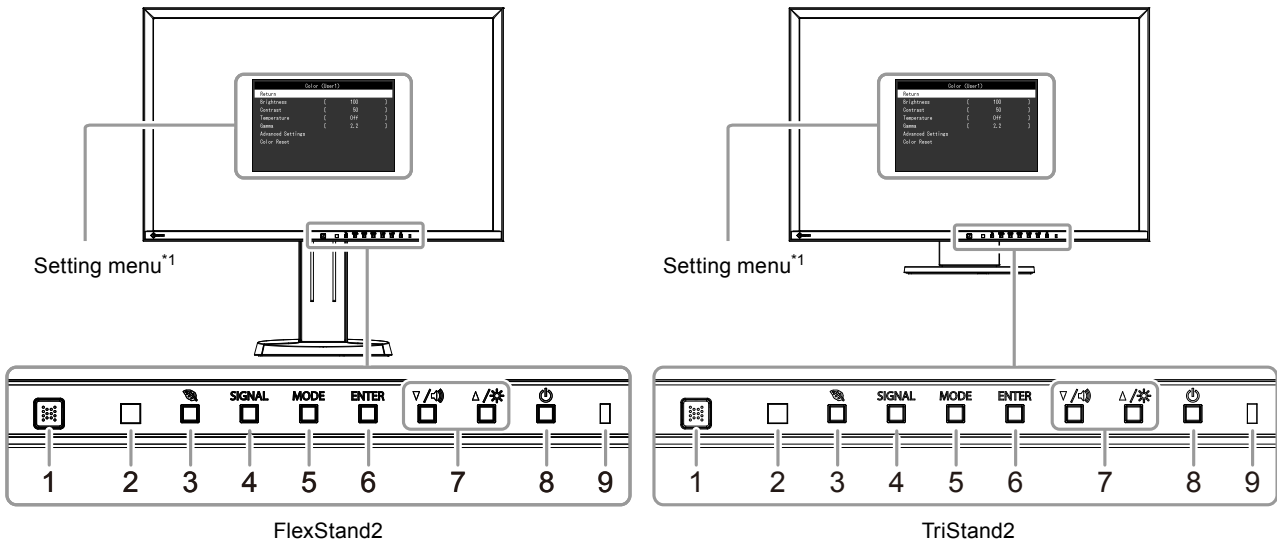

1. EcoView Sense sensor	Detects the movement of a person in front of the monitor (EcoView Sense function (page 38)).
2. Ambient light sensor	Detects ambient brightness (Auto EcoView function (page 37)).
3. button	Displays the setting menu of the power saving function (Auto EcoView (page 37) and EcoView Optimizer 2 (page 38)) and EcoView Sense (page 38).
4. SIGNAL button	Switches input signals for display (page 51).
5. MODE button	Changes the FineContrast mode (page 19).
6. ENTER button	Displays the Setting menu, determines an item on the menu screen, and saves values adjusted (page 12).
7. , button*2	<ul style="list-style-type: none"> Provides the menu selection as well as the adjustment and setting of a function. button: Displays the volume adjustment menu (page 31). button: Displays the Brightness adjustment menu (page 20).
8. button	Turns the power on or off.
9. Power indicator	Indicates the monitor's operation status. Blue: Operating Orange: Power saving mode OFF: Main power / Power off

*1 See "1-4. Basic Operations and Functions" (page 12) for how to use.

*2 In this User's Manual, the button may be hereafter simply displayed as , and the button as .

● Rear

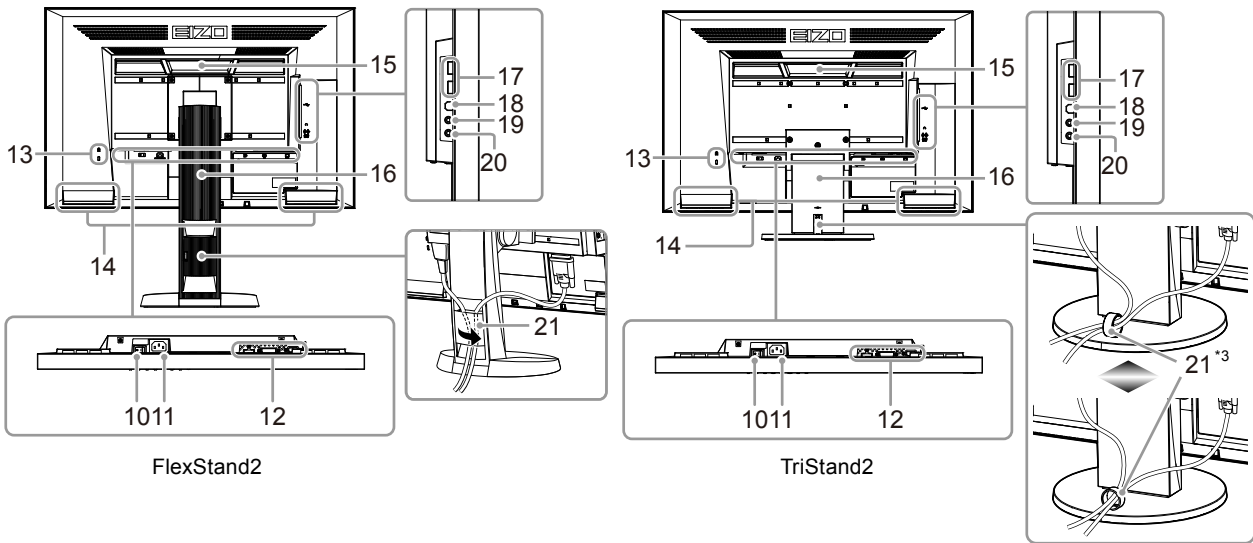

10. Main power switch	Turns the main power on or off.
11. Power connector	Connects the power cord.
12. Input signal connector	Left: DisplayPort connector / Center: DVI-D connector / Right: D-Sub mini15-pin connector
13. Security lock slot	Complies with Kensington's MicroSaver security system.
14. Speaker	Outputs audio source.
15. Handle	Handle used for transportation Attention <ul style="list-style-type: none"> Firmly grasp and hold the monitor by the bottom while grabbing the handle, and carefully convey the monitor so as not to drop it.
16. Stand*4	Adjusts the height and angle (tilt and swivel) of the monitor.
17. USB port (DOWN)	Connects a peripheral USB device.
18. USB port (UP)	Connects the USB cable for using the USB Hub function (page 52).
19. Headphone jack	Connects the headphones.
20. Stereo mini jack	Connects the stereo mini jack cable (commercially available product).
21. Cable holder	Covers the monitor cables.

*3 See "6-3. Attaching / Detaching the TriStand2 Cable Holder" ([page 49](#)) for how to attach the cable holder.

*4 An optional arm (or an optional stand) can be attached by removing the stand (see "6-1. Attaching the Optional Arm" ([page 46](#))).

1-3. EIZO LCD Utility Disk

An “EIZO LCD Utility Disk” (CD-ROM) is supplied with this product. The following table shows the disk contents and the overview of the software programs.

● Disk contents and software overview

The disk includes software programs for adjustment, and User’s Manual. Refer to Readme.txt file on the disk for software startup procedures or file access procedures.

Item	Overview	Windows	Macintosh
Screen adjustment pattern files	Used when adjusting the image of analog signal input manually.	√	√
ScreenManager Pro for LCD (DDC/CI)	Software for adjusting the screen using the mouse and keyboard.	√	-
EIZO ScreenSlicer	Software that divides a screen and lays out multiple windows efficiently.	√	-
User’s Manual of this monitor (PDF file)		√	√
Readme.txt file		√	√

● To use “ScreenManager Pro for LCD (DDC/CI) / EIZO ScreenSlicer”

For the installation and use of “ScreenManager Pro for LCD (DDC/CI) / EIZO ScreenSlicer”, refer to the respective User’s Manual on the disk.

1-4. Basic Operations and Functions

● Basic operation of the Setting menu

1. Displaying the Setting menu

1. Press ENTER. The Setting menu appears.

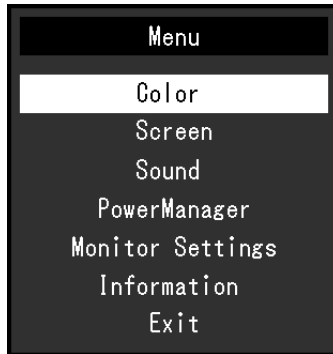

2. Adjusting / Setting

1. Choose a menu to adjust / set with ▼,▲, and then press ENTER. The Sub menu appears.

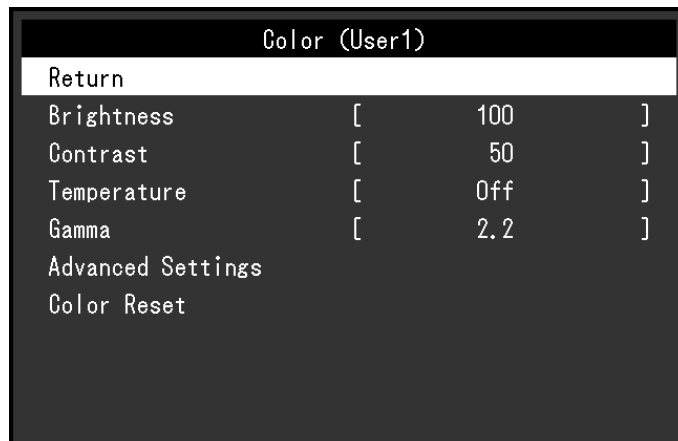

2. Choose an item to adjust / set with ▼,▲, and then press ENTER. The adjustment / setting menu appears.



3. Adjust / set the selected item with ▼,▲, and then press ENTER.

3. Exiting

1. Choose "Return" from the Sub menu and press ENTER. The Setting menu appears.
2. Choose "Exit" from the Main menu and press ENTER. The Setting menu quits.

Note

- The Setting menu can also be exited by pressing ENTER twice quickly.
-

● Functions

The following table shows the Setting menu and setting items of each menu.

Main menu	Setting	Reference	
Color ^{*1}	Brightness	"2-3. Adjusting Color" (page 19)	
	Contrast		
	Temperature		
	Gamma		
	Advanced Settings		Saturation
			Hue
		Overdrive ^{*2}	
Gain			
Color Reset	"To reset the color adjustments" (page 35)		
Screen	Screen Size	"Screen Size Changing" (page 29)	
	Smoothing	"2-4. Screen Adjustment" (page 25)	
	Analog Adjustment ^{*3}		Auto Screen Adjust
			Auto Range Adjust
			Clock
			Phase
			Hor.Position
Ver.Position			
Sound	Source	"3-2. Selecting sound source while using the DisplayPort signal input" (page 31)	
	Power Save	"Audio Output" (page 37)	
PowerManager	Power Save	"4-1. Setting Power Saving" (page 36)	
	Eco Timer	"4-6. Enabling / Disabling Auto Power-OFF" (page 40)	
Monitor Settings	Up View ^{*4}	"3-3. Compensating viewing angle deficiency (EV2316W / EV2416W only)" (page 32)	
	Input Signal	"To set input signal selection" (page 52)	
	Power Indicator	"4-2. Setting Power Indicator" (page 37)	
	Language	"3-9. Setting Language" (page 34)	
	DDC/CI	"3-4. Enabling / Disabling DDC/CI communication" (page 32)	
	Border Intensity	"To adjust brightness of non-display area" (page 30)	
	Menu Settings	Orientation	"3-6. Setting Orientation" (page 33)
		Logo	"3-7. Showing and hiding the EIZO logo" (page 33)
		Menu Position	"3-8. Changing Setting Menu Display Position" (page 34)
	Reset	"To reset all adjustments to the default settings" (page 35)	
Information	"6-6. Displaying Monitor Information" (page 53)		

*1 The adjustment / settings available on the "Color" menu depend on the selected Color mode. The above table shows the sub menus when the User1 or User2 mode is selected.

*2 EV2336W / EV2436W only

*3 These functions can be adjusted with analog input.

*4 EV2316W / EV2416W only

Chapter 2 Adjusting Screens

2-1. Compatible Resolutions

The monitor supports the following resolutions.

● EV2316W

Analog Input (D-Sub)

Resolution	Applicable Signals	Vertical Scan Frequency	Dot Clock
640 × 480	VGA	60 Hz	148.5 MHz (Max.)
800 × 600	VESA	60 Hz	
1024 × 768	VESA	60 Hz	
1280 × 720	CEA-861	60 Hz	
1280 × 960	VESA	60 Hz	
1280 × 1024	VESA	60 Hz	
1680 × 1050	VESA CVT, VESA CVT RB	60 Hz	
1920 × 1080 ^{*1}	CEA-861	60 Hz	

Digital Input (DVI-D)

Resolution	Applicable Signals	Vertical Scan Frequency	Dot Clock
640 × 480	VGA	60 Hz	148.5 MHz (Max.)
800 × 600	VESA	60 Hz	
1024 × 768	VESA	60 Hz	
1280 × 720	CEA-861	60 Hz	
1280 × 960	VESA	60 Hz	
1280 × 1024	VESA	60 Hz	
1680 × 1050	VESA CVT, VESA CVT RB	60 Hz	
1920 × 1080 ^{*1}	CEA-861	60 Hz	

Digital Input (DisplayPort)

Resolution	Applicable Signals	Vertical Scan Frequency	Dot Clock
640 × 480	VGA, CEA-861	60 Hz	148.5 MHz (Max.)
720 × 480 (4:3)	CEA-861	60 Hz	
720 × 480 (16:9)	CEA-861	60 Hz	
800 × 600	VESA	60 Hz	
1024 × 768	VESA	60 Hz	
1280 × 720	CEA-861	60 Hz	
1280 × 960	VESA	60 Hz	
1280 × 1024	VESA	60 Hz	
1680 × 1050	VESA CVT, VESA CVT RB	60 Hz	
1920 × 1080 ^{*1}	CEA-861	60 Hz	

The graphics board should comply with the VESA standard and CEA-861 standard.

*1 Recommended resolution

● EV2336W

Analog Input (D-Sub)

Resolution	Applicable Signals	Vertical Scan Frequency	Dot Clock
640 × 480	VGA, VESA	~75 Hz	148.5 MHz (Max.)
720 × 400	VGA TEXT	70 Hz	
800 × 600	VESA	~75 Hz	
1024 × 768	VESA	~75 Hz	
1280 × 720	CEA-861	60 Hz	
1280 × 960	VESA	60 Hz	
1280 × 1024	VESA	~75 Hz	
1680 × 1050	VESA CVT, VESA CVT RB	60 Hz	
1920 × 1080 ^{*1}	CEA-861	60 Hz	

Digital Input (DVI-D)

Resolution	Applicable Signals	Vertical Scan Frequency	Dot Clock
640 × 480	VGA	60 Hz	148.5 MHz (Max.)
720 × 400	VGA TEXT	70 Hz	
800 × 600	VESA	60 Hz	
1024 × 768	VESA	60 Hz	
1280 × 720	CEA-861	60 Hz	
1280 × 960	VESA	60 Hz	
1280 × 1024	VESA	60 Hz	
1680 × 1050	VESA CVT, VESA CVT RB	60 Hz	
1920 × 1080 ^{*1}	CEA-861	60 Hz	

Digital Input (DisplayPort)

Resolution	Applicable Signals	Vertical Scan Frequency	Dot Clock
640 × 480	VGA, CEA-861	60 Hz	148.5 MHz (Max.)
720 × 400	VGA TEXT	70 Hz	
720 × 480 (4:3)	CEA-861	60 Hz	
720 × 480 (16:9)	CEA-861	60 Hz	
800 × 600	VESA	60 Hz	
1024 × 768	VESA	60 Hz	
1280 × 720	CEA-861	60 Hz	
1280 × 960	VESA	60 Hz	
1280 × 1024	VESA	60 Hz	
1680 × 1050	VESA CVT, VESA CVT RB	60 Hz	
1920 × 1080 ^{*1}	CEA-861	60 Hz	

The graphics board should comply with the VESA standard and CEA-861 standard.

*1 Recommended resolution

● EV2416W

Analog Input (D-Sub)

Resolution	Applicable Signals	Vertical Scan Frequency	Dot Clock
640 × 480	VGA	60 Hz	193.3 MHz (Max.)
800 × 600	VESA	60 Hz	
1024 × 768	VESA	60 Hz	
1280 × 720 ^{*1}	CEA-861	60 Hz	
1280 × 960	VESA	60 Hz	
1280 × 1024	VESA	60 Hz	
1600 × 1200	VESA	60 Hz	
1680 × 1050	VESA CVT, VESA CVT RB	60 Hz	
1920 × 1200 ^{*2}	VESA CVT, VESA CVT RB	60 Hz	

Digital Input (DVI-D)

Resolution	Applicable Signals	Vertical Scan Frequency	Dot Clock
640 × 480	VGA	60 Hz	162 MHz (Max.)
800 × 600	VESA	60 Hz	
1024 × 768	VESA	60 Hz	
1280 × 720 ^{*1}	CEA-861	60 Hz	
1280 × 960	VESA	60 Hz	
1280 × 1024	VESA	60 Hz	
1600 × 1200	VESA	60 Hz	
1680 × 1050	VESA CVT, VESA CVT RB	60 Hz	
1920 × 1200 ^{*2}	VESA CVT RB	60 Hz	

Digital Input (DisplayPort)

Resolution	Applicable Signals	Vertical Scan Frequency	Dot Clock
640 × 480	VGA, CEA-861	60 Hz	162 MHz (Max.)
720 × 480 (4:3)	CEA-861	60 Hz	
720 × 480 (16:9)	CEA-861	60 Hz	
800 × 600	VESA	60 Hz	
1024 × 768	VESA	60 Hz	
1280 × 720 ^{*1}	CEA-861	60 Hz	
1280 × 960	VESA	60 Hz	
1280 × 1024	VESA	60 Hz	
1600 × 1200	VESA	60 Hz	
1680 × 1050	VESA CVT, VESA CVT RB	60 Hz	
1920 × 1200 ^{*2}	VESA CVT RB	60 Hz	

The graphics board should comply with the VESA standard and CEA-861 standard.

*1 For this resolution, the “Screen Size” setting is “Full Screen” (see “2-5. Screen Size Changing” (page 29)).

*2 Recommended resolution

● EV2436W

Analog Input (D-Sub)

Resolution	Applicable Signals	Vertical Scan Frequency	Dot Clock
640 × 480	VGA, VESA	~75 Hz	193.3 MHz (Max.)
720 × 400	VGA TEXT	70 Hz	
800 × 600	VESA	~75 Hz	
1024 × 768	VESA	~75 Hz	
1280 × 720	CEA-861	60 Hz	
1280 × 960	VESA	60 Hz	
1280 × 1024	VESA	~75 Hz	
1600 × 1200	VESA	60 Hz	
1680 × 1050	VESA CVT, VESA CVT RB	60 Hz	
1920 × 1200 ^{*1}	VESA CVT, VESA CVT RB	60 Hz	

Digital Input (DVI-D)

Resolution	Applicable Signals	Vertical Scan Frequency	Dot Clock
640 × 480	VGA	60 Hz	162 MHz (Max.)
720 × 400	VGA TEXT	70 Hz	
800 × 600	VESA	60 Hz	
1024 × 768	VESA	60 Hz	
1280 × 720	CEA-861	60 Hz	
1280 × 960	VESA	60 Hz	
1280 × 1024	VESA	60 Hz	
1600 × 1200	VESA	60 Hz	
1680 × 1050	VESA CVT, VESA CVT RB	60 Hz	
1920 × 1200 ^{*1}	VESA CVT RB	60 Hz	

Digital Input (DisplayPort)

Resolution	Applicable Signals	Vertical Scan Frequency	Dot Clock
640 × 480	VGA, CEA-861	60 Hz	162 MHz (Max.)
720 × 400	VGA TEXT	70 Hz	
720 × 480 (4:3)	CEA-861	60 Hz	
720 × 480 (16:9)	CEA-861	60 Hz	
800 × 600	VESA	60 Hz	
1024 × 768	VESA	60 Hz	
1280 × 720	CEA-861	60 Hz	
1280 × 960	VESA	60 Hz	
1280 × 1024	VESA	60 Hz	
1600 × 1200	VESA	60 Hz	
1680 × 1050	VESA CVT, VESA CVT RB	60 Hz	
1920 × 1200 ^{*1}	VESA CVT RB	60 Hz	

The graphics board should comply with the VESA standard and CEA-861 standard.

*1 Recommended resolution

2-2. Setting the Resolution

When you connect the monitor to the PC and find that the resolution is improper, or when you want to change the resolution, follow the procedure below.

● Windows 8 / Windows 7

1. For Windows 8, click the “Desktop” tile on the Start Screen to display the desktop.
2. Right-click the mouse anywhere on the desktop except for icons.
3. From the displayed menu, click “Screen resolution”.
4. On the “Screen Resolution” dialog box, select the monitor.
5. Click “Resolution” to select the desired resolution.
6. Click the “OK” button.
7. When a confirmation dialog box is displayed, click “Keep changes”.

● Windows Vista

1. Right-click the mouse anywhere on the desktop except for icons.
2. From the displayed menu, click “Personalize”.
3. On the “Personalization” window, click “Display Settings”.
4. On the “Display Settings” dialog box, select the “Monitor” tab and select desired resolution in the “Resolution” field.
5. Click the “OK” button.
6. When a confirmation dialog box is displayed, click “Yes”.

● Windows XP

1. Right-click the mouse anywhere on the desktop except for icons.
2. From the displayed menu, click “Properties”.
3. When the “Display Properties” dialog box is displayed, click the “Settings” tab and select desired resolution for “Screen resolution” under “Display”.
4. Click the “OK” button to close the dialog box.

● Mac OS X

1. Select “System Preferences” from the Apple menu.
2. When the “System Preferences” dialog box is displayed, click “Displays” for “Hardware”.
3. On the displayed dialog box, select the “Display” tab and select desired resolution in the “Resolutions” field.
4. Your selection will be reflected immediately. When you are satisfied with the selected resolution, close the window.

2-3. Adjusting Color

● To select the display mode (FineContrast Mode)

This function allows easy selection of a desired mode according to monitor application.

Display Modes

Mode	Purpose
User1	Select this to define a desired set of parameter settings.
User2	
sRGB	Suitable for color matching with sRGB compatible peripherals.
Paper	Produces a printed paper effect. Suitable for displaying images from media such as books and documents.
Movie	Suitable for playing back animated images.

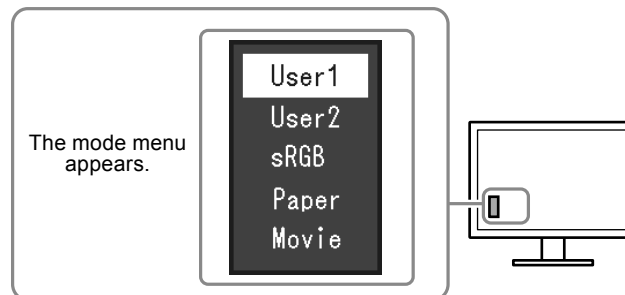

Procedure

1. Press MODE.

The mode menu appears at the bottom left of the screen.

2. The mode among the list is highlighted in turn each time MODE is pressed.

You can switch the mode with ▼ or ▲ while the mode menu is displayed.

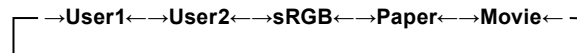

Note

- The Setting menu and the Mode menu cannot be displayed at the same time.
- "ScreenManager Pro for LCD (DDC/CI)" allows you to select the FineContrast mode automatically according to the application used (see "Chapter 3 Auto FineContrast" in the "ScreenManager Pro for LCD (DDC/CI)" User's Manual).

● To perform advanced adjustments

The “Color” menu of the Setting menu allows you to set and save the independent color adjustment for each mode.

Attention

- It takes about 30 minutes for the performance of electrical parts to stabilize. Please wait 30 minutes or more after the monitor power has been turned on, and then adjust the monitor.
- Perform the range adjustment first when adjusting color for analog signals (see [“To adjust color gradation automatically” \(page 28\)](#)).
- The same image may be seen in different colors on multiple monitors due to their monitor-specific characteristics. Make fine color adjustment visually when matching colors on multiple monitors.

Note

- Using the “ScreenManager Pro for LCD (DDC/CI)” allows you to perform the color adjustment by using the mouse and keyboard of your PC. (Refer to “Chapter 4 Color Adjustment” in the User’s Manual for “ScreenManager Pro for LCD (DDC/CI)”.)

● Adjustable settings in each mode

The adjustable settings depend on the mode. (Non-adjustable or non-settable function cannot be selected.)

√: Adjustable - : Not adjustable

Function	FineContrast Mode					
	User1	User2	sRGB	Paper	Movie	
Brightness	√	√	√	√	√	
Contrast	√	√	-	-	√	
Temperature	√	√	-	√	√	
Gamma	√	√	-	-	-	
Advanced Settings	Saturation	√	√	-	-	√
	Hue	√	√	-	-	√
	Overdrive ^{*1}	√	√	-	-	-
	Gain	√	√	-	-	-
Color Reset	√	√	√	√	√	

*1 EV2336W / EV2436W only

● To adjust brightness

The screen brightness is adjusted by changing the brightness of the backlight (light source from the LCD back panel).

Adjustable range

0 to 100

Procedure

1. Press ▲/☼.
2. Use ▼ or ▲ for adjustment.
3. Press ENTER to exit.

Note

- If you feel that the image is too dark even if the brightness is set to 100, adjust the contrast.
- Alternatively, you can use “Brightness” under “Color” in the Adjustment menu to adjust it.
- To adjust the screen brightness automatically and comfortably, see [“4-3. Enabling / Disabling Automatic Brightness Adjustment” \(page 37\)](#).

● To adjust contrast

The brightness of the screen is adjusted by varying the video signal level.

Adjustable range

0 to 100

Procedure

1. Choose “Color” in the Setting menu, and press ENTER.
2. Choose “Contrast” in the “Color” menu, and press ENTER.
The “Contrast” menu appears.
3. Use ▼ or ▲ for adjustment.
4. Press ENTER to exit.

Note

- In the contrast of 50, every color gradation is displayed.
 - When adjusting the monitor, it is recommended to perform the brightness adjustment which may not lose the gradation characteristics, prior to the contrast adjustment.
 - Perform the contrast adjustment in the following cases.
 - When you feel the image is too dark even if the brightness is set to 100 (Set the contrast to higher than 50.)
-

● To adjust color temperature

Color temperature can be adjusted.

The color temperature is normally used to express the hue of “White” and / or “Black” by a numerical value.

The value is expressed in degrees “K” (Kelvin).

The screen becomes reddish at a low color temperature, and bluish at a high color temperature, like the flame temperature. A gain preset value is set for each color temperature setting value.

Adjustable range

Off, 4000 K-10000 K (specified by every 500 K unit, including 9300 K)

Procedure

1. Choose “Color” in the Setting menu, and press ENTER.
2. Choose “Temperature” in the “Color” menu, and press ENTER.
The “Temperature” menu appears.
3. Use ▼ or ▲ for adjustment.
4. Press ENTER to exit.

Note

- The value shown in “K” is available only as reference.
 - “Gain” allows you to perform more advanced adjustment (see [“To adjust gain” \(page 24\)](#)).
 - If you set to “Off”, the image is displayed in the preset color of the monitor (Gain: 100 for each RGB).
 - When gain is changed, the color temperature is changed to “Off”.
-

● To adjust gamma

Gamma can be adjusted. The brightness of the monitor varies depending on the input signal, however, the variation rate is not proportional to the input signal. To keep the balance between the input signal and the brightness of the monitor is called as “Gamma correction”.

Adjustable range

1.8, 2.0, 2.2

Procedure

1. Choose “Color” in the Setting menu, and press ENTER.
2. Choose “Gamma” in the “Color” menu, and press ENTER.
The “Gamma” menu appears.
3. Use ▼ or ▲ for adjustment.
4. Press ENTER to exit.

Note

- If “Paper” is selected in the FineContrast mode, the gamma value is displayed for “Paper”. The setting “Paper” is specially meant to get the displayed image look like it is printed on paper.
-

● To adjust the color saturation

This function allows you to adjust color saturation.

Adjustable range

-50 to 50

Procedure

1. Choose “Color” in the Setting menu, and press ENTER.
2. Choose “Advanced Settings” in the “Color” menu, and press ENTER.
3. Choose “Saturation” in the “Advanced Settings” menu, and press ENTER.
The “Saturation” menu appears.
4. Use ▼ or ▲ for adjustment.
5. Press ENTER to exit.

Attention

- Using this function may make some color gradations unavailable for display.
-

Note

- The minimum value (-50) changes the screen to monochrome.
-

● To adjust hue

This function allows you to adjust hue.

Adjustable range

-50 to 50

Procedure

1. Choose “Color” in the Setting menu, and press ENTER.
2. Choose “Advanced Settings” in the “Color” menu, and press ENTER.
3. Choose “Hue” in the “Advanced Settings” menu, and press ENTER.
The “Hue” menu appears.
4. Use ▼ or ▲ for adjustment.
5. Press ENTER to exit.

Attention

- Using this function may make some color gradations unavailable for display.
-

● To set overdrive intensity (EV2336W / EV2436W only)

This function allows you to set overdrive intensity based on the use of the monitor. You can reduce Image lags by setting it to “Enhanced” when displaying animated images.

Adjustable range

Enhanced, Standard, Off

Procedure

1. Choose “Color” in the Setting menu, and press ENTER.
2. Choose “Advanced Settings” in the “Color” menu, and press ENTER.
3. Choose “Overdrive” in the “Advanced Settings” menu, and press ENTER.
The “Overdrive” menu appears.
4. Use ▼ or ▲ for adjustment.
5. Press ENTER to exit.

Attention

- The overdrive function is disabled in the following cases:
 - The vertical scan frequency of input signals is more than 60 Hz
 - Select “Normal” during “Screen Size” (excluding the case that display resolution is 1920 × 1080 (EV2336W) or 1920 × 1200 (EV2436W)).
-

● To adjust gain

The brightness of each color component red, green, and blue is called “Gain”. You can change the hue of “white” by adjusting gain.

Adjustable range

0 to 100

Procedure

1. Choose “Color” in the Setting menu, and press ENTER.
2. Choose “Advanced Settings” in the “Color” menu, and press ENTER.
3. Choose “Gain” in the “Advanced Settings” menu, and press ENTER.

The “Gain” menu appears.

4. Adjust gain with ▼ or ▲ for each of red, green, and blue.
5. Press ENTER to exit.

Attention

- Using this function may make some color gradations unavailable for display.

Note

- The value of gain changes with that of color temperature.
 - When gain is changed, the color temperature is changed to “Off”.
-

2-4. Screen Adjustment

● Digital Signal Input

When digital signals are input, images are displayed correctly based on the preset data of the monitor, but if characters and / or lines appear blurred, go to “[To modify blurred characters / lines](#)” (page 28).

When performing more advanced adjustment, see “[2-3. Adjusting Color](#)” (page 19) and subsequent pages.

● Analog Signal Input

Attention

- It takes about 30 minutes for the performance of electrical parts to stabilize. Please wait 30 minutes or more after the monitor power has been turned on, and then adjust the monitor.
 - The Self Adjust (automatic screen adjustment) function does not work for the images under the resolution of 800 × 600 (SVGA).
 - The self adjustment (or automatic screen adjustment) function works correctly when an image is fully displayed over the Windows or Macintosh display area. They do not work properly in the cases below:
 - When an image is displayed only on a part of the screen (command prompt window, for example)
 - When a black background (wallpaper, etc.) is in useAlso, these functions cannot work properly in some graphic boards.
-

The monitor screen adjustment is used to suppress flickering of the screen or adjust screen position and screen size correctly according to the PC to be used.

Note

- The Self Adjust function works when all of the following conditions are satisfied:
 - When a signal is input into the monitor for the first time or when a resolution or vertical / horizontal scan frequency not used before is set
-

If the screen is not displayed correctly even after performing the Self Adjust operation, adjust the screen according to the procedures on the following pages to use the monitor comfortably.

Setting Procedures

1. Perform the auto adjustment.

● To adjust flickering, screen position, and screen size automatically

Procedure

1. Choose “Screen” in the Setting menu, and press ENTER.
2. Choose “Analog Adjustment” in the “Screen” menu, and press ENTER.
3. Choose “Auto Screen Adjust” in the “Analog Adjustment” menu, and press ENTER.
4. Select “Yes” with ▼ or ▲, and press ENTER.

Flickering, screen position, and screen size are corrected by the auto-adjustment function.

If the screen is not displayed correctly even after performing the auto adjustment, perform adjustments according to the following procedure. If the screen is displayed correctly, go to “[5. Adjusting color gradation](#).” (page 28).

2. Prepare to use analog screen adjustment patterns.

Load the “EIZO LCD Utility Disk” to your PC, and then open the “Screen adjustment pattern files”.

Note

- For details and instructions on opening the “Screen adjustment pattern files”, refer to the Readme.txt file.

3. Perform the auto adjustment again with the analog screen adjustment pattern displayed.

● To adjust flickering, screen position, and screen size automatically

Procedure

1. Display Pattern 1 in full screen on the monitor using the “Screen adjustment pattern files”.

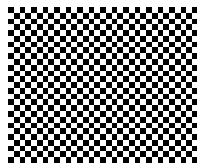

2. Choose “Screen” in the Setting menu, and press ENTER.
3. Choose “Analog Adjustment” in the “Screen” menu, and press ENTER.
4. Choose “Auto Screen Adjust” in the “Analog Adjustment” menu, and press ENTER.
5. Select “Yes” with ▼ or ▲, and press ENTER.

Flickering, screen position, and screen size are corrected by the auto-adjustment function.

If the screen is not displayed correctly even after performing the auto adjustment, perform adjustments according to the following procedure. If the screen is displayed correctly, go to [“5. Adjusting color gradation.”](#) (page 28).

4. Choose “Screen” from the Setting menu to perform advanced adjustments.

Adjust the clock, phase and position, in this order.

● To eliminate vertical bars

Procedure

1. Choose “Analog Adjustment” in the “Screen” menu, and press ENTER.
2. Choose “Clock” in the “Analog Adjustment” menu, and press ENTER.

The “Clock” menu appears.

3. Adjust the clock with ▼ or ▲ to eliminate vertical bars.

Press ▼ or ▲ slowly so as not to miss the adjustment point.

4. Press ENTER to exit.

When blurring, flickering or bars appear on the screen after adjustment, proceed to “To remove flickering or blurring”.

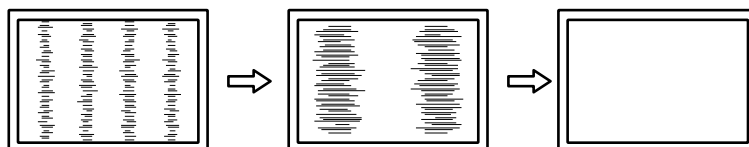

● To remove flickering or blurring

Procedure

1. Choose “Analog Adjustment” in the “Screen” menu, and press ENTER.
2. Choose “Phase” in the “Analog Adjustment” menu, and press ENTER.

The “Phase” menu appears.

3. Adjust the phase with ▼ or ▲ to minimize flickering or blurring.
4. Press ENTER to exit.

When vertical bars appear on the screen after adjustment, go back to “To eliminate vertical bars”.

(Clock → Phase → Position)

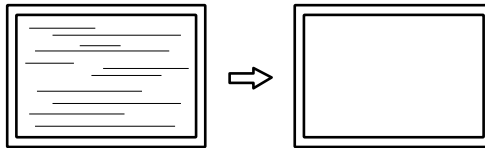

Attention

- Flickering or blurring may not be eliminated depending on your PC or graphics board.

● To correct the screen position

Note

- Since the number of pixels and the pixel positions are fixed on the LCD monitor, only one position is provided to display images correctly. The position adjustment is made to shift an image to the correct position.

Procedure

1. Choose “Analog Adjustment” in the “Screen” menu, and press ENTER.
2. Choose “Hor.Position” or “Ver.Position” from the “Analog Adjustment” menu, and press ENTER.

The “Hor. Position” or “Ver. Position” menu appears.

3. Adjust the position with ▼ or ▲.
4. Press ENTER to exit.

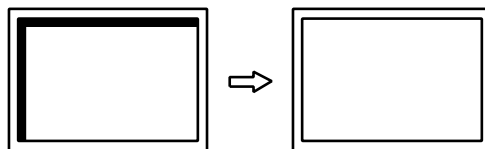

5. Close Pattern 1.

5. Adjusting color gradation.

● To adjust color gradation automatically

Every color gradation (0 to 255) can be displayed by adjusting the signal output level.

Procedure

1. Display Pattern 2 in full screen on the monitor using the “Screen adjustment pattern files”.

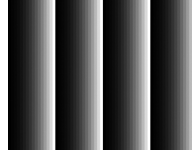

2. Choose “Screen” in the Setting menu, and press ENTER.
3. Choose “Analog Adjustment” in the “Screen” menu, and press ENTER.
4. Choose “Auto Range Adjust” in the “Analog Adjustment” menu, and press ENTER.
5. Select “Yes” with ▼ or ▲, and press ENTER.
The output range is set automatically.
6. Close Pattern 2.

6. Modify blurred characters or lines.

● To modify blurred characters / lines

When an image is displayed with a resolution other than recommended, the characters or lines of the displayed image may blur.

Attention

- Smoothing setting may not be required depending on the display resolution. (You cannot choose the smoothing icon.)
-

Adjustable range

1 to 5

Procedure

1. Choose “Screen” in the Setting menu, and press ENTER.
2. Choose “Smoothing” in the “Screen” menu, and press ENTER.
The “Smoothing” menu appears.
3. Use ▼ or ▲ for adjustment.
4. Press ENTER to exit.

2-5. Screen Size Changing

● Screen Size Changing

The image with the resolution other than the recommended resolution is displayed in full screen automatically. You can change the screen size by using the “Screen Size” function.

Setting	Function
Full Screen	Displays an image in full screen. Images are distorted in some cases because the vertical rate is not equal to the horizontal rate.
Enlarged	Displays an image in full screen. In some cases, a blank horizontal or vertical border appears to equalize the vertical rate and the horizontal rate.
Normal*1	Displays images with the specified resolution.

*1 EV2336W / EV2436W only

Example: Image size 1024 × 768

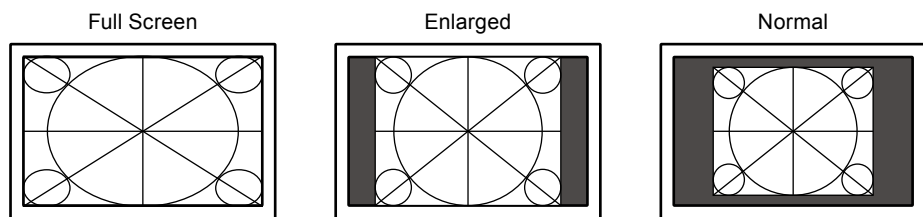

EV2316W :	(1920 × 1080)	(1440 × 1080)	(-)
EV2336W :	(1920 × 1080)	(1440 × 1080)	(1024 × 768)
EV2416W :	(1920 × 1200)	(1600 × 1200)	(-)
EV2436W :	(1920 × 1200)	(1600 × 1200)	(1024 × 768)

Procedure

1. Choose “Screen” in the Setting menu, and press ENTER.
2. Choose “Screen Size” in the “Screen” menu, and press ENTER.
The “Screen Size” menu appears.
3. Select “Full Screen”, “Enlarged”, or “Normal” with ▼ or ▲.
4. Press ENTER to exit.

Attention

- Selecting “Normal” may make some color gradations unavailable for display.
- When a 1280 × 720 resolution image is displayed on the EV2416W, the screen size is “Full Screen”.

● To adjust brightness of non-display area

A border (black area with no image) around the image appears in the “Normal” or “Enlarged” mode.

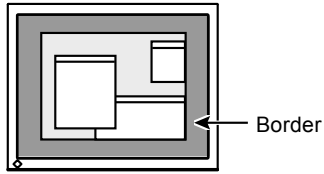

Procedure

1. Choose “Monitor Settings” in the Setting menu, and press ENTER.
2. Choose “Border Intensity” in the “Monitor Settings” menu, and press ENTER.
The “Border Intensity” menu appears.
3. Use ▼ or ▲ for adjustment.
4. Press ENTER to exit.

Chapter 3 Setting Monitor

3-1. Adjusting Volume

This function allows you to adjust the volume.

Adjustable range

0 to 30

Procedure

1. Press ▼/⏮).
2. Use ▼ or ▲ for adjustment.
3. Press ENTER to exit.

Note

- The volume for the speakers and the headphone can be set individually.
-

3-2. Selecting sound source while using the DisplayPort signal input

This function allows you to switch sound source during DisplayPort signal input. You can select the Stereo Mini Jack or DisplayPort.

Procedure

1. Choose “Sound” in the Setting menu, and press ENTER.
2. Choose “Source” in the “Sound” menu, and press ENTER.
The “Source” menu appears.
3. Select “Stereo Mini Jack” or “DisplayPort” with ▼ or ▲.
4. Press ENTER to exit.

Note

- This function is available with DisplayPort signal input.
-

3-3. Compensating viewing angle deficiency (EV2316W / EV2416W only)

When the screen is to be viewed from below, the viewing angle can be compensated for so the screen looks as if it is being seen from directly ahead.

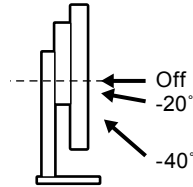

Adjustable range

-40°, -20°, Off

Procedure

1. Choose “Monitor Settings” in the Setting menu, and press ENTER.
2. Choose “Up View” in the “Monitor Settings” menu, and press ENTER.
The “Up View” menu appears.
3. Select “-40°”, “-20°”, or “Off” with ▼ or ▲.
4. Press ENTER to exit.

Attention

- The setting is turned “Off” in the following cases:
 - “Orientation” of the Setting menu is set to “Portrait”.
 - “sRGB” is selected from the FineContrast mode.
 - Depending on the viewing angle, switching the setting may make the screen less visible.
-

3-4. Enabling / Disabling DDC/CI communication

This function allows you to enable / disable the DDC/CI communication (see “6-9. Glossary” (page 65)).

Procedure

1. Choose “Monitor Settings” in the Setting menu, and press ENTER.
2. Choose “DDC/CI” in the “Monitor Settings” menu, and press ENTER.
The “DDC/CI” menu appears.
3. Select “On” or “Off” with ▼ or ▲.
4. Press ENTER to exit.

Note

- The DisplayPort input of this monitor does not support DDC/CI communication.
-

3-5. Locking Operation Buttons

This function allows you to lock the settings to prevent them being changed.

Procedure

1. Press **⏻** to turn off the monitor.
2. Hold down **SIGNAL** while pressing **⏻** to turn on the monitor.
The Lock / Unlock setting is toggled by performing the operation in step 2.

Note

- The following operations are available even if the buttons are locked:
 - Turning on or off the monitor with the Power button
-

3-6. Setting Orientation

This function allows you to change the orientation of the Setting menu when using the monitor screen in vertical display position.

Procedure

1. Choose “Monitor Settings” in the Setting menu, and press **ENTER**.
2. Choose “Menu Settings” in the “Monitor Settings” menu, and press **ENTER**.
3. Choose “Orientation” in the “Menu Settings” menu, and press **ENTER**.
The “Orientation” menu appears.
4. Select “Landscape” or “Portrait” with **▼** or **▲**.
5. Press **ENTER** to exit.
6. When selecting “Portrait”, turn the monitor screen 90° in clockwise direction.

Attention

- Be sure that the cables are correctly connected.
 - Be sure to turn the monitor screen after pulling up the screen to the uppermost position of the stand and setting the screen tilted upward.
-

Note

- For using the monitor with “Portrait” position, the graphics board supporting portrait display is required. When placing the monitor in a “Portrait” position, settings of your graphics board need to be changed. Refer to the User’s Manual of the graphics board for details.
-

3-7. Showing and hiding the EIZO logo

When the monitor is turned on, the EIZO logo appears on the screen. You can choose to show or hide the display of the EIZO logo.

Procedure

1. Choose “Monitor Settings” in the Setting menu, and press **ENTER**.
2. Choose “Menu Settings” in the “Monitor Settings” menu, and press **ENTER**.
3. Choose “Logo” in the “Menu Settings” menu, and press **ENTER**.
The “Logo” menu appears.
4. Select “On” or “Off” with **▼** or **▲**.
5. Press **ENTER** to exit.

3-8. Changing Setting Menu Display Position

You can change the display position of the Setting menu.

Procedure

1. Choose “Monitor Settings” in the Setting menu, and press ENTER.
2. Choose “Menu Settings” in the “Monitor Settings” menu, and press ENTER.
3. Choose “Menu Position” in the “Menu Settings” menu, and press ENTER.
The “Menu Position” menu appears.
4. Choose the position with ▼ or ▲.
5. Press ENTER to exit.

3-9. Setting Language

This function allows you to select a language for the Setting menu or messages.

Selectable languages

English, German, French, Spanish, Italian, Swedish, Japanese, Simplified Chinese, Traditional Chinese

Procedure

1. Choose “Monitor Settings” in the Setting menu, and press ENTER.
2. Choose “Language” in the “Monitor Settings” menu, and press ENTER.
The “Language” menu appears.
3. Choose a language with ▼ or ▲.
4. Press ENTER to exit.

3-10. Resetting the Monitor to the Default Settings

The setting values are reset to the default settings.

Attention

- After resetting, you cannot undo the operation.

Note

- Regarding the default setting, see [“Main Default Settings” \(page 60\)](#).
-

● To reset the color adjustments

This function only resets the color adjustments for the currently selected mode to the default settings.

Procedure

1. Choose “Color” in the Setting menu, and press ENTER.
2. Choose “Color Reset” in the “Color” menu, and press ENTER.
3. Select “Yes” with ▼ or ▲.
4. Press ENTER.

The color adjustments revert to the default settings.

● To reset “EcoView Sense Settings”

This function resets adjustments for “EcoView Sense Settings” to the default settings.

Procedure

1. Press .
2. Choose “EcoView Sense Settings” in the “EcoView Menu”, and press ENTER.
3. Choose “Reset” in the “EcoView Sense Settings”, and press ENTER.
4. Select “Yes” with ▼ or ▲.
5. Press ENTER.

The “EcoView Sense Settings” adjustments revert to the default settings.

Note

- “EcoView Sense Settings” can be changed and reset only when “EcoView Sense” is set to “On” (see [“4-4. Setting the power saving mode when a person leaves the monitor” \(page 38\)](#)).
-

● To reset all adjustments to the default settings

This function resets all adjustments to the default settings.

Procedure

1. Choose “Monitor Settings” in the Setting menu, and press ENTER.
2. Choose “Reset” in the “Monitor Settings” menu, and press ENTER.
3. Select “Yes” with ▼ or ▲.
4. Press ENTER.

All adjustments revert to the default settings.

Chapter 4 Power Saving Functions

4-1. Setting Power Saving

● Monitor

This function allows you to set the monitor into the power saving mode according to the PC status. When the monitor has shifted to the power saving mode, the images on the screen are not displayed.

Attention

- Turning off the main power switch or unplugging the power cord completely shuts off power supply to the monitor.
- When the monitor is in power saving mode, devices connected to the USB downstream port will still work. Therefore, power consumption of the monitor varies with connected devices even in the power saving mode.
- Power consumption varies even when the stereo mini jack cable is connected.

Note

- The monitor changes to the power saving mode about 15 seconds after the signal input ceases to be detected.

Procedure

1. Choose “PowerManager” in the Setting menu, and press ENTER.
2. Choose “Power Save” in the “PowerManager” menu, and press ENTER.
The “Power Save” menu appears.
3. Select “On” or “Off” with ▼ or ▲.
4. Press ENTER to exit.

Power Saving System

Analog Signal Input

This monitor complies with the VESA DPM standard.

PC		Monitor	Power Indicator
On		Operating	Blue
Power saving mode	STAND-BY SUSPENDED OFF	Power saving mode	Orange
Power Off		Power saving mode	Orange

Digital Signal Input

- DVI
This monitor complies with the DVI DMPM standard.
- DisplayPort
This monitor complies with the DisplayPort Standard V1.1a.

PC		Monitor	Power Indicator
On		Operating	Blue
Power saving mode		Power saving mode	Orange
Power Off		Power saving mode	Orange

Exiting the power saving mode

If the monitor receives input, it automatically exits the power saving mode and returns to the normal display mode.

● Audio Output

This monitor allows you to turn off the audio output from the speakers / headphone at the power saving mode.

Procedure

1. Choose “Sound” in the Setting menu, and press ENTER.
2. Choose “Power Save” in the “Sound” menu, and press ENTER.
The “Power Save” menu appears.
3. Select “Sound On” or “Sound Off” with ▼ or ▲.
4. Press ENTER to exit.

4-2. Setting Power Indicator

This function allows you to set the power indicator (blue) ON / OFF in the monitor ON condition.

Procedure

1. Choose “Monitor Settings” in the Setting menu, and press ENTER.
2. Choose “Power Indicator” in the “Monitor Settings” menu, and press ENTER.
The “Power Indicator” menu appears.
3. Select “On” or “Off” with ▼ or ▲.
4. Press ENTER to exit.

4-3. Enabling / Disabling Automatic Brightness Adjustment

● Auto EcoView

The ambient light sensor on the front side of the monitor detects the environmental brightness to adjust the screen brightness automatically and comfortably by using the Auto EcoView function.

Attention

- Be careful not to block the ambient light sensor on the lower side of the monitor when using the Auto EcoView function.
-

Procedure

1. Press .
2. Choose “Auto EcoView” in the “EcoView Menu” menu, and press ENTER.
The “Auto EcoView” menu appears.
3. Select “High”, “Standard”, or “Off” with ▼ or ▲.
4. Press ENTER to exit.

Note

- As “Brightness” in the Setting menu is changed, the auto adjustment range for Auto EcoView is also changed.
 - Set to “High” if you feel a little brighter with “Standard” setting status.
-

● EcoView Optimizer 2

Using the EcoView Optimizer 2 function automatically adjusts the screen brightness according to the white level of the input signal. This function can reduce the power consumption while maintaining the brightness specified by the input signal.

Procedure

1. Press .
2. Choose “EcoView Optimizer 2” in the “EcoView Menu” menu, and press ENTER.
The “EcoView Optimizer 2” menu appears.
3. Select “On” or “Off” with ▼ or ▲.
4. Press ENTER to exit.

Note

- When “Movie” is selected from the FineContrast mode, the setting is turned “Off”.
 - When the EcoView Optimizer 2 function is “On”, the appearance of pale color may change. If that bothers you, set this function to “Off”.
-

4-4. Setting the power saving mode when a person leaves the monitor

The sensor on the front side of the monitor detects the movement of a person by using the EcoView Sense function. When a person moves away from the monitor, it shifts to the power saving mode automatically and does not display the images on the screen to reduce the power consumption. When a person comes near the monitor again, it recovers from the power saving mode and displays the images. The sensitivity and time until the power saving mode is activated can be set according to the monitor usage environment and movement of the user.

Note

- At the time of shifting to power saving mode, the message that indicates shifting is displayed.
-

Procedure

1. Press .

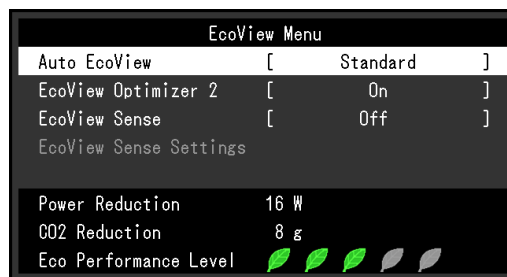

2. Choose “EcoView Sense” in the “EcoView Menu”, and press ENTER.
The “EcoView Sense” menu appears.
3. Select “On” or “Off” with ▼ or ▲.
4. Press ENTER to exit.

5. When “On” is selected, select “EcoView Sense Settings” for setting the details.

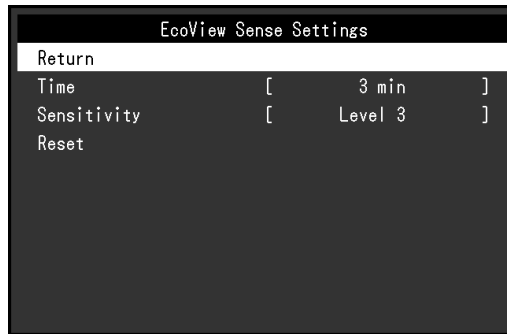

Item	Setting Range	Description
Time	5, 30 sec 1, 3, 5, 10, 15, 30, 45, 60 min	Specifies the time from when a person leaves the monitor until the “No Presence detected” message appears. The monitor shifts to the power saving mode about 20 seconds after the message is displayed.
Sensitivity	Level 5 Level 4 Level 3 Level 2 Level 1	When the setting level is high (“Level 5” at maximum), even minor movements of a person are detected, causing the monitor to shift to the power saving mode only infrequently. On the other hand, when the setting level is low (“Level 1” at minimum), only major movements of a person are detected, allowing the monitor to shift to the power saving mode frequently. EcoView Sense is activated when the sensor on the front side of the monitor detects the movement of heat. Therefore, the sensitivity should be changed depending on the typical user’s clothes or the typical room temperature. If the monitor shifts to or recovers from the power saving mode contrary to your expectations, try changing the setting level.
Reset	-	This function resets all adjustments to the default settings.

Note

- When the monitor is used in the “Portrait” direction, the detection sensitivity is lower than the “Landscape” direction. Try increasing the sensitivity setting value when switching the mode to the power saving mode.
- To use the monitor comfortably, increase the sensitivity for high temperatures, which reduces the detection sensitivity, and reduce the sensitivity for low temperatures, which increases the detection sensitivity.

4-5. Checking the power saving level

The EcoView menu allows you to check Power Reduction, CO₂ Reduction, and Eco Performance Level. The more indicators light up representing the Eco Performance Level, the higher the power saving level attained.

Example: EV2436W

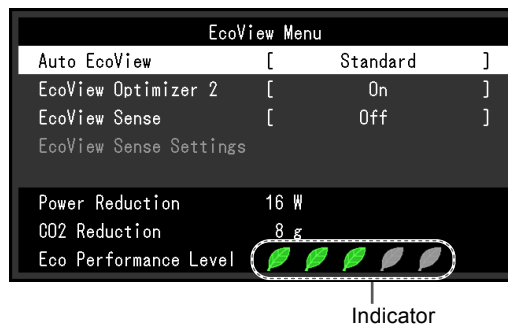

Procedure

1. Press .

The “EcoView Menu” menu appears.

Note

- Power reduction: the backlight’s reduction of power consumption as a result of the adjusted brightness value.
CO₂ reduction: converted from the “Power reduction” value, this is an estimate of the quantity of CO₂ emissions reduced when using the monitor for 1 hour.
* The numeric value is a result of a calculation based on a default setting (0.000555 t -CO₂/kWh) determined by a Japanese ministerial ordinance (2006, Ministry of Economy, Trade and Industry, Ministry of Environment, civil code article 3) and may differ depending on country and year.

4-6. Enabling / Disabling Auto Power-OFF

This function allows you to switch the setting to turn off the monitor automatically after a specified time has passed in the power saving mode.

Adjustable range

Off, 0, 1, 2, 3, 5, 10, 15, 20, 25, 30, 45 min, 1, 2, 3, 4, 5 h





Procedure

1. Choose “PowerManager” in the Setting menu, and press ENTER.
2. Choose “Eco Timer” in the “PowerManager”, and press ENTER.
3. Select “Off” or time to turn off the monitor with ▼ or ▲.
4. Press ENTER to exit.

Chapter 5 Troubleshooting

If a problem still remains after applying the suggested remedies, contact your local EIZO representative.

5-1. No picture



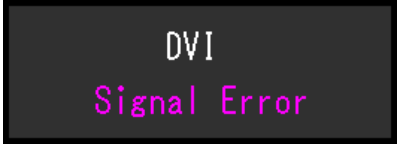









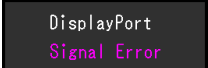

Problem	Possible cause and remedy
<p>1. No picture</p> <ul style="list-style-type: none"> Power indicator does not light. 	<ul style="list-style-type: none"> Check whether the power cord is connected properly. Turn the main power switch on. Press . Turn off the main power, and then turn it on again a few minutes later.
<ul style="list-style-type: none"> Power indicator is lighting blue. 	<ul style="list-style-type: none"> Increase "Brightness", "Contrast", or "Gain" in the Setting menu (see "To perform advanced adjustments" (page 20)).
<ul style="list-style-type: none"> Power indicator is lighting orange. 	<ul style="list-style-type: none"> Switch the input signal with SIGNAL. Move the mouse or press any key on the keyboard. Check whether the PC is turned on. When the EcoView Sense function is "On", the monitor may have shifted to the power saving mode. Come near to the monitor. If the screen is not displayed, move the mouse or press any key on the keyboard. Depending on the PC and graphics board, the input signal is not detected and the monitor does not recover from the power saving mode. If the screen is not displayed even after moving the mouse or pressing any key on the keyboard, turn the monitor off and on using its power button. When the screen is displayed, execute the following procedure. The problem may be improved. <ol style="list-style-type: none"> Press  to turn off the monitor. Hold down  while pressing  to turn on the monitor. <p>"x" is displayed on the menu title of "Information" of the Setting menu (see "6-6. Displaying Monitor Information" (page 53)).</p> <ol style="list-style-type: none"> Reboot the PC. <p>To return to the previous setting, perform steps 1 to 3 again.</p> <div data-bbox="884 1462 1310 1742" data-label="Image"> <pre> Information (DVI) x FlexScan EV2436W S/N: 00000001 Usage Time (h) 0 Input Signal 1920x1200 fH: 74.0kHz fV: 60.0 Hz fD: 154.0MHz </pre> </div>
<ul style="list-style-type: none"> Power indicator is flashing orange. 	<ul style="list-style-type: none"> The device that is connected using DisplayPort has a problem. Solve the problem, turn off the monitor, and then turn it on again. Refer to the User's Manual of the output device for further details.

Problem	Possible cause and remedy
<p>2. The message below appears.</p> <ul style="list-style-type: none"> The message shows that the input signal is out of the specified frequency range. Example: 	<p>This message appears when the signal is not input correctly even when the monitor functions properly.</p> <ul style="list-style-type: none"> Check whether the PC is configured to meet the resolution and vertical scan frequency requirements of the monitor (see “2-1. Compatible Resolutions” (page 14)). Reboot the PC. Select an appropriate setting using the graphics board’s utility. Refer to the User’s Manual of the graphics board for details.

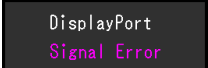

5-2. Imaging problems (for both digital and analog)

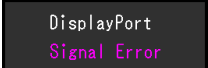
Problem	Possible cause and remedy
<p>1. The screen is too bright or too dark.</p>	<ul style="list-style-type: none"> Use “Brightness” or “Contrast” in the Setting menu to adjust it. (The LCD monitor backlight has a limited life span. When the screen becomes dark or begins to flicker, contact your local EIZO representative.) If the screen is too bright, turn on Auto EcoView. The monitor detects the environmental brightness to adjust the screen brightness automatically.
<p>2. Characters are blurred.</p>	<ul style="list-style-type: none"> Check whether the PC is configured to meet the resolution and vertical scan frequency requirements of the monitor (see “2-1. Compatible Resolutions” (page 14)). When an image is displayed with a resolution other than recommended, the characters or lines of the displayed image may blur. Use “Smoothing” and “Screen Size” in the Setting menu to adjust the display (see “To modify blurred characters / lines” (page 28), and “Screen Size Changing” (page 29)).
<p>3. Afterimages appear.</p>	<ul style="list-style-type: none"> Afterimages are particular to LCD monitors. Avoid displaying the same image for a long time. Use the screen saver or power save function to avoid displaying the same image for extended periods of time.
<p>4. Green / red / blue / white dots or defective dots remain on the screen.</p>	<ul style="list-style-type: none"> This is due to LCD panel characteristics and is not a failure.
<p>5. Interference patterns or pressure marks remain on the screen.</p>	<ul style="list-style-type: none"> Leave the monitor with a white or black screen. The symptom may disappear.
<p>6. Noise appears on the screen.</p>	<ul style="list-style-type: none"> In the Setting menu, set “Overdrive” to “Off” (see “To set overdrive intensity (EV2336W / EV2436W only)” (page 23)). When entering the HDCP signals, the normal images may not be displayed immediately.

5-3. Imaging problems (for digital only)

Problem	Possible cause and remedy									
<p>1. The monitor configuration is changed to single under the multiple monitor configuration (when DisplayPort is connected).</p>	<ul style="list-style-type: none"> When two monitors are connected to one PC using DisplayPort, and the power to one of the monitors is turned off with the power button, the screen setting may be changed to the single monitor configuration. In such a case, enable the “DP HotPlug” function with the following procedures. Enabling this function may increase the power consumption. <ol style="list-style-type: none"> Press  to turn off the monitor. Hold down  while pressing  to turn on the monitor. Each time the operation enables / disables this function alternatively. <p>The current setting status can be identified based on the color used to display the input port or signal error.</p> <table border="1" data-bbox="798 734 1398 967"> <thead> <tr> <th>Setting</th> <th>Input port</th> <th>Signal Error</th> </tr> </thead> <tbody> <tr> <td>Disable (default setting)</td> <td></td> <td></td> </tr> <tr> <td>Enable</td> <td></td> <td></td> </tr> </tbody> </table> 	Setting	Input port	Signal Error	Disable (default setting)			Enable		
Setting	Input port	Signal Error								
Disable (default setting)										
Enable										

5-4. Imaging problems (for analog only)

Problem	Possible cause and remedy
<p>1. Display position is incorrect.</p> 	<ul style="list-style-type: none"> Use “Position” in the Setting menu to correct the image position (see “To correct the screen position” (page 27)). If the problem persists, use the graphics board’s utility if available to change the display position.
<p>2. Vertical bars appear on the screen or a part of the image is flickering.</p> 	<ul style="list-style-type: none"> Use “Clock” in the Setting menu to adjust it (see “To eliminate vertical bars” (page 26)).
<p>3. Whole screen is flickering or blurring.</p> 	<ul style="list-style-type: none"> Use “Phase” in the Setting menu to adjust it (see “To remove flickering or blurring” (page 27)).

5-5. Other problems

Problem	Possible cause and remedy
1. The Setting menu does not appear.	<ul style="list-style-type: none"> • Check whether the operation lock function is active (see “3-5. Locking Operation Buttons” (page 33)).
2. The “Smoothing” on the Setting menu “Screen” cannot be selected.	<ul style="list-style-type: none"> • You cannot choose “smoothing” when the screen is displayed in the following resolutions or settings. <ul style="list-style-type: none"> - The resolution is 1920 × 1080 (EV2316W / EV2336W) - The resolution is 1920 × 1200 (EV2416W / EV2436W) - Screen Size is “Normal” (EV2336W / EV2436W only)
3. The auto adjustment function does not work.	<ul style="list-style-type: none"> • This function does not work during digital signal input. • This function is intended for use on the Macintosh and on AT-compatible PC running Windows. It does not work properly when an image is displayed only on a part of the screen (command prompt window, for example) or when a black background (wallpaper, etc.) is in use. • This function does not work correctly with some graphics boards.
4. No audio output.	<ul style="list-style-type: none"> • Check whether the stereo mini jack cable is connected properly. • Check whether volume is set to 0. • Check the setting of the PC and the audio playback software. • During DisplayPort signal input, check the “Source” setting (see “3-2. Selecting sound source while using the DisplayPort signal input” (page 31)).
5. (When using EcoView Sense) The images remain to be displayed when you move away from the monitor. / The images do not reappear when you come near it.	<ul style="list-style-type: none"> • Check the setting environment of the monitor. Presence Sensor may not work correctly in the following environments. <ul style="list-style-type: none"> - The monitor is located in a place affected by wind. - There is some heat emitting device near the monitor. - There is some obstacle in front of the sensor. • Check whether any dirt on the sensor. Clean the sensor with a soft cloth. • Check whether you are in front of the monitor. The EcoView Sense function is activated when the sensor on the front side of the monitor detects the movement of heat. • In the high temperature conditions, the monitor may not recover from the power saving mode. If the screen is not displayed even after moving the mouse or pressing any key on the keyboard, turn the monitor off and on using its power button. When the screen is displayed, increase the detection sensitivity value (see “4-4. Setting the power saving mode when a person leaves the monitor” (page 38)).

Problem	Possible cause and remedy
<p>6. USB devices connected to the monitor do not work.</p>	<ul style="list-style-type: none"> • Check whether the USB cable is connected correctly (see “6-5. Making Use of USB (Universal Serial Bus)” (page 52)). • Change the USB port to another one. If the PC or peripheral devices works correctly by changing the USB port, contact your local EIZO representative. (Refer to the manual of the PC for details.) • Reboot the PC. • If the peripheral devices work correctly when the PC and peripheral devices are connected directly, please contact your local EIZO representative. • Check whether the PC and OS are USB compliant. (For USB compliance of the respective devices, consult their manufacturers.) • Check the PC’s BIOS setting for USB when using Windows. (Refer to the manual of the PC for details.)

Chapter 6 Reference

6-1. Attaching the Optional Arm

An optional arm (or an optional stand) can be attached by removing the stand section. Please refer to our web site for the corresponding optional arm (or optional stand). <http://www.eizo.com>

Attention

- When attaching an arm or stand, follow the instructions of their User's Manual.
- When using another manufacturer's arm or stand, confirm the following in advance and select one conforming to the VESA standard.
 - Clearance between the screw holes: 100 mm × 100 mm
 - Thickness of plate: 2.6 mm
 - Strong enough to support weight of the monitor unit (except the stand) and attachments such as cables.
- When using another manufacturer's arm or stand, use the screws as described below.
 - FlexStand2: Screws fixing the stand to the monitor
 - TriStand2: Screws supplied with this product (M4 × 12 mm)
- When using an arm or stand, attach it to meet the following tilt angles of the monitor.
 - Up 45°, down 45° (horizontal display, and vertical display rotated 90 degrees clockwise)
- Connect the cables after attaching an arm or stand.
- Do not move the removed stand up and down. Doing so may result in injury or device damage.
- The monitor and arm or stand are heavy. Dropping them may result in injury or equipment damage.
- When setting the monitor to the portrait style, turn the monitor screen 90° in clockwise direction.

Procedure

1. Lay the LCD monitor on a soft cloth spread over on a stable surface with the panel surface facing down.

2. Remove the stand.

Using a screwdriver, loosen the screws securing the unit and the stand (FlexStand2: four positions, TriStand2: three positions).

3. Attach the arm or stand to the monitor.

Secure the monitor to the arm or stand using the screws specified in the User's Manual of the arm or stand.

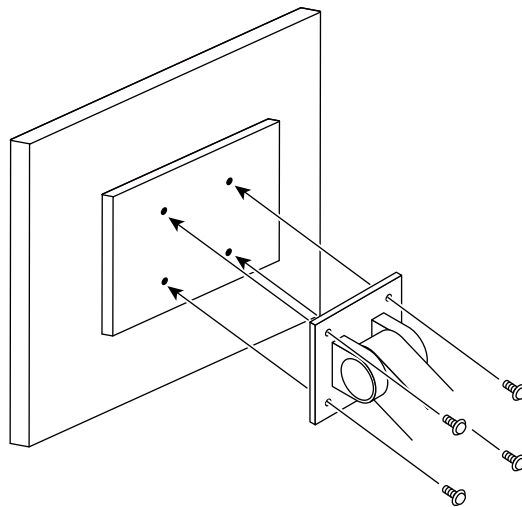

6-2. Detaching / Attaching the TriStand2 Stand Base

Note

- There are 2 types of shapes for the stand brace and the base mounting section (refer to the figures in the procedure). Check the shape of the monitor you have purchased.

Detaching procedure

The Stand base that was attached during setup can be detached using the following procedures.

- 1. Lay the LCD monitor on a soft cloth spread over on a stable surface with the panel surface facing down.**
- 2. Turn the fixing screw for the Stand base in the “RELEASE” direction to detach the base.**

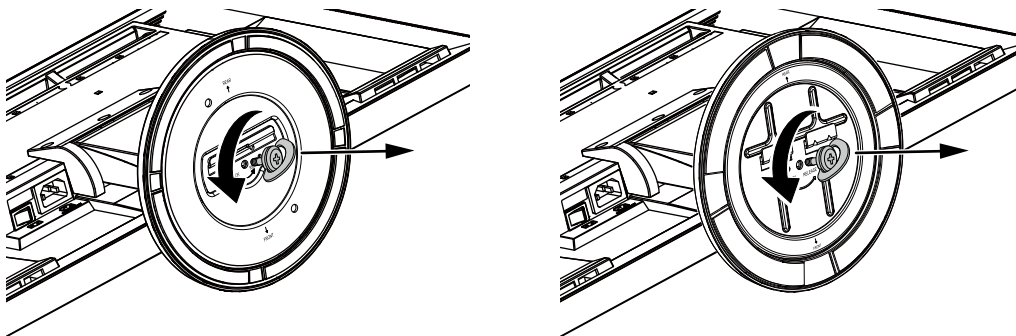

- 3. Remove the Stand base while lifting it up.**

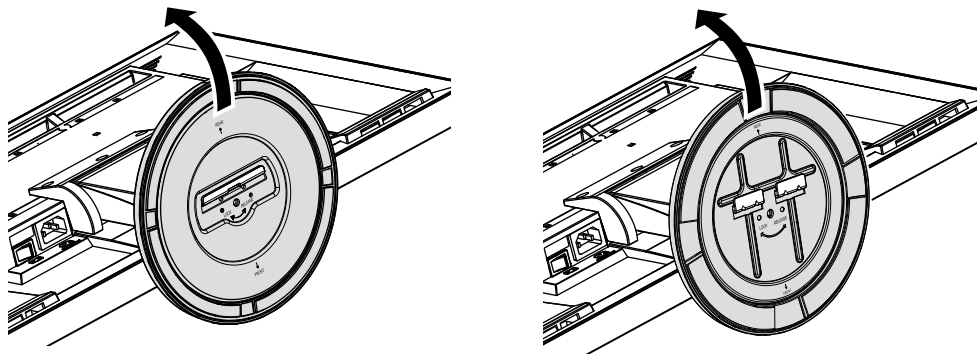

Attaching procedure

The once removed the Stand base can be attached to the monitor again with the following procedures.

- 1. Lay the LCD monitor on a soft cloth spread over on a stable surface with the panel surface facing down.**
- 2. Hold the Stand base with the “REAR” side facing upward, align the hole (a) of the Stand base with the tab (b) at the bottom of the monitor, and snap the tab into the hole.**

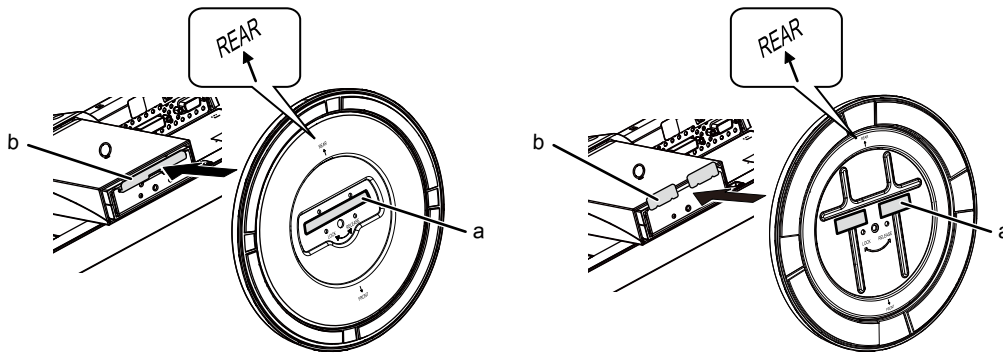

- 3. Turn the supplied screw in the “LOCK” direction to lock the Stand base.**

Tighten the screw firmly to the end.

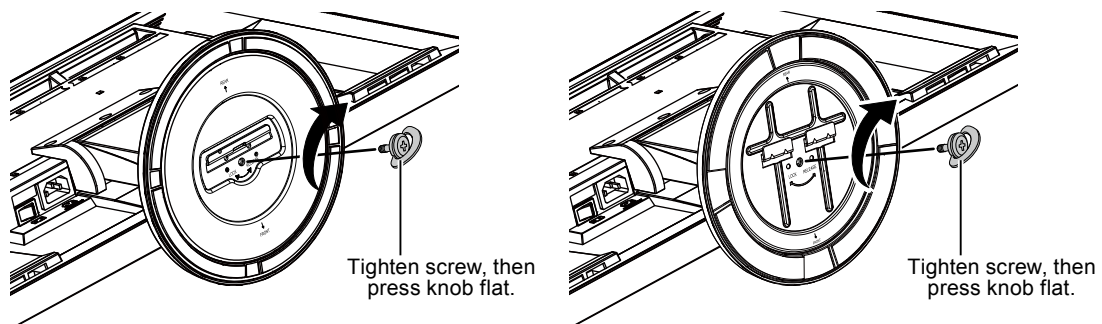

- 4. Place the monitor on a stable surface.**

6-3. Attaching / Detaching the TriStand2 Cable Holder

When you want to use the cable holder with TriStand2, follow the procedure below. The holder can also be removed.

Note

- FlexStand2 is a set comprised of the stand and the cable holder.
-

Attaching procedure

1. Pass the cables through the cable holder.

2. Shut the bottom of the cable holder.

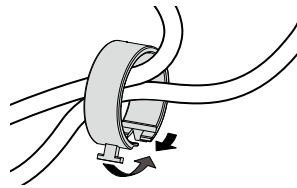

3. While holding the shut section, insert the cable holder into the Stand base.

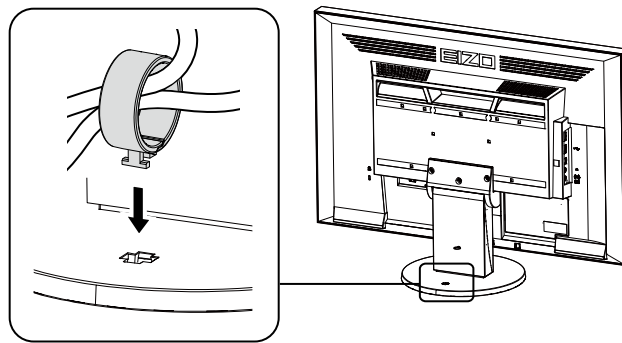

Note

- The cable holder can be inserted either perpendicular or parallel to the base. Change the direction of the cable holder according to the conditions of the cables.

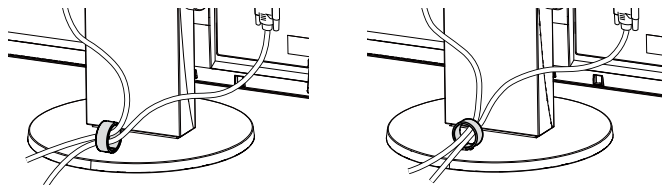

Detaching procedure

- 1. Shut the bottom of the cable holder.**
- 2. While holding the shut section, lift the cable holder upward to remove it from the Stand base.**

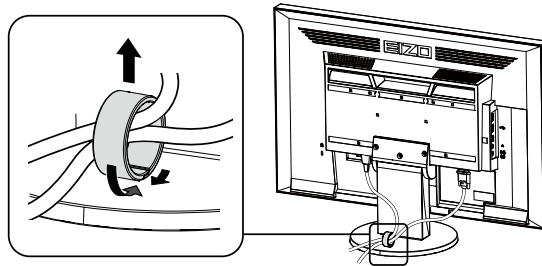

6-4. Connecting Multiple PCs

The product has multiple connections to PCs and allows you to switch to one of the connections for display.

Connection examples

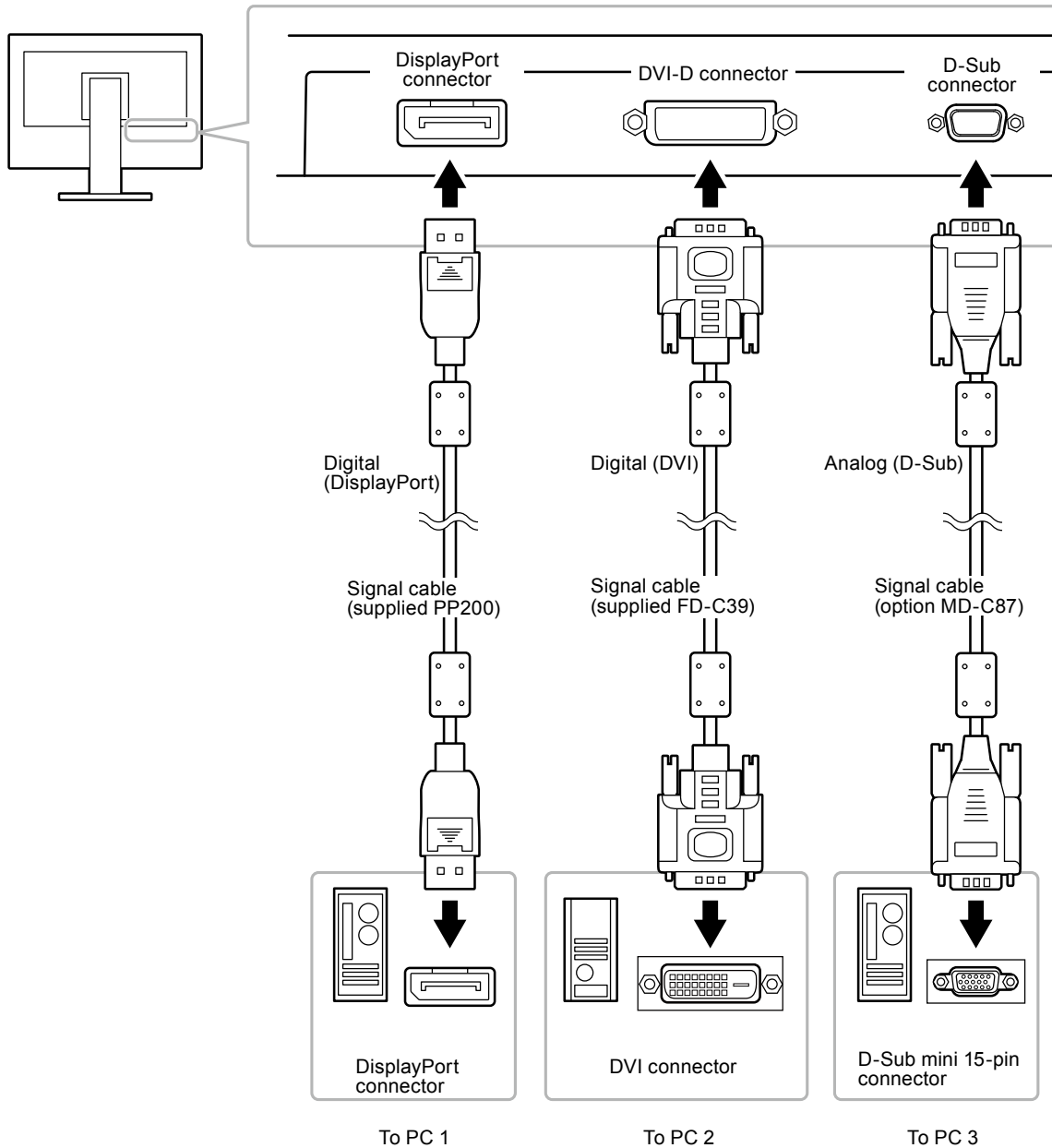

● To switch among input signals

The input signal switches each time SIGNAL is pressed.

When the signal is switched, the active input port name appears at the top right corner of the screen.

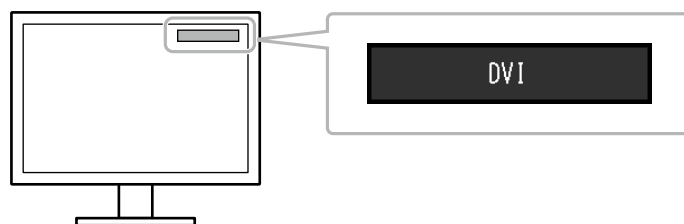

● To set input signal selection

Setting	Function
Auto	The monitor recognizes the connector through which PC signals are input. When a PC is turned off or enters the power saving mode, the monitor automatically displays another signal.
Manual	The monitor displays the signal from the selected connector despite the signal input. Select the input signal for display using the SIGNAL operation button.

Procedure

1. Choose “Monitor Settings” from the Adjustment menu, and press ENTER.
2. Choose “Input Signal” from “Monitor Settings”, and press ENTER.
3. Select “Auto” or “Manual” with ▼ or ▲.
4. Press ENTER to exit.

Note

- If you select “Auto”, the monitor enters the power saving mode after all the PCs have entered the power saving mode or have been switched off.
-

6-5. Making Use of USB (Universal Serial Bus)

This monitor has a USB hub. It works as a USB hub when connected to a USB-compatible PC, allowing the connection of peripheral USB devices.

● Required System Environment

- A PC equipped with a USB port
- Windows 2000 / XP / Vista / 7 / 8 or Mac OS 9.2.2 and Mac OS X 10.2 or later
- USB cable (commercially available product)

Attention

- This monitor may not work depending on PC, OS or peripheral devices to be used. For USB compatibility of peripheral devices, contact their manufacturers.
 - When the monitor is in power saving mode, devices connected to the USB downstream port will still work. Therefore, power consumption of the monitor varies with connected devices even in the power saving mode.
 - When the main power of the monitor is Off, a device connected to the USB downstream port will not operate.
-

● Connection Procedure (Setup of USB Function)

1. Connect the monitor first to a PC using the signal cable, and run the PC.
2. Connect the USB cable between the USB downstream port of the PC and the USB upstream port of the monitor.

The USB hub function is set up automatically upon connection of the USB cable.

3. Connect the peripheral USB devices to the USB downstream port of the monitor.

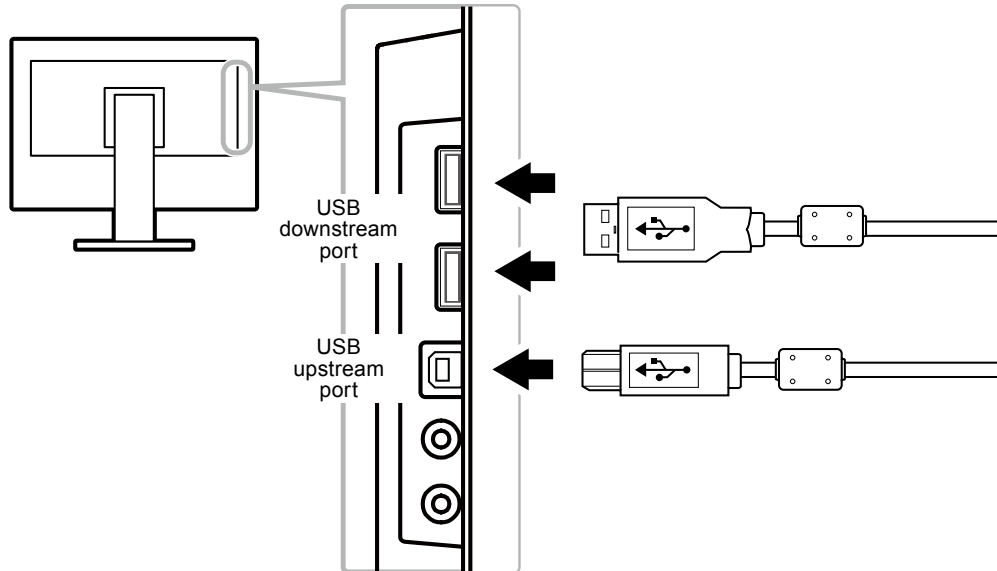

6-6. Displaying Monitor Information

This function allows you to display the model name, serial number, usage time, resolution, and input signal.

Procedure

1. Choose “Information” in the Setting menu, and press ENTER.
The “Information” menu appears.

Attention

- When you turn on the monitor for the first time, the usage time may be more than 0 due to a factory inspection.

6-7. Specifications

● EV2316W

LCD Panel	Size		23.0-inch (580 mm)
	Type		TFT color LCD, LED backlight
	Surface treatment		Anti-Glare Hard Coating
	Viewing angles		Horizontal 170°, vertical 160° (CR≥10)
	Dot Pitch		0.2655 mm
	Response Time		Black-white-black: Approx. 5 ms
Horizontal Scan Frequency	Analog		31 - 68 kHz
	Digital	DVI	31 - 68 kHz
		DisplayPort	31 - 68 kHz
Vertical Scan Frequency	Analog		55 - 61 Hz (non-interlace)
	Digital	DVI	59 - 61 Hz (non-interlace)
		DisplayPort	59 - 61 Hz (non-interlace)
Resolution			1920 Dots × 1080 Lines
Max. Dot Clock	Analog		148.5 MHz
	Digital	DVI	148.5 MHz
		DisplayPort	148.5 MHz
Max. Display Color			Approx. 16.77 million colors
Display Area (H × V)			509.7 mm (20.1 inch) × 286.7 mm (11.3 inch)
Power Supply			100 - 120 VAC ±10 %, 50 / 60 Hz 0.75 A 200 - 240 VAC ±10 %, 50 / 60 Hz 0.45 A
Power Consumption	Screen Display On		43 W or less
	Power saving mode		0.3 W or less (with no USB connections, "EcoView Sense": "Off", and "Sound" - "Power Save": "Sound Off")
	Power Off		0.3 W or less
	Main Power Off		0 W
Input Signal Connector			D-Sub mini 15-pin DVI-D connector (Applicable to HDCP) DisplayPort (Standard V1.1a, applicable to HDCP) Applicable Format (Audio signal) - 2ch linear PCM (32 kHz / 44.1 kHz / 48 kHz / 88.2 kHz / 96 kHz)
Analog Input Signal (Sync)			Separate, TTL, positive / negative
Analog Input Signal (Video)			Analog, Positive (0.7 Vp-p / 75 Ω)
Digital Signal (DVI) Transmission System			TMDS (Single Link)
Audio Output			Speaker output: 1.0 W + 1.0 W (8 Ω, THD+N: 10 % or less) Headphone output: 2 mW + 2 mW (32 Ω, THD+N: 3 % or less)
Line Input			Input impedance: 44 kΩ (typ.) Input level: 2.0 Vrms (Max.)
Plug & Play			Analog / Digital (DVI-D) : VESA DDC 2B / EDID structure 1.3 Digital (DisplayPort) : VESA DisplayPort / EDID structure 1.4
Dimensions (Width) × (Height) × (Depth)	Main unit (FlexStand2)		540 mm (21.3 inch) × 360 - 513.5 mm (14.2 inch - 20.2 inch) × 245.5 mm (9.7 inch)
	Main unit (TriStand2)		540 mm (21.3 inch) × 387.5 - 447.5 mm (15.3 inch - 17.6 inch) × 200 mm (7.9 inch)
	Main unit (without stand)		540 mm (21.3 inch) × 317.5 mm (12.5 inch) × 56 mm (2.2 inch)

Mass	Main unit (FlexStand2)	Approx. 5.7 kg (12.6 lbs.)
	Main unit (TriStand2)	Approx. 4.3 kg (9.5 lbs.)
	Main unit (without stand)	Approx. 3.1 kg (6.8 lbs.)
Movable range	FlexStand2	Tilt: 30° Up, 0° Down
		Swivel: 172° Right, 172° Left
		Adjustable height: 195 mm (7.7 inch) (179 mm (7.0 inch) for tilt of 0°)
		Rotation: 90° (Clockwise)
	TriStand2	Tilt: 25° Up, 0° Down
		Swivel: 172° Right, 172° Left
Adjustable height: 60 mm (2.36 inch)		
Environmental Conditions	Temperature	Operating: 5°C to 35°C (41°F to 95°F)
		Transportation/Storage: -20°C to 60°C (-4°F to 140°F)
	Humidity	Operating: 20 % to 80 % R.H. (no condensation)
		Transportation/Storage: 10 % to 90 % R.H. (no condensation)
	Air Pressure	Operating: 700 to 1,060 hPa
		Transportation/Storage: 200 to 1,060 hPa
USB	Standard	USB Specification Revision 2.0
	Port	Upstream port × 1, Downstream port × 2
	Communication Speed	480 Mbps (high), 12 Mbps (full), 1.5 Mbps (low)
	Supply current	Downstream: Max. 500mA/1 port

● EV2336W

LCD Panel	Size	23.0-inch (580 mm)	
	Type	TFT color LCD, LED backlight	
	Surface treatment	Anti-Glare Hard Coating	
	Viewing angles	Horizontal 178°, vertical 178° (CR≥10)	
	Dot Pitch	0.2652 mm	
	Response Time	Black-white-black: Approx. 16 ms Gray-to-gray: Approx. 6 ms (Overdrive setting: Enhanced)	
Horizontal Scan Frequency	Analog	31 - 81 kHz	
	Digital	DVI	31 - 68 kHz
		DisplayPort	31 - 68 kHz
Vertical Scan Frequency	Analog	55 - 76 Hz (non-interlace)	
	Digital	DVI	59 - 61 Hz (non-interlace) (VGA TEXT: 69 - 71 Hz)
		DisplayPort	59 - 61 Hz (non-interlace) (VGA TEXT: 69 - 71 Hz)
Resolution	1920 Dots × 1080 Lines		
Max. Dot Clock	Analog	148.5 MHz	
	Digital	DVI	148.5 MHz
		DisplayPort	148.5 MHz
Max. Display Color	Approx. 16.77 million colors		
Display Area (H × V)	509.1 mm (20 inch) × 286.4 mm (11.3 inch)		
Power Supply	100 - 120 VAC ±10 %, 50 / 60 Hz 0.8 A 200 - 240 VAC ±10 %, 50 / 60 Hz 0.5 A		

Power Consumption	Screen Display On	40 W or less
	Power saving mode	0.3 W or less (with no USB connections, "EcoView Sense": "Off", and "Sound" - "Power Save": "Sound Off")
	Power Off	0.3 W or less
	Main Power Off	0 W
Input Signal Connector		D-Sub mini 15-pin DVI-D connector (Applicable to HDCP) DisplayPort (Standard V1.1a, applicable to HDCP) Applicable Format (Audio signal) - 2ch linear PCM (32 kHz / 44.1 kHz / 48 kHz / 88.2 kHz / 96 kHz)
Analog Input Signal (Sync)		Separate, TTL, positive / negative
Analog Input Signal (Video)		Analog, Positive (0.7 Vp-p / 75 Ω)
Digital Signal (DVI) Transmission System		TMDS (Single Link)
Audio Output		Speaker output: 1.0 W + 1.0 W (8 Ω, THD+N: 10 % or less) Headphone output: 2 mW + 2 mW (32 Ω, THD+N: 3 % or less)
Line Input		Input impedance: 44 kΩ (typ.) Input level: 2.0 Vrms (Max.)
Plug & Play		Analog / Digital (DVI-D) : VESA DDC 2B / EDID structure 1.3 Digital (DisplayPort) : VESA DisplayPort / EDID structure 1.4
Dimensions (Width) × (Height) × (Depth)	Main unit (FlexStand2)	540 mm (21.3 inch) × 360 - 513.5 mm (14.2 inch - 20.2 inch) × 245.5 mm (9.7 inch)
	Main unit (TriStand2)	540 mm (21.3 inch) × 387.5 - 447.5 mm (15.3 inch - 17.6 inch) × 200 mm (7.9 inch)
	Main unit (without stand)	540 mm (21.3 inch) × 317.5 mm (12.5 inch) × 56 mm (2.2 inch)
Mass	Main unit (FlexStand2)	Approx. 6.3 kg (13.9 lbs.)
	Main unit (TriStand2)	Approx. 4.9 kg (10.8 lbs.)
	Main unit (without stand)	Approx. 3.7 kg (8.2 lbs.)
Movable range	FlexStand2	Tilt: 30° Up, 0° Down
		Swivel: 172° Right, 172° Left
		Adjustable height: 195 mm (7.7 inch) (179 mm (7.0 inch) for tilt of 0°)
		Rotation: 90° (Clockwise)
	TriStand2	Tilt: 25° Up, 0° Down
		Swivel: 172° Right, 172° Left
Adjustable height: 60 mm (2.36 inch)		
Environmental Conditions	Temperature	Operating: 5°C to 35°C (41°F to 95°F)
		Transportation/Storage: -20°C to 60°C (-4°F to 140°F)
	Humidity	Operating: 20 % to 80 % R.H. (no condensation)
		Transportation/Storage: 10 % to 90 % R.H. (no condensation)
Air Pressure	Operating: 700 to 1,060 hPa	
	Transportation/Storage: 200 to 1,060 hPa	
USB	Standard	USB Specification Revision 2.0
	Port	Upstream port × 1, Downstream port × 2
	Communication Speed	480 Mbps (high), 12 Mbps (full), 1.5 Mbps (low)
	Supply current	Downstream: Max. 500mA/1 port

● EV2416W

LCD Panel	Size	24.1-inch (610 mm)	
	Type	TFT color LCD, LED backlight	
	Surface treatment	Anti-Glare Hard Coating	
	Viewing angles	Horizontal 170°, vertical 160° (CR≥10)	
	Dot Pitch	0.270 mm	
	Response Time	Black-white-black: Approx. 5 ms	
Horizontal Scan Frequency	Analog	31 - 76 kHz	
	Digital	DVI	31 - 76 kHz
		DisplayPort	31 - 76 kHz
Vertical Scan Frequency	Analog	55 - 61 Hz (non-interlace)	
	Digital	DVI	59 - 61 Hz (non-interlace)
		DisplayPort	59 - 61 Hz (non-interlace)
Resolution		1920 Dots × 1200 Lines	
Max. Dot Clock	Analog	193.3 MHz	
	Digital	DVI	162 MHz
		DisplayPort	162 MHz
Max. Display Color		Approx. 16.77 million colors	
Display Area (H × V)		518.4 mm × 324.0 mm (20.4 inch × 12.8 inch)	
Power Supply		100 - 120 VAC ±10 %, 50 / 60 Hz 0.8 A 200 - 240 VAC ±10 %, 50 / 60 Hz 0.5 A	
Power Consumption	Screen Display On	40 W or less	
	Power saving mode	0.3 W or less (with no USB connections, "EcoView Sense": "Off", and "Sound" - "Power Save": "Sound Off")	
	Power Off	0.3 W or less	
	Main Power Off	0 W	
Input Signal Connector		D-Sub mini 15-pin DVI-D connector (Applicable to HDCP) DisplayPort (Standard V1.1a, applicable to HDCP) Applicable Format (Audio signal) - 2ch linear PCM (32 kHz / 44.1 kHz / 48 kHz / 88.2 kHz / 96 kHz)	
Analog Input Signal (Sync)		Separate, TTL, positive / negative	
Analog Input Signal (Video)		Analog, Positive (0.7 Vp-p / 75 Ω)	
Digital Signal (DVI) Transmission System		TMDS (Single Link)	
Audio Output		Speaker output: 1.0 W + 1.0 W (8 Ω, THD+N: 10 % or less) Headphone output: 2 mW + 2 mW (32 Ω, THD+N: 3 % or less)	
Line Input		Input impedance: 44 kΩ (typ.) Input level: 2.0 Vrms (Max.)	
Plug & Play		Analog / Digital (DVI-D) : VESA DDC 2B / EDID structure 1.3 Digital (DisplayPort) : VESA DisplayPort / EDID structure 1.4	
Dimensions (Width) × (Height) × (Depth)	Main unit (FlexStand2)	552.5 mm (21.8 inch) × 376 - 534 mm (14.8 - 21.0 inch) × 245.5 mm (9.7 inch)	
	Main unit (TriStand2)	552.5 mm (21.8 inch) × 408 - 468 mm (16.1 - 18.4 inch) × 200 mm (7.9 inch)	
	Main unit (without stand)	552.5 mm (21.8 inch) × 358 mm (14.1 inch) × 57 mm (2.24 inch)	
Mass	Main unit (FlexStand2)	Approx. 6.3 kg (13.9 lbs.)	
	Main unit (TriStand2)	Approx. 4.9 kg (10.8 lbs.)	
	Main unit (without stand)	Approx. 3.7 kg (8.2 lbs.)	

Movable range	FlexStand2	Tilt:	30° Up, 0° Down
		Swivel:	172° Right, 172° Left
		Adjustable height:	195 mm (7.7 inch) (158 mm (6.2 inch) for tilt of 0°)
		Rotation:	90° (Clockwise)
	TriStand2	Tilt:	25° Up, 0° Down
		Swivel:	172° Right, 172° Left
Adjustable height:		60 mm (2.36 inch)	
Environmental Conditions	Temperature	Operating:	5°C to 35°C (41°F to 95°F)
		Transportation/Storage:	-20°C to 60°C (-4°F to 140°F)
	Humidity	Operating:	20 % to 80 % R.H. (no condensation)
		Transportation/Storage:	10 % to 90 % R.H. (no condensation)
	Air Pressure	Operating:	700 to 1,060 hPa
		Transportation/Storage:	200 to 1,060 hPa
USB	Standard	USB Specification Revision 2.0	
	Port	Upstream port × 1, Downstream port × 2	
	Communication Speed	480 Mbps (high), 12 Mbps (full), 1.5 Mbps (low)	
	Supply current	Downstream:	Max. 500mA/1 port

● EV2436W

LCD Panel	Size	24.1-inch (610 mm)	
	Type	TFT color LCD, LED backlight	
	Surface treatment	Anti-Glare Hard Coating	
	Viewing angles	Horizontal 178°, vertical 178° (CR≥10)	
	Dot Pitch	0.270 mm	
	Response Time	Black-white-black: Approx. 14 ms Gray-to-gray: Approx. 6 ms (Overdrive setting: Enhanced)	
Horizontal Scan Frequency	Analog	31 - 81 kHz	
	Digital	DVI	31 - 76 kHz
		DisplayPort	31 - 76 kHz
Vertical Scan Frequency	Analog	55 - 76 Hz (non-interlace) (WUXGA: - 61 Hz)	
	Digital	DVI	59 - 61 Hz (non-interlace) (VGA TEXT: 69 - 71 Hz)
		DisplayPort	59 - 61 Hz (non-interlace) (VGA TEXT: 69 - 71 Hz)
Resolution	1920 Dots × 1200 Lines		
Max. Dot Clock	Analog	193.3 MHz	
	Digital	DVI	162 MHz
		DisplayPort	162 MHz
Max. Display Color	Approx. 16.77 million colors		
Display Area (H × V)	518.4 mm × 324.0 mm (20.4 inch × 12.8 inch)		
Power Supply	100 - 120 VAC ±10 %, 50 / 60 Hz 1.0 A 200 - 240 VAC ±10 %, 50 / 60 Hz 0.6 A		
Power Consumption	Screen Display On	60 W or less	
	Power saving mode	0.3 W or less (with no USB connections, "EcoView Sense": "Off", and "Sound" - "Power Save": "Sound Off")	
	Power Off	0.3 W or less	
	Main Power Off	0 W	

Input Signal Connector		D-Sub mini 15-pin
		DVI-D connector (Applicable to HDCP)
		DisplayPort (Standard V1.1a, applicable to HDCP)
		Applicable Format (Audio signal) - 2ch linear PCM (32 kHz / 44.1 kHz / 48 kHz / 88.2 kHz / 96 kHz)
Analog Input Signal (Sync)		Separate, TTL, positive / negative
Analog Input Signal (Video)		Analog, Positive (0.7 Vp-p / 75 Ω)
Digital Signal (DVI) Transmission System		TMDS (Single Link)
Audio Output		Speaker output: 1.0 W + 1.0 W (8 Ω, THD+N: 10 % or less) Headphone output: 2 mW + 2 mW (32 Ω, THD+N: 3 % or less)
Line Input		Input impedance: 44 kΩ (typ.) Input level: 2.0 Vrms (Max.)
Plug & Play		Analog / Digital (DVI-D) : VESA DDC 2B / EDID structure 1.3 Digital (DisplayPort) : VESA DisplayPort / EDID structure 1.4
Dimensions (Width) × (Height) × (Depth)	Main unit (FlexStand2)	552.5 mm (21.8 inch) × 376 - 534 mm (14.8 - 21.0 inch) × 245.5 mm (9.7 inch)
	Main unit (TriStand2)	552.5 mm (21.8 inch) × 408 - 468 mm (16.1 - 18.4 inch) × 200 mm (7.9 inch)
	Main unit (without stand)	552.5 mm (21.8 inch) × 358 mm (14.1 inch) × 57 mm (2.24 inch)
Mass	Main unit (FlexStand2)	Approx. 6.7 kg (14.8 lbs.)
	Main unit (TriStand2)	Approx. 5.3 kg (11.7 lbs.)
	Main unit (without stand)	Approx. 4.1 kg (9 lbs.)
Movable range	FlexStand2	Tilt: 30° Up, 0° Down
		Swivel: 172° Right, 172° Left
		Adjustable height: 195 mm (7.7 inch) (158 mm (6.2 inch) for tilt of 0°)
		Rotation: 90° (Clockwise)
	TriStand2	Tilt: 25° Up, 0° Down
		Swivel: 172° Right, 172° Left
Adjustable height: 60 mm (2.36 inch)		
Environmental Conditions	Temperature	Operating: 5°C to 35°C (41°F to 95°F)
		Transportation/Storage: -20°C to 60°C (-4°F to 140°F)
	Humidity	Operating: 20 % to 80 % R.H. (no condensation)
		Transportation/Storage: 10 % to 90 % R.H. (no condensation)
	Air Pressure	Operating: 700 to 1,060 hPa
		Transportation/Storage: 200 to 1,060 hPa
USB	Standard	USB Specification Revision 2.0
	Port	Upstream port × 1, Downstream port × 2
	Communication Speed	480 Mbps (high), 12 Mbps (full), 1.5 Mbps (low)
	Supply current	Downstream: Max. 500mA/1 port

● Main Default Settings

Auto EcoView	Standard
EcoView Optimizer 2	On
EcoView Sense	Off
FineContrast Mode	User1
Screen Size	Full Screen
Smoothing	3
Power Save	On
Eco Timer	Off
Language	English
Menu Position	Center
Input Signal	Manual

● Outside Dimensions

EV2316W / EV2336W

FlexStand2

Unit: mm (inch)

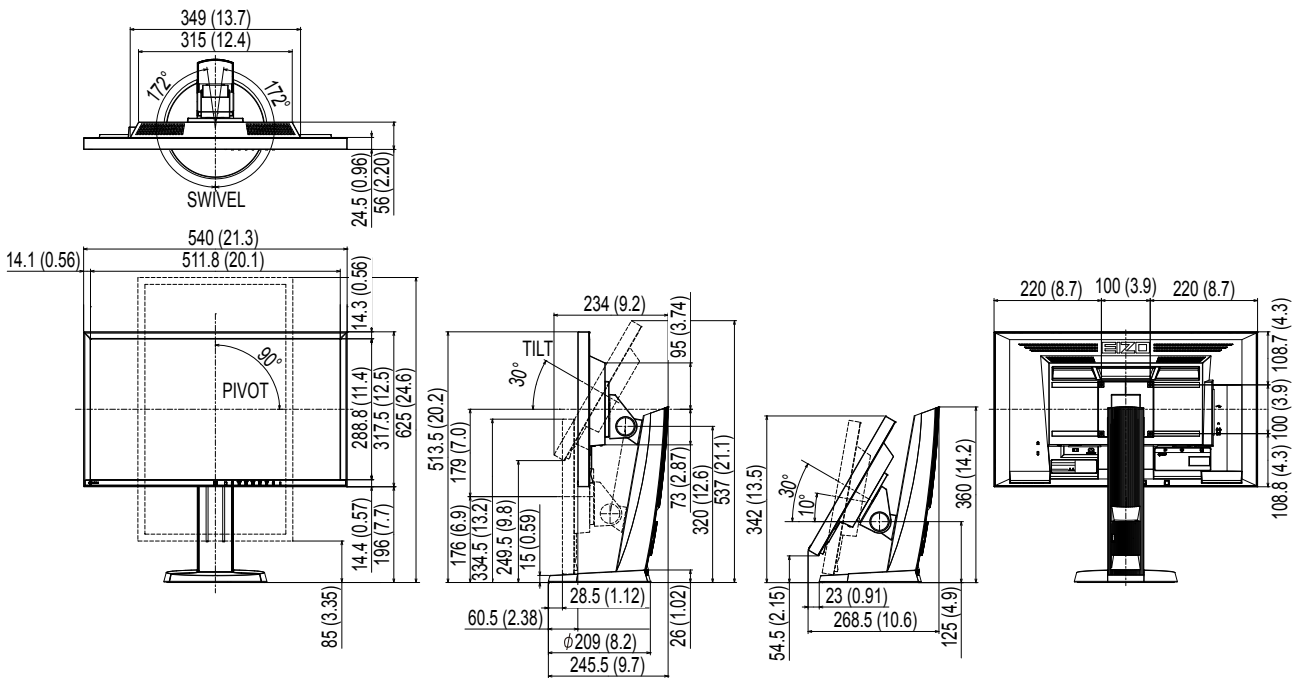

TriStand2

Unit: mm (inch)

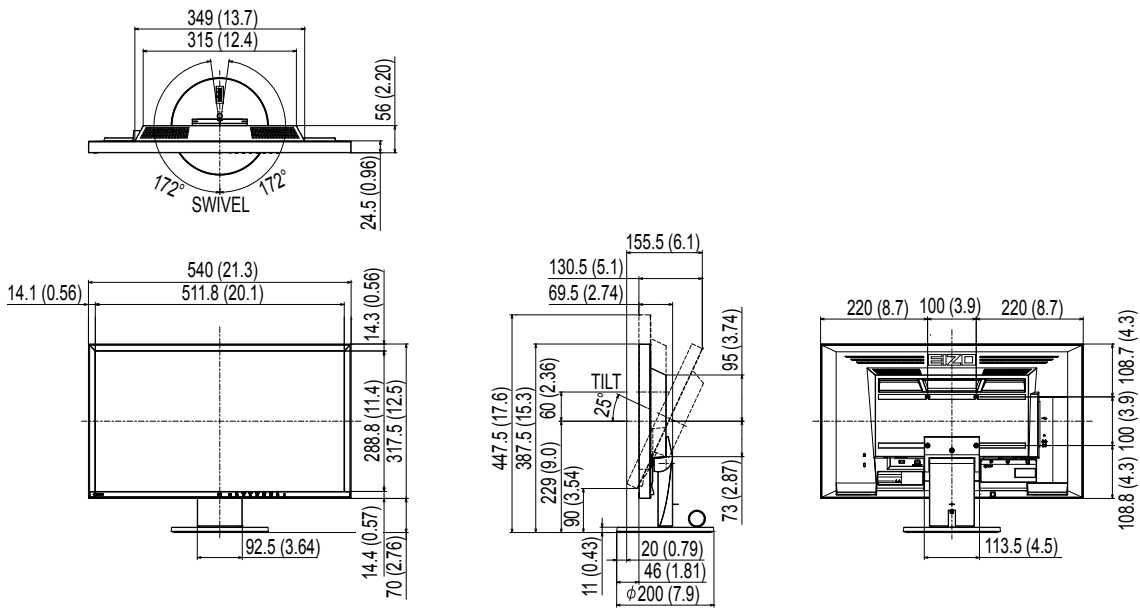

EV2416W / EV2436W

FlexStand2

Unit: mm (inch)

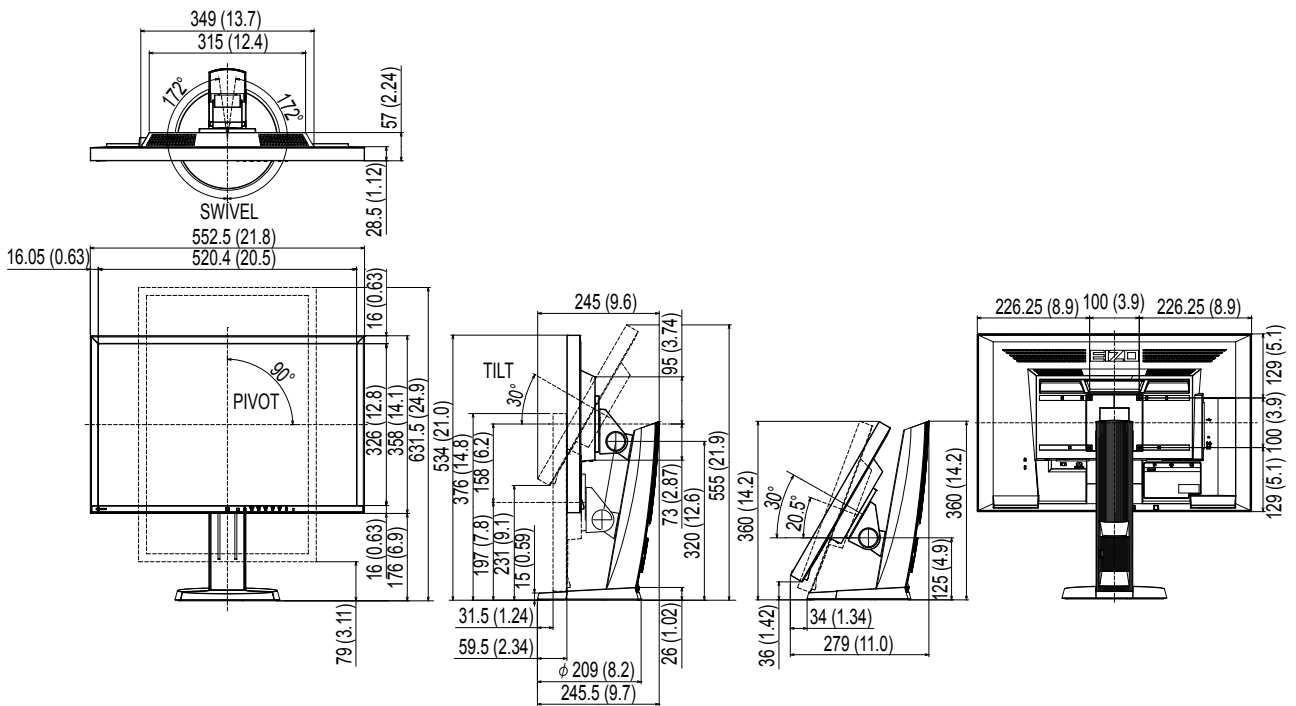

TriStand2

Unit: mm (inch)

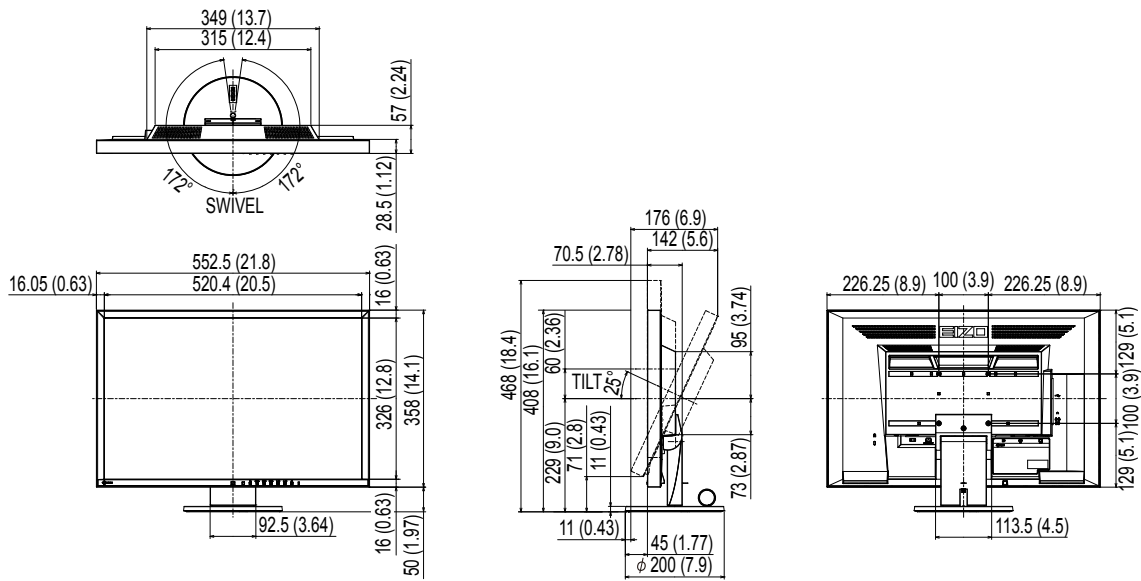

● Accessories

Signal cable	MD-C87
Cleaning Kit	EIZO "ScreenCleaner"

For the latest information about the accessories, refer to our web site.

<http://www.eizo.com>

6-8. Preset Timing

The following table shows factory preset analog signal timing.

Attention

- Display position may be deviated depending on the PC connected, which may require screen adjustment using Setting menu.
- If a signal other than those listed in the table is input, adjust the screen using the Setting menu. However, screen display may still be incorrect even after the adjustment.
- When interlace signals are used, the screen cannot be displayed correctly even after screen adjustment using the Setting menu.

● EV2316W

Resolution	Applicable Signals	Frequency			Polarity	
		Dot Clock: MHz	Horizontal: kHz	Vertical: Hz	Horizontal	Vertical
640 × 480	VGA	25.18	31.47	59.94	Negative	Negative
800 × 600	VESA	40.00	37.88	60.32	Positive	Positive
1024 × 768	VESA	65.00	48.36	60.00	Negative	Negative
1280 × 720	CEA-861	74.25	45.00	60.00	Positive	Positive
1280 × 960	VESA	108.00	60.00	60.00	Positive	Positive
1280 × 1024	VESA	108.00	63.98	60.02	Positive	Positive
1680 × 1050	VESA CVT	146.25	65.29	59.95	Negative	Positive
1680 × 1050	VESA CVT RB	119.00	64.67	59.88	Positive	Negative
1920 × 1080	CEA-861	148.50	67.50	60.00	Positive	Positive

● EV2336W

Resolution	Applicable Signals	Frequency			Polarity	
		Dot Clock: MHz	Horizontal: kHz	Vertical: Hz	Horizontal	Vertical
640 × 480	VGA	25.18	31.47	59.94	Negative	Negative
640 × 480	VESA	31.50	37.86	72.81	Negative	Negative
640 × 480	VESA	31.50	37.50	75.00	Negative	Negative
720 × 400	VGA TEXT	28.32	31.47	70.09	Negative	Positive
800 × 600	VESA	36.00	35.16	56.25	Positive	Positive
800 × 600	VESA	40.00	37.88	60.32	Positive	Positive
800 × 600	VESA	50.00	48.08	72.19	Positive	Positive
800 × 600	VESA	49.50	46.88	75.00	Positive	Positive
1024 × 768	VESA	65.00	48.36	60.00	Negative	Negative
1024 × 768	VESA	75.00	56.48	70.07	Negative	Negative
1024 × 768	VESA	78.75	60.02	75.03	Positive	Positive
1280 × 720	CEA-861	74.25	45.00	60.00	Positive	Positive
1280 × 960	VESA	108.00	60.00	60.00	Positive	Positive
1280 × 1024	VESA	108.00	63.98	60.02	Positive	Positive
1280 × 1024	VESA	135.00	79.98	75.03	Positive	Positive
1680 × 1050	VESA CVT	146.25	65.29	59.95	Negative	Positive
1680 × 1050	VESA CVT RB	119.00	64.67	59.88	Positive	Negative
1920 × 1080	CEA-861	148.50	67.50	60.00	Positive	Positive

● EV2416W

Resolution	Applicable Signals	Frequency			Polarity	
		Dot Clock: MHz	Horizontal: kHz	Vertical: Hz	Horizontal	Vertical
640 × 480	VGA	25.18	31.47	59.94	Negative	Negative
800 × 600	VESA	40.00	37.88	60.32	Positive	Positive
1024 × 768	VESA	65.00	48.36	60.00	Negative	Negative
1280 × 720	CEA-861	74.25	45.00	60.00	Positive	Positive
1280 × 960	VESA	108.00	60.00	60.00	Positive	Positive
1280 × 1024	VESA	108.00	63.98	60.02	Positive	Positive
1600 × 1200	VESA	162.00	75.00	60.00	Positive	Positive
1680 × 1050	VESA CVT	146.25	65.29	59.95	Negative	Positive
1680 × 1050	VESA CVT RB	119.00	64.67	59.88	Positive	Negative
1920 × 1200	VESA CVT	193.25	74.56	59.89	Negative	Positive
1920 × 1200	VESA CVT RB	154.00	74.04	59.95	Positive	Negative

● EV2436W

Resolution	Applicable Signals	Frequency			Polarity	
		Dot Clock: MHz	Horizontal: kHz	Vertical: Hz	Horizontal	Vertical
640 × 480	VGA	25.18	31.47	59.94	Negative	Negative
640 × 480	VESA	31.50	37.86	72.81	Negative	Negative
640 × 480	VESA	31.50	37.50	75.00	Negative	Negative
720 × 400	VGA TEXT	28.32	31.47	70.09	Negative	Positive
800 × 600	VESA	36.00	35.16	56.25	Positive	Positive
800 × 600	VESA	40.00	37.88	60.32	Positive	Positive
800 × 600	VESA	50.00	48.08	72.19	Positive	Positive
800 × 600	VESA	49.50	46.88	75.00	Positive	Positive
1024 × 768	VESA	65.00	48.36	60.00	Negative	Negative
1024 × 768	VESA	75.00	56.48	70.07	Negative	Negative
1024 × 768	VESA	78.75	60.02	75.03	Positive	Positive
1280 × 720	CEA-861	74.25	45.00	60.00	Positive	Positive
1280 × 960	VESA	108.00	60.00	60.00	Positive	Positive
1280 × 1024	VESA	108.00	63.98	60.02	Positive	Positive
1280 × 1024	VESA	135.00	79.98	75.03	Positive	Positive
1600 × 1200	VESA	162.00	75.00	60.00	Positive	Positive
1680 × 1050	VESA CVT	146.25	65.29	59.95	Negative	Positive
1680 × 1050	VESA CVT RB	119.00	64.67	59.88	Positive	Negative
1920 × 1200	VESA CVT	193.25	74.56	59.89	Negative	Positive
1920 × 1200	VESA CVT RB	154.00	74.04	59.95	Positive	Negative

6-9. Glossary

Clock

The analog signal input monitor needs to reproduce a clock of the same frequency as the dot clock of the graphics system in use, when the analog signal is converted to a digital signal for image display. This is called clock adjustment. If the clock pulse is not set correctly, some vertical bars appear on the screen.

DDC/CI (Display Data Channel / Command Interface)

VESA provides the standardization for the interactive communication of the setting information, etc. between a PC and the monitor.

DisplayPort

DisplayPort is a next-generation digital AV interface that allows connection of the PC, audio, imaging devices, etc. to the monitor. One cable can transfer sound with images.

DVI (Digital Visual Interface)

DVI is a digital interface standard. DVI allows direct transmission of the PC's digital data without loss. This adopts the TMDS transmission system and DVI connectors. There are two types of DVI connectors. One is a DVI-D connector for digital signal input only. The other is a DVI-I connector for both digital and analog signal inputs.

DVI DMPM (DVI Digital Monitor Power Management)

DVI DMPM is a digital interface power saving function. The "Monitor ON (operating mode)" and "Active Off (power saving mode)" are indispensable for DVI DMPM as the monitor's power mode.

Gain

This is used to adjust each color parameter for red, green and blue. An LCD monitor displays the color by the light passing through the panel color filter. Red, green and blue are the three primary colors. All the colors on the screen are displayed by combining these three colors. The color tone can be changed by adjusting the light intensity (volume) passing through each color's filter.

Gamma

Generally, the monitor brightness varies nonlinearly with the input signal level, which is called "Gamma Characteristic". A small gamma value produces a low-contrast image, while a large gamma value produces a high-contrast image.

HDCP (High-bandwidth Digital Content Protection)

Digital signal coding system developed to copy-protect the digital contents, such as video, music, etc. This helps to transmit the digital contents safely by coding the digital contents sent via the DVI or HDMI connector on the output side and decoding them on the input side. Any digital contents cannot be reproduced if both of the equipments on the output and input sides are not applicable to HDCP system.

Overdrive

This technology enhances response speed by increasing the potential difference at the time of motion of liquid-crystal pixels, and it is used for liquid-crystal TV sets and others in general. It provides clear-cut three-dimensional display with little afterimage, by improving response speed of the intermediate graduation range that frequently appears in moving images.

Phase

Phase means the sampling timing to convert the analog input signal to a digital signal. Phase adjustment is made to adjust the timing. It is recommended that phase adjustment be made after the clock is adjusted correctly.

Range Adjustment

Range adjustment controls the signal output levels to display every color gradation. It is recommended that range adjustment be made before color adjustment.

Resolution

The LCD panel consists of numerous pixels of specified size, which are illuminated to form images. This monitor consists of horizontal 1920 pixels and 1080 vertical pixels (EV2316W / EV2336W), or horizontal 1920 pixels and 1200 vertical pixels (EV2416W / EV2436W). At a resolution of 1920×1080 (EV2316W / EV2336W) or 1920×1200 (EV2416W / EV2436W), all pixels are illuminated as a full screen (1:1).

sRGB (Standard RGB)

International standard for color reproduction and color space among peripheral devices (such as monitors, printers, digital cameras, scanners). As a form of simple color matching for the Internet, colors can be displayed using tones close to those of the transmission and reception devices.

Temperature

Color temperature is a method to measure the white color tone, generally indicated in degrees Kelvin. The screen becomes reddish at a low temperature, and bluish at a high temperature, like the flame temperature.

5000 K: Slightly reddish white

6500 K: White referred to as daylight-balanced color

9300 K: Slightly bluish white

TMDS (Transition Minimized Differential Signaling)

A signal transmission system for digital interface.

VESA DPM (Video Electronics Standards Association - Display Power Management)

VESA specifications achieve increased energy efficiency for computer monitors. This involves standardization of signals sent from the computer (graphics board).

DPM defines the status of signals transmitted between the computer and monitor.

Appendix

Trademark

The DisplayPort Compliance Logo and VESA are registered trademarks of the Video Electronics Standards Association.

Windows, Windows Vista, Windows Media, SQL Server, and Xbox 360 are registered trademarks of Microsoft Corporation in the United States and other countries.

Apple, Mac, Macintosh, iMac, eMac, Mac OS, MacBook, PowerBook, ColorSync, QuickTime, and iBook are registered trademarks of Apple Inc.

Acrobat, Adobe, Adobe AIR, and Photoshop are registered trademarks of Adobe Systems Incorporated in the United States and other countries.

PowerPC is a registered trademark of International Business Machines Corporation.

Pentium is a registered trademark of Intel Corporation in the United States and other countries.

AMD Athlon and AMD Opteron are trademarks of Advanced Micro Devices, Inc.

GRACoL and IDEAlliance are registered trademarks of International Digital Enterprise Alliance.

ColorVision, ColorVision Spyder2 are registered trademarks of DataColor Holding AG.

Spyder3 is a trademark of DataColor Holding AG.

Eye-One, ColorMunki, and X-Rite are registered trademarks or trademarks of X-Rite Incorporated.

TouchWare is a trademark of 3M Touch Systems, Inc.

NextWindow is a registered trademark of NextWindow Ltd.

RealPlayer is a registered trademark of RealNetworks, Inc.

NEC is a registered trademark of NEC Corporation. PC-9801 and PC-9821 are trademarks of NEC Corporation.

PlayStation is a registered trademark of Sony Computer Entertainment Inc.

PSP and PS3 are trademarks of Sony Computer Entertainment Inc.

ENERGY STAR is a registered trademark of the United States Environmental Protection Agency in the United States and other countries.

The terms HDMI and HDMI High-Definition Multimedia Interface, and the HDMI Logo are trademarks or registered trademarks of HDMI Licensing, LLC in the United States and other countries.

Kensington and MicroSaver are trademarks of ACCO Brands Corporation.

EIZO, the EIZO Logo, ColorEdge, DuraVision, FlexScan, FORIS, RadiForce, RadiCS, RadiNET, Raptor, and ScreenManager are registered trademarks of EIZO Corporation in Japan and other countries.

ColorNavigator, EIZO EasyPIX, EcoView NET, EIZO ScreenSlicer, i•Sound, Screen Administrator, and UniColor Pro are trademarks of EIZO Corporation.

All other company and product names are trademarks or registered trademarks of their respective owners.

License

A round gothic bold bit map font designed by Ricoh is used for the characters displayed on this product.

ENERGY STAR

As an ENERGY STAR Partner, EIZO Corporation has determined that this product meets the ENERGY STAR guidelines for energy efficiency.



TCO

This product has acquired the TCO standard that relates to the safety, ergonomics (EcoView Optimizer 2: Off), environment and so forth of office equipment. For an overview of the TCO, refer to our web site.

<http://www.eizo.com>

FCC Declaration of Conformity

For U.S.A. , Canada, etc. (rated 100-120 Vac) Only

FCC Declaration of Conformity

We, the Responsible Party

EIZO Inc.

5710 Warland Drive, Cypress, CA 90630

Phone: (562) 431-5011

declare that the product

Trade name: EIZO

Model: FlexScan EV2316W/EV2336W/EV2416W/EV2436W

is in conformity with Part 15 of the FCC Rules. Operation of this product is subject to the following two conditions: (1) this device may not cause harmful interference, and (2) this device must accept any interference received, including interference that may cause undesired operation.

This equipment has been tested and found to comply with the limits for a Class B digital device, pursuant to Part 15 of the FCC Rules. These limits are designed to provide reasonable protection against harmful interference in a residential installation. This equipment generates, uses, and can radiate radio frequency energy and, if not installed and used in accordance with the instructions, may cause harmful interference to radio communications. However, there is no guarantee that interference will not occur in a particular installation. If this equipment does cause harmful interference to radio or television reception, which can be determined by turning the equipment off and on, the user is encouraged to try to correct the interference by one or more of the following measures.

- * Reorient or relocate the receiving antenna.
- * Increase the separation between the equipment and receiver.
- * Connect the equipment into an outlet on a circuit different from that to which the receiver is connected.
- * Consult the dealer or an experienced radio/TV technician for help.

Changes or modifications not expressly approved by the party responsible for compliance could void the user's authority to operate the equipment.

Note

Use the attached specified cable below or EIZO signal cable with this monitor so as to keep interference within the limits of a Class B digital device.

- AC Cord
- Shielded Signal Cable (enclosed)

Canadian Notice

This Class B digital apparatus complies with Canadian ICES-003.

Cet appareil numérique de la classe B est conforme à la norme NMB-003 du Canada.

Hinweise zur Auswahl des richtigen Schwenkarms für Ihren Monitor

Dieser Monitor ist für Bildschirmarbeitsplätze vorgesehen. Wenn nicht der zum Standardzubehör gehörige Schwenkarm verwendet wird, muss statt dessen ein geeigneter anderer Schwenkarm installiert werden. Bei der Auswahl des Schwenkarms sind die nachstehenden Hinweise zu berücksichtigen:

Der Standfuß muß den nachfolgenden Anforderungen entsprechen:

- a) Der Standfuß muß eine ausreichende mechanische Stabilität zur Aufnahme des Gewichtes vom Bildschirmgerät und des spezifizierten Zubehörs besitzen. Das Gewicht des Bildschirmgerätes und des Zubehörs sind in der zugehörigen Bedienungsanleitung angegeben.
- b) Die Befestigung des Standfusses muß derart erfolgen, daß die oberste Zeile der Bildschirmanzeige nicht höher als die Augenhöhe eines Benutzers in sitzender Position ist.
- c) Im Fall eines stehenden Benutzers muß die Befestigung des Bildschirmgerätes derart erfolgen, daß die Höhe der Bildschirmmitte über dem Boden zwischen 135 – 150 cm beträgt.
- d) Der Standfuß muß die Möglichkeit zur Neigung des Bildschirmgerätes besitzen (max. vorwärts: 5°, min. nach hinten $\geq 5^\circ$).
- e) Der Standfuß muß die Möglichkeit zur Drehung des Bildschirmgerätes besitzen (max. $\pm 180^\circ$). Der maximale Kraftaufwand dafür muß weniger als 100 N betragen.
- f) Der Standfuß muß in der Stellung verharren, in die er manuell bewegt wurde.
- g) Der Glanzgrad des Standfusses muß weniger als 20 Glanzeinheiten betragen (seidenmatt).
- h) Der Standfuß mit Bildschirmgerät muß bei einer Neigung von bis zu 10° aus der normalen aufrechten Position kippsicher sein.

Hinweis zur Ergonomie :

Dieser Monitor erfüllt die Anforderungen an die Ergonomie nach EK1-ITB2000 mit dem Videosignal, 1920×1080 (EV2316W / EV2336W) / 1920×1200 (EV2416W / EV2436W), Digital Eingang und mindestens 60,0 Hz Bildwiederholfrequenz, non interlaced. Weiterhin wird aus ergonomischen Gründen empfohlen, die Grundfarbe Blau nicht auf dunklem Untergrund zu verwenden (schlechte Erkennbarkeit, Augenbelastung bei zu geringem Zeichenkontrast.)

Übermäßiger Schalldruck von Ohrhörern bzw. Kopfhörern kann einen Hörverlust bewirken. Eine Einstellung des Equalizers auf Maximalwerte erhöht die Ausgangsspannung am Ohrhörer- bzw. Kopfhörerausgang und damit auch den Schalldruckpegel.

„Maschinenlärminformations-Verordnung 3. GPSGV:

Der höchste Schalldruckpegel beträgt 70 dB(A) oder weniger gemäss EN ISO 7779“

[Begrenzung des maximalen Schalldruckpegels am Ohr]

Bildschirmgeräte: Größte Ausgangsspannung 150 mV

LIMITED WARRANTY

LIMITED WARRANTY

EIZO Corporation (hereinafter referred to as “**EIZO**”) and distributors authorized by EIZO (hereinafter referred to as the “**Distributors**”) warrant, subject to and in accordance with the terms of this limited warranty (hereinafter referred to as the “**Warranty**”), to the original purchaser (hereinafter referred to as the “**Original Purchaser**”) who purchased the product specified in this document (hereinafter referred to as the “**Product**”) from EIZO or Distributors, that EIZO and Distributors shall, at their sole discretion, either repair or replace the Product at no charge if the Original Purchaser becomes aware within the Warranty Period (defined below) that the Product malfunctions or is damaged in the course of normal use of the Product in accordance with the description in the instruction manual attached to the Product (hereinafter referred to as the “**User’s Manual**”).

The period of this Warranty is limited to (i) five (5) years from the date of purchase of the Product; or, limited to the expiration of (ii) 30,000 hours of its use of the Product (hereinafter referred to as the “**Warranty Period**”). EIZO and Distributors shall bear no liability or obligation with regard to the Product in relation to the Original Purchaser or any third parties other than as provided under this Warranty.

EIZO and Distributors will cease to hold or store any parts of the Product upon expiration of seven (7) years after the production of such parts is discontinued. In repairing the monitor, EIZO and Distributors will use renewal parts which comply with our QC standards.

The Warranty is valid only in the countries or territories where the Distributors are located. The Warranty does not restrict any legal rights of the Original Purchaser.

Notwithstanding any other provision of this Warranty, EIZO and Distributors shall have no obligation under this Warranty whatsoever in any of the cases as set forth below:

- (a) Any defect of the Product caused by freight damage, modification, alteration, abuse, misuse, accident, incorrect installation, disaster, faulty maintenance and/or improper repair by third party other than EIZO and Distributors;
- (b) Any incompatibility of the Product due to possible technical innovations and/or regulations;
- (c) Any deterioration of the sensor;
- (d) Any deterioration of display performance caused by the deterioration of expendable parts such as the LCD panel and/or backlight, etc. (e.g. changes in brightness, changes in brightness uniformity, changes in color, changes in color uniformity, defects in pixels including burnt pixels, etc.);
- (e) Any defect of the Product caused by external equipment;
- (f) Any defect of the Product on which the original serial number has been altered or removed;
- (g) Any normal deterioration of the product, particularly that of consumables, accessories, and/or attachments (e.g. buttons, rotating parts, cables, User’s Manual, etc.); and
- (h) Any deformation, discoloration, and/or warp of the exterior of the product including that of the surface of the LCD panel.

To obtain service under the Warranty, the Original Purchaser must deliver the Product, freight prepaid, in its original package or other adequate package affording an equal degree of protection, assuming the risk of damage and/or loss in transit, to the local Distributor. The Original Purchaser must present proof of purchase of the Product and the date of such purchase when requesting services under the Warranty.

The Warranty Period for any replaced and/or repaired product under this Warranty shall expire at the end of the original Warranty Period.

EIZO OR DISTRIBUTORS ARE NOT RESPONSIBLE FOR ANY DAMAGE TO, OR LOSS OF, DATA OR OTHER INFORMATION STORED IN ANY MEDIA OR ANY PART OF ANY PRODUCT RETURNED TO EIZO OR DISTRIBUTORS FOR REPAIR.

EIZO AND DISTRIBUTORS MAKE NO FURTHER WARRANTIES, EXPRESSED OR IMPLIED, WITH RESPECT TO THE PRODUCT AND ITS QUALITY, PERFORMANCE, MERCHANTABILITY OR FITNESS FOR ANY PARTICULAR USE. IN NO EVENT SHALL EIZO OR DISTRIBUTORS BE LIABLE FOR ANY INCIDENTAL, INDIRECT, SPECIAL, CONSEQUENTIAL OR OTHER DAMAGE WHATSOEVER (INCLUDING, WITHOUT LIMITATION, DAMAGES FOR LOSS OF PROFIT, BUSINESS INTERRUPTION, LOSS OF BUSINESS INFORMATION, OR ANY OTHER PECUNIARY LOSS) ARISING OUT OF THE USE OR INABILITY TO USE THE PRODUCT OR IN ANY CONNECTION WITH THE PRODUCT, WHETHER BASED ON CONTRACT, TORT, NEGLIGENCE, STRICT LIABILITY OR OTHERWISE, EVEN IF EIZO OR DISTRIBUTORS HAVE BEEN ADVISED OF THE POSSIBILITY OF SUCH DAMAGES. THIS EXCLUSION ALSO INCLUDES ANY LIABILITY WHICH MAY ARISE OUT OF THIRD PARTY CLAIMS AGAINST THE ORIGINAL PURCHASER. THE ESSENCE OF THIS PROVISION IS TO LIMIT THE POTENTIAL LIABILITY OF EIZO AND DISTRIBUTORS ARISING OUT OF THIS LIMITED WARRANTY AND/OR SALES.

BEGRENZTE GARANTIE

EIZO Corporation (im Weiteren als „**EIZO**“ bezeichnet) und die Vertragsimporteure von EIZO (im Weiteren als „**Vertrieb(e)**“ bezeichnet) garantieren dem ursprünglichen Käufer (im Weiteren als „**Erstkäufer**“ bezeichnet), der das in diesem Dokument vorgegebene Produkt (im Weiteren als „**Produkt**“ bezeichnet) von EIZO oder einem Vertrieb erworben hat, gemäß den Bedingungen dieser beschränkten Garantie (im Weiteren als „**Garantie**“ bezeichnet), dass EIZO und der Vertrieb nach eigenem Ermessen das Produkt entweder kostenlos reparieren oder austauschen, falls der Erstkäufer innerhalb der Garantiefrist (weiter unten festgelegt) eine Fehlfunktion bzw. Beschädigung des Produkts feststellt, die während des normalen Gebrauchs des Produkts gemäß den Anweisungen des zum Lieferumfang des Produkts gehörenden Benutzerhandbuchs (im Weiteren als „**Benutzerhandbuch**“ bezeichnet) aufgetreten ist.

Die Dauer der Garantieleistung beträgt (i) fünf (5) Jahre ab dem Erstverkaufsdatum des Produkts oder (ii) 30.000 Betriebsstunden des Produkts (im Weiteren als „**Garantiefrist**“ bezeichnet). EIZO und die Vertriebe übernehmen über den Rahmen dieser Garantie hinaus hinsichtlich des Produkts keinerlei Haftung oder Verpflichtung dem Erstkäufer oder Dritten gegenüber.

EIZO und die Vertriebe verpflichten sich, Ersatzteile für das Produkt über einen Zeitraum von sieben (7) Jahren nach Einstellung der Produktion der Ersatzteile zu lagern bzw. anzubieten. EIZO und seine Vertriebspartner verpflichten sich, bei einer etwaigen Reparatur des Monitors ausschließlich Produkte gemäß den EIZO-Qualitätssicherungsstandards zu verwenden.

Diese Garantie gilt nur in Ländern oder Gebieten, in denen sich Vertriebe befinden. Die gesetzlichen Gewährleistungsrechte des Erstkäufers gegenüber dem Verkäufer werden durch diese Garantie nicht berührt.

EIZO und die Vertriebe besitzen im Rahmen dieser Garantie keinerlei Verpflichtung in den folgenden Fällen:

- (a) Produktdefekte, die auf Frachtschäden, Modifikation, Nachgestaltung, Missbrauch, Fehlbedienung, Unfälle, unsachgemäße Installation, Naturkatastrophen, fehlerhafte Wartung und/oder unsachgemäße Reparatur durch eine andere Partei als EIZO und die Vertriebe zurückzuführen sind.
- (b) Eine Inkompatibilität des Produkts aufgrund von technischen Neuerungen und/oder neuen Bestimmungen, die nach dem Kauf in Kraft treten.
- (c) Jegliche Verschlechterung des Sensors.
- (d) Jegliche Verschlechterung der Bildschirmleistung, die durch Verschleißteile wie das LCD-Panel und/oder die Hintergrundbeleuchtung usw. hervorgerufen werden (z.B. Veränderungen von Helligkeit oder Helligkeitsverteilung, Veränderungen von Farbe oder Farbverteilung, Pixeldefekte einschließlich von durchgebrannten Pixeln usw.).
- (e) Produktdefekte, die durch externe Geräte verursacht werden.
- (f) Jeglicher Defekt eines Produkts, dessen ursprüngliche Seriennummer geändert oder entfernt wurde.
- (g) Normale Abnutzung des Produkts, insbesondere von Verbrauchsteilen, Zubehöerteilen und/oder Beilagen (z.B. Tasten, drehbare Teile, Kabel, Benutzerhandbuch usw.); sowie
- (h) Verformungen, Verfärbungen und/oder Verziehungen am Produktäußeren, einschließlich der Oberfläche des LCD-Panels.

Bei Inanspruchnahme der Garantieleistung ist der Erstkäufer verpflichtet, das Produkt auf eigene Kosten und in der Originalverpackung bzw. einer anderen geeigneten Verpackung, die einen gleichwertigen Schutz gegen Transportschäden bietet, an den örtlichen Vertrieb zu übersenden, wobei der Erstkäufer das Transportrisiko gegenüber Schäden und/oder Verlust trägt. Zum Zeitpunkt der Inanspruchnahme der Garantieleistung muss der Erstkäufer einen Verkaufsbeleg vorweisen, auf dem das Kaufdatum angegeben ist.

Die Garantiefrist für ein im Rahmen dieser Garantie ausgetauschtes und/oder repariertes Produkt erlischt nach Ablauf der ursprünglichen Garantiefrist.

EIZO ODER DIE EIZO-VERTRAGSIMPORTEURE HAFTEN NICHT FÜR ZERSTÖRTE DATENBESTÄNDE ODER DIE KOSTEN DER WIEDERBESCHAFFUNG DIESER DATENBESTÄNDE AUF JEDLICHEN DATENTRÄGERN ODER TEILEN DES PRODUKTS, DIE IM RAHMEN DER GARANTIE BEI EIZO ODER DEN EIZO-VERTRAGSIMPORTEUREN ZUR REPARATUR EINGEREICHT WURDEN.

EIZO UND DIE EIZO-VERTRAGSIMPORTEURE GEBEN WEDER EXPLIZITE NOCH IMPLIZITE GARANTIE IN BEZUG AUF DIESES PRODUKT UND SEINE QUALITÄT, LEISTUNG, VERKÄUFLICHKEIT ODER EIGNUNG FÜR EINEN BESTIMMTEN ZWECK. AUF KEINEN FALL SIND EIZO ODER DIE EIZO-VERTRAGSIMPORTEURE VERANTWORTLICH FÜR JEDLICHE ZUFÄLLIGE, INDIREKTE, SPEZIELLE, FOLGE- ODER ANDERE SCHÄDEN JEDLICHER ART (EINSCHLIESSLICH OHNE JEDE BEGRENZUNG SCHÄDEN BEZÜGLICH PROFITVERLUST, GESCHÄFTSUNTERBRECHUNG, VERLUST VON GESCHÄFTSINFORMATION ODER JEDLICHE ANDEREN FINANZIELLEN EINBUSSEN), DIE DURCH DIE VERWENDUNG DES PRODUKTES ODER DIE UNFÄHIGKEIT ZUR VERWENDUNG DES PRODUKTES ODER IN JEDLICHER BEZIEHUNG MIT DEM PRODUKT, SEI ES BASIEREND AUF VERTRAG, SCHADENSERSATZ, NACHLAESSIGKEIT, STRIKTE HAFTPFLICHT ODER ANDEREN FORDERUNGEN ENTSTEHEN, AUCH WENN EIZO UND DIE EIZO-VERTRAGSIMPORTEURE IM VORAUS ÜBER DIE MÖGLICHKEIT SOLCHER SCHÄDEN INFORMIERT WURDEN. DIESER AUSSCHLUSS ENTHÄLT AUCH JEDE HAFTPFLICHT, DIE AUS FORDERUNGEN DRITTER GEGEN DEN ERSTKÄUFER ENTSTEHEN KANN. ZWECK DIESER KLAUSEL IST ES, DIE HAFTUNG VON EIZO UND DEN VERTRIEBEN GEGENÜBER FORDERUNGEN ZU BEGRENZEN, DIE AUS DIESER BESCHRÄNKTEN GARANTIE UND/ODER DEM VERKAUF ENTSTEHEN KÖNNEN.

GARANTIE LIMITÉE

EIZO Corporation (ci-après dénommé « **EIZO** ») et les distributeurs autorisés par EIZO (ci-après dénommés « **Distributeurs** »), sous réserve et conformément aux termes de cette garantie limitée (ci-après dénommée « **Garantie** »), garantissent à l'acheteur initial (ci-après dénommé « **Acheteur initial** ») du produit spécifié dans la présente (ci-après dénommé « **Produit** ») acheté auprès d'EIZO ou de Distributeurs agréés EIZO, que EIZO et ses Distributeurs auront pour option de réparer ou remplacer gratuitement le Produit si l'Acheteur initial constate, pendant la Période de garantie (définie ci-dessous), qu'il y a un dysfonctionnement ou que le Produit a subi un dommage dans le cadre d'une utilisation normale du Produit conformément à la description du mode d'emploi qui accompagne le Produit (ci-après dénommé « **Manuel d'utilisation** »).

La période de cette Garantie est limitée à (i) cinq (5) ans à partir de la date d'achat du Produit ; ou, limitée jusqu'à l'expiration de (ii) 30 000 heures d'utilisation du Produit (ci-après dénommée « **Période de Garantie** »). EIZO et ses Distributeurs déclinent toute responsabilité ou obligation concernant ce Produit face à l'Acheteur initial ou à toute autre personne à l'exception de celles stipulées dans la présente Garantie.

EIZO et ses Distributeurs cesseront de tenir ou conserver en stock toute pièce de ce Produit après l'expiration de la période de sept (7) ans suivant l'arrêt de la production de telles pièces. Pour réparer le moniteur, EIZO et ses distributeurs utiliseront des pièces de rechange conformes à nos normes de contrôle qualité.

La Garantie est valable uniquement dans les pays ou les territoires où se trouvent les Distributeurs. La Garantie ne limite aucun des droits reconnus par la loi à l'Acheteur initial.

Nonobstant toute autre clause de cette Garantie, EIZO et ses Distributeurs n'auront d'obligation dans le cadre de cette Garantie pour aucun des cas énumérés ci-dessous :

- (a) Tout défaut du Produit résultant de dommages occasionnés lors du transport, d'une modification, d'une altération, d'un abus, d'une mauvaise utilisation, d'un accident, d'une installation incorrecte, d'un désastre, d'un entretien et/ou d'une réparation incorrects effectués par une personne autre que EIZO ou ses Distributeurs ;
- (b) Toute incompatibilité du Produit résultant d'améliorations techniques et/ou réglementations possibles ;
- (c) Toute détérioration du capteur ;
- (d) Toute détérioration des performances d'affichage causée par la détérioration des éléments consommables tels que le panneau LCD et/ou le rétroéclairage, etc. (par exemple des changements de luminosité, des changements de l'uniformité de la luminosité, des modifications de couleur, des changements de l'uniformité des couleurs, des défauts de pixels y compris des pixels brûlés, etc.);
- (e) Tout défaut du Produit causé par un appareil externe ;
- (f) Tout défaut d'un Produit sur lequel le numéro de série original a été altéré ou supprimé ;
- (g) Toute détérioration normale du Produit, particulièrement celle des consommables, des accessoires et/ou des pièces reliées au Produit (touches, éléments pivotants, câbles, Manuel d'utilisation etc.), et
- (h) Toute déformation, décoloration, et/ou gondolage de l'extérieur du Produit, y compris celle de la surface du panneau LCD.

Pour bénéficier d'un service dans le cadre de cette Garantie, l'Acheteur initial doit renvoyer le Produit port payé, dans son emballage d'origine ou tout autre emballage approprié offrant un degré de protection équivalent, au Distributeur local, et assumera la responsabilité des dommages et/ou perte possibles lors du transport. L'Acheteur initial doit présenter une preuve d'achat du Produit comprenant sa date d'achat pour bénéficier de ce service dans le cadre de la Garantie.

La Période de garantie pour tout Produit remplacé et/ou réparé dans le cadre de cette Garantie expirera à la fin de la Période de garantie initiale.

EIZO OU SES DISTRIBUTEURS NE SAURAIENT ÊTRE TENUS RESPONSABLES DES DOMMAGES OU PERTES DE DONNÉES OU D'AUTRES INFORMATIONS STOCKÉES DANS UN MÉDIA QUELCONQUE OU UNE AUTRE PARTIE DU PRODUIT RENVOYÉ À EIZO OU AUX DISTRIBUTEURS POUR RÉPARATION.

AUCUNE AUTRE GARANTIE, EXPLICITE OU TACITE, N'EST OFFERTE PAR EIZO ET SES DISTRIBUTEURS CONCERNANT LE PRODUIT ET SES QUALITÉS, PERFORMANCES, QUALITÉ MARCHANDE OU ADAPTATION À UN USAGE PARTICULIER. EN AUCUN CAS, EIZO OU SES DISTRIBUTEURS NE SERONT RESPONSABLES DES DOMMAGES FORTUITS, INDIRECTS, SPÉCIAUX, INDUITS, OU DE TOUT AUTRE DOMMAGE QUEL QU'IL SOIT (Y COMPRIS, SANS LIMITATION, LES DOMMAGES RÉSULTANT D'UNE PERTE DE PROFIT, D'UNE INTERRUPTION D'ACTIVITÉS, D'UNE PERTE DE DONNÉES COMMERCIALES, OU DE TOUT AUTRE MANQUE À GAGNER) RÉSULTANT DE L'UTILISATION OU DE L'INCAPACITÉ D'UTILISER LE PRODUIT OU AYANT UN RAPPORT QUELCONQUE AVEC LE PRODUIT, QUE CE SOIT SUR LA BASE D'UN CONTRAT, D'UN TORT, D'UNE NÉGLIGENCE, D'UNE RESPONSABILITÉ STRICTE OU AUTRE, MÊME SI EIZO OU SES DISTRIBUTEURS ONT ÉTÉ AVERTIS DE LA POSSIBILITÉ DE TELS DOMMAGES. CETTE LIMITATION INCLUT AUSSI TOUTE RESPONSABILITÉ QUI POURRAIT ÊTRE SOULEVÉE LORS DES RÉCLAMATIONS D'UN TIERS CONTRE L'ACHETEUR INITIAL. L'ESSENCE DE CETTE CLAUSE EST DE LIMITER LA RESPONSABILITÉ POTENTIELLE DE EIZO ET DE SES DISTRIBUTEURS RÉSULTANT DE CETTE GARANTIE LIMITÉE ET/OU DES VENTES.

GARANTÍA LIMITADA

EIZO Corporation (en lo sucesivo “EIZO”) y sus distribuidores autorizados (en lo sucesivo los “Distribuidores”), con arreglo y de conformidad con los términos de esta garantía limitada (en lo sucesivo la “Garantía”), garantizan al comprador original (en lo sucesivo el “Comprador original”) que compró el producto especificado en este documento (en lo sucesivo el “Producto”) a EIZO o a sus Distribuidores, que EIZO y sus Distribuidores, a su propio criterio, repararán o sustituirán el Producto de forma gratuita si el Comprador original detecta dentro del periodo de la Garantía (indicado posteriormente) que el Producto no funciona correctamente o que se ha averiado durante el uso normal del mismo de acuerdo con las indicaciones del manual de instrucciones suministrado con el Producto (en lo sucesivo el “Manual del usuario”).

El periodo de validez de esta Garantía está limitado a (i) cinco (5) años a partir de la fecha de compra del Producto o (ii) a 30.000 horas de uso del Producto (en adelante designado como el “Periodo de Garantía”). EIZO y sus Distribuidores no tendrán ninguna responsabilidad ni obligación con respecto al Producto para con el Comprador original ni para con terceros que no sean las estipuladas en la presente Garantía.

EIZO y sus Distribuidores no estarán obligados a suministrar cualquier recambio del Producto una vez pasados siete (7) años desde que se deje de fabricar el mismo. Para la reparación del monitor, EIZO y los distribuidores utilizarán repuestos que cumplan con nuestros estándares de control de calidad.

La Garantía es válida sólo en los países y territorios donde están ubicados los Distribuidores. La Garantía no restringe ningún derecho legal del Comprador original.

A pesar de las estipulaciones de esta Garantía, EIZO y sus Distribuidores no tendrán obligación alguna bajo esta Garantía en ninguno de los casos expuestos a continuación:

- (a) Cualquier defecto del Producto causado por daños en el transporte, modificación, alteración, abuso, uso incorrecto, accidente, instalación incorrecta, desastre, mantenimiento incorrecto y/o reparación indebida realizada por un tercero que no sea EIZO o sus Distribuidores.
- (b) Cualquier incompatibilidad del Producto debida a posibles innovaciones técnicas y/o reglamentaciones.
- (c) Cualquier deterioro del sensor.
- (d) Cualquier deterioro en el rendimiento de la visualización causado por fallos en las piezas consumibles como el panel LCD y/o la "Backlight", etc. (p. ej. cambios de brillo, cambios de uniformidad del brillo, cambios de color, cambios de uniformidad del color, defectos de píxeles, incluyendo píxeles muertos, etc.).
- (e) Cualquier defecto del Producto causado por un equipo externo.
- (f) Cualquier defecto del Producto en el que haya sido alterado o borrado el número de serie original.
- (g) Cualquier deterioro normal del Producto, y en particular de las piezas consumibles, accesorios y demás (p. ej. botones, piezas giratorias, cables, Manual del usuario, etc.).
- (h) Cualquier deformación, decoloración y/o alabeo del exterior del Producto incluida la superficie del panel LCD.

Para obtener servicio en los términos de esta Garantía, el Producto deberá ser enviado por el Comprador original, a su Distribuidor local, con el transporte previamente pagado, en el embalaje original u otro embalaje adecuado que ofrezca el mismo grado de protección, asumiendo el riesgo de daños y/o pérdida del Producto durante el transporte. El Comprador original deberá presentar un comprobante de compra del Producto en el que se refleje la fecha de compra del mismo cuando lo solicite el servicio de Garantía.

El Periodo de garantía para cualquier Producto reemplazado y/o reparado en los términos de esta Garantía expirará al vencer el Periodo de garantía original.

EIZO O LOS DISTRIBUIDORES AUTORIZADOS DE EIZO NO SE RESPONSABILIZAN DE NINGÚN DAÑO O PÉRDIDA QUE PUEDAN SUFRIR LOS DATOS U OTRA INFORMACIÓN ALMACENADA EN CUALQUIER MEDIO O CUALQUIER PARTE DE CUALQUIER PRODUCTO DEVUELTO A EIZO O A LOS DISTRIBUIDORES DE EIZO PARA SU REPARACIÓN.

EIZO Y LOS DISTRIBUIDORES AUTORIZADOS DE EIZO NO OFRECEN NINGUNA OTRA GARANTÍA, IMPLÍCITA NI EXPLÍCITA, CON RESPECTO AL PRODUCTO Y A SU CALIDAD, RENDIMIENTO, COMERCIABILIDAD E IDONEIDAD PARA CUALQUIER USO EN PARTICULAR. EN NINGÚN CASO SERÁN EIZO O LOS DISTRIBUIDORES AUTORIZADOS DE EIZO RESPONSABLES DE NINGÚN DAÑO EMERGENTE, INDIRECTO, ESPECIAL, INHERENTE O CUALQUIERA QUE SEA (INCLUYENDO, SIN LIMITACIÓN, DAÑOS POR LUCRO CESANTE, INTERRUPCIÓN DE LA ACTIVIDAD COMERCIAL, PÉRDIDA DE INFORMACIÓN COMERCIAL O CUALQUIER OTRA PÉRDIDA PECUNIARIA) QUE SE DERIVE DEL USO O IMPOSIBILIDAD DE USO DEL PRODUCTO O EN RELACIÓN CON EL PRODUCTO, YA SEA BASADO EN CONTRATO, POR AGRAVIO, NEGLIGENCIA, ESTRICTA RESPONSABILIDAD O CUALQUIERA QUE SEA, AUN CUANDO SE HAYA ADVERTIDO A EIZO O A LOS DISTRIBUIDORES DE EIZO DE LA POSIBILIDAD DE TALES DAÑOS. ESTA EXCLUSIÓN TAMBIÉN ABARCA CUALQUIER RESPONSABILIDAD QUE PUEDA DERIVARSE DE RECLAMACIONES HECHAS POR UN TERCERO CONTRA EL COMPRADOR ORIGINAL. LA ESENCIA DE ESTA ESTIPULACIÓN ES LIMITAR LA RESPONSABILIDAD POTENCIAL DE EIZO Y LOS DISTRIBUIDORES QUE PUDIERA DERIVARSE DE ESTA GARANTÍA LIMITADA Y/O VENTAS.

GARANZIA LIMITATA

EIZO Corporation (a cui si farà riferimento da qui in poi con “**EIZO**”) ed i Distributori autorizzati da EIZO (a cui si farà riferimento da qui in poi con “**Distributori**”) garantiscono, secondo i termini di questa garanzia limitata (a cui si farà riferimento da qui in poi con “**Garanzia**”) all’acquirente originale (a cui si farà riferimento da qui in poi con “**Acquirente originale**”) che ha acquistato il prodotto specificato in questo documento (a cui si farà riferimento da qui in poi con “**Prodotto**”) da EIZO o dai suoi Distributori, che EIZO e i distributori, a loro discrezione, ripareranno o sostituiranno il Prodotto senza addebito se l’Acquirente originale trova, entro il periodo della Garanzia (definito sotto), che il Prodotto malfunziona e si è danneggiato nel corso del suo normale utilizzo osservando le indicazioni del manuale di istruzioni allegato al Prodotto (a cui si farà riferimento da qui in poi con “**Manuale utente**”).

La presente Garanzia è limitata a (i) cinque (5) anni a partire dalla data d’acquisto del Prodotto o (ii) allo scadere di 30.000 ore d’utilizzo del Prodotto (a cui si farà riferimento da qui in poi con “**Periodo di Garanzia**”). EIZO e i suoi Distributori non si assumono alcuna responsabilità e non hanno alcun obbligo riguardo al Prodotto verso l’Acquirente originale o terzi diversi da quelli relativi a questa Garanzia.

EIZO e i suoi Distributori cesseranno di tenere o di conservare qualsiasi ricambio del Prodotto allo scadere di sette (7) anni dopo che la produzione di tali ricambi è stata terminata. Per la riparazione del monitor, EIZO e i Distributori utilizzeranno parti di ricambio conformi ai nostri standard di controllo della qualità.

La Garanzia è valida soltanto nei paesi dove ci sono i Distributori EIZO. La Garanzia non limita alcun diritto legale dell’Acquirente originale.

Indipendentemente da qualsiasi altra condizione di questa Garanzia, EIZO e i suoi Distributori non avranno alcun obbligo derivante da questa Garanzia in ognuno dei casi elencati di seguito:

- (a) Qualsiasi difetto del Prodotto causato da danni di trasporto, modifiche, alterazioni, abusi, usi impropri, incidenti, installazione errata, calamità, manutenzione errata e/o riparazioni improprie eseguite da terze parti che non siano EIZO o i suoi Distributori.
- (b) Qualsiasi incompatibilità del Prodotto dovuta a possibili innovazioni tecniche e/o normative.
- (c) Qualsiasi deterioramento del sensore.
- (d) Qualsiasi deterioramento delle prestazioni dello schermo causato dal deterioramento delle parti consumabili, come il pannello LCD e/o la retroilluminazione, ecc. (per esempio: i cambiamenti di luminosità, cambiamenti di uniformità della luminosità, i cambiamenti di colore, i cambiamenti di uniformità del colore, i difetti dei pixel, inclusi i pixel bruciati, ecc.).
- (e) Qualsiasi difetto del Prodotto causato da apparecchiature esterne.
- (f) Qualsiasi difetto del Prodotto in cui il numero di serie originale sia stato alterato o rimosso.
- (g) Qualsiasi normale deterioramento del Prodotto, in particolar modo nelle sue parti di consumo, accessori, e/o attacchi (per esempio: tasti, parti rotanti, cavi, Manuale dell’utente, ecc.).
- (h) Qualsiasi tipo di deformazione, scolorimento, e/o di involucro esterno del Prodotto inclusa la superficie del pannello LCD.

Per ricevere assistenza tecnica con questa Garanzia, l’Acquirente originale deve inviare il Prodotto, con trasporto pre-pagato, nella sua confezione originale o altra confezione adeguata che fornisce un livello analogo di protezione, assumendosi il rischio di danni e/o perdita in transito, al Distributore locale. L’Acquirente originale deve presentare la prova di acquisto che stabilisce la data di acquisto del Prodotto quando richiede servizio sotto Garanzia.

Il Periodo di garanzia per qualsiasi Prodotto sostituito e/o riparato sotto questa Garanzia scade alla fine del Periodo di garanzia originale.

EIZO O I SUOI DISTRIBUTORI NON SONO RESPONSABILI PER QUALSIASI DANNO O PERDITA DI DATI O ALTRE INFORMAZIONI MEMORIZZATI SU QUALSIASI SUPPORTO O QUALSIASI PARTE DI QUALSIASI PRODOTTO INVIATO A EIZO O I SUOI DISTRIBUTORI PER RIPARAZIONI.

EIZO E I SUOI DISTRIBUTORI NON OFFRONO ALCUNA GARANZIA ADDIZIONALE, IMPLICITA O ESPLICITA, RIGUARDO IL PRODOTTO E LA SUA QUALITÀ, PRESTAZIONI, VENDIBILITÀ O APPROPRIATEZZA PER QUALSIASI USO PARTICOLARE. IN NESSUN CASO EIZO O I DISTRIBUTORI EIZO AUTORIZZATI SARANNO RESPONSABILI PER QUALSIASI DANNO ACCIDENTALE, INDIRETTO, SPECIALE, CONSEGUENTE O DI QUALSIASI ALTRA NATURA (INCLUSI, SENZA LIMITI, DANNI PER PERDITA DI PROFITTI, INTERRUZIONE DELLE ATTIVITÀ, PERDITA DI INFORMAZIONI D’AFFARI O QUALSIASI ALTRA PERDITA PECUNIARIA) DERIVANTI DALL’USO O DALL’IMPOSSIBILITÀ DI USARE IL PRODOTTO O IN QUALSIASI RELAZIONE AL PRODOTTO, SIA SU BASE DI CONTRATTO, TORTO, NEGLIGENZA, STRETTA RESPONSABILITÀ O ALTRIMENTI, ANCHE SE EIZO O I DISTRIBUTORI EIZO AUTORIZZATI SONO STATI AVVERTITI DELLA POSSIBILITÀ DI TALI DANNI. QUESTA ESCLUSIONE INCLUDE ANCHE QUALSIASI RESPONSABILITÀ CHE POSSA INSORGERE DA RECLAMI DI TERZI CONTRO L’ACQUIRENTE ORIGINALE. L’ESSENZA DI QUESTO PROVVEDIMENTO È LIMITARE LA RESPONSABILITÀ POTENZIALE DI EIZO E DEI DISTRIBUTORI DERIVANTE DA QUESTA GARANZIA LIMITATA E/O DALLE VENDITE.

BEGRÄNSAD GARANTI

EIZO Corporation (nedan kallat "**EIZO**") och EIZOs auktoriserade distributörer (nedan kallade "**Distributörer**") garanterar i enlighet med villkoren i denna begränsade garanti (nedan kallad "**Garantin**") den ursprunglige köparen (nedan kallad den "**Ursprunglige köparen**") som köpte den i dokumentet specificerade produkten (nedan kallad "**Produkten**") från EIZO eller Distributörer, att EIZO eller Distributörer enligt eget gottfinnande kostnadsfritt antingen reparera eller byta ut den defekta Produkten om den Ursprunglige köparen inom Garantiperioden (definieras nedan) upptäcker att Produkten fungerar felaktigt eller skadas under normal användning av Produkten i enlighet med beskrivningen i bruksanvisningen (nedan kallad "**Bruksanvisning**").

Giltighetsperioden för denna garanti är begränsad till (i) fem (5) år från datumet för Produktens inköp eller, om detta inträffar tidigare, begränsat till utlöpanget av (ii) 30 000 timmars användning av Produkten (häri kallad "**Garantiperioden**"). EIZO och Distributörer ska inte under några villkor ha något annat ansvar än vad som anges i denna garanti gällande Produkten i relation till den Ursprunglige köparen eller tredje part.

EIZO och Distributörer kommer att upphöra med lagerhållning av Produktens delar efter sju (7) år efter att produktionen av dessa delar upphört. När skärmen repareras använder EIZO och distributörer reservdelar som uppfyller våra kvalitetsstandarder.

Garantin är endast giltig i de länder där det finns Distributörer. Garantin begränsar inte några av den Ursprunglige köparens lagstadgade rättigheter.

Oavsett andra villkor i denna garanti ska inte EIZO Distributörer under några villkor ha något ansvar i något av de fall som beskrivs nedan:

- (a) När någon bristfällighet hos Produkten kan härledas till att ha uppstått vid frakt, modifiering, ändring, felaktigt handhavande, olycka, felaktig installation, katastrof, felaktigt underhåll och/eller felaktig reparation utförd av tredje part annan än EIZO och Distributörer.
- (b) Alla former av inkompatibilitet hos Produkten på grund av möjliga tekniska innovationer och/eller bestämmelser.
- (c) Alla försämringar av sensorn.
- (d) Alla försämringar av bildens prestanda beroende på förbrukningsdelar så som LCD-panel och/eller bakgrundsbelysning etc. (t.ex. ändringar i ljusstyrka, jämnhet i ljusstyrka, färg, färgjämnhet, defekta pixlar och/eller fast lysande pixlar etc.).
- (e) Alla defekter hos Produkten som orsakats av extern utrustning.
- (f) Alla defekter hos Produkten på vilken det ursprungliga serienumret har ändrats eller avlägsnats.
- (g) All normal försämring av Produkten, speciellt förbrukningsartiklar, tillbehör och/eller yttre delar (t.ex. knappar, roterande delar, kablar, Bruksanvisningen etc.).
- (h) Varje deformation, missfärgning och/eller skevhet av Produktens yttre inklusive ytan på LCD-panelen.

För att erhålla service under denna garanti måste den Ursprunglige köparen (med hänseende till risken för skada och/eller förlust under transport) leverera Produkten till närmaste Distributör med förebetalad frakt, i dess ursprungliga förpackning eller annan fullgod förpackning som ger likvärdigt skydd. Den Ursprunglige köparen måste kunna visa inköpsbevis för Produkten som klargör Produktens inköpsdatum vid begäran av garantiservice.

Garantiperioden för alla utbytta och/eller reparerade produkter under denna garanti skall upphöra vid utgången av den ursprungliga Garantiperioden.

EIZO ELLER DISTRIBUTÖRER ÄR INTE ANSVARIGA FÖR NÅGON FORM AV SKADA ELLER FÖRLUST AV DATA ELLER ANNAN INFORMATION SOM HAR LAGRATS I NÅGON FORM AV MEDIA ELLER ANNAN DEL AV NÅGON PRODUKT SOM HAR RETURNERATS TILL EIZO ELLER DISTRIBUTÖRER FÖR REPARATION.

EIZO OCH DISTRIBUTÖRERNA GARANTERAR INGET, UTTRYCKLIGEN ELLER UNDERFÖRSTÅTT, VAD BETRÄFFAR PRODUKTEN OCH DESS KVALITET, PRESTANDA, SÄLJBARHET ELLER LÄMPLIGHET FÖR NÅGON FORM AV SPECIELL ANVÄNDNING. UNDER INGA OMSTÄNDIGHETER SKALL EIZO ELLER DISTRIBUTÖRERNA HÅLLAS ANSVARIGA FÖR NÅGRA SOM HELST UNDERORDNADE, INDIREKTA, SPECIELLA, DÄRAV FÖLJANDE ELLER ÖVRIGA SKADOR (INKLUSIVE, UTAN BEGRÄNSNING TILL, SKADOR FÖR FÖRLUST AV INKOMST, AVBRUTEN AFFÄRSRÖRELSE, FÖRLUST AV AFFÄRSINFORMATION ELLER ANNAN SÄRSKILD FÖRLUST) SOM UPPSTÅTT SOM ETT RESULTAT AV ANVÄNDNING ELLER OFÖRMÅGA ATT ANVÄNDA PRODUKTEN ELLER I NÅGON FORM AV ANSLUTNING TILL PRODUKTERNA, VARE SIG DETTA GRUNDAS PÅ KONTRAKT, ÅTALBAR HANDLING, FÖRSUMLIGHET, ANSVARSSKYLDIGHET ELLER ANNAT, ÄVEN OM EIZO ELLER DISTRIBUTÖRERNA HAR INFORMERATS BETRÄFFANDE MÖJLIGHET ATT SÅDANA SKADOR FÖRELIGGER. DETTA UNDANTAG OMFATTAR ÄVEN ALL FORM AV ANSVARSSKYLDIGHET SOM KAN UPPSTÅ GENOM EN TREDJE PARTS ANSPRÅK GENTEMOT DEN URSPRUNGLIGE KÖPAREN. GRUNDBESTÄNDSDELEN I BESTÄMMELEN ÄR ATT BEGRÄNSA DET EVENTUELLA ANSVARSTAGANDET FÖR EIZO OCH DISTRIBUTÖRERNA SOM KAN UPPSTÅ GENOM DENNA BEGRÄNSADE GARANTI OCH/ELLER FÖRSÄLJNING.

ΠΕΡΙΟΡΙΣΜΕΝΗ ΕΓΓΥΗΣΗ

Η EIZO Corporation (στο εξής «**EIZO**») και οι διανομείς που εξουσιοδοτεί η EIZO (στο εξής «**Διανομείς**») παρέχουν εγγύηση, υποκείμενη και σύμφωνα με τους όρους της παρούσας περιορισμένης εγγύησης (στο εξής «**Εγγύηση**»), στον αρχικό αγοραστή (στο εξής «**Αρχικός Αγοραστής**») ο οποίος αγόρασε το προϊόν που καθορίζεται στο παρόν έγγραφο (στο εξής «**Προϊόν**») από την EIZO ή τους Διανομείς, η οποία εξασφαλίζει ότι η EIZO και οι Διανομείς, σύμφωνα με τη διακριτή ευχέρειά τους, είτε θα επισκευάσουν είτε θα αντικαταστήσουν το Προϊόν χωρίς χρέωση εάν ο Αρχικός Αγοραστής αντιληφθεί εντός της Περιόδου Εγγύησης (ορίζεται κατωτέρω) ότι το Προϊόν δυσλειτουργεί ή έχει υποστεί βλάβη κατά τη διάρκεια κανονικής χρήσης του Προϊόντος σύμφωνα με την περιγραφή στο εγχειρίδιο χρήσης που συνοδεύει το Προϊόν (στο εξής «**Εγχειρίδιο Χρήστη**»).

Η περίοδος της παρούσας Εγγύησης είναι (i) πέντε (5) έτη από την ημερομηνία αγοράς του Προϊόντος, ή, στη λήξη των (ii) 30.000 ωρών χρήσης του Προϊόντος (στο εξής «**Περίοδος Εγγύησης**»). Η EIZO και οι Διανομείς δεν φέρουν καμία ευθύνη ή υποχρέωση όσον αφορά το Προϊόν σε σχέση με τον Αρχικό Αγοραστή ή οποιοδήποτε τρίτο μέρος, ούτε άλλη ευθύνη διαφορετική από αυτήν που παρέχεται στην παρούσα Εγγύηση.

Η EIZO και οι Διανομείς θα παύσουν να διατηρούν ή να αποθηκεύουν τυχόν εξαρτήματα του Προϊόντος κατόπιν της λήξης των επτά (7) ετών μετά τη διακοπή της παραγωγής τέτοιων εξαρτημάτων. Κατά την επισκευή της οθόνης, η EIZO και οι Διανομείς θα χρησιμοποιήσουν ανταλλακτικά επισκευής που συμμορφώνονται με τα πρότυπά μας για τη Διασφάλιση Ποιότητας.

Η Εγγύηση ισχύει μόνο σε χώρες ή περιοχές όπου βρίσκονται οι Διανομείς. Η Εγγύηση δεν περιορίζει οποιαδήποτε νόμιμα δικαιώματα του Αρχικού Αγοραστή.

Λαμβανομένης υπόψη κάθε διάταξης της παρούσας Εγγύησης, η EIZO και οι Διανομείς δεν θα έχουν καμία απολύτως υποχρέωση σύμφωνα με την παρούσα Εγγύηση σε οποιαδήποτε από τις περιπτώσεις που διατυπώνονται κατωτέρω:

- (α) Τυχόν ελάττωμα του Προϊόντος που προκαλείται από ζημιά κατά τη μεταφορά, τροποποίηση, αλλαγή, κατάχρηση, λανθασμένη χρήση, ατύχημα, λανθασμένη εγκατάσταση, καταστροφή, εσφαλμένη συντήρηση ή/και λανθασμένη επισκευή από τρίτο μέρος εκτός της EIZO και των Διανομέων,
- (β) Τυχόν ασυμβατότητα του Προϊόντος λόγω πιθανών τεχνικών καινοτομιών ή/και κανονισμών,
- (γ) Τυχόν επιδείνωση του αισθητήρα,
- (δ) Τυχόν επιδείνωση της απόδοσης οθόνης που προκαλείται από τη φθορά αναλώσιμων εξαρτημάτων όπως της οθόνης LCD ή/και του φωτός υποβάθρου, κτλ. (π.χ. αλλαγές στη φωτεινότητα, αλλαγές στην ομοιομορφία φωτεινότητας, αλλαγές στο χρώμα, αλλαγές στην ομοιομορφία χρώματος, ελαττώματα σε pixel περιλαμβανομένων των καμένων pixel, κτλ.),
- (ε) Τυχόν ελάττωμα του Προϊόντος που προκαλείται από εξωτερικό εξοπλισμό,
- (στ) Τυχόν ελάττωμα του Προϊόντος στο οποίο έχει τροποποιηθεί ή αφαιρεθεί ο γνήσιος αριθμός σειράς,
- (ζ) Τυχόν φυσιολογική φθορά του προϊόντος, ιδιαίτερα αυτής των αναλώσιμων, των αξεσουάρ ή/και των προσαρτημάτων (π.χ. κουμπιά, περιστρεφόμενα μέρη, καλώδια, Εγχειρίδιο Χρήστη, κτλ.), και
- (η) Τυχόν παραμόρφωση, αποχρωματισμό ή/και διαστρέβλωση του εξωτερικού μέρους του προϊόντος, περιλαμβανομένης της επιφάνειας της οθόνης LCD.

Ο Αρχικός Αγοραστής για να δικαιούται υπηρεσίες επισκευής σύμφωνα με την Εγγύηση, θα πρέπει να παραδώσει το Προϊόν, με πληρωμένα τα μεταφορικά έξοδα, στην αρχική του συσκευασία ή σε άλλη επαρκή συσκευασία με ισότιμο βαθμό προστασίας, αναλαμβάνοντας τον κίνδυνο βλάβης ή/και απώλειας κατά τη μεταφορά, στον τοπικό Διανομέα. Ο Αρχικός Αγοραστής όταν ζητά υπηρεσίες επισκευής σύμφωνα με την Εγγύηση, θα πρέπει να προσκομίζει την απόδειξη αγοράς του Προϊόντος και την ημερομηνία της αγοράς.

Η Περίοδος Εγγύησης για οποιοδήποτε αντικατεστημένο ή/και επισκευασμένο προϊόν σύμφωνα με την παρούσα Εγγύηση λήγει στο τέλος της αρχικής Περιόδου Εγγύησης.

Η EIZO Ή ΟΙ ΔΙΑΝΟΜΕΙΣ ΔΕΝ ΕΥΘΥΝΟΝΤΑΙ ΓΙΑ ΟΠΟΙΑΔΗΠΟΤΕ ΒΛΑΒΗ Ή ΑΠΩΛΕΙΑ ΔΕΔΟΜΕΝΩΝ Ή ΑΛΛΩΝ ΠΛΗΡΟΦΟΡΙΩΝ ΠΟΥ ΑΠΟΘΗΚΕΥΟΝΤΑΙ ΣΕ ΟΠΟΙΟΔΗΠΟΤΕ ΜΕΣΟ Ή ΟΠΟΙΟΔΗΠΟΤΕ ΑΛΛΟ ΜΕΡΟΣ ΣΕ ΟΠΟΙΟΔΗΠΟΤΕ ΠΡΟΪΟΝ ΠΟΥ ΕΠΙΣΤΡΕΦΕΤΑΙ ΣΤΗΝ EIZO Ή ΣΕ ΔΙΑΝΟΜΕΑ ΓΙΑ ΕΠΙΣΚΕΥΗ.

Η EIZO ΚΑΙ ΟΙ ΔΙΑΝΟΜΕΙΣ ΔΕΝ ΠΑΡΕΧΟΥΝ ΚΑΜΙΑ ΠΕΡΑΙΤΕΡΩ ΕΓΓΥΗΣΗ, ΡΗΤΗ Ή ΣΥΝΕΠΑΓΟΜΕΝΗ, ΟΣΟΝ ΑΦΟΡΑ ΤΟ ΠΡΟΪΟΝ ΚΑΙ ΤΗΝ ΠΟΙΟΤΗΤΑ, ΤΗΝ ΑΠΟΔΟΣΗ, ΤΗΝ ΕΜΠΟΡΕΥΣΙΜΟΤΗΤΑ Ή ΤΗΝ ΚΑΤΑΛΛΗΛΟΤΗΤΑ ΤΟΥ ΓΙΑ ΟΠΟΙΟΔΗΠΟΤΕ ΣΥΓΚΕΚΡΙΜΕΝΗ ΧΡΗΣΗ. ΣΕ ΚΑΜΙΑ ΠΕΡΙΠΤΩΣΗ Η EIZO Ή ΟΙ ΔΙΑΝΟΜΕΙΣ ΔΕΝ ΘΑ ΕΥΘΥΝΟΝΤΑΙ ΓΙΑ ΚΑΜΙΑ ΑΠΟΛΥΤΩΣ ΤΥΧΑΙΑ, ΕΜΜΕΣΗ, ΕΙΔΙΚΗ, ΣΥΝΕΠΑΓΟΜΕΝΗ Ή ΑΛΛΗ ΒΛΑΒΗ (ΠΕΡΙΛΑΜΒΑΝΟΜΕΝΩΝ, ΜΕΤΑΞΥ ΑΛΛΩΝ, ΒΛΑΒΩΝ Ή ΑΠΩΛΕΙΑΣ ΚΕΡΔΩΝ, ΔΙΑΚΟΠΗΣ ΕΠΙΧΕΙΡΗΜΑΤΙΚΩΝ ΔΡΑΣΤΗΡΙΟΤΗΤΩΝ, ΑΠΩΛΕΙΑΣ ΕΠΙΧΕΙΡΗΜΑΤΙΚΩΝ ΠΛΗΡΟΦΟΡΙΩΝ Ή ΤΥΧΟΝ ΑΛΛΗΣ ΧΡΗΜΑΤΙΚΗΣ ΑΠΩΛΕΙΑΣ) ΠΟΥ ΠΡΟΚΥΠΤΕΙ ΑΠΟ ΤΗ ΧΡΗΣΗ Ή ΤΗΝ ΑΝΙΚΑΝΟΤΗΤΑ ΧΡΗΣΗΣ ΤΟΥ ΠΡΟΪΟΝΤΟΣ Ή ΤΥΧΟΝ ΑΛΛΗΣ ΣΥΝΔΕΣΗΣ ΜΕ ΤΟ ΠΡΟΪΟΝ, ΕΙΤΕ ΒΑΣΙΖΕΤΑΙ ΣΕ ΣΥΜΒΟΛΑΙΟ, ΒΛΑΒΗ, ΑΜΕΛΕΙΑ, ΑΥΣΤΗΡΗ ΕΥΘΥΝΗ Ή ΕΙΔΑΛΛΩΣ, ΑΚΟΜΗ ΚΙ ΕΑΝ Η EIZO Ή ΟΙ ΔΙΑΝΟΜΕΙΣ ΕΝΗΜΕΡΩΘΟΥΝ ΓΙΑ ΤΗΝ ΠΙΘΑΝΟΤΗΤΑ ΤΕΤΟΙΩΝ ΖΗΜΙΩΝ. Η ΕΞΑΙΡΕΣΗ ΑΥΤΗ ΠΕΡΙΛΑΜΒΑΝΕΙ ΕΠΙΣΗΣ ΟΠΟΙΟΔΗΠΟΤΕ ΕΥΘΥΝΗ ΕΝΔΕΧΕΤΑΙ ΝΑ ΠΡΟΚΥΨΕΙ ΑΠΟ ΑΞΙΩΣΕΙΣ ΤΡΙΤΟΥ ΜΕΡΟΥΣ ΚΑΤΑ ΤΟΥ ΑΡΧΙΚΟΥ ΑΓΟΡΑΣΤΗ. Η ΟΥΣΙΑ ΤΟΥ ΟΡΟΥ ΑΥΤΟΥ ΕΙΝΑΙ ΝΑ ΠΕΡΙΟΡΙΣΕΙ ΤΗΝ ΠΙΘΑΝΗ ΕΥΘΥΝΗ ΤΗΣ EIZO ΚΑΙ ΤΩΝ ΔΙΑΝΟΜΕΩΝ ΠΟΥ ΠΡΟΚΥΠΤΕΙ ΑΠΟ ΤΗΝ ΠΑΡΟΥΣΑ ΕΓΓΥΗΣΗ Ή/ΚΑΙ ΤΙΣ ΠΩΛΗΣΕΙΣ.

ОГРАНИЧЕННАЯ ГАРАНТИЯ

EIZO Corporation (называемая в дальнейшем “EIZO”) и авторизованные EIZO дистрибуторы (называемые в дальнейшем “Дистрибуторы”) гарантируют, в соответствии с условиями и пунктами этой ограниченной гарантии (называемой в дальнейшем “Гарантия”), первичному покупателю (называемому в дальнейшем “Первоначальный покупатель”), который приобрел у EIZO или Дистрибуторов продукт, указанный в этом документе (называемый в дальнейшем “Продукт”), что EIZO или Дистрибуторы на свое усмотрение либо бесплатно отремонтируют, либо бесплатно заменят Продукт, если Первоначальный покупатель признает в пределах Гарантийного срока (определенного ниже), что Продукт неисправен или он поврежден процессе нормального использования продукта в соответствии с описанием в инструкции по эксплуатации, прилагаемой к Продукту (называемой в дальнейшем “Руководство пользователя”).

Гарантийный период ограничен сроком (i) пять (5) лет от даты приобретения Продукта или ограничен сроком (ii) 30 000 часов использования Продукта (называемый в дальнейшем “Гарантийный период”). EIZO и Дистрибуторы не несут никакой ответственности и не берут обязательств относительно Продукта по отношению к Первоначальному покупателю или по отношению к любым третьим сторонам, кроме обязательств, оговоренных в этой Гарантии.

EIZO и Дистрибуторы прекратят хранение или складирование любых деталей Продукта по истечении семи (7) лет после прекращения производства таких деталей. В случае ремонта монитора EIZO и Дистрибуторы будут использовать запчасти, которые соответствуют нашим стандартам QC (контроль качества).

Гарантия действительна только в странах или регионах, где расположены Дистрибуторы. Гарантия не ограничивает никакие законные права Первоначального покупателя.

Несмотря на другие условия этой Гарантии EIZO и Дистрибуторы не несут никаких обязательств согласно этой Гарантии в любом из перечисленных ниже случаев:

- (а) Любые дефекты Продукта, вызванные повреждениями при перевозке, модификацией, изменением, неправильным обращением, неправильным использованием, авариями, неправильной установкой, стихийными бедствиями, неправильным уходом и/или неправильным ремонтом третьей стороной, отличной от EIZO или Дистрибуторов;
- (б) Любые несовместимости Продукта из-за технических усовершенствований и/или изменения технических норм;
- (в) Любое повреждение датчика;
- (г) Любые ухудшения работы дисплея, вызванные изнашиванием невосстановимых частей, таких как панель ЖКД и/или подсветка и т.д. (например, изменение в яркости, изменение в равномерности яркости, изменение в цветности, изменение в равномерности цветности, изменение в пикселях, включая выгоревшие пиксели и т.д.);
- (д) Любые дефекты Продукта, вызванные внешним оборудованием;
- (е) Любые дефекты Продукта, при которых оригинальный серийный номер был изменен или удален;
- (ж) Любые естественные ухудшения продукта, в частности, вызванные износом расходных частей, принадлежностей и/или приспособлений (например, кнопок, вращающихся частей, кабелей, Руководства пользователя и т.д.); и
- (з) Любые деформации, изменения цвета и/или коробления внешней поверхности продукта, включая поверхность панели ЖКД.

Чтобы получить техническое обслуживание в рамках Гарантии, Первоначальный покупатель должен доставить Продукт местному Дистрибутору, оплатив перевозку, в его оригинальной упаковке или в другой соответствующей упаковке, обеспечивающей равноценную степень защиты, принимая во внимание риск повреждения и/или утерю при транспортировке. При запросе технического обслуживания в рамках Гарантии Первоначальный покупатель должен предоставить свидетельство покупки продукта и даты покупки.

Гарантийный период для любого замененного и/или отремонтированного продукта в рамках Гарантии истекает в конце завершения срока действия оригинального Гарантийного периода.

EIZO или ДИСТРИБУТОРЫ НЕ НЕСУТ ОТВЕТСТВЕННОСТИ ЗА ЛЮБЫЕ ПОВРЕЖДЕНИЯ ИЛИ УТЕРЮ ДАННЫХ ИЛИ ДРУГОЙ ИНФОРМАЦИИ, ХРАНЯЩИХСЯ НА КАКИХ-ЛИБО НОСИТЕЛЯХ ИНФОРМАЦИИ ИЛИ НА ЛЮБЫХ ДРУГИХ ЧАСТЯХ ПРОДУКТА, КОТОРЫЙ ВОЗВРАЩЕН EIZO или ДИСТРИБУТОРАМ ДЛЯ РЕМОНТА.

EIZO и ДИСТРИБУТОРЫ НЕ ДАЮТ НИКАКОЙ ДАЛЬНЕЙШЕЙ ГАРАНТИИ, ВЫРАЖЕННОЙ ИЛИ ПОДРАЗУМЕВАЕМОЙ, ОТНОСИТЕЛЬНО ПРОДУКТА И ЕГО КАЧЕСТВА, ТЕХНИЧЕСКИХ ХАРАКТЕРИСТИК, ТОВАРНОСТИ ИЛИ СООТВЕТСТВИЯ ДЛЯ КАКОГО-ЛИБО ОПРЕДЕЛЕННОГО ИСПОЛЬЗОВАНИЯ. НИ ПРИ КАКИХ УСЛОВИЯХ EIZO или ДИСТРИБУТОРЫ НЕ НЕСУТ ОТВЕТСТВЕННОСТИ ЗА ЛЮБОЙ СЛУЧАЙНЫЙ, КОСВЕННЫЙ, СПЕЦИАЛЬНЫЙ, ПОБОЧНЫЙ ИЛИ ИНОЙ УЩЕРБ (ВКЛЮЧАЯ, БЕЗ ОГРАНИЧЕНИЙ, УЩЕРБ ИЗ-ЗА НЕПОЛУЧЕННОЙ ПРИБЫЛИ, ПРЕРЫВАНИЯ БИЗНЕСА, ПОТЕРИ КОММЕРЧЕСКОЙ ИНФОРМАЦИИ ИЛИ ЛЮБЫЕ ДРУГИЕ ФИНАНСОВЫЕ ПОТЕРИ), ВОЗНИКШИЙ ИЗ-ЗА ИСПОЛЬЗОВАНИЯ ИЛИ НЕВОЗМОЖНОСТИ ИСПОЛЬЗОВАТЬ ПРОДУКТ ИЛИ В ЛЮБОЙ ДРУГОЙ СВЯЗИ С ПРОДУКТОМ, ЛИБО ОСНОВАННЫЙ НА КОНТРАКТНЫХ ОТНОШЕНИЯХ, ГРАЖДАНСКИХ ПРАВОНАРУШЕНИЯХ, НЕБРЕЖНОСТИ, ПРИЧИНЕНИЯ УЩЕРБА ТРЕТЬЕЙ СТОРОНЕ ИЛИ ЧЕМ-ЛИБО ЕЩЕ, ДАЖЕ ЕСЛИ EIZO или ДИСТРИБУТОРЫ БЫЛИ УВЕДОМЛЕННЫ О ВОЗМОЖНОСТИ ТАКОГО УЩЕРБА. ЭТО ИСКЛЮЧЕНИЕ ТАКЖЕ ВКЛЮЧАЕТ ЛЮБЫЕ ОБЯЗАТЕЛЬСТВА, КОТОРЫЕ МОГУТ ВОЗНИКНУТЬ В РЕЗУЛЬТАТЕ ТРЕБОВАНИЙ ТРЕТЬЕЙ СТОРОНЫ В ОТНОШЕНИИ ПЕРВОНАЧАЛЬНОГО ПОКУПАТЕЛЯ. СУЩЕСТВОМ ЭТОГО ПОЛОЖЕНИЯ ЯВЛЯЕТСЯ ОГРАНИЧЕНИЕ ПОТЕНЦИАЛЬНОЙ ОТВЕТСТВЕННОСТИ EIZO и ДИСТРИБУТОРОВ, ВОЗНИКАЮЩЕЙ ИЗ-ЗА ЭТОЙ ОГРАНИЧЕННОЙ ГАРАНТИИ И/ИЛИ ПРОДАЖ.

有限保证责任书

EIZO Corporation (以下简称“EIZO”)和 EIZO 授权的经销商 (以下简称“经销商”), 接受并依照本有限保证责任书 (以下简称“保证书”)之条款, 向从 EIZO 和经销商购买本文中所规定产品 (以下简称“产品”)的原买方 (以下称“原买方”)提供保证:在保证期内 (规定如下), 如果原买方发现按本产品所附使用说明书 (以下简称“用户手册”)所述方式正常使用本产品过程中, 本产品出现故障或损坏, EIZO 和经销商根据其独立的判断免费修理或更换该产品。

本保证期限定为(i)自本产品购买之日起的五(5)年期间或限定为到达(ii)使用本产品 3 万小时的期限(以下简称“保证期限”)。EIZO 和经销商将不向原买方或任何第三方承担本保证书所规定之外的与本产品有关的任何责任或义务。

本产品的任何部件停产七(7)年后, EIZO 和经销商将不再保留或保管任何这类部件。维修显示器时, EIZO 与经销商将使用符合我方质量控制标准的替换零件。

本保证书仅对于设有经销商的国家或地区有效。本保证书并不限定原买方的任何法律权利。

无论本保证书的任何其他条款如何规定, 对于任何下列情况之一, EIZO 和经销商将不承担本保证书规定责任:

- (a) 由于运输损害、改装、改动、滥用、误用、意外事故、错误安装、灾害、维护不善和 / 或由除 EIZO 和经销商以外的第三方进行不适当的修理造成本产品的任何故障。
- (b) 由于可能发生的技术变更和 / 或调整造成本产品的任何不兼容性。
- (c) 传感器的任何劣化。
- (d) 由于诸如液晶显示屏 (LCD) 和 / 或背灯等消耗品部件的老化造成的任何显示性能低劣 (如亮度变化、亮度均一性变化、色彩变化、色彩均一性变化、如烧伤像素等像素缺陷)。
- (e) 因外部设备造成本产品的任何故障。
- (f) 因本产品的原序号被改变或消除造成本产品的任何故障。
- (g) 本产品的任何正常老化, 尤其是消耗品、附件和 / 或附加装置 (如按钮、旋转部件、电缆、用户手册等)、以及
- (h) 本产品表面包括液晶显示屏 (LCD) 表面的任何变形、变色和 / 翘曲。

为了获得本保证书规定的服务, 原买方必须使用原包装或其他具有同等保护程度的适当包装将本产品运送到当地的经销商, 并且预付运费, 承担运输中的损坏和 / 或损失的风险。要求提供本保证书规定的服务时, 原买方必须提交购买本产品和标明此购买日期的证明。

按本保证书规定进行了更换和 / 或修理的任何产品的保证期限, 将在原保证期限结束时终止。

在返回给 EIZO 和经销商进行修理后, 任何产品的任何媒体或任何部件中储存的数据或其他信息发生任何损坏或损失, 对此 EIZO 和经销商将不承担责任。

对于本产品及其质量、性能、可销售性以及对于特殊用途的适合性, EIZO 和经销商不提供其他任何明示或暗示的保证。因使用本产品或无法使用本产品或因与本产品有任何关系 (无论是否根据合同) 而造成:任何附带的、间接的、特殊的、随之发生的或其他的损害 (包括但不限于 利润损失、业务中断、业务信息丢失或其他任何金钱损失) 以及侵权行为、过失、严格赔偿责任或其他责任, 即使已经向 EIZO 和经销商提出了发生这些损害的可能性, 对此 EIZO 和经销商概不承担责任。本免责条款还包括因第三方向原买方提出索赔而可能发生的任何责任。本条款的本质是限定由于本有限保证责任书和 / 或销售本产品所发生的 EIZO 和经销商的潜在责任。

Recycling Information

Recycling Information

This product, when disposed of, is supposed to be collected and recycled according to your country's legislation to reduce environmental burden. When you dispose of this product, please contact a distributor or an affiliate in your country.

The contact addressees are listed on the EIZO website below.

<http://www.eizo.com>

For recycling information for customers in Switzerland, please refer to the following website.

<http://www.swico.ch>

Informationen zum Thema Recycling

Dieses Produkt muss gemäß den Vorschriften Ihres Landes zur Entlastung der Umwelt recyclet werden. Wenden Sie sich bei der Entsorgung dieses Produkts an einen Verteiler oder eine Tochtergesellschaft in Ihrem Land.

Die Adressen zur Kontaktaufnahme sind auf der unten angegebenen Website von EIZO aufgeführt.

<http://www.eizo.com>

Kunden in der Schweiz entnehmen Informationen zum Recycling der folgenden Website:

<http://www.swico.ch>

Informations sur le recyclage

Ce produit doit être jeté aux points de collecte prévus à cet effet et recyclé conformément à la législation de votre pays, afin de réduire l'impact sur l'environnement. Lorsque vous jetez ce produit, veuillez contacter un distributeur ou une société affiliée de votre pays.

Les adresses des distributeurs sont répertoriées sur le site Web EIZO ci-dessous.

<http://www.eizo.com>

Pour les clients en Suisse, veuillez consulter le site Web suivant afin d'obtenir des informations sur le recyclage.

<http://www.swico.ch>

Información sobre reciclaje

Este producto debe desecharse y reciclarse según la legislación del país para reducir el impacto medioambiental. Cuando desee deshacerse de este producto, póngase en contacto con un distribuidor o una filial de su país.

Encontrará las direcciones de contacto en el sitio web de EIZO que se indica a continuación.

<http://www.eizo.com>

Informazioni sul riciclaggio

Per lo smaltimento e il riciclaggio del presente prodotto, attenersi alle normative vigenti nel proprio paese per ridurre l'impatto ambientale. Per lo smaltimento, rivolgersi ad un distributore o un affiliato presenti nel proprio paese.

Gli indirizzi sono elencati nel sito Web EIZO riportato di seguito.

<http://www.eizo.com>

Per informazioni sul riciclaggio per i clienti in Svizzera, consultare il sito Web riportato di seguito.

<http://www.swico.ch>

Återvinningsinformation

När denna produkt kasseras ska den hanteras och återvinnas enligt landets föreskrifter för att reducera miljöpåverkan. När du kasserar produkten ska du kontakta en distributör eller representant i ditt land.

Kontaktadresserna listas på EIZO-webbplatsen nedan.

<http://www.eizo.com>

Πληροφορίες ανακύκλωσης

Το προϊόν αυτό, όταν απορρίπτεται, πρέπει να συλλέγεται και να ανακυκλώνεται σύμφωνα με τη νομοθεσία της χώρας σας έτσι ώστε να μην επιβαρύνει το περιβάλλον. Για να απορρίψετε το προϊόν, επικοινωνήστε με έναν αντιπρόσωπο ή μια θυγατρική εταιρεία στη χώρα σας.

Οι διευθύνσεις επικοινωνίας αναγράφονται στην τοποθεσία web της EIZO παρακάτω.

<http://www.eizo.com>

Сведения по утилизации

По истечении срока службы данного продукта его следует принести на сборный пункт и утилизировать в соответствии с действующими предписаниями в вашей стране, чтобы уменьшить вредное воздействие на окружающую среду. Прежде чем выбросить данный продукт, обратитесь к дистрибьютору или в местное представительство компании в вашей стране.

Контактные адреса можно найти на веб-узле EIZO.

<http://www.eizo.com>

Informatie over recycling

Wanneer u dit product wilt weggooien, moet het uit milieu-overwegingen worden verzameld en gerecycled volgens de betreffende wetgeving van uw land. Wanneer u dit product wilt weggooien, moet u contact opnemen met een distributeur of een partner in uw land.

De contactadressen worden vermeld op de volgende EIZO-website.

<http://www.eizo.com>

Informação sobre reciclagem

Este produto, quando o deitar fora, deve ser recolhido e reciclado de acordo com a legislação do seu país para reduzir a poluição. Quando deitar fora este produto, contacte um distribuidor ou uma filial no seu país.

Os endereços de contacto estão listados no website do EIZO, abaixo.

<http://www.eizo.com>

Oplysninger om genbrug

Denne produkt forventes ved bortskaffelse at blive indsamlet og genbrugt i overensstemmelse med lovgivningen i dit land for at reducere belastningen af miljøet. Når du bortskaffer denne produkt, skal du kontakte en distributør eller et tilknyttet selskab i dit land.

Adresserne på kontaktpersonerne er angivet på EIZO's websted nedenfor.

<http://www.eizo.com>

Kierrätystä koskevia tietoja

Tuote tulee hävittää kierrättämällä maan lainsäädännön mukaisesti ympäristön kuormittumisen vähentämiseksi. Kun hävität tuotteen, ota yhteyttä jälleenmyyjään tai tytäryhtiöön maassasi.

Yhteystiedot löytyvät EIZOn Internet-sivustolta.

<http://www.eizo.com>

Wykorzystanie surowców wtórnych

Ten produkt po zużyciu powinien być zbierany i przetwarzany zgodnie z krajowymi przepisami dotyczącymi ochrony środowiska. Wyrzucając ten produkt, należy skontaktować się z lokalnym dystrybutorem lub partnerem. Adresy kontaktowe można znaleźć we wskazanej poniżej witrynie internetowej firmy EIZO.

<http://www.eizo.com>

Informace o recyklaci

Při likvidaci produktu musí být produkt vyzvednut a recyklován podle zákonů příslušné země, aby nedocházelo k zatěžování životního prostředí. Zbavujete-li se produktu, kontaktujte distributora nebo pobočku ve své zemi. Kontaktní adresy jsou uvedeny na následující webové stránce společnosti EIZO.
<http://www.eizo.com>

Ringlussevõtu alane teave

Keskkonnakoormuse vähendamiseks tuleks kasutatud tooted kokku koguda ja võtta ringlusse vastavalt teie riigi seadustele. Kui kõrvaldate käesoleva toote, võtke palun ühendust turustaja või filiaaliga oma riigis. Kontaktisikud on toodud EIZO veebilehel järgmisel aadressil:
<http://www.eizo.com>

Újrahasznosítási információ

Jelen terméket, amikor eldobjuk, az illető ország törvényei alapján kell összegyűjteni és újrahasznosítani, hogy csökkentsük a környezet terhelését. Amikor ezt a terméket eldobja, kérjük lépjen kapcsolatba egy országon belüli forgalmazóval vagy társvállalkozással.
A kapcsolat címei az EIZO alábbi weboldalán találhatók felsorolva:
<http://www.eizo.com>

Podatki o recikliranju

Ob koncu uporabe odslužen izdelek izročite na zbirno mesto za recikliranje v skladu z okoljevarstveno zakonodajo vaše države. Prosimo, da se pri odstranjevanju izdelka obrnete na lokalnega distributerja ali podružnico.
Kontaktne naslovi so objavljeni na spodaj navedenih spletnih straneh EIZO:
<http://www.eizo.com>

Informácie o recyklácii

Pri likvidácii musí byť tento výrobok recyklovaný v súlade s legislatívou vašej krajiny, aby sa znížilo zaťaženie životného prostredia. Keď sa chcete zbaviť tohto výrobku, kontaktujte prosím distribútora alebo pobočku vo vašej krajine.
Zoznam kontaktných adries je uvedený na nasledovnej webovej stránke firmy EIZO:
<http://www.eizo.com>

Pārstrādes informācija

Utilizējot šo produktu, tā savākšana un pārstrāde veicama atbilstoši jūsu valsts likumdošanas prasībām attiecībā uz slodzes uz vidi samazināšanu. Lai veiktu šī produkta utilizāciju, sazinieties ar izplatītāju vai pārstāvniecību jūsu valstī.
Kontaktadrese ir norādītas zemāk minētajā EIZO tīmekļa vietnē.
<http://www.eizo.com>

Informacja apie gražinamąjį perdirbimą

Šalinant (išmetant) šiuos gaminius juos reikia surinkti ir perdirbti gražinamuju būdu pagal jūsų šalies teisės aktus, siekiant sumažinti aplinkos teršimą. Kai reikia išmesti šį gaminį, kreipkitės į jūsų šalyje veikiančią gaminių pardavimo atstovybę arba jos filiaalą.
Kontaktiniai adresatai nurodyti EIZO interneto svetainėje.
<http://www.eizo.com>

Информация относно рециклиране

При изхвърлянето на този продукт се предлага събирането и рециклирането му съобразно законите на вашата страна за да се намали замърсяването на околната среда. Когато искате да се освободите от този продукт, моля свържете се с търговския му представител или със съответните органи отговарящи за това във вашата страна.

Данните за връзка с нас са описани на следния Интернет сайт на EIZO:
<http://www.eizo.com>

Informație referitoare la reciclare

Acest produs, când debarasat, trebuie colectat și reciclat conform legislației țării respective ca să reducem sarcina mediului. Când se debarasează de acest produs, vă rugăm să contactați un distribuitor sau un afiliat al țării respective.

Adresele de contact le găsiți pe pagina de web al EIZO:
<http://www.eizo.com>

معلومات عن إعادة التدوير

عند التخلص من هذا المنتج، من الضروري تجميعه وإعادة تدويره وفقاً للقوانين المتبعة في بلدك لتقليل العبء المسلط على البيئة. عندما تتخلص من هذا المنتج، يرجى الاتصال بموزع أو طرف متنسب إليه في بلدك. عناوين الاتصال مدرجة في موقع ايزو EIZO ادناه على شبكة الانترنت.

<http://www.eizo.com>

Geri Dönüşüm Bilgisi

Bu ürünün, atılacağı zaman, ülkenizin çevre kirliliğinin azaltılması konusundaki mevzuatına göre toplanması ve yeniden değerlendirilmesi gerekmektedir. Ürünü atacağınız zaman lütfen ülkenizdeki bir distribütör veya ilgili kuruluşla temasa geçiniz.

İrtibat adresleri aşağıdaki EIZO web sitesinde verilmiştir.
<http://www.eizo.com>

China Measures for RoHS Compliance in ChinaRoHS

关于电子信息产品污染控制标识



本标识根据「电子信息产品污染控制管理办法」，适用于在中华人民共和国销售的电子信息产品。标识中央的数字为环保使用期限的年数。只要您遵守该产品相关的安全及使用注意事项，在自制造日起算的年限内，不会产生对环境污染或人体及财产的影响。上述标识粘贴在机器背面。

• 有毒有害物质或元素的名称及含量

部件名称	有毒有害物质或元素					
	铅 (Pb)	汞 (Hg)	镉 (Cd)	六价铬 (Cr (VI))	多溴联苯 (PBB)	多溴二苯醚 (PBDE)
印刷电路板	×	○	○	○	○	○
机箱	○	○	○	○	○	○
液晶显示器	×	○	○	○	○	○
其他	×	○	○	○	○	○

○：表示该有毒有害物质在该部件所有均质材料中的含量均在 SJ/T 11363-2006 规定的限量要求以下。
×：表示该有毒有害物质至少在该部件的某一均质材料中的含量超出 SJ/T 11363-2006 规定的限量要求。
(企业可在此处，根据实际情况对上表中打“×”的技术原因进行进一步说明)

