

**INSTALLATION AND OPERATOR
MAINTENANCE MANUAL
FOR**

**Micom Pathfinder
5 - 25 Watt HF-SSB
Manpack Transceiver**

Revision C

NOVEMBER 2010

WARNINGS, CAUTIONS AND NOTES

The following notations are used to place special emphasis on procedures, or to call attention to precautionary measures.

WARNING

An operating procedure, practice and so forth, which if not followed correctly, could result in personal injury, or loss of life.

CAUTION

An operating procedure, practice and so forth, which if not followed correctly, could result in damage to, or destruction of equipment.

NOTE

An operating procedure, condition and so forth, to which special attention should be paid.

GENERAL SAFETY PRECAUTIONS



WARNING - HIGH VOLTAGE

During transmission, high RF voltages may appear at the RF connectors, the antenna cable, and on the antenna itself.

Avoid touching the antenna and the RF connectors of a radio set while it operates.

Make sure the antenna is not located near high-voltage lines.

Operating and maintenance personnel must be familiar with the applicable safety requirements before attempting to install or operate the radio set.

WARNING

Lithium-Ion batteries contain dangerous chemicals. Handle and dispose of Lithium-Ion batteries according to the prescribed safety regulations. In particular, observe the following precautions:

1. Do not short-circuit Lithium-Ion batteries.
2. Do not damage battery case and do not tamper with battery in any way.
3. Do not try to recharge the battery, except by means of the supplied battery charger.
4. Do not expose to heat or flame.
5. Do not dispose of used Lithium-Ion batteries by burning.

CAUTION

Do not transmit with radio on your back. Place radio on ground before starting transmit/receive communication, and connect it to the grounding spike in accordance with Chapter 2.

FEDERAL COMMUNICATION COMMISSION REGULATIONS

The FCC has established limits for safe exposure to radio frequency (RF) emissions from mobile two-way radios. The FCC requires manufacturers to demonstrate compliance with RF exposure limits before mobile two-way radios can be marketed in the U.S. When two-way radios are approved for occupational/controlled environment exposure limits, the FCC requires users to be fully aware of, and exercise control over, their exposure. Awareness and control of RF exposure can be accomplished by education or training through appropriate means such as information and instructions in user manuals or safety booklets, or other appropriate means. This user safety booklet includes useful information about RF exposure and helpful instructions on how to control your RF exposure.

Your two-way radio is designed and tested to comply with a number of national and international standards and guidelines (listed below) regarding human exposure to radio frequency electromagnetic energy. This radio complies with the IEEE (FCC) and ICNIRP exposure limits for occupational/controlled RF exposure environments at usage factors of up to 10% talk-90% listen. In terms of measuring RF energy for compliance with FCC exposure guidelines, your radio radiates measurable RF energy only while it is transmitting (during talking), not when it is receiving (listening) or in standby mode.

Your two-way radio complies with the following RF energy exposure standards and guidelines:

- United States Federal Communications Commission, Code of Federal Regulations; 47CFR part 2 sub-part J
- American National Standards Institute (ANSI)/Institute of Electrical and Electronic Engineers (IEEE) C95.1-1992
- Institute of Electrical and Electronic Engineers (IEEE) C95.1-1999 Edition
- International Commission on Non-Ionizing Radiation Protection (ICNIRP) 1998
- Ministry of Health (Canada) Safety Code 6: Limits of Human Exposure to Radiofrequency Electromagnetic Fields in the Frequency Range from 3 kHz to 300 GHz, 1999
- Australian Communications Authority Radiocommunications (Electromagnetic Radiation – Human Exposure) Standard, 2001
- ANATEL, Brasil Regulatory Authority, Resolution 256 (April 11, 2001). Additional Requirements for SMR, Cellular and PCS Product Certification.

SAFETY SUMMARY

The following are general safety precautions that are not related to any specific procedures and therefore do not appear elsewhere in this publication. These are recommended precautions that personnel must understand and apply during various phases of operation and maintenance.

KEEP AWAY FROM LIVE CIRCUITS. Operating personnel must at all times observe all safety regulations. Do not replace components or make adjustments inside the equipment with the high voltage supply turned on. Under certain conditions, dangerous potentials may exist even when the power control is in the OFF position, due to charges retained by capacitors. To avoid casualties, always remove power and discharge and ground a circuit before touching it.

DO NOT SERVICE OR ADJUST ALONE. Under no circumstances should any person reach into the equipment enclosure for the purpose of servicing or adjusting the equipment except in the presence of someone who is capable of rendering aid.

RESUSCITATION. Personnel working with or near high voltages should be familiar with modern methods of resuscitation.

USE SAFETY APPROVED EQUIPMENT. When cleaners and primers are being applied, approved explosion-proof lights, blowers, and other equipment shall be used. Insure that firefighting equipment is readily available and in working order.

GIVE CLEANERS SPECIAL CARE. Keep cleaners in special polyethylene bottles or in safety cans and in minimum quantities. Discard soiled cleaning cloths into safety cans.

TABLE OF CONTENTS

	Page
CHAPTER 1 GENERAL DESCRIPTION	
1-1. SCOPE	1-1
1-2. PURPOSE AND USE	1-1
1-3. EQUIPMENT DESCRIPTION.....	1-2
1-3.1 Micom Receiver/Transmitter.....	1-2
1-3.2 Carrying Harness	1-3
1-3.3 FAD5530 Collapsible 9-Foot Whip Antenna	1-3
1-3.4 FAA5548 Portable Dipole Antenna	1-4
1-3.5 GPS Antenna, AT-1000 (for Use with Option G421)	1-4
1-3.6 Handset, FMN5501	1-4
1-3.7 Loudspeaker, LS-108M (Optional)	1-4
1-3.8 16 Ah Lithium-Ion Battery, FRN8577.....	1-5
1-3.9 Utilities.....	1-5
1-4. TECHNICAL CHARACTERISTICS	1-6
CHAPTER 2 INSTALLATION	
2-1. SCOPE	2-1
2-2. UNPACKING	2-1
2-3. MICOM PATHFINDER ASSEMBLY PROCEDURE.....	2-2
2-3.1 Installation of Battery	2-2
2-3.2 Installation in Carrying Harness	2-3
2-3.3 Installation of Whip Antenna	2-7
2-3.4 Connection of Audio Accessories.....	2-8
2-3.5 Wearing Backpack Carrying Harness	2-8
2-3.6 Operating Micom Pathfinder on Ground.....	2-8
2-4. USING THE FAA5548 TACTICAL DIPOLE ANTENNA.....	2-8
CHAPTER 3 OPERATING PROCEDURES	
3-1. SCOPE	3-1
3-2. MICOM CONTROLS, INDICATORS AND CONNECTORS	3-1
3-3. FAMILIARIZATION WITH MICOM OPERATING PROCEDURES	3-3
3-3.1 Display Functions	3-3
3-3.2 Audible Indications	3-7
3-4. MENU STRUCTURE.....	3-8
3-4.1 Displaying the Main Menu	3-8
3-4.2 What you can Select on the Main Menu.....	3-9
3-4.3 Notational Conventions	3-9
3-5. GETTING STARTED.....	3-10
3-5.1 Turning the Radio On and Off	3-10
3-5.2 Preparation for Operation	3-11
3-5.3 Transmitting and Receiving.....	3-13
3-6. USING THE CHANNEL MODE	3-14
3-6.1 Channel Mode Options.....	3-14
3-6.2 Selecting the Channel Mode	3-15
3-6.3 Choosing a Different Channel	3-16
3-7. USING THE FREQUENCY MODE.....	3-17
3-7.1 Frequency Mode Options	3-17
3-7.2 Selecting the Operating Frequency in the FREQ Mode	3-19
3-7.3 Storing Frequencies	3-22
3-8. USING THE SCAN MODE	3-23
3-8.1 Selecting the Scan Mode	3-23
3-8.2 Scan Mode Options.....	3-23
3-9. USING THE GPS RECEIVER (OPTIONAL)	3-24
3-9.1 Overview of GPS Receiver Functions	3-24
3-9.2 How to Get the Best Results from your Micom GPS Receiver	3-24
3-9.3 Operating the GPS Receiver	3-24
3-10. LOCKING/UNLOCKING THE RADIO	3-27
3-11. CHANGING THE PASSWORD.....	3-28

TABLE OF CONTENTS (Cont'd)

	Page
3-12. USING AUTOMATIC LINK ESTABLISHMENT (ALE).....	3-29
3-12.1 Enabling the ALE Mode.....	3-29
3-12.2 ALE Mode Options.....	3-30
3-12.3 Receiving and Transmitting Calls in ALE Mode.....	3-31
3-12.4 Using ALE Mode to Send and Request GPS Position Data.....	3-57
3-13. USING THE VOCODER.....	3-58
3-13.1 Introduction.....	3-58
3-13.2 Using the Vocoder.....	3-58
3-13.3 Programming the Vocoder.....	3-59
3-14. OPERATION UNDER UNUSUAL CONDITIONS.....	3-62
3-14.1 Operation in Desert Areas.....	3-62
3-14.2 Operation at Low Temperatures.....	3-62
3-14.3 Operation During Storms.....	3-62
CHAPTER 4 USING THE PROGRAMMING MODE	
4-1. SCOPE.....	4-1
4-2. THE PROG MENU.....	4-1
4-3. PROGRAMMING THE RADIO PARAMETERS.....	4-2
4-3.1 Programming Channels.....	4-3
4-3.2 Configuring Radio Parameters.....	4-5
4-3.3 Setting Radio Options.....	4-6
4-4. ALE PROGRAMMING.....	4-7
4-4.1 Programming Nets.....	4-9
4-4.2 Setting the Net Options.....	4-11
4-4.3 Directory Parameters.....	4-11
4-4.4 AMD Message Configuration.....	4-11
4-4.5 ALE Options Configuration.....	4-12
4-4.6 Auto Dial Parameters.....	4-13
4-4.7 Storing ALE parameters.....	4-14
4-4.8 Using the New Station Address Filter.....	4-14
CHAPTER 5 OPERATOR MAINTENANCE	
5-1. GENERAL.....	5-1
5-2. VISUAL INSPECTION AND MECHANICAL CHECKS.....	5-1
5-2.1 Inspection.....	5-1
5-2.2 Cleaning.....	5-2
5-3. CORRECTIVE MAINTENANCE.....	5-3
APPENDIX A USING BATTERY CHARGER, FRN8570B	
A-1. PURPOSE AND USE.....	A-1
A-2. FRN8570B DESCRIPTION.....	A-1
A-3. FUNCTIONAL DESCRIPTION.....	A-1
A-4. FRN8570B OPERATING INSTRUCTIONS.....	A-2
A-4.1 Familiarization with Charger Unit.....	A-2
A-4.2 Preparations for Charging.....	A-3
A-4.3 Charging Process.....	A-3
A-5. MAIN FRN8570B TECHNICAL SPECIFICATIONS.....	A-4
APPENDIX B INSTALLATION OF FAA5548 TACTICAL DIPOLE ANTENNA	
B-1. SCOPE.....	B-1
B-2. FAA5548 DESCRIPTION.....	B-1
B-3. ANTENNA CONFIGURATIONS.....	B-1
B-3.1 Horizontal Dipole.....	B-2
B-3.2 Inverted V Dipole.....	B-2
B-3.3 Sloping Dipole.....	B-3
B-3.4 Wire Antenna Configuration.....	B-4
B-4. FAA5548 INSTALLATION PROCEDURE.....	B-4
APPENDIX C ALE CAPABILITIES AND FEATURES	
C-1. SCOPE.....	C-1
C-2. SCANNING.....	C-1

TABLE OF CONTENTS (Cont'd)

		Page
C-3.	SOUNDING	C-1
	C-3.1 Sounding Cycle Time	C-1
	C-3.2 Manual Sounding	C-2
C-4.	LQA MEMORY	C-3
C-5.	BIDIRECTIONAL HANDSHAKE.....	C-3
C-6.	SELECTIVE CALLING	C-4
	C-6.1 ALE Addressing Method.....	C-4
	C-6.2 Address and Call Types	C-4
C-7.	USING THE MULTINET FEATURE	C-8
C-8.	MESSAGES.....	C-8
C-9.	USING THE CALLER STACK.....	C-8
C-10.	QUICK CALL	C-9

LIST OF ILLUSTRATIONS

	Page
Figure 1-1. Micom Pathfinder, General View	1-1
Figure 1-2. Micom Receiver/Transmitter.....	1-2
Figure 1-3. Micom Pathfinder Carrying Harness, General View (Closed for Transport)	1-3
Figure 1-4. GPS Antenna, AT-1000	1-4
Figure 1-5. GPS Antenna Adapter, AD-1000P	1-4
Figure 1-6. Rechargeable Lithium-Ion Battery, FRN8577	1-5
Figure 1-7. PC-Micom Data Cable	1-5
Figure 2-1. Installing the Battery	2-2
Figure 2-2. Carrying Harness, Front View (Closed).....	2-3
Figure 2-3. Carrying Harness with Front Flaps Raised	2-4
Figure 2-4. Installing Transceiver in Carrying Harness.....	2-5
Figure 2-5. Detail of Transceiver in its Carrying Harness.....	2-6
Figure 2-6. GPS Antenna Installed on Harness.....	2-6
Figure 3-1. Micom Front Panel Controls, Indicators and Connectors.....	3-1
Figure 3-2. MICOM Rear Side Connectors.....	3-2
Figure 3-3. Main Menu	3-9
Figure 3-4. Channel (CHAN) Menu	3-14
Figure 3-5. FREQ (Frequency) Menu.....	3-17
Figure 3-6. GPS Menu	3-25
Figure 3-7. ALE Operator Menu	3-30
Figure 3-8. VCD Programming Menu.....	3-60
Figure 4-1. PROG Menu – Radio Parameters Programming.....	4-2
Figure 4-2. PROG Menu – ALE Parameters Programming	4-7
Figure A-1. Charger Unit, General View	A-2
Figure B-1. Horizontal Dipole Configuration	B-2
Figure B-2. Inverted V Configuration.....	B-3
Figure B-3. Sloping Dipole Configuration.....	B-3
Figure C-1. Network Occupancy	C-2

LIST OF TABLES

	Page
Table 1-1. DATA Connector, Pin Functions.....	1-8
Table 1-2. AUDIO Connectors, Pin Functions.....	1-8
Table 5-1. Visual Inspection and Mechanical Checks.....	5-1
Table 5-2. Fault Messages	5-4
Table A-1. Status Indications	A-2
Table C-1. Use of “@” Stuffing Symbol.....	C-5
Table C-2. Use of “?” Wildcard Symbol.....	C-6

Intentionally Left Blank

CHAPTER 1

GENERAL DESCRIPTION

1-1. SCOPE

This manual provides instructions regarding the installation and operator maintenance of the Micom Pathfinder, a portable high-frequency (HF) single sideband (SSB) manpack radio set. The manual is organized as follows:

- Chapter 1** **General Description:** provides a general description of the Micom Pathfinder and its main components, and presents the main technical characteristics.
- Chapter 2** **Installation:** provides installation instructions for Micom Pathfinder.
- Chapter 3** **Operating Instructions:** describes the equipment and the functions of the various controls and indicators, and presents operating instructions.
- Chapter 4** **Using the Programming Mode:** provides detailed instructions for programming the Micom Pathfinder parameters needed in the various operating modes.
- Chapter 5** **Operator Maintenance:** provides operator maintenance instructions.
- Appendix A** **Using Battery Charger, FRN8570B:** provides instructions for using the FRN8570B to charge Micom Pathfinder battery, FRN8577.
- Appendix B** **Installation of FAA5548 Tactical Dipole Antenna:** provides concise installation instructions for the FAA5548 tactical dipole antenna.
- Appendix C** **ALE Capabilities and Features:** provides a concise description of the ALE capabilities and features supported by Micom Pathfinder.

1-2. PURPOSE AND USE

Micom Pathfinder, a manpack version of the robust Micom-3 mobile radio, is an advanced HF-SSB transceiver that provides a complete solution to the communication requirements in the crowded HF band. It is part of the Micom-3 family of HF/SSB radio sets, has compatible characteristics, and uses the same operating procedures as other Micom-3 radio sets.

Micom Pathfinder has selectable transmit RF power of 5, 10, 15 and 25 W, and high sensitivity. Its built-in automatic antenna tuner supports a wide range of antennas, including a 2.7 meter (9 ft) whip which can be easily folded for storage. For static operation, Micom Pathfinder can also be used with dipole, long wire and other types of broadband antennas.

Micom Pathfinder can be ordered with an optional internal GPS receiver that provides accurate time and navigation data.

Micom Pathfinder is powered by a rechargeable Lithium-Ion battery, and is carried in a convenient, lightweight harness that completely envelops the transceiver, and enables carrying all the necessary accessories.



Figure 1-1. Micom Pathfinder, General View

The Micom Pathfinder capabilities provide reliable long-range HF-SSB radio communications in a rugged yet lightweight manpack configuration. Designed to meet the needs of users who carry out on-foot operations in remote areas, it is built to withstand years of shock and vibration as well as severe weather conditions. Micom Pathfinder is certified for dependability and durability, and complies with the applicable sections of MIL-STD-810F and MIL-STD-810E.

Micom Pathfinder supports voice and data communications. Micom Pathfinder supports data rates up to 4800 bps by means of an optional internal (embedded) modem.

Extensive use of digital signal processing (DSP) ensures high performance; a built-in voice quality system with proprietary DSP algorithms filter out background noise and elevates sound bytes providing exceptional communication clarity and voice quality. Many advanced features are standard, such as digital noise blanking and voice-activated digital squelch. Optional features such as embedded data modem, embedded vocoder, embedded AES encryption, etc., are also available. Moreover, the addition of new features and upgrading to future technologies are easily made by software updating.

To ensure the best possible communication reliability, Micom Pathfinder Automatic Link Establishment (ALE) has been certified by the Joint Interoperability Test Center (JITC) to MIL-STD-188-141B. In addition, the ALE function also provides Automatic Message Display (AMD), that enables operators to exchange preprogrammed messages while establishing a link. The AMD function is also used in several advanced optional features, such as automatic position reporting (either operator-initiated or in response to queries) when a GPS receiver is installed, and automatic adoption of the encryption key used by the transmitting station (provided the necessary key is available at the receiving station).

1-3. EQUIPMENT DESCRIPTION

This section describes the main equipment units of the Micom Pathfinder radio set.

1-3.1 Micom Receiver/Transmitter

The Micom receiver/transmitter unit performs the following main functions:

- Generates the transmit signals.
- Demodulates the received signals.
- Processes the GPS signals (optional).
- Provides the interfaces to the operator, and to data equipment using Micom Pathfinder for radio communications.

Figure 1-2 shows a general view of Micom, including its battery box.

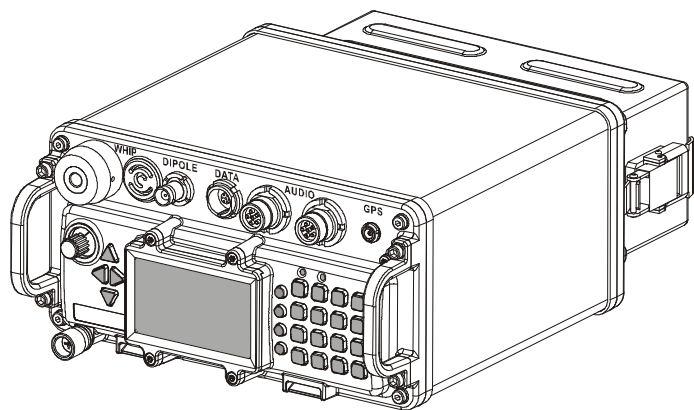

Figure 1-2. Micom Receiver/Transmitter

The Micom is a complete HF/SSB receiver-transmitter, powered by a 14.4 V Lithium-Ion battery installed in a battery box attached to the rear side of the Micom by two clamps. The box houses the battery and protects the battery against environmental elements.

The nominal output impedance of the Micom is 50 Ω , and therefore it can be directly connected to broadband antennas (dipoles, traveling wave antennas, delta and semi-delta antennas). An internal antenna tuner enables using various whip antennas (in addition to the 2.7 meter (9 ft) antenna offered as a standard for the Micom Pathfinder). The transmitter includes antenna mismatch protection: if the VSWR (Voltage Standing Wave Ratio) is too high, for example, because the antenna is disconnected or damaged, the transmission will be inhibited to avoid damage, and a message will be displayed. In addition, if for any reason, the transmitter internal temperature exceeds the maximum permitted temperature, the transmitter output power is automatically reduced to avoid fault due to excessive heat.

The Micom has an intelligent, user-friendly man-machine interface that enables easy operation. The display provides feedback to the operator and shows extensive information concerning system status (e.g., mode of operation, link status, call progress indications, low battery condition, etc.), as well as the GPS data (when this option is used). Support for multiple languages is also available.

1-3.2 Carrying Harness

Micom Pathfinder carrying harness consists of a lightweight nylon harness with adjustable shoulder straps that enable carrying all the necessary accessories. Additional waist and breast straps, also easily adjustable for best fit and user's comfort, stabilize the harness while walking and running.

A foldable rear support enables placing the harness on ground, vertically, for dismantled operation.

CAUTION

During dismantled operation, use the supplied grounding spike and strap to ground the Micom Pathfinder unit.

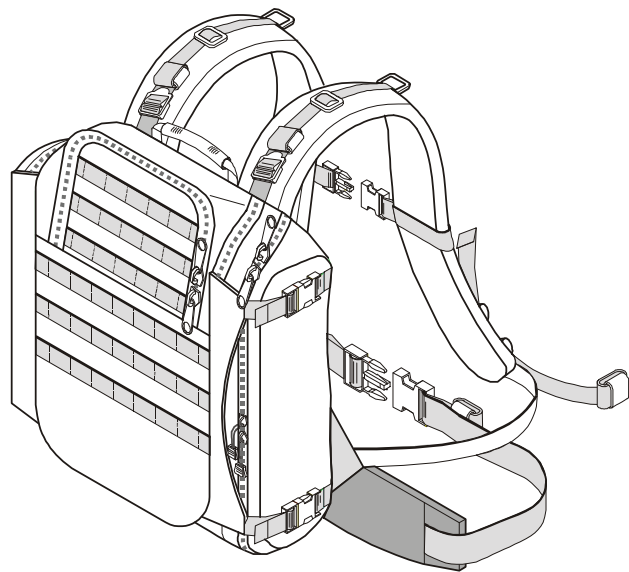

Figure 1-3. Micom Pathfinder Carrying Harness, General View (Closed for Transport)

For best equipment protection, the carrying harness completely envelops the transceiver. A front flap with zippers provides easy access to the internal storage compartments for cables and spare battery, and also permits the installation of the Micom transceiver. After installing the transceiver, the front flap remains closed: a separate top flap can be opened to access the Micom front panel, install the antenna and the handset, and operate the radio set.

Side pouches can be used to carry the folded whip antenna, and other accessories. The optional GPS antenna is attached to the side of the harness.

1-3.3 FAD5530 Collapsible 9-Foot Whip Antenna

The FAD5530 whip antenna is the standard Micom Pathfinder antenna used for short-range ground-wave communication, and is suitable for portable operation. Antenna matching is performed by the Micom internal automatic antenna tuner, and thus FAD5530 is directly connected to the WHIP connector of the Micom.

The FAD5530 whip antenna consists of two components:

- AT-271A Collapsible Antenna. The antenna is composed of six sections. Each section fits into the end of a wider section. A stainless-steel plastic-covered cable (or braided plastic cord), under spring tension, is threaded through the sections to keep them together when operating. When the sections are folded, the cable keeps them together as a group, to prevent the loss of individual sections. Spring tension is provided by a spiral spring in the base section.

- AB-591 Antenna Base Adapter. The antenna base adapter serves as the main support for the AT-271A.

A safety strap is supplied to fasten the antenna sections together, when the radio set is transported with the antenna folded.

1-3.4 FAA5548 Portable Dipole Antenna

The optional FAA5548 dipole antenna is a lightweight portable antenna for the frequency range of 2 to 30 MHz. This antenna is recommended for use during static operation, when long communication ranges are required: when using a properly selected operating frequency, FAA5548 provides continuous coverage for communication ranges of up to 1,000 kilometers.

The FAA5548 antenna consists of two antenna wires, which are attached to an insulator (center unit). The insulator is connected by means of the coaxial feed cable to the front-panel DIPOLE connector. The length of the antenna wires is coarsely adjusted in accordance with the operating frequency. Two cords are used to stretch the wires. The cords are fastened to nearby supports, e.g. trees, poles, etc.

When properly adjusted to the operating frequency range, the FAA5548 input impedance is close to 50 Ω , and therefore it is possible to connect FAA5548 directly to the DIPOLE connector of the Micom. When the selected operation mode involves automatic changing of the operating frequency, e.g., for ALE operation, the antenna should be adjusted to the average operation frequency.

1-3.5 GPS Antenna, AT-1000 (for Use with Option G421)

The GPS antenna, AT-1000, is a compact active omnidirectional antenna which connects to the GPS connector of the Micom through a coaxial cable that carries both DC power and the received GPS signals. The AT-1000 has a threaded stud on its base, which can be used to fasten the antenna to an appropriate adapter. Figure 1-4 shows a general view of the antenna.

Figure 1-4. GPS Antenna, AT-1000

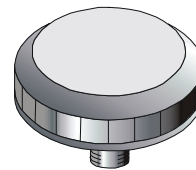

For use in Micom Pathfinder, the required adapter is AD-1000P, and the coaxial cable is CG-5602. AD-1000P is used to attach the AT-1000 to the Micom Pathfinder carrying harness. Figure 1-5 shows a general view of the antenna adapter.

Figure 1-5. GPS Antenna Adapter, AD-1000P

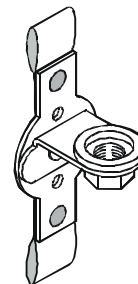

1-3.6 Handset, FMN5501

FMN5501 is a dynamic handset with a noise-suppression microphone complying with MIL-H-49078 (EL). It has a five-pin audio connector for connection to one of the Micom AUDIO connectors.

1-3.7 Loudspeaker, LS-108M (Optional)

The LS-108M is a portable 0.3 W loudspeaker that connects to one of the AUDIO connectors on the front panel of the Micom. The LS-108M is designed for field combat use, and may be attached to a belt or harness. It allows a commander to monitor radio communications while the radio operator remains in full control of the radio set.

A volume control on the housing provides adjustable sound level. The loudspeaker has an additional AUDIO connector, which permits the connection of an additional handset.

1-3.8 16 Ah Lithium-Ion Battery, FRN8577

FRN8577 is a rechargeable Lithium-Ion battery that provides a 14.4 V nominal voltage, and a nominal capacity of 16 ampere-hours. The battery has a plastic outer case with safety vent. The battery has two connectors, one for powering the transceiver, and the other for charging. Internal electronic circuits protect against short-circuits, undervoltage, excessive temperature, and overcharging.

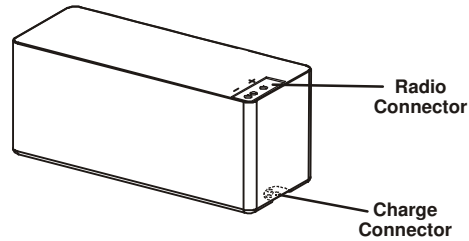

Figure 1-6. Rechargeable Lithium-Ion Battery, FRN8577

1-3.8.1 Battery Charger, FRN8570B

FRN8570B is a portable automatic battery charger for FRN8577 rechargeable Lithium-Ion batteries. FRN8570B can be powered from 100 to 240 VAC, 50/60 Hz. Its operation is fully automatic, and thus ensures full charging of batteries to their rated capacity, while prolonging the operational life of batteries by providing optimum charging conditions.

Refer to Appendix A for additional information.

1-3.9 Utilities

To fully and efficiently utilize the Micom Pathfinder's advanced capabilities, the following utility packages are offered as options:

- The radio operational parameters can be programmed using the Micom Radio Control Application (MRC), option FVN4841 (G424). For further details, refer to "Micom Radio Control Application Owner's Guide", Publication OM-E 2072-09602-10.
- Data communications are supported by the MicomNET e-Mail/Gateway over HF Software Package, covered by the "MicomNET e-Mail/Gateway over HF Software Package User's Guide", Publication 6886864J01.

All the utilities listed above run on PCs using the Windows™ operating system, and require two of the serial RS-232 asynchronous (COM) ports of the PC for communication with the Micom receiver/transmitter: COM2 is used as the radio control port, and COM1 is used as the modem data port. A special data cable is available for connecting the two PC serial ports to the Micom DATA connector.

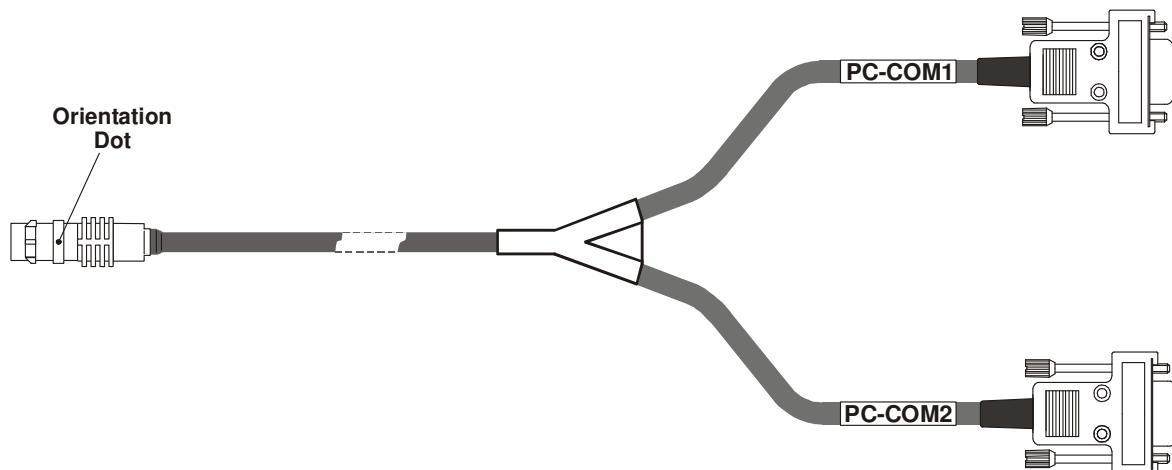

Figure 1-7. PC-Micom Data Cable

1-4. TECHNICAL CHARACTERISTICS**General**

Model	M95AMN0KV5-K+G873
Transmit Frequency Range	1.6 to 30 MHz
Receive Frequency Range	0.1 to 30 MHz (0.1 to 1.6 MHz reduced performance)
RF Impedance	<ul style="list-style-type: none"> • DIPOLE connector: 50 Ω • WHIP connector: internal automatic tuner for whip antenna
Number of Channels	200 simplex or half duplex, user programmable
Scanning	<ul style="list-style-type: none"> • 5 groups with up to 100 channels per group, including 1 guard channel. • Programmable scan rate: 1 to 5 sec. per channel, in 1 sec. steps
ALE	MIL-STD-188-141B, JITC certified, MultiNet support
Frequency Stability	0.6 ppm (0.1 ppm optional)
Frequency Resolution	10 Hz
Data and Remote Control Interfaces	RS-232C
Modes of Operation	<ul style="list-style-type: none"> • SSB (USB or LSB, user-selectable) • PILOT • AME
Services	<ul style="list-style-type: none"> • Analog voice • Digital voice (internal low-rate vocoder) • Data using internal modem (50 to 4800 bps) • COMSEC (digital NIST-certified advanced encryption system (AES), available as option for the vocoder and/or internal modem, internal storage of up to 7 keys)
Audio Bandwidth	Automatic switching between voice and data
Voice Bandwidth	350 to 2700 Hz
Data Bandwidth	Operator-selectable:
	2.1 kHz: 350 to 2100 Hz
	3.0 kHz: 350 to 3000 Hz
	3.3 kHz: 350 to 3300 Hz (also used by internal modem)
Operating Voltage	13.8 VDC \pm 20%, negative ground
Dimensions	110 H \times 222 W \times 220 D mm (4.33 H \times 8.74 W \times 8.66 D inch)
Weight (without battery)	3.6 kg (7.93 lb)

Battery

Type	Lithium-Ion, rechargeable
Capacity	16 Ah
Nominal Voltage	14.4 V
Minimum Voltage	10.0 V
Maximum Continuous Current	13 A
Operating Temperature Range	-30 to +50°C/-22 to +122°F
Charging Temperature Range	0 to +50°C/32 to +122°F
Dimensions (H × W × L)	78.5 × 72.6 × 187.5 mm (3.09 × 2.86 × 7.38 inch)
Weight	1.8 kg
Temperature Range	
Operating	-30 to +60°C/-22 to +140°F
Storage	-40 to +85°C/-40 to +185°F
Humidity	Max. 95% at 50°C
Shock and Vibration	MIL-STD-810E and MIL-STD-810F

Transmitter

Output Power	5, 10, 15, 25 W P.E.P and average, user-selectable
TX/RX Switching Time	10 msec
Tx Tuning Adjustments	None
Current Consumption (single tone)	Max 11A

Receiver

Sensitivity (SINAD) SSB	<ul style="list-style-type: none"> • 0.5 μV for 10 dB SINAD (0.35 μV typical) • 0.1 to 1.6 MHz with reduced performance
Audio Power at Speaker	External 5W @ 2.5% distortion
Squelch	Constant SINAD (digital)
Clarifier Range	\pm 200 Hz in 10 Hz steps
Current Consumption	<ul style="list-style-type: none"> • Max 0.9A without modem • Max 1.1A with modem option

Connectors*Table 1-1. DATA Connector, Pin Functions*

Pin	Description
1	Not connected
2	Serial control communication transmit output (to RADIO connector)
3	Serial control communication receive input (to RADIO connector)
4	Not connected
5	Ground line
6	Serial data communication transmit output (to RADIO and MODEM connectors)
7	Serial data communication receive input (to RADIO and MODEM connectors)

Table 1-2. AUDIO Connectors, Pin Functions

Pin	Description
A	Ground line
B	Receive audio output to external speaker
C	Activates transmission by short to ground
D	Input audio signals generated by the microphone (600 Ω impedance; 6 mV tone is required for full output power)
E	Receive audio output (600 Ω) to earphone
F	Power output to microphone

CHAPTER 2

INSTALLATION

2-1. SCOPE

This Chapter provides installation instructions for Micom Pathfinder.

WARNING

Lithium-Ion batteries, FRN8577, contain dangerous chemicals. Handle and dispose of Lithium-Ion batteries according to the prescribed safety regulations. In particular, observe the following precautions:

1. Do not short-circuit Lithium-Ion batteries, FRN8577.
2. Do not damage battery case and do not tamper with battery in any way.
3. Do not expose to heat or flame.
4. Do not dispose of Lithium-Ion batteries by burning or incinerating.
5. Always charge battery only with the FRN8570B charger.

2-2. UNPACKING

- a. A preliminary inspection of the equipment containers should be made prior to unpacking. Evidence of damage should be noted and reported immediately to the proper authorities.

Unpack the equipment as follows:

- (1) Place each container on a clean flat surface, cut all straps, and open or remove the top.
 - (2) Take out each item carefully and place it securely on a clean surface.
 - (3) Remove the packing material while looking for small items.
 - (4) Fold and store the containers and packing materials for future use.
- b. Checking Unpacked Equipment.
 - (1) Inspect all items for damage. Immediately report any damage found.
 - (2) Check all items against the items listed in the accompanying packing slip and/or the appropriate list of items given in the equipment manual.
 - (3) Report any missing items or discrepancies. Shortage of a minor part which does not affect the proper functioning of the equipment should not prevent use of the equipment.

2-3. MICOM PATHFINDER ASSEMBLY PROCEDURE

The assembly of a Micom Pathfinder radio set and its preparation for operation includes the following steps:

- Installation of Micom battery
- Installation in carrying harness
- Installation of antenna and audio accessories
- Wearing the carrying harness.

2-3.1 Installation of Battery

1. Check that the volume/power control of the Micom Pathfinder is set to the fully counter-clockwise detent position, OFF.
2. Place the unit face down on a clean, flat surface.
3. Release the two clamps holding the battery cover on the bottom of the unit and remove the cover.
4. Remove old battery, if any.
5. Align battery connector with the two power pins protruding from the bottom of the unit, and push the battery in place.
6. Visually check battery cover for dirt or damage. Clean if necessary.
7. Reinstall the battery cover and fasten with the two clamps.

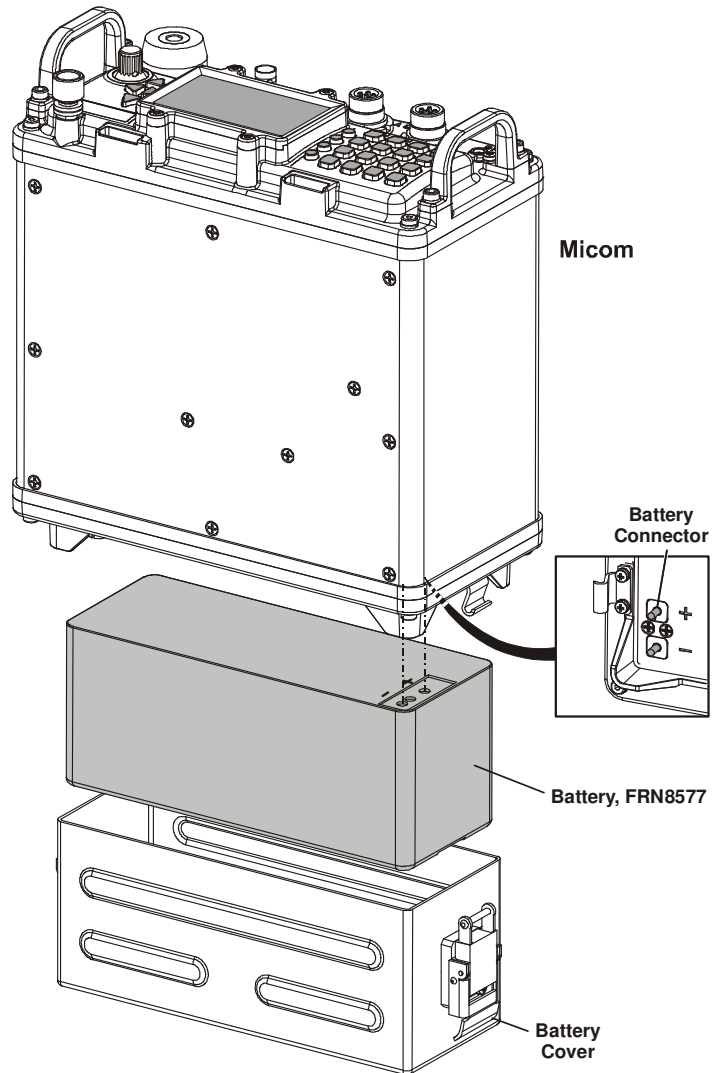

Figure 2-1. Installing the Battery

2-3.2 Installation in Carrying Harness

2-3.2.1 Familiarization with Carrying Harness

Figure 2-2 shows a general front view of the closed carrying harness. The harness can be worn on the operator's back, or placed on the ground, using the rear support to hold it in a vertical position.

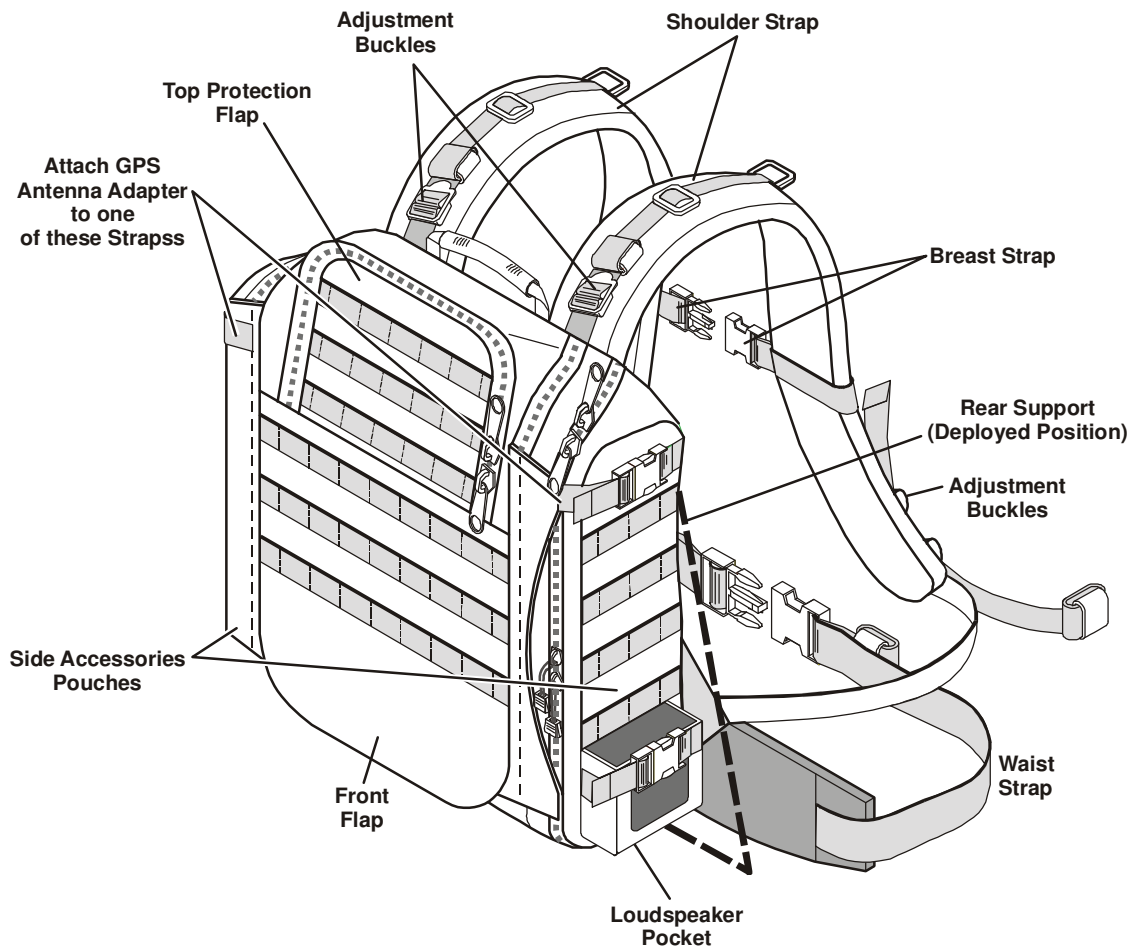

Figure 2-2. Carrying Harness, Front View (Closed)

The carrying harness transceiver compartment is closed by a front flap, which can be unzipped and raised as shown in Figure 2-3. This provides full access to the interior of the carrying harness for installing the transceiver, or retrieving stored items (spare battery, charger, cables, etc.). Additional storage pouches for large accessories, e.g., folded whip antenna, handset, etc., are located on the sides of the carrying harness. The optional GPS antenna (mounted on the adapter, AD-1000P) can be attached to one of the top side straps (either on the left or right hand side of the harness). The optional portable loudspeaker, LS-108M, can be inserted in a special pocket at the right-hand side, or attached with a strap to the harness. During operations, the audio accessory (handset or microphone) can be attached with a strap to the front side of the desired shoulder strap.

In addition to the front flap, the carrying harness has a top protection flap: when the front flap is closed, it is possible to open the top flap to gain access to the Micom front panel and to most of the stored items.

Figure 2-3 shows the carrying harness with the front flap open. Note the internal storage pockets, and in particular the spare battery compartment. The transceiver, with battery, is installed in the compartment located above the spare battery storage, behind a restrainer plate. After the transceiver is in place, the restrainer is pressed against the transceiver body by tightening the four side restraining straps. Two additional top restraining straps, passing along the sides of the transceiver, are attached to the handles, to prevent vertical movement. After the transceiver is secured, the front flap can be closed.

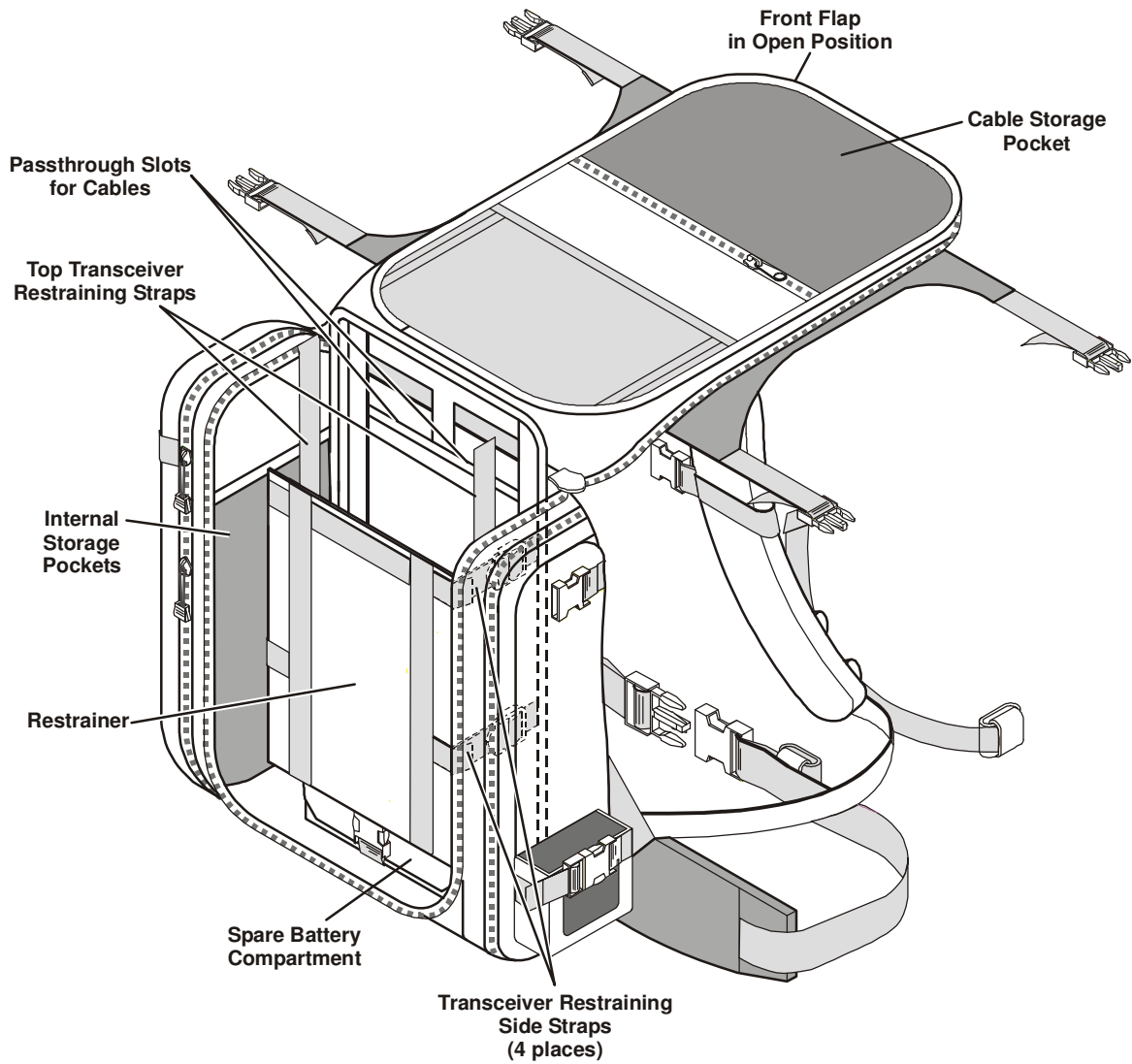

Figure 2-3. Carrying Harness with Front Flaps Raised

2-3.2.2 Installation Procedure

1. Place the carrying harness on a clean, level surface.
2. Release the four straps (two on each side).
3. Unzip the front flap, and then raise the flap as shown in Figure 2-4.
4. If necessary, store a spare battery in its storage compartment.
5. Release the two top transceiver restraining straps, and the four side restraining straps.
6. Orient the transceiver as shown in Figure 2-4, and then place it in position, behind the restrainer plate.

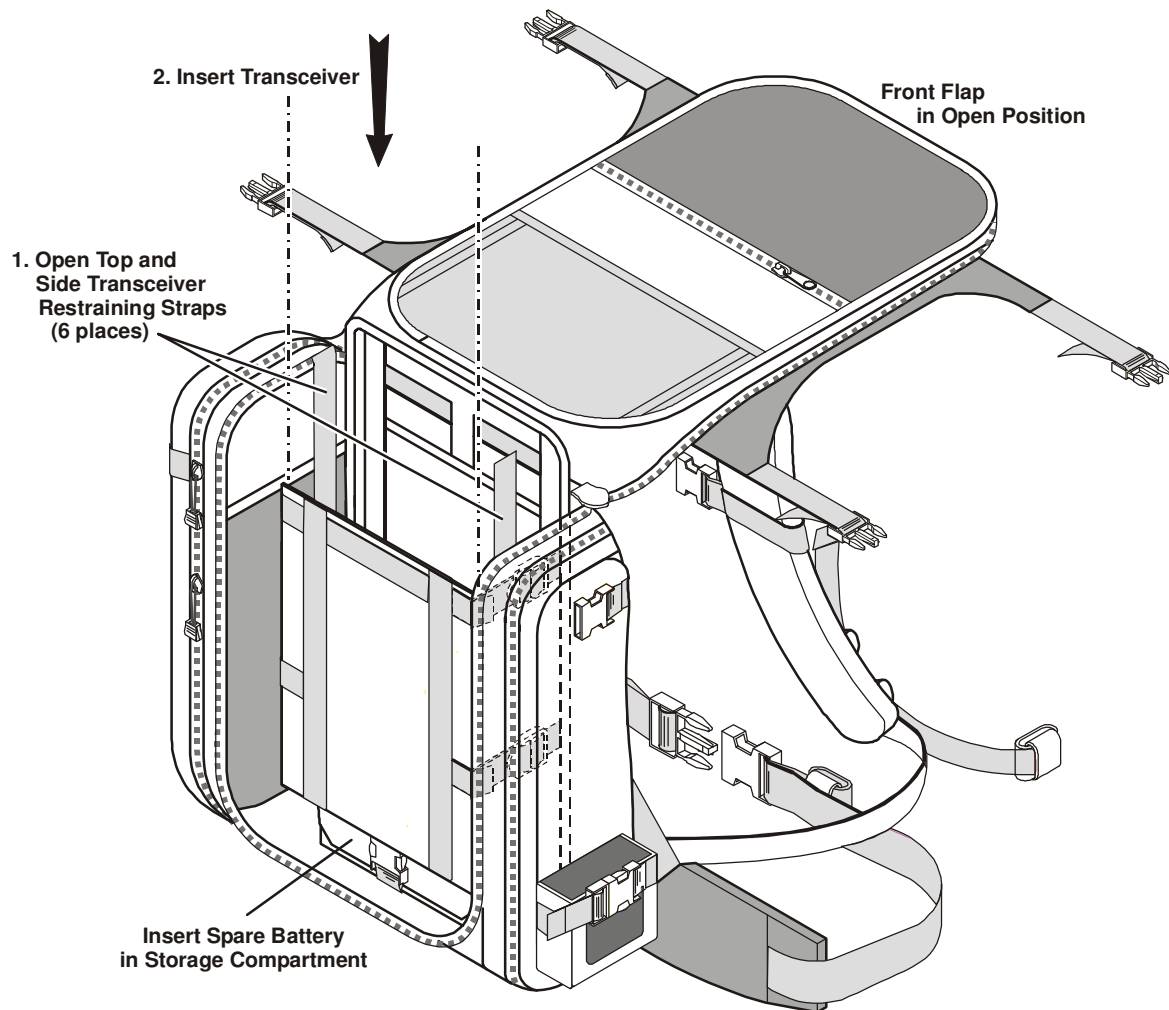

Figure 2-4. Installing Transceiver in Carrying Harness

7. Fasten the four transceiver restraining straps to secure the transceiver behind the restrainer plate.
8. Pass each top transceiver restraining strap over the corresponding transceiver handle, and fasten the straps. See detail of transceiver installed in harness in Figure 2-5.
9. Ensure all transceiver restraining straps are tight.
10. Place all the items to be stored inside the carrying harness in the corresponding storage pockets.
11. Close the front flap and secure with its zipper.
12. Insert all the items to be stored in the side accessories pouches, close the pouches, and then secure the pouches with the corresponding straps.



Figure 2-5. Detail of Transceiver in its Carrying Harness

2-3.2.3 Installation of Optional AD-1000P and GPS Antenna AT-1000

1. If the optional GPS receiver will be in use, insert the GPS support strap in the top loop of the optional AD-1000P, and slide the AD-1000P in place.
2. Insert the other end of the AD-1000P in a suitable slot, as shown in Figure 2-6, and then secure the AD-1000P by fastening the strap.

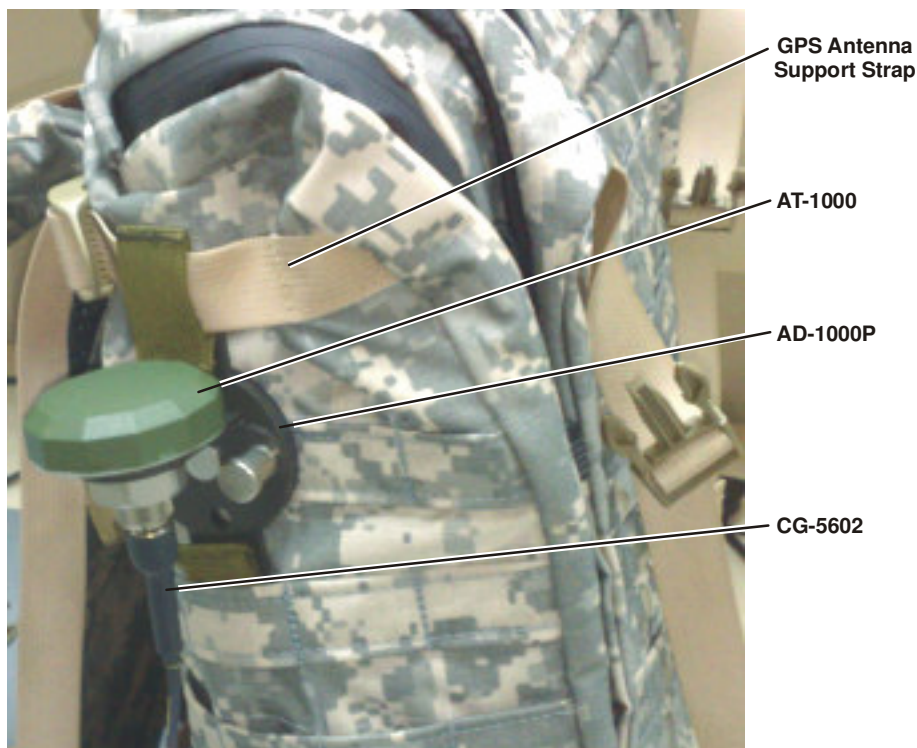
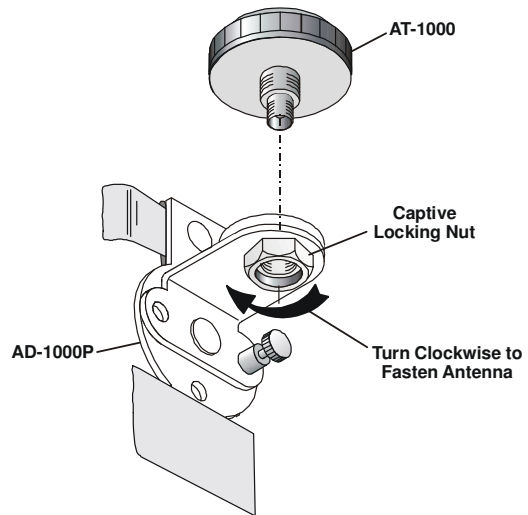

Figure 2-6. GPS Antenna Installed on Harness

1. Insert the threaded stud of the AT-1000 in the AD-1000P hole.
2. Turn the captive nut of the AD-1000P clockwise to fasten the AT-1000 to the adapter.
3. Remove the cover from the GPS connector of the Micom.
4. Connect the TNC connector of the CG-5602 cable to the AT-1000 connector, and tighten the connector.
5. Plug the connector at the other CG-5602 end into the Micom GPS connector.



2-3.2.4 Orienting the GPS Antenna Toward the Sky

When the GPS function is used, the GPS antenna must point toward the sky at all times.

The AD-1000P has two positions:

- Standing position: directs the antenna toward the sky when the Micom operator stands or walks.
- Prone position: directs the antenna toward the sky when the Micom operator lays on the ground.

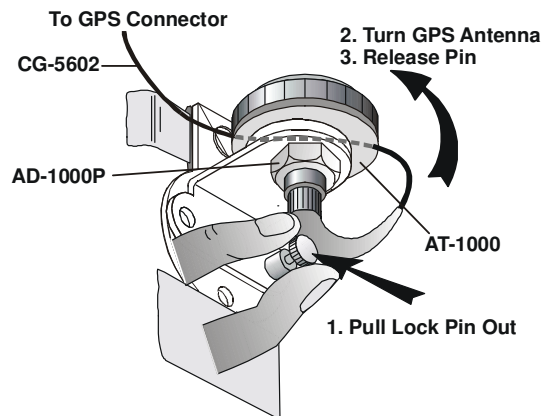

To rotate the GPS antenna from the standing position to the prone position:

1. Pull the AD-1000P lock pin out.
2. Turn the GPS antenna counter-clockwise.
3. Release the lock pin, and make sure it snaps into the corresponding hole locking the antenna and preventing it from rotating.

GPS Antenna in Standing Position

The same procedure is used to return the GPS antenna to the standing position.

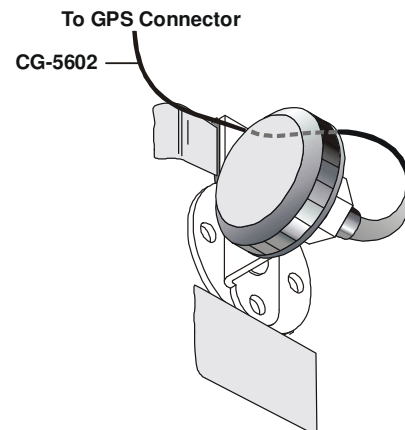

GPS Antenna in Prone Position

CAUTION

Make sure that the CG-5602 cable is not pulled nor stressed when the AD-1000P is rotated.

2-3.3 Installation of Whip Antenna

Before starting make sure that the top protection flap is fully open.

To install the antenna:

1. Remove cover from the WHIP connector on the Micom front panel.
2. Visually check the connector for dirt or damage. Clean if necessary.
3. Screw antenna support AB-591 into the Micom WHIP connector. Tighten by hand only.
4. Extend the whip, and secure all sections by inserting them one into the other by hand.
5. Screw whip antenna sections into antenna support, AB-591.

NOTE

When the radio set is not in use, you may fold the antenna without disconnecting it from the WHIP connector. In this case, fasten the folded sections using the safety belt supplied with the antenna. Before starting transmission, make sure to release the safety belt and extend the antennas.

To remove the whip antenna, perform the above tasks in the reverse order.

CAUTION

When folding the whip, always start with the upper section, otherwise it may be damaged.

2-3.4 Connection of Audio Accessories

Connect the handset, FMN5501, to either of the AUDIO connectors on the front panel of the Micom. You may secure the handset to the front side of a supporting strap.

If the optional LS-108M loudspeaker is used, insert it in the pocket and secure it with the straps, or attach it with a strap passing through its top and bottom hooks. Connect the loudspeaker cable to one of the AUDIO connectors on the front panel of the Micom. Route the audio cables through the dedicated passthrough slots on the back of the harness.

2-3.5 Wearing Backpack Carrying Harness

To wear backpack:

- Put harness on your back by inserting arms through shoulder straps.
- Tighten shoulder straps if necessary by adjusting the strap buckles.
- Buckle waist straps to belt and adjust to size.
- Adjust the breast strap length and then attach the strap.

At this stage, the Micom Pathfinder is ready for use as a manpack radio set.

2-3.6 Operating Micom Pathfinder on Ground

To operate the Micom Pathfinder on the ground, place the backpack on a flat, dry area, and deploy the rear support to stabilize the harness in a standing position.

For safety, and to achieve best perform, ground the Micom Pathfinder: drive the grounding spike into the ground close to the radio, and then connect the grounding strap between the front panel grounding post and the grounding spike.

2-4. USING THE FAA5548 TACTICAL DIPOLE ANTENNA

In static operation, the Micom Pathfinder can be used with an FAA5548 tactical dipole antenna. Refer to Appendix B for FAA5548 installation and operation instructions.

CHAPTER 3

OPERATING PROCEDURES

3-1. SCOPE

This Chapter describes the Micom Pathfinder controls, indicators and connectors, and explains its specific operating procedures. The Chapter is organized as follows:

- information needed to familiarize with the equipment panels – para. 3-2
- procedures for using the Micom Pathfinder keypad and display to perform any desired task – para. 3-3, and para. 3-10, 3-11
- how to start using a radio ready for operation (i.e., a radio installed in accordance with Chapter 2 and programmed in accordance with Chapter 4) – para. 3-5
- specific operating procedures for each main operating mode of the radio:
 - Channel mode – para. 3-6
 - Frequency mode – para. 3-7
 - Scan mode – para. 3-8
 - ALE mode – para. 3-12
- procedures for using the GPS receiver – para. 3-9.

3-2. MICOM CONTROLS, INDICATORS AND CONNECTORS

Figure 3-1 explains the functions of the front panel controls, connectors and indicators.

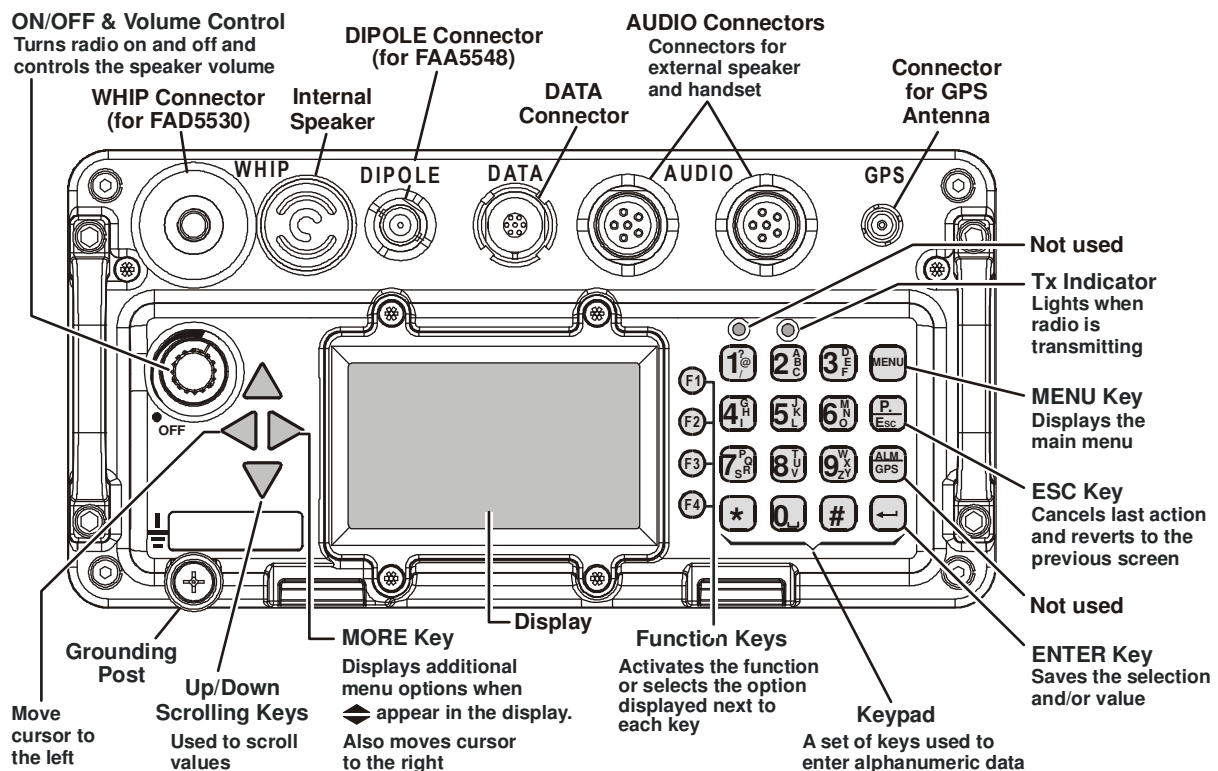

Figure 3-1. Micom Front Panel Controls, Indicators and Connectors

Figure 3-2 identifies the connectors located on the Micom rear side. The rear side includes a two-pin connector, for connecting the power, and a 44-pin connector. The 44-pin connector is normally covered by the battery, and therefore it is not available for use in manpacks.

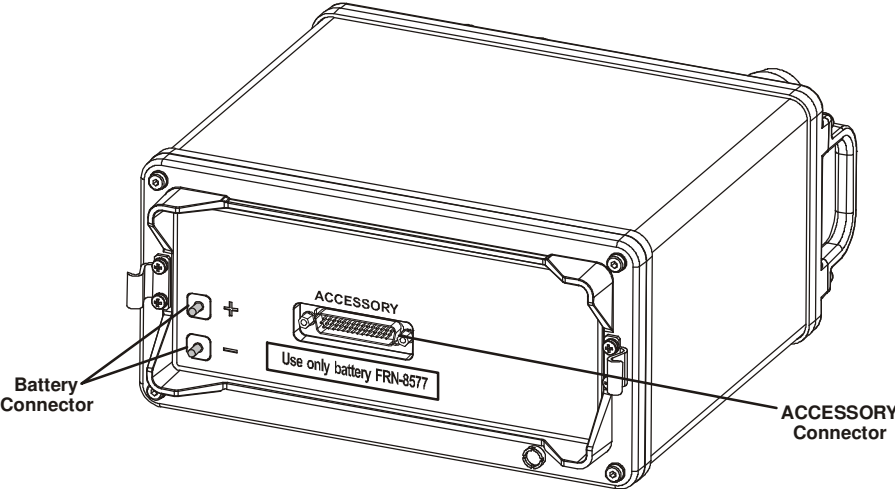



Figure 3-2. MICOM Rear Side Connectors

3-3. FAMILIARIZATION WITH MICOM OPERATING PROCEDURES

This section provides general procedures that will help you start using your radio and get the most of its advanced features. Most of the activities that can be performed by you (selection of operating mode, programming, testing, etc.) are done using the keypad together with the navigation and function keys, and the front panel display.

To simplify operation, Micom function keys operate as soft keys and therefore they permit you control the radio simply and efficiently, using a menu-driven mode that guides you and helps you make the required selections. “Menu-driven” simply means that whenever you must select a parameter, an operating mode, etc., you select it from a list of allowed values displayed on the front panel display, thereby reducing the chance of error:

- To make a selection, you use navigation keys to reach the desired parameter value or action, and then confirm the selection by pressing the ENTER  key.
- To go back to previous options, or cancel the current selection or action, press the ESC  key.

3-3.1 Display Functions

3-3.1.1 Display Organization

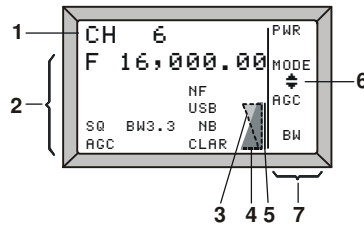

No.	Designation	Description
1	Mode indicator	Indicates the current working mode (e.g., channel, frequency, ALE, etc.) or the action being performed (e.g., programming, testing, etc.)
2	Work area	Displays information on the current working mode, the main operating parameters, the active options, status, etc.
3	Transmit level indicator	In the transmit mode, displays the relative transmit power
4	Receive level indicator	In the receive mode, displays the relative received signal strength
5	Tx bar	Appears when the radio is transmitting
6	More options icon	The presence of this icon indicates that more options can be displayed in the options area. When this icon appears, press the MORE key to see menu options
7	Options display area	Displays a list of options you can select, by pressing the corresponding key, in the current working mode

3-3.1.2 Mode and Function Indications

The following indications may appear in the work area of the LCD display, to indicate the selected mode or functions that are active.

Indication	Meaning
USB	Using upper sideband for transmission and reception
LSB	Using lower sideband for transmission and reception
SQ	Squelch is active: the speaker is turned on only when the radio identifies speech, to prevent reception noise from being heard
MON	When using ALE, indicates that the speaker is normally off, and is automatically turned on when the link is established
AGC	Non-standard AGC mode (AGC off, or fast AGC) has been selected
BW	Non-standard bandwidth has been selected (the bandwidth appears next to the BW indicator, for example, 3.3 (3.3 kHz) in the screen shown above)
NB	Noise blanker is active
CLAR	Clarifier is active (meaning that you selected a frequency deviating from the nominal channel frequency)
NF	Notch filter is active

3-3.1.3 RF Level Indications

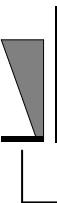
Indication	Meaning
 <p>Strong received signal</p> <p>Weak received signal</p>	Received RF signal strength indication, displayed when the radio is in the receive mode. The height provides a relative indication, which may fluctuate as a result of fading, etc.
 <p>– Full transmit power</p> <p>– Relative transmit power</p> <p>– Low transmit power</p> <p>– Reflected power</p>	<p>Transmit bar, appears when the radio is switched to the transmit mode (for example, when the PTT is pressed). Its length indicates the maximum radio transmit power in the selected mode (MAX, HIGH, MED or LO). The triangle height indicates the instantaneous relative transmit output power, and therefore it fluctuates as a result of modulation.</p> <p>The relative reflected power is indicated by the base line: its length indicates the fraction of power reflected because of antenna VSWR (the length should be small relative to the total height of the transmit bar, which is proportional to the forward power)</p>

3-3.1.4 Using the Keypad

Each key is imprinted with a numeral and several letters.

These characters are accessed in clockwise order, as follows:

- A single key press enters the numeral
- Two consecutive key presses enter the first letter
- Three consecutive key presses enter the second letter
- Four consecutive key presses enter the third letter.
- Five consecutive key presses enter the fourth letter.
- To enter a blank space, press  twice.



When entering frequencies, use the ***** key as a decimal point, if needed. In the ALE mode, the ***** key is also used to enter the wild-card character (? or @).

To enter the ampersand @ symbol, press the **#** key twice.

Example: To enter a number in a field, or edit (change) the number, you type the desired digits on the keypad.

Example: To enter an alphanumeric string in a field, or edit a string, you type the desired alphanumeric character by pressing the appropriate key several times in sequence. For example, to enter “MIKE 01”:

Press **6^{MNO}** twice (for the letter M).

Press **4^{GHI}** four times (for the letter I).

Press **5^{JKL}** three times (for the letter K).

Press **3^{DEF}** three times (for the letter E).

Press **0_L** twice (for the blank space).

Press **0_L** once (for the numeral 0).

Press **1[@]** once (for the numeral 1).

3-3.1.5 Function Keys

The function keys F1, F2, F3 and F4 appearing next to the display are soft keys used to select options which depend on the current radio mode. The current function of each key is shown in the options area of the display, next to the key. For example, on the PROG screen you can press F2 to start programming the ALE parameters.

If a certain function key is not used, no label appears next to the key (see for example F4), and pressing that key has no effect.



3-3.1.6 Options Scroll (MORE) Key

When more than four options are available in the options area of the display, press the **MORE** key to display the additional options.

To return to the first option, press the **ESC** key.

3-3.1.7 Up/Down Scroll Keys

The up and down scroll keys are used to scroll between values that are already programmed into the radio. For example:

- In the Channel mode, pressing the up or down scroll key once lets you view the previous, respectively next, programmed channel. Pressing either key continuously scrolls the channels in the selected direction.
- In the Frequency mode, you can change the frequency in the corresponding direction.
- In the radio Programming mode, you can use these keys to scroll among the programmable parameters.
- When displaying GPS data, you can use these keys to toggle the display format.

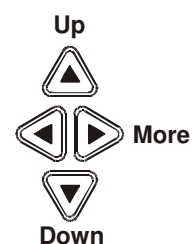

3-3.1.8 Selection from List of Predetermined Values

When the parameter you want to select can assume only one of several predetermined values, you select the desired value by pressing the function keys:

- F1 enters the lowest possible value (or OFF)
- F4 enters the highest possible value
- F2 and F3 increment or decrement the value. When you reach either end, the corresponding key disappears.

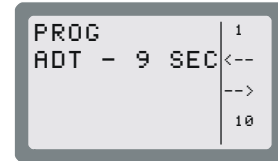

You cannot use the keypad to enter a value for such parameters.

3-3.1.9 Toggle Mode

When the function being set can only be toggled on or off, one function key will be marked **YES** and another **NO**.

To expedite turning on and off often-used functions (for example, turn the squelch on or off) only one key is used. In this case, just press the key assigned to the function to be toggled: the new state is shown for a few seconds, and then disappears as it takes effect immediately.

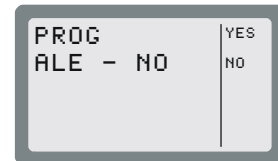

3-3.1.10 Alphanumeric Edit Mode

When you need to enter an alphanumeric string in a field, or edit a string, you type the desired alphanumeric character on the keypad. A blinking cursor **_** indicates the location being edited.

In addition, the following function keys are available:

- SAVE (F1)** Saves editing changes (equivalent to pressing the ENTER key).
- <— (F2)** Used to move the cursor backwards and forwards. When you reach either end, the corresponding key disappears.
- > (F3)**
- CLR (F4)** Pressing this key momentarily erases the digit/letter at which the cursor is presently located, and shifts the entire field one place to the left.
Press this key continuously clears the entire field.

3-3.1.11 Numeric Edit Mode

When you need to enter a number in a field, or edit the number, you type the desired digits on the keypad. A blinking cursor **_** indicates the location being edited.

In addition, the following function keys are available:

- BACK (F3)** Erases the last digit.
- CLR (F4)** Erases all newly entered digits and restores the original value.

3-3.1.12 View Mode

When the string to be displayed is longer than the number of characters that fit in one line (for instance, with long addresses or messages), the view mode enables scrolling to the rest of the string.

The view mode is indicated by the symbol **<-->** next to one of the function keys.

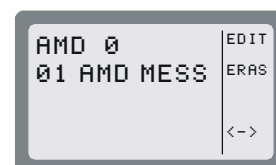

When you press < - >, the key functions change:

- HOME (F1)** Scrolls to display the first character of the string.
- <— (F2)** Scroll one character to the left or right, respectively. If you press either key continuously, the scrolling continues at a rate of four characters per second.
- > (F3)**
- END (F4)** Scrolls to display the last character of the string.



When you reach the beginning of the string, the **HOME (F1)** and **<— (F2)** function keys disappear, whereas when you reach the end of the string, the **—> (F3)** and **END (F4)** function keys disappear.

3-3.1.13 Message Attached Alert

When a message is attached to the received call (an option available for ALE calls, even if you are using the Channel mode), an exclamation sign ! appears to the left of the originating station name.

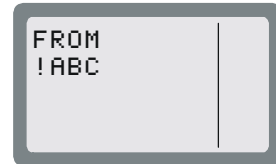

You can view the message contents after you accept the call.

3-3.2 Audible Indications

The user can configure the radio to generate audible tones to indicate events related to the radio operating conditions. The tone volume, low or high, may also be set using the MRC, or by programming from the front panel.

Event	Description
Valid key pressing	Beep sounds when a key is pressed, to indicate that the key pressing has been accepted. No beep – no action.
PTT release	A beep sounds on the remote radio to indicate that the local PTT button has been released.
ALE alerts	During ALE operation, beeps alert you to events you should be aware of, e.g., link establishment/disconnection, etc.

3-4. MENU STRUCTURE

The menu is used to select and control what you want your radio to do.

3-4.1 Displaying the Main Menu

To display the menu:

1. Press **MENU** to display the first part of the Menu screen. You can press the **MENU** key at any time during any sequence of operations: that sequence is then discontinued and the menu screen is immediately displayed.

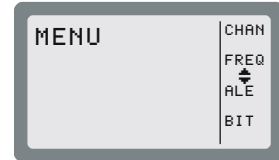

NOTE

The menu structure depends on the operating mode selected by the user. For example, when the ALE function is not used, the third item is either SCAN.

2. Press **MORE** to scroll to the second part of the Menu screen.

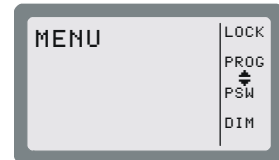

Press **MORE** again to scroll to the third part of the Menu screen.

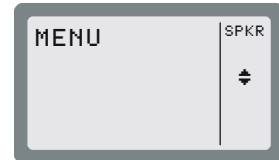

3. To select any item, press the function key next to it.

To exit the menu and return to regular radio operations (e.g., CHAN or FREQ):

4. Press the **ESC** key. The deeper you are in the menu, the more times you need to press **ESC**.

3-4.1.1 Selecting the Display Language

5. Display the second part of the Menu screen as explained above.

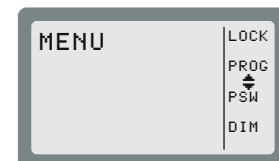

6. Press **PROG** (F2) to enter the Programming mode.

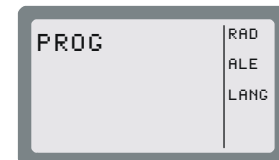

7. Press the function key next to the desired language.
8. Confirm the selection by pressing the **ENTER** key.

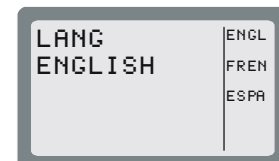

3-4.2 What you can Select on the Main Menu

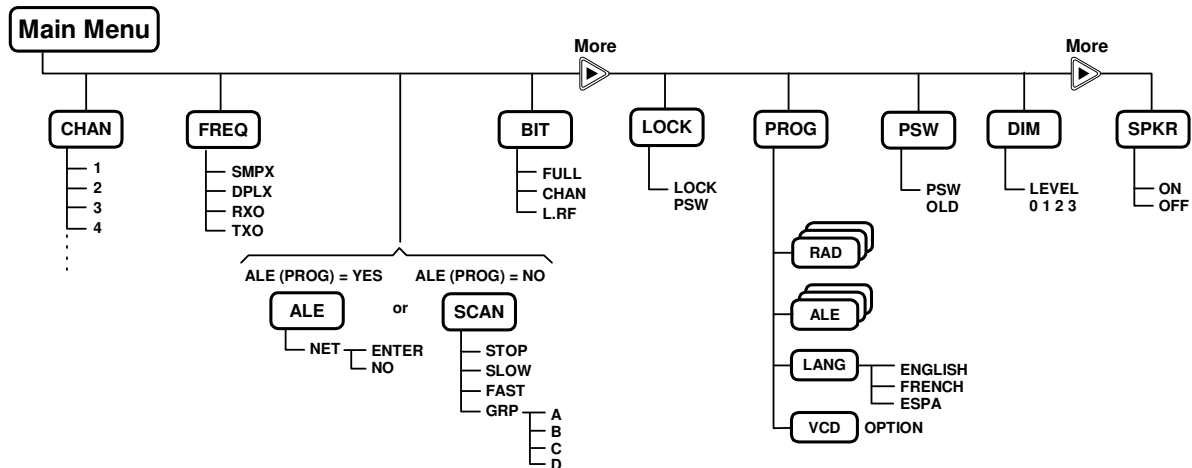

Figure 3-3. Main Menu

Use the following description with Figure 3-3, which shows the details of the main menu.

Menu item	... and its purpose
CHAN	Channel mode: the radio uses a set of preset parameters. Up to 200 sets of parameters can be defined and stored in the Micom, where each set is assigned a <i>channel</i> number (1 to 200). You can use Figure 3-4 to find details on the selections available on the CHAN menu.
FREQ	Frequency mode: you can select manually the frequency (free tune mode) and the other parameters to be used. You can use Figure 3-5 to find details on the selections available on the FREQ menu.
ALE	ALE mode: when you want to call other radio, the radio automatically sets up a link on the best free frequency that can be found. You can also call specific radio sets, a group of radio, or broadcast to all the radio sets. The sets of parameters needed for this operation mode are stored under <i>net</i> numbers (1 to 20), the radio sets are identified by addresses stored by the radio in a directory supporting up to 100 addresses.
SCAN	SCAN mode: when neither the ALE, nor the CCIR mode, is used, you can define a set of channels to be scanned before starting a call. The scan parameters are always loaded by the MRC together with the other operational parameters, and cannot be changed using the Micom panel.
BIT	BIT mode: lets you check that the Micom is OK.
LOCK	Lock the radio to prevent unauthorized use. To lock and unlock, you enter a password.
PROG	Programming mode: lets you program (select and store) the required parameters. Refer to Chapter 4 for details on the selections available on the PROG menu.
PSW	Used to change the password.
DIM	Used to adjust LCD lighting.
SPKR	Used to enable/disable the internal speaker.

3-4.3 Notational Conventions

In this manual, the following conventions are used to simplify the description of the steps you need to carry out actions using the keys and the LCD:

When a procedure begins with a sequence of steps, that sequence is represented in an abbreviated format, with the > symbol indicating the next key to be pressed.

For instance, the following represents a sequence of steps that involves five key pressings: **MENU > MORE > PROG (F2) > RAD (F1) > CHAN (F1)**.

3-5. GETTING STARTED

This section provides basic operating instructions: it covers issues such as turning the radio on and off, preparing it for operation in your particular environment, receiving and transmitting, selecting a channel or a frequency, etc.

NOTES

- The information needed to use Micom in the ALE mode appears in para. 3-12.
- The information needed to use the Micom GPS receiver appears in para. 3-9.

You can use these instructions to start using your Micom radio. To become familiar with all the radio capabilities and features, refer to the following sections. In most cases, the radio reaches you after being configured for use in your radio net. However, if you need to make changes, refer to Chapter 4.

3-5.1 Turning the Radio On and Off

To turn the radio on:

1. Turn the **ON/OFF/VOLUME** knob clockwise to midrange. You may hear a click as the radio is turned on.
2. The display turns on and shows SELF TEST for a few seconds.



NOTE
If the display is too dim, adjust its brightness using **MENU > MORE > DIM**.



3. If the self-test procedure is successfully completed, the radio automatically resumes operation in the last used mode (CHAN, FREQ, ALE, or SCAN).
4. If necessary, adjust the volume control for your convenience.



NOTE

To increase the battery life, Micom Pathfinder has an automatic dimmer feature. The automatic dimmer feature turns the lighting off (that is, automatically sets the dimmer level to 0) when the radio is not in use for 20 seconds. However, as soon as you press any key or the PTT, the lighting is automatically turned on at the operator-selected brightness, and remains ON for 20 seconds after the last key pressing, or after the PTT is released.

If automatic dimming is enabled (**DIM** is **YES**), the display may turn off after a few seconds of inactivity. To cancel this feature, use **MENU > MORE > PROG > RAD > PRMT > DIM** to select **NO** for **DIM**.

If a problem is detected during self-test, the display shows ERR and a code number, followed by a concise description of the error (if the description does not fit in one row, its parts alternate in the display). If the detected problem does not prevent using the radio, press **EXIT** to cancel the display and continue.

To turn the radio off:

Turn the **ON/OFF/VOLUME** knob counterclockwise beyond the detent. You may hear a click as the radio is turned off.

The display turns blank.

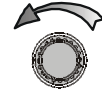
**3-5.2 Preparation for Operation****3-5.2.1 Antenna Type Selection**

After turning the Micom Pathfinder on, it is necessary to check the antenna type, and change it as necessary.

Use the following procedure to select the antenna type:

1. Press the **MENU** key, and scroll to **MENU > MORE > PROG > RAD**, to display the **RADIO PROGRAMMING** screen.
2. Navigate to the last item (next to F4) on the **RADIO PROGRAMMING** screen, which shows the current antenna type:
 - **WHI** – whip, for example, FAD5530. In this case, the internal antenna tuner is automatically enabled (select **ON** on the **MENU>MORE>PROG>ACC TUNE** screen) and it is not possible to disable the tuner as long as the selected antenna is **WHI**.
 - **DIP** – dipole, for example, FAA5548. When you select **DIP**, the internal antenna tuner is disabled by default (**NONE** on the **MENU>MORE>PROG>ACC TUNE** screen), however you can enable the tuner if necessary (for example, it is recommended to enable the tuner when using a long wire antenna configuration for operation over a wide range of frequencies, for example, in the ALE mode).

If necessary, press F4 to toggle the selection.

NOTE

When the tuner is enabled, you will see **TUNE** on the default CH (channel) mode screen.

In addition, when you change the operating channel, you will see for a few seconds a **...TUNE...** message on the screen: this indicates that the tuner adjusts automatically to operation on the new frequency.

3. If you select **DIP** and want to enable the tuner, navigate to **MENU>MORE>PROG>ACC**, and press F2 (**TUNE**). Note however that this setting is lost when Micom Pathfinder is turned off. Therefore, the next time Micom Pathfinder is powered up you must be select **TUNE** again if the tuner must be used when the antenna is set to **DIP**.

At this stage, you can start using Micom Pathfinder in accordance with the standard operating procedures.

3-5.2.2 Enable/Disable the Internal Loudspeaker

When you do not want to use the internal loudspeaker (for example, when connecting the external loudspeaker, LS-108M), use the following procedure:

1. Press the **MENU** key, and press the **MORE** key twice to reach **SPKR**. The screen displays the current state, **SPEAKER OFF** or **SPEAKER ON**.
2. To toggle the state, press F3. The screen displays the new state.

3-5.2.3 Radio Filter Bandwidth and Service Type

The radio filter bandwidth must be selected in accordance with the type of signal to be transmitted and received. For the transmit mode, the type of signal is identified by detecting the active PTT signal, which is one of the following:

- MIC PTT – PTT from the microphone connected to the front panel AUDIO connector; transmits your voice.
- Data PTT – PTT from a data device, for example, a modem, connected to the radio set through the DATA connector; it causes the radio to switch to the data mode and transmit the modem signal.

The radio operating mode is automatically adapted for best performance with the signal expected for the detected PTT type.

A default filter bandwidth can be configured for each channel using **MENU > MORE > PROG > RAD > CHAN** (if no particular filter is set for the current channel, the radio retains the previously used filter). When a new type of call is received or sent, the bandwidth filter changes automatically, depending on the PTT source (voice, data or CW), and the programmed bandwidth for the channel being used.

Bandwidth set to:	Service type:	Filter changes after:
2.1 kHz	Data	First data PTT
2.7 kHz	Voice	First microphone PTT
3.0 kHz	Data	First data PTT
3.3 kHz	High speed data	First data PTT
CW	Morse	First CW PTT
LSM	Low speed data	First data PTT

NOTE

When the filter bandwidth is set to CW, the following CW filter bandwidths can be configured in the Programming mode using **MENU > MORE > PROG > RAD > PRMT**: 0.25, 0.5 or 0.8 (kHz).

3-5.3 Transmitting and Receiving

CAUTION

Do not transmit with radio on your back. Place radio on ground before starting transmit/receive communication, and connect it to the grounding spike in accordance with Chapter 2.

To transmit a voice message:

Press and hold down the Push-to-Talk (PTT) button of the microphone, and speak slowly and clearly after the channel is clear.

You should hear a sidetone, which verifies that your radio transmits normally.

NOTE

No sidetone is heard when using the optional vocoder.

The display changes to show the TX bar, together with indications of forward and reflected power.

During normal speech, these indications fluctuate in accordance with your voice.

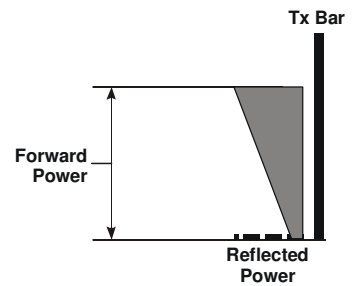

To receive calls:

When the radio identifies a call addressed to it, it sounds a beep and if it is a voice message – you start hearing it in the speaker. The display shows the name of the calling station (blinking) and the call type. The display now shows the RX indication, which is proportional to the received signal strength.

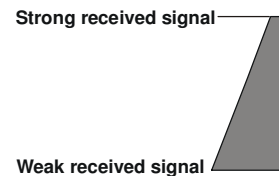

3-6. USING THE CHANNEL MODE

The Channel mode is used to operate on a channel already programmed in the Micom.

The following sections describe how to use the Channel mode.

3-6.1 Channel Mode Options

In the Channel mode, you can operate a variety of functions and options which can help eliminate noise, or otherwise assist reception and/or transmission.

The structure of the CHAN menu is shown in Figure 3-4.

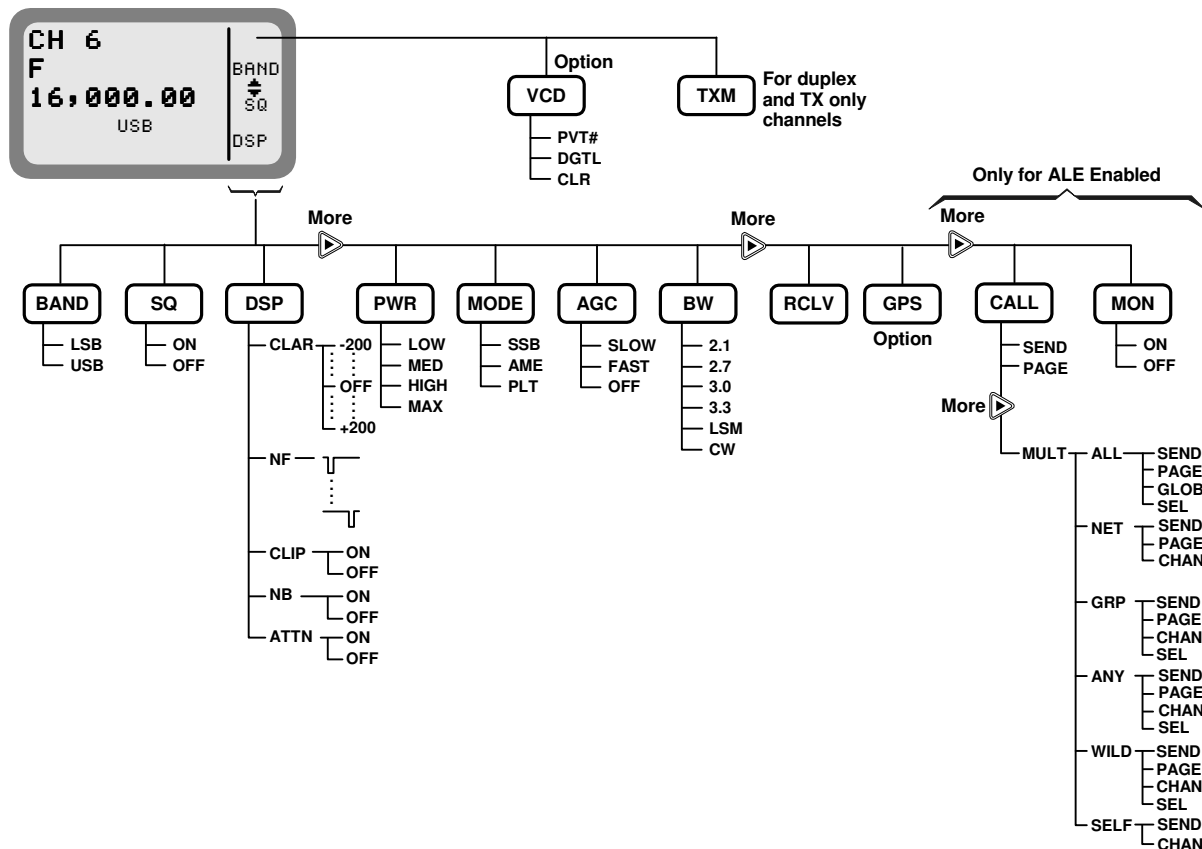

Figure 3-4. Channel (CHAN) Menu

NOTES

- The changing of channel options is temporary. When you select a different channel, all the current options will be lost and replaced by the values configured for the newly selected channel.
- The **RCLV** item appears only if the received signal level display is not permanently enabled using **MENU>PROG>RAD>PRMT> RCLV**.
- The **GPS** item appears only if your radio includes the GPS option.

The following table presents a concise description of the options available in the Channel mode.

Option	Description
TXM	Press to switch to the channel transmit frequency (appears only when using a duplex or Tx only channel). After releasing, the radio returns to the receive frequency. For a Micom with the internal vocoder option, this position displays PVT, DGTL, or CLR. Pressing F1 then toggles the operating mode of the vocoder.

Option	Description
BAND	Toggles between upper sideband (USB) and lower sideband (LSB).
SQ	Toggles the squelch on/off. Always select OFF for CW operation.
DSP	Accesses the Digital Signal Processing menu, which includes the following options: <ul style="list-style-type: none"> • CLAR Controls the clarifier (off/lower frequency/higher frequency). The function key is not available for TXO (transmit only) channels. • NF Controls the notch filter (off/lower frequency/higher frequency). The function key is not available for TXO (transmit only) channels. • CLIP Toggles the clipper on/off. • NB Toggles the noise blanker on/off. • ATTN Toggles the attenuator on/off.
PWR	Selects the transmit power level: LOW – 5W; MED – 10W; HIGH – 15W; MAX – 25W.
MODE	Selects the operation mode: <ul style="list-style-type: none"> • SSB – single sideband • AME – amplitude modulation equivalent • PLT – single sideband with pilot signal.
AGC	Controls the automatic gain control function (fast/slow/off).
BW	Selects the filter bandwidth: <ul style="list-style-type: none"> • 2.1 – 300 to 2100 Hz • 2.7 – 300 to 2700 Hz • 3.0 – 300 to 3000 Hz • 3.3 – 300 to 3300 Hz. Always select this bandwidth for data transmission • LSM – bandwidth optimized for use with low speed modems (1450 to 1950 Hz) • CW (Continuous Wave or Morse operation). The bandwidth used in this case is selected by MENU > PROG > RAD > PRMT > CW.
RCLV	Displays the receive level. The RCLV item appears only if the received signal level display is not permanently enabled using MENU > PROG > RAD > PRMT > RCLV .
GPS	Displays the GPS data. Refer to para. 3-9 for details.

NOTE

When ALE is active, the following options appear:

- **CALL** – initiates an ALE call.
- **PAGE** – displays the stacked received messages.
- **MON** – enables/disables the speaker during link establishment.

For a description of these options, refer to para. 3-12 (ALE mode).

3-6.2 Selecting the Channel Mode

In general, the Micom automatically enters the Channel mode when it is turned on, and starts using the last used channel.

If not, use the Menu screen to select the Channel mode: this is the first item on the menu you see when you press **MENU**.

To enter the Channel mode:

1. Press **MENU** to display the Menu screen.

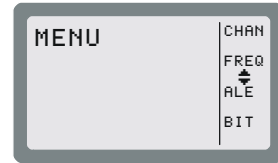

2. Press **CHAN**.

The last active channel flashes in the display.

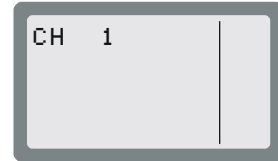

3. Press **ENTER** to confirm your choice, or select another channel as explained in para. 3-6.3.



3-6.3 Choosing a Different Channel

To choose a channel:

1. Press **MENU** to display the menu screen, and press **CHAN**.

The last used channel number is displayed, blinking.

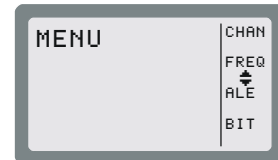

NOTE

To access the priority channel, press **ESC** momentarily. The priority channel is available only in the Scan mode, that is, when ALE is disabled, provided it has been preprogrammed by the MRC.

2. Select a channel by pressing the **UP/DOWN** keys until you reach the required channel,

or

Type the desired number in the keypad.

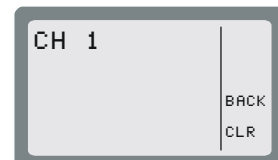

Example: To choose channel 12:

The channel number blinks, indicating that the selection has not yet been confirmed.

Type 12

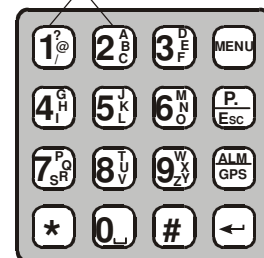

3. When the desired channel is displayed, press **ENTER** to confirm your choice.

NOTE

If you enter a channel that is not yet programmed, a NOT PROG message appears. To program a new channel, refer to Chapter 4, or use the MRC software.

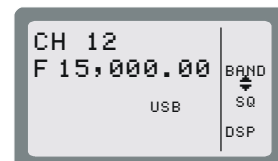

3-7. USING THE FREQUENCY MODE

The Frequency mode enables you to select freely the receive and transmit frequencies. You can select the operating frequency type, change the frequency being used, and operate a variety of functions and options to assist transmission and reception. You can also store the frequency in a channel of your choice.

There are four types of operating frequencies:

- **SMPX** (Simplex Frequency): the same frequency is used for both transmission and reception.
- **DPLX** (Duplex Frequency): the radio transmits on one frequency and receives on a different frequency.
- **RXO** (Receive Only Frequency): defines a frequency for reception only. You cannot transmit on a frequency configured as RXO.
- **TXO** (Transmit Only Frequency): defines a frequency for transmission only. You will not receive on a frequency configured as TXO.

The supported frequency ranges are:

- Reception: 100 kHz to 30 MHz.
- Transmission: 1.6 to 30 MHz.

NOTES

- The Frequency mode is accessible only if the radio is not locked. To unlock, refer to para. 3-10.
- ALE and Frequency modes are mutually exclusive.

3-7.1 Frequency Mode Options

In the Frequency mode, you can operate a variety of functions and options which can eliminate noise or otherwise assist reception and/or transmission.

The structure of the **FREQ** menu is shown in Figure 3-5.

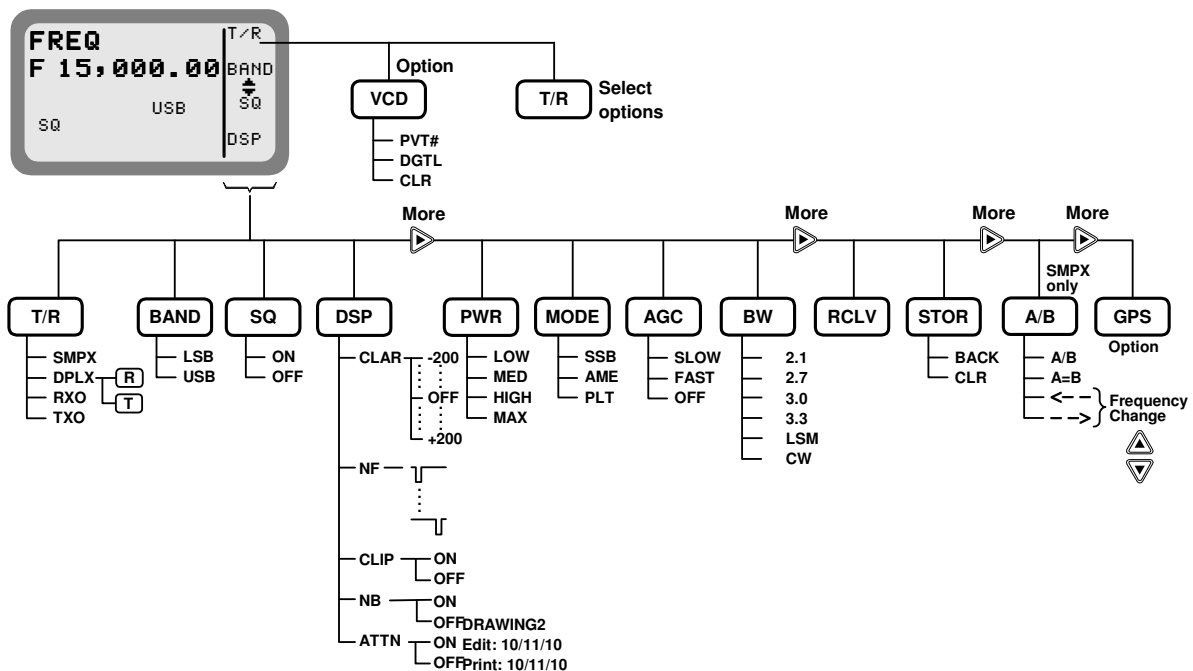

Figure 3-5. *FREQ (Frequency) Menu*

The following table presents a concise description of the options available in the Frequency mode.

Option	Description
T/R	Selects the transmit and receive frequencies and frequency type. For a Micom with the internal vocoder option, this position displays PVT, DGTL, or CLR. Pressing F1 then toggles the operating mode of the vocoder.
BAND	Toggles between upper sideband (USB) and lower sideband (LSB).
SQ	Toggles the squelch on/off. Always select OFF for CW operation.
DSP	Accesses the Digital Signal Processing menu, which includes the following options: <ul style="list-style-type: none"> • CLAR Enables to control the clarifier (off/lower frequency/higher frequency). The function key is not available for TXO (transmit only) channels. • NF Enables to control the notch filter (off/lower frequency/higher frequency). The function key is not available for TXO (transmit only) channels, and in the CCIR mode. • CLIP Toggles the clipper on/off. • NB Toggles the noise blanker function on/off. • ATTN Toggles the attenuator on/off.
PWR	Selects the transmit power level: LOW – 5W; MED – 10W; HIGH – 15W; MAX – 25W.
MODE	Selects the operation mode: <ul style="list-style-type: none"> • SSB – single sideband • AME – amplitude modulation equivalent • PLT – single sideband with pilot signal.
AGC	Controls the automatic gain control (fast/slow/off).
BW	Selects the filter bandwidth. <ul style="list-style-type: none"> • 2.1 – 300 to 2100 Hz • 2.7 – 300 to 2700 Hz • 3.0 – 300 to 3000 Hz • 3.3 – 300 to 3300 Hz. Always select this bandwidth for data transmission • LSM – bandwidth optimized for use with low speed modems (1450 to 1950 Hz) • CW (Continuous Wave or Morse operation). The bandwidth used in this case is selected by MENU > PROG > RAD > PRMT > CW.
RCLV	Displays the receive level. The RCLV item appears only if the received signal level display is not permanently enabled using MENU > PROG > RAD > PRMT > RCLV .
STOR	Stores the frequency parameters in the selected channel.
< -- and -- >	Move the cursor backwards and forwards. When these function keys are used in conjunction with the UP/DOWN scroll keys, the frequency scrolls according to the location of the cursor, enabling you to change the frequency with greater ease.
GPS	Displays the GPS data. Refer to para. 3-9 for details.

NOTES

- The **RCLV** item appears only if the received signal level display is not permanently enabled using **MENU>PROG>RAD>PRMT> RCLV**.
- The **GPS** item appears only if your radio includes the GPS option.

3-7.2 Selecting the Operating Frequency in the FREQ Mode

To enter the frequency mode:

1. Press **MENU** to display the Menu screen.

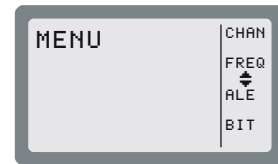

2. Press **FREQ** (F2). The last used frequency blinks, and the frequency type is displayed in the top line.



The letter preceding the frequency in the second line of the display indicates whether the frequency is used for Transmission (T), Reception (R) or both transmission and reception (F).

3. To use the displayed frequency and frequency type, press **ENTER**. If the Frequency type is DPLX, press **ENTER** twice to accept both transmission and reception frequencies.

or

Change the frequency type and the frequency as explained below.

To change the current frequency/frequencies:

1. If you are not in Frequency mode, press **MENU** to access the Menu screen, and press **FREQ** (F2).

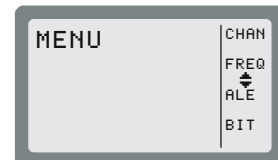

The last used frequency blinks, and the frequency type is displayed in the top line.



or

If you are already in the Frequency mode, press **MORE** until the T/R function appears next to the F1 function key, and then press **T/R** (F1).



The current frequency type is displayed in the top line, followed by the frequencies in use.



2. If necessary, change the frequency type by pressing the relevant function key: **SMPX** (F1), **DPLX** (F2), **RXO** (F3) or **TXO** (F4).

NOTE

Different frequency types may have default frequency settings, which will appear automatically when that frequency type is selected.

- If you are using the SMPX, RXO or TXO frequency type, and you wish to use the displayed frequency, press **ENTER**.

or

Enter a new frequency. There are two ways to change the frequency.

Method A:

- Press **LEFT/RIGHT** to move the cursor to the digit in the frequency value that you want to change. The blinking digit indicates the cursor location.
- Press **UP/DOWN** to scroll to the value of your choice.

Method B:

- Type the frequency on the keypad. The frequency digits blink, indicating that the selection has not yet been confirmed.
- When the desired frequency is displayed, press **ENTER** to confirm your choice.

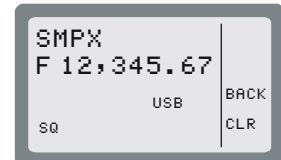

- If you are using the DPLX frequency type, the frequency displayed first is the Rx frequency. If you want to use the displayed frequency, press **ENTER**.



or

Enter a new frequency.

The frequency digits blink, indicating that the selection has not yet been confirmed.

When the desired frequency is displayed, press **ENTER** to confirm your choice.



- After confirming the Rx frequency, the Tx frequency blinks in the display.

If you want to use the displayed Tx frequency, press **ENTER**.



or

Enter a new frequency.

The frequency digits blink, indicating that the selection has not yet been confirmed.

When the desired frequency is displayed, press **ENTER** to confirm your choice.



- Press **ENTER** to confirm the frequency type and the frequencies you have set.



3-7.2.1 VFO Operation

VFO (Variable Frequency Offset) is a feature available in the Simplex mode, that enables you to operate the transceiver simultaneously on two different channels, designated A and B.

- Using the A/B function, you can “freeze” the frequency of channel A, switch to channel B and then return to channel A again.
- Using the A=B option, you can copy the frequency of the current channel to another channel.

To operate the VFO function:

1. If you are not in the Frequency mode, enter the Frequency mode and verify that the frequency type is Simplex: **MENU** > **FREQ** (F2) > **SMPX** (F1) > **ENTER**.

For more information, see page 3-20.



2. Select the required frequency and press **ENTER** to confirm your choice.

3. Press **MORE** until the **A/B** function appears next to the F1 function key.



4. Press **A/B** (F1) to select the A/B mode.

The **A=B** function appears next to the F2 function key' together with the first frequency (frequency A).



5. Press **A/B** (F1) to alternate between the two frequencies.



6. Press **A=B** (F2) to copy the frequency of the displayed channel to the alternate channel.

7. You can adjust the frequency of either A or B at any time, using the following methods:

- Press **<--** (F3) and **-->** (F4) to move the cursor backwards and forwards, depending on the digit you wish to change, and then type the desired digit on the keypad.
- When **<--** (F3) and **-->** (F4) are used in conjunction with the **UP/DOWN** scroll keys, the frequency digit scrolls according to the location of the cursor.

For instance, if the current frequency is 15,400.54 and the cursor is at the 100 kHz location (15,_00.54), pressing the **UP/DOWN** scroll key will scroll the 100 kHz digit to 1,500.54; 15,600.54; 15,700.54 and so on.



To return to the regular Frequency mode:

1. Press **MORE** until the **T/R** function appears next to the F1 function key.
2. Press **T/R** (F1) to select the regular mode.

3-7.3 Storing Frequencies

You can store specific frequencies and frequency parameters in channels which you have programmed.

To store a frequency in a channel:

1. If you are not in the Frequency mode, press **MENU** to display the Menu screen.
2. Press **FREQ**.

The last used frequency blinks, and the frequency type is displayed in the top line.

3. If you wish to use the displayed frequency and frequency type, press **ENTER**. If the frequency type is DPLX, press **ENTER** twice to accept both transmission and reception frequencies.

or

Change the frequency type and the frequency as required (see para. 3-7.1).

4. If necessary, select the other parameters, using the **MORE** key and pressing the required function keys.
5. Press **MORE** twice, and then press **STOR**.

3-8. USING THE SCAN MODE

The Scan mode is available only when ALE is turned off by selecting **NONE** on **MENU > PROG > RAD > OPTS > ALE**.

In the Scan mode, Micom scans preprogrammed channels. In addition, when a guard channel is selected, it is monitored after every other scanned channel.

The channels used in the Scan mode are organized in groups (you can use the Scan function only after at least one group has been downloaded by means of the MRC). Up to five scan groups, identified as A to E, may be created using the MRC, each containing up to 200 channels.

3-8.1 Selecting the Scan Mode

1. Press **MENU** to display the Menu screen.
2. Press **SCAN**. The last used group flashes in the display.

NOTE

If no scan group is stored in the radio, after selecting Scan you will see NO GROUPS, and then the display skips to the PROG menu.

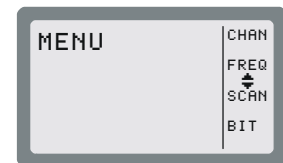

3. If you want to use the currently displayed scan group, press **ENTER**. To select another group, press the function key corresponding to the group you want to choose, and then press **ENTER**.

NOTES

- In the Scan mode, one of the five groups is always selected, and the other groups (up to 4) are displayed next to the function keys.
- If the selected group is not yet programmed, the message GRP X EMPTY appears in the display, where X is the selected group.

3-8.2 Scan Mode Options

In the Scan mode the parameters that control the scanning and options, and options which can help eliminate noise or otherwise assist reception and/or transmission.

The following parameters control the scanning operation:

Option	Description
STOP	Stops the scanning. When scanning is stopped, the label changes to SCAN : pressing F1 again starts the scanning.
SLOW	Decreases the scanning speed.
FAST	Increases the scanning speed. The scan speed can be varied in the range of 150 milliseconds to 5 seconds: <ul style="list-style-type: none"> • From 150 to 950 msec, each F2 or F3 pressing results in a 50-msec change. • From 1 to 5 seconds, each pressing results in a 1-second change.
GRP	Selects a scan group

The other options are identical to those available in the Channel mode (see para. 3-6).

NOTE

The changing of the Scan mode options is temporary. When you exit the Scan mode and then return to Scan, all the current options will be lost and replaced by the values configured for the various channels.

3-9. USING THE GPS RECEIVER (OPTIONAL)

3-9.1 Overview of GPS Receiver Functions

The GPS receiver is an integral part of the Micom transceiver, and can be used whenever the GPS antenna supplied together with the Micom transceiver is properly connected and installed.

The GPS receiver provides accurate time and navigation data. The navigation data includes the geographical coordinates (position data) and the altitude. When the Micom transceiver is moving, you can also see the speed and direction (heading).

The format of the navigation data can be selected in accordance with your needs:

- **LLA format:** Latitude, longitude and altitude (LLA). The latitude and longitude are displayed in degrees, with a precision of hundredths of arc minutes (1/100 min); the altitude is reported in meters, relative to the mean sea level (MSL).

Velocity is reported as the change in the East, North, and Up coordinates, presented in meter/sec with a precision of 0.001 m/sec.

- **ECEF format:** Earth-Centered, Earth-Fixed format for position and velocity. Provides your position and velocity in a Cartesian (X, Y, Z) coordinate frame with its center at the Earth's center, the Z-axis through the North Pole, and the X-axis through 0 degrees longitude, 0 degrees latitude. The position is reported in meters.

Velocity for each axis (that is, is the change in the X, Y and Z coordinate) is displayed in meter/sec, with a precision up to 0.001 m/sec.

The time is always presented on basis of the UTC (Universal Time Coordinated).

The information collected by the GPS receiver can be displayed on the Micom display when using the CH and FREQ modes. In the ALE and CCIR modes, the position data can be reported by means of AMD messages; it can also be automatically reported in response to position queries (also sent by AMD messages).

3-9.2 How to Get the Best Results from your Micom GPS Receiver

The GPS receiver extracts the information it needs by analyzing the signals received from GPS satellites. These satellite periodically transmit navigation messages, where the transmission of each complete message requires almost 15 minutes. To calculate all the data your GPS receiver is capable of providing, it must receive and decode navigation messages from at least 4 GPS satellites (the GPS receiver can use as many as 8 satellites to improve accuracy).

Therefore, after turning a GPS receiver on for the first time after a long period of inactivity, it is essential to let the GPS receiver operate continuously for at least 15 minutes, to enable it to collect updated almanac data. After this initial 15-minute interval, a GPS receiver can relatively rapidly acquire the satellites and calculate its position; thereafter, a GPS receiver must remain on only for a few minutes in order to be able to provide navigation data.

The internal GPS receiver is always powered when the transceiver is turned on. Therefore, if the GPS antenna is connected, the GPS receiver can start the acquisition process as soon as the transceiver is turned on, and can then track the satellites continuously. Turning the Micom transceiver off will force the GPS receiver to reacquire the satellites.

3-9.3 Operating the GPS Receiver

3-9.3.1 GPS Menu

The GPS menu is displayed by selecting the GPS item on the FREQ or CH menu. The GPS menu structure is shown in Figure 3-6.

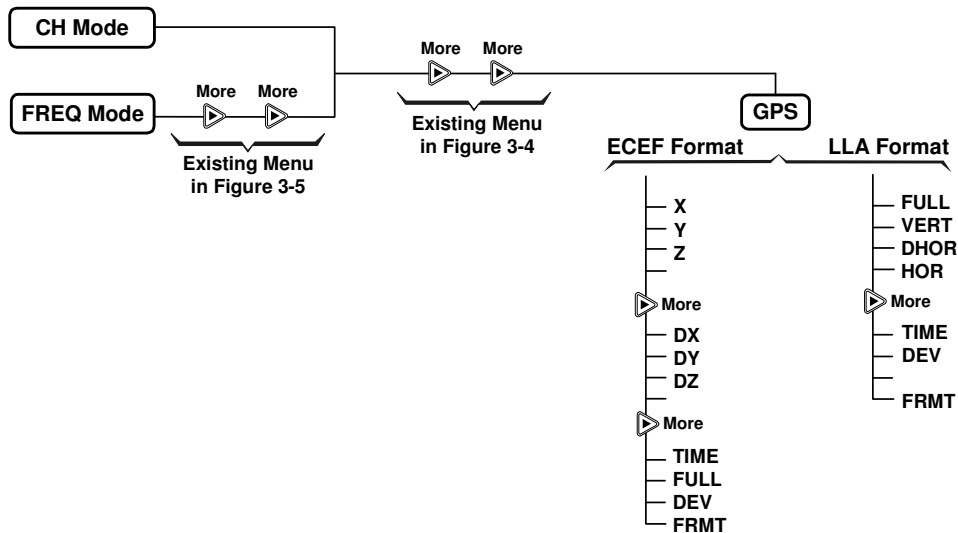

Figure 3-6. GPS Menu

The menu structure depends on the display format, **ECEF** or **LLA**, selected by the **FMT** item. You can also press the UP or DOWN panel key to toggle the display format.

- a. The items displayed on the GPS menu when using the LLA format are as follows:

FULL	Alternating display of the absolute velocity (VEL) in the horizontal plane, and its direction relative to the North (azimuth – AZIMTH).
VERT	Alternating display of altitude and up/down velocity.
DHOR	Alternating display of North/South and East/West velocities.
HOR	Alternating display of latitude and longitude.
TIME	Display the time-of-day obtained from the GPS receiver.
DEV	Used to check that the GPS receiver is operating.
FRMT	Toggle the display format (to ECEF).

- b. The items displayed on the GPS menu when using the ECEF format are as follows:

X	Display the X coordinate.
Y	Display the Y coordinate.
Z	Display the Z coordinate (altitude).
DX	Display the velocity along the X axis.
DY	Display the velocity along the Y axis.
DZ	Display the velocity along the Z axis.
TIME	Display the time-of-day obtained from the GPS receiver.
FULL	Alternating display of the absolute velocity (VEL), and its direction relative to the North (azimuth – AZIMTH).
DEV	Used to check that the GPS receiver is operating.
FRMT	Toggle the display format (to LLA).

3-9.3.2 First-Time Operation

The internal GPS receiver is always powered when the transceiver is turned on. Therefore, if the GPS antenna is connected and you are in a good place with a clear view of the sky, the GPS receiver can start the satellite acquisition process as soon as the transceiver is turned on, and can then track the satellites continuously.

Thus, the **GPS** item on the **FREQ** or **CH** menu only enables/disables the display of GPS data: the result is that after selecting **GPS**, the GPS data can be immediately displayed, and is updated once per second (time is updated once every 5 seconds).

Before using the GPS receiver, turn the Micom transceiver on and let it operate for at least 15 minutes.

3-9.3.3 Operating Instructions

3-9.3.3.1 Switching to the GPS Display

NOTE

You cannot switch to the GPS display if you are using the ALE mode.

1. Select the **GPS** item by scrolling with the **MORE** key on the **FREQ** or **CH** menu, and then pressing **F2**. You will see a message that indicates the current display format, **GPS LLA** or **GPS ECEF**.
2. If necessary, switch to the alternate display format by pressing the **UP** or **DOWN** key.
Alternatively, you can use the **GPS** menu: press **MORE** as required to see **FMT**, and then press the key next to **FMT (F4)**.
3. If the GPS receiver operates normally and is ready, you will see the information selected the last time the receiver has been used.

3-9.3.3.2 Selecting what to Display

1. Press the key next to the type of information you want to see: use Figure 3-6 to find the key to be pressed.
2. The displayed information appears on the display and is automatically updated every second. The time is updated every 5 seconds.
3. To change the display of GPS information, scroll to the desired item.
4. To cancel the display of GPS information, select any other menu except **GPS**.

3-9.3.4 What to do if ...

1. If the GPS display mode, **GPS LLA** or **GPS ECEF**, does not appear when switching to the **GPS** display, scroll to the **DEV** item. You should see the GPS receiver type.
 - If you see **UNKNOWN**, turn the Micom transceiver off and after a few minutes turn it back on. If the problem persists, the GPS receiver must be serviced.
 - If you see **NONE**, your Micom transceiver does not include the optional GPS receiver.
2. If the requested information does not appear within 15 minutes, but the check in Step 1 above is successful, check for proper connection of the GPS antenna cable to the rear GPS antenna connector of the transceiver.
3. After checking that the antenna is properly connected, check that the GPS antenna did not shift from its intended position, and has a clear view of the sky. Try to improve your location: avoid locations near trees, high buildings or steep hills.

3-10. LOCKING/UNLOCKING THE RADIO

You can use the Lock mode to prevent unauthorized persons from accessing the programming and frequency modes.

To enter the Lock mode, you need to provide a password which consists of six digits. See para. 3-11 for instructions on configuring the desired password.

To lock the radio:

1. Press **MENU** to display the Menu screen.

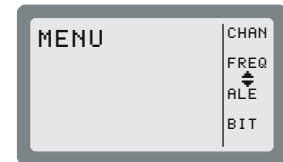

2. Press **MORE** to scroll to the second Menu screen.

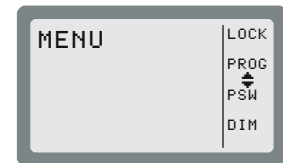

3. Press **LOCK**.



4. Enter the password to lock the radio.

NOTE

If you enter the wrong password, you will see **WRONG PSW!**. Enter the password again.

5. Press **O.K.** or **ENTER** to confirm.

To unlock the radio:

Use the same procedure as when entering the Lock mode.

3-11. CHANGING THE PASSWORD

To be able to lock the radio, it is necessary to use a password. For security reasons, you may want to change the password often. The factory-default password is 123456.

To change the password:

1. Press **MENU** to display the Menu screen.

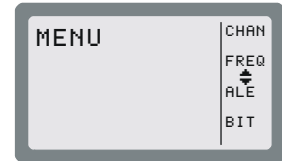

2. Press **MORE** to scroll to the second Menu screen.



3. Press **PSW**.
4. Enter the old password, using the keypad.

When you start to enter the password, you can use the function keys to move the cursor to the left or right, or to clear the display and enter the complete string.

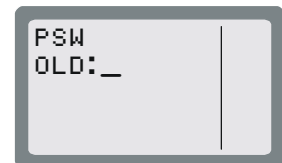

NOTE

If you have not yet set a password, use the factory-default password, 123456.

5. Press **O.K.** after you enter the old password.
If you enter the wrong password, Micom displays an error message, and you cannot continue.
6. After entering the correct password, you enter a new password.
7. Press **O.K.** to confirm the new password.

3-12. USING AUTOMATIC LINK ESTABLISHMENT (ALE)

The Micom unit supports the Automatic Link Establishment (ALE) function, a method that enables automatically selecting the best working channel from a group of preprogrammed channels without any user intervention, thereby facilitating communication among HF radio stations and improving the communications quality and reliability. The ALE function incorporates all the advanced data transmission techniques required by MIL-STD-188-141B and FED-STD-1045. For an overview of Micom ALE capabilities and services, refer to Appendix C.

The ALE function ensures the best possible link without requiring prior knowledge of radio communication conditions, and thus enables reliable HF communication even under rapidly changing propagation conditions. For this purpose, HF radio sets using the ALE function continuously monitor and evaluate the transmission quality on each frequency assigned for communication, and automatically select an optimal frequency for each transmission. After selecting the optimal frequency, a link between the communicating stations is established via an automatic handshake process, which is performed without requiring operator's intervention.

ALE combines sounding, scanning, selective calling, channel selection and LQA (Link Quality Analysis). These features, all automatic, ensure that communication takes place on the channel with the best link quality, even with an unskilled operator. The ALE also includes many types of calls you can use to rapidly and efficiently set up links with other ALE users, and features such as messages, stack and quick call.

ALE supports many features, including:

- Various type of calls
- Up to 20 nets, each with its own set of members and associated frequencies (channels)
- Up to 100 ALE addresses in the directory
- Up to 100 scan channels
- Up to 12 AMD (paging) messages.

All the ALE features you can use on your radio can be programmed: to program or modify features, you can use the front panel of the radio, as described in Chapter 4. The ALE features can also be preprogrammed using the MRC.

The following sections provide instructions for communicating in the ALE mode for a radio that has already been programmed with the necessary parameters in accordance with Chapter 4.

Note that when the ALE mode is enabled, your radio can receive and transmit ALE calls even when you are using the Channel mode. For this purpose, the **CALL** key is displayed even in the Channel mode (see Figure 3-4). The only restriction is that in the Channel mode, Micom uses only the ALE parameters of net 1. Therefore, if net 1 is not programmed, no ALE functionality is available in the Channel mode, even when the ALE mode is enabled.

Note that the radio will prevent users from performing calls on Rx only (RXO) or Tx only (TXO) channels. This is true even when operating in the Channel mode: when selecting a Rx Only or Tx Only channel, the ALE option is disabled (the **CALL** key is not displayed when such a channel is selected).

3-12.1 Enabling the ALE Mode

To enter the ALE mode:

1. Press **MENU** to display the Menu screen.

NOTE

If you see **CCIR** or **SCAN** next to F3, first enable the ALE mode. To enable ALE, select **ALE** on **MENU > MORE > PROG > RAD > OPTS > SLCL**.

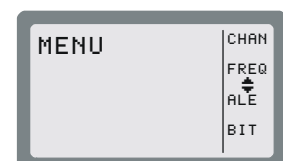

2. Press **ALE**.

The last active net flashes in the display.

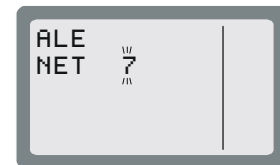

3. To use the displayed net, press **ENTER**.

To select another net:

- Press the **UP/DOWN** keys until you reach the required number.
- or
- Type the desired net number on the keypad.

The new net number blinks, indicating that the selection has not yet been confirmed.



4. Press **ENTER** to confirm your choice.

The radio then starts scanning the channels in the selected net (the changing channel number appears to the right of the net number).

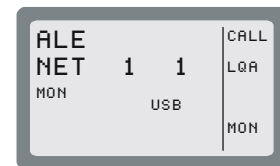

3-12.2 ALE Mode Options

Figure 3-7 shows the operator options available in the ALE mode.

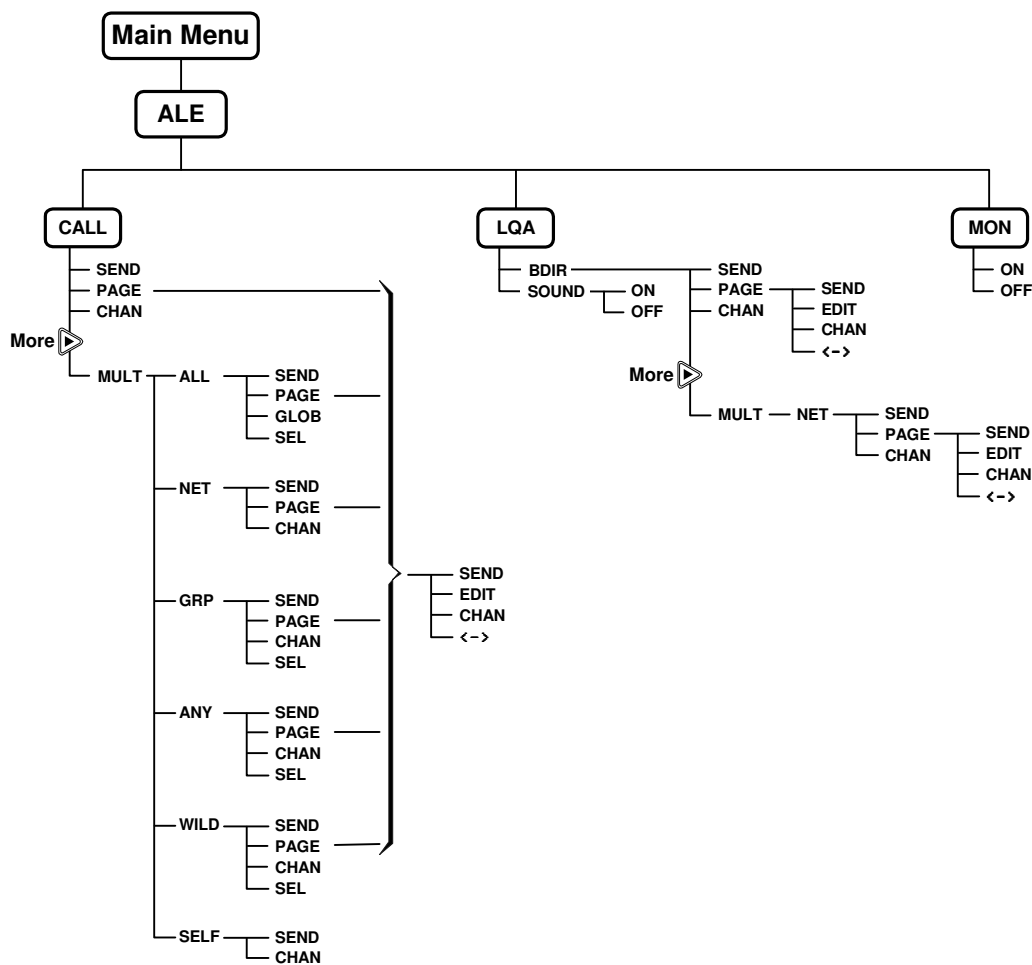

Figure 3-7. ALE Operator Menu

3-12.3 Receiving and Transmitting Calls in ALE Mode

The Micom supports the following types of ALE calls:

- Individual call – call directed to a specific station.
- Net call – call directed to a net (a net is a preprogrammed group of stations).
- Group call – call directed to a group of stations.
- AllCall – call directed to all other stations simultaneously (broadcast call); can also be used as a distress call.
- AnyCall – call directed to all other stations simultaneously, usually used to detect new stations.
- Wildcard call – call simultaneously addressed to a selected group of stations within a net, with wildcards used within the address to specify the desired stations. For efficient use of wildcards, an appropriate station naming plan must be in place.
- Self call – call using the station’s own address, generally used for test purposes.
- Bidirectional call – request for updating the LQA score with another station or stations.
- Sounding call – used to build a link quality database. This database stores ongoing information on the current quality of the various channels programmed for use by your radio.

All types of calls, except for sounding calls, can also carry messages.

Using the ALE message service, you can also request remote stations equipped with GPS receivers to send their position. Moreover, if the GPS receiver of your radio is operational, you can also send your position to other radio sets.

NOTE

Micom also supports the MultiNet feature. When this feature is enabled, Micom can receive and transmit ALE calls in several different nets (up to 20). See details in Appendix C.

During ALE calls, a link is established between the stations participating in the call. During the link state, the radio operators have various options, many of them similar to the options available in the Channel mode. For a description of the link options, see pages 3-33 to 3-36.

3-12.3.1 Receiving Calls in ALE Mode

When your Micom receives a call, it displays its type and the source address.

You are also notified when a message is attached: if a message is received, the name of the calling station is preceded by an exclamation mark.

For any type of call, if the ALERT attribute is programmed to YES, you will hear the alert tone when a message is received.

Receiving an individual call:

When an individual call (i.e., a call addressed only to your station) is received, the name of the calling station blinks in the display.



NOTE

If the calling station name is too long and does not fit in the display, <--> appears next to F1. Press <--> to enter the View mode (see page 3-6).



Receiving a net call:

When your radio receives a net call (i.e., a call addressed to all the stations in your net), the display flashes a net call alert that alternates the words **NET CALL** with the calling station name.

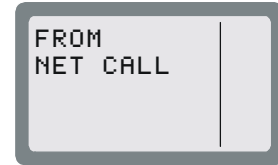

Receiving an AllCall:

NOTE

You can program your radio to ignore incoming AllCalls. If the radio is set to ignore incoming AllCalls, it stops scanning when an AllCall is received but it does not display, nor lets you hear the call. At the end of the AllCall, the radio automatically returns to the scanning mode.

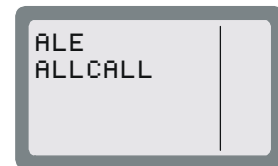

When an AllCall is received, the display flashes an AllCall alert that alternates **ALLCALL** with the calling station name.

Receiving an AnyCall:

NOTE

You can program your radio to ignore incoming AnyCalls. If the radio is set to ignore incoming AnyCalls, it stops scanning when an AnyCall is received but it does not display, nor lets you hear the call. At the end of the AnyCall, the radio automatically returns to the scanning mode.

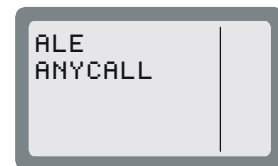

When an AnyCall is received, the display flashes an AllCall alert that alternates **ANYCALL** with the calling station name.

Receiving a sounding call:

When the radio is in the ALE mode and it receives a sounding call from another station, the calling station name appears in the display, preceded by the letter **S** to identify that the call is a sounding call.

Within a few seconds, the radio automatically returns to the mode used before the call was received.



Receiving a bidirectional handshake call:

When the radio receives a bidirectional handshake call from another station, your radio responds automatically, without your intervention. Within a few seconds, the radio automatically returns to the mode used before the call was received.

If the bidirectional handshake includes a message, the calling station name and the received message are stored in the stack, and the **STAK** function key appears.

To answer an incoming call:

Press any key (including PTT, but not **ESC**) to accept the call. The calling station name stops blinking, and is displayed steadily. The alert tone is no longer heard. The radio is now in the link state with the calling station.

NOTE

When an AllCall is received, no link is actually established but you can hear the calling station.

If the received call includes a message, an exclamation mark precedes the station name, and the name is followed by a colon and the message.

If the calling station name and message are too long and do not fit in the display, press < - > to enter the View mode, where you can scroll right and left to display the whole message.

To display LQA for the received call:

Press **LQA**. You will see the channel in use, and its LQA score.

3-12.3.2 The Link State

After the radio successfully receives or transmits a call, it is in the link state.

If the call was received from another radio, the display includes the word **FROM** in the first line, as well as the name of the station which initiated the call (if a message has been received, it is also displayed).

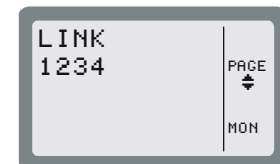

If the call was initiated by your radio, the display includes the word **LINK** in the first line, as well as the destination address.

**3-12.3.2.1 Link State Options**

While in the link state, you can operate the following functions using the function keys.

NOTE

The change of link options is temporary. When you exit the link state, all the changed parameters will be lost.

Option	Description
< - >	Activates the View mode, where you can view the entire station address.
Page	Enables you to select a message to be sent to the station you are linked to. After a message is selected, you can edit it. The PAGE function is not available when receiving an AllCall.
LQA	Displays the channel on which the link was established, and the LQA score of the current link. If the name of the station you are linked to is not in your directory, this function will not be available. The LQA key is displayed only if you established the link in the ALE mode (in the Channel mode, this function is not available, because the call is received/transmitted on the current channel).
MON	Turns on and off monitoring by means of the speaker.
RPL	Replaces the currently-used channel with a channel with a better LQA score. The radio disconnects the link, replaces the channel being used, and initiates the call once again. The RPL function is available only for individual calls, and only for the call initiator. The RPL key is displayed only if you established the link in the ALE mode (in the Channel mode this function is not available, because the call is received/transmitted on the current channel).

Cont'd

Option	Description
BAND	Toggles between upper sideband (USB) and lower sideband (LSB). The sideband change takes places only after the current call is ended.
SQ	Toggles the squelch on/off. Always select OFF for CW operation.
DSP	Accesses the Digital Signal Processing menu, which includes the following options: <ul style="list-style-type: none"> • CLAR Enables to control the clarifier (off/lower frequency/higher frequency). The function key is not available for TXO (transmit only) channels. • NF Enables to control the notch filter (off/lower frequency/higher frequency). The function key is not available for TXO (transmit only) channels. • CLIP Toggles the clipper on/off. • NB Toggles the noise blanker on/off. • ATTN Toggles the attenuator on/off.
PWR	Selects the transmit power level: LOW – 5W; MED – 10W; HIGH – 15W; MAX – 25W.
MODE	Selects the operation mode: <ul style="list-style-type: none"> • SSB – single sideband • AME – amplitude modulation equivalent • PLT – single sideband with pilot signal).
AGC	Controls the automatic gain control function (fast/slow/off).
BW	Selects the filter bandwidth. <ul style="list-style-type: none"> • 2.1 – 300 to 2100 Hz • 2.7 – 300 to 2700 Hz • 3.0 – 300 to 3000 Hz • 3.3 – 300 to 3300 Hz. Always select this bandwidths for data transmission • LSM – bandwidth optimized for use with low speed modems (1450 to 1950 Hz) • CW (Continuous Wave or Morse operation). The bandwidth used in this case is selected by MENU > PROG > RAD > PRMT > CW.
RCLV	Displays the receive level. The RCLV item appears only if the received signal level display is not permanently enabled using MENU > PROG > RAD > PRMT > RCLV .
FREQ	Displays the current frequency.

3-12.3.2.2 Replacing the Current Channel While in the Link State

If during an individual call you find that the channel in use is not good enough, you can replace it with a better channel.

NOTES

- Channel replacement is possible only during an individual call in the ALE mode.
- Only the initiator of a call can replace the channel in use.

To replace the channel:

1. Press **MORE** to scroll to the second link state menu.
2. Press **RPL** to replace the channel in use.
3. The radio disconnects the link, replaces the channel being used, and initiates the call once again.

**NOTE**

Even if a message was transmitted when the original link was initiated, the new link will be initiated without the message.

3-12.3.2.3 Using the Caller Stack

The caller stack stores information about unanswered calls. The stack entry contains the self-address of the calling station, and any message sent by the calling station when it sent the call set up request. The stack can contain up to 10 calls.

When the stack is not empty, you can see the stack icon in the display.

The radio records an address in the stack only once, even if the same caller made several unanswered calls. However, if the same caller sent calls with different messages, all such calls will be saved in the stack. If you see **STAK** in the options area, the stack includes at least one call you never viewed before. The stack is arranged in FIFO order, that is, the first address that enters the stack is also the first that you see on the display.

To view the calls in the stack:

1. Press **STAK**. The radio displays information on the total number of calls in the stack, and information on the first call. If the number of characters exceeds the available space, press < - > to activate the view mode.
2. Use the **UP/DOWN** keys to view any additional calls in the stack.

To return a call to a station registered in the stack:

1. Press **STAK**.
2. Use the **UP/DOWN** keys to scroll to the required call.
3. Press **CALL**.
4. Press **PAGE** if you want to attach a message when you reply to the call.
5. Press **CHAN** if you want the call to be initiated on a specific channel in the currently used net.

NOTE

The **CHAN** key is displayed only if the radio is in the ALE mode.

6. Press **SEND** or **ENTER** to initiate the call.

NOTE

After initiating a call to a station, its page in the stack is automatically deleted, together with all other calls from the same address.

To remove an address from the stack:

The radio automatically removes an address from the stack in the following cases:

- When the operator calls a station registered in the caller stack, all stack calls containing that address are erased from the stack, regardless of whether the call was returned from within the stack or during an individual call.
- The stack can contain up to ten addresses. When the stack is full and a new address comes in, the new address replaces the oldest address in the stack.

In addition, you can manually remove an address from the stack as follows:

1. Press **STAK**.
2. Use the **UP/DOWN** keys to scroll to the required call.
3. Press **ERAS**.
4. Press **YES** to confirm or, **NO** to cancel the deletion.

3-12.3.3 Disconnecting Calls

When you are in the link state, your radio can communicate with at least one other ALE station.

To disconnect an incoming call:

Press the **ESC** key. This disconnects the link and returns the radio to the mode used before the link was established. When you disconnect a link, you can instruct the other station(s) to return to the working mode they were in before they entered the link state. This feature is called Home Acknowledge, and can be programmed.

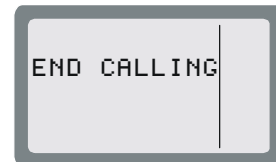

If Home Acknowledge is enabled:

- In an individual link, each of the stations in the link can transmit the Home Acknowledgement to instruct the other stations to disconnect the link.
- In a net/AnyCall link, the Home Acknowledgement can only be transmitted by the radio which initiated the call.

3-12.3.4 Transmitting Calls in ALE Mode

To transmit an ALE call, you must specify the destination. In general, the destination consists of a net and one or more stations (members of the specified net):

- When the MultiNet function (Appendix C) is disabled, the destination net is always the currently selected net (its number is displayed on the LCD while the radio is scanning). Therefore, if you do not want to select a different net, you can skip directly to the selection of the destination station(s).
- When the MultiNet function is enabled, *first you must always select a net and then the destination station(s).*

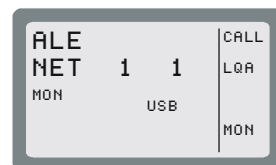

To expedite the transmission of an AllCall, you can send a global AllCall by pressing the **P/ESC** key for a few seconds.

Micom stores the last called address, so you can simply press the PTT twice in rapid sequence (**double pressing**) to call again that address. This also applies to AllCall, and therefore after sending AllCall for the first time, you can send it again by double pressing the PTT.

NOTE

If you want to monitor the call set up process on the speaker and be alerted by a beep when the link is set up, turn the monitor on, using the **MON** key.

3-12.3.4.1 Selecting the Desired Net

To select a net:

1. Press **MENU** and select **ALE**.

The radio displays current active net number, flashing.



2. To change the currently used net, press the **UP/DOWN** keys, or enter the net number on the keypad, and then press **ENTER**.

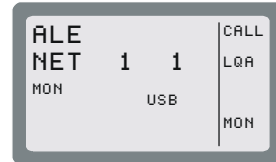

3-12.3.4.2 Calls to an Individual Station

To transmit an individual call with MultiNet OFF:

1. Press **CALL**.

The radio displays the last called address. This may be a station address, or any other type of address (for example, net, wildcard, etc.).

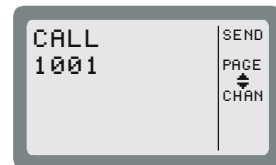

2. To select a different station:

Press the **UP/DOWN** keys to scroll between stations.

or

Use the keypad to enter a station name and then press **SAVE** or **ENTER** when the required station name appears.

NOTE

When scrolling between stations with the **UP/DOWN** keys, every key pressing displays destination addresses in the following order:

- The last called address
- The AllCall address (GL ALLCALL, or SL ALLCALL, if you used it instead of GL ALLCALL)
- The current active net number
- The addresses of the members in the current net
- Other addresses in the directory.

3. Press **SEND** or **ENTER** to initiate the call.

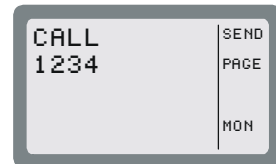

- The radio now starts the link set up process. During this process, you will see **TO** alternating with the number of the channel on which the set up request is being sent (the channel may change, if the called station does not answer on the first channel(s)).

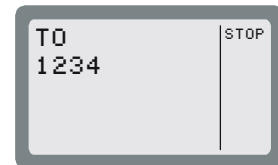

NOTE

While the radio is initializing the link, you can press **STOP** or **ESC** to abort the entire process.

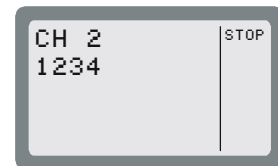

- After the link is established, you will see a **LINK** message. Now you may press the PTT and start talking.

NOTE

If the link with the selected station cannot be set up, you will see for a few seconds a flashing **NO LINK** message.

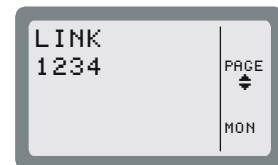

- To disconnect the link, press the **ESC** key (see page 3-36).

NOTE

If you want to call again the same station, double-press the PTT to use the quick-call feature (see page 3-40).

To transmit an individual call with MultiNet ON:

- Press **CALL**. The radio displays the current net number, flashing. If you wish to change the currently used net, press the **UP/DOWN** keys or enter the net number on the keypad.
- Press **ENTER** to confirm the net number.
- The radio displays the last called station.
Press the **UP/DOWN** keys to scroll between stations, or use the keypad to enter a station name and then press **SAVE** or **ENTER** when the required station name appears.
- Press **SEND** or **ENTER** to initiate the call.
- The radio now starts the link set up process. During this process, you will see **TO** alternating with the number of the channel the set up request is being sent (the channel may change, if the called station does not answer on the first channel(s)).

NOTE

While the radio is initializing the link, you can press **STOP** or **ESC** to abort the entire process.

- After the link is established, you will see a **LINK** message. Now you may press the PTT and start talking.
- To disconnect the link, press the **ESC** key (see page 3-33).

To transmit on a specific channel:

1. Initiate a call as explained above (page 3-36 or 3-38) and select the desired station.



2. Press **CHAN** to select a specific channel.

The channel with the best LQA score is displayed. The speaker is unmuted to enable you to check the channel quality by listening to it.

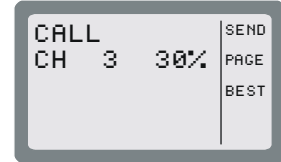
**NOTE**

If the name of the called station has been edited and the new station name is not in the directory, no LQA score is displayed.

3. Press **BEST** to select the channel with the best LQA score...

NOTE

If the name of the called station has been edited and the new station name is not in the directory, the channel displayed after pressing **BEST** is the first scanned channel of the net.

... or

Press the **UP/DOWN** keys to scroll to the channel of your choice.

NOTE

You can use this option to transmit a call to a station operating in the Channel mode. If the other station is in the Channel mode, your radio switches to the Channel mode for the duration of the call, and then returns to the ALE mode after the link to that station is disconnected.

4. Press **SEND** or **ENTER** to initiate the call.
5. The radio now starts the link set up process. During this process, you will see **TO** alternating with the number of the channel on which the set up request is being sent (the channel may change, if the called station does not answer on the first channel(s)).

NOTE

While the radio is initializing the link, you can press **STOP** or **ESC** to abort the entire process.

6. After the link is established, you will see a **LINK** message. Now you may press the PTT and start talking.
7. To disconnect the link, press the **ESC** key (see page 3-36).

3-12.3.4.3 Quick Call

A quick call is a call to the last station you tried to call (regardless of whether the call was successful or not). In the ALE mode, the channel used for the original call is reused for the quick call.

The Quick Call feature can be enabled or disabled as part of ALE parameters programming.

NOTES

- Quick Call will not transmit a message, even if the last call contained a message.
- The first time the station is switched to the ALE or Channel mode, quick call is not possible as no "most recent" station data exists.

To send a quick call:

Double-press the PTT of your microphone or handset. The radio automatically tries to contact the last called station.

During this process, you will see **TO** alternating with the number of the channel on which the set up request is being sent (the channel may change, if the called station does not answer on the first channel(s)).

NOTE

While the radio is initializing the link, you can press **STOP** or **ESC** to abort the entire process.

3-12.3.4.4 Using Autodial

The Autodial feature lets you use a single digit to call a preprogrammed address. There are ten programmable Autodial addresses, where each can include a message.

To use Autodial to send a call:

1. Press **#** on the keypad.

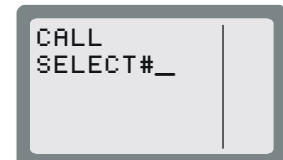

NOTE

If you do not select an auto-address within a few seconds, the display automatically reverts to the previous state.

2. Press the desired preprogrammed Autodial number (0 to 9).

The programmed address is immediately displayed; if a message is preprogrammed, an exclamation sign will appear before the station name.

Press **PAGE** if you want to attach a message to the call or to replace/edit a preprogrammed attached message. See page 3-41.

NOTE

If the Autodial number you enter is not programmed, the message **NOT PROG** will be displayed.

3. Press **CHAN** if you want the call to be initiated on a specific channel. See page 3-41.
4. Press **ENTER** or **SEND** to start the call.

- The radio now starts the link set up process. During this process, you will see **TO** alternating with the number of the channel on which the set up request is being sent (the channel may change, if the called station does not answer on the first channel(s)).

NOTE

While the radio is initializing the link, you can press **STOP** or **ESC** to abort the entire process.

- After the link is established, you will see a LINK message. Now you may press the PTT and start talking.
- To disconnect the link, press the **ESC** key (see page 3-36).

3-12.3.4.5 Sending Messages

You can send messages (*page*) together with the initial call (before the link is set up), and also whenever necessary while the link is already set up (that is, when your station is in a link with the destination station).

In the link state, if you are making an individual call, both the receiving and the calling station can send messages to the other station. This is also true for net calls and group calls.

To transmit an individual call with a message:

- Initiate a call as explained above (page 3-37 or 3-38) and select the desired station.



- Press **PAGE** to add a message. The last sent message is displayed.

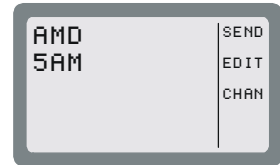

- Press the **UP/DOWN** keys to scroll to the required message.

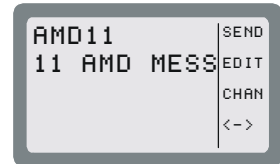

or

- To edit the message, press **EDIT** and use the keypad to enter a new message.



- Press **SAVE** when the message is ready.

- Press **SEND** or **ENTER** to initiate the call.



- Proceed with the call as explained above (page 3-37 or 3-38).

To send a message during a call (link state):

1. Press **PAGE**.

NOTE

If this function key is not displayed, you cannot send a message in the present mode.



2. Select or edit the desired message as explained on page 3-40.

3. Press **SEND** or **ENTER** to send the message.



4. The radio now starts the link set up process for this message (this process is similar to the process used to set up the link for this call). During this process, you will see **TO** alternating with the number of the channel being used.

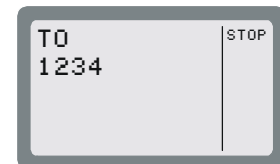

NOTES

- While the radio is initializing the link, you can press **STOP** or **ESC** to abort the entire process.
- If the link needed to send the message to the selected station cannot be set up, you will see for a few seconds a flashing NO LINK message.

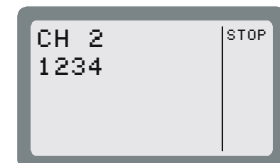

3-12.3.4.6 Other Types of Calls

In addition to calls to individual stations described on the pages 3-36 to 3-41, additional types of calls can be used to help you call multiple stations (see list on page 3-31).

NOTE

A properly designed address assignment plan is needed to take advantage of the special ALE calling modes.

The special call types are reached under a special submenu, designated MULT (see Figure 3-7 for its organization).

To select a special call type:

1. Press **CALL**.

The radio displays the last called address. This may be a station address, or any other type of address (for example, AllCall, net, wildcard, etc.).

2. Press **MORE** once.
3. Press **MULT** to display the first page of special calls. If the desired call type is located on this page, press the corresponding function key to select it.
4. If necessary, press **MORE** again to display the next page.

NOTE

Pressing **MORE** again return you to the first page of special calls: do not use the **ESC** key, as it cancels the MULT option.

5. Go to the page listed below for detailed instructions.

Option	Capabilities	See Page ...
ALL	AllCall – call directed to all the other stations simultaneously; usually used as a distress call.	3-43
NET	Net call – call directed to a net (a net is a preprogrammed group of stations). Up to 20 nets can be defined.	3-45
GRP	Group call – call directed to a group of individually selected stations. Groups can be preprogrammed, but you can also select the stations to be called and save the selection for reuse. Up to five groups can be defined.	3-46
ANY	AnyCall – call directed to all the other stations simultaneously, usually used to detect new stations.	3-48
WILD	Wildcard call – call simultaneously addressed to a selected group of stations within a net, with wildcards used within the address to specify the desired stations. Wildcard calls use the special ALE addressing modes. If you are not familiar with these modes, you should review Appendix C.	3-51
SELF	Self call – call using the station’s own address, generally used for test purposes.	3-53

3-12.3.4.7 Transmitting AllCalls

An *AllCall* is a message which your radio uses to establish a connection with all the other stations simultaneously, and is typically used to broadcast a message or send a distress call. An AllCall can also include a message.

In addition to this type of AllCall (referred to as a *global (GL) AllCall*), it is also possible to use *selective (SL) AllCall*: this is a simultaneous call addressed only to all the stations whose names (addresses) end with a character you specify.

NOTE

If so required, you can set your radio so that it cannot send AllCalls.

You cannot select the channel on which an outgoing AllCall will be sent: outgoing AllCalls are sent on the AllCall channel defined for the currently selected net, or on the best scanned channel of the net.

NOTE

When radios in other nets have their MultiNet feature enabled, AllCalls may also reach these radios.

There are two ways to send a global AllCall: using the **ESC** key or using the **CALL** function. A selective AllCall can be sent only using the **CALL** function.

To send global AllCall using the ESC key:

1. Press **ESC** continuously for a few seconds. The radio starts sending the GL AllCall.

During this process, you will see **TO** alternating with the number of the channel on which the set up request is being sent.

NOTE

While the radio is initializing the link, you can press **STOP** or **ESC** to abort the entire process.

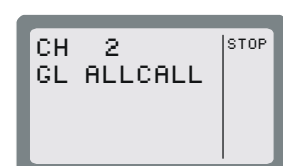
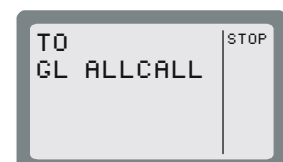

2. After a delay, you will see LINK with a flashing GL ALLCALL.



3. Confirm the link set up by pressing **ENTER** or the PTT. The GL ALLCALL message stops flashing, and you can start talking.



4. Press **PAGE** if you want to send a message. See page 3-42 for details.

5. To end the call, press **ESC**.

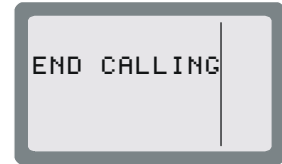

To send global AllCall using the CALL function:

1. Press **CALL**. The radio displays the last called address.

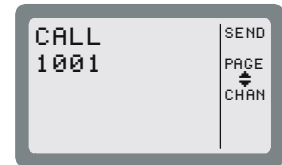

2. Press the **UP/DOWN** keys until you reach GL ALLCALL.

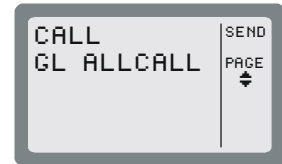

3. Press **PAGE** if you want to add a message to the call. See page 3-41 for details.

4. Press **SEND** or **ENTER** to start the call.

The call now proceeds as for call initiated by pressing the **ESC** key.

To send selective AllCall:

1. Press **CALL**.

The radio displays the last called address.

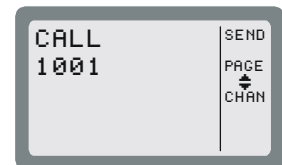

2. Press **MORE** once.

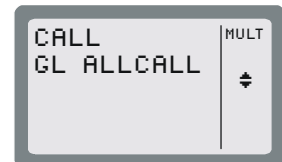

3. Press **MULT** to display the first page of special calls.

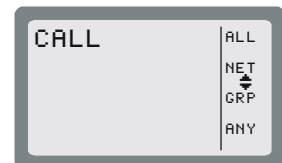

4. Press **ALL**.

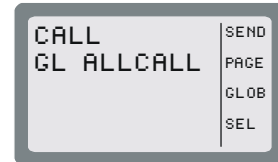

5. Press **SEL**.

NOTE
If you decide to send a Global AllCall, press GLOB.

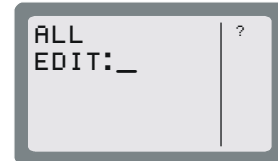

6. Type the desired character (only one character is accepted).

NOTE
You can press ? if you decide to send a global AllCall.

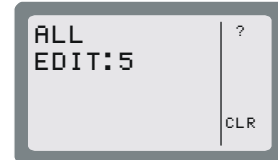

7. Confirm your selection by pressing **ENTER**.

NOTE
If you decide to send a global AllCall, press GLOB.

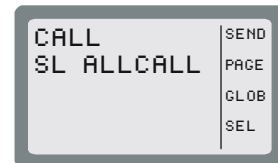

8. Press **SEND** or **ENTER** to start the call. The radio starts sending the selective AllCall.

NOTE
While the radio is initializing the link, you can press **STOP** or **ESC** to abort the entire process.

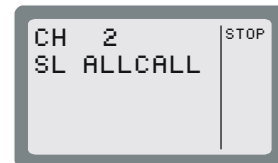
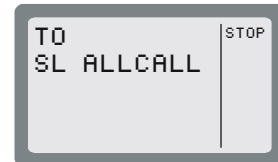

9. After a delay, you will see **LINK**, and you can start talking.

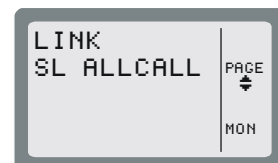

10. Press **PAGE** if you want to send a message. See page 3-42 for details.

11. To end the call, press **ESC**.

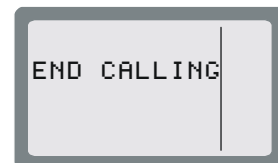

Transmitting Net Calls

Before starting, select the net you want to use as explained on page 3-36. However, when MultiNet is enabled, you will be prompted for a net number as soon as you start a call.

NOTES

- You can program nets using the front panel, or the MRC.
- The radio must be programmed as a **MASTER** radio in the net (an ALE Programming option) in order to be able to transmit net calls.

To transmit a net call:

1. Press **CALL**.

The radio displays the last called address.

If you see the net you want, skip directly to Step 5 below, otherwise continue as explained below.

2. Select the **NET** option as explained on page 3-43.
3. Press **PAGE** if you want to attach a message to the call.
4. Press **CHAN** if you want to initiate the call on a specific channel.
5. Press **SEND** or **ENTER** to initiate the call.

The radio now starts the link set up process. During this process, you will see **TO** alternating with the number of the channel on which the set up request is being sent.

NOTE

While the radio is initializing the link, you can press **STOP** or **ESC** to abort the entire process.

When a net call is transmitted, each member in the net responds to the call and the initiator of the call receives an indication of the response on the display.

6. After links have been established, you can start talking.
7. To end the call, press **ESC**.

3-12.3.4.8 Transmitting Group Calls

Group calls let you call several individual stations in your net (at least 2) at once. Thus, you can use a group call to communicate with a few select stations, while other stations can still communicate at will, using other channels available to your net.

You can call up to 5 stations in a group call. The only restriction is that the total length of all the addresses cannot exceed 12 ALE words (36 characters). If the maximum allowed length is exceeded, you get a **BUFF FULL** error.

NOTES

- If you need to check beforehand the length, remember that each ALE word must include 3 characters. Therefore, when an address is not an exact multiple of 3, stuffing symbols are automatically added in the last positions.
- ALE addresses are categorized in accordance with their leading ALE word (that is, their first three characters: if the address is short and has only one or two characters, stuffing symbols @ are added). When assembling a group you must also take into consideration that the maximum number of different address categories (as identified by their leading word) in one group is 5. If more are included, then when you try to send the call you will see **UFA WRONG**. In this case, remove addresses to make the group more homogenous.

To make a group call, first you must specify the stations to be included in the group. The addresses of the stations you include in the group can be saved as a **group**; the radio can store up to 4 different groups. If a group including the desired stations is already programmed, you can directly initiate the call to the desired group.

NOTE

Before starting, you may want to select a different net to use: see instructions on page 3-36.

When MultiNet is enabled, you will be prompted for a net number as soon as you press **CALL** to start a call.

To transmit a group call:

1. Press **CALL**.

The radio displays the last called address.

If you see the group you want, skip directly to Step 6 below, otherwise continue as explained below.

2. Select the GRP option as explained on page 3-43.
3. The first group displayed is always group 1. If this is the group you want, skip directly to Step 6 below, otherwise press the UP or DOWN arrows until you see the desired group.
4. Press **PAGE** if you want to attach a message to the group call.
5. Press **CHAN** if you want to initiate the call on a specific channel.
6. Press **SEND** or **ENTER** to initiate the call.

NOTES

- If the selected group does not include at least 2 stations, your request is rejected and you will see for a few seconds **AT LEAST 2**.
- If the addresses in the group have more than 5 different leading words, your request is rejected and you will see for a few seconds **UFA WRONG**.

The radio now starts the link set up process. During this process, you will see **TO** alternating with the number of the channel on which the set up request is being sent.

NOTE

While the radio is initializing the link, you can press **STOP** or **ESC** to abort the entire process.

When a net call is transmitted, each member in the group responds to the call and the initiator of the call receives an indication of the response on the display.

7. After links have been established, you can start talking.
8. To end the call, press **ESC**.

To define or change a group:

1. Press **CALL** and select the GRP option, as you do to start a group call (page 3-46).
2. The first group displayed is always group 1. If this is the group you want, skip directly to Step 3 below, otherwise press the UP or DOWN arrows until you see the desired group.
3. To select the stations you want in this group, press **SEL**.

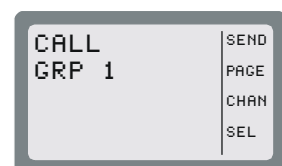

NOTE

The following example explains how to build a new group, but you can use the same procedures to change an existing group.

- After pressing **SEL**, you will see the DIR screen. Therefore, you can select stations from the addresses already stored in the directory, or type new addresses using the keypad.

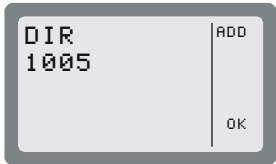

To select an address from these already in the directory:

- Use the UP and DOWN arrows to display the desired directory entry, and then press **ADD**.

The label above the selected entry changes to **ADDED**, to indicate that it is now included in the group.

Now you can also have the option (**ERAS**) to delete the entry from the group.



NOTE

If adding the station would cause the total length of the station addresses in the group to exceed 12 ALE words, then after pressing **ADD** you will see **BUFF FULL** and the process stops.

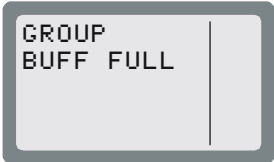

- Repeat the procedure described above until the group includes only the desired stations.

As you scroll through the directory, you will see **DIR** for stations that can be added, and **ADDED** for those already added. If the station you want to add to the group is not in the directory:

Enter the new station using the keypad. If you make a mistake, scroll to the desired position using **<--** and/or **-->**, or clear (**CLR**) the whole entry and start again.

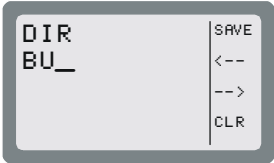

- When ready, press **SAVE** to store the new station in the directory. Now you can add it to the group by pressing **ADD**.

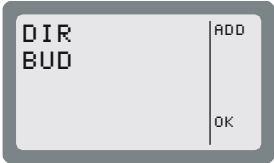

3-12.3.4.9 Transmitting AnyCalls

An AnyCall is a general broadcast which your radio uses to simultaneously establish links with other stations. An AnyCall can also include a message.

NOTE

If so required, you can set your radio so that it cannot send AnyCalls.

AnyCall is somewhat similar to AllCall, except that it requests responses from the other stations and therefore it can be used to detect new stations. Another difference is that you can also select the channel on which the AnyCall will be transmitted (alternatively, you can let the radio select automatically the channel).

NOTE

When radios in other nets have their MultiNet feature enabled, AnyCalls may also reach these radios. See details in Appendix C.

You can send three types of AnyCalls (see also description of addressing modes on Appendix C):

- **General:** the address sent by your radio is @@?. This is a simultaneous call addressed to all the stations.
- **Selective:** you specify the last character of the address. This is a simultaneous call addressed only to the stations whose names (addresses) end with a character you specify.
- **Double selective:** similar to selective, except that you specify the last two characters of the address.

To make an AnyCall, first you must select the address to be used for the call.

Micom will wait for responses for a certain time before entering the link state with all the stations that responded within this interval (the maximum number of stations that are accepted in an AnyCall is 16).

NOTE

Before starting, you may want to select a different net to use: see instructions on page 3-36.

When MultiNet is enabled, you will be prompted for a net number as soon as you press **CALL** to start a call.

To transmit an AnyCall:

1. Press **CALL**. The radio displays the last called address.
 If you see the address you want (that is, you want to repeat the last AnyCall), skip directly to Step 10 below, otherwise continue as explained below.
2. Press **MORE** once.
3. Press **MULT** to display the first page of special calls.
4. Press **ANY**.
5. Press **SEL**.

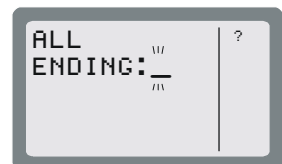
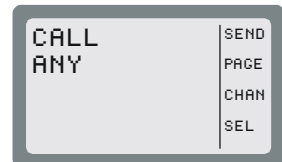
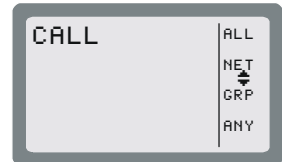
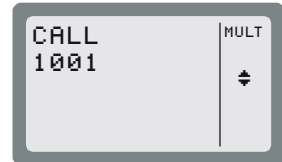
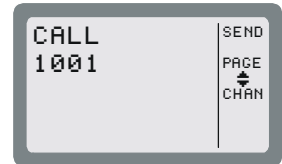

NOTE
 If you try to send (**SEND**) the call without first selecting an address, your attempt is rejected and you see for a few seconds **NOT PROG.**

6. Select the AnyCall address:

- To send a general AnyCall, press **?**.



- To send a selective AnyCall, enter the desired character (any character except #, @ or ?).

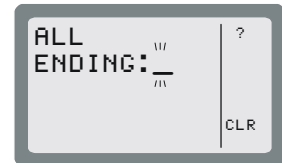

- To send a double-selective AnyCall, enter two characters.

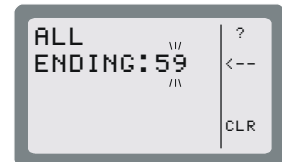

7. Confirm your selection by pressing **ENTER**.

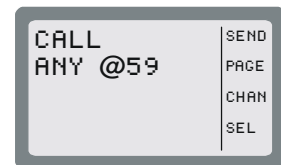
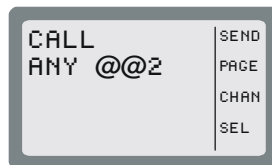
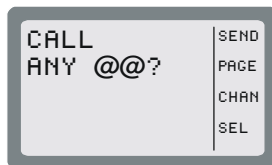

- Press **PAGE** if you want to attach a message to the call.
- Press **CHAN** if you want to initiate the call on a specific channel.
- Press **SEND** or **ENTER** to initiate the call.

The radio now starts the AnyCall process. During this process, you will see **TO** alternating with the number of the channel on which the request is being sent.

NOTE
 You can press **STOP** or **ESC** to abort the entire process.

When an AnyCall is transmitted, the initiator of the call receives an indication of each station answering the call (its address flashes in the display, until replaced by the next answering station).

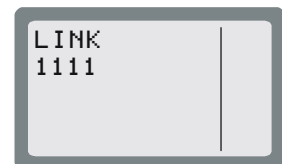

- After a programmed interval (or after 16 stations answer, whichever comes first), the link is established. Now you can start talking.



12. To end the call, press **ESC**.

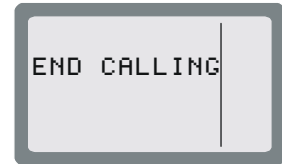

3-12.3.4.10 Transmitting Wildcard Calls

Wildcard calls, that is, calls in which the destination address includes the wildcard character **?**, let you to simultaneously address multiple stations with a single address:

- Any station receiving an address with wildcards stops scanning and checks the address length: if the number of characters in the received address is different from the number of characters in its own self-address, the station ignores the call.
- If the received address matches the length, a receiving station checks the significant positions in the received address against its own. For example, the stations JOHN and JOIN will both accept a call with the address JO?N.
- Each station accepting the call answers the calling station in a pseudo-random slot.

Micom will wait for responses for a certain time before entering the link state with all the stations that responded within this interval (the maximum number of stations that are accepted in a wildcard call is 16). Therefore, with the wildcard option, the link set up process takes more time, because the radio waits longer to get responses (it cannot “guess” the number of stations that will answer).

Before continuing, you may wish to review Appendix C, which present details on ALE addressing (including the use of wildcards in addresses).

NOTE

Before starting, you may want to select a different net to use: see instructions on page 3-36.

When MultiNet is enabled, you will be prompted for a net number as soon as you press **CALL** to start a call.

To transmit a wildcard call:

1. Press **CALL**. The radio displays the last called address.

If you see the address you want (that is, you want to repeat the last wildcard call), skip directly to Step 11 below, otherwise continue as explained below.



2. Press **MORE** once.

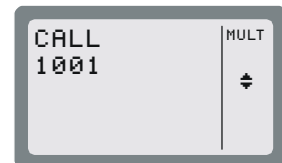

3. Press **MULT** to display the first page of special calls.

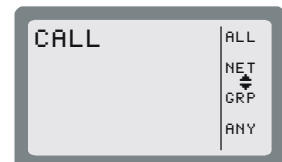

4. Press **MORE** again to display the next page.

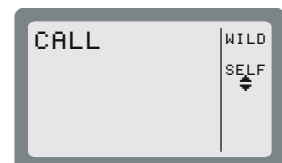

5. Press **WILD** to start.



6. Press **SEL**.



NOTE

If you try to send (**SEND**) the call without first selecting an address, your attempt is rejected and you see for a few seconds **NOT PROG.**

7. Select the desired address:
- To insert a wildcard, press ?
 - Enter the desired characters using the keypad.



8. Confirm your selection by pressing **ENTER**.

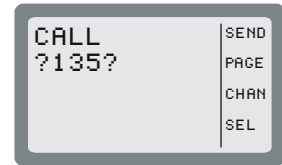

9. Press **PAGE** if you want to attach a message to the call.
10. Press **CHAN** if you want to initiate the call on a specific channel.
11. Press **SEND** or **ENTER** to initiate the call.

NOTE

If the selected group does not include at least 2 stations, your request is rejected and you will see for a few seconds **AT LEAST 2.**

The radio now starts the process. During this process, you will see **TO** alternating with the number of the channel on which the request is being sent.

NOTE

You can press **STOP** or **ESC** to abort the entire process.

12. After a delay, you will see **LINK** with the wildcard address flashing.



13. Confirm the link set up by pressing **ENTER** or the PTT. The address stops flashing, and you can start talking.

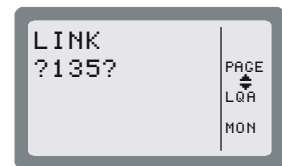

14. To end the call, press **ESC**.

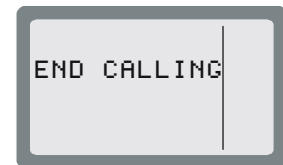

3-12.3.4.11 Transmitting a Self Call

The self-call is a test call addressed to your own address within the currently selected net. Its purpose is to check that your radio set is OK and can transmit calls (to check reception, you can simply listen to other radio sets).

When you send the self-call, the radio starts sending calls to its own address, successively, on each channel in the current net. After going through all the channels, the call process stops. No other response is expected.

NOTE

You can also include the self address in a group call.

To send a self-call:

1. Press **CALL**. The radio displays the last called address.
2. Press **MORE** once.
3. Press **MULT** to display the first page of special calls.
4. Press **MORE** again to display the next page.
5. Press **SELF** to start the self-call.
6. You may select now a specific channel to perform the call, by pressing **CHAN**. See details on page 3-39.
7. When ready, press **SEND** to start transmitting. The display alternates between your self-address and the channel used for the call is sent. If you did not select a specific channel, the channel number changes as the radio sends the call on each channel assigned to the selected net.

After all the channels have been used, the call automatically stops.

You can press **STOP** at any time to end the call sooner.

3-12.3.4.12 Bidirectional Handshake

The bidirectional handshake is used to exchange LQA scores with other stations without establishing a link.

NOTE

The Micom can also be programmed to automatically initiate the call to the station after finishing the bidirectional handshake (using the BDLK parameter reached under the ALE programming options).

A bidirectional handshake can be carried out with a single station or with all stations in the net. It can be carried out either on a single channel, or on all the net channels. When required, a message can also be added to the procedure. After a bidirectional handshake with a single station, the LQA matrices of both radios are updated. The operator can then initiate a call to that station and obtain the best channel automatically.

When the bidirectional handshake procedure is performed with a net, all the stations in the net update their LQA tables. Micom will wait for responses for a certain time before entering the link state with all the stations that responded within this interval (the maximum number of stations that are accepted in a bidirectional handshake is 16).

NOTE

Before starting, you may want to select a different net to use: see instructions on page 3-36.

When MultiNet is enabled, you will be prompted for a net number as soon as you press **CALL** to start a call.

To execute a bidirectional handshake with an individual station:

1. Press **LQA** to enter the LQA menu.



2. Press **BIDR**. The last called address is displayed. If this is the address you want, skip directly to Step 6 below.

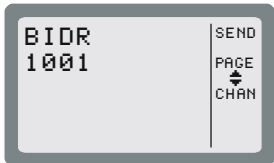

3. To select a different address, use the **UP/DOWN** keys to scroll to the required address in the directory, and then press **ENTER** to confirm your selection.

or

If the station you want to add to the group is not in the directory:

- Enter the new station using the keypad. If you make a mistake, scroll to the desired position using **<--** and/or **-->**, or clear (**CLR**) the whole entry and start again.
- When ready, press **SAVE** to store the new station in the directory.

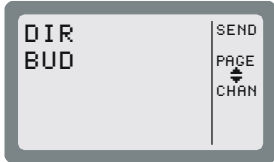
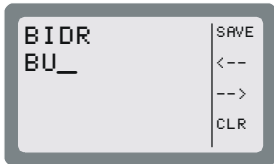

4. Press **PAGE** if you wish to attach a message to the bidirectional handshake process. After confirming the message, exclamation mark precedes the name of the called station, indicating that a message has been attached.
5. Press **CHAN** if you wish to execute a bidirectional handshake process on a specific channel.
6. Press **SEND** or **ENTER** in order to initiate the bidirectional handshake process. During this process, you will see **TO** alternating with the number of the channel on which the set up request is being sent.

NOTE

During the bidirectional handshake process, you can press **STOP** or **ESC** to abort the entire process.

To execute a bidirectional handshake with a net:

1. Press **LQA** to enter the LQA menu.



2. Press **BIDR**. The last called address is displayed. If this is the net you want, skip directly to Step 6 below.

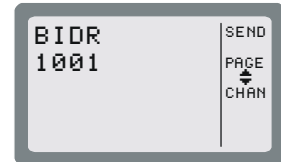

3. Press **MORE**.

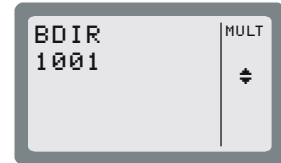

4. Press **MULT**.

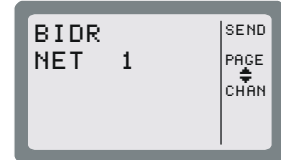

5. Press **NET**.

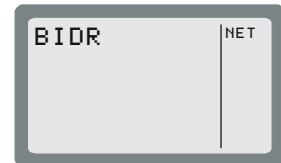

NOTE

You cannot change the net number at this stage – the bidirectional handshake is always performed on the currently selected net. To change the net, see page 3-36.

6. Press **PAGE** if you want to attach a message to the handshake.
7. Press **CHAN** if you want to initiate the handshake on a specific channel.
8. Press **SEND** or **ENTER** to initiate the handshake. During this process, you will see **TO** alternating with the number of the channel on which the handshake is being sent.

NOTE

While the radio is initializing the handshake, you can press **STOP** or **ESC** to abort the entire process.

3-12.3.4.13 Sounding

Sounding is used to test the quality of the channels and propagation paths of all channels in the net.

The sounding signal is normally repeated automatically, at regular intervals. A complete round of sounding messages, or "sounding cycle" can be programmed to 30, 60, 90, or 120 minutes, or can be set to OFF.

Sounding can also be initiated manually whenever necessary, even if automatic sounding is enabled.

To manually initiate sounding:

1. Press **LQA** to enter the LQA menu.

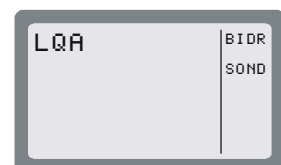

2. Press **SOND**.

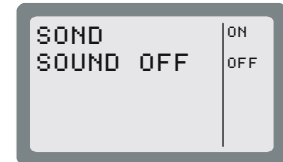

3. Press **ON** to start manual sounding, or **OFF** to stop an ongoing sounding process.

NOTES

- The radio automatically returns to ALE mode when sounding is stopped.
- When the radio transmits a sounding signal, the Tx bar is visible.

3-12.3.5 Using the Inlink Function

When the inlink function is enabled, the stations participating in a call are automatically notified by a DISC message whenever another participant leaves (disconnects from) the call.

The link is then automatically disconnected when only one station is left (that is, after all the other participants disconnected).

The inlink function is available in any type of call that involves the setting up of a link using bidirectional handshaking. Therefore, you can use it in individual calls, group calls, net calls, etc., but not in AllCalls and self calls.

NOTE

For the inlink function to operate correctly, it must be enabled on all the stations.

Do not enable the inlink function when communicating with a radio that does not support the full ALE capabilities in accordance with MIL-STD-188-141B.

To avoid disconnecting the link too soon as a result of inactivity (that is, after the programmed PTT time-out interval (PTOT)), each participant can request other stations to wait beyond the PTOT interval (up to 10 minutes more) before automatic disconnection occurs.

This option (TOT – time-out interval) is displayed over the F4 key after the link is set up: to send a request for the other stations to wait more time, press the TOT key.

3-12.3.6 Transmitting ALE Calls in the Channel Mode

The ALE option is available in both the ALE and Channel modes and therefore, the radio can also answer ALE calls.

The transmission process is similar for both operating modes, with the following differences:

- In the Channel mode, every call is initiated on the currently selected channel.
- The LQA function is not available in the Channel mode: sounding and bidirectional calls can only be initiated in the ALE mode.
- When the radio is in the Channel mode, it uses the parameters programmed for net 1.

NOTE

If net 1 is not programmed, there is no ALE functionality in the Channel mode, even if the ALE option is turned on.

3-12.4 Using ALE Mode to Send and Request GPS Position Data

You can use the ALE AMD service to:

1. Send your position to any another destination (including one-to-many).
2. Request the position of another Micom transceiver equipped with a GPS receiver. You can make this type of request only when you call an individual station.

Note that the operations described above automatically set up a link between the two stations and therefore it is necessary to disconnect the link when it is no longer needed. For this purpose, it is recommended to enable Home Acknowledge, and/or enable the PTT time-out function.

NOTE

AMD messages with the GPS position do not enter the stack (the information such message carries is good only at the time you got it): if you do not read the message in time, you can no longer retrieve the message at a later time.

Thus, you must allow sufficient time for the destination station to read the position message before when link is disconnected. This is particularly important when Home Acknowledge is enabled: the message will disappear as soon as you disconnect the link.

3-12.4.1 Request GPS Position

To automatically get the position of another Micom station, use the following procedure:

1. Select the **CALL** mode (either from the ALE mode or the CHAN mode).
2. Select the destination address (you can make only an individual call).
3. Select the **PAGE** selection mode.
4. Scroll until you see the **RMT POS** message, and then send the message.
5. Your station starts the link set up to the selected station; after the link is set up, you will see the response AMD of the called station, which includes its latitude and longitude. **POSITION INVALID** means that the remote station cannot provide its location.
6. You may now continue with voice communication, or disconnect the link to the called station.

NOTE

Radio sets of various vendors can also accept GPS position requests. The position request is made by sending the string **FIXPOSIT** as an AMD message.

3-12.4.2 Sending Own GPS Position

You can use the PAGE service to send the AMD message that appears in position 14 in the default list of AMD messages to transmit your own position to a remote station.

To send your position report to other station(s):

1. Select the **CALL** mode (either from the ALE mode or the CHAN mode).
2. Select the destination address and/or the call type.
3. Select the **PAGE** selection mode.
4. Scroll until you see the **I AM AT ...** message, and then send the message.
5. Your station sends the AMD message with your latitude and longitude.

3-13. USING THE VOCODER

3-13.1 Introduction

The Micom can be ordered for with the vocoder option. The vocoder provides voice privacy at good voice quality, using digital signal processing techniques.

The vocoder supports the following protection modes:

- Privacy (PVT) mode. The vocoder can store up to 8 private keys for use in this mode.
- Digital (DGTL) encryption mode.

You can select the desired protection mode, or switch to the clear (CLR) mode. To support protected communication, the radio bandwidth is automatically switched to 3.3K.

The vocoder can be used in all the modes (Channel, Frequency and ALE).

NOTE

When using the DGTL mode with ALE, the radio scans in the Clear mode. When a vocoder call is detected, the radio automatically switches to the protected DGTL mode after the link is established, and returns to scan in the Clear mode after the link is disconnected.

3-13.2 Using the Vocoder

When operating the radio with the vocoder in the Channel, Frequency or ALE mode, you can choose between the CLR, DGTL, and PVT (private) modes:

- PVT activates the automatic voice privacy functions
- DGTL activates the vocoder digital encryption function
- CLR reverts to regular radio activity.

NOTES

There are eight preprogrammed PVT keys, PVT1 to PVT8, and one digital encryption key (DGTL). Program the key to be used as described in the Programming the Vocoder section starting on page 3-59. The currently-used key number appears on the screen.

In the PVT and DGTL modes, the vocoder controls whether you hear or not the received signals, and therefore the squelch option (**SQ** (F3)) is not displayed. The Squelch option (F3) appears only in the Clear (CLR) mode.

When the PTT is activated, a hold-off tone sounds. Wait for the hold-off tone to end before talking.

To use the vocoder in the Channel mode:

1. Press the F1 key whenever it is necessary to toggle between the PVT (Private), DGTL, and CLR (Clear) modes.



NOTE

When using the digital mode, you see **DGTL** instead of **PVT#**.

**To use the vocoder in the Frequency mode:**

1. When using the Frequency mode, press **MORE** twice to access the third screen.



2. Press the F3 key whenever it is necessary to toggle between the PVT (Private), DGTL, and CLR (Clear) modes.

To use the vocoder in the ALE mode:

1. Enable the ALE mode, as described in para. 3-12.1.
2. When using the DGTL mode, the radio scans automatically in the CLR mode (you may see that the bandwidth returns to the default, 2.7K) and switches to the DGTL mode without your intervention when a DGTL call is detected.

When using the PVT mode, you must press the F1 key to switch to the CLR (Clear) mode to enable the radio to scan or to initiate a call to the desired destination. After a link is established, press **CLR** (F1) to switch to the PVT mode. Switch back to the CLR mode after the link is disconnected.

3-13.3 Programming the Vocoder

The PROG menu of the Micom provides access to the following functions:

- Programming the vocoder private (PVT) key.
- Display the vocoder hardware and software versions, and the vocoder configuration.
- Erasing the stored keys. You should erase the keys after their validity expires, or as a precaution when the radio must be serviced.

To access the vocoder programming menu:

1. Press **MENU** to display the Menu screen.

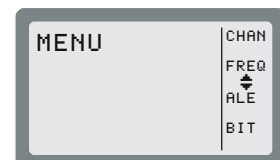

2. Press **MORE** to scroll to the second Menu screen.

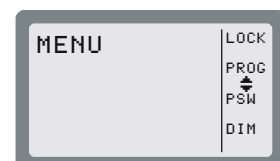

3. Press **PROG** to enter the Programming screen.

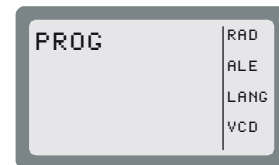

4. Press **VCD** to enter the Vocoder menu.

5. Press the relevant key to access the Vocoder options:

- **PVT** Select the key used in the private mode.
- **CONF** Display information on the vocoder hardware and software.
- **ERAS** Erase the stored keys.

Figure 3-8 shows the VCD programming options. The available selections are described in the following sections.

Figure 3-8. VCD Programming Menu

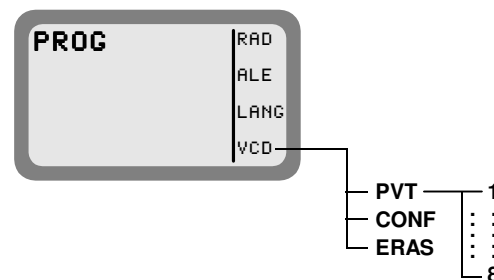

3-13.3.1 Selecting the Vocoder Mode and Keys

Vocoder offers two protection modes: privacy and public key encryption. The keys to be used must be loaded into the vocoder, before starting operations.

3-13.3.1.1 Selecting the Vocoder Private Key

Private reception and transmission are possible only when a valid key is selected. If the selected key is not valid or is not stored in the vocoder, a tone will be heard and the selection is rejected.

To select the vocoder private key to be used in this mode:

1. Access the Vocoder Programming menu: **MENU > MORE > PROG > VCD (F4)**.
2. Press **PVT** to enter the privacy key selection mode.
3. Use the **UP/DOWN** keys to scroll through PVT1 to PVT8.

NOTE
The displayed key number flashes until its selection is confirmed.

4. Press **ENTER** to confirm the selection of the key displayed on the screen.
Press **ESC** to revert to the previous setting.

3-13.3.1.2 Display of Vocoder Information

1. Access the Vocoder Programming menu: **MENU > MORE > PROG > VCD (F4)**.
2. Press **CONF (F2)**.
3. The screen changes to display the vocoder host version, and the function of key F1 changes: it now enables you to scroll cyclically through the information items displayed on the screen.

NOTE

If you need additional details on the displayed information, contact your local distributor or the manufacturer.

4. To end the display, press **ESC**.

3-13.3.1.3 Erasing the Stored Keys

1. Access the Vocoder Programming menu: **MENU > MORE > PROG > VCD**.
2. Press **ERAS**.
3. You are requested to confirm: press **YES**, or cancel the task by pressing **NO**.

3-14. OPERATION UNDER UNUSUAL CONDITIONS

3-14.1 Operation in Desert Areas

Micom Pathfinder radio sets are capable of operation under very harsh conditions.

Use the following recommendations to lower the ambient heat stress on the equipment.

- Avoid, whenever possible, direct sun radiation on the equipment.
- If sun exposure is unavoidable, minimize the exposed area.
- Permit free air movement around the equipment.

3-14.2 Operation at Low Temperatures

- Keep the front panel free of ice.
- If possible, keep the radios turned on even when not used for communication.
- Interconnecting cables and cords lose some of their flexibility at low temperatures. Be careful not to strain them.
- Coat the rubber O-ring of the AUDIO connector with silicone grease.
- Remove condensation from equipment, especially from front panel areas and connectors.

3-14.3 Operation During Storms

The radio set is protected against high-energy electrostatic discharges that may occur during lightning storms. However, for maximum safety, during lightning storms, do not install the antenna and avoid touching it.

CHAPTER 4

USING THE PROGRAMMING MODE

4-1. SCOPE

This Chapter provides concise instructions for using the PROG mode.

The Programming mode, accessed by opening the PROG menu is used to program manually the parameters needed by your radio set. There are two main group of parameters:

- Radio parameters – the parameters for communication in your environment and in the radio nets you use most of the time. Refer to para. 4-3 for details.
- ALE parameters – the parameters needed to use the ALE function. Refer to para. 4-4 for details.

The manufacturer offers a dedicated Radio Service Software (MRC), which is an efficient tool for preparing sets of operational parameters for Micom Pathfinder radio. MRC supports all the functions that can be performed by means of the PROG menu. MRC is recommended when it is necessary to configure many radio sets.

Micom Pathfinder lets you change the most of parameters in use on-line, to adjust to any particular situation. However, when you select another channel or net, the changes are discarded and the programmed values are used again.

4-2. THE PROG MENU

NOTE

The PROG menu is accessible only if the radio is not locked. If you cannot display the PROG menu, refer to para. 3-10 for instructions on unlocking your radio set.

To enter the PROG menu:

1. Press **MENU** to display the Menu screen.
2. Press **MORE** to scroll to the second Menu screen.
3. Press **PROG** to enter the Programming mode.

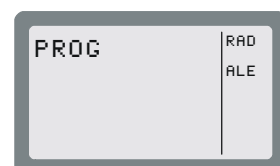
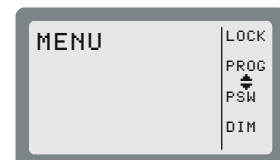
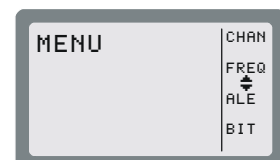

NOTE

If your Micom is equipped with an internal vocoder, or connected to an external vocoder, you will see **VCD** next to F4.

The structure of the PROG menu is shown in the following figures:

- Programming the Radio Parameters (Figure 4-1).
- Programming the ALE Parameters (Figure 4-2).

4-3. PROGRAMMING THE RADIO PARAMETERS

The Radio (RAD) Programming menu is used to program the following types of parameters:

- Channel parameters – para. 4-3.1
- General radio parameters – para. 4-3.2.
- Radio options – para. 4-3.3.

Refer to Figure 4-1 for the detailed structure and options of the RAD menu.

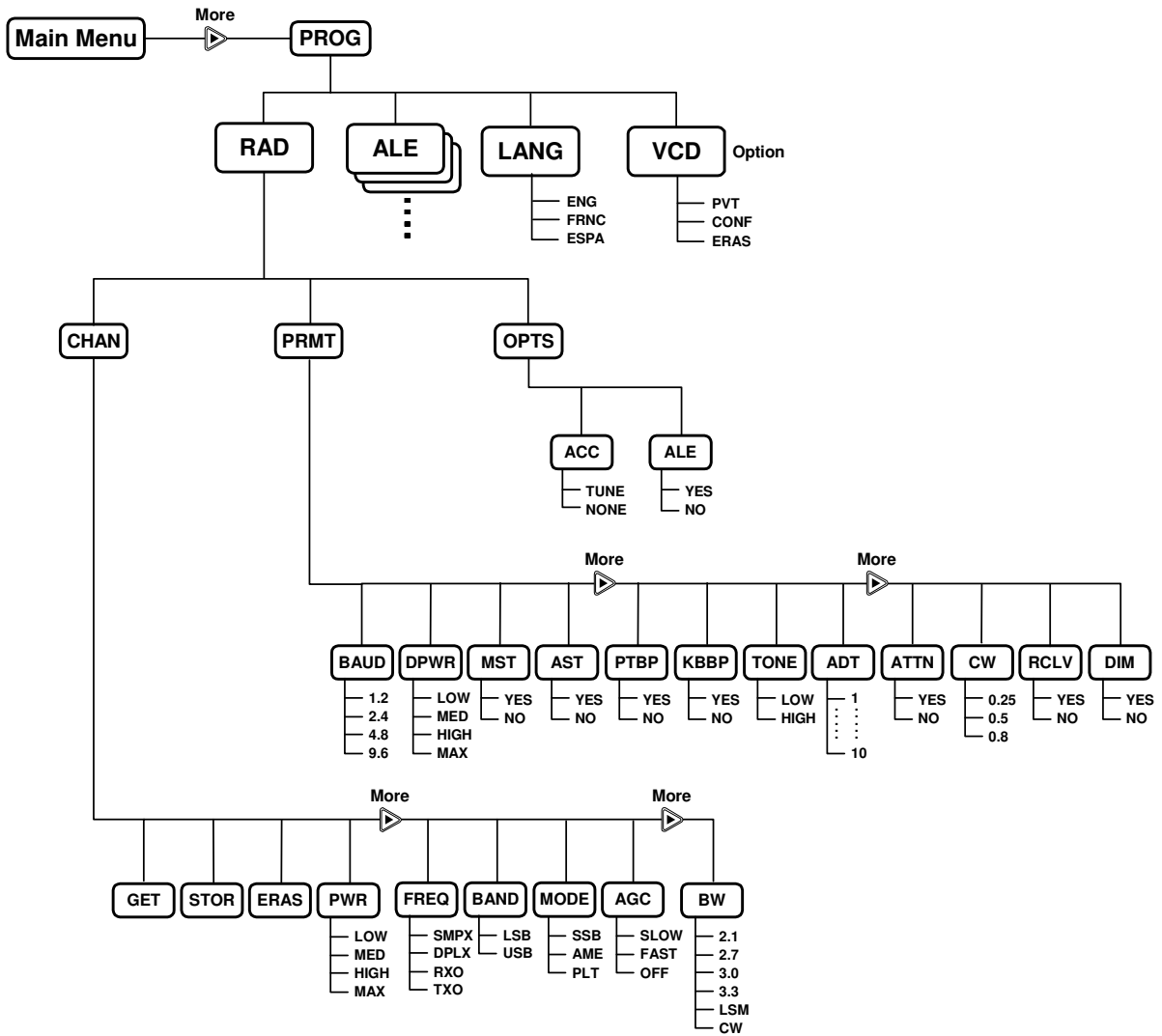
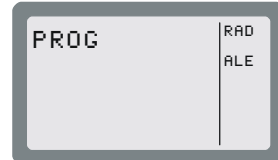
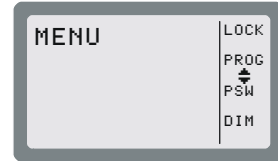
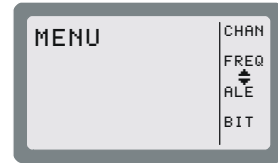

Figure 4-1. PROG Menu – Radio Parameters Programming

The following sections explain the programming procedures.

To start radio programming:

1. Press **MENU** to display the Menu screen.
2. Press **MORE** to scroll to the second Menu screen.
3. Press **PROG** to enter the Programming mode.
4. Press **RAD** to enter the Radio Programming mode.



4-3.1 Programming Channels

The Channel programming menu includes two groups of options:

- GET and STOR are used to copy the channel parameters from one selected channel to another, and ERAS is used to delete the user-configured parameters of a selected channel.
- The other options are used to configure the operational parameters to be used on the channel being configured.

To enter the Channel Programming mode:

1. Enter the Radio Programming menu.
2. Press **CHAN**.



The CHAN menu provides the following options (see also Figure 4-1):

Option	Description
GET	GET retrieves all the parameters defined for a channel already programmed in Micom Pathfinder (the default is the current channel, but you can select any other channel). You can store these parameters in a new channel using the STOR function, and then edit the parameters as required.
STOR	Store the set of parameters in a selected channel.

Option	Description
ERAS	<p>ERAS is used to delete (erase) a channel. Actually, this action only replaces the user-modified parameters of the channel with the factory-default parameters, but marks the channel as not programmed.</p> <p>The factory-default parameter values are as follows:</p> <ul style="list-style-type: none"> • Rx Frequency 15.000.00 MHz • Tx Frequency 15.000.00 MHz • SSB Mode USB • Bandwidth 2.7 • Tx Power MAX • AGC SLOW.
PWR	<p>Select the channel transmit power level. Four transmit power levels can be selected:</p> <ul style="list-style-type: none"> • LOW – 5 W nominal • MED – 10 W nominal • HIGH – 15 W nominal • MAX – 25 W nominal.
FREQ	<p>Select the channel frequency. Micom Pathfinder offers four frequency options:</p> <ul style="list-style-type: none"> • SMPX Simplex Frequency – the same frequency is used for both transmission and reception. • DPLX Duplex Frequency – transmits on one frequency and receives on a different frequency. • RXO Receiving Only Frequency – defines a frequency for reception only. Transmission on that frequency is disabled. The available frequency range is 100 kHz to 30 MHz. • TXO Transmitting Only Frequency – defines a frequency for transmission only. You cannot receive on that frequency. The available frequency range is 1.6 to 30 MHz.
BAND	<p>Select the channel operating sideband:</p> <ul style="list-style-type: none"> • USB – upper sideband mode • LSB – lower sideband mode.
MODE	<p>Select the channel radio operating mode:</p> <ul style="list-style-type: none"> • SSB – single sideband • AME – amplitude modulation equivalent • PLT – single sideband with pilot signal.
AGC	<p>Select the channel Automatic Gain Control mode. Micom Pathfinder offers two AGC response speeds: SLOW and FAST. You can also turn the AGC OFF completely.</p>
BW	<p>Selects the filter bandwidth.</p> <ul style="list-style-type: none"> • 2.1 – 300 to 2100 Hz • 2.7 – 300 to 2700 Hz • 3.0 – 300 to 3000 Hz • 3.3 – 300 to 3300 Hz. Always select this bandwidth for data transmission • LSM – bandwidth optimized for use with low speed modems (1450 to 1950 Hz) • CW (Continuous Wave or Morse operation). The bandwidth used in this case is selected by MENU > PROG > RAD > PRMT > CW.

4-3.2 Configuring Radio Parameters

The radio parameters are global parameters, which are used for all the channels.

To start the radio parameters programming:

1. Enter the Radio Programming menu.
2. Press **PRMT**.



The PRMT option in the Radio Programming menu provides the following options (see Figure 4-1):

Option	Description
BAUD	Selects the data transmission rate of the internal modem: <ul style="list-style-type: none"> • 1.2 – 1200 bps • 2.4 – 2400 bps • 4.8 – 4800 bps • 9.6 – 9600 bps.
DPWR	Selects the maximum transmit power for data transmission, that is, for a transmission initiated by the data PTT. The available selections are: <ul style="list-style-type: none"> • LOW – 5 W nominal • MED – 10 W nominal • HIGH – 15 W nominal • MAX – 25 W nominal. <p>The transmit power used in the other modes is independently selected for each channel. If the selected data transmit power exceeds the transmit power configured on the operating channel, the radio will use the lower channel transmit power.</p>
MST	Enables/disables the sidetone heard in the speaker when you transmit using the microphone.
AST	Enables/disables the speaker sidetone when you transmit using an accessory connected through the rear panel (not relevant).
PTBP	Enables/disables the transmission of a beep when the local push-to-talk (PTT) button is released. This beep is used to notify the other stations that the local (your) radio set has stopped transmitting and returned to the receive mode: therefore, another radio can start transmitting.
KBBP	Enables/disables the keypad beep. When enabled, a beep is heard whenever a valid key is pressed.
TONE	Select the keypad beep level: high or low. The selection is relevant only when the keypad beep is enabled.
ADT	Selects the alternate display time-out, that is, the time after which a keypad sequence is automatically aborted in case no action is taken. In this case, the display returns to the previous screen. <p>The time-out interval can be selected in the range of 1 to 10 seconds.</p>
ATTN	Enables/disables the use of an internal RF attenuator. The attenuator is used to reduce interference when your radio is located near strong transmitters.

Option	Description
CW	Select the channel filter bandwidth used in the CW mode: <ul style="list-style-type: none"> • 0.25 – 250 Hz • 0.5 – 500 Hz • 0.8 – 800 Hz A lower value improves the reception but requires better frequency accuracy.
RCLV	Enables/disables the receive signal level display. If the receive signal indication is not enabled, you can temporarily enable it using one of the function keys.
DIM	Enables/disables automatic dimming of the display. Usually, the display operates continuously. However, you can program the display to be normally off, and be automatically turned on when the transceiver detects any type of activity (keypad, PTT, incoming call, etc.). The ADT option selects the time before the display is again turned off when inactive.

4-3.3 Setting Radio Options

To start programming the radio options:

1. Enter the Radio Programming menu.



2. Press **OPTS**.



The OPTS option in the Radio Programming menu provides two sets of options (see Figure 4-1):

- **ACC** Used to configure the radio for operation with an antenna tuner:
 - NONE** Operation without an antenna tuner, which is possible only when using a broadband antenna connected to the DIP connector.
 - TUNE** Operation with antenna tuner. An antenna tuner is always necessary when using a whip.
- **ALE** Used to select the radio link setup mode:
 - ALE** Use of ALE protocol.
 - NONE** No link set up protocol. In this case, you can set up groups of channels to be scanned.

After selecting the desired mode, select **SET** to set the new mode.

4-4. ALE PROGRAMMING

The ALE Programming menu is used to configure the parameters needed by the ALE function. The structure of the ALE programming menu is shown in Figure 4-2.

NOTE

You can access the ALE Programming menu only after you select **ALE** for **MENU > MORE > PROG > RAD > OPTS > ALE = YES**.

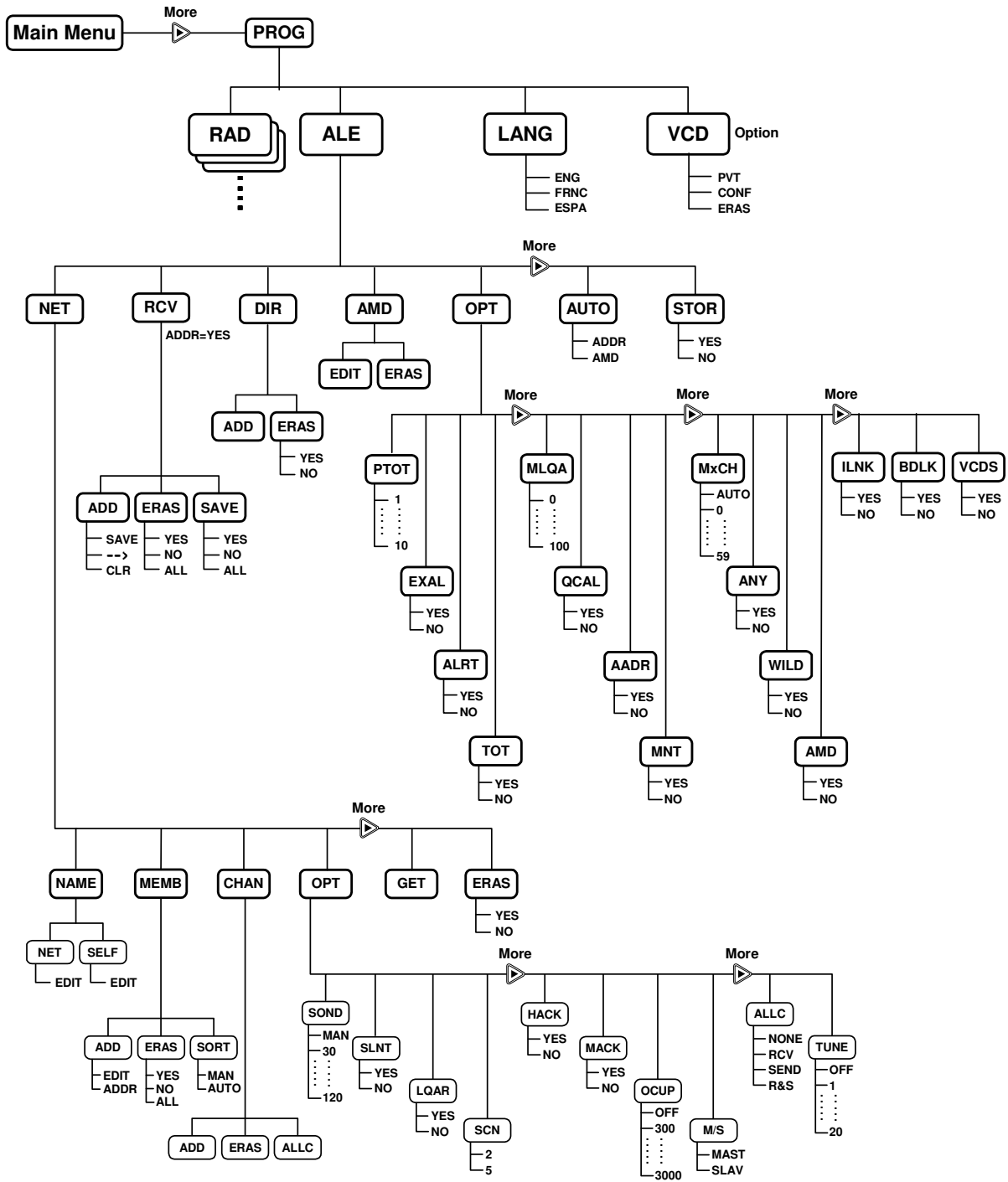
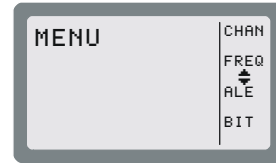

Figure 4-2. PROG Menu – ALE Parameters Programming

To start ALE programming:

1. Press **MENU** to display the Menu screen.



2. Press **MORE** to scroll to the second Menu screen.

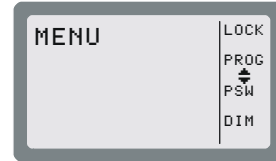

3. Press **PROG**.

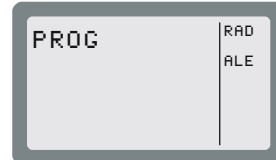

4. Press **ALE** to enter the ALE Programming menu.
5. Press **MORE** as required to access additional ALE programming parameters.

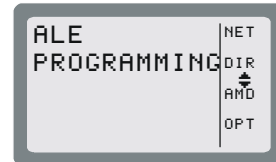

In the ALE Programming mode, you can program the following features:

Option	Description	See Page ...
NET	Net parameters: station names, options, members and scanned channels.	4-9
REC	Edit the list of stations not appearing in the directory from which calls have been received. This item is displayed only after such calls have been received, and therefore will not appear when the Micom Pathfinder is just turned on.	4-11
DIR	Directory: configuration of the ALE address list.	4-11
AMD	Messages: preparation of AMD messages ready to be sent with ALE calls.	4-11
<div style="border: 2px solid black; padding: 10px; width: fit-content; margin: 10px auto;"> <p>NOTE</p> <p>During ALE operation, you can also edit, or prepare, a message, on-line, using the PAGE EDIT option.</p> </div>		
OPT	Options: configuration of the various ALE options, such as PTT timeout, external alarm, and so on.	4-12
AUTO	Autodial parameters: shortcuts for ALE calls to frequently called stations.	4-13
STOR	Store the changes made in the ALE programming session.	4-14

The following sections explain the programming of these features.

NOTES

- The ESC key is used to cancel a change you have made, if not yet confirmed. If you have already saved changes, the ESC key will only return to a previous screen of the ALE Programming menu.
- When you end ALE programming, you must store the parameters you defined.
- If you press the MENU key to exit the programming mode without first saving your changes, you will be prompted to store the ALE configuration changes. Press YES to store the configuration. If you press NO, the configuration will revert to the previous configuration, and any changes made in the current ALE programming session will be ignored.

4-4.1 Programming Nets

When programming a net, you can set the net names, define the net members, add channels, configure various options, copy parameters from a defined net or erase an entire net.

4-4.1.1 Overview of Net Programming

The net programming mode enables you to view and edit the configuration of each net. The configuration includes the following menus:

- **NAME** Edit the net name and the self-address:
 - **NET:** Define or edit the net names.
It is not allowed to use a name already used as a self-address, nor an address already appearing in the address directory.
 - **SELF:** Define or edit your self address (the identification of your station, to be used by other stations within the same net).
It is not allowed to use a name already used as a net address, nor an address already appearing in the address directory.

A net name or self address can contain up to 15 characters. Valid characters are the letters A to Z and the numerals 0 to 9.

- **MEMB** Add or erase members (station addresses) from the list of net members. This list defines which stations can participate in a net call (a net can have up to 16 addresses).

The MEMB menu also enables you to sort the list of members: this determines the order in which members respond to a net call. You can arrange the order of the list of members manually, or instruct the radio to arrange them in alphanumeric order.

A member name can contain up to 15 characters. Valid characters are the letters A to Z and the numerals 0 to 9. It is not allowed to define a name already used as a net address, nor an address already appearing in the address directory. New member names will automatically be added to the directory list (unless the directory is full).

- **CHAN** Add or remove channels to the list of scanned channels in a net, and to define the channel on which AllCalls are to be transmitted (the *AllCall channel* (ALLC)).

NOTES

- Each net can contain up to 100 scanned channels.
- All nets combined can contain up to 100 scanned channels. If you exceed this number, the message **OVER 100 CH** is displayed for one second, and then the display returns to the previous menu.
- If you enter a channel which is not programmed, a **NOT PROG** message is displayed for a second, and the display returns to the previous menu.

- **OPT** Configure net options, including: sounding, silent net, LQA request, scan rate, home acknowledgment, monitor acknowledgment, occupancy detection, master/slave definitions, AllCall options and tune time.
- **GET** Copy all parameters from one net to another. This function is useful if you are defining a new net and wish to base most of its parameters on an existing net, for instance if you need to use different frequencies/channels for day and night communication, but all other net information (such as stations and names) is identical.
- **ERAS** Erase an entire net from the ALE data base.

After preparing a set of parameters, your entries are checked and any errors are reported. If you do not correct the detected errors, Micom Pathfinder will offer to discard the new set of parameters.

4-4.1.2 Default Values

Unless you define different values, each net uses the following factory-defaults:

- | | |
|--------------------------|--------------------------|
| • Net Name | No default defined |
| • Self Address | No default defined |
| • AllCall | Send and receive enabled |
| • AllCall Channel | No default defined |
| • Tune Time | No tune time |
| • Silent | No |
| • Home Acknowledgment | Yes |
| • Monitor Acknowledgment | No |
| • Master/Slave | Master |
| • LQA Request | Yes |
| • Sounding | Manual |
| • Occupancy Check | No |
| • Scanned Channels | No default defined. |

When programming a new net or other ALE parameters, you do not need to define all parameters: change only those for which the default values are not suitable.

4-4.2 Setting the Net Options

Use this menu to configure net options:

- **SOND** Sounding Parameters: define the interval (in minutes) at which automatic sounding is performed (30, 60, 90 or 120 minutes), or define sounding as a manual function. See Appendix A for a detailed explanation on the sounding process.
- **SLNT** Silent Mode: select whether the net is in the silent mode, which means that members in the net can initiate calls but not allowed to respond to an ALE transmission.
- **LQAR** LQA Reports: select whether your radio will ask the called station for a report on the quality of the communication every time a call is initiated.
- **SCN** Scan Rate: select the number of channels scanned each second when the radio is in ALE mode: can be set to 2 or 5 channels per second.
- **HACK** Home Acknowledgment: enable/disable home acknowledgment. When enabled, the radio transmits an end-of-call indication to the remote station.
- **MACK** Monitor Acknowledgment: enable/disable monitor acknowledgment. When enabled, the radio transmits an *accept call* indication to the station that initiated the call.
- **OCUP** Occupancy Check: enable/disable the occupancy check. The occupancy check defines whether the radio uses the speech detect mechanism to determine whether a channel on which a call is about to be made is occupied. If this option is ON, a call cannot be initiated on a channel determined to be occupied. This option can be operated in addition to the ALE signal detection mechanism.

You can select the interval at which occupancy checks are made (300 to 3000 msec, in 300-msec increments).
- **M/S** Master/Slave: select whether your radio serves as a master or slave in the current ALE network. Only a master station can initiate a Net Call.
- **ALLC** AllCall Settings: this option determines whether the ALE is able to receive and/or send AllCalls.

An AllCall is an ALE broadcast transmission. All stations receiving an AllCall are linked to the sender, even if they do not recognize the sender's address. If no AllCall channel is defined, the call will be made on the best channel in the net.
- **TUNE** Tune Time: select the tuning time. Tuning time is the maximum time the current ALE waits for the called station to tune (this is the tune-in time of the slowest tuner in the net). The tune time is added to the calculated response time. Tune time can be 1 to 20 seconds, or OFF (zero).

4-4.3 Directory Parameters

This DIR option on the ALE Programming menu enables preparing the ALE address list. This list contains the names of stations to which the radio can address a private call using the ALE. You can add a new address, and edit an existing address.

A name can contain up to 15 characters. Valid characters are the letters A to Z and the numerals 0 to 9. You cannot add an address which is identical to the name of a programmed net, nor an address already used as a self address in a programmed net. The list can contain up to 100 addresses, and is automatically sorted in ascending alphanumeric order.

4-4.4 AMD Message Configuration

The AMD option of the ALE Programming menu is used to view, edit, add or erase messages intended for transmission. The characters you can enter in messages using the radio keypad are: A to Z, 0 to 9, space, * and #. See message preparation details in Chapter 3.

Messages programmed using a remote PC with a standard keyboard can contain all the ASCII characters the range of 20 (hexa) to 5F (hexa).

The message list can contain up to 12 messages, numbered AMD 0 to AMD 11. Each message can contain up to 90 characters.

NOTE
 If no messages are stored, **EMPTY** will appear in the second display line.

4-4.5 ALE Options Configuration

This menu enables you to configure the following ALE options:

Option	Description
PTOT	PTT Timeout: the time (in minutes) which elapses between the moment you release the PTT button, until the ALE disconnects the link. The allowed range is 1 to 10 minutes.
EXAL	External Alarm: activate/deactivate the radio external alarm when a call is received.
ALRT	Alert tone: enable/disable the generation of an alert tone whenever a link is established.
TOT	Accept Link Time-out Time: the radio can be configured to disconnect the link automatically if neither the PTT, nor any other key is pressed within 30 seconds from the reception of a call. If Accept Link TOT is set to NO, the received call is accepted immediately and automatically.
MLQA	<p>Minimum LQA Score: determines the minimum acceptable LQA (Link Quality Analysis) score allowed when trying to establish a link on a specific channel.</p> <p>If the minimum score is not achieved when the radio attempts to establish a link in the ALE mode, the radio will try to establish a link on the scanned channel with the next best LQA score. At the end of this process, a link will be established on the scan channel with the best LQA score. If the call is made on a specific channel, the radio ignores the minimum LQA score check.</p> <p>The allowed range of LQA scores is 0 to 100%. When selecting the minimum LQA score, remember that in accordance with the ALE standards, the maximum LQA score (assigned for receiving an optimum sounding is 70%), and the minimum score is 30%. The score given to a station that did not send any sounding or a station whose sounding has not been received is also 30%.</p>
QCAL	Quick Call: enable/disable initiating a call to the last called address by pressing the MIC PTT button twice in rapid sequence (double pressing).
AADR	<p>Automatic address: enable/disable automatically adding the source addresses of incoming calls to the ALE directory.</p> <div style="border: 1px solid black; padding: 10px; text-align: center; margin: 10px auto; width: fit-content;"> <p>NOTE If the directory is full, new addresses will not be added.</p> </div>
MNT	MultiNet: enable/disable the scanning of multiple ALE nets. When enabled, this feature lets the radio communicate with stations in nets other than the currently selected net.
MxCH	Maximum Scan Channels: when MultiNet is enabled, the time needed for scanning all the nets may be rather long. This parameter is used to adapt the duration of the calling signal to the number of scanned net, to ensure that communications are not disrupted. You can select between automatic selection, or select a value in the range of 0 to 59 seconds.
ANY	AnyCall: enable/disable the sending AnyCalls.
WILD	Wildcard: enable/disable the sending wildcard calls.
AMD	Automatic Message Display: enable/disable the sending AMD messages.

Option	Description
ILNK	Inlink: enable/disable the inlink facility, which enables notifying other call participants when each participant disconnects from the link. All participants must be programmed to use the same selection (either YES or NO). Do not enable the inlink function when communicating with a radio that does not support the full ALE capabilities in accordance with MIL-STD-188-141B.
BDLK	Bidirectional link: enable/disable automatically setting up a link on the best channel after a bidirectional handshake with an individual station.

The ALE options have the following factory-default values:

- PTT Timeout No timeout
- Alert Yes
- External Alarm Yes
- Auto Address No
- Quick Call Yes
- Minimum LQA score 0
- Accept Link Timeout Yes
- MNT Yes
- MxCH Auto
- ANY Yes
- WILD Yes
- AMD Yes
- ILNK No
- BDLK No

When configuring ALE options, you do not need to define all parameters: change only those for which the factory-default values are not suitable.

4-4.6 Auto Dial Parameters

Auto Dial enables you to set shortcuts for calls to frequently called stations, with or without automatically attaching messages when a station is called:

- **AUTO** Used to configure up to 10 autodial codes, numbered AUTO 0 to AUTO 9.
- **AMD** Used to prepare AMD messages for sending when an autodial code is used. See message preparation details in Chapter 3.

NOTE

If a message is attached to the address, an exclamation mark precedes the address.

4-4.7 Storing ALE parameters

Before exiting the ALE programming menu, you must store the parameters you have programmed.

NOTE

If you press the MENU or ESC key to exit programming mode without first saving your changes, you will be prompted to store the ALE configuration changes. Press YES to store the configuration.

If you press NO, the configuration will revert to the previous configuration, and any changes made in the ALE programming session will be ignored.

4-4.8 Using the New Station Address Filter

To help you add new station addresses to the ALE directory of your radio set in a controlled manner, Micom Pathfinder has a special ALE address filter. To enable this filter, enable the Auto Address function on the **PROG > ALE > OPT > AADR** menu (this function can also be enabled by means of the MRC).

When enabled, the address filter compares the source address of each call received by your radio set with the addresses stored in the ALE directory. When the first new unlisted address is found, it is stored in a special memory stack, and you are notified that at least one unlisted address has been detected by adding the option RCV under **PROG > ALE**, after the **NET** option. When you want to check the addresses stored in the stack, you select **RCV** and then decide whether to erase an address or add it to the ALE directory of your radio set.

Up to 20 new addresses can be stored in this stack, which is organized as a FIFO stack: this means that when a new address, different from all the previously detected addresses, is received while 20 addresses are already stored, it will replace the oldest address.

The information on the received addresses is automatically erased when the radio is turned off; only addresses added to the directory remain in the directory.

To edit the received addresses and add addresses to the ALE directory:

1. Press **MENU** and select **ALE**.
2. When addresses are stored in the new received addresses stack, you will see the **RCV** option. Press **RCV** to display the RCV screen.

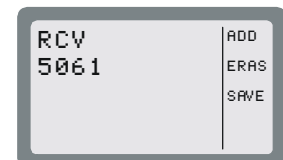

3. The RCV screen displays the last detected unlisted address. Use the **UP/DOWN** arrows to display the desired address (the display is cyclical).



4. When the desired address is displayed, press the key corresponding to the action to be performed:
 - To delete the address from the stack, press **ERAS**.
 - To add the address to the directory, press **ADD**. The address is removed from the stack.
5. To confirm, press **SAVE**.
6. Repeat the actions until all the desired addresses are processed. When done, press **ESC** to end.

If the stack is now empty, the **RCV** option is no longer displayed on the ALE menu.

CHAPTER 5

OPERATOR MAINTENANCE

5-1. GENERAL

Operator maintenance consists of routine tasks and specific checks and services that are needed to keep equipment in a “ready to use” condition. Routine tasks such as cleaning, checking cables for damage, stowing items not used and checking for loose bolts, nuts and screws must be performed whenever the operator sees that they are necessary and are, therefore, not listed in the following tables.

Visually inspect the radio set often, especially for damaged antennas. Be sure that cables are positively connected, and do not show breaks, cuts and other damage. Make sure that the radio set is assembled properly and ready for operation. Perform these checks before starting any mission, and also after every mission.

After the visual checks, perform a communication check by contacting another radio station.

If a radio set fails to operate, refer to para. 5-3 for instructions.



WARNING - HIGH VOLTAGE

During transmission, high RF voltages may appear at the RF connectors, the antenna cable, and on the antenna itself. Avoid touching the antenna and RF connectors when the radio set operates.

Make sure that the antenna is not located near high-voltage lines.

5-2. VISUAL INSPECTION AND MECHANICAL CHECKS

5-2.1 Inspection

Inspect each part as directed in Table 5-1. Repair and/or replace components found to be defective and/or damaged.

Table 5-1. Visual Inspection and Mechanical Checks

Sequence	Item to be Inspected	Procedure
1	Protective case and battery box	a. Inspect for damage, and loose or missing parts or screws. b. Remove dust and dirt. c. Check the condition of painted metal surfaces and panel lettering. Spot paint bare metal surfaces. <p style="text-align: center;">NOTE</p> Connectors, controls, the keypad and the display window must not be painted or polished with abrasives. d. Tighten all screws. Replace missing screws
2	Connectors	a. Check that all connectors are securely mounted. b. Inspect shell and contacts for damage and corrosion. c. Clean and remove all foreign matter.

Table 5-1. Visual Inspection and Mechanical Checks (Cont'd)

Sequence	Item to be Inspected	Procedure
3	ON/OFF and volume control	a. Check the control for looseness and damage. b. Turn control through its full range and check that it operates freely, without binding or excessive looseness
4	Keypad and buttons	a. Check for damage. b. Check for proper operation
5	Display window	a. Clean dirt and dust. b. Check for cracks
6	Battery connector	a. Check for corrosion or damage to contacts. b. Clean connector contacts
7	Cables	a. Check insulation for tears, breaks, and other damage. b. Check connectors for damage
8	Carrying harness	a. Check for tears, breaks, and other damage. b. Check all the straps and buckles for damage
9	Audio accessories	a. Check insulation for tears, breaks, and other damage. b. Check connectors for damage. c. Check smooth operation of PTT and loudspeaker volume control
10	Antenna	If your radio set uses the whip antenna FAD5530, make the following checks: a. Check that the antenna base is securely fastened to the panel. b. Check the whip sections for corrosion or damage. c. Check that antenna whip sections fit tightly. For other antennas, inspect in accordance with the corresponding antenna Operator Manual
11	GPS Antenna, Adapter, and GPS Cable	a. Check that the GPS antenna is securely fastened to its adapter. b. Check for physical damage to antenna and its cable, and replace if necessary. c. Check proper connection of the GPS antenna cable, CG-5602

5-2.2 Cleaning

WARNING

Prolonged inhalation of cleaning compound may be dangerous; make certain that adequate ventilation is provided. Do not use near a flame. Avoid contact with the skin. If contact with skin is made, immediately wash off with water.

Inspect the exterior of the unit. The surfaces should be clean and free of dirt, grease and other contaminants.

- a. Remove dust and other loose dirt with a soft clean, cloth.
- b. Remove grease, fungus and ground-in dirt from the cases: use a lightly dampened cloth (not wet) with an approved cleaning compound.
- c. Remove dirt from plugs and jacks with a brush.

- d. Clean the front panel displays and keypad with a soft clean cloth. If dirt is difficult to remove, dampen the cloth with water; mild soap may be used for more effective cleaning.

CAUTION

1. Do not press on the display window faces when cleaning.
2. Do not use solvents for cleaning display window, keypad and push-buttons.
3. Do not use compressed air for cleaning the panel. This may damage the push-buttons.

5-3. CORRECTIVE MAINTENANCE

The scope of corrective maintenance at the operator level is to return the radio set to normal operation as soon as possible, by replacing cables, accessories, or equipment units suspected of being defective. Replaced items shall be sent for repair at a designated maintenance facility.

In case a fault is detected, or the radio set fails to operate, perform the following steps and repeat the communication check until the problem is corrected:

1. Visually inspect the radio set, and make sure that the radio set is assembled properly and ready for operation.
2. Replace the battery with a freshly-charged battery, and then check again.
3. Turn the radio set off, and then turn it back on, and monitor the display: every time the radio is turned on, a self-test procedure is performed. If an internal malfunction is found, an error message will be displayed.
4. Activate the BIT function, using **MENU>BIT**. You have three options:
 - **FULL** – runs a full test of the Micom Pathfinder.
 - **CHAN** – tests Micom Pathfinder operation on the current channel.
 - **L.RF** – tests the Micom Pathfinder receive path only.

NOTES

1. To obtain reliable results, it is necessary to perform the test under controlled conditions. This is achieved by disconnecting the external antenna, and connecting a 50Ω dummy load or 30 db attenuator with a suitable power rating (30W or more) to the **DIPOLE** connector (make sure to select **TUNE** on **PROG > RAD > OPTS > ACC** when using a dummy load).

In addition, you must perform the test in the SSB mode, and the DPWR parameter must be MAX (DPWR changes only after the radio is turned off and back on).

2. It is not necessary to connect a load when performing only the L.RF test.
3. If the Micom Pathfinder includes an internal modem or vocoder, make sure to perform the test in the clear (CLR) mode.

Select the test best suited to the detected problem, and wait a few seconds for the test to complete.

Refer to Table 5-2 and perform the corrective actions listed for the corresponding message, until the problem is corrected. If the message does not appear in Table 5-2, or the problem persists, the radio set must be serviced.

Table 5-2. Fault Messages

Message	Corrective Actions
OVER TMP	Check that the radio is not exposed to direct sun radiation, and that there is no obstruction to free air flow around the radio
NOT PROG (Error 14)	This message indicates that the radio is not programmed (the message may also appear if the radio DC power failed during programming). In this case, the default baud rate of the MRC interface is 1200 bps. Program the radio parameters (using the MRC). This forces the radio to accept the downloaded parameters
BATTERY FAIL (Error 11)	Micom has an internal battery, that enables the memory to store the last channel information that was used before the radio was turned off. If this battery becomes weak, it will display this warning. When the battery is dead, all the channel information will be retained, but the radio will always use channel 1 when you turn the radio on. (Example: if you are scanning in the ALE mode and you turn the radio off; when you turn the radio back on, it will be on channel 1). You may continue using the radio, but request service as soon as possible
DATABASE FAIL (Error 15)	This message will appear if the ALE scanned channels do not match the programmed channels in the MRC (for example, ALE is programmed to scan channels 1, 2 and 3, but the MRC program does not have a frequency programmed into channel 3). Check and correct the programmed parameters

APPENDIX A

USING BATTERY CHARGER, FRN8570B

A-1. PURPOSE AND USE

FRN8570B is an AC-powered portable battery charger designed to charge 14.4V Lithium-Ion rechargeable battery packs of the type used by Micom Pathfinder (FRN8577).

FRN8570B is simple to operate and does not require operator attendance during operation, yet it provides advanced features, such as fully automatic charging and automatic stopping after battery pack charging is completed. FRN8570B does not have any controls, as its operation is fully automatic. A single indicator displays the operating state.

The FRN8570B is intended for use in rooms, shelters, etc. Do not expose the FRN8570B to direct sun radiation or excessive temperatures, rain, snow, or high humidity. Keep charger battery contacts clean, and avoid accidental short-circuits by powering the FRN8570B on only after a battery is connected.

A-2. FRN8570B DESCRIPTION

FRN8570B comprises three components:

- AC/DC converter, which provides 24 VDC for the charger unit. The AC/DC converter has an integral DC output cable terminated in a 2.5 mm round plug, for connection to the charger unit.
- AC power cable for the AC/DC converter.
- Charger unit, powered by 24 VDC provided by the AC/DC converter. The charger has a short charging cable terminated in a two-pin connector plug with a polarizer pin that matches the FRN8577 charging connector (pin polarity is marked next to each pin).



A-3. FUNCTIONAL DESCRIPTION

The FRN8570B is powered from 100 to 240 VAC, 50/60 Hz. FRN8570B operation is fully automatic, to ensure full charging of batteries to their rated capacity, and to prolong the operational life of batteries by providing optimum charging conditions.

To control battery charging, the FRN8570B charger unit automatically tests the battery pack as it is connected to the charger, and continues monitoring the battery state during the charging process, to detect the exact moment when the battery becomes fully charged. This prevents overcharging of batteries. The operator is informed of the progress of charging by a status indicator.

The charging process is as follows:

- When powered up, the charger unit checks the current and voltage supplied to the battery connector, to detect the connection of a battery pack of the proper type, and identify defective battery packs. This enables the detection of failed batteries, for example, batteries with short-circuited cells, so that such batteries can be taken out of service.
- When the connection of a battery pack of the proper type is detected, charging proceeds until the pack is fully charged. While charging proceeds, the charger unit LED flashes green, and changes to steady lighting in green when charging is complete.
- If a fully charged battery remains connected after its charging is completed, as long as the FRN8570B is powered the charger remains in standby (the LED lights steadily in green, with short blinks every 30 seconds).

A-4. FRN8570B OPERATING INSTRUCTIONS

A-4.1 Familiarization with Charger Unit

Figure A-1 shows a typical charger unit. The unit includes the following items:

- DC input connector: round 2.5 mm connector for the 24 VDC charger supply voltage.
- DC output cable, terminated in a plug matching the FRN8577 charging connector.
- Status indicator. Table A-1 explains the indications provided by this indicator.

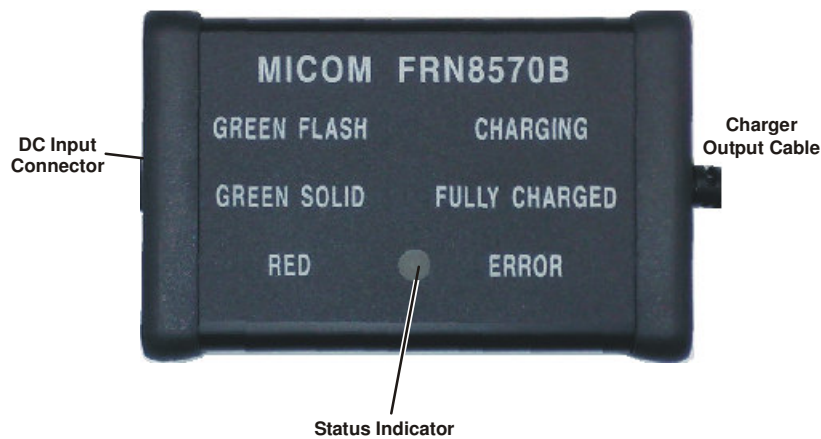

Figure A-1. Charger Unit, General View

Table A-1. Status Indications

Indicator State	Meaning
Off	Charger not powered
Green flashing	Charging in process
Green steady on (short blinks every 30 seconds)	Charge process complete, battery is fully charged Charger in standby (no battery connected)
Red steady on	Error condition, for example, short-circuit across charger terminals, or connection to incorrect type of battery (for example, NiCd or NiMH battery)

A-4.2 Preparations for Charging

1. Place the battery charger on a flat, clean surface, protected from sun and rain.
2. Insert the DC output plug of the AC/DC converter into the DC input connector of the charger unit.
3. Connect the AC power cable to the power input connector of the AC/DC converter, and then connect the other end of the power cable into an AC outlet.

A-4.3 Charging Process

1. When ready to charge a battery, connect the battery to be charged to the battery charger: insert the DC output plug of the charger unit into the FRN8577 charging socket and press firmly to mate (the connectors will mate only if plug is correctly oriented).
2. The status indicator of the charger unit will start flashing in green.

NOTE

If the battery is faulty, the status indicator will start flashing in red. In this case, no charge current is supplied to the battery. Disconnect the power, and replace the battery.

3. The charger now operates automatically. When the battery is fully charged: the status indicator of the charger unit lights steadily in green, with short blinks every 30 seconds.
4. At this stage, disconnect the battery from the charger. The status indicator continues to light steadily in green (with short blinks every 30 seconds), to indicate that the charger is in standby.
However, if necessary, you may leave the battery connected to the charger.
5. If the charger is no longer needed, disconnect the power cable from the AC outlet, and then disassemble the charger by disconnecting its components.

A-5. MAIN FRN8570B TECHNICAL SPECIFICATIONS**Charger Specifications**

Charging Termination Method	CC/CV voltage point
Maximum Charge Rate	3000 mA
Charge Termination Voltage	16.8V
Top-Off Charge Current	300 mA for 1 hour
Input Voltage	24 VDC nominal (allowed range: 18 to 28 VDC)
Cable Length	30.5 cm (12 in)
Input Connector	2.5 mm, center positive
Dimensions	86 × 56 × 26 mm (3.38 × 2.20 × 1.02 in)
Operating Temperature Range	0 to 45°C
Storage Temperature Range	-25 to +70°C
Weight	171 g (6.0 oz.)

AC/DC Converter Specifications

Output Voltage	24 VDC (22.8 to 25.2 VDC)
Output Connector	2.5 mm, center positive
Input Voltage	90 to 264 VAC, 47 to 63 Hz, single phase
Dimensions	76.2 x 43.2 x 147.3 mm (3.0 × 1.7 × 5.8 in)
Weight	482 g (17 oz.) typical
Output Current	3.1A maximum
Input Current	2A maximum at 100 to 240 VAC

APPENDIX B

INSTALLATION OF FAA5548 TACTICAL DIPOLE ANTENNA

B-1. SCOPE

This Appendix provides concise installation instructions for the FAA5548 tactical dipole antenna.

The information provided in this Appendix complements the information appearing in the FAA5548 Tactical Dipole Antenna User Manual.

B-2. FAA5548 DESCRIPTION

The FAA5548 is a manpack-portable half-wave dipole antenna for field use. The antenna is marked with frequency markings along its length, to enable easy setting of desired operating frequency.

The FAA5548 includes the following components:

- Two antenna elements constructed of PVC covered copper braid with Kevlar core. Each element is 36 m long, and is calibrated in accordance with the operating frequency. The intervals between calibration labels are as follows:
 - 2 to 3 MHz range: 0.1 MHz.
 - 3 to 4 MHz range: 0.2 MHz.
 - 4 to 10 MHz range: 0.5 MHz.
 - 10 to 18 MHz range: 2 MHz.
 - 18 to 30 MHz range: 4 MHz.
- Coaxial cable assembly, 10 m long, with fitted strain relief and terminated in two BNC male connectors. To cover longer distances you may order an extension cable.
- Center junction unit (black polypropylene) with BNC female socket.
- Two throwing ropes made of 1.5 mm polyester flexible plaited rope. Each rope is 20 m long and is fitted with 2 oz lead weight at one end.
- Belt mounted kit bag for antenna components.

B-3. ANTENNA CONFIGURATIONS

The FAA5548 dipole antenna can be installed in four configurations, depending on the supports available and the desired radiation pattern. The configurations are as follows:

- Horizontal dipole
- Inverted V dipole
- Sloping dipole
- Wire antenna.

The antenna must be located in a clear area, with natural or manmade supports to hold the antenna up. Two end supports will be needed for a dipole configuration, while only a single support is needed for an inverted V, sloping dipole or long-wire configuration. The clear area must be large enough to accommodate the antenna without any physical obstructions. The length of this area will depend on which configuration you choose, and the frequency of operation.

B-3.1 Horizontal Dipole

A dipole antenna consists of two conducting elements with a center junction connected by a coaxial to the antenna dipole connector on the radio.

The most common configuration is the horizontal dipole, shown in Figure B-1. The radiation pattern for this antenna is broadside to the antenna elements (that is, perpendicular to the running direction of the wire). The vertical radiation angle of a horizontal dipole is a function of its height above ground. In general, mounting closer to the ground increases the near-vertical incident skywave (NVIS), which is best for short-distance communications.

Mounting the horizontal dipole higher up causes the vertical radiation angle to tilt down, towards the horizon. This will favor long-distance communications. In any case, the recommended height range is from $\frac{1}{10} \lambda$ (minimum) to $\frac{1}{4} \lambda$ (maximum), where λ is the wavelength.

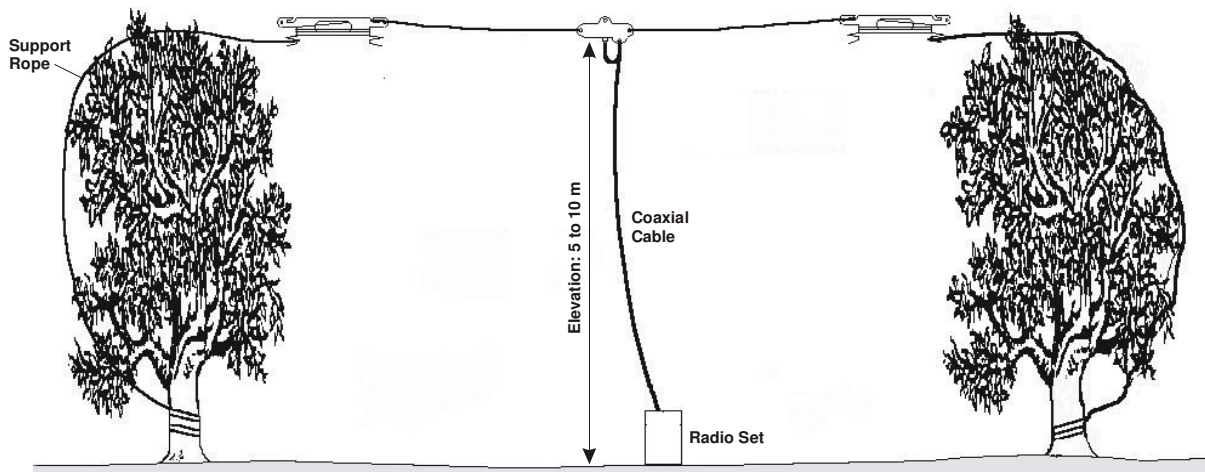

Figure B-1. Horizontal Dipole Configuration

NOTE

When using trees as end supports, wrap end of support rope around tree three or four times. Make sure to leave slack in support rope, so that the center of the antenna sags down.

B-3.2 Inverted V Dipole

At low frequencies, the required antenna element length is very long. To minimize physical stress and sag at the center point, an inverted V configuration (Figure B-2) should be used, instead of a standard horizontal dipole. This configuration will result in better RF performance, since the feedpoint (the point of maximum radiation) is placed high above ground. In addition, the use of a halyard support may be helpful; as it will relieve the antenna wire from excessive stresses and increase its life span.

This alternative to the horizontal dipole has an added advantage: to install the inverted V, only one support is needed (at the center), instead of the two needed for the horizontal dipole.

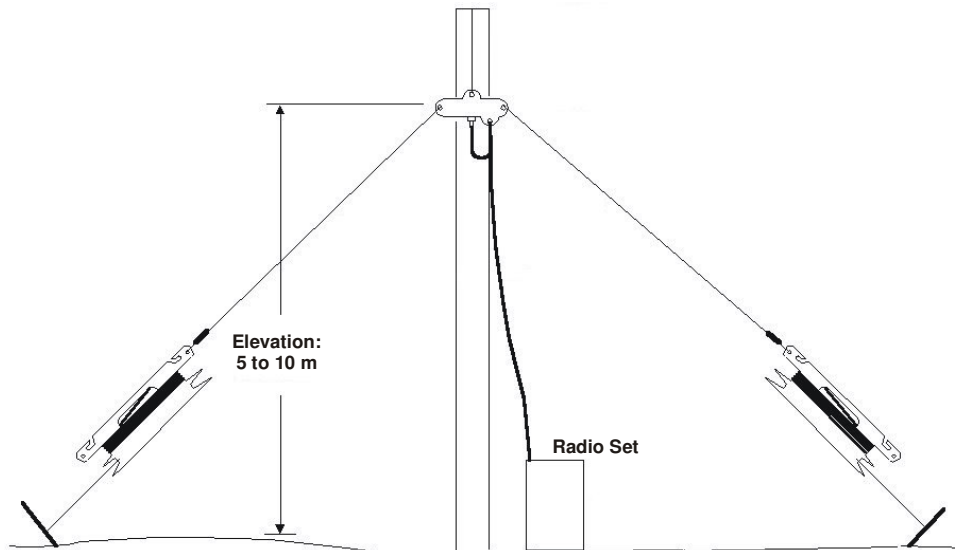

Figure B-2. Inverted V Configuration

When using the inverted V configuration, pay attention to the following points:

1. The angle between the two halves must be 90° or greater, to prevent cancellation of the radiated energy.
2. The main radiation lobe of the inverted V is broadside to the direction of the wire, the same as for the horizontal dipole. However, the inverted V also exhibits a minor radiation lobe directly in line with each end of the wire. These minor radiation lobes have generally a low vertical radiation angle, which is useful for long-distance communications. The antenna can be oriented to take advantage of this combined radiation pattern.

B-3.3 Sloping Dipole

The sloping dipole configuration can be used to obtain a long-distance, slightly directional radiation pattern.

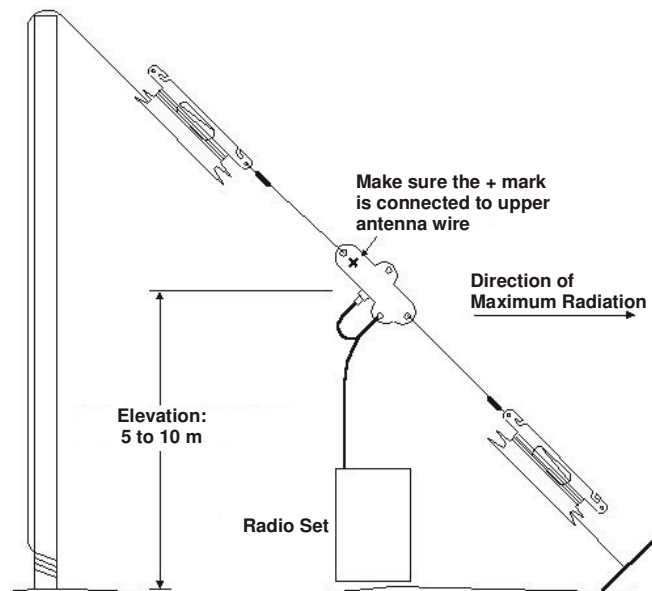

Figure B-3. Sloping Dipole Configuration

When using the sloping dipole, pay attention to the following points:

1. Sloping dipoles exhibit mostly low-angle radiation, which is suitable for long-distance communications, but generally poor for short-distance skywave (NVIS) operation. Sloping dipoles are recommended for long-distance communication only.
2. The sloping dipole exhibits some gain in the direction of the sloping wire. Conversely, it exhibits a significant null in the opposite or rear direction. This directional pattern can be used to optimize signal strength in one favored direction, and/or minimize interference coming from an undesired direction.

B-3.4 Wire Antenna Configuration

For extended communication ranges (on the order of hundreds of kilometers), it is strongly recommended that a dipole antenna be used.

In emergency situations, or when the topography does not allow the erection of a dipole antenna, it is possible to use a wire antenna. A wire antenna consists of a single conductor.

The wire antenna has a directional radiation lobe, directed in the direction at which the wire is pointed (similar to the main radiation direction of the sloping dipole).

NOTE

The wire antenna is an improvisation when there are time or location constraints. It is not recommended as a standard antenna.

You can also use the FAA5548 as a wire antenna by connecting only one wire to the center junction (always to the side marked by + (plus)).

- When the wire length is close to the dipole wire length required at the operating frequency, you can connect the wire antenna, through a coaxial cable, to the DIPOLE connector of the Micom. In this case, select the dipole antenna upon power-up.
- When the wire length is short, connect the wire directly to the WHIP connector of the Micom. In this case, select the whip antenna upon power up.

B-4. FAA5548 INSTALLATION PROCEDURE

CAUTION

Before installing the antenna, make sure the selected location is not near power lines.

The procedure given below assumes familiarity with the FAA5548. For further details, refer to the FAA5548 Tactical Dipole Antenna User Manual.

1. Whenever possible, erect poles of appropriate height to support the dipole antenna elements.
2. Attach both antenna elements to the center junction unit.
3. Connect the BNC coaxial feed line to the center junction.
4. Determine the length of the antenna elements according to the operating frequency.
5. Unwind both antenna elements until they are of the desired length, and then loop the antenna wire through the slot on the winding spool.
6. Fully unwind the end support ropes from each winding spool. Throw the end weights over the trees or other structures used as the end supports.
7. Pull the end support ropes until the center junction is 5 to 10 m above ground. Be sure to leave some slack in the ropes, so that any movement of the end supports for example, as a result of winds, will be accommodated. Tie the ropes to ensure that the antenna maintains its position.

CAUTION

When erecting the antenna, avoid excessive stress. It is normal for the center point of the antenna to sag downward, which will not adversely affect performance.

Use of excessive pulling force will put undue stress on the antenna wire, insulation, and other components.

8. Connect the BNC connector at the free end of the antenna feed cable to the Micom DIPOLE connector.

Intentionally Left Blank

APPENDIX C

ALE CAPABILITIES AND FEATURES

C-1. SCOPE

This Appendix provides a concise description of the ALE capabilities and features.

C-2. SCANNING

The method used to select the best channel is based on scanning: as long as it is idle, a radio operating in the ALE mode switches frequency at a relatively rapid rate (programmable at 2 or 5 channels per second) within the group of channels that can be used (the ALE frequency table, with up to 100 frequencies). During this process, it collects information regarding the state of each channel (busy/free and its background noise) that can be used together with the quality information collected by sounding when the user initiates a call.

- When a station initiates a call, it selects the best free channel on the basis of the most recent information, switches to that channel and then transmits a call request for a time sufficient for any station to finish scanning all the preprogrammed channels and reach the selected channel.
- Any station that should receive this call will then stop on the channel used by the initiating station, and will use the channel for communication. The exact response to the call request depends on the type of call (call types are described below): as a result, it is possible to program any desired station to ignore some types of calls (in fact, any call not specifically addressed to it).

C-3. SOUNDING

Automatic sounding is the method used by ALE for testing the quality of channels and propagation paths under field conditions. The sounding signal is a unilateral identifying broadcast, repeated at periodic intervals on unoccupied channels. Identification of a sounding signal sent from a station indicates a high probability of bidirectional communication.

The length of the sounding cycles can be set to short or long cycles, depending on propagation conditions. When propagation changes are slow, long intervals of about 1 or 2 hours may be sufficient. If, however, the propagation changes are erratic and rapidly changing, or if it is critical to have updated connectivity information, then shorter intervals are recommended. Each station can also measure BER and S/N, and update the LQA table accordingly.

The maximum score for receiving an optimum sounding is 70%; the minimum score is 30%. The score given to a station that did not send any sounding or a station whose sounding has not been received is also 30%.

C-3.1 Sounding Cycle Time

The sounding signal is repeated at regular intervals on all the channels in the network. A complete round of sounding messages, or **sounding cycle**, can be programmed to 30, 60, 90, or 120 minutes when the automatic sounding is on. You can also manually initiate sounding when there is a specific need for it, even if the system is set to operate in the automatic mode.

A short sounding cycle ensures a more updated LQA memory. However, frequent sounding increases network occupancy, leaving less channel-free time for the users. Figure C-1 illustrates network occupancy in relation to sounding cycles of 30, 60, 90 and 120 minutes. (Note that both axes have logarithmic scales.) The chart also shows 80% and 95% occupancy in a 120-minute sounding cycle at a very rapid scanning rate (applicable only to multiple-channel networks).

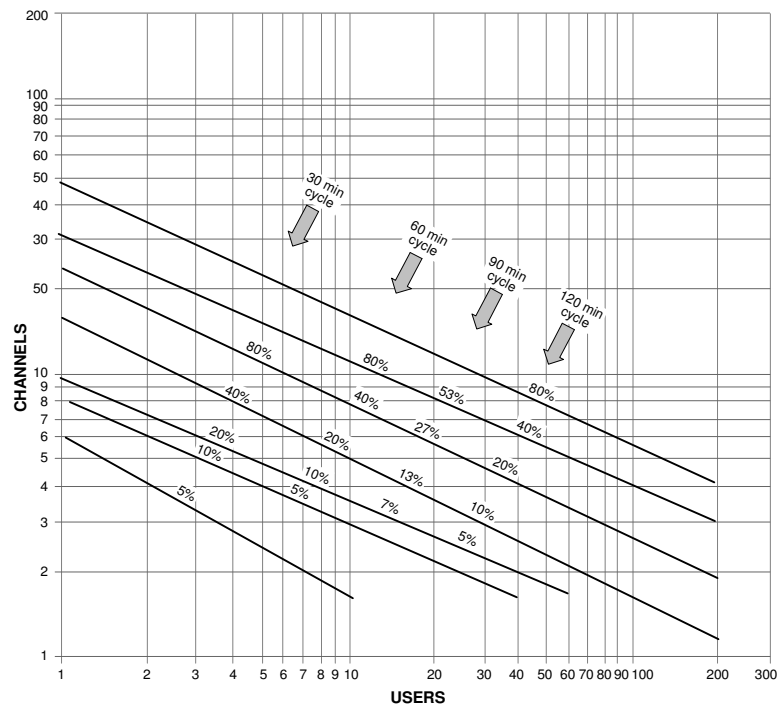

Figure C-1. Network Occupancy

Use the chart to determine the best sounding cycle for your particular network, bearing in mind network occupancy, propagation conditions and other considerations.

The following examples demonstrate how to read the chart.

- In a network of nine channels used by eight members, a 30-minute sounding cycle would result in 80% occupancy; a 60-minute cycle would result in 40% occupancy; a 90-minute cycle would result in 27% occupancy and a 120-minute cycle would result in 20% occupancy.
- If there are only two or three channels in the network, a sounding cycle of 30 minutes allows enough channel-free time, even for as many as ten users.

Under field conditions, occupancy will usually be less than the value obtained from the chart because not every station receives all the soundings that are being broadcast on all channels.

To increase channel-free time for the users by reducing network occupancy, you can try one of these four methods (in this order):

1. Increase the sounding cycle time (to 90 or 120 minutes).
2. Reduce the number of channels in the network (for example, by using different nets for different times of day).
3. Reduce the number of stations in the network by re-arranging the hierarchical subgrouping of stations.
4. Request all stations to set the fast scan rate option.

C-3.2 Manual Sounding

When it is necessary to perform a rapid sounding cycle on all channels instead of, or in addition to the automatic sounding cycle, manual sounding can be used.

C-4. LQA MEMORY

The ALE builds a database of connectivity information based on calls and the ALE sounding messages transmitted by other stations in the network. This information is stored in a special LQA memory and is used to determine the link quality of all channels in the networks. The data in the LQA memory is **time-weighted**, that is, recent information is given more value than old, thus compensating for changing propagation conditions.

C-5. BIDIRECTIONAL HANDSHAKE

The bidirectional handshake is an operator-initiated procedure used to exchange LQA scores with other stations without establishing a link.

NOTE

The Micom Pathfinder can also be programmed to automatically initiate the call to the station after finishing the bidirectional handshake (using the BDLK parameter reached under the ALE programming options).

This procedure is useful in the following cases:

- The radio has only recently been switched on and the automatic sounding cycle has not yet been completed.
- The operator wishes to update the LQA scores before initiating a call to another station, for example, for example, because of abrupt atmospheric charges, or other propagation changes.
- A new or passive station has joined the system.

A bidirectional handshake can be carried out with a single station or with all stations in the net. It can be carried out either on a single channel, or on all the net channels. When required, a message can also be added to the procedure.

After a bidirectional handshake with a single station, the LQA matrices of both radios are updated. The operator can then initiate a call to that station and obtain the best channel automatically.

When the bidirectional handshake procedure is performed with a net, all the stations in the net update their LQA tables.

C-6. SELECTIVE CALLING

Micom Pathfinder uses an approach standardized in MIL-STD-181-141B and FED-1075 to selective calling, and therefore has the capability and flexibility to link with one or many prearranged or as-needed single or multiple stations.

This selective calling capability is based on the use of a special addressing method.

C-6.1 ALE Addressing Method

ALE uses digital addresses to identify stations. The fundamental address element in the ALE system is the single word: one ALE address word must always contain three characters (one triplet).

A single ALE word is needed for the basic individual station address (this is called a **basic address**). To increase the available range of addresses, basic addresses can be expanded up to a maximum of 5 words (15 characters): such addresses are called *extended addresses*.

The characters that can be used in addresses are a subset of the standard Basic 38 ASCII character set. This subset includes:

- All the capital (upper case) letters (A to Z)
- All the digits (0 to 9)
- Two utility characters:
 - The stuffing symbol @. It can be used to add characters at the end of an address, so that the resulting length is a whole number of words (triplets). A receiving station then interprets only the non-stuffing characters. For example, if the address has 8 characters, add one @ at the end of the address, whereas for an address with 7 characters, two @ symbols must be added. In special addressing modes, this symbol is interpreted as an *ignore* instruction: see additional utilization guidelines in Table C-1.
 - The wildcard symbol ?. It is used to indicate that any character (except @) is acceptable (this is the equivalent of a *don't mind* instruction). See Table C-2 for utilization guidelines in the special addressing modes.

NOTE

In the following sections, "A," "B," "C" or "D" indicates any alphanumeric character other than "@" or "?".

Micom Pathfinder has the capacity to store and use 100 addresses of up to 15 characters each. Micom Pathfinder will reject addresses longer than 15 characters, and will notify you with an UFA WRONG message.

C-6.2 Address and Call Types

ALE stations, including the Micom Pathfinder, have the capability and flexibility to link with one or many prearranged or as-needed single or multiple stations. There are three general addressing methods:

- Individual station addressing
- Multiple stations addressing, for example, net and group
- Special addressing modes, for example, AllCall, AnyCall, etc.

The following sections explain the addressing modes and how they can be used for various purposes.

C-6.2.1 Individual Station Address

The individual station address may contain 1, 2, 3, 4, or 5 words. To enable using addresses that are not an integer multiple of 3 characters (for example, an address consisting of 1, 2, 7, 8, 10, ..., etc. characters), stuffing can be used: with stuffing, the last address word includes one or two stuffing symbols in the last position(s) (see the "stuff-1" and "stuff-2" patterns in Table C-1).

The wildcard symbol cannot be included in an individual station address, nor in a call request to an individual station.

Table C-1. Use of “@” Stuffing Symbol

Pattern	Interpretation
A B C	“Standard” 3-character address word, shown here for reference. Only the station with this address stops scanning and responds
A B @	“Stuff-1” reduced address field, used to add characters “A, B” at the end of the address
A @ @	“Stuff-2” reduced address field, used to add character “A” at the end of the address
@ ? @	“AllCall” global address (see also Table C-2): all the stations stop and listen (unless this function is inhibited)
@ A @	“Selective AllCall” global address: each station with the same last character “A” stop scanning and listen (unless this function is inhibited)
@ @ ?	“AnyCall” global address (see also Table C-2): all the stations stop scanning and respond in randomly selected timeslots (unless this function is inhibited)
@ @ A @ B@ (option)	“Selective AnyCall” address: each station with same last character(s) “A” (or “B”) stops scanning and responds in a randomly selected timeslot (unless this function is inhibited), using its own address
@ A B @ C D (option)	“Double selective AnyCall” address: each station with same last characters “AB” (or “CD”) stops scanning and responds in a randomly selected timeslot (unless this function is inhibited), using its own address
@ @ @	“Null” address; all the stations ignore this address. The null address intended for use in test and maintenance, or to create an extra “buffer” timeslot

C-6.2.2 Net Addresses

The purpose of a net call is to rapidly and efficiently establish contact with multiple prearranged (net) stations. This is achieved by the use of a single net address.

The net address is actually an additional address assigned in common to all the stations that are members of a specific net. Its address structure is identical to that used for individual station addresses (basic or extended, with or without stuffing, as necessary).

When defining a net, each member station is automatically assigned a timeslot: by having each station answer a call request in a different timeslot, collisions are avoided.

C-6.2.3 Group Addresses

The purpose of a group call is to rapidly and efficiently establish contact with multiple non-prearranged (group) stations.

To make a group call, a calling ALE station uses a sequence of the actual individual station addresses of the called stations.

C-6.2.4 Special Addressing Modes – Use of Wildcards

A “wildcard” is a special character, “?”, that a calling station can use to address multiple stations with a single call address. The following rules apply:

- The total length of a calling address that includes wildcard(s) must be equal to that of the called station addresses.
- A receiving station will accept a wildcard character as a substitute for the alphanumeric character in its own address that occupies the same position. This means that the wildcard character is a substitute for any of 36 characters and digits (A to Z, 0 to 9) in the Basic 38 character subset.

- Multiple wildcard characters can be used in different positions of the same address (basic or extended).

See Table C-2 for examples of patterns using the “?” wildcard symbol.

Table C-2. Use of “?” Wildcard Symbol

Pattern	Interpretation
A B C	“Standard” 3-character address, shown here for reference. All the characters in this word must be evaluated
A B ? A ? C ? B C	“Standard” “wild-1” address word. Indicates that only the positions occupied by other characters (“A” and “B”) need be evaluated: the position occupied by the “?” symbol can be ignored (<i>ignored</i> in this context means that any valid character is accepted)
A ? ? ? B ? ? ? C	“Standard” “wild-2” address word. Indicates that only the position occupied by an character (“A”, “B” or “C”) need be evaluated: the positions occupied by the “?” symbols can be ignored
? ? ?	“Standard” “wild-3” address word. Indicates that all of the three positions in this word can be ignored
A B @	“Stuff-1” reduced address field, shown here for reference. Only the first two characters in this word must be evaluated
A ? @ ? B @	“Wild-1” “stuff-1” address. Only the character “A” or “B” in this word must be evaluated
? ? @	“Wild-2” “stuff-2” address. Only the character “A” or “B” in this word must be evaluated
A @ @	“Stuff-2” reduced address field, shown here for reference. Only the first character in this word must be evaluated
? @ @	“Wild-1” “stuff-2” address. Only the first character in this word must be evaluated, and is ignored
@ A B	“Double selective AnyCall” address word, shown here for reference: only the last two characters in this word must be evaluated
@ A ?	“Double selective AnyCall” “wild-1” address word: only the middle character “A” in this word must be evaluated
@ ? B	Not permitted. Use “selective AnyCall”
@ ? ?	Not permitted. Use “global AnyCall”
@ @ A	“Selective AnyCall”: see Table C-1
@ @ ?	“Global AnyCall”: see Table C-1
@ A ?	“Selective AllCall”: see Table C-1
@ ? @	“Global AllCall”: see Table C-1
? @ ?	“Inlink address”: see page C-7

C-6.2.5 AllCall Addresses

An AllCall is a general broadcast that does not request responses and does not designate any specific addressee: a call with this address is accepted by any station, which then stops scanning and listens to the call. The most common use of AllCalls is in cases of distress: when in distress, it is more likely to want to make any available connection in the minimum period of time than to issue a call to an individual or to a select group.

The global AllCall address is @?@. As a variation, the calling station can also use selective AllCall. Basically, the selective AllCall address is identical in function to the global AllCall, except that it

specifies the last single character of the addresses of the desired subgroup of receiving stations (that is, it replaces the ? with an alphanumeric – see more details in Table C-1). Any station whose address matches the pattern stops scanning and listens.

The operator can always initiate an outgoing (transmit) AllCall, but the Micom Pathfinder can be programmed to accept or ignore incoming (receive) AllCalls.

When a radio issues an AllCall, all the stations that are capable of receiving calls receive the AllCall.

In the scan mode, if the Micom Pathfinder station is set to receive AllCalls, it stops scanning when an AllCall is received. If an AllCall channel has been defined, then outgoing AllCalls are performed on that channel. If no AllCall channel has been defined, the call is performed on the first scanned channel of the net. In the Channel mode, outgoing AllCalls are performed on the currently active channel.

NOTE

You can transmit an AllCall by pressing the ESC button for a few seconds.

C-6.2.6 AnyCalls

An AnyCall is a general broadcast similar to AllCall with the difference that it requests responses, without designating any specific addressee(s). Therefore, an ALE station may use the AnyCall to generate responses from essentially unspecified stations, and thus it can identify new stations and connectivities.

The global AnyCall address is @@?. As a variation, the calling station can also use selective AnyCall, which is identical in function to the global AnyCall, except that it specifies the last single character of the addresses of the desired subset of receiving stations (that is, it replaces the ? with an alphanumeric – see more details in Table C-1). If even narrower acceptance and response criteria are required, double selective AnyCall may be used: this is identical to selective AnyCall, except that its special address (@AB) specifies the last two characters that the desired subset of receiving stations.

The operator can always initiate an outgoing (transmit) AnyCall, but the Micom Pathfinder can be programmed to accept or ignore incoming (receive) AnyCalls.

Any station accepting an AnyCall stops scanning, and then initiates a response in a randomly selected timeslot.

C-6.2.7 Self Addresses

Stations can also use their own self addresses when making calls. This may be useful for self-test and maintenance purposes, etc.

The self address may be used only in specifically-addressed calls including a group call, but not in an AllCall or AnyCall.

C-6.2.8 Null Address

The null address is a special type of address that is not directed to, accepted by, or responded to by any station.

This address is intended for test and maintenance purposes, and to provide buffer time: for example, if a null address appears in a group call, no station will respond in the associated timeslot.

C-6.2.9 Inlink Address

The inlink address, ?@?, is used to instruct all the stations participating in an already established link to accept and act upon the information sent with the inlink address. For example, any station can use the inlink address to send an AMD message that all the linked stations would present to their user.

The inlink address is recognized only after a link is established between two or more stations.

C-7. USING THE MULTINET FEATURE

Normally, a radio operating in the ALE mode receives and transmits only in its currently selected net. However, there are operational scenarios in which it is beneficial to enable radios to use the ALE functions while still being aware of what is going on in additional nets (for example, firefighters and paramedics must often respond to the same emergency), and be able of answering a call in another net. For this purpose, Micom Pathfinder radios offer the MultiNet feature.

When the MultiNet feature is enabled, a Micom Pathfinder radio can operate on multiple nets (up to 20). The operating characteristics then change as follows:

- Channels: each net has a group of assigned (receiving and associated transmitting) frequencies. The radio scans the channels in one net after the other, until all the nets have been scanned.
- Station addresses (the self-address and the net address used when responding to calls): the radio responds according to the self-address assigned to the station in its currently selected net (for a total of up to 20 self-addresses).
- Sounding: each radio sends soundings only within the currently selected net. Each radio scans all the channels in the currently selected net, one by one. Sounding is started 10 minutes after the unit is switched on. The sounding group interval is determined according to the programmed Sounding Auto Time.

During operation, the Micom Pathfinder radio scans all the frequencies included in the defined nets:

- When the radio receives a call, it responds with the self-address that is programmed in the radio for that net.
- When initiating a call, you select the net you want to transmit to, and then select an address (a specific station, or any other type of address you wish to use). The radio then looks up the frequencies that are associated with the station you call and uses only those frequencies to call that station.
- LQA exchanges and sounding use only frequencies associated with the currently selected net.

Note that the time needed to scan multiple nets may be rather long, even when using the rather fast 5 channels/second scan rate. Moreover, the duration of a call set up request must also be long enough to ensure that your call reaches all the relevant nets. You can use the MaxScanCh parameter (an ALE programming option) to change the duration: the default, when AUTO is selected, is about 7 seconds; however you can select a different value, in the range of 1 to 59 seconds. Make sure to use the minimum value that ensures all the nets will hear your call set up request, because long durations are very disruptive.

C-8. MESSAGES

The ALE enables you to create, send or receive alphanumeric messages (“paging” messages) in accordance with the AMD (Automatic Display Message) definition in Federal Standard FS-1045.

The messages are displayed on the receiving station LCD display, and can be up to 90 characters long. Messages can be added to any type of call, whether individual, group, net, AllCall, AnyCall, bidirectional handshake, etc. You can create up to 12 messages, and can edit or erase any of the messages at any time.

C-9. USING THE CALLER STACK

The *caller stack* is an internal memory that stores a list of unanswered calls. Each stack entry contains the self address of the calling station and a message (AMD) if any was sent. You can view the list, return a call and view any message sent with any call.

The stack can contain up to 10 calls. The radio records an address in the stack only once even if the same caller makes repeated unanswered calls. However, if the same caller sent calls with different messages, all such calls will be saved in the stack. Each stack entry is referred to as a Page.

The appearance of the word STAK next to one of the function buttons of the LCD display indicates

that there is at least one call in the stack. The STAK indicator is automatically turned off when all pages in the stack have been erased.

The stack is arranged in FIFO order, that is, the first address that enters the stack is also the first that you see on the display. If the stack is full and a new call is received, the oldest call in the stack is automatically erased.

For convenience, addresses appearing in the stack can be easily added to the ALE address directory.

C-10. QUICK CALL

During a call, the radio saves the latest destination information as the **quick call** information. When the user presses the PTT of the microphone or handset twice in rapid sequence, the radio automatically directs the call to that address.

In the ALE mode, channel information is also retained and used for quick calls.

Intentionally Left Blank