

Thinking of you
Electrolux

instruction book
gebrauchsanweisung
instrucciones de uso
instruções de uso

freezer
gefrierschrank
congelatore
congelatore

EUF29400W, EUF29400X

We were thinking of you

when we made this product

Welcome to the world of Electrolux

Thank you for choosing a first class product from Electrolux, which hopefully will provide you with lots of pleasure in the future. The Electrolux ambition is to offer a wide variety of quality products that make your life more comfortable. You find some examples on the cover in this manual. Please take a few minutes to study this manual so that you can take advantage of the benefits of your new machine. We promise that it will provide a superior User Experience delivering Ease-of-Mind. Good luck!

The following symbols are used in this manual:



Important information concerning your personal safety and information on how to avoid damaging the appliance



General information and tips



Environmental information

Scrapping old cabinets



The symbol on the product or on its packaging indicates that this product may not be treated as household waste. Instead it shall be handed over to the applicable collection point for the recycling of electrical and electronic equipment. By ensuring this product is disposed of correctly, you will help prevent potential negative consequences for the environment and human health, which could otherwise be caused by inappropriate waste handling of this product. For more detailed information about recycling of this product, please contact your local city office, your household waste disposal service or the shop where you purchased the product.

Safety instructions

Your new freezer may have other functions compared to your previous one.

Carefully read these instructions to learn how the appliance works and how to care for it. Keep the instruction booklet. It will come in handy if you later sell the cabinet or give it to somebody else.

These warnings are provided in the interests of your safety. Ensure that you understand them all before installing or using the appliance. Your safety is of paramount importance. If you are unsure about any of the meanings or warnings contact the Customer Care Department.

For the User

- The cabinet is intended for keeping foodstuff in a normal household as explained in this instruction booklet.
- Do not keep explosive gases or liquids in the refrigerator or freezer compartment. They may explode and cause injury and material damage.
- Do not place food products directly against the air hole on the rear wall.
- Do not keep carbonised drinks or bottles in the freezer compartment. The glass bottles may break.
- The cabinet is heavy. The edges and projecting parts of the cabinet may be sharp. Be careful when moving the cabinet and always use gloves.

Child Safety

- Pay attention so that small children do not gain access to the operating controls or the inside of the cabinet.

Contents

Scrapping old cabinets	5	Saving energy	12
Safety instructions	5	Food Storage	12
USE	7	Protect the environment	12
BEFORE USE	7	MAINTENANCE and CLEANING ..	13
Control Panel	7	Removing the ventilation grille	13
DISPLAY	7	Cleaning	13
Functions Menu	8	To change the lamp	14
Select /Switch off /Switch on	8	When the appliance is not in use ..	14
Temperature selection	8	SOMETHING NOT WORKING	14
Switching off	8	Technical specification	17
Ambient Temperature Function	9	INSTALLATION	17
Child lock Function	9	Electrical cord	17
Eco mode Function	9	Unpacking	17
Freezing fresh food	9	Remove the transport supports ...	18
Chill Mode Function	10	Cleaning	18
Use of the freezer compartment ...	10	Installing the cabinet	18
Use of the freezer compartment ...	10	Door Reversal	20
Storage of frozen food	10	Electrical connection	21
Excessive temperature alarm	11	Guarantee/Customer Service	22
Door open acoustic alarm	11	EUROPEAN GUARANTEE	23
Cabinet interior	11	www.electrolux.com	24
HINT and TIPS	12		

USE

BEFORE USE

Position and clean the cabinet as explained in the section "Installation".



Before inserting the power plug into the outlet and switching on the cabinet for the first time, leave it standing upright for about 4 hours. Otherwise the compressor may sustain damage. This time will allow the oil sufficient time to return to the compressor.

Control Panel

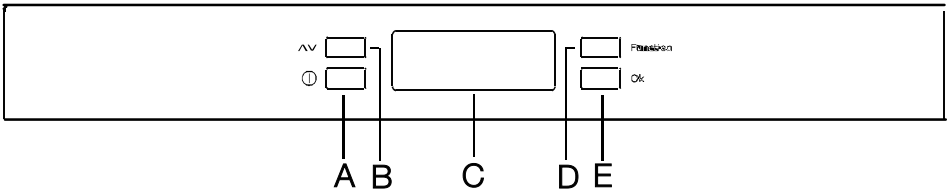

- A - Appliance button ON/OFF
- B - Temperature regulation button
- C - Temperature and function indicator

- D - Function button
- E - Confirmation button

DISPLAY





- Excessive temperature alarm and Door open acoustic alarm Indicator (if foreseen)
- If on the temperature indicated is the ambient temperature
- Positive or negative Temperature indicator
- Temperature indicator
- If on the function child lock is on
- If on the function timer is on
- If on the Chill mode function is on
- If on the fast freeze function is on
- If on the Eco mode function is on

First switch on

After plugging the plug into the power outlet, if the display is not illuminated, press key (A), appliance on.

As soon as the appliance is turned on, it is in alarm condition, the temperature flashes and you will hear a buzzer.

Press key (E) and the buzzer will go off (also see the section on "excessive temperature alarm") the icon  still flashes and on the indicator  will appear the warmest temperature reached.

For a correct storage of the food select the Eco mode function that guarantee the following temperature is set:

-18°C in the freezer

- Wait until the inside compartment temperature reach -18°C, before introducing the goods in the freezer compartment.
- To select a different temperature see "Temperature regulation".

Functions Menu

By activating the key D the functions menu is operating. Each function could be confirmed by pressing button E. If there is no confirmation after some seconds the display will go out from the menu and return in normal condition.

The following functions are indicated:

Ambient Temperature

Child lock function

Eco mode function

Fast freeze function

Chill mode function (or timer function)

Select /Switch off /Switch on

Temperature selection

The temperature may be regulated by pressing the key (B) to set the desired temperature.

By pressing the key (B) the current temperature setting flashes on the indicator. To confirm the choice of the temperature press the key (E).

You will hear the buzzer for few seconds and the indicator displays the newly selected temperature for a few seconds, then shows again the inside compartment temperature.

The newly selected-temperature must be reached after 24 hours.

After a long period out of use it is not necessary to set again the temperature because it remains stored.



Attention!

During the stability period by the first starting the temperature displayed can not correspond to the setting temperature. During this time it is possible that the temperature displayed is different than the setting temperature.

Switching off

The appliance is shut off by pressing key (A) for more than 1 second. After this, a countdown of the temperature from -3 -2 -1 will be shown.

Ambient Temperature Function

The ambient temperature function is activated by pressing key D (several times if necessary) until the corresponding icon appears .

In this condition the selected temperature is the ambient temperature. You must confirm the choice by pressing key E within few seconds. You will hear the buzzer and the icon remains lighted.

It is possible to de-activate the function at any time by pressing key D until the corresponding icon will flash and then key E.

Child lock Function

The child lock function is activated by pressing key D (several times if necessary) until the corresponding icon appears .

You must confirm the choice by pressing key E within few seconds. You will hear the buzzer and the icon remains lighted.

In this condition any possible operation through the keys does not cause any change as long as this function is activated.

It is possible to de-activate the function at any time by pressing key D until the corresponding icon will flash and then key E.

Eco mode Function

The Eco mode function is activated by pressing key D (several times if necessary) until the corresponding icon appears . You must confirm the choice by pressing key E within few

seconds. You will hear the buzzer and the icon remains lighted.

In this condition the chosen temperatures are automatically set (+ 5°C and - 18°C), in the best conditions for storing food.

It is possible to de-activate the function at any time by changing the selected temperature in one of the compartment.



Freezing fresh food

The freezer compartment is suitable for long term storage of commercially frozen and deep-frozen food, and for freezing fresh food.

The maximum quantity of foods to freeze in 24 hours is shown on the serial number plate.

Place the food directly in touch with the cooling surface (remove the drawer or basket).

In case the food is frozen inside the drawers or baskets, the maximum quantity is slightly reduced.

Place the food to be frozen in the  compartment, as this is the coldest point. To freeze fresh foods, you will need to activate the fast freeze function. Press key D (several times if necessary) until the corresponding icon appears .

You must confirm the choice by pressing key E within few seconds. You will hear the buzzer and on the display will appear some animation with lines.

After a pre-cooling period of 24 hours, place the foods in the freezer.

The freezing process takes 24 hours. During this period do not put other foods in the freezer.

This function stops automatically after 52 hours.



It is possible to de-activate the function at any time by pressing key D until the corresponding icon will flash and then key E.

Chill Mode Function

It is activated by pressing key D (several times if necessary) until the corresponding icon appears . You must confirm the choice by pressing key E within few seconds. You will hear the buzzer and the icon remains lighted.

In this condition it operates a timer with a default value of 30 min and it could change from 1 to 90 min, by pressing key B you select the minutes needed.

At the end of the selected time there are the following indications:

- on the indicator the symbol flashing ;
- the icon flashing ;
- the icon flashing ;
- sounding of an acoustic alarm until key E is pressed. **At this point bear in mind to remove the drinks contained in the freezer compartment.**

It is possible to de-activate the function at any time by pressing key D until the corresponding icon will flash and then key E.

Use of the freezer compartment

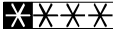
The freezer is provided with the symbol  which means that it is suitable for freezing fresh food and for long term storage of frozen and deep-frozen food.

Use of the freezer compartment

The temperature may be regulated between -15°C and -24°C.

We suggest setting the internal temperature of approximately -18°C, which guarantees proper freezing and conservation of the frozen foods.



Attention!

During the stability period by the first starting the temperature displayed can not correspond to the setting temperature. During this time it is possible that the temperature displayed is different than the setting temperature.



Attention!

Difference between the temperature displayed and temperature setting is normal. Especially when:

- a new setting has recently been selected
- the door has been left open for a long time
- warm food has been placed in the compartment.

Difference until 5°C inside the compartment are quite normal.

During normal functioning the indicator shows the warmest temperature inside the compartment.

Storage of frozen food

When first starting-up or after a period out of use, before putting the products in the compartment let the appliance run at least 12 hours. To obtain the best performance from this appliance, you should: if large quantities of food are to be stored, remove all drawers and baskets from appliance and place food on cooling shelves.

Pay careful attention not to exceed load limit stated on the side of the upper section  (where applicable).



Important

In the event of accidental defrosting, for example due to a power failure, if the power has been off for longer than the value shown in the technical characteristics chart under "rising time", the defrosted food must be consumed quickly or cooked immediately and then refrozen (after cooling).

Excessive temperature alarm

An increase in the temperature in the freezer compartment (for example due to a power failure) is indicated by:

- flashing temperature;
- flashing of the icon  ;
- sounding of buzzer.

When normal conditions are restored:

- the acoustic signal shuts off;
- the temperature value continues to flash;

When you press key "E" to de-activate the alarm, the highest temperature reached in the compartment appears on indicator for some seconds. Then it returns on the normal operation showing the temperature of the selected compartment.

During the alarm phase, the buzzer can be switched off by pressing key E.

Door open acoustic alarm

An acoustic alarm will sound when the door is left open for around 1,5 minutes. The door open alarm conditions are indicated by:

- flashing of the icon  ;
- sounding of buzzer.

Press the key (E) to stop the acoustic

alarm.

When normal conditions are restored (door closed):

- the acoustic alarm will stop.

Cabinet interior

Freezer drawers

The freezer drawers make that it easy to quickly and easily find the food package you want. In order to obtain maximum space, all fittings except the top door and the lower box can be removed and filled with groceries up to the indicated loading limit.

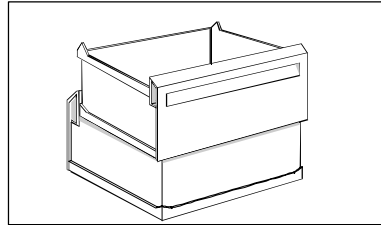

Ice cubes

Fill the ice tray to max. 3/4 since water expands as it freezes. Release the ice cubes by twisting the ice tray.

If ice cubes are kept for a long time, they will dry out and the taste is affected. Thus, throw away old ice cubes and prepare new ones when needed.

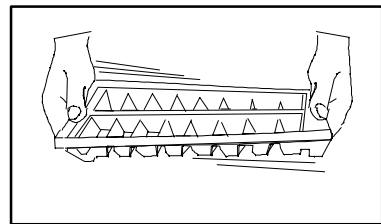

Removable shelves

There are the removable shelves inside the freezer. Remove the shelf when large food products need to be frozen.

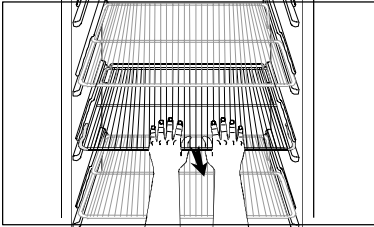

HINT and TIPS

Saving energy

- Pay careful attention to where the cabinet is placed. See the section "Installation". When installed correctly, the cabinet will consume less energy.
- Try to avoid keeping the door open for long periods, or opening the door too frequently as warm air will enter the cabinet, and cause the compressor to switch on unnecessarily often.
- Ensure there are no obstructions preventing the door from closing properly.
- Thaw frozen food in the fridge. This will ensure safer defrosting of foods and reduce the work of the refrigeration unit
- It is advisable to periodically clean the refrigeration system at the back of the appliance with a duster or vacuum cleaner.
- Food which is to be frozen (when cool) should be placed in the fridge before being transferred to the freezer.
- Avoid unnecessary frosting in the cabinet by packing all foodstuffs into airtight packages before placing them in the freezer.

- Carefully follow the advice on freezing products in the section "Using the freezer". This will prevent wasting energy.
- Do not set the temperature too low in the freezer. A suitable temperature is in the range of -18°C to -20°C .
- Make sure the door gasket is complete and always clean.

Food Storage

- To obtain the best results from your appliance, neither hot foods nor liquids which may evaporate, should be placed in the larder compartment.
- Avoid buying frozen food if you can not store it straight away. The use of an insulated container is advisable. When you arrive home place the frozen food in the freezer immediately.
- Ensure that food placed in the freezer is dated and labelled and used in date order to ensure that food is consumed at its best. Remove suspect food from you refrigerator and clean, refer to cleaning and maintenance.

Protect the environment

- Hand over the cabinet packaging and discarded fridges and freezers to a recycling station. Contact your local council or Environmental Health office for more information.
- Keep foodstuff in re-usable containers. Cut down on disposable material as much as possible.
- When cleaning the cabinet, use a mild washing-up detergent.
- Follow the advice in the section "Saving energy"
- The door gasket and coolant used in this cabinet will not harm the ozone

layer.

· All parts in the packaging can be recycled.

· The cabinet has been designed for easy dismantling and subsequent recycling.

MAINTENANCE and CLEANING

Removing the ventilation grille

The ventilation grille can be removed, e.g. to wash the grille.

Make sure the door is open when removing the ventilation grille. Unsnap the upper edge of the grille by pulling outward/downward. Then pull the grille straight out to completely remove it.

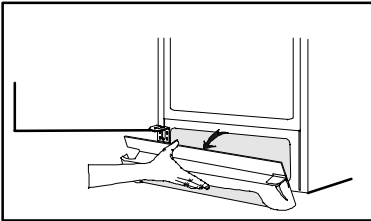

External Cleaning

Use water/neutral soap emulsion for cleaning the surface of stainless steel, anti-finger-print coated. Absolutely not to use abrasive paste.

Remove the ventilation grille (see the section "Removing the ventilation grille") and vacuum-clean under the cabinet. Once or twice a year dust the condenser (black grille) and the compressor at the back of the appliance, with a brush or vacuum cleaner, as an accumulation of dust will affect the performance of the appliance and cause excessive electricity consumption.

Cleaning

Clean the cabinet at regular intervals.

Internal Cleaning

Disconnect the appliance from electricity supply.

Clean the inside and accessories with warm water and bicarbonate of soda (5ml to 0,5 litre water) Rinse and dry thoroughly.

Regularly check the door seals and wipe clean to ensure they are clean and free from debris.

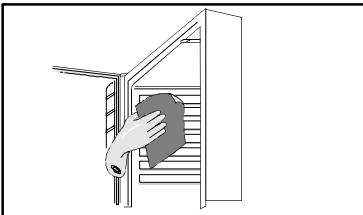
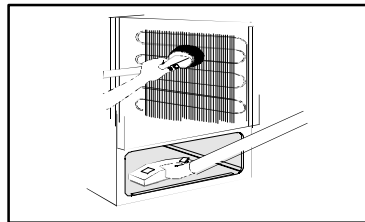

When moving the cabinet, lift it by the floor.

Defrosting

Defrosting is not necessary. Every 24 hours, the evaporator is defrosted automatically.



Never use a hair drier or other heating speed up defrosting. Excessive heat in plastic interior, and humidity could enter appliance making it live.

To change the lamp

Disassemble the lamp by using a screwdriver in the recess on the lamp insert.

Assemble a new lamp by guiding it into a centred position and press until it snaps.

Use a halogen bulb of the same type, maximum rating of 20 W.

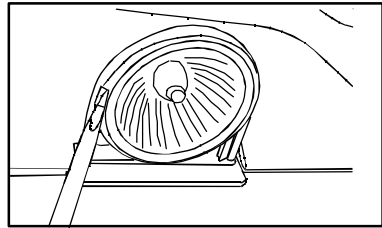

When the appliance is not in use Disconnect the appliance from electricity supply.

Empty all foods and clean the appliance, leaving the doors ajar to prevent unpleasant smells. If the cabinet will be kept on, ask somebody to check it once in a while to prevent the food inside from spoiling in case of a power failure.

SOMETHING NOT WORKING

Before contacting your local Service Force Centre check the following point:

Problem	Possible cause / Remedy
"□" is displayed in the temperature display.	Please contact your local Electrolux Service Force Centre
Audible alarm + flashing red warning lamp. (It is too warm inside the freezer.)	Switch off the audible alarm by pressing the alarm off button. The audible alarm could have been triggered by: The cabinet having been recently switched on and the temperature still being too high. See the chapter "Switching on and setting the temperature". The door may have been open for so long that the 'door open' alarm was triggered.

<p>It is too warm inside the freezer.</p>	<p>Set a lower temperature.</p> <p>Make sure that the door is completely closed and that the insulating strip is complete and clean.</p> <p>If warm food products have been put inside the freezer, wait for a couple of hours and then check the temperature again.</p> <p>Distribute the food products to allow cold air to circulate around them.</p>
<p>It is too cold inside the freezer.</p>	<p>Set a warmer temperature.</p> <p>Fast Freeze could have been switched on.</p> <p>The temperature display shows the highest temperature inside the cabinet. Thus a difference between the temperature indicated on the display and the (average) temperature measured in another way is normal.</p>
<p>Too much frost and ice are produced.</p>	<p>Make sure that the door is completely closed and that the insulating strip is complete and clean.</p>
<p>The compressor operates continuously.</p>	<p>Set a warmer temperature.</p> <p>Make sure that the door is completely closed and that the insulating strip is complete and clean.</p> <p>The temperature where the cabinet is placed is above normal room temperature.</p>
<p>The cabinet does not operate at all. Cooling or interior light does not operate. No indicator lamps light.</p>	<p>The cabinet is not switched on.</p> <p>Power does not reach the cabinet. (Try connecting another electrical device to the power outlet.)</p> <p>The fuse has blown.</p> <p>The power plug is not properly connected.</p>

<p>Sound level in cabinet is too high.</p>	<p>The refrigerating system will always produce some sounds. A pulsing sound is heard when coolant is pumped inside the cooling pipes. A ticking sound from the thermostat can be heard when the compressor switches on and off. The sound level varies depending on the operation of the cabinet.</p> <p>If you feel the sound level is incorrect:</p> <p>Make sure the pipes at the back of the cabinet not touch each other. Carefully bend them if they do.</p> <p>If the cushion spacers (between the cabinet wall and pipes) come loose, put them back in place again.</p> <p>Carefully follow the instructions in the chapter "Installing the cabinet".</p>
<p>Power failure</p>	<p>Do not unnecessarily open the cabinet, except when the power cut seems to be long, in which case the food products should be moved to another cabinet that works. If the frozen products are still hard following the power cut, they may be immediately refrozen. If the food products have thawed but are still fresh, they may be used, however they should be prepared before re-freezing or eating them.</p>

Technical specification

Model	EUF29400W / EUF29400X
Net capacity Freezer l	267
Energy consumption kWh/y	334
Freezing capacity 24 hours	20
Rising time h	10
Dimension mm	
Height	1800
Width	595
Depth	623

INSTALLATION

Electrical cord

Do not remove the power cord by pulling on its lead, particularly when the product is being pulled out of its niche.

- Damage to the cord may cause a short-circuit, fire and/or electric shock.
- In the event of damage to the appliance's main cable, only an authorised service company recommended by the manufacturer or a similarly qualified person may adjust it in order to avoid shock hazard for the user.

Unpacking

Unpack the cabinet and check that it is in good condition and free of any transport damage. Notify the dealer immediately of any damage. Hand the

packaging over for recycling. For more information, contact your local city office or the dealer.



Do not allow children to play with the packaging. The plastic film can cause suffocation.

Remove the transport supports

Remove the transport supports placed along the door sides.

Some models are fitted with a silencing pad under the cabinet. Do not remove this pad.

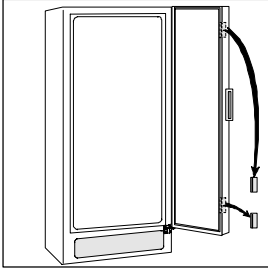

Cleaning

Wash the inside of the cabinet using lukewarm water, a mild washing-up detergent and a soft cloth.

Installation of distance

Assemble the attached distance on the back side of the panel according to the illustration.

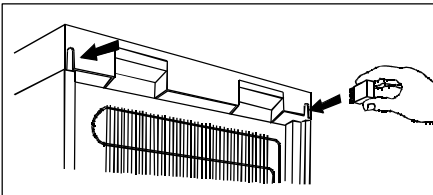

Installing the cabinet

When two appliances are placed beside each other, the distances enclosed in the plastic wrapping should be glued between the appliances. As shown in the illustration.

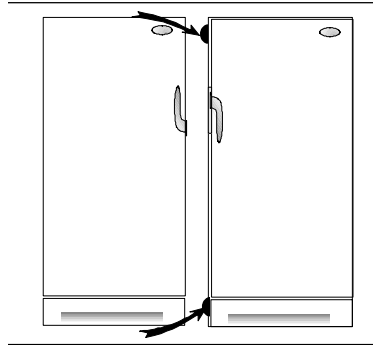

Make sure that the power plug is not squashed or damaged by back of the product.

- A damaged power plug may overheat and cause a fire.

Do not place heavy articles or the product itself on the power cord.

- there is a risk of a short circuit and fire.

If the power plug socket is loose, do not insert the power plug.

- there is a risk of electric shock or fire.

To obtain the best performance from the cabinet, ensure:

- the cabinet is placed in a dry, cool place and is not exposed to direct sunlight.
- the cabinet is not placed close to a source of heat, e.g. a cooker or dishwasher.
- the cabinet is level. The cabinet should not lean against any wall. If necessary adjust the feet using the adjustment spanner supplied.

· there is good air circulation around the cabinet and that the air channels below and behind the cabinet are not blocked. The ventilation space above the cabinet must be at least 4 cm.

The ventilation space can either be

- a) directly above the cabinet, or
 - b) behind and above the top cupboard.
- In this case, the space behind the cupboard must be at least 50 mm deep.

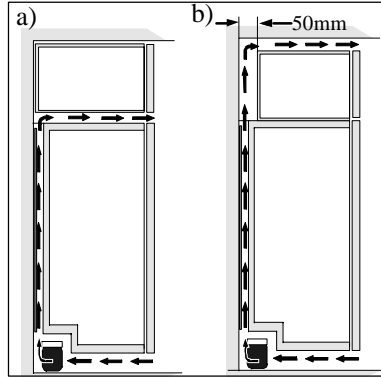

Cabinet is placed at a location whose ambient temperature corresponds to the climate classification*, for which the appliance is designed.

* See on the rating plate on the inside of the appliance.

The following table shows which ambient temperature is correct for each climate classification.

Climate classification	for an ambient temperature of
SN	+10°C to +32°C
N	+16°C to +32°C
ST	+18°C to +38°C
T	+18°C to +43°C

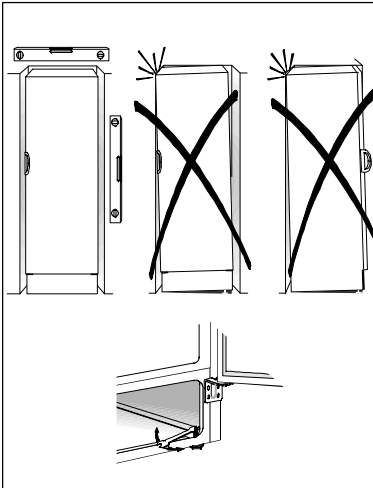

If the cabinet is placed in a corner and the side with the hinges facing the wall, the distance between the wall and the cabinet must be at least 150 mm to allow the door to open enough so that the baskets can be removed. The power plug must be accessible after installation of the cabinet.

Door Reversal

1. Close the cabinet and remove the plug from the electrical socket.
2. Remove the ventilation grille. There is a part on the grille that can be removed. Remove and reposition it on the other side.
3. Put the cabinet on a wooden board when it is laid down. Later, when raising the cabinet, it will be easier to grip under the cabinet thanks to the board.
4. Unscrew the three screws on the backside of the front cover
Remove the front cover

Unscrew the hinge pin

Remove the door

5. Unscrew the door stopper screw

Remove the door stopper

6. Remove the two cover lids on the roof

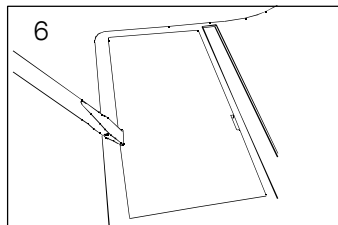
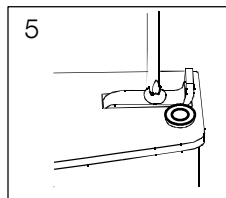
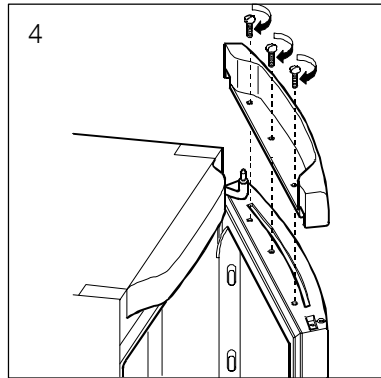
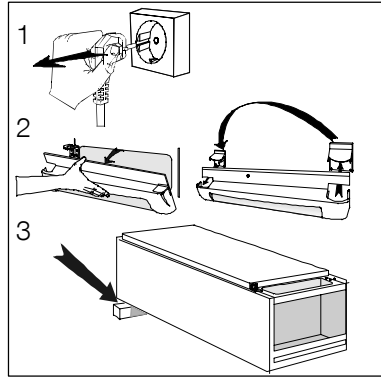

7. Unscrew the two screws on the hinge

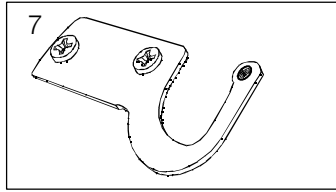

8. Remove the cover on the front

Reassembly in reverse order on the opposite side.

Raise the cabinet and replace the ventilation grille.

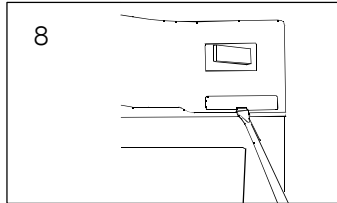

9. To transfer the handle.

Unscrew the screws. Fit the handle onto the opposite side by turning it one half circle. Press the supplied plastic plugs into the holes to which the handle was previously fitted.

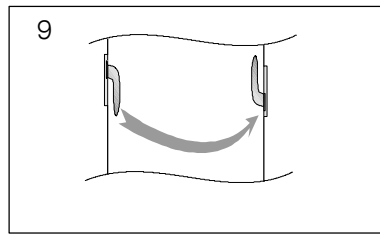

Put the cabinet in position. Check that the appliance is level. See the section "Positioning the cabinet".

Electrical connection

Connect the cabinet to a grounded electrical outlet.

Voltage: 230 V.

Fuse: 10 A.

Refer to the rating plate on the left inside the cabinet.

Guarantee/Customer Service

Standard guarantee conditions

We, Electrolux, undertake that if within 12 months of the date of the purchase this Electrolux appliance or any part thereof is proved to be defective by reason only of faulty workmanship or materials, we will, at our option repair or replace the same FREE OF CHARGE for labour, materials or carriage on condition that:

- The appliance has been correctly installed and used only on the electricity supply stated on the rating plate.
- The appliance has been used for normal domestic purposes only, and in accordance with the manufacturer's instructions.
- The appliance has not been serviced, maintained, repaired, taken apart or tampered with by any person not authorised by us.
- Electrolux Service Force Centre must undertake all service work under this guarantee
- Any appliance or defective part replaced shall become the Company's property.
- This guarantee is in addition to your statutory and other legal rights.

Exclusions

- Damage or calls resulting from transportation, improper use or neglect, the replacement of any light bulbs or removable parts of glass or plastic.
- Costs incurred for calls to put right an appliance which is improperly installed or calls to appliances outside the United Kingdom.
- Appliances found to be in use within a commercial environment, plus those which are subject to rental agreements.

- Products of Electrolux manufacturer that are not marketed by Electrolux

Service and Spare Parts

In the event of your appliance requiring service, or if you wish to purchase spare parts, please contact your local Service Force Centre by telephoning

0870 5 929 929

Your telephone call will be automatically routed to the Service Force Centre covering your postcode area.

For the address of your local Service Force Centre and further information about Service Force, please visit the website at

www.serviceforce.co.uk

Before calling out an engineer, please ensure you have read the details under the heading "Something not working" When you contact the Service Force Centre you will need to give the following details:

1. Your name, address and postcode.
2. Your telephone number.
3. Clear concise details of the fault.
4. The model and Serial number of the appliance (found on the rating plate).
5. The purchase date.

Please note a valid purchase receipt or guarantee documentation is required for in guarantee service calls.

Customer Care

For general enquiries concerning your Electrolux appliance, or for further information on Electrolux products please contact our Customer Care Department by letter or telephone at the address below or visit our website at www.electrolux.co.uk

Customer Care Department
Electrolux Major Appliances
Addington Way
Luton

Bedfordshire, LU4 9QQ

Tel: 08705 950 950 (*)

(*) Calls may be recorded for training purposes



European Guarantee

This appliance is guaranteed by Electrolux in each of the countries listed at the back of this user manual, for the period specified in the appliance guarantee or otherwise by law. If you move from one of these countries to another of the countries listed below the appliance guarantee will move with you subject to the following qualifications:-

- The appliance guarantee starts from the date you first purchased the appliance which will be evidenced by production of a valid purchase document issued by the seller of the appliance.
- The appliance guarantee is for the same period and to the same extent for labour and parts as exists in your new country of residence for this particular model or range of appliances.
- The appliance guarantee is personal to the original purchaser of the appliance and cannot be transferred to another user.
- The appliance is installed and used in accordance with instructions issued by Electrolux and is only used within the home, i.e. is not used for commercial purposes.
- The appliance is installed in accordance with all relevant regulations in force within your new country of residence.

The provisions of this European Guarantee do not affect any of the rights granted to you by law.

www.electrolux.com

		
Albania	+35 5 4 261 450	Rr. Pjeter Bogdani Nr. 7 Tirane
Belgique/België/ Belgien	+32 2 363 04 44	Bergensesteenweg 719, 1502 Lembeek
Česká republika	+420 2 61 12 61 12	Budějovická 3, Praha 4, 140 21
Danmark	+45 70 11 74 00	Sjællandsgade 2, 7000 Fredericia
Deutschland	+49 180 32 26 622	Muggenhofer Str. 135, 90429 Nürnberg
Eesti	+37 2 66 50 030	Mustamäe tee 24, 10621 Tallinn
España	+34 902 11 63 88	Carretera M-300, Km. 29,900 Alcalá de Henares Madrid
France	www.electrolux.fr	

		
Great Britain	+44 8705 929 929	Addington Way, Luton, Bedfordshire LU4 9QQ
Hellas	+30 23 10 56 19 70	4 Limnou Str., 54627 Thessaloniki
Hrvatska	+385 1 63 23 338	Slavonska avenija 3, 10000 Zagreb
Ireland	+353 1 40 90 753	Long Mile Road Dublin 12
Italia	+39 (0) 434 558500	C.so Lino Zanussi, 26 - 33080 Porcia (PN)
Latvija	+37 17 84 59 34	Kr. Barona iela 130/2, LV-1012, Riga
Lietuva	+370 5 2780609	Verkių 29, LT-09108 Vilnius
Luxembourg	+35 2 42 43 13 01	Rue de Bitbourg, 7, L-1273 Hamm
Magyarország	+36 1 252 1773	H-1142 Budapest XIV, Erzsébet királyné útja 87
Nederland	+31 17 24 68 300	Vennootsweg 1, 2404 CG - Alphen aan den Rijn
Norge	+47 81 5 30 222	Risløkkvn. 2 , 0508 Oslo
Österreich	+43 18 66 400	Herziggasse 9, 1230 Wien
Polska	+48 22 43 47 300	ul. Kolejowa 5/7, Warsaw
Portugal	+35 12 14 40 39 39	Quinta da Fonte - Edifício Gonçalves Zarco - Q 35 2774 - 518 Paço de Arcos
Romania	+40 21 451 20 30	Str. Garii Progresului 2, S4, 040671 RO
Schweiz/Suisse/ Svizzera	+41 62 88 99 111	Industriestrasse 10, CH-5506 Mägenwil
Slovenija	+38 61 24 25 731	Electrolux Ljubljana, d.o.o. Tržaška 132, 1000 Ljubljana
Slovensko	+421 2 43 33 43 22	Electrolux Slovakia s.r.o., Electrolux Domáce spotrebiče SK, Seberínho 1, 821 03 Bratislava
Suomi	+35 8 26 22 33 00	Konepajaranta 4, 28100 Pori
Sverige	+46 (0)771 76 76 76	Electrolux Service, S:t Göransgatan 143, S-105 45 Stockholm
Türkiye	+90 21 22 93 10 25	Tarlabaşı caddesi no : 35 Taksim Istanbul
Россия	+7 495 9377837	129090 Москва, Олимпийский проспект, 16, БЦ „Олимпик“

www.electrolux.com

www.electrolux.uk

www.electrolux.de

www.electrolux.es

www.electrolux.pt