

# **ESTEEM TUNING PROCEDURE**

for

## **MODEL 192M**

**Firmware Versions 1.36 and above.**

**March 1998**

**Confidential**

*This manual and the firmware described in it are copyrighted by EST, with all rights reserved. Under the copyright laws, this manual or the firmware internal to the ESTeem unit may not be copied, in whole or part, without the written consent of EST. Under the law, copying includes translating into another language.*

*Electronic Systems Technology (EST) cannot guarantee that you will receive notice of a revision to the firmware described in the manual, even if you have returned a registration/warranty card received with the product. You should periodically check with your authorized EST dealer or call factory direct.*

*EST and the EST logo are registered trademarks of Electronic Systems Technology, Inc. Simultaneously published in the United States and Canada. All rights reserved.*

# PRODUCT WARRANTY

Electronic Systems Technology, Inc., (hereinafter EST) expressly warrants its products as free of manufacturing defects for a period of one year from the date of sale to first user/customer.

***THERE ARE NO OTHER WARRANTIES, EXPRESS OR IMPLIED AND THERE IS EXPRESSLY EXCLUDED ALL WARRANTIES OF MERCHANTABILITY OR FITNESS FOR A PARTICULAR PURPOSE. NO OTHER WARRANTY GIVEN BY ANY EMPLOYEE, AGENT, DISTRIBUTOR OR OTHER PERSON WITH RESPECT TO THE PRODUCT SHALL BE BINDING ON EST.***

## LIMITATION OF LIABILITY:

EST's liability shall be limited to refunding of purchase price, repair or replacement of product.

***IN NO EVENT SHALL EST HAVE LIABILITY FOR CONSEQUENTIAL, INCIDENTAL, SPECIAL OR EXEMPLARY DAMAGES CAUSED DIRECTLY OR INDIRECTLY BY THE PRODUCT, INCLUDING BUT NOT LIMITED TO ANY INTERRUPTION OF SERVICES, LOSS OF BUSINESS OR ANTICIPATORY PROFITS. IN NO EVENT SHALL EST BE LIABLE FOR ANY DAMAGES WHATSOEVER IN EXCESS OF THE PURCHASE PRICE OF THE PRODUCT.***

In the event that a unit or part requires replacement or factory servicing, the following conditions apply:

- a) Customer must obtain from EST an authorized RMA (Return Materials Authorization) Number before shipment of product or parts to EST for any reason;
- b) If the whole unit is shipped, it must be in its original carton and shipping components, or a carton and shipping components supplied by EST, or if parts only are shipped, they must be packaged and cushioned so as to prevent damage in transit and shipped freight prepaid;

## PRODUCT WILL BE CONSIDERED OUT OF WARRANTY IF:

- a) If the product is damaged due to improper or abnormal use, abuse, mishandling, accident or improper maintenance or failure to follow operating instruction;
- b) If the product is defective as a result of sand, dirt, or water damage;
- c) If any factory-sealed enclosure has been opened or shows evidence of an attempt to be opened;
- d) If defects or damage are caused by the use of unauthorized parts or unauthorized service;
- e) If the product has had its serial numbers altered or removed.

Warranty repair form must be accompanied by proof of user's purchase of unit. Product must be shipped to the manufacturer at the following address:

Electronic Systems Technology  
415 North Quay Street  
Kennewick, Washington USA 99336

## ADDITIONAL SERVICE:

If EST releases an improvement update to firmware internal to the ESTeem unit during the 90 day period after the unit was purchased by the first user/customer, EST will update the applicable unit with the revised version at no charge other than for UPS handling and shipping to and from your location to the EST factory. Return of any such item must be accompanied with proof of purchase.

**ESTEEM**

<b>1.0</b>	<b>ALIGNMENT OF SERIES 100 PORTION TRANSCEIVER .....</b>	<b>1</b>
<b>2.0</b>	<b>ALIGNMENT OF SERIES 200 PORTION TRANSCEIVER .....</b>	<b>1</b>
<b>3.0</b>	<b>ALIGNMENT OF SERIES 300 PORTION TRANSCEIVER .....</b>	<b>1</b>
<b>4.0</b>	<b>ALIGNMENT OF SERIES 400 PORTION TRANSCEIVER .....</b>	<b>2</b>
<b>5.0</b>	<b>ALIGNMENT OF SERIES 600 PORTION TRANSCEIVER .....</b>	<b>2</b>
<b>6.0</b>	<b>ALIGNMENT OF SERIES 500 PORTION TRANSCEIVER (Transmitter Section) .....</b>	<b>3</b>
<b>7.0</b>	<b>ALIGNMENT OF SERIES 600 PORTION TRANSCEIVER (Receiver Section) .....</b>	<b>3</b>
<b>8.0</b>	<b>FINAL ALIGNMENT .....</b>	<b>3</b>

**APPENDIX A - RECOMMENDED TEST EQUIPMENT**

**APPENDIX B - MODEL 192M TX/RX SPECIFICATIONS**

**APPENDIX C - MODEL 192M RS-232C/422/485 CONFIGURATION TABLE**

**APPENDIX D - SPECIAL HARDWARE SCHEMATIC DIAGRAMS**

**APPENDIX E - MODEL 192M TEST CONFIGURATIONS**

**ATTACHMENTS**

**MODEL 192 TX/RX ASSEMBLY DRAWING - B00407 Sheets 1 & 2**

**MODEL 192M PRODUCT ACCEPTANCE PROCEDURE**

**ALIGNMENT OF SERIES 100 PORTION  
TRANSCEIVER.**

**Function:** *Master synthesizer (258 MHz +/- 10 MHz, 50 kHz steps).*

- 1.1 Connect the CPU board to the transceiver using a 18 pin test cable.
- 1.2 Power up the unit and let warm up.
- 1.3 Make sure the frequency is set to 162.000 MHz (master synthesizer frequency of 258 MHz).
- 1.4 Sniff the master oscillator on a spectrum analyzer (258 MHz @ 100 MHz span).
- 1.5 Adjust C108 for an output frequency of 258 MHz.

*You should see the oscillator "snap" on to the approximate frequency.*

- 1.6 Monitor loop stress test point (junction. L101/C105/C106/...) and adjust C108 for a stress voltage of 4 volts.
- 1.7 Span down the spectrum analyzer to 100 kHz span.
- 1.8 The spectrum should look pretty good.
- 1.9 Adjust C139 to put the loop on frequency.

*If frequency can not be "put on" change C141 to a value which will put the loop on frequency with in the adjustment range of C139.*

- 1.10 Tack on the shield over the master oscillator and repeat above steps.
- 1.11 Bottom line:

- *The master loop is functioning.*
- *The 6.000 MHz reference crystal is on frequency.*

**ALIGNMENT OF SERIES 200 PORTION  
TRANSCEIVER.**

**Function:** *Fine synthesizer (120 MHz +/- 1 MHz, 100/125 kHz steps).*

- 2.1 Sniff the fine oscillator on a spectrum analyzer (120 MHz @ 20 MHz span).
- 2.2 Adjust L202 for an output frequency of 120 MHz.  
  
*You should see the oscillator "snap" on to the approximate frequency.*
- 2.3 Monitor loop stress test point (junction. L201/C205/C206/...) and adjust L202 for a stress voltage of 4 volts.
- 2.4 Span down the spectrum analyzer to 10 kHz span.
- 2.5 The spectrum should look pretty good and be on frequency (<100 Hz error).
- 2.6 Tack on a shield at two places.
- 2.7 Bottom line:
  - *The Fine loop is functioning.*

**ALIGNMENT OF SERIES 300 PORTION  
TRANSCEIVER.**

**Function:** *Slave synthesizer (252 MHz +/- 10 MHz, 50 kHz steps).*

- 3.1 Sniff the master oscillator on a spectrum analyzer (252 MHz @ 100 MHz span).
- 3.2 Adjust C308 for an output frequency of 252 MHz.  
  
*The oscillator "snap" may be very hard to see so do not try to look for it.*
- 3.3 Monitor loop stress at the output of U06 (pin 06) and adjust C308 for a stress voltage of 4 volts. This adjustment is very touchy so be careful.
- 3.4 Span down the spectrum analyzer to 100 kHz span.
- 3.5 The spectrum should look pretty good.
- 3.6 Readjust, if necessary, C139 to put the loop on frequency (252.000 MHz +/- 250 Hz).
- 3.7 Tack on the shield over the slave oscillator and repeat above steps.

**Confidential****MODEL 192M TUNING PROCEDURE**

3.8 You will have to readjust C308 to compensate for the cover. This is done by looking across R301 on the other side of the board. Readjust C308, very carefully, for zero (0) volts +/- .025 volts across R301. See back panel

3.9 Bottom line:

- *The slave loop is functioning.*
- *The 6.000 MHz reference crystal has been checked and is on frequency.*
- *The preliminary first LO alignment has been completed.*

**ALIGNMENT OF SERIES 400 PORTION TRANSCEIVER.**

**Function:** *Modulator/exciter analogue mode (90 MHz +/- 5 kHz).*

- 4.1 Set the transceiver to transmit mode using the RADIO ON command.
- 4.2 Sniff the exciter oscillator on a spectrum analyzer (90 MHz @ 20 MHz span).
- 4.3 Adjust L402 for an output frequency of 90 MHz.  
*You should see the oscillator "snap" on to the approximate frequency.*
- 4.4 Monitor loop stress test point (junction, L401/C405/C406/...) and adjust L402 for a stress voltage of 4 volts.
- 4.5 Span down the spectrum analyzer to 20 kHz span.
- 4.6 The spectrum should look pretty good and be on frequency (<100 Hz error)..
- 4.7 Bottom line:
  - *The modulation loop is functioning.*
  - *Preliminary frequency setting has been accomplished.*

**ALIGNMENT OF SERIES 600 PORTION TRANSCEIVER.**

**Function:** *Final receiver section.*

- 5.1 Set the transceiver back to receive mode.
- 5.2 Sniff the exciter oscillator on a spectrum analyzer (90 MHz @ 20 MHz span).
- 5.3 Set the spectrum analyzer to 89.545 MHz with a span of 10 kHz.
- 5.4 Check and see if the crystal oscillator is working, adjust C626 to put LO on frequency.
- 5.5 Tack a coax cable to the junction of C601 and R601 and connect to a signal generator and set generator to 90 MHz at a level of approximately -30 dBm, Set generator modulation to FM 1 kHz at a deviation of 5 kHz.
- 5.6 Install test points at the following places:
  - 1) Pin 7 of U603 (Data)
  - 2) Pin 7 of U602 (RSSI Level)
- 5.7 Look at the levels on TP#1 with a scope and look at the signal (it should be clean 1 kHz sine wave).
- 5.8 Drop the signal level down to the point where the signal is noisy.
- 5.9 Adjust L602 for maximum RSSI DC level on TP#3.
- 5.10 Receiver IF sens. should be lower than 2 uV for a little noisy 1 kHz sine wave on TP#1.
- 5.11 Raise sig. gen. level to -60 dBm and check the voltage between U602 p-8 and U602 p-9.
- 5.12 This voltage should be less than 15 mV. Adjust the sig. gen. a kHz or two to zero this voltage level. If this level can be set to <15 mV then retune gen. back to 90 MHz and adjust C626 to zero this voltage.
- 5.13 Remove the coax cable.

## 5.14 Bottom line:

- *The receiver sub-section is operating.*
- *Demonstrated IF send. Of less than 2 uV (1 uV typical).*

### ALIGNMENT OF SERIES 500 PORTION TRANSCEIVER (Transmitter Section).

**Function:** *Generate a modulated 0 dBm signal to drive the Motorola Brick.*

- 6.1 Set the transceiver to transmit mode.
- 6.2 Connect a coax cable to the input line of the Motorola Power amp module and connect to the spectrum analyzer.
- 6.3 Set the spectrum analyzer to 162 MHz at a span of 20 MHz, you should see a signal at a level of greater than -50 dBm.
- 6.4 Adjust C541, C546, C550 and C522, C517, C513 carefully for maximum power at the connector (level should be 0 dBm -2/+1 dBm). You may want to scale the analyzer to 1 dB/vert div.
- 6.5 Do the above steps once more.
- 6.6 Bottom line:

- *RF level is at correct level and frequency.*

### ALIGNMENT OF SERIES 600 PORTION TRANSCEIVER (Receiver Section).

**Function:** *Align the receiver portion of 600 section.*

- 7.1 Set the transceiver to receive mode.
- 7.2 Connect signal generator to input of transceiver and set to 162 MHz, -60 dBm and FM modulate at 1 kHz @ 5 kHz deviation.
- 7.3 Monitor pin 7 of U603 (analog data out) on the scope and pin 7 of U602 (RSSI).
- 7.4 Adjust signal generator level to produce a slightly noisy sine wave on the scope.

7.5 Adjust C803, C807 & L502 for maximum RSSI level.

7.6 Reduce generator level to reestablish a noisy sine wave on scope again. The generator level should be below .7 uV.

7.7 Bottom line:

- *Receiver front end/mixer and filters are now aligned.*

### FINAL ALIGNMENT.

- 8.1 With the RADIO ON command enabled adjust the transmitted modulation to 4 kHz using R446.
- 8.2 Verify the transmitted output power.
- 8.3 Verify transmitted frequency is 162 MHz  $\pm$ 200 Hz.
- 8.4 Put the transceiver in receive mode. Supply a -90 dBm modulated 1 kHz signal to the antenna input. Monitor U16 pin 23 on the CPU and adjust R39 for a DC offset of 2.5 VDC with a receive signal of -90 dBm.
- 8.5 Adjust receiver squelch. Set squelch to 0 and adjust R639 to -101 dBm.

**Confidential****APPENDIX A  
RECOMMENDED TEST EQUIPMENT**

---

1. RF Signal Generator, HP 8565B or equivalent.
2. DC Voltmeter, Fluke 77 or equivalent.
3. Oscilloscope, 100 MHz, Tektronics 2465 or equivalent.
4. Frequency Counter, 1 GHz, Beckman FC130A or equivalent.
5. pin Interconnection Ribbon Cable, Reference Appendix D, Special Hardware Schematic Diagrams.
6. RF Power Meter, Bird 43 or equivalent.
7. Attenuator, Fixed, 20 dB, Alan 50HP20-10 or equivalent.
8. Attenuator, Adjustable, 1 to 102 dB, Alan 50TA102 or equivalent.
9. Spectrum Analyzer, HP 8568B or equivalent.
10. Reference ESTeem, Model 192M.
11. IBM compatible computer, 386 or equivalent.
12. ESTeem Production Test Software Program.
13. Power Supply, EST p/n AA174 or equivalent.

**APPENDIX B**  
**MODEL 192 C TX/RX SPECIFICATIONS**

---

**Transmitter**

Frequency Range: 150 to 174 MHz  
Channel Spacing: 12.5 KHz  
Number of Channels: 1920  
Frequency Stability: +/- 2.5 ppm  
RF Power Output: 2 W or 4 W (optional)  
Duty Cycle: 100%  
RF Output Impedance: 50 ohms  
RF Output Connector: TNC female  
Spurious & Harmonics: > 58 dB  
Transmit Rise Time: 1 ms  
Modulation: 4 Level FSK  
Data Rate: 9,600 bps  
Deviation: 3 KHz  
Occupied BW: < 12.5 KHz

**Receiver**

Frequency Range: 150 to 174 MHz  
Channel Spacing: 12.5 KHz  
Number of Channels: 1920  
Frequency Stability: +/- 5 ppm  
Sensitivity: < 2 uv  
Spurious & Image Rejection: > 50 dB  
Squelch Adjustment: 4 Levels - Software adjustable  
Adjacent Channel Rejection: > 70 dB  
T/R Switch; Solid state - internal to unit

**General**

Input Voltage: 11 to 15 VDC  
Input Current: 750 ma (receive)  
                  1.6 A (transmit - 2W)  
                  2 A (transmit - 4W)  
Temperature Range: -30° to +50° C.  
                  95% Non-condensing  
Size: 2 ¼ in. H x 5 ¼ in. W x 10 ¼ in. L  
Weight: 3.2 lbs.



**Confidential****APPENDIX C****MODEL 192M RS-232C/422/485 CONFIGURATION TABLES****RS-232C/422/485 Configuration Tables**

On the rear end plate of the ESTeem is an eight position switch labeled RS-232 Setup. The switch positions are defined as follows:

**RS-232C/422/485 Configuration Table**

Switch	1	2	3	Baud
	OFF	OFF	OFF	19,200
	ON	OFF	OFF	9,600
	OFF	ON	OFF	4,800
	ON	ON	OFF	2,400
	OFF	OFF	ON	1,200
	ON	OFF	ON	600
	OFF	ON	ON	300

**ESTeem RS-232C/422/485  
Port Pin-Out Table**

Pin No.	Function
1	Shield Ground
2	Transmit Data (TxD)
3	Receive Data (RxD)
4	Request To Send (RTS Input)
5	Clear To Send (CTS)
6	Data Set Ready (DSR)
7	Signal Ground
8	Data Carrier Detect (DCD)
19	Mode Control
20	Data Terminal Ready (DTR)
22	Ring Indicator (RI)
12	Request To Send (RTS Output)
9	RS-422/485 Transmit Data (-)
10	RS-422/485 Transmit Data (+)
14	RS-422/485 Receive Data (+)
16	RS-422/485 Receive Data (-)

**RS-232C/422/485 Parity/Stop Bit Configuration Table**

Switch	4	5	6	7	Data Format
	OFF	OFF	OFF	OFF	7 bit data + No parity + 1 stop
	ON	OFF	OFF	OFF	7 bit data + No parity + 2 stop
	OFF	ON	OFF	ON	7 bit data + Odd parity + 1 stop
	ON	ON	OFF	ON	7 bit data + Odd parity + 2 stop
	OFF	ON	OFF	OFF	7 bit data + Even parity + 1 stop
	ON	ON	OFF	OFF	7 bit data + Even parity + 2 stop
	OFF	OFF	ON	OFF	8 bit data + No parity + 1 stop
	ON	OFF	ON	OFF	8 bit data + No parity + 2 stop
	OFF	ON	ON	ON	8 bit data + Odd parity + 1 stop
	ON	ON	ON	ON	8 bit data + Odd parity + 2 stop
	OFF	ON	ON	OFF	8 bit data + Even parity + 1 stop
	ON	ON	ON	OFF	8 bit data + Even parity + 2 stop

SPECIAL HARDWARE SCHEMATIC DIAGRAMS

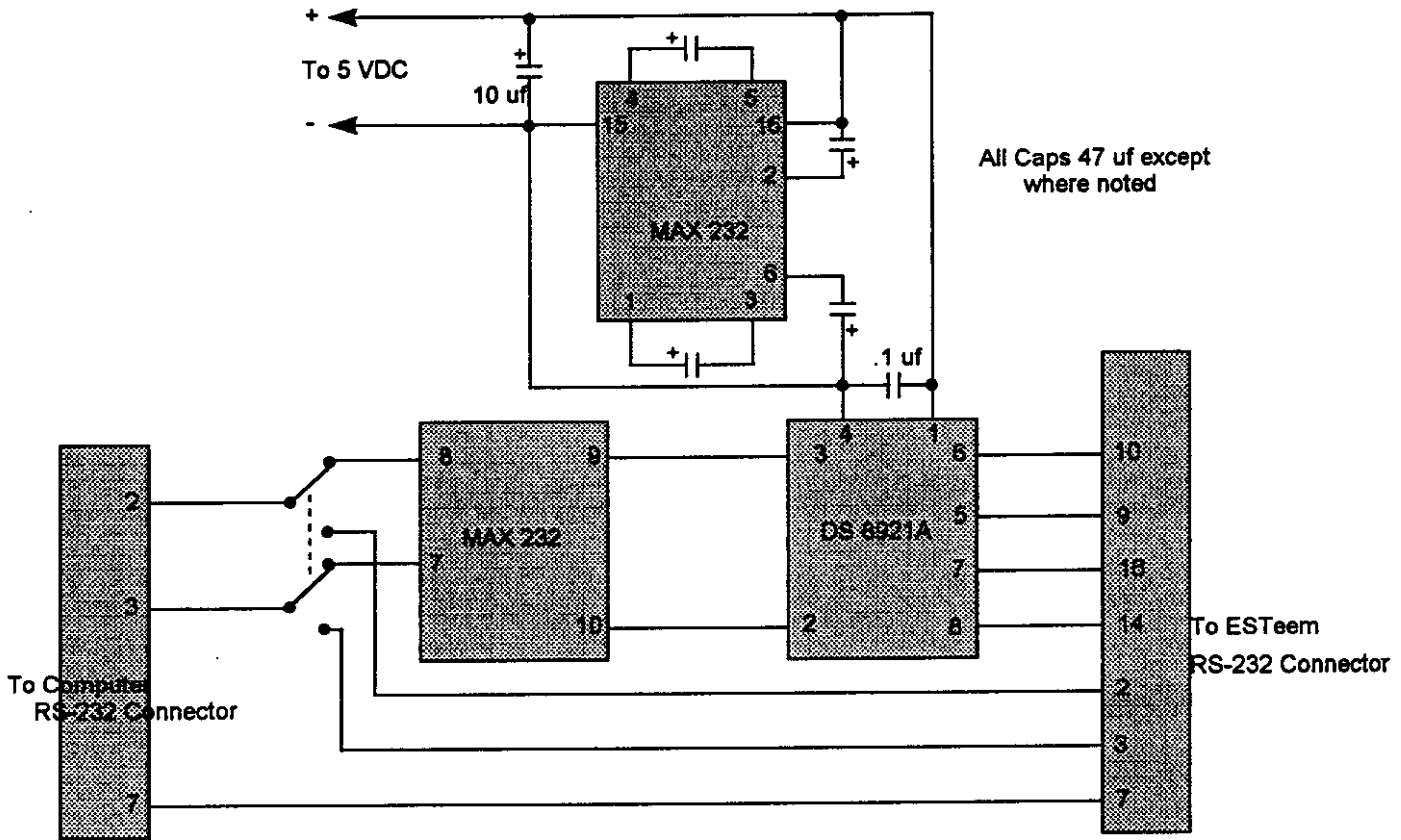

RS-232/422 Test Module Schematic

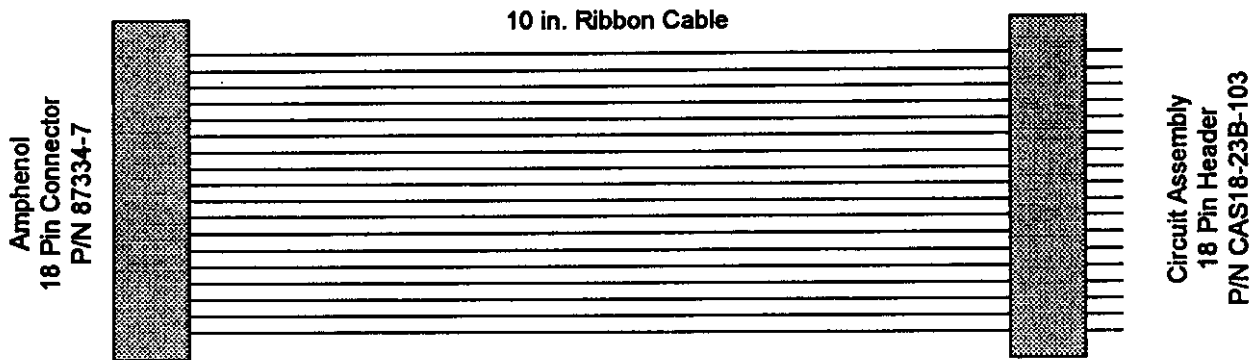

Model 192 Interconnection Cable Schematic

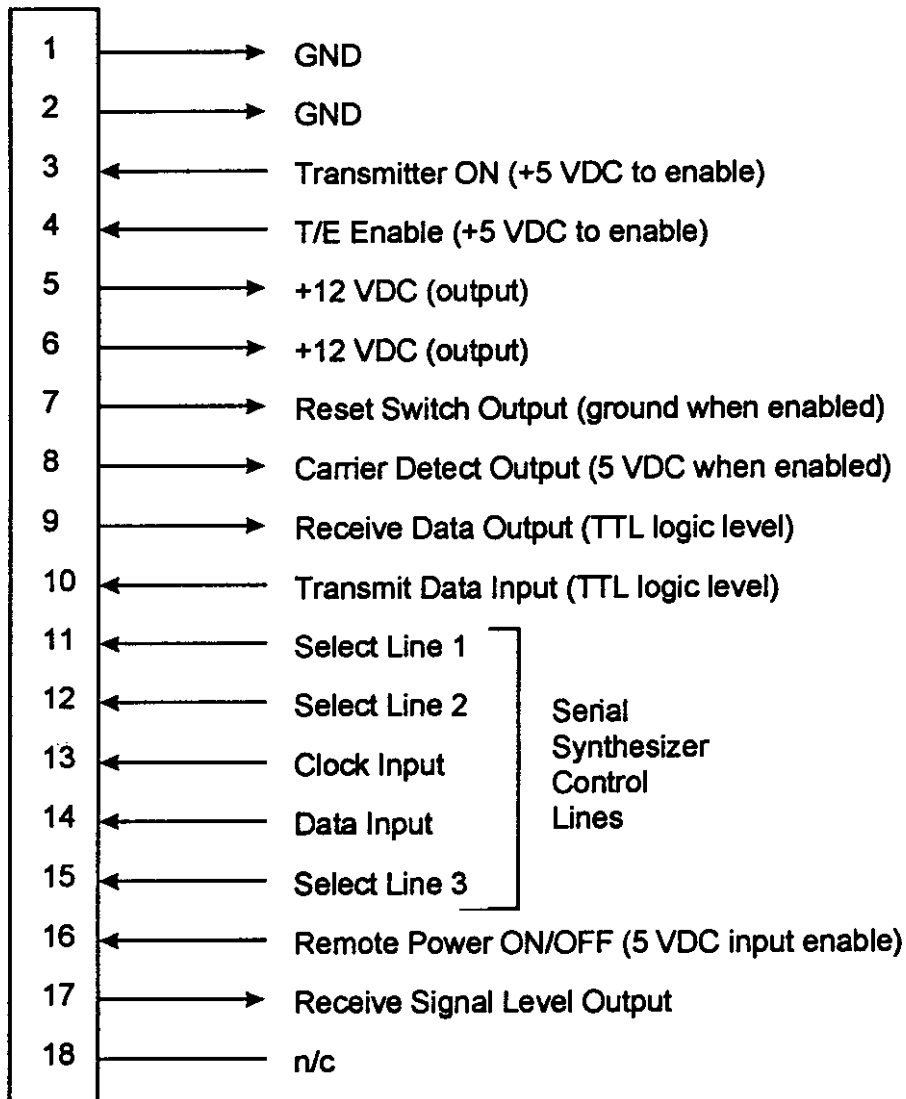
**Confidential****APPENDIX D****SPECIAL HARDWARE SCHEMATIC DIAGRAMS****Model 192 Tx/Rx P1 Schematic**

# APPENDIX E MODEL 192 TEST CONFIGURATIONS

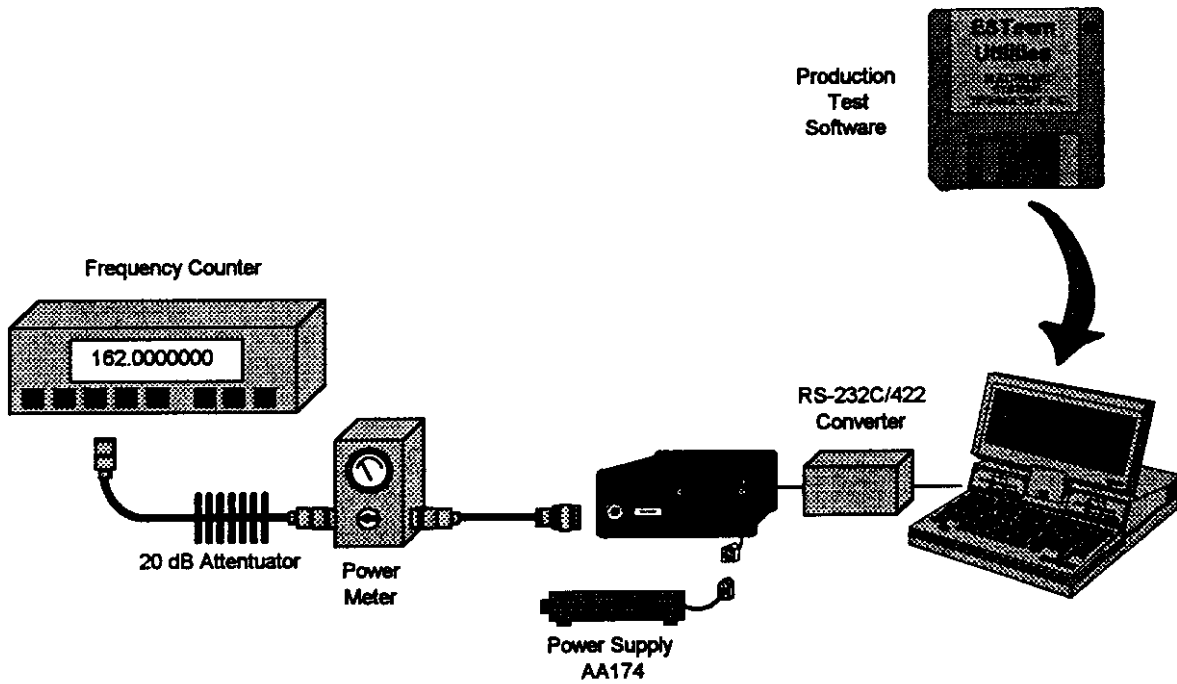

### Model 192M Power/Frequency Test Setup

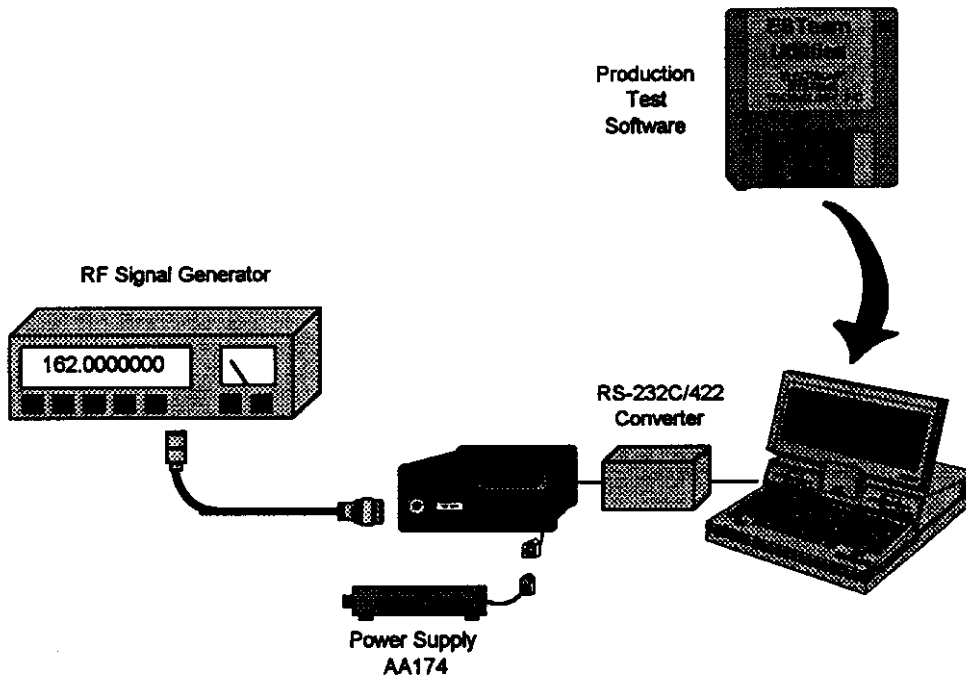

### Model 192M Receiver Sensitivity Test Setup

# APPENDIX E MODEL 192 TEST CONFIGURATIONS

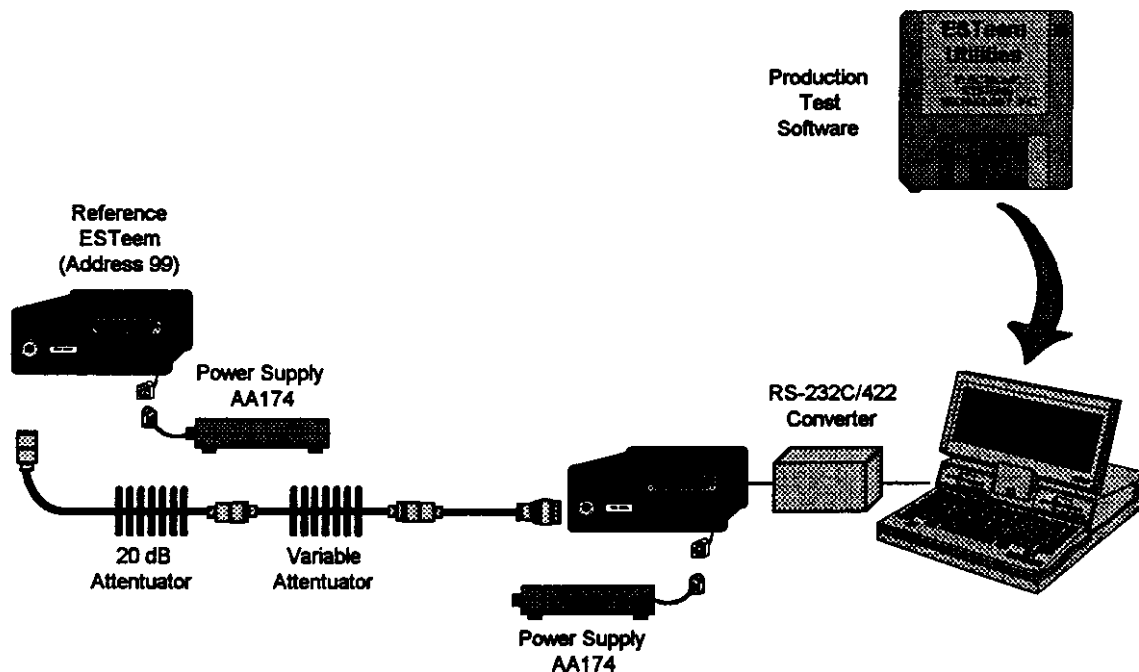

**Model 192M QA/QC Tuning Test Setup**

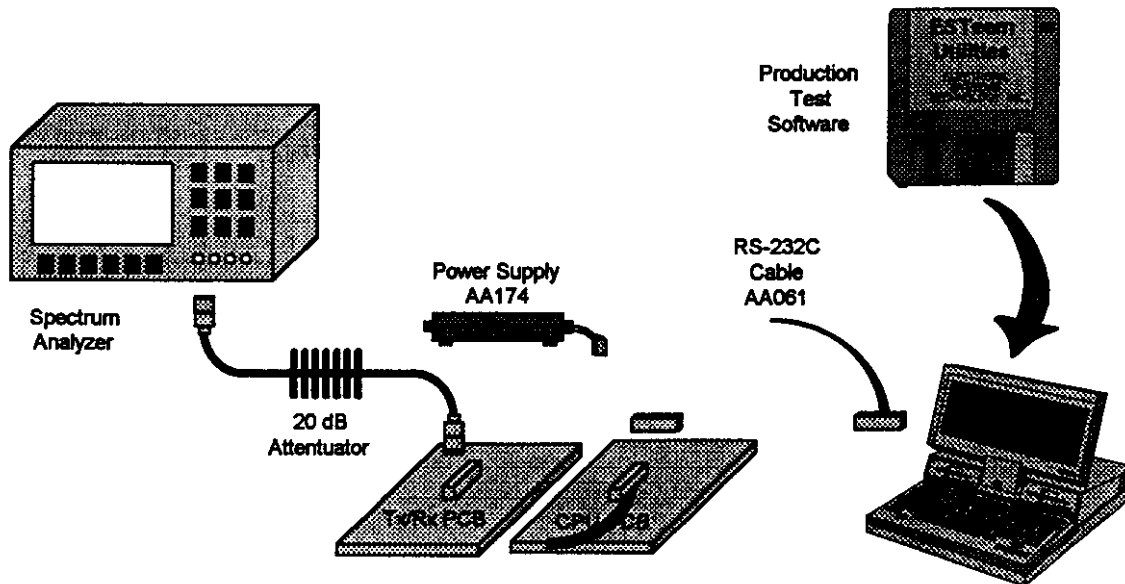

**Model 192M Transmitter Alignment Setup**

# ESTeem Model 192M Product Acceptance Procedure

INITIAL	
MFG	QA/QC

1. Complete ESTeem Burn-in

--

2. Record the following:

--

ESTeem S/N:	<table border="1" style="width: 100%; height: 15px;"><tr><td></td></tr></table>		<table border="1" style="width: 100%; height: 15px;"><tr><td></td></tr></table>		
Tx/Rx Board Rev. No:	<table border="1" style="width: 100%; height: 15px;"><tr><td></td></tr></table>		<table border="1" style="width: 100%; height: 15px;"><tr><td></td></tr></table>		
CPU Board Rev. No:	<table border="1" style="width: 100%; height: 15px;"><tr><td></td></tr></table>		<table border="1" style="width: 100%; height: 15px;"><tr><td></td></tr></table>		
EPROM Version:	<table border="1" style="width: 100%; height: 15px;"><tr><td></td></tr></table>		<table border="1" style="width: 100%; height: 15px;"><tr><td></td></tr></table>		
QA Review of above items:			<table border="1" style="width: 100%; height: 15px;"><tr><td></td></tr></table>		

3. Record ESTeem power supply voltage (12 VDC +/- .2V):

--	--	--

4. Program ESTeem for 162 MHz operation and record transmitter output power (4.5 W +/- .5 W):

--	--	--

5. Program ESTeem for 150 MHz operation and record transmitter output power ( $\geq 4.0$ ):

--	--	--

6. Program ESTeem for 174 MHz operation and record transmitter output power ( $\geq 4.0$ ):

--	--	--

7. Program ESTeem for 162 MHz and record frequency (162.000000 +/- 150 Hz)

--	--	--

8. Program ESTeem for 162 MHz operation and record the following receiver squelch levels:

Low (-70 dBm +/- 5 dBm)	<table border="1" style="width: 100%; height: 15px;"><tr><td></td></tr></table>		<table border="1" style="width: 100%; height: 15px;"><tr><td></td></tr></table>		
High (-101 dBm +/- 1 dBm)	<table border="1" style="width: 100%; height: 15px;"><tr><td></td></tr></table>		<table border="1" style="width: 100%; height: 15px;"><tr><td></td></tr></table>		

9. Complete EST QA Tune Test:

A. Option No. \_\_\_\_\_ B. Mark Signal Strength Meter: \_\_\_\_\_ 

--

10. Perform RS-422/485 communications port test:

--	--

11. Perform IR communications port test:

--	--

12. Restore ESTeem to Factory Default Settings and perform SAVE command:

--	--

13. Configure ESTeem RS-232C port for 19,200, N,8,1

--	--

14. ESTeem final assembly complete

--	--

Comments

--

MFG Technician: \_\_\_\_\_

Date: \_\_\_\_\_

EST QA Technican: \_\_\_\_\_

Date: \_\_\_\_\_

# ESTeem Model 192M Product Acceptance Procedure

INITIAL	
MFG	QA/QC

1. Complete ESTeem Burn-in

--

2. Record the following:

--

ESTeem S/N:	<table border="1" style="width: 100%; height: 15px;"><tr><td></td></tr></table>		
Tx/Rx Board Rev. No:	<table border="1" style="width: 100%; height: 15px;"><tr><td></td></tr></table>		
CPU Board Rev. No:	<table border="1" style="width: 100%; height: 15px;"><tr><td></td></tr></table>		
EPROM Version:	<table border="1" style="width: 100%; height: 15px;"><tr><td></td></tr></table>		
QA Review of above items:		<table border="1" style="width: 100%; height: 15px;"><tr><td></td></tr></table>	

3. Record ESTeem power supply voltage (12 VDC +/- .2V):

--	--	--

4. Program ESTeem for 162 MHz operation and record transmitter output power (2.5 W +/- .5 W):

--	--	--

5. Program ESTeem for 150 MHz operation and record transmitter output power ( $\geq 2.0$ ):

--	--	--

6. Program ESTeem for 174 MHz operation and record transmitter output power ( $\geq 2.0$ ):

--	--	--

7. Program ESTeem for 162 MHz and record frequency (162.000000 +/- 150 Hz)

--	--	--

8. Program ESTeem for 162 MHz operation and record the following receiver squelch levels:

Low (-70 dBm +/- 5 dBm)	<table border="1" style="width: 100%; height: 15px;"><tr><td></td></tr></table>		
High (-101 dBm +/- 1 dBm)	<table border="1" style="width: 100%; height: 15px;"><tr><td></td></tr></table>		

9. Complete EST QA Tune Test:

A. Option No. \_\_\_\_\_ B. Mark Signal Strength Meter: \_\_\_\_\_ 

--

10. Perform RS-422/485 communications port test:

--	--

11. Perform IR communications port test:

--	--

12. Restore ESTeem to Factory Default Settings and perform SAVE command:

--	--

13. Configure ESTeem RS-232C port for 19,200, N,8,1

--	--

14. ESTeem final assembly complete

--	--

Comments

--

MFG Technician: \_\_\_\_\_

Date: \_\_\_\_\_

EST QA Technican: \_\_\_\_\_

Date: \_\_\_\_\_

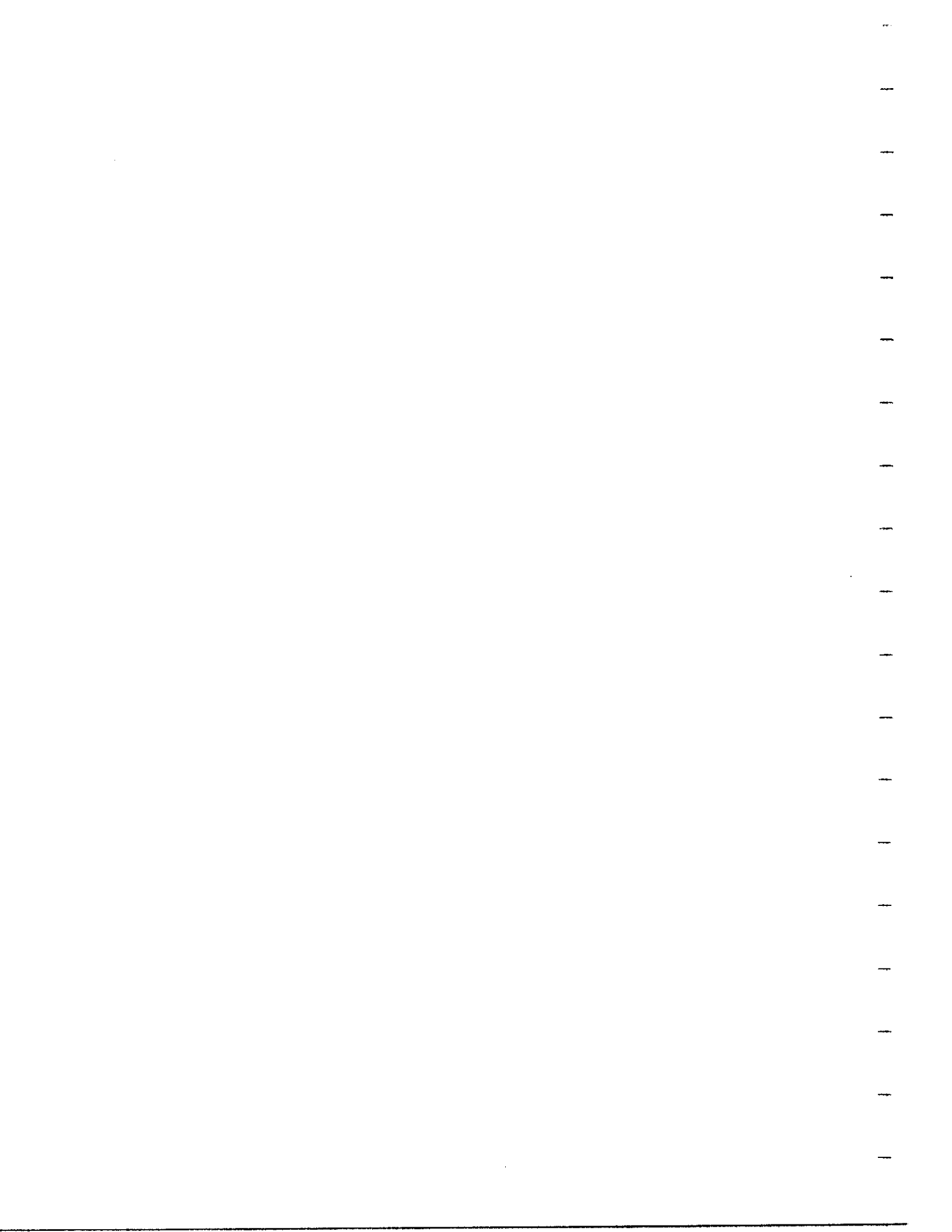



# **ESTEEM USERS MANUAL**

for

## **MODELS 192C/F/V/M**

**Firmware Versions 1.33 and above.**

**September 1997**

*This manual and the firmware described in it are copyrighted by EST, with all rights reserved. Under the copyright laws, this manual or the firmware internal to the ESTeem unit may not be copied, in whole or part, without the written consent of EST. Under the law, copying includes translating into another language.*

*Electronic Systems Technology (EST) cannot guarantee that you will receive notice of a revision to the firmware described in the manual, even if you have returned a registration/warranty card received with the product. You should periodically check with your authorized EST dealer or call factory direct.*

*EST and the EST logo are registered trademarks of Electronic Systems Technology, Inc. Simultaneously published in the United States and Canada. All rights reserved.*

# PRODUCT WARRANTY

Electronic Systems Technology, Inc., (hereinafter EST) expressly warrants its products as free of manufacturing defects for a period of one year from the date of sale to first user/customer.

**THERE ARE NO OTHER WARRANTIES, EXPRESS OR IMPLIED AND THERE IS EXPRESSLY EXCLUDED ALL WARRANTIES OF MERCHANTABILITY OR FITNESS FOR A PARTICULAR PURPOSE. NO OTHER WARRANTY GIVEN BY ANY EMPLOYEE, AGENT, DISTRIBUTOR OR OTHER PERSON WITH RESPECT TO THE PRODUCT SHALL BE BINDING ON EST.**

## LIMITATION OF LIABILITY:

EST's liability shall be limited to refunding of purchase price, repair or replacement of product.

**IN NO EVENT SHALL EST HAVE LIABILITY FOR CONSEQUENTIAL, INCIDENTAL, SPECIAL OR EXEMPLARY DAMAGES CAUSED DIRECTLY OR INDIRECTLY BY THE PRODUCT, INCLUDING BUT NOT LIMITED TO ANY INTERRUPTION OF SERVICES, LOSS OF BUSINESS OR ANTICIPATORY PROFITS. IN NO EVENT SHALL EST BE LIABLE FOR ANY DAMAGES WHATSOEVER IN EXCESS OF THE PURCHASE PRICE OF THE PRODUCT.**

In the event that a unit or part requires replacement or factory servicing, the following conditions apply:

- a) Customer must obtain from EST an authorized RMA (Return Materials Authorization) number (call 509-735-9092 Customer Support) before shipment of product or parts to EST for any reason;
- b) If the whole unit is shipped, it must be in its original carton and shipping components, or a carton and shipping components supplied by EST, or if parts only are shipped, they must be packaged and cushioned so as to prevent damage in transit and shipped freight prepaid;

## PRODUCT WILL BE CONSIDERED OUT OF WARRANTY IF:

- a) If the product is damaged due to improper or abnormal use, abuse, mishandling, accident or improper maintenance or failure to follow operating instruction;
- b) If the product is defective as a result of sand, dirt, or water damage;
- c) If any factory-sealed enclosure has been opened or shows evidence of an attempt to be opened;
- d) If defects or damage are caused by the use of unauthorized parts or unauthorized service;
- e) If the product has had its serial numbers altered or removed.

Warranty repair form must be accompanied by proof of user's purchase of unit. Product must be shipped to the manufacturer at the following address:

Electronic Systems Technology  
415 North Quay Street  
Kennewick, Washington USA 99336

## ADDITIONAL SERVICE:

If EST releases an improvement update to firmware internal to the ESTeem unit during the 90 day period after the unit was purchased by the first user/customer, EST will update the applicable unit with the revised version at no charge other than for UPS handling and shipping to and from your location to the EST factory. Return of any such item must be accompanied with proof of purchase.

# TABLE OF CONTENTS

## CHAPTER 1 - STARTING OUT

Before You Start .....	1-2
ESTeem Utility .....	1-2
Installing ESTeem Utility Software - DOS .....	1-2
Installing ESTeem Utility Software - Windows ...	1-2
Running The Program .....	1-2
Starting Out .....	1-3
ESTeem Basic Programming .....	1-4
Help Functions .....	1-5
Saving a Program .....	1-5
Restoring Factory Default Settings.....	1-5

## CHAPTER 2 - MODES OF OPERATION

Command Mode .....	2-2
Converse Mode .....	2-2
Transparent Mode .....	2-3
Semi-Transparent Mode .....	2-3
Hardware Mode Control .....	2-3

## CHAPTER 3 - PROGRAMMING ESTEEM FEATURES

Digi-Repeating Feature .....	3-2
Global Broadcast Feature .....	3-2
Auto Transmit Feature .....	3-3
Auto Connect Feature .....	3-3
Multi-Connect Feature .....	3-3
Remote Programming Feature .....	3-4
Security Feature .....	3-4

Hardware Ring Line .....	3-4
Packet Monitor Feature .....	3-5
Using The Infrared Communications Port .....	3-5
Using The Phone Communications Port .....	3-6

## CHAPTER 4 - ESTEEM APPLICATION PROGRAMS

Transparent Auto-Connect .....	4-2
Transparent Auto-Connect Global .....	4-2
Interactive Terminal Applications.....	4-3
Programmable Logic Controllers .....	4-3

## CHAPTER 5 - RS-232C/422/485 INTERFACING

DTE vs DCE .....	5-2
Flow Control .....	5-2
Memory Buffers .....	5-3
Data Terminal Ready .....	5-3
RS-422/485 Configuration .....	5-3
RS-232/422/485 Configuration Tables .....	5-4
RS-232/422/485 Port Pin-out Table .....	5-4

## CHAPTER 6 - ANTENNAS

Coaxial Cables .....	6-2
Weather Proofing Coaxial Connectors .....	6-2
Grounding .....	6-3
Lightning Arrestors .....	6-3

# TABLE OF CONTENTS

## CHAPTER 6 - ANTENNAS

Reference Material .....	6-3
Model 192 Typical Outdoor Antenna Installation Diagram .....	6-4
Model 192 Typical Indoor & Mobile Antenna Installation Diagram .....	6-7
ESTeem SWR Measurements Block Diagram...	6-10

## CHAPTER 7 - THEORY OF OPERATION

Introduction .....	7-2
ESTeem How It Works .....	7-2
Spectrum Utilization .....	7-3
Packet Protocols .....	7-3
Flow Control .....	7-3
Data Privacy .....	7-3
Effective Baud Rate .....	7-3

## APPENDICES

### Appendix A - Licensing

(USA only) .....	APX A-2
------------------	---------

### Appendix B - Specifications

ESTeem Specifications .....	APX B-1
Model 192 Antenna Specifications .....	APX B-4

### Appendix C - Tables/Diagrams

ESTeem Command Error Message Table....	APX C-1
ESTeem System Status Message Table .....	APX C-2
ESTeem System Error Message Table .....	APX C-3

### Appendix D - ESTeem Software Commands

Factory Default Settings.....	APX D-1
Definitions .....	APX D-2

# **CHAPTER 1**

## **STARTING OUT**

---

### **BEFORE YOU START**

### **ESTEEM UTILITY**

**Installing ESTeem Utility Software - DOS**

**Installing ESTeem Utility Software - Windows**

**Running The Program**

### **STARTING OUT**

### **BASIC ESTEEM PROGRAMMING**

**HELP Functions**

**Saving A Program**

**Restoring Factory Defaults**

# CHAPTER 1 STARTING OUT

## BEFORE YOU START

Congratulations on your purchase of the ESTeem Wireless Modem! This section of the manual will describe the basic functioning and programming of the ESTeem to get your wireless network up as soon as possible. It is recommended that any first time user of the ESTeem and those that are unfamiliar with its operation complete all steps in this section before proceeding.

Take a few minutes to inventory your equipment before you proceed. Report any missing or damaged items to Customer Support as soon as possible. We at Electronic Systems Technology, Inc. (EST) are constantly trying to improve our products and support system so if you have any comments or suggestions on improvement of this manual, please contact us at (509) 735-9092.

The completion of this section requires loading the ESTeem Utility program on your computer. The following section will describe the installation and use of this valuable utility program.

## ESTEEM UTILITY

The ESTeem Utility is designed to assist the ESTeem user in programming and troubleshooting. The Utility covers basic operation, programming, PLC applications, and diagnostics of the ESTeem.

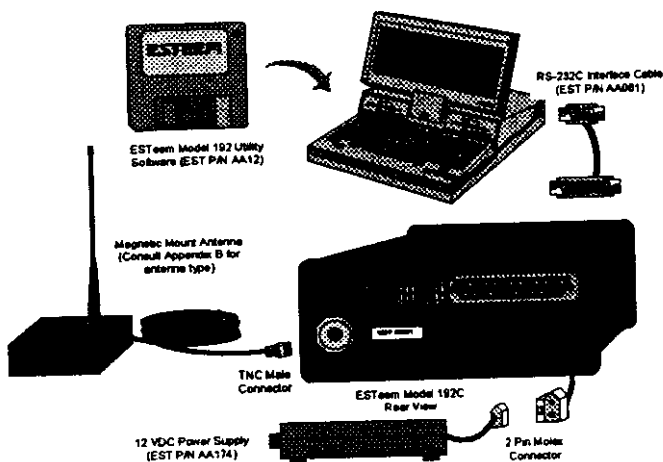

Figure 1: Installation Diagram

## Installing ESTeem Utility Software-DOS

1. Boot-up the computer using DOS.
2. Insert the 3.5 inch ESTeem Utility Program into drive A. Reference Figure 1.
3. Select drive A from DOS by typing A: and press RETURN.
4. Type INSTALL followed by pressing RETURN.
5. The ESTeem Utility and Diagnostic Programs will be loaded on to your computer's hard drive.

## Installing ESTeem Utility Software-WINDOWS

1. Insert the ESTeem Utilities Disk in drive A, or type the appropriate drive for your system.
2. Select RUN from the File menu.
3. Type A:\install on the RUN line.
4. Follow the procedures in the installation program.
5. Remove the ESTeem Utility Program from drive A and store in a safe place.

## Running The Program

1. To run the program, type EST-U followed by a RETURN. Figure 2 shows an example of the menu of the ESTeem Utility program. If you see this menu, you have successfully completed the installation of the ESTeem Utility software.

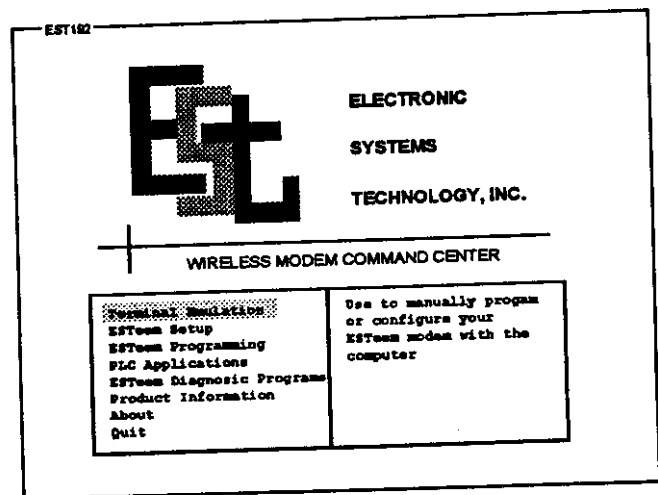

Figure 2: ESTeem Utility Main Menu

# CHAPTER 1 STARTING OUT

## STARTING OUT

This section covers the basics of operating the ESTEem wireless modem. If this is your first experience with the ESTEem wireless modems or you are unclear on how to set the frequency, squelch, or test communication, the ESTEem Setup section will guide you through the basics of wireless communication.

1. Select ESTEem Setup from the main menu. A window like the one in Figure 3 will be displayed.

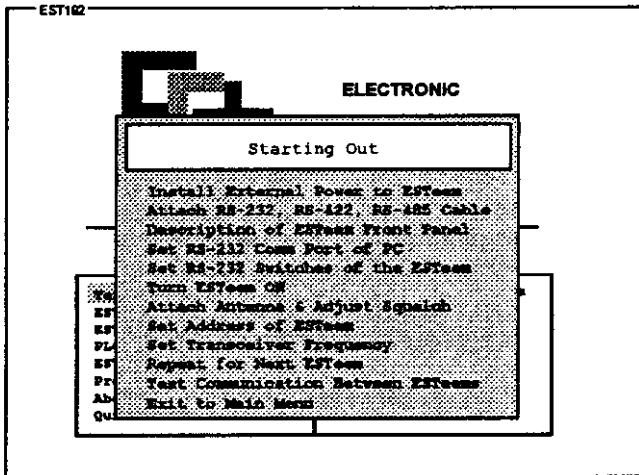

Figure 3: Starting Out Menu

This window is a check sheet for setting all operating parameters of the ESTEem. As you complete each section, a check mark will be displayed next to the item you finished. This will allow you to verify that all steps were taken in programming the ESTEems to communicate. Proceed to step 2.

2. Select Install External Power to ESTEem from the menu. You are instructed to plug the power converter into the power source and the ESTEem modem. The voltage and current specifications are displayed. The ESTEem model AA174 power supply can be used with all ESTEem products. Press any key to proceed.
3. Select Attach RS-232, RS-422, RS-485 Cable from the main menu. All the cable configurations for the ESTEem serial port are listed. Press ENTER to scroll through the pin-outs. Press the ESC key when finished. Attach a serial cable to the computer and ESTEem modem.

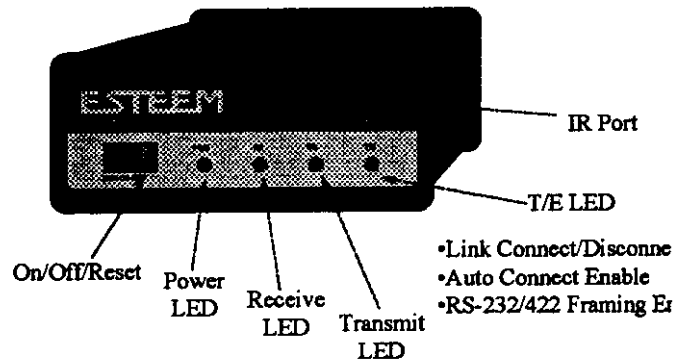

Figure 4: ESTEem Front Panel

**Note:** A standard 9-Pin serial port on a computer to ESTEem interface cable is the ESTEem AA061 (Figure 1).

4. The Description of ESTEem Front Panel section will show the location and description of the four lights on the front of all ESTEem modems (Figure 4). For example, place the cursor dot over the PWR location and press ENTER. A small dialog on the meaning of the PWR light indicator will be displayed. Familiarize yourself with the meaning of all the display lights on the ESTEem and press ESC to continue.
5. Select Set RS-232 Comm Port of PC and press ENTER. This section will configure the communications port on your computer to operate with the ESTEem modem. Select the operating parameters you wish or leave at the default of

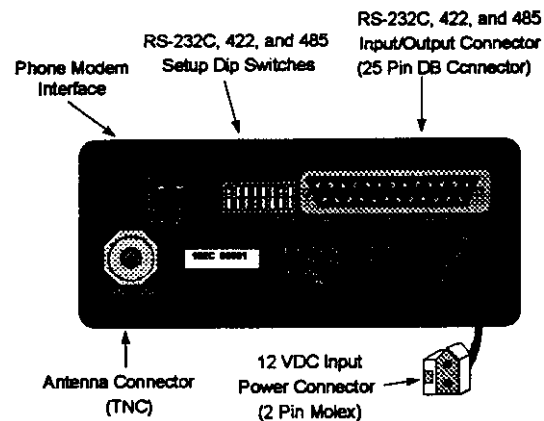

Figure 5: ESTEem Rear Panel Diagram

# CHAPTER 1

## STARTING OUT

- 19,200,N,8,1. Press the control key and the enter key at the same time (CTRL-Enter) to select your choice.
- This next section is titled Set RS-232 Switches of the ESTeem. Press ENTER and the window will display how the RS-232 switches on the rear of the ESTeem (Figure 5) need to be set to match the configuration of the computer's communication port that we set in step 5. Configure the switches on the ESTeem to match those listed in the window and press any key to continue.
  - Select Turn ESTeem ON. If your power cord and serial interface cable are installed correctly, the ESTeem welcome message will be displayed. This will confirm communications between computer and the ESTeem. If you do not see the welcome message or the computer displays an error in communication, follow the on-line troubleshooting procedure that will be displayed.
  - Select Attach Antenna & Adjust Squelch from the menu. This section will give you instructions on antenna placement and installation. Install antenna and press the ENTER key to set the squelch. Proceed to step 9.
  - This section of the utility will set the receiver squelch on the ESTeem. The ESTeem's radio communication protocol will not allow the modem to transmit if the ESTeem has a solid receive light due to outside interference. Look on the front of the modem and adjust the squelch to as high a level as possible that will keep the receive light out when other ESTeems are not transmitting. Press ESC to leave this section.
  - Press Set Address of ESTeem. You must give each ESTeem a unique address in the system. Type in the address number and press ENTER to continue.
  - Select Set Transceiver Frequency. This will allow you to configure the ESTeem's operating frequency. Set all ESTeems on the same frequency for operation within this section. Press CTRL-Enter to continue.
  - You have just configured all operating parameters within the ESTeem. If this is your first ESTeem you have programmed for testing, press the Repeat for next ESTeem and all check marks will be erased. Proceed to step 2 and complete all items for the next ESTeem. If you have at least two ESTeems programmed and wish to test communication, proceed to step 13.

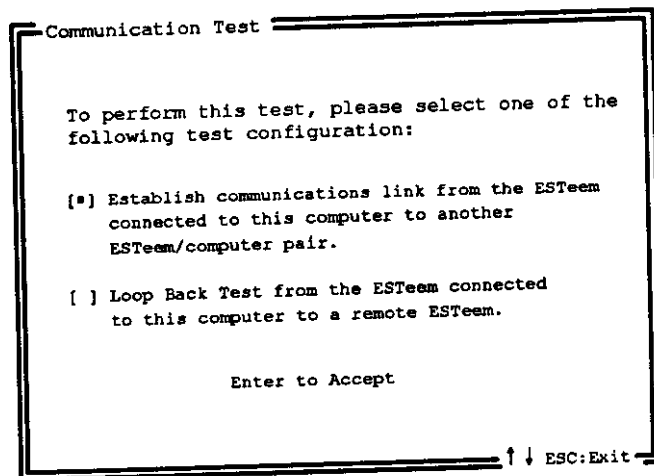

Figure 6: Communications Test Window

- Press Test Communication Between ESTeems. This section will allow you to test the radio frequency (RF) communications between two or more ESTeems. Two types of tests are listed in this window (Figure 6). If you have a computer attached to both ESTeems proceed to step 14 and if you only have one computer to test both ESTeems proceed to step 15.
- The first test will be used if you have a computer attached to both ESTeems. Select the first of two items and press ENTER. Follow the instructions on the screen to establish a communication link between modems.
- This second test will allow you to use the remote ESTeem as a digi-repeater for your local modem. This procedure is explained in the window and can test communication with only one computer.
- You now have completed the basic programming and setup of your ESTeem modems. You have tested their operation with each other and are now ready to proceed in programming them for your application. Press Exit to Main Menu and continue with the programming of the ESTeem for your application.

### BASIC ESTEEM PROGRAMMING

Most of the ESTeem commands outlined in this section have been automatically input to the modem by the ESTeem Utility program. A few of the commands used most often in troubleshooting and programming are covered here. These commands can be programmed to the modem directly by the Terminal Emulation section of the utility or by any other terminal software package.



# CHAPTER 1

## STARTING OUT

### HELP Functions

The ESTeem has over a hundred software commands to aid the user in their application. The HELP command allow the user to list the various software commands and their respective values.

From the COMMAND mode, type HELP<cr>. Your display should list the following:

Help switches are:

ALL (Lists all settings).  
 CHANGE (List settings changed from factory default).  
 CONTROL (List settings dealing with control).  
 PLC (List settings for PLCs).  
 RADIO (List settings for ESTeem radio).  
 RS232 (List settings for RS-232/422/485).  
 SETUP (List settings for control).  
 SYSTEM (List settings for system).

These are the different software categories.

**Example:** HELP SETUP<cr> , will list all the programmable variables and their settings for the SETUP category.

You can interrogate a discrete software command by just typing the command followed by a <cr>.

**Example:** ADD<cr> , will list the current address saved in the connected ESTeem.

**Note** *Appendix E of this manual will have the complete listing of software commands and categories for the factory default of the ESTeem.*

### Saving A Program

A program is saved by typing in the SAVE command at the CMD: prompt. The programming variables that have been changed will be written to the non-volatile memory.

The programming parameters will be loaded each time the modem is powered up or reset.

### Restoring Factory Defaults

The ESTeem has a very simple procedure to restore the program variables in the unit to the factory default setting. When the FA<cr> command is entered from the command mode the ESTeem will be configured from a variable table located in its EPROM. It is a good practice to restore the ESTeem to a factory defaults before any programming of the unit.

To ensure the modem is in the COMMAND MODE to set it back to the factory default perform the following:

1. Set Bit 8 on the RS-232 setup switches to the OFF position.
2. Reset the ESTeem.
3. Type FA<cr> and the ESTeem welcome message should be displayed. The characters may not be echoed on the screen.
4. Type SA<cr> to save the factory default table.

—  
—  
—  
—  
—  
—  
—  
—  
—  
—  
—  
—  
—  
—  
—  
—  
—  
—  
—  
—  
—  
—  
—

—————

# **CHAPTER 2**

## **MODES OF OPERATION**

---

**COMMAND MODE**

**CONVERSE MODE**

**TRANSPARENT MODE**

**SEMI-TRANSPARENT MODE**

**HARDWARE MODE CONTROL**

# CHAPTER 2

## MODES OF OPERATION

The ESTeem has three major modes of operation, Command, Converse, and Transparent. This chapter of the manual describes each one of these modes.

### COMMAND MODE

The COMMAND Mode (CMD: prompt) is the default mode that the ESTeem initially enters on power-up or after a hardware or software reset. From this mode the user can command or program the ESTeem. In this mode the user may access the various program commands to configure the ESTeem for the specific application. These values can be stored in nonvolatile memory within the ESTeem by the use of the SAVE command. The ESTeem reads these setup parameters stored in memory on power-up or RESET.

When programming in the COMMAND Mode, the user need only enter enough characters to uniquely identify the respective command.

Example: CMD:ADD 15 <cr>

This enters the source address of the ESTeem to the decimal value of 15. The first three letters ADD were enough for the ESTeem to uniquely identify the command for ADDRESS. The number of characters that need to be typed varies depending upon the command being entered. In some cases, four or even more letters may have to be entered in order for the identification to be uniquely determined. Up to ten multiple commands can be written on the same line if separated by a colon.

Example: CMD:ADD 15:SETC 2:SAVE <cr>

### CONVERSE MODE

This mode allows bi-directional communication from the input/output device attached to the ESTeem to a destination ESTeem and its respective input/output device. The ESTeem will automatically switch to the CONVERSE Mode after the initial CONNECT has been made.

When the ESTeem is in the CONVERSE Mode the \* prompt will be displayed. The ESTeem will remain in the CONVERSE Mode until the radio link has been broken or by typing a control character defined by the user with the COMMAND variable.

The factory default for the COMMAND variable is CTRL C. You can return to the CONVERSE Mode from the COMMAND Mode by typing CONV <cr>.

When you are in the CONVERSE Mode the echoing of the character comes from the ESTeem if ECHO = ON (factory default) has been programmed in the ESTeem.

### Transmitting Data

The ESTeem will transmit data from the CONVERSE Mode if one or more of the following conditions have been met.

1. The ESTeem transmit buffer has been filled. The size of the transmit buffer is defined in the ESTeem by the PACKLEN variable. This variable is programmable from 1 to 2000 bytes. Factory default is 2000.
2. The ESTeem receives a SENDPAC (send packet) character from the RS-232C input data stream. The SENDPAC variable can be defined from 0 to 255 by the user. Factory default is 13 (carriage return). The SENDPAC character is also transmitted by the ESTeem. In file dump applications the SENDPAC character can be programmed to be the EOF (end of file) character transmitted from the sending device (i.e.; CTRL Z, CTRL G, etc.).
3. Termination control timer. The termination control timer is enabled by the TERMC (on/off) command. When enabled, the termination timer starts from the time the last transmit buffer has been updated in the RS-232C port. If the termination timer expires before another character is received or transmitted, the contents of the ESTeem transmit buffer will be transmitted. The waiting time of the timer is defined by the TERMT variable (termination time). The programming range of the TERMT variable is 10-255ms. Factory default values are TERMC = OFF and TERMT = 50. It is noted that when the termination timer is used, the SENDPAC variable is usually programmed to be a character that is non occurring in your data stream (i.e.; SENDPAC = 255) so that premature transmission does not occur.

# CHAPTER 2

## MODES OF OPERATION

### TRANSPARENT MODE

The TRANSPARENT Mode allows the ESTeem to pass all data characters (O-255 or 0-FF hex) using 8 data bits.

To program the ESTeem in the TRANSPARENT mode the TRANSPARENT command must be enabled and switch Bit 8 to ON (RS-232C Setup Switch). The TRANSPARENT command will defeat the SENDPAC and COMMAND variables and put the ESTeem in the transparent mode when Bit 8 is ON.

The transmission of the data packets can only be accomplished by enabling the termination control commands (TERMC and TERMT) or the PACKLEN buffer being filled. The value of TERMT should be slightly longer than the maximum delay encountered during RS-232C transmission. If this time is set to short, the ESTeem will truncate your data stream improperly.

When using the TRANSPARENT Mode, data flow control is by hardware handshaking only. Hardware handshaking is initiated by enabling hardware flow control (XHF = ON).

The SETCON (Set Connect command) must be used to define the node that you want to communicate with while in the TRANSPARENT Mode. When the TRANSPARENT Mode is enabled you can not communicate to the ESTeem in the COMMAND Mode unless you use the Hardware Mode Control line (see explanation this chapter).

To remove the ESTeem from the TRANSPARENT Mode the user must perform the following:

1. Switch Bit 8, Off on the RS-232C Setup Switch.
2. Reset the ESTeem from the front panel switch.
3. Type Tra OFF <cr>.

### SEMI-TRANSPARENT MODE

This mode should be utilized when sending a non-ASCII file and there is a possibility that the SENDPAC character could be contained in the transmitted data set. Perform the following prior to programming the ESTeem to initialize the unit to factory default settings:

1. Turn Bit 8, OFF on the RS-232C Setup Switch.
2. Reset the ESTeem.
3. TYPE FA <cr>. Please note the characters may or may not be echoed by the CRT.

#### ESTeem

ADD	xxx	xxx = your address
SETC	yyy	yyy = destination address
TERMC	ON	
TERMT	10	
SENDP	255	
EDIT	OFF	
SAVE		

If EDIT is off, and SENDPAC = 255, the SENDPAC character is disabled. This character when received will not cause packet transmission and will be passed as normal data. The TERMC and TERMT commands are used to transmit the contents of the ESTeem transmit buffer.

Software flow control in this example is still enabled (factory default XSF = ON) therefore the ESTeem will pass all characters except the data flow control characters for Xon/Xoff.

### HARDWARE MODE CONTROL

The MODECON (Mode Control) command is provided in the ESTeem to change the mode of the ESTeem modem from COMMAND Mode to CONVERSE (or TRANSPARENT Mode) via a hardware control line. The hardware line is located on pin 19 of the RS-232C connector. If MODEC = HARDWARE, a "low or 0" on pin 19 (-3 to -15 vdc) will put the ESTeem in the COMMAND Mode and a "high or one" on pin 19 (+3 to +15 vdc) will put the ESTeem in the CONVERSE or TRANSPARENT Mode. The factory default is SOFTWARE.

1  
2  
3  
4  
5  
6  
7  
8  
9  
10  
11  
12  
13  
14  
15  
16  
17  
18  
19  
20  
21  
22  
23  
24  
25  
26  
27  
28  
29  
30  
31  
32  
33  
34  
35  
36  
37  
38  
39  
40  
41  
42  
43  
44  
45  
46  
47  
48  
49  
50  
51  
52  
53  
54  
55  
56  
57  
58  
59  
60  
61  
62  
63  
64  
65  
66  
67  
68  
69  
70  
71  
72  
73  
74  
75  
76  
77  
78  
79  
80  
81  
82  
83  
84  
85  
86  
87  
88  
89  
90  
91  
92  
93  
94  
95  
96  
97  
98  
99  
100

# **CHAPTER 3**

## **PROGRAMMING ESTEEM FEATURES**

---

FCC ID: ENPESTEEM192M

**DIGI-REPEATING FEATURE**

**GLOBAL BROADCAST FEATURE**

**AUTO TRANSMIT FEATURE**

**AUTO CONNECT FEATURE**

**MULTI-CONNECT FEATURE**

**REMOTE PROGRAMMING FEATURE**

**SECURITY FEATURE**

**HARDWARE RING LINE FEATURE**

**PACKET MONITOR FEATURE**

**USING THE INFRARED COMMUNICATIONS PORT**

**USING THE PHONE COMMUNICATIONS PORT**

**ESTEEM**

# CHAPTER 3

## PROGRAMMING ESTEEM FEATURES

Listed in this chapter are the major ESTeem features and programming examples on how to use them. These features are individual building blocks to solve your application needs. Remember your particular application may require one or more of these features enabled.

### DIGI-REPEATING

The Repeater feature allows an ESTeem to relay it's respective transmission or packet through a maximum of three ESTeems to increase the operating range of the unit. Any ESTeem in your radio network can function as a repeater for any other ESTeem. This is independent of the fact that the ESTeem being used as a repeater is linked or connected to another node, therefore an ESTeem can function as a repeater, operational node, or both at the same time. The data that is digi-repeated through an ESTeem will not be output through the repeating ESTeem's RS-232C port.

To specify one or more ESTeems as repeaters, the CONNECT command has been expanded to except up to three added addresses as follows:

```
CONN r1,r2,r3,da
```

r1 = Address (1 to 254) of first ESTeem repeater.  
r2 = Address (1 to 254) of second ESTeem repeater.  
r3 = Address (1 to 254) of third ESTeem repeater.  
Da = Address (1 to 255) of destination ESTeem.

**Note:** *Address 255 is used for Global.*

When transmitting packets through other ESTeems, the source ESTeem will automatically adjust it's FRACK time to allow additional time for the packet to reach its destination and for the returned acknowledgment. Frack time takes into account the packet size and the number of repeaters specified. The ACK still comes from the destination ESTeem, not the first or any repeater.

For testing purposes, you can loop back a connection to yourself by placing your source address in the destination address of the repeater string. Any data transmitted will repeat through the repeater address and display back on the screen.

#### Example:

```
CONN r1,Sa
```

r1 = Address (1 to 254) of first ESTeem repeater.  
Sa = Address of local ESTeem.

Any ESTeem command in this manual that uses an address string can be configured to use the Digi-repeating feature.

#### Example:

```
SETC r1,r2,r3,da
```

### GLOBAL BROADCAST

Global broadcast is the ability of one ESTeem to transmit it's message to more than one ESTeem at one time. All ESTeems within radio range will receive the message whether or not they are connected to another ESTeem or in command or converse mode.

You can put your ESTeem in Global by connecting or programming the SETC to address 255. Address 255 is a non assignable unit address and is used by the ESTeem CPU to access this special mode. When an ESTeem is in Global, the standard ACK protocol from the receiving ESTeem is disabled, but the 32 bit CRC error checking on the received ESTeem is still operational. When you perform CONN 255 <cr> from the COMMAND MODE the ESTeem will immediately go to the CONVERSE MODE (\* is displayed). All messages sent will be transmitted globally to all ESTeems in radio range.

In the ESTeem you have a GLOBAL (on/off) command. When GLOBAL = On, you can receive Global transmissions. If GLOBAL = Off you will not display Global transmissions from other ESTeems.

**Note:** *Factory default is ON.*

By using the repeater function you can transmit Global messages from another ESTeem using the Digi-repeating feature.

#### Example:

```
CONN 10,20,30,255<cr>  
SETC 10,20,30,255<cr>
```



# CHAPTER 3

## PROGRAMMING ESTEEM FEATURES

By adjusting these commands you can route from unit 10 to 20, 20 to 30, and go Global at unit 30.

You can enable global transmissions in more than one ESTEem in your network. This will allow global communications between all ESTEems within radio range.

### AUTO TRANSMIT

The Auto Transmit feature of the ESTEem allows the user to transmit a data packet without filling up the PACKLEN (packet length) buffer or defining a special control character using the SENDPAC (send packet) variable. The Auto Transmit feature is a timer that is enabled in the ESTEem that monitors traffic in and out of the RS-232C port. If there are characters in the RS-232C buffer, the termination control timer starts from the time the last receive or transmitted character is updated in the buffer. If the termination time expires before another character is received or transmitted, the received characters are transmitted.

To enable this feature perform the following from the COMMAND MODE:

TERMC (on/off) = On. Enable termination control.

TERMT (10-255) = One unit number equals 1ms.

TERMC is the termination control command. TERMT is the termination time command. Factory default for TERMC = Off and TERMT = 10.

### AUTO CONNECT

The Auto Connect feature allows the user to program the ESTEem to perform a CONNECT to another ESTEem when data is sent to the RS-232C communications port.

To enable this feature perform the following from the COMMAND MODE:

SETCON (1-255) = Address of destination ESTEem.

Remember, you can use the Repeater routing (r1,r2,r3,da) or put the ESTEem in Global (address 255). SETCON is the set connect command.

SA SAVE command. This will save the SETC variable to the non volatile memory so that it will not be lost when the ESTEem is RESET.

Bit 8 (on/off) = On. Bit 8 is located on the RS-232C SETUP SWITCH on the rear of the ESTEem. The ESTEem must be RESET after the Bit has been changed to be read by the ESTEem CPU.

RESET ESTEem RESET is located on the front panel OFF/ON switch. The T/E light on the front panel of the ESTEem should now flash at a two times per second rate.

### MULTI-CONNECT

The actual polling of the ESTEem must originate from the host device connected to the ESTEem using the CONNECT command to originate the initial connect and the COMMAND character to return from the CONVERSE mode to the COMMAND mode. The first time around the pole a CONNECT data packet (rf transmission) will be initiated. When a link is established, it is held internally in the ESTEem connect table. The next time around the pole to the same address, the link status will be checked in the ESTEem table. If the address indicates a link has already been established, then only data and its corresponding ACK will be transmitted to that node. This greatly increases polling time by eliminating the usual CONNECT/DISCONNECT sequence each time except when communication is first established.

The MULTID command allows the user to send data to a specific ESTEem address from the CONVERSE Mode by specifying the ESTEem address routing before the data packet. This feature will also display the address of the sending ESTEem on any received data.

#### Example Of Transmitted Data:

[001]DATA Routes data to an ESTEem addressed 1.

[100,200,250,1]DATA Routes data to an ESTEem addressed 1 via ESTEems addressed 100, 200, and 250.

The above example replaces the CONNECT command from the COMMAND Mode.

# CHAPTER 3

## PROGRAMMING ESTEEM FEATURES

Received data packets will have the address of the ESTeem that sent the data at the beginning of the data packet.

### Example Of Received Data:

[004]RECEIVED DATA      Data received from an ESTeem addressed 4.

[030,100,244,004]      Data received from an ESTeem addressed 4 via ESTeems addressed 30, 100, and 244.

MULTID (on/off) = On      Enables this feature. Factory default = OFF.

### REMOTE PROGRAMMING

The Remote Programming feature allows the user to remotely program ESTeems in his network. When a connection has been made with the remote ESTeem the RPG: prompt will be displayed showing that you are now in the COMMAND mode of that remote ESTeem.

To enable this feature perform the following from the COMMAND MODE:

PROG (1-254)      Address of destination ESTeem.

**Note:** *You can also use the Repeater routing (r1,r2,r3,da) to reach the destination ESTeem. (r1 = address of first repeater, r2 = address of second repeater, etc. da = destination address).*

To end a remote programming session, type DISC (Disconnect) and you will return to the COMMAND prompt of your ESTeem. There is a Watch Dog Timer that will automatically disconnect you from remote programming if there is no activity for thirty seconds.

The REMPROG (on/off) feature is used to defeat the ability of your ESTeem from being remotely programmed. If REMPROG = OFF another ESTeem cannot remotely program your unit. Factory default = ON.

### SECURITY

The Security feature allows the user to lock out programming of the ESTeem. REMEMBER TO STORE YOUR CODE NUMBER IN A SAFE PLACE. To enable this feature perform the following from the COMMAND MODE:

SECURITY (1 to 100,000)      Entering a security number enables the security feature.

SAVE      To enter the security code permanently into the ESTeem memory.

**Note:** *When enabled, the ESTeem will output a "Security On" message.*

To disable the security feature perform the following from the COMMAND mode.

SECURITY (1 to 100,000)      Entering your security number disables the security feature.

SAVE      To remove the security code permanently from the ESTeem memory.

**Note:** *When disabled, the ESTeem will output a "Security Off" message.*

### HARDWARE RING LINE

When the ESTeem establishes a CONNECT or link with another ESTeem (T/E Light on solid), pin 22 at the ESTeem RS-232C will change from a -15 vdc voltage state to a +15 vdc voltage state. The RING software command allows the user to change the output from a latched state to a pulsed state. To change the state of this line program the following from the COMMAND mode. Factory default = LATCH.

RING =Latch. Pin 22 is high when the ESTeem T/E light is on solid.

RING =Pulse. Pin 22 is pulsed (positive 250 ms.) when the ESTeem T/E light is on solid.

# CHAPTER 3

## PROGRAMMING ESTEEM FEATURES

### PACKET MONITOR

The PACKM [ON/OFF] command places the ESTEem in a special packet monitor mode. When this feature is enabled the ESTEem is placed in a receive only mode and will not function as a normal ESTEem. The ESTEem will monitor and report the status of all message traffic within the network in the following format, the actual packet message will not be outputted.

SA-xxx, DA-xxx, Type Code, R1-Repeater Status, R2-Repeater Status, R3-Repeater Status, Data Bytes Sent

xxx = ESTEem Address

DA = Destination ESTEem

SA = Source ESTEem

R1 = Address of first ESTEem repeater.

R2 = Address of second ESTEem repeater.

R3 = Address of third ESTEem repeater.

#### Type Codes

I = Information

DISC = Disconnected

RR = Receive Ready

UA = Unnumbered Acknowledge

RNR = Receive Not Ready

FRMR = Frame Reject

REJ = Reject

DM = Disconnected Mode

UI = Unnumbered Information

SABM = Set Async. Balance Mode

#### Repeater Status

P = Pending

D = Done

### USING THE INFRARED COMMUNICATIONS PORT

The infrared (IR) communications port will allow you to program and interrogate the ESTEem without disconnecting the serial cable from the back of the modem. The IR port is located on the front panel of the ESTEem, above the T/E light.

To communicate from a computer to the ESTEem through the IR port you will need a copy of the ESTEem

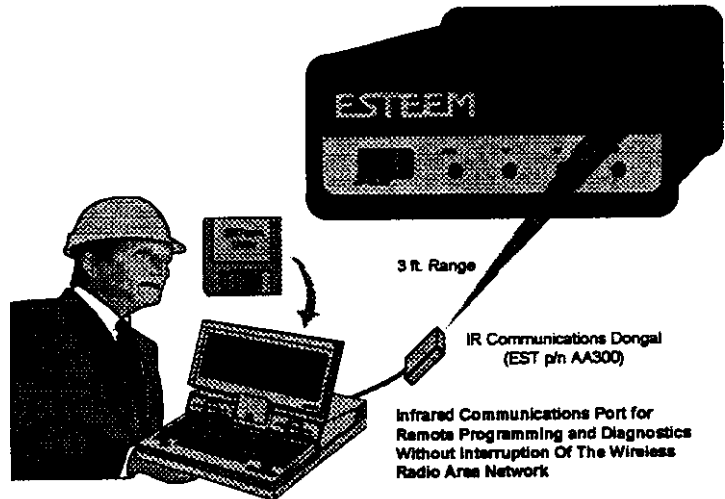

Figure 1: Using The IR Port

Utilities (Version 4.0 or higher) and an ESTEem IR Communication Dongle (ESTEem P/N AA300).

Connect the dongle directly to the serial port of the computer. The dongle requires initialization from the ESTEem Utilities. This initialization is done automatically upon starting the utility or can be done by pressing the ALT key and the I key at the same time (ALT-I). If the modem is not in the COMMAND mode, press CTRL-C to display the CMD: prompt.

**Note:** With Switch 8 (RS-232 Setup) in the On position the ESTEem defaults the IR port to the command mode.

The IR dongle has a range of approximately three feet, directly in front of the port. The dongle is powered by the serial port and requires no additional power sources.

**Note:** Only one of the four communications ports (RS-232/422/485 connector, IR port, Phone Modem Port, or Remote Programming) can be in the Command mode at a time. When either the IR or the Phone port switch to converse mode, the RS-232/422/485 port is blocked from receiving any data.

# CHAPTER 3

## PROGRAMMING ESTEEM FEATURES

### USING THE PHONE COMMUNICATIONS PORT

If your ESTEem modem has the optional phone port installed, you have the ability to gain access to the ESTEem from anywhere in the world through a standard phone modem.

Connect a standard phone company line to the ESTEem's phone connector and dial the number with a phone modem using any type of communications package such as Procomm® or Window® terminal. Set the terminal to connect at 2400 bps. The ESTEem will answer on the first ring. Type a CTRL-C on the communications terminal and a CMD: prompt should appear.

**Note:** When the phone port is active, the IR port will be disabled.

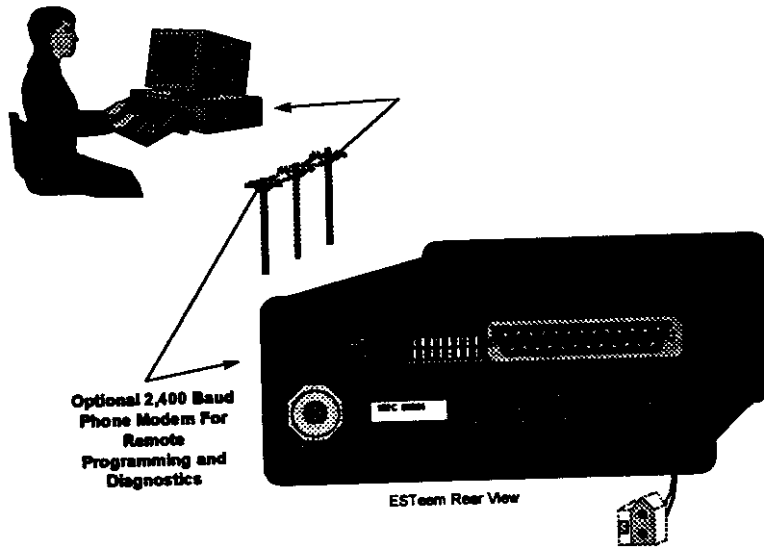

**Figure 2: Using The Phone Port**

# **CHAPTER 4**

## **ESTEEM APPLICATION PROGRAMS**

---

**TRANSPARENT AUTO CONNECT**

**TRANSPARENT AUTO CONNECT GLOBAL**

**INTERACTIVE TERMINAL APPLICATIONS**

**PROGRAMMABLE LOGIC CONTROLLERS**

# CHAPTER 4

## ESTEEM APPLICATION PROGRAMS

Listed below are different application programs to aid the user in programming the ESTeem.

### TRANSPARENT AUTO-CONNECT

This mode is used for a dedicated point to point application. The ESTeem will initiate the radio link when data is received by the RS-232/422/485 port.

Perform the following prior to programming the ESTeem(s) to initialize the unit to factory default settings:

1. Turn Bit 8 OFF on the RS-232C Setup Switch.
2. Reset the ESTeem.
3. TYPE FA <cr>. Please note the characters may not be echoed by the CRT.

ESTeem A		ESTeem B	
ADD	xxx	ADD	yyy
SETC	yyy	SETC	xxx
TERMC	ON	TERMC	ON
TERMT	10	TERMT	10
XHF	ON *	XHF	ON *
DISACK	ON *	DISACK	ON *
TRANS ON		TRANS ON	
SAVE		SAVE	
Bit 8 ON		Bit 8 ON (RS-232 Switch)	
Reset ESTeem		Reset ESTeem	

**Notes:**

- Turn DISACK ON only if you want to defeat the acknowledge packet.
- xxx and yyy represent an ESTeem address which is user definable from 1 to 254.

### TRANSPARENT AUTO-CONNECT GLOBAL

This mode is usually used for a point to multi-point applications when a customers devices include their own addressing protocol to communicate between devices. The ESTeem packet addressing and acknowledge protocol is defeated. All ESTeems will receive the data transmission. The 32 bit CRC error checking on received data is still enabled. This program is used in all ESTeems, the only difference is the unit addresses.

Perform the following prior to programming the ESTeem(s) to initialize the unit to factory default settings:

1. Turn Bit 8 OFF on the RS-232C Setup Switch
2. Reset the ESTeem.
3. TYPE FA <cr>. Please note the characters may not be echoed by the crt.

ESTeem A

---

ADD	xxx (xxx = ESTeem address)
SETCON	255
TERMC	ON
TERMT	10
XHF	ON *
TRANS ON	
SAVE	
Bit 8	ON (RS-232 Switch)
Reset ESTeem	

**Note:** Only hardware flow control can be used in this mode.

# CHAPTER 4

## ESTEEM APPLICATION PROGRAMS

### INTERACTIVE TERMINAL APPLICATION

This program is used to connect a mainframe to a remote terminal. This setup is a typical point to point configuration with the AUTO-CONNECT feature enabled.

Perform the following prior to programming the ESTeem(s) to initialize the unit to factory default settings:

1. Turn Bit 8 OFF on the RS-232C Setup Switch.
2. Reset the ESTeem.
3. TYPE FA <cr>. Please note the characters may not be echoed by the crt.

ESTeem At Mainframe		ESTeem At Terminal	
-----		-----	
ADD	xxx	ADD	yyy
SETC	yyy	SETC	xxx
TERMC	ON	TERMC	ON
TERMT	10	TERMT	10
XSF	OFF	XSF	OFF
XHF	ON *	XHF	ON *
DISACK	ON *	DISACK	ON *
TRANS ON		TRANS ON	
SAVE		SAVE	
Bit 8 ON		Bit 8 ON (RS-232 Switch)	
RESET ESTeem		RESET ESTeem	

#### Notes:

- Turn DISACK ON only if you want to defeat the acknowledge packet.
- Only hardware flow control can be used in this mode.
- xxx and yyy represent an ESTeem address which is user definable from 1 to 254.

### PROGRAMMABLE LOGIC CONTROLLERS

EST has available complete Engineering Reports for each PLC manufacturer make which will be provided at no charge by calling EST Customer Support on 509-735-9092.

1  
2  
3  
4  
5  
6  
7  
8  
9  
10  
11  
12  
13  
14  
15  
16  
17  
18  
19  
20  
21  
22  
23  
24  
25  
26  
27  
28  
29  
30  
31  
32  
33  
34  
35  
36  
37  
38  
39  
40  
41  
42  
43  
44  
45  
46  
47  
48  
49  
50  
51  
52  
53  
54  
55  
56  
57  
58  
59  
60  
61  
62  
63  
64  
65  
66  
67  
68  
69  
70  
71  
72  
73  
74  
75  
76  
77  
78  
79  
80  
81  
82  
83  
84  
85  
86  
87  
88  
89  
90  
91  
92  
93  
94  
95  
96  
97  
98  
99  
100



# **CHAPTER 5**

## **RS-232C/422/485 INTERFACING**

---

**DTE VS DCE**

**FLOW CONTROL**

**MEMORY BUFFERS**

**DATA TERMINAL READY**

**RS-422/485 CONFIGURATION**

**RS-232/422/485 CONFIGURATION TABLES**

**RS-232/422/485 PORT PINOUT TABLE**

# CHAPTER 5

## RS-232C/422/485 INTERFACING

### DTE vs. DCE

The ESTeem is configured as a Data Communication Equipment (DCE) device. The following signals available at the RS-232C connector located at the rear of the unit.

	Pin		Description
DCE	1	FG	Shield Ground
	2	TXD	Transmit Data (Input)
	3	RXD	Receive Data (Output)
	4	RTS	Request To Send (Input)
	5	CTS	Clear to Send (Output)
	7	SG	Signal Ground
	8	DCD	Data Carrier Detect (Output)
	12	RTS	Request To Send (Output)
	20	DTR	Data Terminal Ready (Input)
	22	Ring	Ring Indicator (Output)

The important thing to remember is that for the ESTeem to communicate with an external device, the data output from pin 3 of the ESTeem RS-232C connector must be connected to the data input of the device you are connected to; otherwise, the ESTeem won't work. Likewise, the data input to pin 2 of the ESTeem must be connected to the data output of the device you are connected to. Normally, if the equipment you are connecting to looks like a terminal or computer (DTE), its input, Receive Data (RXD), will be on pin 3 its output, Transmit Data (TXD), will be on pin 2. Therefore, the ESTeem can be connected directly.

If the device you are connecting to is configured as a modem (DCE), its output will be on pin 3. If this configuration is connected to the ESTeem, damage may result to the ESTeem or the connecting device. In this case, you can purchase a null connector that internally reverses pins 2 and 3.

Whatever your situation may be, it is always best to check the manual on your particular device and connect accordingly.

Purchase or fabricate a RS-232C shielded cable for your ESTeem. The ESTeem requires a standard male 25 pin D connector on one end of the cable for proper connection.

Remember to install the small retaining screws on either side of the cable connector. Tightening these screws

keeps you from accidentally losing connection with your ESTeem.

#### Notes:

- *The ESTeem requires a shielded RS-232 cable. This is to prevent unwanted electrical noise from entering the ESTeem and also to prevent any electrical noise from getting out of the ESTeem.*
- *Remember – always use a shielded RS-232C cable.*
- *Pins 9, 10, 14, & 16 are used for RS-422/485 interfacing and should be left open if not used.*

### FLOW CONTROL

The ESTeem can be enabled to support SOFTWARE or HARDWARE flow control.

#### Software Flow Control

Software flow control is enabled by the XSFLOW (on/off) command in the ESTeem. When XSFLOW is ON the ESTeem will respond to <XOFF>, (stop) and <XON>, (off) commands from the RS-232 port. The factory default setting is ON. The default value for START is 17 (CTRL Q) and for STOP is 19 (CTRL S).

#### Hardware Flow Control

Hardware flow control is enabled by the XHFLOW (on/off) command in the ESTeem. The factory default value is OFF.

When XHFLOW is enabled (on) the control signal lines, Request To Send (RTS, pin 4), Data Carrier Detect (DCD, pin 8), and Clear To Send (CTS, pin 5) are available to the user at the RS-232C connector. The CTS and RTS signals are used to control the flow of data into and out of the ESTeem.

The CTS signal on pin 5 is used to control the data into the ESTeem. When CTS is set (high on pin 5) the modem is ready to receive data. When CTS is reset (low on pin 5) the ESTeem is not ready to receive data.

The RTS signal is used to control data out of the ESTeem. RTS is set (high on pin 4), by the user to indicate to the ESTeem that the user is ready to receive data. When reset, the user is not ready to receive data. (NOTE: Low = On, High = Off).

# CHAPTER 5

## RS-232C/422/485 INTERFACING

### MEMORY BUFFERS

The ESTeem has a 4000 byte buffer on the TRANSMIT SIDE (outgoing data) and a 4000 byte buffer on the RECEIVE SIDE (incoming data).

#### Transmit Buffer

The Outgoing data buffer will hold two data blocks before the ESTeem will enable its RS-232C hardware/software control on data coming into the modem if the network is busy. A data block in this example is a block of data that is defined by the PACKLENGTH or SENDPAC character which ever occurs first.

Therefore, if PACKLENGTH = 10 the modem will input a maximum of 20 bytes before it enables its hardware/software handshake line (two 10 byte packets). In another example, if PACKLENGTH = 2000 but the data block is terminated by the SENDPAC character before the input buffer reaches the full 2000 bytes, the buffer will still hold only two data blocks if the network is busy.

In order to utilize the 2000 bytes storage for small data packets (bar code readers, etc.), program the modem using the following guidelines:

```
PACKLENGTH = 2000    SENDPAC = 255
TERMC       = ON     TERMT   = 10
```

**Note:** Set the TERMT time greater than the pause between data bursts.

By programming the above parameters the ESTeem will buffer the incoming data packets and automatically transmit the data when the 2000 byte buffer is filled or the TERMT time limit is met. This will allow the customer to use two blocks of 2000 or 4000 bytes before the modem enables the respect hardware/software control.

#### Receive Buffer

If the device that the receiving ESTeem is outputting data to, enables its respective hardware or software control, the modem will store 4000 bytes of data before flow controlling off the transmitting ESTeem.

### DATA TERMINAL READY (DTR)

A software switch, DTR\_ENAB (ON/OFF) is provided in the ESTeem for monitoring the status of a device connected to pin 20 of the RS-232C connector. The factory default setting is OFF. When this command is enabled the ESTeem will monitor the DTR signal on pin 20. If the DTR line being supplied to the ESTeem, from the user, is at a SPACE (high) condition then the ESTeem is enabled. If the DTR line is at a MARK (low) condition then the ESTeem is disabled.

This signal is normally used by the ESTeem modem as an indication that connection is made to a device that is on line and ready to transmit/receive data.

### RS-422/485 CONFIGURATION

The ESTeem will support the requirements of the EIA Standard RS-422/485. This is a four (4) wire interface consisting of the TRANSMIT DATA (-), TRANSMIT DATA (+), RECEIVE DATA (-), AND RECEIVE DATA (+). These signals are available at the 25 pin RS-232C connector on the modem.

	Pin	Description
DCE	9	BTR (-) TRANSMIT DATA (-)
	10	BTR (+) TRANSMIT DATA (+)
	14	BRX (+) RECEIVE DATA (+)
	16	BRX (-) RECEIVE DATA (-)

This interface is designed to provide unipolar differential drive to twisted pair or parallel wire transmission lines.

**Note:** The ESTeem can be factory configured for 2-wire RS-485 interfacing. Call EST Customer Support on 509-735-9092.

# CHAPTER 5

## RS-232C/422/485 INTERFACING

### RS-232C/422/485 Configuration Tables

On the rear end plate of the ESTeem is an eight position switch labeled RS-232 Setup. The switch positions are defined as follows:

**RS-232C/422/485 Configuration Table**

Switch	1	2	3	Baud
	OFF	OFF	OFF	19,200
	ON	OFF	OFF	9,600
	OFF	ON	OFF	4,800
	ON	ON	OFF	2,400
	OFF	OFF	ON	1,200
	ON	OFF	ON	600
	OFF	ON	ON	300

**ESTeem RS-232C/422/485  
Port Pin-Out Table**

Pin No.	Function
1	Shield Ground
2	Transmit Data (TxD)
3	Receive Data (RxD)
4	Request To Send (RTS Input)
5	Clear To Send (CTS)
6	Data Set Ready (DSR)
7	Signal Ground
8	Data Carrier Detect (DCD)
19	Mode Control
20	Data Terminal Ready (DTR)
22	Ring Indicator (RI)
12	Request To Send (RTS Output)
9	RS-422/485 Transmit Data (-)
10	RS-422/485 Transmit Data (+)
14	RS-422/485 Receive Data (+)
16	RS-422/485 Receive Data (-)

**RS-232C/422/485 Parity/Stop Bit Configuration Table**

Switch	4	5	6	7	Data Format
	OFF	OFF	OFF	OFF	7 bit data + No parity + 1 stop
	ON	OFF	OFF	OFF	7 bit data + No parity + 2 stop
	OFF	ON	OFF	ON	7 bit data + Odd parity + 1 stop
	ON	ON	OFF	ON	7 bit data + Odd parity + 2 stop
	OFF	ON	OFF	OFF	7 bit data + Even parity + 1 stop
	ON	ON	OFF	OFF	7 bit data + Even parity + 2 stop
	OFF	OFF	ON	OFF	8 bit data + No parity + 1 stop
	ON	OFF	ON	OFF	8 bit data + No parity + 2 stop
	OFF	ON	ON	ON	8 bit data + Odd parity + 1 stop
	ON	ON	ON	ON	8 bit data + Odd parity + 2 stop
	OFF	ON	ON	OFF	8 bit data + Even parity + 1 stop
	ON	ON	ON	OFF	8 bit data + Even parity + 2 stop

# **CHAPTER 6 ANTENNAS**

---

**COAXIAL CABLES**

**WEATHER PROOFING COAXIAL CONNECTORS**

**GROUNDING**

**LIGHTNING ARRESTORS**

**REFERENCE MATERIAL**

**MODEL 192 TYPICAL OUTDOOR ANTENNA INSTALLATION  
BLOCK DIAGRAMS**

**MODEL 192 TYPICAL INDOOR & MOBILE ANTENNA  
INSTALLATION BLOCK DIAGRAMS**

**ESTEEM SWR MEASUREMENT BLOCK DIAGRAM**

# CHAPTER 6

## ANTENNAS

EST offers different types of antennas ranging from 1/4 wave to 5/8 wave in physical size. The user choice is dependent on the application.

Communications in the VHF and UHF bands are normally over "Line of Sight (LOS)". Looking from the antenna of one wireless modem you must be able to see the antenna of the wireless modem you wish to communicate with. If a large object obstructs the line of sight view it is unlikely that satisfactory communications will result. This means you must relocate the antennas or use the REPEATER FEATURE and a second modem to go over or around the object.

The United States Federal Communications Commission (FCC) specifies that the antenna type used on the ESTeem Model 192V be limited to one-half wave vertically polarized omni-direction in design. This limits the overall gain of the antenna to a maximum of approximately 3 dB.

The Model 192C/F/M products are allowed by the FCC to use high gain directional antennas.

It is noted that a 1/4 wave antenna that does not have ground plane radials requires a ground plane to operate at maximum efficiency. This can simply be a conducting surface under the antenna that is a 1/4 wave length in diameter. For the Model 192V this is approximately 42 inches. A conducting surface can be anything from the roof top of an automobile to a file cabinet.

### COAXIAL CABLES

To minimize signal loss, the overall length of the coaxial cable should be as short as possible. To avoid corrosion select coaxial cable manufacturers with tinned copper braid, where possible. Listed below are representative cable losses in db/100ft at the VHF and UHF frequencies:

Frequency (MHz)	RG-58u	RG-8	1/2" Helix
72-79	- 3.8	- 1.5	- 0.6
150-174	- 5.2	- 2.3	- .845
402-420	-10.0	- 4.2	- 1.5
450-470	-10.8	- 4.4	- 1.5

In a severe noise environment it may be desirable to use a double shield type of coax cable such as RG-214/U.

**Note:** Pre-made coax cables can be purchased from the factory. A -3 dB loss means you have lost 1/2 of your signal. A +3 dB gain means you have doubled (x2) your signal.

Keep the antenna feedline as short as possible to minimize losses.

Extreme care must be taken when attaching coax connectors to the antenna feedlines. If there is any error in making this connection the output of the transmitter will be greatly reduced.

### WEATHER PROOFING COAX CONNECTIONS

1. Coat the threads of the connectors with silicone lubricant prior to assembly (See Note 1) and hand tighten. Care should be taken not to get any lubricant on the center conductor.
2. Wrap the connector assembly with a vapor barrier patch for weather proofing (See Note 2), ensuring to overlap onto the coax cable approximately 1 1/2 inches.
3. Apply an electrical coating (sealing agent) over the vapor barrier patch for added protection (See Note 3).

#### Notes:

1. Dow Corning RTV-3140 or equivalent.
2. Suggested vendors:

VAPOR-WRAP  
Decibel Products  
3184 Quebec St.  
Dallas, TX 75356  
214-631-0310

VYNIL-MASTIC, P/N 2200  
3-M Company  
Customer Service  
512-984-1800

3. SCOTCHKOTE, 3-M Company, or equivalent.

# CHAPTER 6

# ANTENNAS

---

## GROUNDING

All building mount antennas require attachment to a good earth ground for optimum efficiency. Contact a reputable local communications shop for procedures for your area.

## LIGHTNING ARRESTORS

Lightning arrestors should be used on all external building mount antennas for personal protection and to minimize damage to the transceiver during lightning storms. The units should be installed as per manufacturers instructions provided with the device.

## REFERENCE MATERIAL

The ideal reference book for antennas and transmission lines is the "The Radio Amateur's Handbook", by the Headquarters Staff of the American Radio Relay League.

# CHAPTER 6 ANTENNAS

## Model 192V Typical Outdoor Antenna Installation Diagram

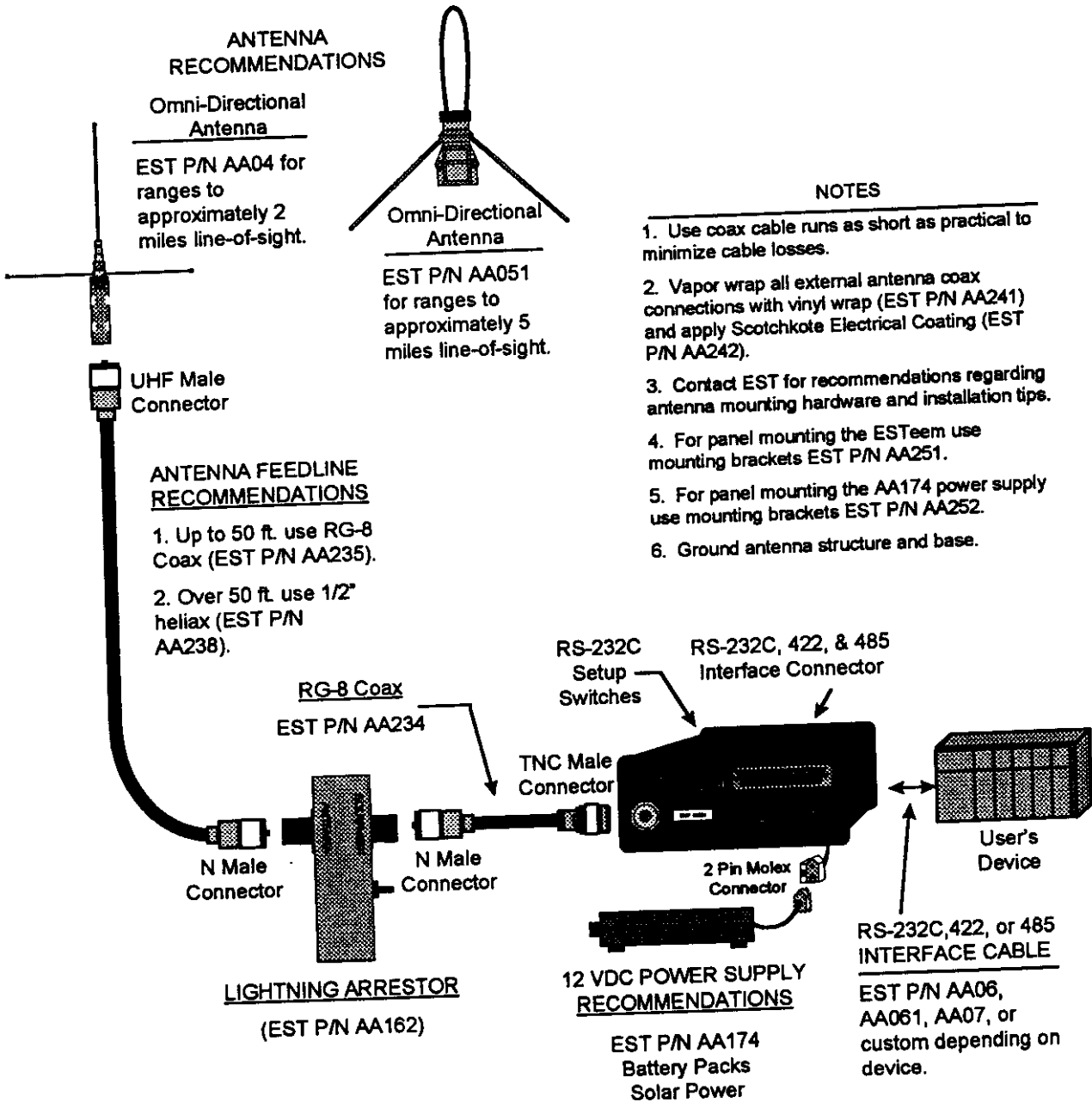



# CHAPTER 6

## ANTENNAS

### Models 192M

## Outdoor Fixed Base Site

### Diagram

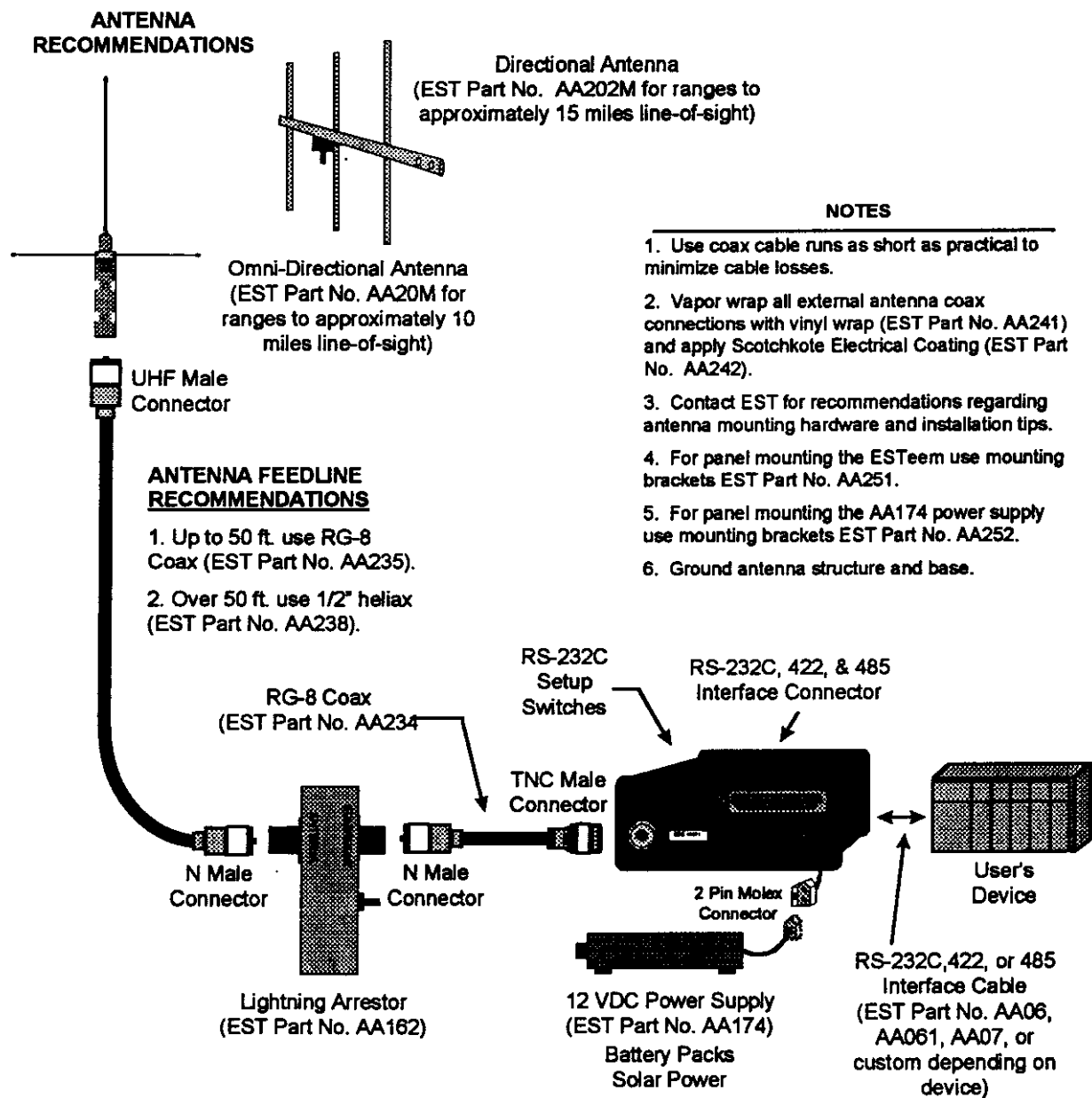

# CHAPTER 6 ANTENNAS

## Models 192C and 192F Typical Outdoor Antenna Installation Diagram

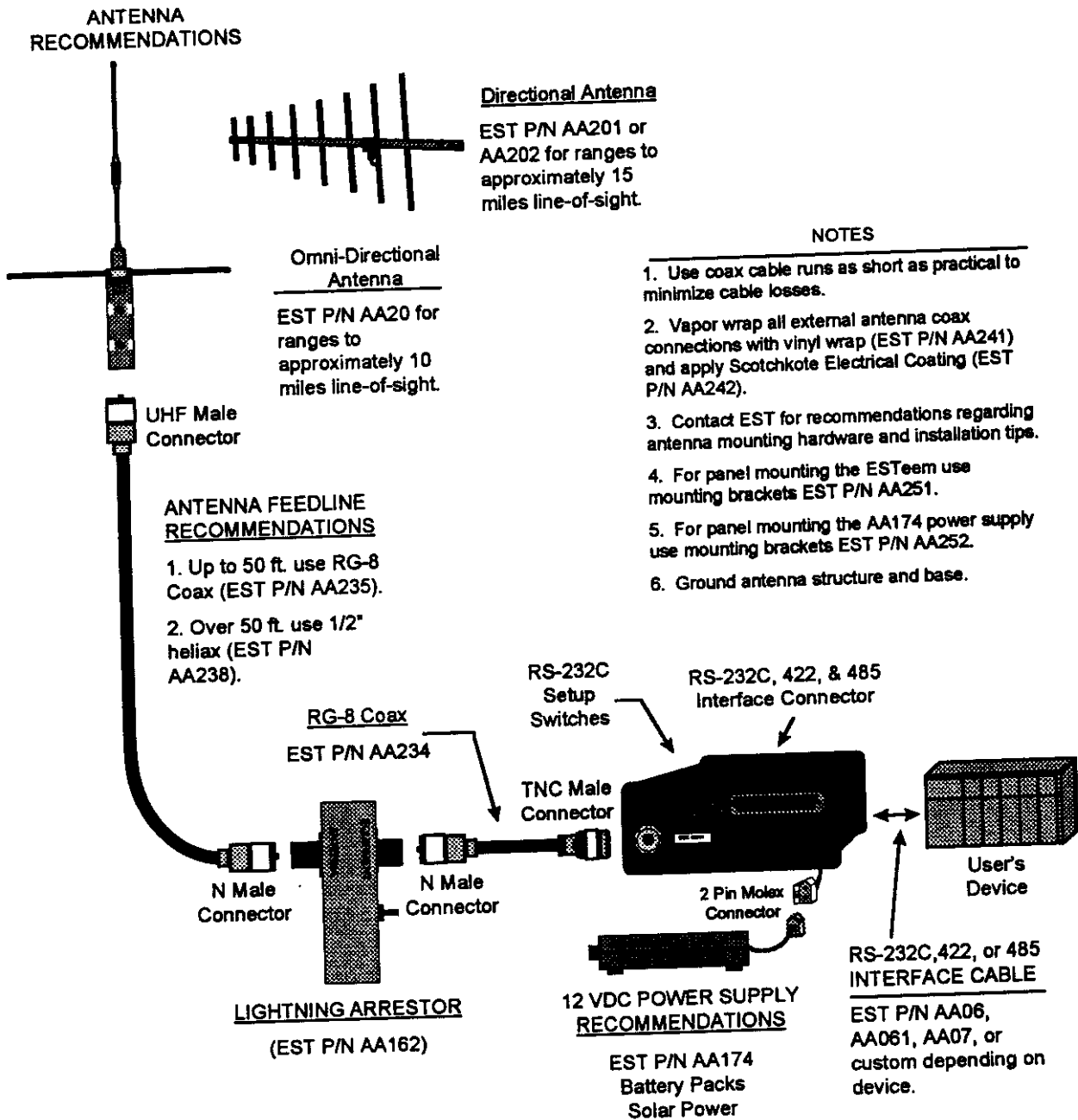

# CHAPTER 6 ANTENNAS

## Model 192V Typical Indoor & Mobile Antenna Installation Diagram

### ANTENNA RECOMMENDATIONS

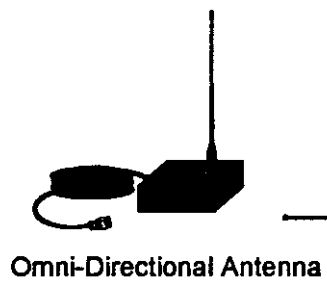

Magnetic Mount. EST P/N AA03 with 42 in. vertical radial or P/N AA15 with 17 in. rubber duck radial.

**Note:** RG-8 feedline is not required. Magnetic mount antennas have approximately 12 ft. of integral RG-58 cable for direct connection to ESTeem.

### ANTENNA FEEDLINE RECOMMENDATIONS

1. Up to 50 ft. use RG-8 Coax (EST P/N AA233).
2. Over 50 ft. call EST.

### Omni-Directional Antenna

Permanent Mount. EST P/N AA04 with 42 in. vertical radial or P/N AA041 with 18 in. vertical radial.

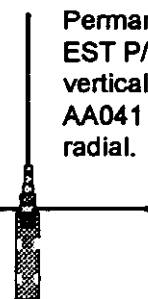

UHF Male Connector



TNC Male Connector

RS-232C Setup Switches

RS-232C, 422, & 485 Interface Connector

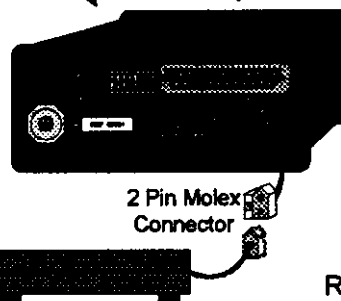

2 Pin Molex Connector

### 12 VDC POWER SUPPLY RECOMMENDATIONS

EST P/N AA174 Battery Packs

### NOTES

1. Use coax cable runs as short as practical to minimize cable losses.
2. Vapor wrap all external antenna coax connections with vinyl wrap (EST P/N AA241) and apply Scotchkote Electrical Coating (EST P/N AA242).
3. Contact EST for recommendations regarding antenna mounting hardware and installation tips.
4. For panel mounting the ESTeem use mounting brackets EST P/N AA251.
5. For panel mounting the AA174 power supply use mounting brackets EST P/N AA252.
6. Ground antenna structure and base.



User's Device

### RS-232C, 422, or 485 INTERFACE CABLE

EST P/N AA06, AA061, AA07, or custom depending on device.

# CHAPTER 6 ANTENNAS

## Models 192M Typical Indoor & Mobile Equipment Diagram

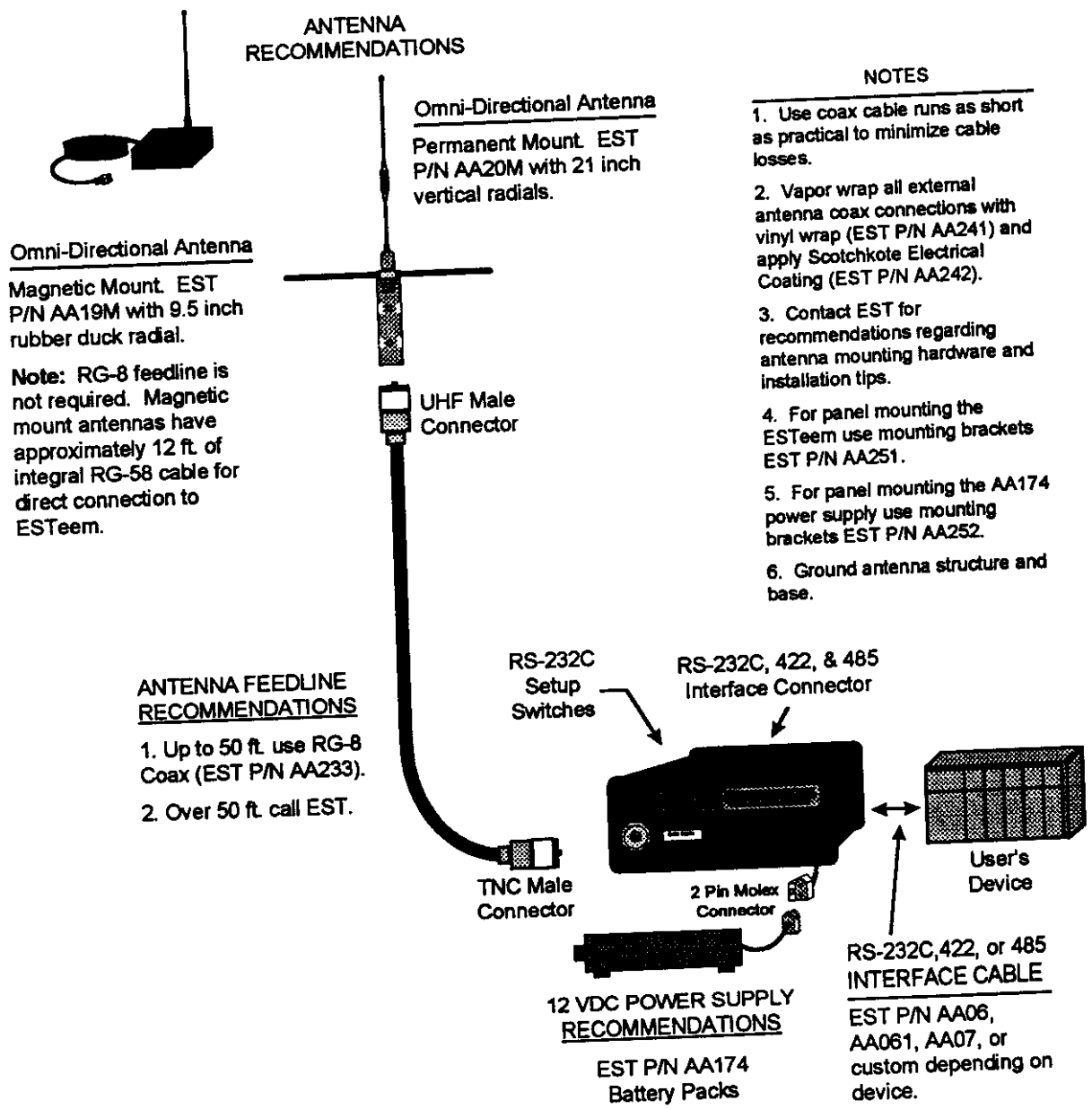

# CHAPTER 6 ANTENNAS

## Model 192C and 192F Typical Indoor & Mobile Antenna Installation Diagram

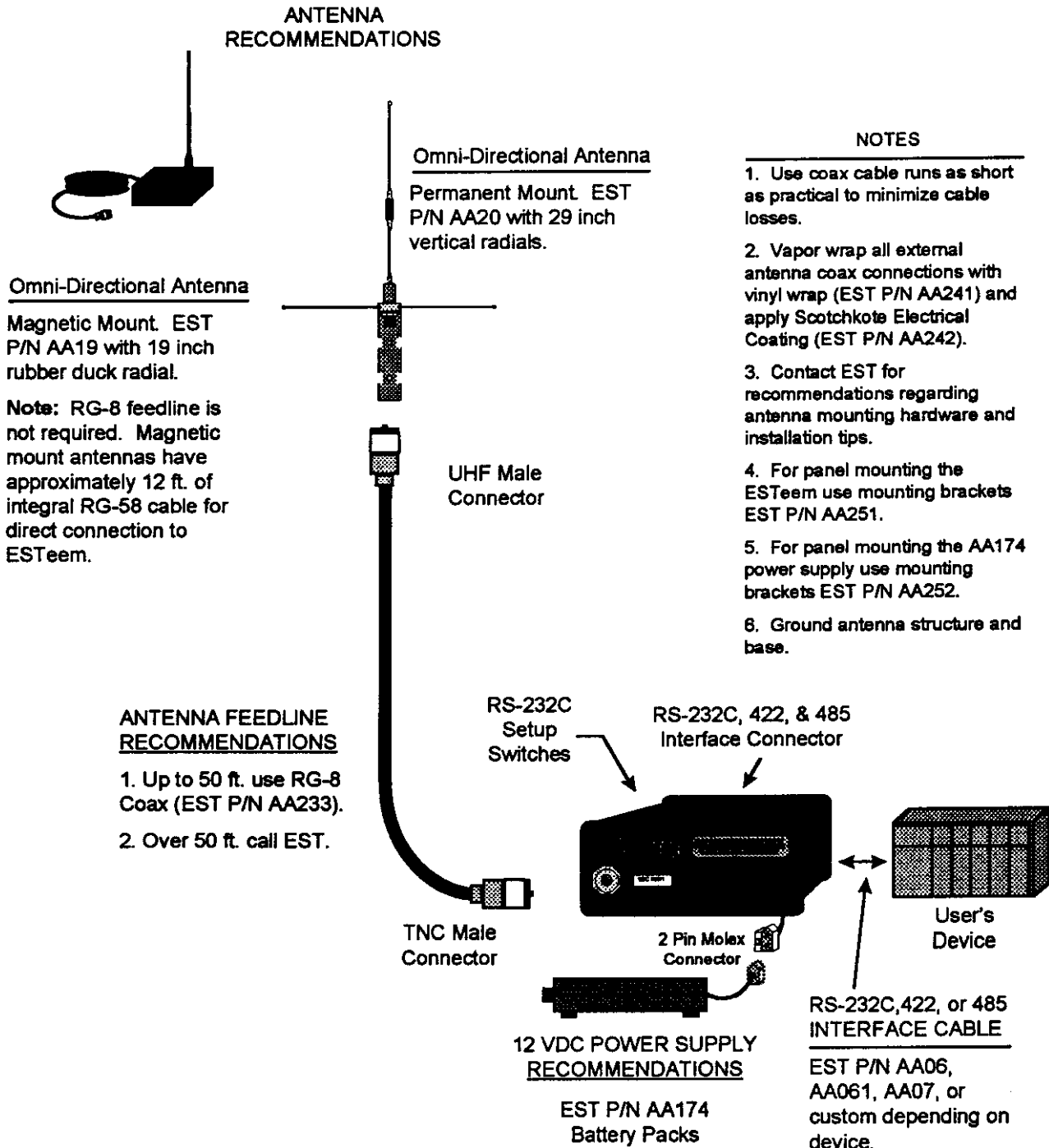

# CHAPTER 6 ANTENNAS

## ESTeem SWR Measurement Block Diagram

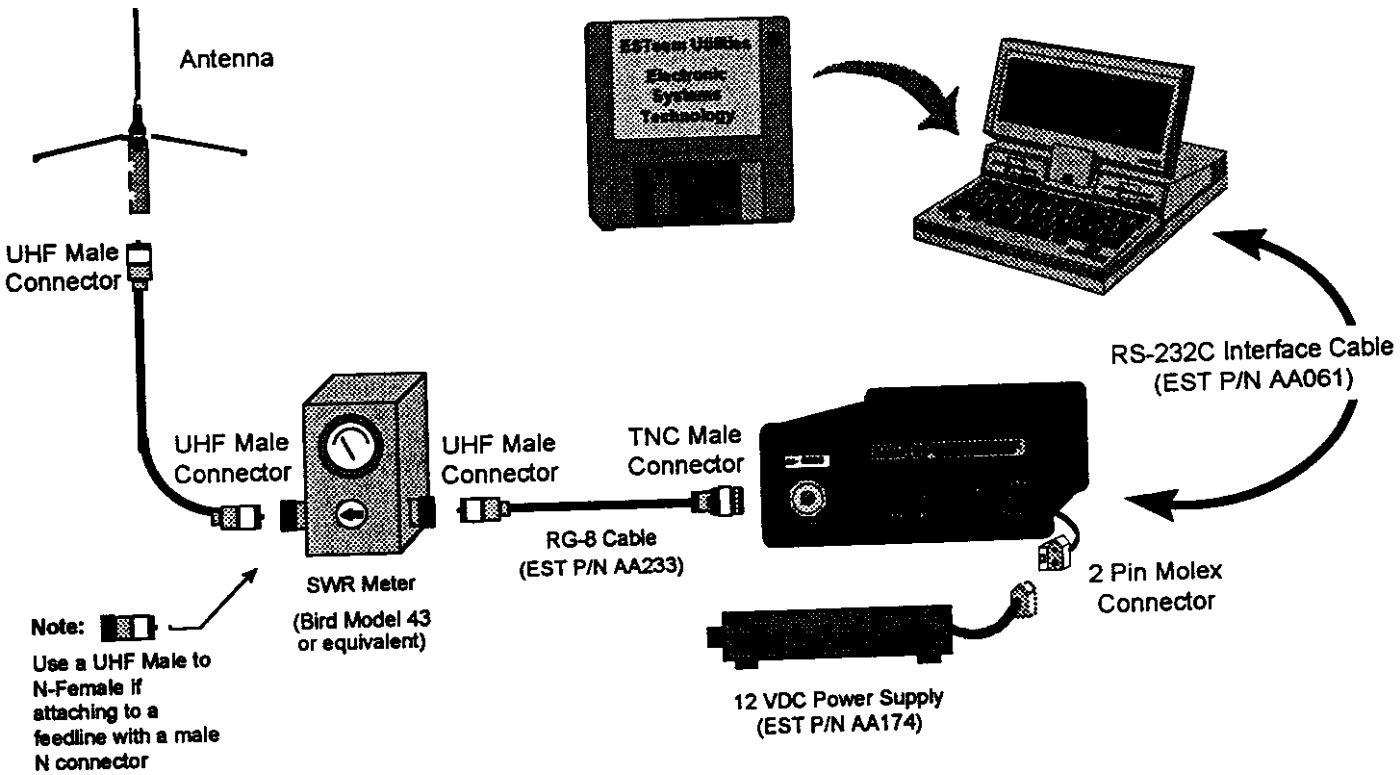

### Programming The ESTeem For SWR Measurements

1. Configure the hardware as per the above diagram.
2. Turn Switch 8 on the RS-232 Setup Switch (located on the rear of the ESTeem) to the OFF position.
3. Reset the ESTeem (front panel switch).
4. Install the ESTeem Utility on the PC hard drive as per instructions with the software.
5. From Utility Main Menu (Figure 1) select the Terminal Emulation Mode.
6. In the Terminal Emulation Mode type the following commands followed by a RETURN.



WIRELESS MODEM COMMAND CENTER

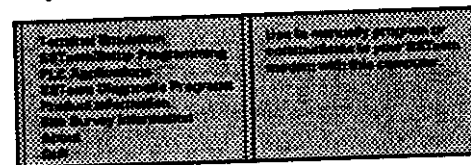

Figure 1: ESTeem Utility Main Menu

FA            Return  
RAD   ON    Return

This returns the unit to factory default parameters.  
Enable the RADIO ON command. The transmitter will alternate ON for 10 seconds and OFF for 3 seconds.

7. When the testing is completed, type the following:

RAD   OFF   Return

This disables the RADIO ON command.

# **CHAPTER 7**

## **THEORY OF OPERATION**

---

**INTRODUCTION**

**ESTEEM HOW IT WORKS**

**SPECTRUM UTILIZATION**

**PACKET PROTOCOLS**

**FLOW CONTROL**

**DATA PRIVACY**

**EFFECTIVE BAUD RATE**

# CHAPTER 7

## THEORY OF OPERATION

### INTRODUCTION

ESTeem wireless modem products provide a "Wireless Solution" by eliminating conventional hardwiring of leased phone lines.

All of the ESTeem models come with the industry standard RS-232C, RS-422, and RS-485 asynchronous communications ports to give the user a new dimension to "Local Area Networking".

Our packet burst, frequency agile communications products allow the user to create a "Radio Area Network" of up to 255 users on a single frequency. The packet burst communications technique was chosen to give the system very high data integrity in high noise industrial environments. The ESTeem incorporates a method of error checking that provides received data accuracy of greater than one part in 100 million.

Internal Digi-Repeater features allow the user to increase operating range by relaying transmission through a maximum of three ESTeems to reach the destination ESTeem. An ESTeem can operate as an operating node, a repeater node, or both simultaneously for added flexibility.

"Private Data Communications" is provided by the use of an interleaving technique of the modulated data, user definable commands for unit addressing, network addressing, and security lock-out of software programming. If higher security is required, the ESTeem is compatible with asynchronous Data Encryption Standard (DES) encryption devices.

The ESTeem has programmable software commands to allow the user to easily configure the unit for any application or mission. The ESTeem setup parameters are saved in its own non-volatile memory.

When you buy ESTeem products you are getting equipment designed by the company that holds the United States and Canadian patent for the wireless modem. We are proud to say that we design, develop and manufacture our products in the United States. Each ESTeem is subjected to a rigorous quality control bench test before shipping to insure our customers have out-of-the-package reliability. We also have a dedicated Customer Support Staff, Field Engineering Services and Factory Training classes to make sure that your application problem are solved.

### HOW IT WORKS

Now, as you can probably guess, the ESTeem is a sophisticated piece of technology, however the concept is easy to comprehend if you understand packet radio.

All packet systems, whether hardwired or radio, share the same principle of operation; data is taken from your standard RS-232C, RS-422, or RS-485 asynchronous port and is transmitted in "Blocks". Think of this block as an "Electronic Envelope" that we call a packet. The size of the packet can be defined by the user from 1 to 2000 bytes of information. Reducing the size of the packet allows the ESTeem to operate better in high EMF noise environments, because by reducing the packet size you reduce transmission exposure time on the radio waves thereby increasing your probability of a successful transmission.

Once this packet of data is formed, its transmitted in a "burst," one ESTeem to another, hence the term "packet burst communications". Now, if more than one packet is required to send the data then the ESTeem goes into full automatic mode and transmits additional packets.

Before an ESTeem transmits its packet it listens to ensure that the air waves are clear before transmitting. This listen before transmit scheme is called "carrier sensed multiple access," or CSMA.

When a "packet" has been transmitted, every modem in radio range on the same frequency hears it. To design a modem to communicate with a network of modems it has to be "address specific" so only the modem you want to talk to accepts your information. It's like yelling into a crowd of 255 people but you want only the persons name you called to acknowledge (ACK). Well, very simply, that's how the ESTeem works. Once the address you're calling receives your packet, it's checked for accuracy.

Accuracy is probably the single most important part of any communication device. The ESTeem uses Forward Error Correction (FEC) and a 32 bit Cyclic Redundancy Check (CRC) which is a very sophisticated method of checking the data integrity of the packet once its been received. The CRC insures data integrity greater than one part in one hundred million. Once the CRC is completed on the received packet, the data is outputted to the user and a positive acknowledgment (ACK) is transmitted back to the sender.



# CHAPTER 7

## THEORY OF OPERATION

It's safe to assume that the data you receive is good data or you get nothing at all using the CRC technique. If no ACK is returned after a given delay, the sender assumes the packet was not received and "retries" the transmission. The number of retries are user definable from 1 to 255, allowing the unit to automatically retry sending the packet.

### SPECTRUM UTILIZATION

The ESTeem uses a "listen before transmit" or Carrier Sensed Multiple Access (CSMA) scheme. This means only one unit in a network is allowed to transmit at a time. By fixing each user's communication window and allowing the computer in the ESTeem to be the Air Traffic Controller, many individual users can share one frequency. The ESTeem firmware can support up to 255 ESTeems on a single channel or frequency. For example in the United States there are 1600 frequencies (12.5 KHz channel spacing) in UHF, giving a network density of greater than 408,000 users in a given cell or geographical area. Once you are out of radio range, you can construct another cell of users.

The CSMA technique is a very efficient way to manage your network of ESTeems and prevent communication bottlenecks. In addition, an anti-collision software scheme is used to recover data if two or more units transmit at exactly the same time. When this feature is added the technical term for this technique is now called CSMA-CD (collision detection).

By using this communications technique only one frequency channel is needed with a very narrow bandwidth (this is called narrow band FM modulation) thereby saving valuable radio spectrum space.

### PACKET PROTOCOLS

By using CSMA no polling station or token is required in the ESTeem network. When an ESTeem has information to send it will check to see if the channel is clear before transmitting its packet and await an (ACK). The ESTeem is a Master/Master system, meaning any ESTeem can communicate with any other ESTeem.

### FLOW CONTROL

The ESTeem supports hardware and software flow control, which allow different devices on the network to

communicate at different baud rates. In addition to flow control the ESTeem also has a 4000 byte data buffer on both the receive and transmit buffers in the unit.

### DATA PRIVACY

Data privacy in the ESTeem is provided by three levels of data encoding in the firmware and by the user being able to define over four security and communications parameters (Unit Address, Network ID, and Operating Frequency) that allow communications access to the modem giving over 100 million combinations. If higher security is required, the units are compatible with asynchronous Data Encryption Standard (DES) encryption peripherals.

### EFFECTIVE BAUD RATE

The maximum input baud rate to the modem is 19,200 baud, asynchronous, full duplex, but this is misleading since the ESTeems actually communicate to each simplex over the RF link, at 19,200 bps (25 KHz channel spacing - Model 192C/F or 20 KHz channel spacing - Model 192V) or 9,600 bps (12.5 KHz channel spacing - Model 192C/F). The effective baud rate is a function of the above plus the packet length variable in the ESTeem (definable from 1 to 2000 bytes). If the packlength variable is set to 2000 bytes the effective baud rate is approximately 18,000 baud (25 KHz channel spacing) or 9,000 baud (12.5 KHz channel spacing) the effective baud rate will degrade as the packlength variable is reduced.

Another item that must be understood is transmission turn around time. Remember, the ESTeem sends a data packet and waits for an (ACK) from the destination modem before another packet is transmitted. All radio transmitters have a fixed delay time, this is the amount of time it takes the transmitter to stabilize once it is energized before it can send data. In the ESTeem the delay is approximately 15 milliseconds *one way* which includes transmitter turn-on time and packet frame overhead or a total turn around time accounting for the (ACK) of 30 milliseconds. Therefore total time to send a data packet is 30 milliseconds plus the time required to send the data (i.e. number of bits sent/19,200 b/s).



# **APPENDICES**

---

## **APPENDIX “A” FCC INFORMATION (USA Only)**

## **APPENDIX “B” SPECIFICATIONS**

**ESTeem Specifications**

**Antenna Specifications**

## **APPENDIX “C” TABLES/DIAGRAMS**

**ESTeem Command Error Message Table**

**ESTeem System Status Message Table**

**ESTeem System Error Message Table**

## **APPENDIX “D” ESTEEM SOFTWARE COMMANDS**

**Factory Default Settings**

**Definitions**

# APPENDIX A

## FCC LICENSING

### INFORMATION TO USERS

**WARNING:** This equipment has been tested and found to comply with the limits for a Class A digital device, pursuant to Part 15 of the FCC Rules. These limits are designed to provide reasonable protection against harmful interference when the equipment is operated in a commercial environment. This equipment generated, uses, and can radiate radio frequency energy and, if not installed and used in accordance with the instruction manual, may cause harmful interference to radio communications. Operation of this equipment in a residential area is likely to cause harmful interference in which case the user will be required to correct the interference at his own expense.

To insure compliance to FCC non-interference regulations, peripherals attached to this modem require shielded I/O cables.

If this equipment does cause interference to radio or television, which can be determined by turning the equipment off and on, the user is encouraged to try to correct the interference by one or more of the following measures:

1. Re-orient the radio/TV receiving antenna.
2. Re-orient the modem antenna.
3. Relocate the modem with respect to the radio/TV receiving antenna.
4. Plug the power supply for the modem into a different outlet so that the modem and radio/TV receiver are on different branch circuits.
5. Verify that the modem chassis is connected to an earth ground.
6. Attach a split bead (FAIR-RITE PN 2643164251) to the RS-232 cable.

If necessary, the user should consult the dealer or an experienced radio/TV technician for additional suggestions. The user may find the following booklet prepared by the FCC helpful.

"How to Identify and Resolve Radio-TV Interference Problems"

This booklet is available from the U.S. Government Printing Office, Washington, D.C. 20402 - Stock No. 004-000-00245-4. Application forms for the license are available from the nearest office of the FCC.

Electronic Systems Technology maintains a list of consultants that provide professional services at a reasonable cost to assist the users in licensing.

### Other Information

#### Model 192C

25 KHz Channel Spacing, 19,200 bps  
FCC Type Acceptance No: ENPESTEEM192  
Emissions Designator: 17K6F1D

12.5 KHz Channel Spacing, 9,600 bps  
FCC Type Acceptance No: ENPESTEEM192A  
Emissions Designator: 10K8F1D

12.5 KHz Channel Spacing, 19,200 bps  
Industry Canada Type Acceptance No: 2163 195 214A  
Emissions Designator: 10K0F2D

#### Model 192F

25 KHz Channel Spacing, 19,200 bps  
Industry Canada Type Acceptance No: 2163 195 214A  
Emissions Designator: 17K6F1D

12.5 KHz Channel Spacing, 9,600 bps  
Industry Canada Type Acceptance No: 2163 195 214A  
Emissions Designator: 10K8F1D

25 KHz Channel Spacing, 19,200 bps  
Malaysia Telecom No: RADL 60A 1097 S  
Emissions Designator: 17K6F1D

#### Model 192V

20 KHz Channel Spacing, 19,200 bps  
FCC Type Acceptance No: ENPESTEEM192V  
Emissions Designator: 17K6F1D

20 KHz Channel Spacing, 19,200 bps  
Industry Canada Type Acceptance No: 2163 195 308A  
Emissions Designator: 17K6F1D

# APPENDIX A

## FCC LICENSING

---

### Model 192M

25 kHz Channel Spacing, 19,200 bps  
U.S.A. Type Acceptance: ENPESTEEM192M  
Emission Designator: 17K6F1D

12.5 kHz Channel Spacing, 9,600 bps  
U.S.A. Type Acceptance: ENPESTEEM192M  
Emission Designator: 10K8F1D

25 kHz Channel Spacing, 19,200 bps  
Canada: TBD  
Emission Designator: 17K6F1D

12.5 kHz Channel Spacing, 9,600 bps  
Canada: TBD  
Emission Designator: 10K8F1D

# APPENDIX A FCC LICENSING

## FEDERAL COMMUNICATIONS COMMISSION FIELD OFFICES

### ALASKA

1011 E. Tudor Rd.  
Rm 240 Box 2955  
Anchorage, AK 99510

### CALIFORNIA

7840 El Cajon Blvd  
Suite 405  
La Mesa, CA 92041

3711 Long Beach Blvd  
Suite 501  
Long Beach, CA 90807

323A Battery St  
San Francisco, CA 94111

### COLORADO

Executive Tower  
1405 Curtis St  
Suite 2925  
Denver, CO 80202

### FLORIDA

919 Federal Bldg  
51 SE First Ave.  
Miami, FL 33130

1211 N. Westshore  
Suite 601  
A.D. P. Building  
Tampa, FL 33607

### GEORGIA

Massell Bldg. 440  
1365 Peachtree NE  
Atlanta, GA 30309

### HAWAII

7304 Prince Kuhi  
Federal Building  
Honolulu, HI

### HAWAII

300 Almoana Blvd.  
P.O. Box 50023  
Honolulu, HI

### ILLINOIS

3935 Federal Bldg  
230 S. Dearborn  
Chicago, IL 60604

### LOUISIANA

1009 Edw Hebert Bldg.  
600 South Street  
New Orleans, LA 70130

### MARYLAND

1017 Geo. Fallon  
Building 31  
Hopkins Plaza  
Baltimore, MD

### MASSACHUSETTS

1600 Customhouse  
165 State Street  
Boston, MA 02109

### MICHIGAN

1054 Federal Building  
231 W LaFayette  
Detroit, MI 48225

### MINNESOTA

691 Federal Building  
316 N Robert St.  
St. Paul, MN

### MISSOURI

Brywood Office Tower  
6800 E. 63rd Street  
Kansas City, MO

### NEW YORK

1307 Federal Building  
111 W. Huron  
Buffalo, NY 14202

201 Varick Street  
New York, NY 10014

### OREGON

1782 Federal Building  
1220 SW 3rd Avenue  
Portland, OR 97204

### PENNSYLVANIA

Room 404  
2300 E. Lincoln H  
Langhorne, PA

### PUERTO RICO

747 Federal Building  
Carlo Chardon Ave.  
Hato Rey, PR 00918

### TEXAS

Cabeli Building  
1100 Commerce  
Dallas, TX 75242

5636 Federal Building  
515 Rusk Avenue  
Houston, TX 77002

### VIRGINIA

Military Circle  
870 N. Military Hwy.  
Norfolk, VA 23502

### WASHINGTON

3256 Federal Building  
915 Second Avenue  
Seattle, WA 98174

# APPENDIX B SPECIFICATIONS

## ESTeem General Specifications

### POWER SWITCH:

- Off/On/Reset
- RS-232C/422/485 Setup

### LED INDICATORS:

- Power On
- Receiver Carrier Detect
- Transmitter Enable
- Link Connect/Disconnect
- Auto Connect Enabled
- RS-232C/422/485 Framing Error.

### I/O - CONNECTORS:

- Asynchronous Full Duplex, RS-232C, RS-422 and RS 485 with 25 Pin Sub D Connector.
- RJ 11 Phone Interface (Optional)
- Antenna Output - TNC connector
- Input Power - 2 pin molex

### ADDRESSING RANGE:

- 1 to 255

### DATA INPUTS:

- Selectable 600 to 19,200 baud
- 7 to 8 data bits
- Even, odd, or no parity
- One or two stop bits

### DATA BUFFERS:

- Transmit 4000 bytes
- Receive 4000 bytes

### FLOW CONTROL:

- Hardware or Software

### DATA TRANSMISSION PROTOCOL:

- Carrier Sensed Multiple Access with Collision Detection (CSMA-CD)

### ERROR CHECKING:

Forward error correction and 32 Bit Cyclic Redundancy Check (CRC) with packet acknowledge and retry

### MINIMUM RADIO TURN AROUND TIME:

- < 15 MS + Data (W/O ACK)
- < 30 MS + Data (W/ACK)

### POWER REQUIREMENTS:

#### Models 192C & 192F

- 11 TO 15 vdc @ 750 ma Rx  
2 W RF      2 A Tx  
4 W RF      3 A Tx

#### Model 192M

- 12 to 15 VDC @ 750 ma Rx  
2 W RF      1.6 A Tx  
4 W RF      2 A Tx

#### Model 192V

- 11 to 15 VDC @ 490 ma Rx  
850 ma Tx

### SIZE:

- 2 ¼ in. Height
- 5 ¼ in. Width
- 10 ¼ in. Length

### WEIGHT:

- 3.2 lbs.

### ENVIRONMENT:

- -30 TO 50 ° C.
- 95% non-condensing

### WARRANTY:

- 1 Year

# APPENDIX B SPECIFICATIONS

## ESTeem Transceiver Specifications

### ESTeem Model 192C

### ESTeem Model 192F

Frequency Range	450 to 470 MHz
Frequency Selection	Digitally Synthesized - Software Selectable
Frequency Stability	+/- 1 ppm
Frequency Selectability	6.25KHz
RF Data Rate	19,200 bps @ 25 KHz Channel Spacing U.S.A. Type Acceptance: ENPESTEEM192 Emission Designator: 17K6F1D  9,600 bps @ 12.5 KHz Channel Spacing U.S.A. Type Acceptance: ENPESTEEM192A Emission Designator: 10K8F1D  19,200 bps @ 12.5 KHz Channel Spacing Canada: 2163 195 214A Emission Designator: 10K0F2D
Transmitter Modulation	DC to 4800 Hz @ 19,200 bps DC to 2400 Hz @ 9,600 bps
Transmitter Deviation	4 KHz @ 19,200 bps 3 KHz @ 9,600 bps
Transmitter RF Power Output	2 Watts (4 Watts optional)
Transmitter Duty Cycle	100%
Transmitter Spurious & Harmonics	> 55 dB down from carrier
Transmitter Rise Time	1 msec
Transmitter FM Hum & Noise	> 50 dB down from carrier
Receiver Sensitivity:	-101 dBm
Receiver Spurious & Image Rejection	> 50 dB
Receiver Squelch Sensitivity	Adjustable - Four Levels
Receiver Adjacent Channel Rejection	> 70 dB
Receiver Modulation Acceptance:	25 KHz
Receiver Base Bandwidth:	4.8 KHz
Transmit/Receive Switch	Integral to Unit
RF Output Impedance	50 Ohms
RF Input/Output Connector	TNC Female
Power Supply Voltage	12 to 15 VDC
Power Supply Current @ 12 VDC	750 ma Receive 2 A Transmit (2 W RF Output) 3 A Transmit (4 W RF Output)
Input Power Connector	2 Pin Molex (male)
Temperature Range	-30 to + 50 ° C.
Size	2 ¼ in. H x 5 ¼ in. W x 10 ¼ in. L.
Weight	3.2 lbs.

400 to 420 MHz
Digitally Synthesized - Software Selectable
+/- 1 ppm
6.25KHz
19,200 bps @ 25 KHz Channel Spacing Canada: 2163 195 214A Emission Designator: 17K6F1D
9,600 bps @ 12.5 KHz Channel Spacing Canada: 2163 195 214A Emission Designator: 10K0F2D
DC to 4800 Hz @ 19,200 bps
DC to 2400 Hz @ 9,600 bps
4 KHz @ 19,200 bps
3 KHz @ 9,600 bps
4 Watts (2 Watts optional)
100%
> 55 dB down from carrier
1 msec
> 50 dB down from carrier
-101 dBm
> 50 dB
Adjustable - Four Levels
> 70 dB
25 KHz
4.8 KHz
Integral to Unit
50 Ohms
TNC Female
12 to 15 VDC
750 ma Receive 2 A Transmit (2 W RF Output) 3 A Transmit (4 W RF Output)
2 Pin Molex (male)
-30 to + 50 ° C.
2 ¼ in. H x 5 ¼ in. W x 10 ¼ in. L.
3.2 lbs.



# APPENDIX B SPECIFICATIONS

## ESTeem Transceiver Specifications

### ESTeem Model 192M

Frequency Range	150 to 174 MHz
Frequency Selection	Digitally Synthesized - Software Selectable
Frequency Stability	+/- 2.5 ppm
Frequency Selectability	12.5 kHz
RF Data Rate	19,200 bps @ 25 kHz Channel Spacing U.S.A. Type Acceptance: ENPESTEEM192M Emission Designator: 17K6F1D  9,600 bps @ 12.5 kHz Channel Spacing U.S.A. Type Acceptance: ENPESTEEM192M Emission Designator: 10K8F1D  19,200 bps @ 25 kHz Channel Spacing Canada: TBD Emission Designator: 17K6F1D  9,600 bps @ 12.5 kHz Channel Spacing Canada: TBD Emission Designator: 10K8F1D
Transmitter Modulation	DC to 4800 Hz @ 19,200 bps DC to 2400 Hz @ 9,600 bps
Transmitter Deviation	4 kHz @ 19,200 bps 3 kHz @ 9,600 bps
Transmitter RF Power Output	2 Watts (4 Watts optional)
Transmitter Duty Cycle	100%
Transmitter Spurious & Harmonics	> 55 dB down from carrier
Transmitter Rise Time	1 msec
Transmitter FM Hum & Noise	> 50 dB down from carrier
Receiver Sensitivity:	-101 dBm
Receiver Spurious & Image Rejection	> 50 dB
Receiver Squeich Sensitivity	Adjustable - Four Levels
Receiver Adjacent Channel Rejection	> 70 dB
Receiver Modulation Acceptance:	25 kHz
Receiver Base Bandwidth:	4.8 kHz
Transmit/Receive Switch	Integral to Unit
RF Output Impedance	50 Ohms
RF Input/Output Connector	TNC Female
Power Supply Voltage	12 to 15 VDC
Power Supply Current @ 12 VDC	750 ma Receive 1.6 A Transmit (2 W RF Output) 2.0 A Transmit (4 W RF Output)
Input Power Connector	2 Pin Molex (male)
Temperature Range	-30 to + 50 ° C.
Size	2 ¼ in. H x 5 ½ in. W x 10 ¼ in. L.
Weight	3.2 lbs.

### ESTeem Model 192V

72 to 73 MHz 74 to 76 MHz ( custom)
Digitally Synthesized - Software Selectable
+/- 50 ppm
20 KHz 12.5 KHz (custom)
19,200 bps @ 20 KHz Channel Spacing U.S.A. Type Acceptance: ENPESTEEM192V Emission Designator: 17K6F1D
19,200 bps @ 20 KHz Channel Spacing Canada: TBD Emission Designator: 17K6F1D
DC to 4800 Hz @ 19,200 bps DC to 2400 Hz @ 9,600 bps
4 KHz @ 19,200 bps 3 KHz @ 9,600 bps
1 Watts
100%
> 55 dB down from carrier
1 msec
> 50 dB down from carrier
-101 dBm
> 50 dB
Adjustable - Four Levels
> 70 dB
25 KHz
4.8 KHz
Integral to Unit
50 Ohms
TNC Female
12 to 15 VDC
490 ma Receive 850 ma Transmit
2 Pin Molex (male)
-30 to + 50 ° C.
2 ¼ in. H x 5 ½ in. W x 10 ¼ in. L.
3.2 lbs.

# APPENDIX B SPECIFICATIONS

## Model 192C & F Antennas

**Model No:** AA19C & AA19F  
**Antenna Type:** Omni-Directional, 1/2 Wave  
**Applications:** Mobile Mount.  
**Frequency:** 450 to 470 MHz - AA19C  
400 to 420 MHz - AA19F  
**Polarization:** Vertical  
**Impedance:** 50 ohms  
**Gain:** 2 db.  
**VSWR:** < 2 to 1  
**Front To Back Ratio:** n/a  
**Horizontal Beamwidth:** n/a  
**Vertical Beamwidth:** 60 degrees  
**Antenna Material:** Rubber duck whip.  
**Mounting Hardware:** Magnetic base.  
**Antenna Connector:** TNC with 12 feet integral RG-58 cable.  
**Antenna Envelope:** 16 in. length. Magnetic base 3.5 in. by 3 in by 1 in.  
**Weight:** 1 lb. 5 oz.

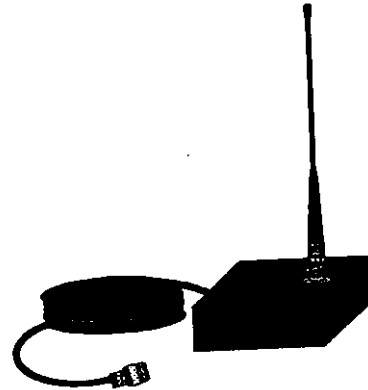

Model AA19

**Model No:** AA20C & AA20F  
**Antenna Type:** Omni-Directional, DC grounded, Collinear 5/8 wave over 1/2 wave.  
**Applications:** Fixed base or mobile mounting. L shaped mounting bracket may be removed for panel mounting. Ground plane radials may be removed depending on application.  
**Frequency:** 450 to 470 MHz - AA20C  
400 to 420 MHz - AA20F  
**Polarization:** Vertical  
**Impedance:** 50 ohms  
**Gain:** 4.5 dB.  
**VSWR:** < 1.5  
**Front To Back Ratio:** n/a  
**Horizontal Beamwidth:** n/a  
**Vertical Beamwidth:** 30 degrees  
**Antenna Material:** Stainless steel whip and ground plane radials. All other hardware anodized metal.  
**Mounting Hardware:** Stainless steel clamps for mounting to 3/4 in. to 1 1/2 in. pipe with right angle mount or direct mount.  
**Antenna Connector:** UHF Female (S-239)  
**Antenna Envelope:** 37 1/2 in. length by 16 in width with ground plane radials.  
**Weight:** 2 lbs.

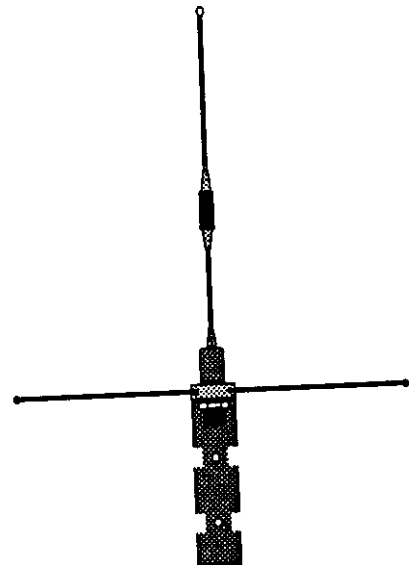

Model AA20

# APPENDIX B

## SPECIFICATIONS

### Model 192C & F Antennas

<b>Model No:</b>	AA201C & AA201F
<b>Antenna Type:</b>	Directional, DC grounded, 8 element yagi.
<b>Applications:</b>	Fixed base.
<b>Frequency:</b>	450 to 470 MHz - AA201C 400 to 420 MHz - AA201F
<b>Polarization:</b>	Vertical
<b>Impedance:</b>	50 ohms
<b>Gain:</b>	11 dB
<b>VSWR:</b>	< 1.5
<b>Front To Back Ratio:</b>	23 dB
<b>Horizontal Beamwidth:</b>	42 degrees
<b>Vertical Beamwidth:</b>	50 degrees
<b>Antenna Material:</b>	High strength aluminum painted black.
<b>Mounting Hardware:</b>	Heavy duty U bolts for mounting to 3/4 in. to 1 1/2 in. pipe with right angle mount or direct panel mount.
<b>Antenna Connector:</b>	UHF Female (SO-239)
<b>Maximum Power Input:</b>	300 Watts
<b>Antenna Envelope:</b>	60 in. length by 15 in. width
<b>Windload (RWV):</b>	100 mph
<b>Wind Load, Flat Plate (Ft):</b>	.52
<b>Lateral Thrust @RWV:</b>	14 mph
<b>Bending Moment @RWV:</b>	23 ft. lbs.
<b>Weight:</b>	2 lbs.

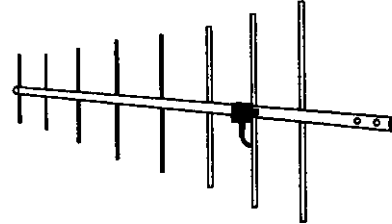

Model 201

<b>Model No:</b>	AA202C & AA202F
<b>Antenna Type:</b>	Directional, DC grounded, 5 element yagi.
<b>Applications:</b>	Fixed base.
<b>Frequency:</b>	450 to 470 MHz - AA202C 400 to 420 MHz - AA202F
<b>Polarization:</b>	Vertical or Horizontal
<b>Impedance:</b>	50 ohms
<b>Gain:</b>	10 dB
<b>VSWR:</b>	< 1.5
<b>Front To Back Ratio:</b>	20 dB
<b>Horizontal Beamwidth:</b>	59 degrees
<b>Vertical Beamwidth:</b>	53 degrees
<b>Antenna Material:</b>	High strength aluminum with gold chromate finish.
<b>Mounting Hardware:</b>	Heavy duty U bolts for mounting up to 2 1/8 in. pipe with right angle mount or direct panel mount.
<b>Antenna Connector:</b>	UHF Female (SO-239)
<b>Maximum Power Input:</b>	300 Watts
<b>Antenna Envelope:</b>	34.5 in. length by 13.25 in. width
<b>Windload (RWV):</b>	100 mph
<b>Weight:</b>	1.68 lbs.

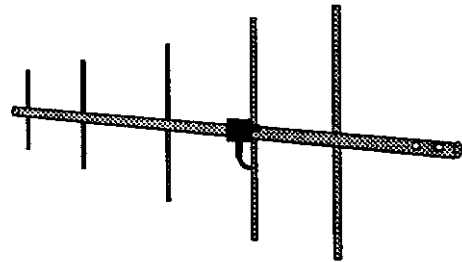

Model 202

# APPENDIX B SPECIFICATIONS

## Model 192M Antennas

<b>Model No:</b>	AA19M
<b>Antenna Type:</b>	Omni-Directional, 1/2 Wave over 1/4 Wave.
<b>Applications:</b>	Mobile Mount.
<b>Frequency:</b>	150 to 174 MHz
<b>Polarization:</b>	Vertical
<b>Impedance:</b>	50 ohms
<b>Gain:</b>	Unity
<b>VSWR:</b>	< 1.5 to 1
<b>Front To Back Ratio:</b>	n/a
<b>Horizontal Beamwidth:</b>	n/a
<b>Vertical Beamwidth:</b>	60 degrees
<b>Antenna Material:</b>	Rubber duck whip.
<b>Mounting Hardware:</b>	Magnetic base.
<b>Antenna Connector:</b>	TNC with 12 feet integral RG-58 cable.
<b>Antenna Envelope:</b>	11 in. length. Magnetic base 3.5 in. by 3 in. by 1 in.
<b>Weight:</b>	1 lb. 5 oz.

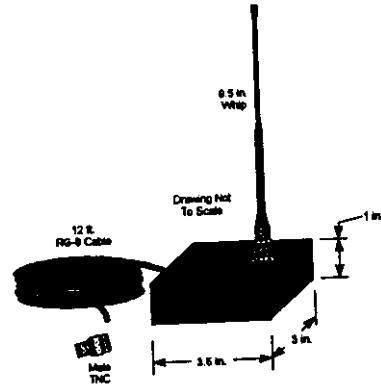

Model 19

<b>Model No:</b>	AA20M
<b>Antenna Type:</b>	Omni-Directional, DC Grounded, 5/8 Wave.
<b>Applications:</b>	Fixed base or mobile mounting. L shaped mounting bracket may be removed for panel mounting. Ground plane radials may be removed depending on application.
<b>Frequency:</b>	150 to 175 MHz
<b>Polarization:</b>	Vertical
<b>Impedance:</b>	50 ohms
<b>Gain:</b>	3.0 dB with ground plane radials
<b>VSWR:</b>	< 1.5
<b>Front To Back Ratio:</b>	n/a
<b>Horizontal Beamwidth:</b>	n/a
<b>Vertical Beamwidth:</b>	60 degrees
<b>Antenna Material:</b>	Stainless steel whip and ground plane radials. All other hardware anodized metal.
<b>Mounting Hardware:</b>	Stainless steel clamps for mounting to .75 in. to 1.5 in. pipe with right angle mount or direct panel mount.
<b>Antenna Connector:</b>	UHF Female (SO-239)
<b>Antenna Envelope:</b>	61 in. length by 43.5 in. width with ground plane radials
<b>Power:</b>	200 watts
<b>Weight:</b>	2 lbs.

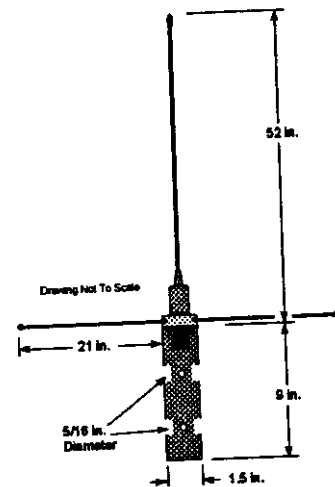

Model 20

# APPENDIX B

## SPECIFICATIONS

### Model 192M Antennas

<b>Applications:</b>	Fixed base mounting.
<b>Antenna Type:</b>	Directional, 3 Element Yagi, DC Ground
<b>Frequency:</b>	150 to 174 MHz
<b>Polarization:</b>	Vertical or Horizontal
<b>Impedance:</b>	50 ohms
<b>Gain:</b>	7.1 dB
<b>VSWR:</b>	< 1.5
<b>Front To Back Ratio:</b>	17 dB
<b>Horizontal Beamwidth:</b>	72 degrees
<b>Vertical Beamwidth:</b>	57 degrees
<b>Antenna Material:</b>	6061-T6 Aluminum
<b>Boom Diameter:</b>	7/8 in. 6061-T6 Aluminum, double wall construction
<b>Mounting Hardware:</b>	Stainless steel U bolts for mounting to 1 5/8 in. diameter pipe.
<b>Antenna Connector:</b>	UHF Female (SO-239)
<b>Maximum Power Input:</b>	500 Watts
<b>Antenna Envelope:</b>	42 in. length by 39 in. width
<b>Windload (RWV):</b>	100 mph
<b>Wind Load, Flat Plate (Ft<sup>2</sup>):</b>	.36 sq. ft.
<b>Lateral Thrust @ RWV:</b>	14.6 lbs.
<b>Bending Moment @ RWV:</b>	25.3 ft. lbs.
<b>Weight:</b>	3 lbs.

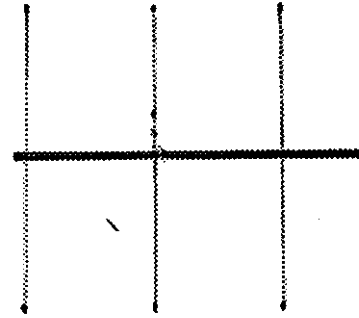

Model 202

# APPENDIX B SPECIFICATIONS

## Model 192V Antennas

**Model No:** AA03  
**Antenna Type:** Omni-Directional, ¼ Wave  
**Applications:** Mobile Mount.  
**Frequency:** 66 to 79 MHz  
**Polarization:** Vertical  
**Impedance:** 50 ohms  
**Gain:** unity with ground plane  
**VSWR:** < 2 to 1  
**Front To Back Ratio:** n/a  
**Horizontal Beamwidth:** n/a  
**Vertical Beamwidth:** 60 degrees  
**Antenna Material:** Stainless steel whip.  
**Mounting Hardware:** Magnetic base.  
**Antenna Connector:** TNC with 12 feet integral RG-58 cable.  
**Antenna Envelope:** 44 in. length. Magnetic base 3.5 in. by 3 in. by 1 in.  
**Weight:** 1 lb. 5 oz.

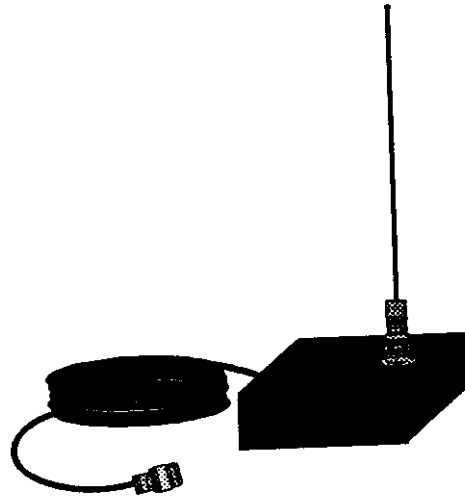

AA03

**Model No:** AA15  
**Antenna Type:** Omni-Directional, ¼ Wave  
**Applications:** Mobile Mount.  
**Frequency:** 66 to 79 MHz  
**Polarization:** Vertical  
**Impedance:** 50 ohms  
**Gain:** unity with ground plane  
**VSWR:** < 2 to 1  
**Front To Back Ratio:** n/a  
**Horizontal Beamwidth:** n/a  
**Vertical Beamwidth:** 60 degrees  
**Antenna Material:** Rubber duck whip.  
**Mounting Hardware:** Magnetic base.  
**Antenna Connector:** TNC with 12 feet integral RG-58 cable.  
**Antenna Envelope:** 17 in. length. Magnetic base 3.5 in. by 3 in. by 1 in.  
**Weight:** 1 lb. 5 oz.

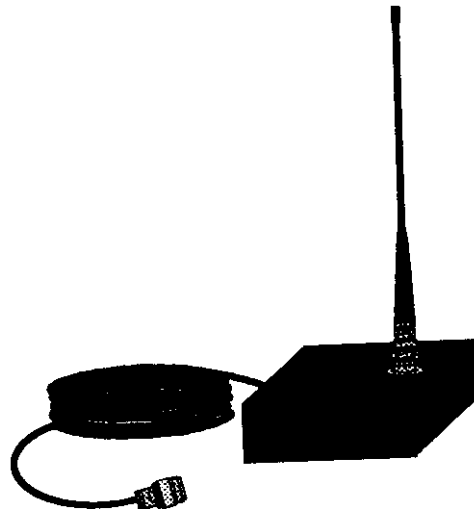

AA15

# APPENDIX B SPECIFICATIONS

## Model 192V Antennas

**Model No:** AA04  
**Antenna Type:** Omni-Directional, ¼ wave.  
**Applications:** Fixed base or mobile mounting. L shaped mounting bracket may be removed for panel mounting. Ground plane radials may be removed depending on application.  
**Frequency:** 66 to 79 MHz  
**Polarization:** Vertical  
**Impedance:** 50 ohms  
**Gain:** Unity with ground plane radials  
**VSWR:** < 1.5  
**Front To Back Ratio:** n/a  
**Horizontal Beamwidth:** n/a  
**Vertical Beamwidth:** 60 degrees  
**Antenna Material:** Stainless steel whip and ground plane radials. All other hardware anodized metal.  
**Mounting Hardware:** Stainless steel clamps for mounting to ¼ in. to 1 5/8 in. pipe with right angle mount.  
**Antenna Connector:** UHF Female (S-239)  
**Antenna Envelope:** 52 in. length by 86 in width with ground plane radials.  
**Weight:** 2 lbs.

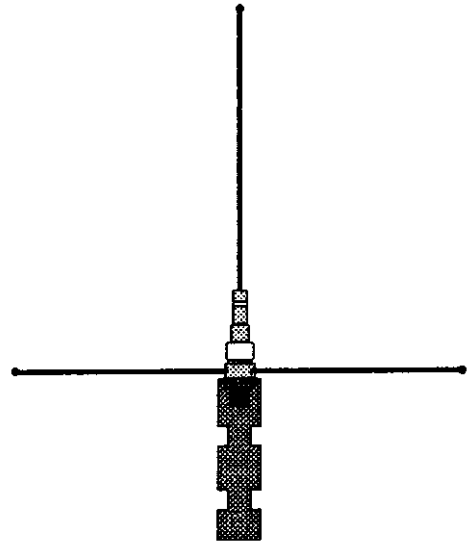

AA04

**Model No:** AA041  
**Antenna Type:** Omni-Directional, ¼ wave, loaded  
**Applications:** Fixed base or mobile mounting. L shaped mounting bracket may be removed for panel mounting. Ground plane radials may be removed depending on application.  
**Frequency:** 66 to 79 MHz  
**Polarization:** Vertical  
**Impedance:** 50 ohms  
**Gain:** Unity with ground plane radials  
**VSWR:** < 1.5  
**Front To Back Ratio:** n/a  
**Horizontal Beamwidth:** n/a  
**Vertical Beamwidth:** 60 degrees  
**Antenna Material:** Stainless steel whip and ground plane radials. All other hardware anodized metal.  
**Mounting Hardware:** Stainless steel clamps for mounting to ¼ in. to 1 5/8 in. pipe with right angle mount.  
**Antenna Connector:** UHF Female (S-239)  
**Antenna Envelope:** 26 ¼ in. length by 82 in width with ground plane radials.  
**Weight:** 2 lbs.

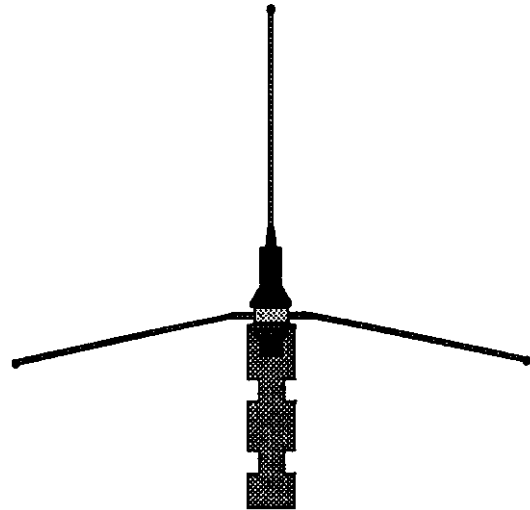

AA041

# APPENDIX B SPECIFICATIONS

## Model 192V Antennas

<b>Model No:</b>	AA042
<b>Antenna Type:</b>	Omni-Directional, ¼ wave, loaded
<b>Applications:</b>	Fixed base or mobile mounting. L shaped mounting bracket may be removed for panel mounting. Ground plane radials may be removed depending on application.
<b>Frequency:</b>	66 to 79 MHz
<b>Polarization:</b>	Vertical
<b>Impedance:</b>	50 ohms
<b>Gain:</b>	Unity with ground plane radials
<b>VSWR:</b>	< 1.5
<b>Front To Back Ratio:</b>	n/a
<b>Horizontal Beamwidth:</b>	n/a
<b>Vertical Beamwidth:</b>	60 degrees
<b>Antenna Material:</b>	Stainless steel whip and ground plane radials. All other hardware anodized metal.
<b>Mounting Hardware:</b>	Stainless steel clamps for mounting to ¾ in. to 1 5/8 in. pipe with right angle mount.
<b>Antenna Connector:</b>	UHF Female (S-239)
<b>Antenna Envelope:</b>	56 in. length by 86 in width with ground plane radials.
<b>Weight:</b>	2 lbs.

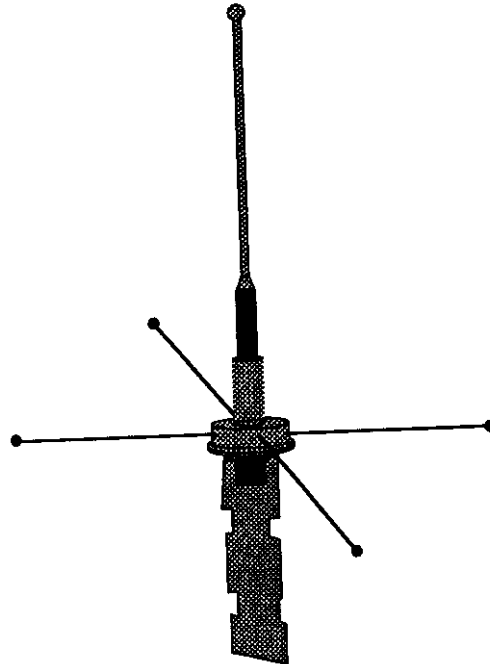

AA042

<b>Model No:</b>	AA051
<b>Antenna Type:</b>	Omni-Directional, DC Grounded
<b>Applications:</b>	Fixed base building mount.
<b>Frequency:</b>	72 to 76 MHz
<b>Polarization:</b>	Vertical
<b>Impedance:</b>	50 ohms
<b>Gain:</b>	Unity with ground plane radials
<b>VSWR:</b>	< 1.5
<b>Front To Back Ratio:</b>	n/a
<b>Horizontal Beamwidth:</b>	n/a
<b>Vertical Beamwidth:</b>	78 degrees
<b>Antenna Material:</b>	Stainless steel radiator, fiberglass radials, anodized aluminum base.
<b>Mounting Hardware:</b>	Mast mounting to 25/32 in. to 1 1/8 in. pipe by means of a mounting kit (supplied).
<b>Antenna Connector:</b>	UHF Female (SO-239)
<b>Antenna Envelope:</b>	63 in. length by 55 in width with ground plane radials.
<b>Weight:</b>	4 lbs.

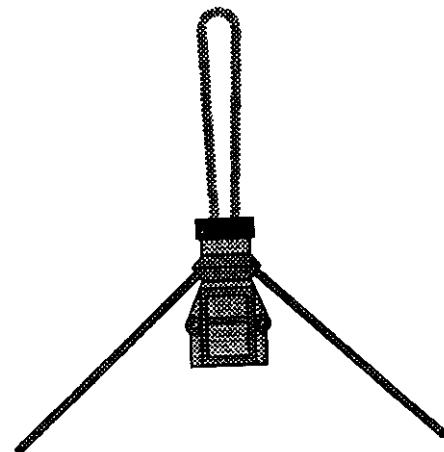

AA051



# APPENDIX B SPECIFICATIONS

## Model 192V Antennas

<b>Model No:</b>	AA052
<b>Antenna Type:</b>	Directional, DC Grounded
<b>Applications:</b>	Fixed base building mount.
<b>Frequency:</b>	72 to 76 MHz
<b>Polarization:</b>	Vertical
<b>Impedance:</b>	50 ohms
<b>Gain:</b>	4 dB
<b>VSWR:</b>	< 1.5
<b>Front To Back Ratio:</b>	11 dB
<b>Horizontal Beamwidth:</b>	84 degrees
<b>Vertical Beamwidth:</b>	74 degrees
<b>Antenna Material:</b>	6061-T aluminum.
<b>Mounting Hardware:</b>	Mast mounting to 25/32 in. to 1 1/8 in. pipe by means of a mounting kit (supplied).
<b>Antenna Connector:</b>	UHF Female (SO-239)
<b>Antenna Envelope:</b>	74 in. length by 40 in width.
<b>Weight:</b>	6.5 lbs.
<b>Maximum Exposed Area:</b>	0.35 sq. ft.
<b>Wind Velocity (w/o ice):</b>	100 mph

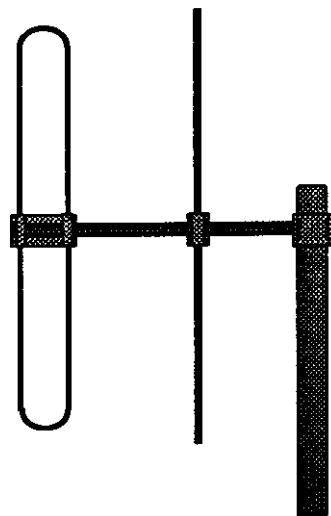

AA052

# APPENDIX C SPECIFICATIONS

## ESTeem Command Error Message Table

Listed below are the ESTeem Command Error Messages and their definitions. To receive these messages, TYPESYSTEM must be ON (See Appendix D, Definitions). All System Status Messages have a bell (O7H or CTRL G) preceding the message except when Messform is ON. If MESSFORM = OFF Line A will be displayed. If MESSFORM = ON Line B will be displayed.

1. A "TOO MANY CHARACTERS FOR  
COMMAND"  
B EMO1

This message will be displayed if more than the allocated number of characters are typed for a command. This is because some commands are truncated at a length of 8 characters.

2. A "AMBIGUOUS COMMAND"  
B EMO2

This is the case of not enough characters being entered to uniquely identify a command.

3. A "INVALID ARGUMENT"  
B EM03

This is displayed when a non valid value is given to a Command. Example; a value of O cannot be given to FRACK because the only valid values are 1-255.

# APPENDIX C

## SPECIFICATIONS

### ESTeem System Status Message Table

Listed below are the ESTeem System Status Messages and their definitions. To receive these messages, TYPESYSTEM must be ON (See APPENDIX D, DEFINITIONS). All System Status Messages have a bell (O7H or CTRL G) preceding the message except when Messform is ON. If Messform = OFF Line A will be displayed. If Messform = ON Line B will be displayed.

1. A "CONNECTED TO XX"  
B SSO1-xx

This message is caused by either receiving a reply from a Log On Packet, receiving a Log On Packet, or by typing LINK when connected and in the COMMAND MODE. XX is the address of the modem connected to.

2. A "DISCONNECTED FROM XX"  
B SSO2-xx

Tells that you have been disconnected from the device you were originally connected to (xx is unit address).

3. A "LINK DOWN"  
B SSO3

This message occurs after sending the last retry data packet and receiving no response from the destination node. This message usually indicates a hard failure -i.e. destination node not energized, wrong baud rate, (not compatible between units) improper transmit/receive frequency between nodes, etc.

4. A "CURRENTLY NOT CONNECTED!"  
B SSO4

The Disconnect was issued while the modem was not connected to another modem or when LINK is typed in the COMMAND MODE when you are not connected.

This message is displayed when the modem is configured in the monitor mode.

5. A "FAILED TO CONNECT!"  
B SSO5

This message occurs if the modem fails to connect.

6. A "FAILED TO DISCONNECT!"  
B SS06

This message occurs if the modems are connected and are unable to disconnect.

7. A "USING FACTORY DEFAULTS"  
B SS07

This command states when factory defaults have been enabled.

8. A "REMOTE PROGRAMMING"  
B SS08

This message is displayed when the ESTeem has been placed in the remote programming mode.

9. A "PHONE MODEM CONNECTED.  
INFRARED PORT DISABLED"  
B SS09

This message is displayed when the ESTeem phone port has received an in-coming call.

10. A "PHONE MODEM DISCONNECTED.  
INFRARED PORT ENABLED"  
B SS10

This message is displayed when the ESTeem port has been disconnected.

# APPENDIX C SPECIFICATIONS

## ESTeem System Error Message Table

Listed below are the ESTeem System Error Messages and their definitions. To receive these messages, TYPESYSTEM must be ON (See APPENDIX D, DEFINITIONS). All System Status Messages have a bell (O7H or CTRL G) preceding the message except when Messform is ON. If Messform = OFF Line A will be displayed. If Messform = ON Line B will be displayed.

1. A "NOVRAM FAILED"  
B SEO1

If this response is received after a save, there is a hardware problem with the ESTeem's NOVRAM Circuitry.

2. A "ROM FAILED"  
B SEO2

If this response is received after a save, there is a hardware problem with the ESTeem's ROM Circuitry.

# APPENDIX D

## SOFTWARE COMMANDS

### Factory Default Setting

Listed below is a listing of the ESTeem software commands and their Factory Default settings.

#### HELP CONTROL

APPENDRU = 255  
CONNECT  
CONVERS  
DISCONN  
FACTORY  
HELP  
MULTID = OFF  
PACKMON = OFF  
PHONE = OFF  
RADIO = OFF  
RESET  
ROUTE = 0  
RESTORE = 0  
SAVE  
TRANSPAR = OFF

#### HELP SETUP

ADDRESS = 1  
COMMAND = 3  
EDIT = ON  
MESSFORM = OFF  
NETWORK = 37  
PACKLENG = 2000  
PROMPT = ON  
RETRY = 6  
SENDPAC = 13  
SETCON = 2  
TERMCNT = OFF  
TERMTIME = 50  
TYPERROR = OFF  
TYPSTYPE = ON

#### HELP PLC

A\_BCTRL = OFF  
GE\_CTRL = OFF  
JOHNCTRL = OFF  
MODCTRL = OFF  
MOORE = OFF  
OPTO = OFF  
PLC\_MAST = OFF  
SQDADD = 0  
SQDCTRL = OFF

#### HELP RS-232

AUTOLF = ON  
BLOCK = OFF  
DTR\_ENAB = OFF  
ECHO = ON  
MODECONT = OFF  
XHFLOW = OFF  
XSFLOW = ON

#### HELP SYSTEM

ALTERETR = 2  
ALTEROUT = OFF  
COPYRIGHT  
DISACK = OFF  
MODEL = 19C  
POLLED = OFF  
PROGRAM = 0  
REMPROG = ON  
SECURITY = OFF  
S/N = 0  
TXSTAT  
VERSION = 1.0V

#### HELP RADIO

CARBSY = 1  
FRACK = 50  
LAT  
MODULATE = ON  
RANDOM = OFF  
RFCYCLES = 10  
RXDATA = 1  
RXEND = 1  
RXSIGNAL = OFF  
SEL/A1 = 56  
SEL/N1 = 86  
SEL/N2 = 960  
SQUELCH = 0

# APPENDIX D

## SOFTWARE COMMANDS

### Definitions

Listed below in alphabetical order are the definitions of the ESTeem software commands.

#### **A\_BCTRL**

This function enables the Allen Bradley controller protocol. For further details reference the EST Engineering Report on Allen Bradley controller interfacing.

ON: Enabled.  
OFF: Disabled.

Factory default = OFF.

#### **ADDRESS (1-255)**

The command defines the ESTeem source address. The default value is whatever address has been stored in nonvolatile memory. Addresses 1 to 254 are usable for unit addressing. Address 255 is used for GLOBAL.

#### **ALTERetr (0-255)**

This command specifies the number of retries to establish a link under the ALTERROUT command. This command is independent from the RETRY command.  
Factory default = 2.

Note: When ALTERROUT = ON, the RETRY variable determines how many times the ESTeem will cycle through the ALTERROUT table before displaying the "Link Is Down" message.

#### **ALTEROUT (on/off)**

This command allows the user to define four alternate routes. When this software switch is enabled the ESTeem will prompt the user for four addition modem addresses or destinations. It is noted that a destination using repeater paths can be used. If the modem is unable to connect to the specific unit addressed or "DESTINATION CONNECTED TO ANOTHER NODE" is encountered the modem will try to connect using an alternate route. The modem will start route selection with the last route used or the SETCONN variable. The ALTERETR command will determine the number of tries the ESTeem will attempt to connect before it switches to the next route defined in the table.

ON: Enabled.  
OFF: Disabled.

Factory default = OFF.

#### **APPEndru (l#,r#,a1,a2,g)**

The APPEndru command appends routes to a connect address that are defined by the ROUTE command.

- l # = Location of route number in memory. Address locations 1 to 16.
- r # = Appended route number. Route numbers 1 to 16.
- a1 = Address of first destination node. Address numbers from 1 to 254.
- a2 = Address of last destination node. . Address numbers from 1 to 254.
- g = Group feature is enabled by inserting a 1 in this field.

Factory default = 0. APPEndru 0 disables this feature.

Note: This command is used in conjunction with the ROUTE Command.

#### **AUtoif (on/off)**

This command enables the auto line feed sent to the terminal after each carriage return.

ON: Enabled.  
OFF: Disabled.

Factory default = ON.

#### **BLOCK (on/off)**

The BLOCK command, when enabled, disables the RS-232C/422/485 communications port from receiving or outputting data.

ON: Enabled.  
OFF: Disabled.

The factory default value is OFF

# APPENDIX D

# SOFTWARE COMMANDS

## Definitions

Listed below in alphabetical order are the definitions of the ESTeem software commands.

### CARbsy (0-255)

This command defines the carrier busy delay in milliseconds. A value of 0 will disable the carrier busy delay. Factory default = 1.

### COMMand (0-255)

This command specifies the value (in decimal) of an ASCII character used to return the ESTeem to COMMAND MODE. If the COMMAND character is read by the ESTeem when in the CONVERSE MODE, the modem will exit to the COMMAND MODE. A value of 0 in this command will disable the function. Factory default = \$03 (Hex) or CTRL-C.

### CONNect (r1,r2,r3,da)

This command performs the CONNECT to a destination ESTeem. This function supports a direct connect or a connect through a maximum of three repeater nodes. The default value is whatever address has been stored by the SETCon COMMAND.

r1 = ESTeem address (1 to 254) of repeater 1.  
r2 = ESTeem address (1 to 254) of repeater 2.  
r3 = ESTeem address (1 to 254) of repeater 3.  
da = Destination address (1 to 254).

### CONVers

The execution of this command causes an immediate exit from COMMAND MODE into CONVERSE MODE.

### COPright

The execution of this command causes the copyright information to be printed.

### DISACK (on/off)

This command when enabled instructs the modem to disable the acknowledgment request on the information packet. This is used when the designation device will respond with its own acknowledgment.

Factory default = OFF.

### DISCONNect (1-254)

The disconnect command. The execution of this command immediately initiates a disconnect request with the currently connected node or in a multi-connect environment only a specific node may be addressed.

### DTR\_enab (on/off)

The DTR enable command. This command, when enabled, allows the ESTeem modem to monitor pin 20 of the RS-232C connector in regards to the status of an external device connected to it.

ON: Enables monitoring the DTR signal on pin 20 of the RS-232C connector. If DTR is at a space condition, then the modem is enabled. If DTR is at a mark condition, then the ESTeem modem will be disabled. The normal operation of this line is for the ESTeem modem to have status on the external device, out-putting to pin 20. This line can act as a status to the ESTeem when the external device is ready to transmit or receive data.

OFF: Disabled

Factory default = OFF.

Note: If the DTR command is enabled and the line is disabled then the ESTeem will perform a "Disconnect" if connected.

### ECHO (on/off)

This command enables the ESTeem to echo characters received from the input device back to the input device.

ON: Enabled.

OFF: Disabled.

Factory default = ON.

### EDit (on/off)

This command enables the EDIT functions from the CONVERSE Mode.

Factory default = ON.

# APPENDIX D

## SOFTWARE COMMANDS

### Definitions

Listed below in alphabetical order are the definitions of the ESTeem software commands.

#### Factory

The factory default command. The execution of this command causes the ESTeem to restore the command table values from factory values that are stored permanently in memory. This will allow the user the ability to restore the ESTeem to factory conditions during testing or set-up.

#### FRack (1-255)

This command programs the frame acknowledge delay in milliseconds. This value is used as a minimum time before decrementing the retry count and retransmitting a packet if the retry count is not zero.

Factory default = 50.

#### GE\_CTRL

This command enables the General Electric controller protocol. For further information please reference the EST Engineering Report on General Electric controller interfacing.

ON: Enabled.  
OFF: Disabled.

Factory default = OFF.

#### HElp

HELP switches are:

HELP	Displays this Help menu.
HELP ALL	Displays All commands switches and arguments.
HELP CHANGE	Displays only the commands that are changed from factory default.
HELP CONTROL	Displays Control commands switches and arguments.
HELP PLC	Displays PLC commands switches and arguments.

#### HELP RADIO

Displays Radio commands switches and arguments.

#### HELP RS-232

Displays RS232 commands switches and arguments.

#### HELP SETUP

Displays Setup commands switches and arguments.

#### HELP SYSTEM

Displays System commands switches and arguments.

#### JOHNctrl (on/off)

This function enables the Johnson controller protocol. For further detail Reference the EST Engineering Report on Johnson controller interfacing.

ON: Enabled.  
OFF: Disabled.

Factory default = OFF.

#### LAT

Latches the selection of the desired serial frequency synthesizer on the Tx/Rx card

#### MESSform (on/off)

When enabled all of the system status and error messages will be in a formatted form.

"xx" indicates what error or message (See Error Messages and System Status Messages).

EMxx <CR>	[ESTeem Error Messages]
SExx <CR>	[System Error Messages]
SSxx <CR>	[System Status Messages]
SSxx-xxxx <CR>	[System Status Message W/Returned Value]

ON: Enabled.  
OFF: Disabled.

Factory default = OFF.



# APPENDIX D

## SOFTWARE COMMANDS

### Definitions

Listed below in alphabetical order are the definitions of the ESTeem software commands.

#### **MOdecontr (on/off)**

**ON:** The mode of the ESTeem modem is controlled by pin 19 of the RS-232C connector. A low (0) directs the ESTeem into the COMMAND mode. A high (1) directs the ESTeem into CONVERSE/TRANSPARENT mode.

**OFF:** The mode of the ESTeem modem is controlled by ASCII character.

Factory default = OFF

#### **MODEL (xx)**

Displays the product model of default firmware that is installed. Model should be the same as product being used. Listed below are the model codes

19C = ESTeem Model 192C  
19F = ESTeem Model 192F  
19M = ESTeem Model 192M  
19V = ESTeem Model 192V

#### **MODCTRL**

This command enables the Modicon controller protocol. For further detail Reference the EST Engineering Report on Modicon controller interfacing.

**OFF:** Disabled.

Factory default = OFF.

#### **MODulate (on/off)**

The radio modulate command. When enabled will transmit a modulated test signal when the RADIO ON command is enabled.

**ON:** Enabled.  
**OFF:** Disabled.

The factory default value is OFF

#### **MOORE (on/off)**

This function enables the Moore products using Hart protocol. For further details reference the EST Engineering Report on Moore Products interfacing.

**ON:** Enabled.  
**OFF:** Disabled.

Factory default = OFF.

#### **MULTID (on/off)**

This command when enabled allows the ESTeem User to send data to another ESTeem from the CONVERSE MODE by specifying the routing address before the data.

**ON:** Enabled.  
**OFF:** Disabled.

Factory default = OFF.

#### **Example Of Transmitted Data:**

[001]DATA Routes data to an ESTeem addressed 1.

[100,200,250,1]DATA Routes data to an ESTeem addressed 1 via ESTeems addressed 100, 200, and 250.

This replaces using the CONNECT command from the COMMAND Mode. Received data packets will have the address of the ESTeem that sent the data at the beginning of the data packet.

#### **Example Of Received Data:**

[004]RECEIVED DATA Data received from an ESTeem addressed 4.

[030,100,244,004] Data received from an ESTeem addressed 4 via ESTeems addressed 30, 100, and 244.

#### **NETwork (0-255)**

Network identification code. This is used to program a common code for all modems in the customers network so that another facility on your frequency using the same addresses will not interfere with your equipment. Factory default = 37.

# APPENDIX D

# SOFTWARE COMMANDS

## Definitions

Listed below in alphabetical order are the definitions of the ESTeem software commands.

### **OPTO (on/off)**

This function enables the Opto 22 protocol. For further details reference the EST Engineering Report on Opto 22 interfacing.

ON: Enabled.  
OFF: Disabled.

Factory default = OFF.

### **PACKleng (1-2000)**

This command defines the length of the data packet in bytes. Factory default = 2000.

### **PACKMon (on/off)**

Places the ESTeem in the packet monitor mode. Factory default = OFF.

### **PHone (on/off)**

Phone port enable command. The ESTeem will answer an incoming call when enabled.

ON: Enabled.  
OFF: Disabled.

The factory default value is OFF.

### **PLC\_MAST (on/off)**

The programmable logic controller (PLC) command.

ON: When enabled, the ESTeem modem will identify the desired route from the master PLC message. The ESTeem modem will only identify the PLC master route if the master command is enabled in the PLC.

OFF: The ESTeem modem will be configured as to interface to a slave PLC.

Factory default = OFF.

### **POLLed (on/off)**

When enabled the ESTeem will only transmit the contents of its internal transmit buffer when it receives

an ENQ (hex 5) from a polling ESTeem. During non polled times the ESTeem transmit buffer will be continuously updated from data being received by the

RS-232C/422 port. This software feature was developed for interfacing the ESTeem to output devices without flow control that are to be polled from a master device.

ON: Enabled will transmit the contents of its transmit buffer when a ENQ (hex 5) is received.  
OFF: Disabled.

Factory default = OFF.

### **PROGram (1-254,1-254,1-254,1-254)**

This command is used to remote program another ESTeem unit. Example PROG 10 (Unit 10 is the address of the remote unit). When a connection has been made with the remote ESTeem the RPG: prompt will appear. The RPG: prompt is the command prompt of the remote modem.

Note: See *REMPROG Command*.

### **PROMpt (on/off)**

The prompt enable command.

ON: The prompt responses are enabled. These are the prompts for Converse or Trans Mode that are normally output from the RS-232C serial port by the ESTeem.  
OFF: Disabled.

Factory default = ON.

### **RADio (on/off)**

The radio transmitter enable command. The ESTeem radio transmitter will cycle on and off when enabled for tuning and antenna testing procedures.

ON: Enabled.  
OFF: Disabled.

The factory default value is OFF

# APPENDIX D

## SOFTWARE COMMANDS

### Definitions

Listed below in alphabetical order are the definitions of the ESTeem software commands.

#### **RANdom (on/off)**

The RANDOM command when enabled will generate a simulated random data output when the RADIO ON command is enabled

ON: Enabled.  
OFF: Disabled.

The factory default value is OFF

#### **REMprog (on/off)**

This command will disable the ESTeem from being remotely programmed by any another ESTeem.

ON: Enabled.  
OFF: Disabled.

The factory default value is ON.

#### **RESet**

The software reset command for the ESTeem. The execution of this command resets the internal electronics in the ESTeem.

#### **RESTore**

The restore command. The execution of this command restores the ESTeem command variables and switches configurations stored in nonvolatile memory.

#### **RETry (1-255)**

The retry command number. This is the number specifying the number of retries, retransmission of frames, that are not acknowledged. Frames are retransmitted RETRY times before operation is aborted. Factory default = 6.

#### **RFcycles**

This command defines the number of cycles the ESTeem will transmit when programmed with the RADIO COMMAND.

Factory default = 10.

#### **ROUTE (#,r1,r2,r3,)**

The ROUTE sets up the route table in the ESTeem.

- l # = User defined route number. Route numbers 1 to 16 may be used.
- r1 = Address of first repeater. Address numbers from 1 to 254 may be used.
- r2 = Address of second repeater. Address numbers from 1 to 254 may be used.
- r3 = Address of third repeater. Address numbers from 1 to 254 may be used.

**Note:** See APPENDRU Command.

Factory default = 0.

#### **RXData (1-255)**

This command defines the time (milliseconds) the receiver waits after a carrier detect before starting the receive sequence. This value is optimized at the factory and should not be changed.

Factory default = 1.

#### **RXEnd (1-255)**

This command defines the time (milliseconds) to wait after the last character is received before reinitializing the receiver.

Factory default = 1.

#### **RXSIGNAL (on/off)**

This command enables the signal to noise ratio meter output. Output level varies from 0 to 248 (248 being the highest reading).

ON: Enabled.  
OFF: Disabled.

Factory default = OFF.

#### **SAve**

# APPENDIX D SOFTWARE COMMANDS

## Definitions

Listed below in alphabetical order are the definitions of the ESTeem software commands.

The save command. The execution of this command stores the current command values and switches.

**Note:** Please wait approximately two seconds after executing the SAVE command before turning off power to the ESTeem.

### SECURITY (off or 1-100000)

The security command disables programming the ESTeem.

1 to 100000 This feature is enabled when you enter a number from 1 to 100000. When enabled the ESTeem will return a Security ON message. To disable security enter SECURITY xxxxxx.  
xxxxxx = your predefined security number.  
When disabled the ESTeem will return a Security Off message.  
OFF Security disabled.

Factory default = OFF.

### SENDPACK (0-255)

Send packet (SENDPACK) command. The value specifies an ASCII character used to signal when to send the packet. If set to a value of 255 the command is disabled. The factory default value is 13 (Return).

### SEL/A1 (1-255)

The SEL/A1 command sets the transceiver for a specific frequency. Factory default (Model 192C) = 50.

### SEL/N1 (1-999)

The SEL/A1 command sets the transceiver for a specific frequency. Factory default (Model 192C) = 86.

### SEL/N2 (1-999)

The SEL/N2 command sets the transceiver for a specific frequency. Factory default (Model 192C) = 960.

### SETCon (r1,r2,r3,da)

This command defines the destination address for the ESTeem to perform a connect using the Auto Connect feature. This function supports a direct connect or a connect through a maximum of three repeaters.

r1 = ESTeem address (1 to 254) of repeater 1.  
r2 = ESTeem address (1 to 254) of repeater 2.  
r3 = ESTeem address (1 to 254) of repeater 3.  
da = Destination address (1 to 254).

### S/N

Serial Number command. When executed from the Command Model will output the ESTeem serial number of the unit that is defined at the time of manufacturer.

### SQDCTRL (on/off)

This function enables the Square D controller protocol. For further detail Reference the EST Engineering Report on Square D controller interfacing.

Factory default = OFF.

### SQDADD (1-254)

This function is used with the SQDCTRL command to control the address fence when using SQ-D Network Interface Modules. For further details reference the EST Engineering Report on the SQ-D controller.

Factory default = 0.

### SQUELCH (0-3)

This command defines the squelch threshold of the receiver. Listed below are the settings:

0	=	-101 dBm	2 $\mu$ V
1	=	- 93 dBm	5 $\mu$ V
2	=	- 87 dBm	10 $\mu$ V
3	=	- 70 dBm	70 $\mu$ V

Factory default = 0.

### TERMCont (on/off)

# APPENDIX D

## SOFTWARE COMMANDS

### Definitions

Listed below in alphabetical order are the definitions of the ESTeem software commands.

The RS-232C/422/485 receive termination timer.

**ON:** If there are characters in the RS-232 buffer and the modem is in Converse Mode, the termination timer starts from the time the last receive character is updated in the buffer. If the termination time expires before another character is received, the characters are transmitted.

**OFF:** Disabled

Factory default = OFF.

#### **TERMTime (10-65535)**

The RS-232C/422/485 receive termination timer value. This value can be 10 to 65535 milliseconds. This value is enabled by TERMCNT. Factory default = 50.

#### **TRANSPAR (on/off)**

The transparent mode command. This mode allows the ESTeem link to be completely transparent to the communicating RS-232/422/485 devices. Reference Chapter 2.

**ON:** Enabled.

**OFF:** Disabled.

Factory default = OFF.

#### **TXSTAT**

This command outputs the total number of rf transmissions vs. the total number of retries. After output is completed, the counter is zeroed.

#### **TYPerr (on/off)**

This command enables the Communication Error Messages.

**ON:** Enabled.

**OFF:** Disabled.

Factory default = OFF.

#### **TYPSyste (on/off)**

This command enables the System and Error Message Commands.

**ON:** Enabled.

**OFF:** Disabled.

Factory default = ON.

#### **VERSION**

This command will display the current software version being used by the ESTeem.

#### **XHflow (on/off)**

This command enables hardware flow control.

**ON:** Enabled.

**OFF:** Disabled.

Factory default = OFF.

#### **XSflow (on/off)**

This command enables software flow control.

**ON:** Enabled.

**OFF:** Disabled.

Factory default = ON.

1  
2  
3  
4  
5  
6  
7  
8  
9  
10  
11  
12  
13  
14  
15  
16  
17  
18  
19  
20  
21  
22  
23  
24  
25  
26  
27  
28  
29  
30  
31  
32  
33  
34  
35  
36  
37  
38  
39  
40  
41  
42  
43  
44  
45  
46  
47  
48  
49  
50  
51  
52  
53  
54  
55  
56  
57  
58  
59  
60  
61  
62  
63  
64  
65  
66  
67  
68  
69  
70  
71  
72  
73  
74  
75  
76  
77  
78  
79  
80  
81  
82  
83  
84  
85  
86  
87  
88  
89  
90  
91  
92  
93  
94  
95  
96  
97  
98  
99  
100