



ESTEEM

INDUSTRIAL WIRELESS SOLUTIONS

ESTeem User's Manual

Horizon Series

Manual Revision 1.0

June 2016

Author: _____

Date: _____

Name: Eric P. Marske

Title: Product Support Manager

Approved by: _____

Date: _____

Name: Mike Eller

Title: President

**Electronic Systems Technology, Inc.
Dba ESTeem Wireless Modems**

Building B1

415 N. Quay Street

Kennewick, WA 99336

Phone: 509-735-9092

Fax: 509-783-5475

E-mail: market@esteem.com

Web Site: www.esteem.com

Copyright© 2016 by Electronic Systems Technology, Inc.

All rights reserved. Printed in the United States of America. No part of this publication may be reproduced, stored in a retrieval system, or transmitted, in any form or by any means, electronic, mechanical, photocopying, recording, or otherwise, without the prior written permission of Electronic Systems Technology.

Electronic Systems Technology, Inc. dba ESTeem Wireless Modems, (hereinafter ESTeem) expressly warrants its products as free of manufacturing defects for a period of one year from the date of sale to first user/customer. THERE ARE NO OTHER WARRANTIES, EXPRESS OR IMPLIED AND THERE IS EXPRESSLY EXCLUDED ALL WARRANTIES OF MERCHANTABILITY OR FITNESS FOR A PARTICULAR PURPOSE. NO OTHER WARRANTY GIVEN BY ANY EMPLOYEE, AGENT, DISTRIBUTOR OR OTHER PERSON WITH RESPECT TO THE PRODUCT SHALL BE BINDING ON ESTEEM.

LIMITATION OF LIABILITY:

ESTeem's liability shall be limited to refunding of purchase price, repair or replacement of product. IN NO EVENT SHALL ESTEEM HAVE LIABILITY FOR CONSEQUENTIAL, INCIDENTAL, SPECIAL OR EXEMPLARY DAMAGES CAUSED DIRECTLY OR INDIRECTLY BY THE PRODUCT, INCLUDING BUT NOT LIMITED TO ANY INTERRUPTION OF SERVICES, LOSS OF BUSINESS OR ANTICIPATORY PROFITS. IN NO EVENT SHALL ESTEEM BE LIABLE FOR ANY DAMAGES WHATSOEVER IN EXCESS OF THE PURCHASE PRICE OF THE PRODUCT.

In the event that a unit or part requires replacement or factory servicing, the following conditions apply:

- a) Customer must obtain from ESTeem an authorized RMA (Return Materials Authorization) Number before shipment of product or parts to ESTeem for any reason;
- b) If the whole unit is shipped, it must be in its original carton and shipping components, or a carton and shipping components supplied by ESTeem, or it parts only are shipped, they must be packaged and cushioned so as to prevent damage in transit and shipped freight prepaid;

PRODUCT WILL BE CONSIDERED OUT OF WARRANTY IF:

- a) If the product is damaged due to improper or abnormal use, abuse, mishandling, accident or improper maintenance or failure to follow operating instruction;
- b) If the product is defective as a result of sand, dirt, or water damage;
- c) If any factory-sealed enclosure has been opened or shows evidence of an attempt to be opened;
- d) If defects or damage are caused by the use of unauthorized parts or unauthorized service;
- e) If the product has had its serial numbers altered or removed.

Warranty repair form must be accompanied by proof of user's purchase of unit. Product must be shipped to the manufacturer at the following address:

ESTeem Wireless Modems
415 North Quay Street
Kennewick, Washington USA 99336

ADDITIONAL SERVICE:

If ESTeem releases an improvement update to firmware internal to the ESTeem unit during the 90-day period after the unit was purchased by the first user/customer, ESTeem will update the applicable unit with the revised version at no charge other than for UPS handling and shipping to and from your location to the ESTeem factory. Return of any such item must be accompanied with proof of purchase.

CHAPTER 1 – Introduction

Before You Begin	1-1
Horizon Overview	1-1
Horizon Configuration Modes	
Access Point Modes	1-2
Access Point Peer (Repeater) Mode	1-3
Self-Healing Mesh Network	1-4
Station (WiFi Client) Modes	1-4
RS-232 Serial Applications	1-5

CHAPTER 2 – Starting Out

Three Configuration Phases	2-1
Horizon Hardware Description	2-1
Front Panel Layout	2-2
Antenna Connection Overview	2-2
Horizon Hardware Configuration	2-3

CHAPTER 3 – Example Applications

Modes of Operation Description and Examples	3-1
Ethernet Bridge Mode	3-1
Router Modes	3-3
Mobile Client Modes	3-4
802.11 Access Point Modes	3-5
Programming Examples	3-7
Using ESTeem Network Configuration (ENC) Utility	3-7
Example 1 – Point to Point Ethernet Bridge	3-9
Example 2 – Point to Point Ethernet Bridge with Repeater	3-10
Example 3 – Point to Multipoint with Mesh Repeater	3-11
Example 4 – Point to Multipoint Router Mode	3-13
Example 5 – Mobile Client Mode	3-15
Example 6 – 802.11 Access Point Mode	3-16
Router Addressing Examples	3-17

CHAPTER 4 – Utilities and Features

ESTeem Network Configuration (ENC) Utility	4-1
ESTeem Discovery Utility	4-1
Firmware Updates	4-3
Setting Local Time	4-4
Configuring Time Server	4-5
VLAN Operation	4-6

IGMP Snooping	-----	4-6
Simple Network Management Protocol (SNMP)	-----	4-10

CHAPTER 5 – Web Configuration

Logging Into Web Configuration Manager		5-1
Web Configuration Manager		
Top Menu	-----	5-1
Setting ModemID Field	-----	5-2
Status Menu	-----	5-3
System Log Screen	-----	5-4
Setup Screen	-----	5-5
Advanced Configuration Screen	-----	5-5
Backup Screen	-----	5-6
Restore Screen	-----	5-6
Software Update	-----	5-7
System Reboot	-----	5-7

CHAPTER 6 – Serial Configuration and Applications

Using RS-232 Programming Port		6-1
Using RS-232 Data Port		
Serial Connections	-----	6-3
Serial Configuration	-----	6-3

CHAPTER 7 – Bridge Links and Mesh Networking

ESTeem Mesh Network		7-1
Configuration	-----	7-1
Rapid Spanning Tree Protocol (RSTP)		
Overview	-----	7-4
Phases	-----	7-4
Priority and Path Cost	-----	7-4
Root Bridge	-----	7-4
Redundant Backup		
Redundant Master Configuration	-----	7-5

CHAPTER 8 – Antenna Setups

Antenna and Cable Configurations		
Horizon 2.4 Antenna and Cable Configurations	-----	8-1
Horizon 900 Antenna and Cable Configurations	-----	8-3

Weatherproofing Coaxial Cable Connections	8-3
Antenna Diversity	8-3
Assembling the AA195PM Outdoor Pole Mounting Kit	8-4
Grounding Procedure	8-9
Fresnel Zone	8-10

APPENDIX A – FCC Information

APPENDIX B – Interface Ports

Ethernet Interface	-----	B-1
Configuring DHCP Server	-----	B-1
RS-232 Programming Port Pin-Out	-----	B-2
RS-232 Data Port Pin-Out	-----	B-2

APPENDIX C – Radio Configuration

Frequency of Operation	-----	C-1
RF Data Rate Configuration	-----	C-1
RF Bandwidths	-----	C-2
RF Data Rates and Throughput Chart	-----	C-3
Setting RF Output Power	-----	C-4

APPENDIX D – Security

APPENDIX E – Troubleshooting

Testing Communication Link	-----	E-1
Viewing Peer Table	-----	E-1
Troubleshooting Tips	-----	E-2

APPENDIX F – Horizon 2.4 Specifications

Horizon 2.4 (216An) Specifications	-----	F-1
Case Diagram	-----	F-2
Antenna Specifications	-----	F-3

APPENDIX G – Horizon 900 Specifications

Horizon 900 (216Ad) Specifications	-----	G-1
Case Diagram	-----	G-2
Antenna Specifications	-----	G-3

BEFORE YOU BEGIN

Thank you and congratulations on your purchase of the ESTeem Horizon Series Wireless Ethernet Modem! This manual was written to help both the first time and advanced user of the Horizon to configure the wireless modem for your application. If this is your first time configuring the Horizon and you would like to get going as soon as possible, we recommend using the *ESTeem Resource CD* provided with the modem. The Resource CD will provide the software utilities and guide you through the configuration of the wireless modem for your application.



Figure 1: ESTeem Horizon Series

The ESTeem Horizon Series of wireless Ethernet networking hardware are very sophisticated networking devices. To keep the manual usably short, many of the application descriptions and programming details assume the user has a good working knowledge of the following network concepts:

Throughout this User's Manual are "*Technical Tips*" in boxes like this that have been added to help answer the most commonly asked questions.

- General Ethernet networking and the configuration of LAN topologies
- Common Ethernet terminology and acronyms
- TCP/IP network protocol structure and how to configure TCP/IP networks and subnets
- How to identify and set the TCP/IP address on your computer
- Have administrator privileges to the computer and network you are configuring
- If using routing protocols, you must be able to identify and configure the network routers, gateways and firewalls
- You must be familiar with using web browser software such as Internet Explorer, Netscape or Mozilla

If you are unfamiliar with any of the above networking concepts, you may need to contact your network administrator for assistance.

HORIZON OVERVIEW

The ESTeem Horizon is a series of wireless LAN transceivers that can be used to build many types of Wireless Local Area Networks (WLAN). The wireless modems in Horizon series can provide RF data rates up to 150 Mbps and have an RS-232 serial port for legacy device networks. The Model Horizon is a very sophisticated networking device that can be configured for multiple modes of operation depending upon the needs of the wireless and wired LAN system. The following configuration modes are provided as an overview of the basic network types, as all possible network configurations cannot be listed. For further help in selecting the correct network type, please refer to Chapter 4 of this User's Manual or call Customer Support at 509-735-9092.

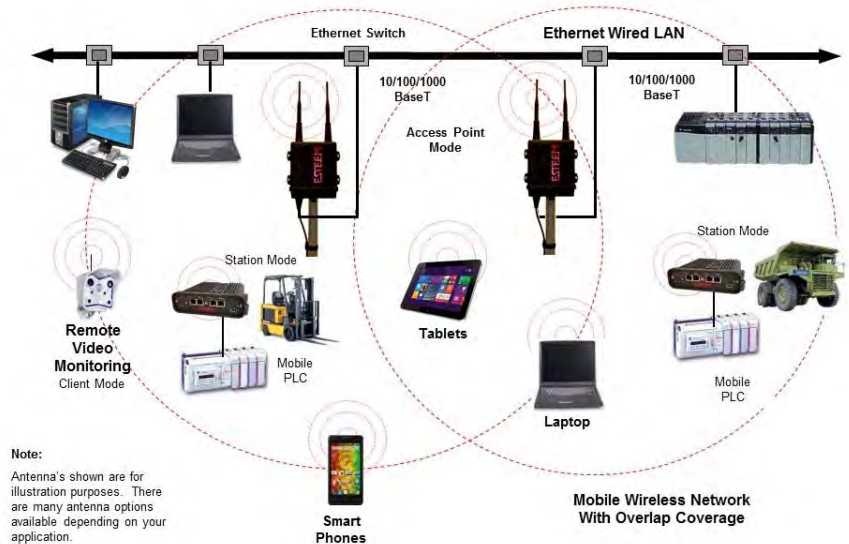

Figure 2: Access Point Bridge Diagram

CONFIGURATION MODES

The Horizon can be configured for multiple modes of operation without any changes to the hardware. The following are brief descriptions of the configuration modes. For detailed descriptions and suggested applications for each mode, please refer to Chapter 4.

Access Point Modes

When the Horizon is configured as an Access Point it will provide a wireless bridge for mobile clients such as Horizon or Model 195E modems in client modes or Wi-Fi devices. Multiple Access Points can be physically connected to the same network (LAN) or through a radio link using the Access Point Peer mode to provide overlapping, seamless Ethernet communication for mobile devices.

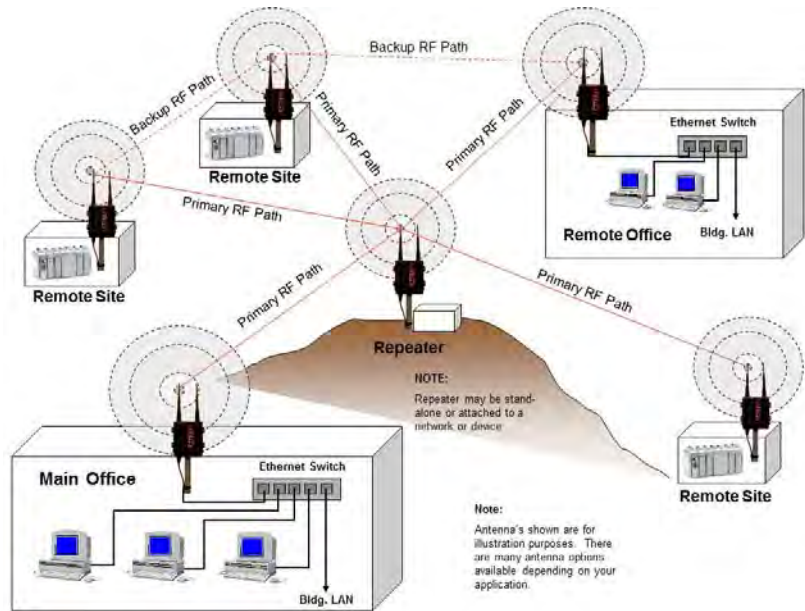

Figure 3: Peer Mode Diagram

1. Access Point Bridge Mode

An ESTeem Horizon in Access Point Bridge mode will both provide wireless access to mobile clients (Access Point) and bridge all Ethernet data connected to the Ethernet ports. The AP Bridge mode will pass all network traffic between connected devices including global network broadcasts. (See Figure 2)

2. Access Point Router Mode

In this mode the ESTeem Horizon will function as a router between wired Ethernet networks, connected to the Horizon's Ethernet port, and the wireless clients in the network. As in all standard router configurations, the wireless and wired Ethernet networks will need to be on separate subnets. The Horizon in Access Point Router mode will pass network traffic for connected devices but will block global network broadcasts from the wired network. This mode of operation should be used instead of the Access Point Bridge mode when a separation between networks is required or the ESTeem is connected to larger LAN Networks that will continuously send global network broadcasts (Figure 3).

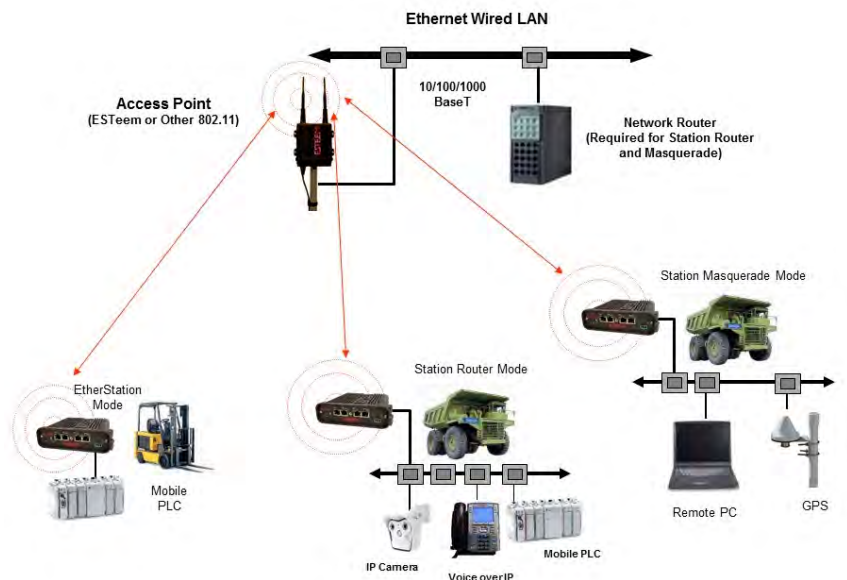

Figure 4: Access Point Masquerade Diagram

3. Access Point Masquerade Mode

The Access Point Masquerade mode is a special use of the Access Point mode where the Horizon will connect mobile clients into a single static IP address on a wired network. Data requests from the wireless network will be processed through the Access Point Masquerade modem, but any request from the wired Ethernet network to devices on the wireless network will be rejected similar to the operation of a “firewall”. The Horizon will hide all the IP addresses connected on the wireless link. You would use this mode of operation if Horizon is connected directly to the Internet with a static IP address (DSL, T1, etc.) and you want the wireless clients to access the information through the Horizon (Figure 4). This mode should also be used for attaching the Horizon to a network where few IP addresses are available or a firewall for the wireless clients is required.

Access Point Peer (Repeater) Mode

The Access Point Peer connection is a unique enhancement of the ESTeem Horizon series. The Access Point Repeater can be used with any of the above Access Point modes. With this repeater feature enabled, the Access Points do not have to be hardwired together on the same physical LAN to provide seamless Ethernet communication for roaming clients. In addition to greatly extending the Access Point canopy range, the Horizon will also bridge any Ethernet device or Ethernet network connected to the unit over this same wireless Ethernet network. This mode gives the user the features of a point to multi-point bridge network but also allows the Horizon in the Client mode to simultaneously roam under the network canopy.

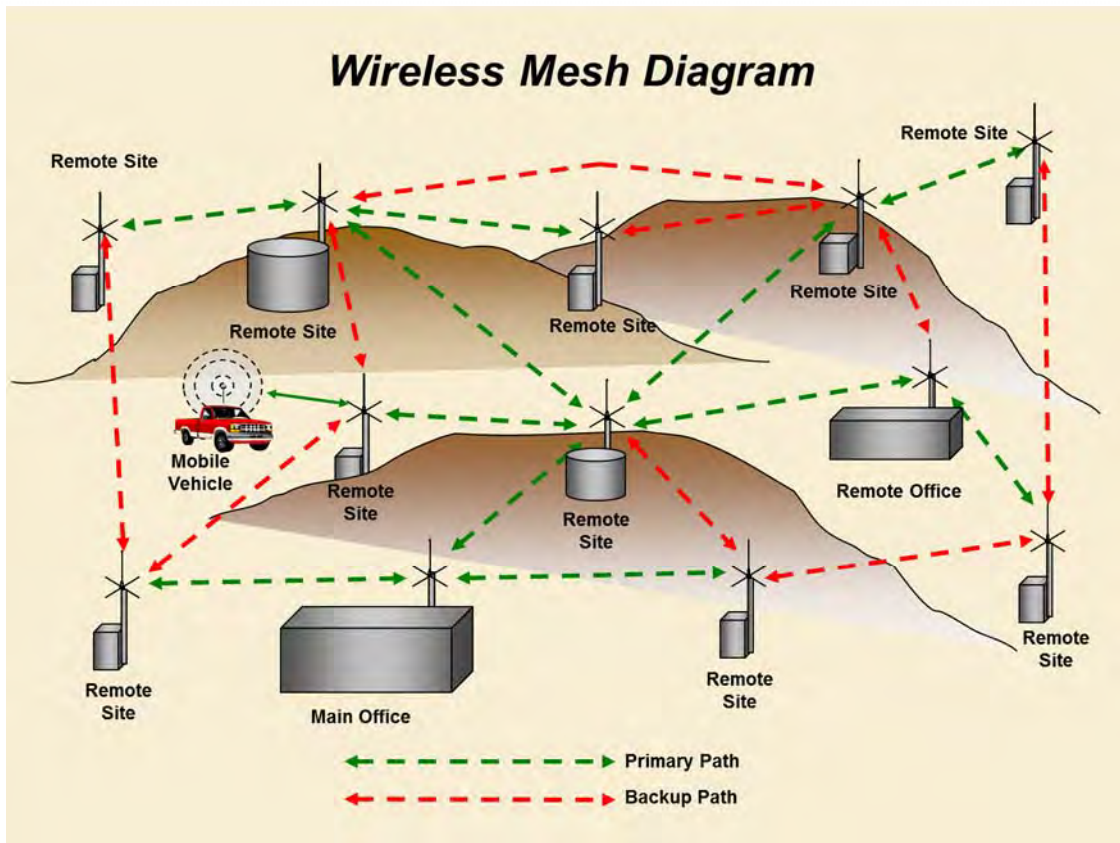

Figure 5: Mesh Network Diagram

Self-Healing Mesh Network

If multiple Access Point Repeater routes are configured to the same destination ESTeem, the Horizon will create a “self-healing” mesh network by automatically re-routing data through alternate paths to reach its destination if the primary path is inoperable. The routing and priority of alternate paths is completely user configurable. (See Figure 5)

Station (Client) Modes

1. **EtherStation Mode**

When the Horizon is configured in the EtherStation mode and attached to a single Ethernet Device, the Horizon will emulate an 802.11 wireless card in functionality for communication as a mobile client. The Horizon will seamless roam under the radio canopy of Access Points and can provide greatly increased range over a Wireless LAN Card for mobile Ethernet devices such as vehicles, forklifts, cranes, etc (Figures 2-4).

2. **Station Router Mode**

The Station Router mode will also functions as a mobile client, similar to EtherStation, but will allow multiple Ethernet devices to be connected to a single Horizon (Figure 4). The Horizon will function as a router between the wireless client mode and the wired Ethernet devices connected to the Ethernet port. Similar in configuration to the Access Point Router mode, the wireless and wired Ethernet networks will need to be on separate subnets. To communicate from wireless network to devices on the wired Station Router network, a separate router (connected to the Ethernet side of the Access Point) is required. This mode would be used where multiple Ethernet devices will be connected to a single Horizon in a mobile client application and the connected Ethernet devices will need to be accessible from the Access Point’s LAN network.

3. **Station Masquerade Mode**

The Station Masquerade mode is another case multiple devices will be connected to a single ESTeem in a mobile or client application. However, unlike the Station Router mode, the Station Masquerade will consolidate all connected Ethernet devices to a single IP address on the network. The devices connected to the Station Masquerade will be able to access information from both the wireless and wired LAN, but will be inaccessible the other way similar in application to a firewall. This mode would be used where multiple Ethernet devices will be connected to a single Horizon in a mobile application and the IP addresses for each device will be hidden from the LAN connected to the AP. See Figure 4.

RS-232 Serial Applications

The ESTeem Horizon is installed with an RS-232 data port for serial data applications run over the broadband link (Figure 6). The serial over broadband network can be used in a point-to-point or point-to-multi-point application for networking serial (RS-232C) devices, providing serial connections to legacy hardware in a new Ethernet network or providing for high-bandwidth devices (such as Video or Voice over IP) in an existing serial network.

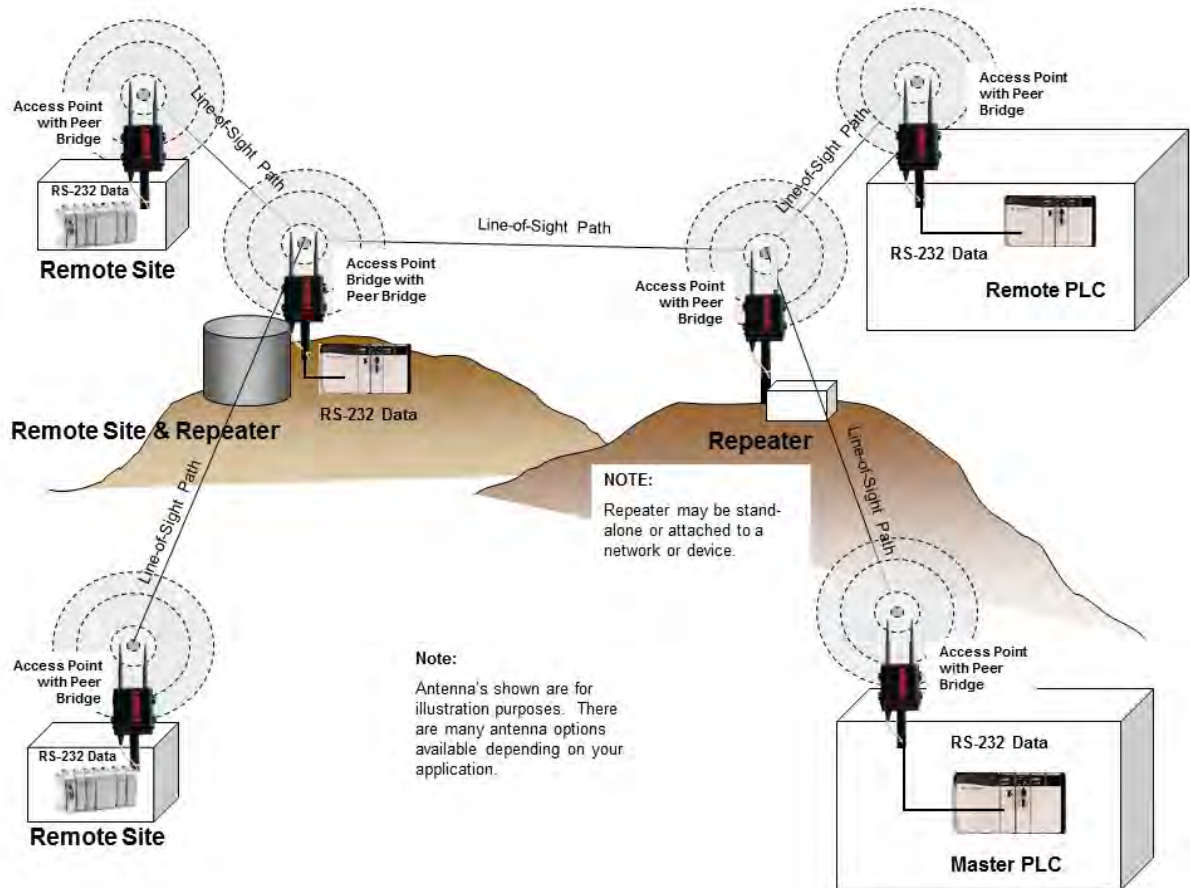

Figure 6: Multi-point Serial Diagram

To begin setup of your wireless Ethernet network, continue to Chapter 2 - Staring Out of this User's Manual.

OVERVIEW

There are three main phases to prepare the ESTeem Horizon for operation in a wireless network:

Phase 1 - Determine the correct mode of operation for the Horizon in the wireless network. The ESTeem Horizon is a sophisticated networking device that can be configured for multiple modes of operation. Determining the correct mode of operation for the ESTeem Horizon is the first step. Chapter 3 of this User's Manual details the modes of operation and applications where each would be used.

Phase 2 - Program the ESTeem for operation in the wireless network. Once the correct mode of operation for the ESTeem has been determined, the Horizon can be programmed for the wireless network. To simplify the programming of the Horizon, ESTeem has created a new software utility called the ESTeem Network Configuration (ENC) Utility which is used to graphically configure the primary and backup communication routes between radio modems in the network. The ENC Utility can be installed from the ESTeem Resource Disk or from the ESTeem web site (www.esteem.com). Chapter 4 (Utilities and Features) of this User's Manual will guide you in the installation of the software and give a brief overview of operation of the ENC Utility, but a detailed User's Guide is available both on the ESTeem Resource Disk and in the Help section of the program itself.

The ESTeem Horizon can also be programmed through the internal Web interface (discussed in detail in Chapter 5) if you do not have access to the ENC Utility.

Phase 3 - Install the ESTeem hardware and test communication. After the ESTeem Horizon programming, install the hardware in each remote location. Chapter 8 of this User's Manual describes the antenna specifications, mounting options and the configuration of the pole mounting hardware for the ESTeem. For instructions on testing and troubleshooting the wireless link, refer to Appendix F (Troubleshooting).

HORIZON HARDWARE LAYOUT

To begin the configuration, unpack the ESTeem Horizon shipping boxes and locate the items below for initial configuration. Take a few minutes to inventory your equipment before you proceed. Report any missing or damaged items to Customer Support (509-735-9092) as soon as possible. Each node in your ESTeem Horizon's network may have different hardware components based upon the final installation location (i.e. Outdoor, Indoor, Point-to-point or Muti-Point). Antenna types, cable lengths, power supplies may be different, but the following items will be required for basic setup:

Horizon Radio



AA109 Resource Disk



Antenna
(AA01S Displayed)



(2) Ethernet Cables



Power Supply
(AA175.2 Displayed)



Serial Interface Cable
(AA6021.1)



Note: Your accessory model numbers may vary from the above, but you will need to locate each of above items to continue configuration.

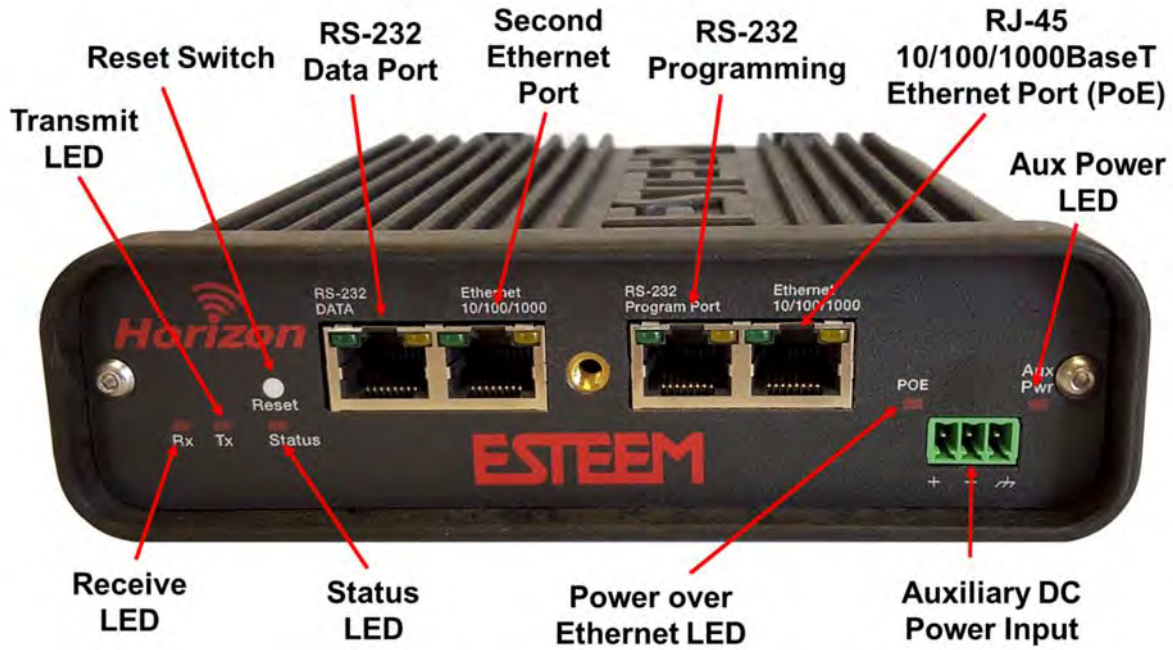

Figure 1: Horizon Front Panel Overview



Figure 2: Horizon Antenna Overview

HORIZON HARDWARE CONFIGURATION

The following steps should be completed to begin configuration of the ESTeem Horizon:

1. Connect the antenna to the antenna connector on the Horizon (Figure 3). For a single antenna use Antenna Port 1 and connect both if using dual antennas.

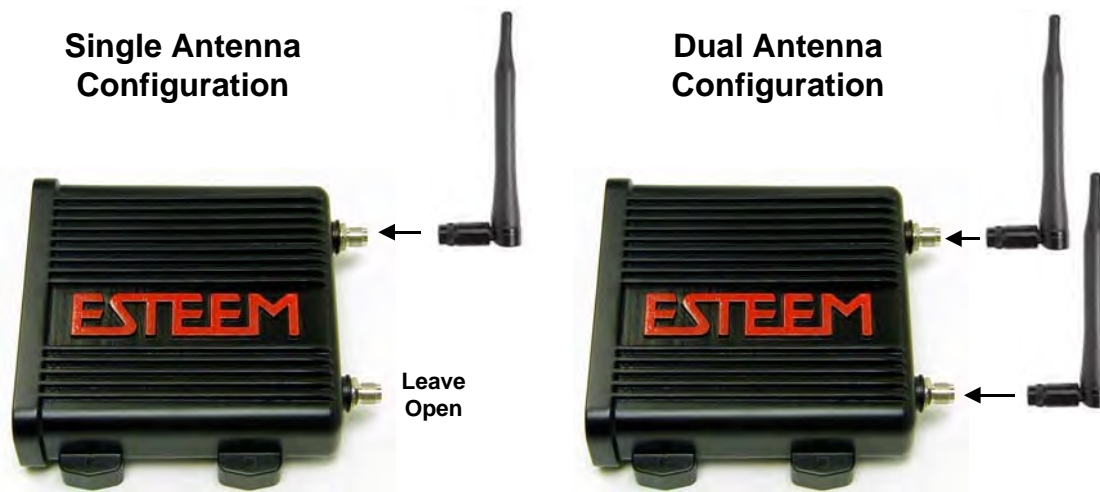
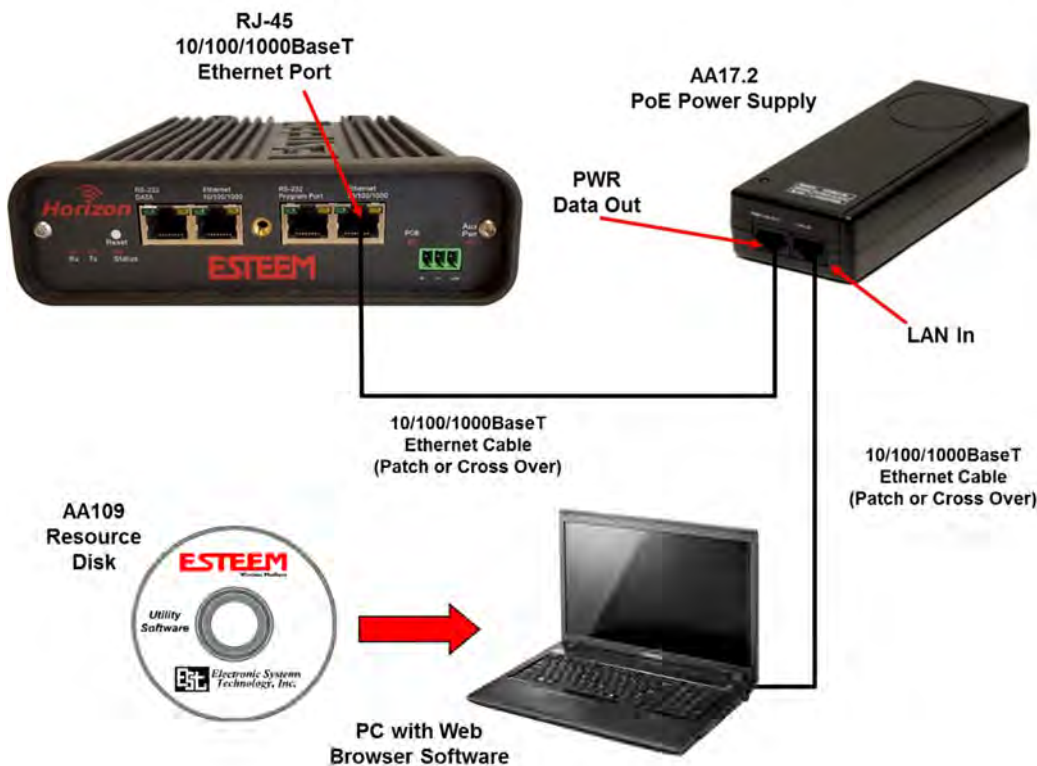

Figure 3: Antenna Configuration Diagram

2. Assemble the Horizon hardware as shown in Figure 4.



Technical Tips:

1. Configure the Horizon prior to mounting.
2. Attach antenna to the Horizon before powering up.

Figure 4: Hardware Configuration Diagram

MODES OF OPERATION

The ESTeem Horizon is a sophisticated wireless networking device that can be configured for multiple modes of operation. Determining the correct mode of operation for the ESTeem is the first step in creating a reliable wireless network. This chapter will explain each mode of operation, provide example applications and detailed programming information for each mode. Please review the following modes of operations. If you do not see an example of your application, please contact ESTeem support at 509-735-9092 for help in selecting your mode of operation.

Ethernet Bridge Mode (AP Bridge)

The most commonly used mode of operation with the ESTeem Horizon is the Ethernet bridge mode. The Ethernet bridge mode will connect two or more ESTeem Horizon's while passing all network traffic that arrives in both the wireless and connected Ethernet ports; including all global network traffic (Figure 1). This mode will work in most wireless applications of the Horizon to wirelessly connect two or more remote Ethernet devices or networks. The Ethernet bridge mode is also used in repeating (Figure 2) and in self-healing Mesh networks (Figure 3) for fixed (non-mobile) applications.

Example Applications

- Building to building remote wireless LAN networks
- Point to point wireless Ethernet communication devices
- Multi-point wireless Ethernet networks
- Remote Supervisory Control and Data Acquisition (SCADA) networks
- Redundant, self-healing Mesh networks
- Fixed locations with mobile ESTeem Horizon's

Applications Where Ethernet Bridge Mode Not Used

- Mobile applications (see Mobile Clients)
- Connections to large Ethernet traffic networks such as large office buildings or plant networks (see Router modes)

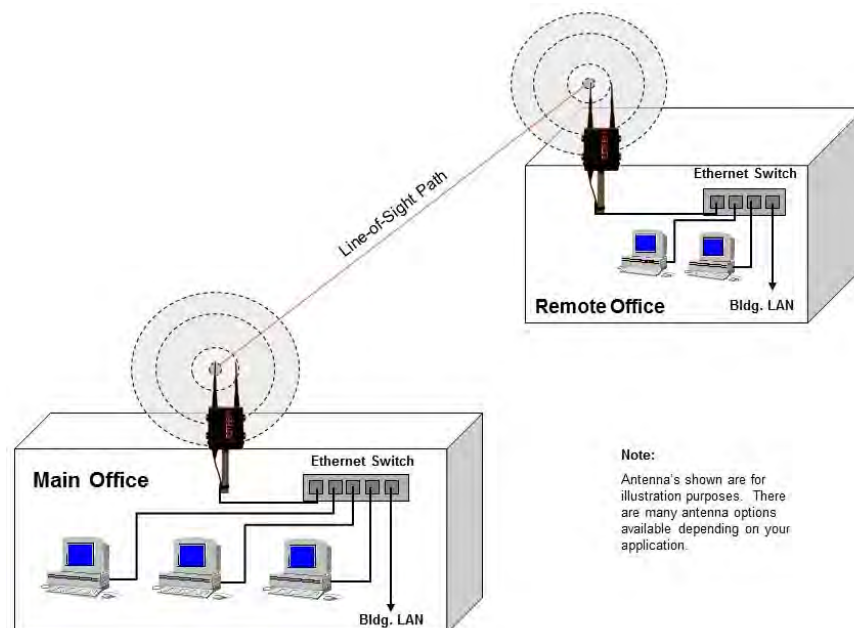

Figure 1: Point to Point Example

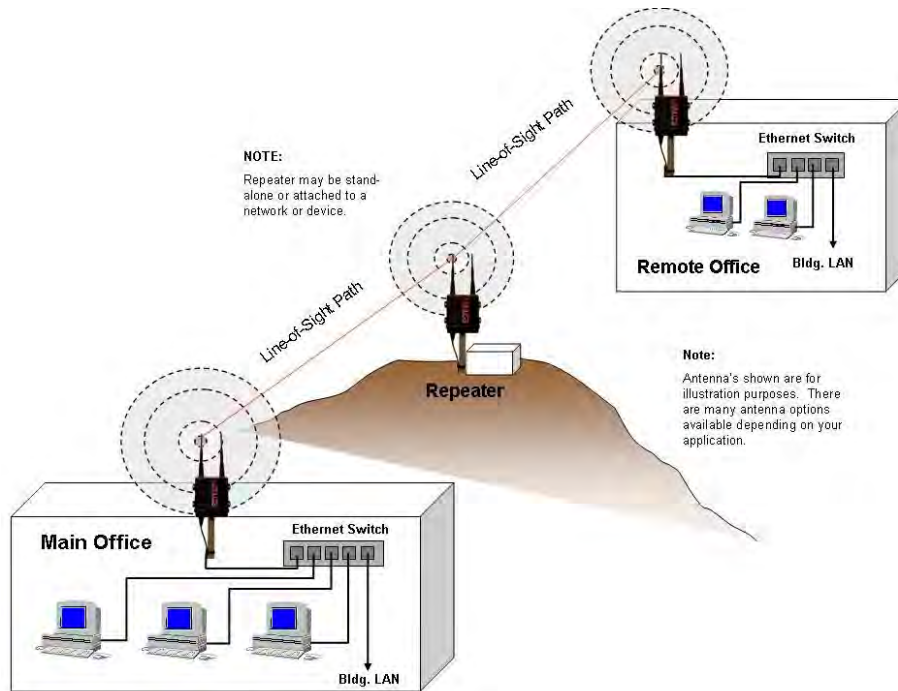

Figure 2: Ethernet Bridge with Repeater

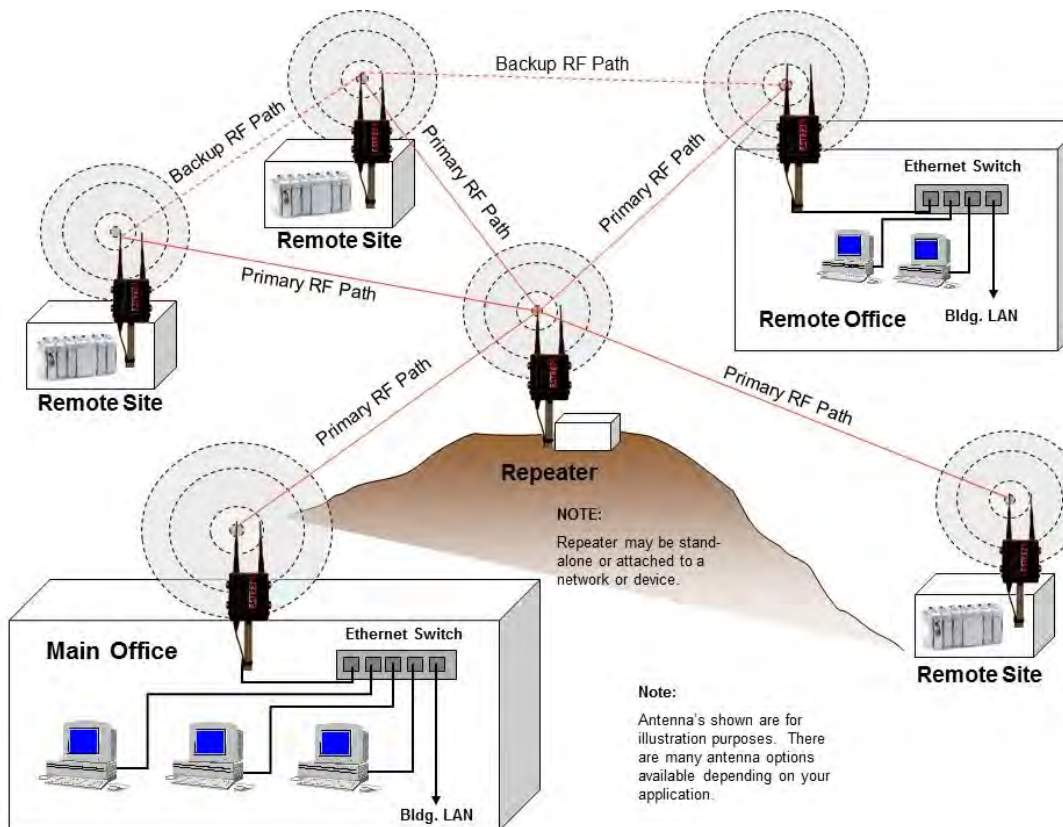

Figure 3: Multipoint Bridge with Mesh Networking

Router Modes (AP Router and AP Masquerade)

The ESTeem Horizon can be configured as a network router or network firewall between the Ethernet LAN connection and the wireless network of remote locations. The router modes are used to limit the network traffic from a busy Ethernet network connection to only those specific IP address used on the wireless network (see Figure 4). The Ethernet router mode (AP Router) will allow bi-directional communication from the Ethernet LAN connection to the wireless network. The Ethernet firewall mode (AP Masquerade) will allow Ethernet devices in the wireless network to request information from the Ethernet LAN network and receive a response, but no traffic can be generated from the Ethernet LAN side.

Example Applications

- Wireless Ethernet networks connected to large company or plant Ethernet LAN networks (AP Router)
- Wireless Ethernet networks with a requirement for network isolation from the plant or company network (AP Router)
- Shared Ethernet connection to direct Internet service (DSL, Cable, T1, etc.) (AP Masquerade)

Applications Where Ethernet Router Mode Not Used

- Mobile applications (see Mobile Clients)
- Simple network connections only using a single IP network subnet (see Ethernet Bridge modes)

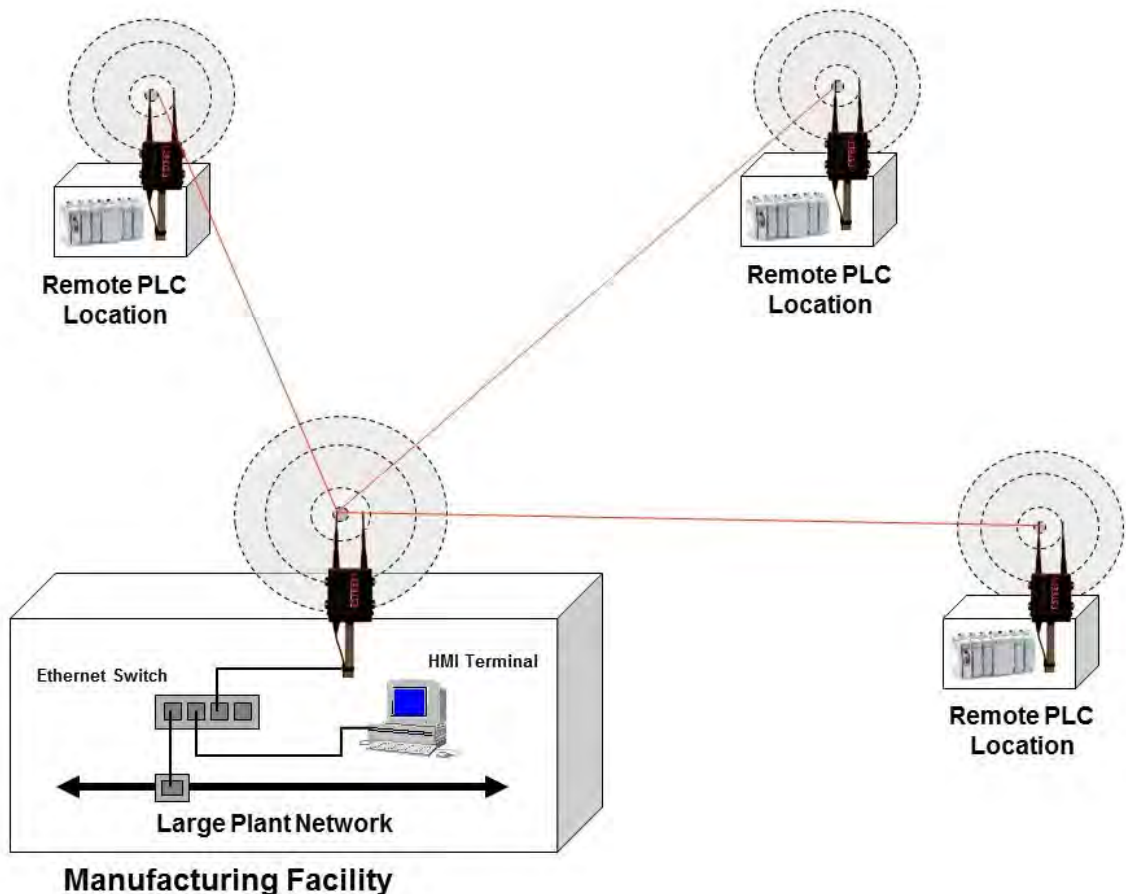

Figure 4: Router Mode Example

Mobile Client Modes (EtherStation, Station Router or Station Masquerade)

The ESTeem Horizon can also be configured to function as a mobile client. The client modes allow the Horizon to seamlessly roam between fixed Access Points. These Access Points can either be ESTeem Horizon wireless modems configured in one of the three Access Point modes (AP Bridge, AP Router or AP Masquerade – see above) or any IEEE 802.11 (Wi-Fi). The client modes will allow mobile Ethernet devices to connect to each other or to an Ethernet LAN through the fixed AP (Figure 5).

The EtherStation mode is used to connect a single Ethernet device to the ESTeem Horizon. If you are connecting the Horizon to multiple Ethernet devices in a mobile mode, the Station Router or Station Masquerade will be required. The Station Router will allow bi-directional communication between the Ethernet devices connected to the Horizon and the wireless network, while the Station Masquerade will serve as a firewall on the Ethernet side.

Example Applications

- Mobile applications where the Horizon will change links often between fixed Access Points
- Long range mobile client networks
- Public safety applications for police, fire and EMS

Applications Where Mobile Client Mode Not Used

- Fixed locations using Ethernet Bridging or Routing
- Wireless Ethernet networks with repeaters

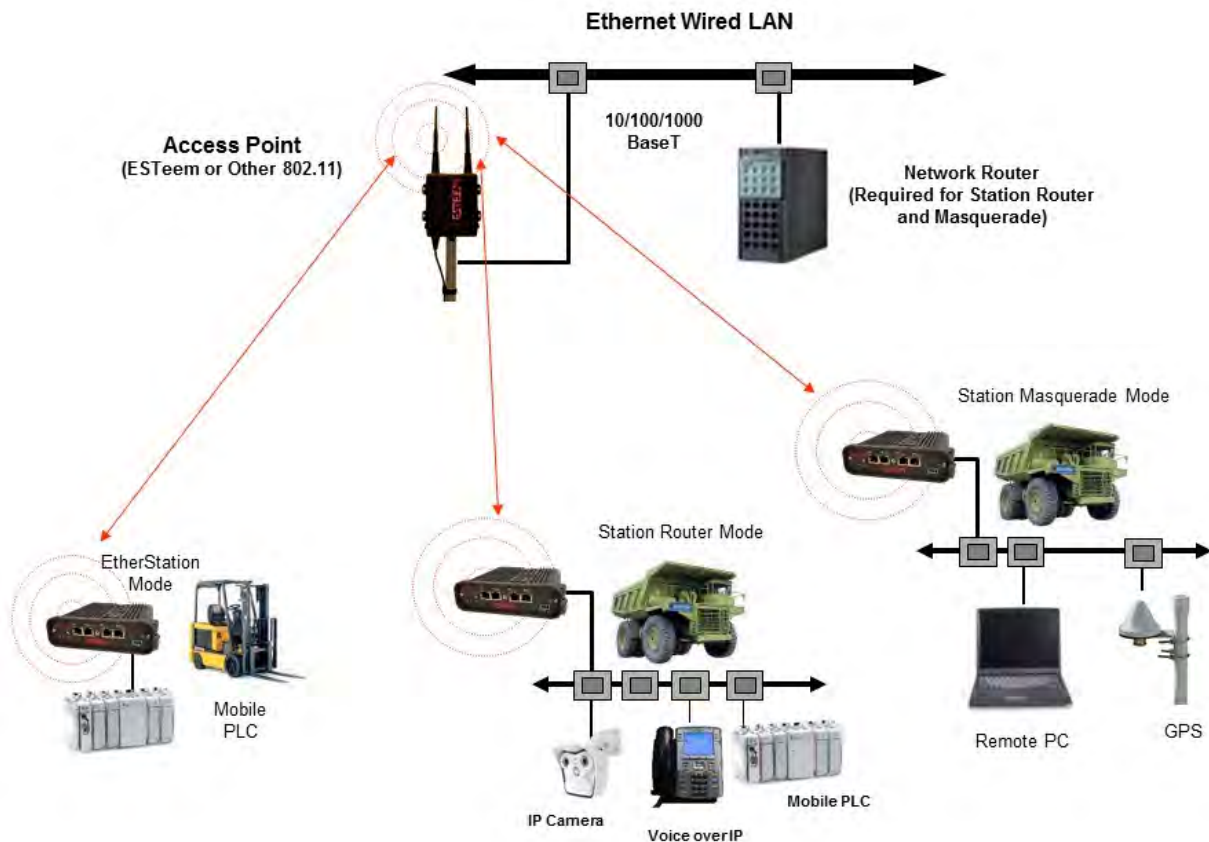

Figure 5: Router Mode Example

802.11 Access Point Modes (AP Bridge, AP Router or AP Masquerade)

The ESTeem Horizon can be configured as a high power 802.11 Access Point (AP). The IEEE 802.11n/g/b Access Point (AP) functionality is available in all three of the Access Point modes (AP Bridge, AP Router or AP Masquerade). The Access Point mode will provide either a single wireless connection (Figure 6) or overlapping coverage (Figure 7) to create a “canopy” of wireless coverage for 802.11 devices. The ESTeem Horizon in AP mode can function as both an Ethernet bridge or router and 802.11 AP simultaneously (Figure 8).

Example Applications

- Industrial, long range 802.11 (Wi-Fi) networks
- Hybrid networks of Ethernet bridging/routing and mobile client access

Applications Where Access Point (AP) Mode Not Used

- Mobile applications

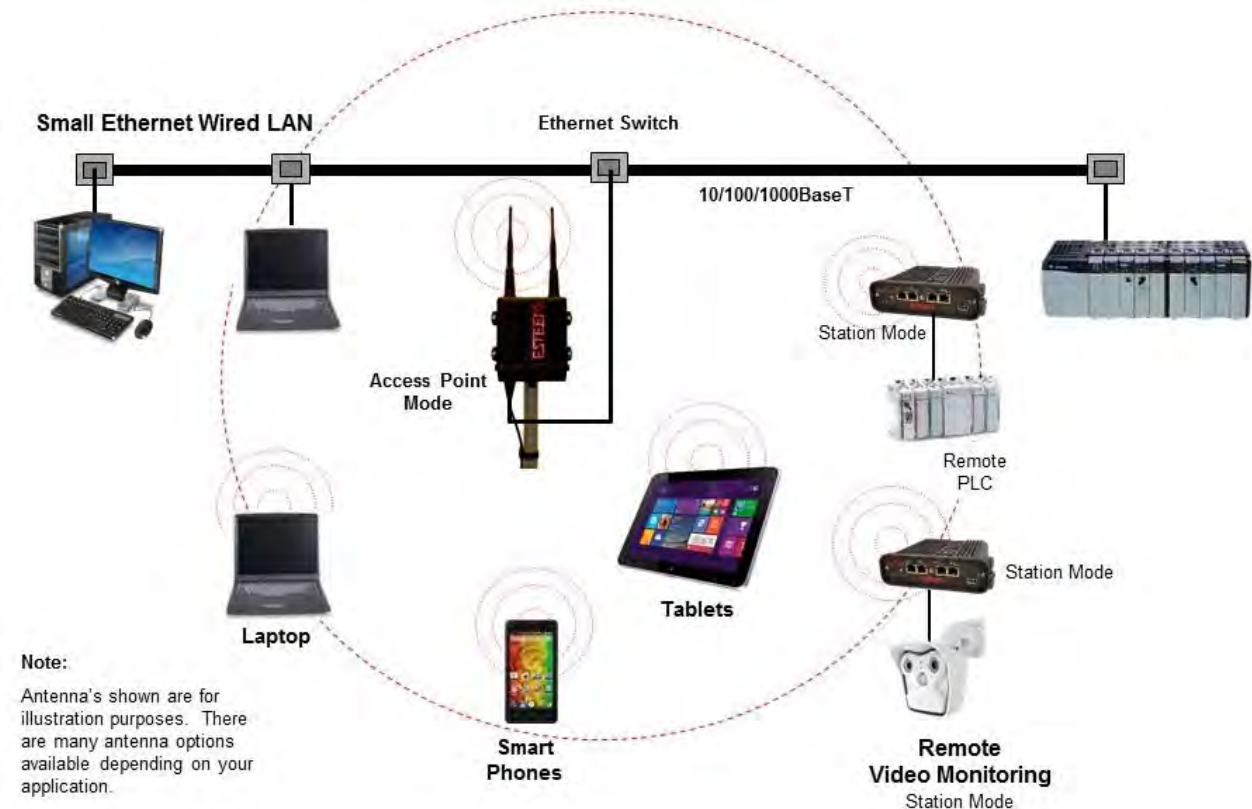

Figure 6: Single Access Point Network

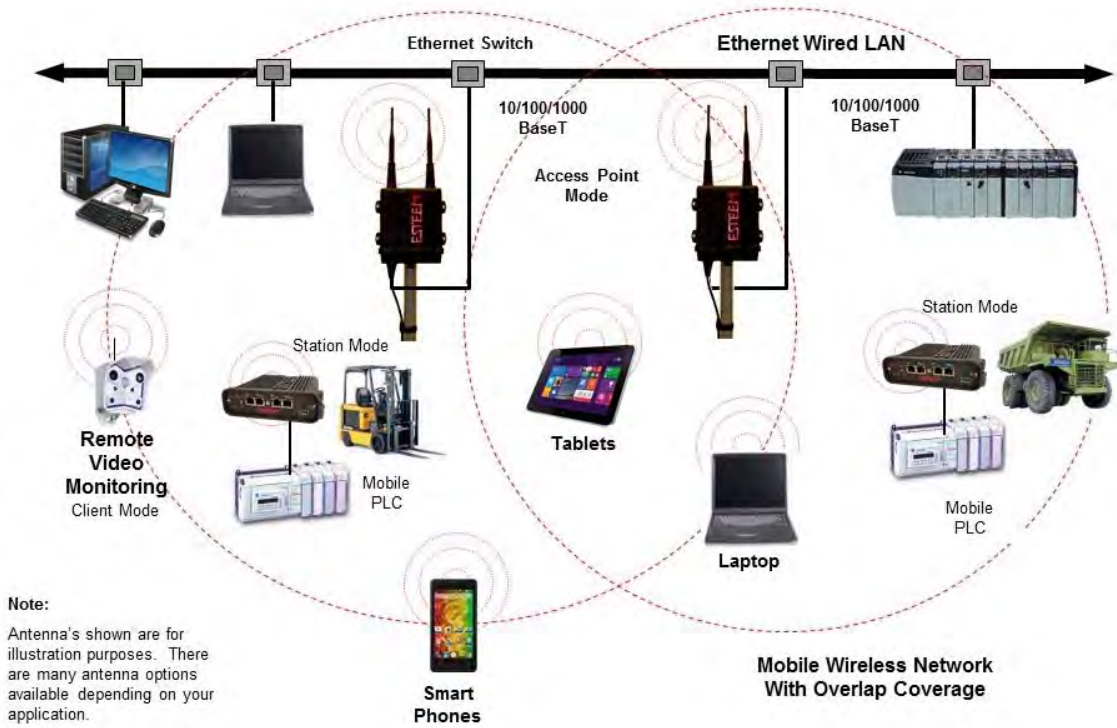

Figure 7: Overlapping Access Point Coverage

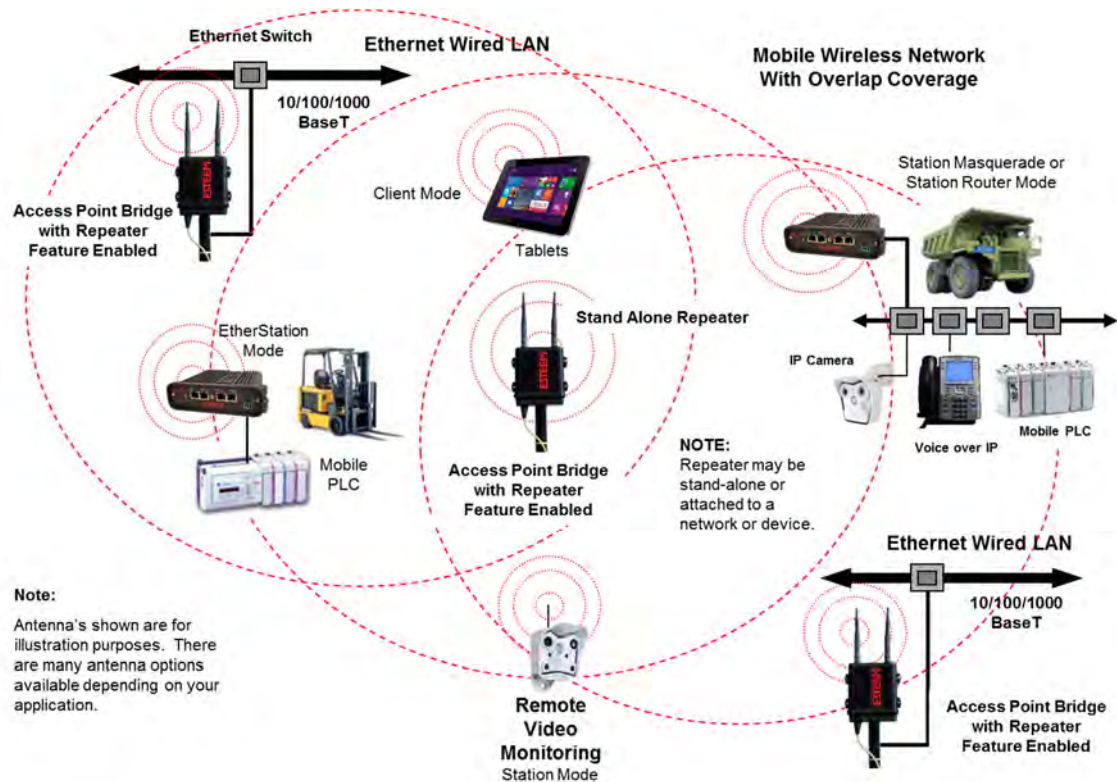

Figure 8: Access Point and Ethernet Bridge

PROGRAMMING EXAMPLES

Once the mode of operation for the ESTeem has been determined, you are now ready to program the Horizon for use. ESTeem has created a simplified network programming utility call the ESTeem Network Configuration (ENC) Utility. This ENC Utility will be used in all the following programming examples. For detailed instructions on installing the ENC Utility, please refer to the User's Guide (found in the ESTeem Resource CD or Utility program itself) or Chapter 4 of this User's Manual

Technical Tip: The ENC Utility calculates the wireless link information based upon **exact** ESTeem serial numbers. The serial numbers listed in the following examples are for example only. Enter the correct ESTeem serial numbers for your application.

Adding Esteem's to ENC Utility and Changing Name

Each of the example applications will use the following procedure to add and rename ESTeem Horizon's.

1. Consult the ENC Utility's User Guide on how the create a new wireless network. Once you have a blank network configuration page (Figure 9), select ESTeem from the menu items to display the drop down menu, then select New>New ESTeem.

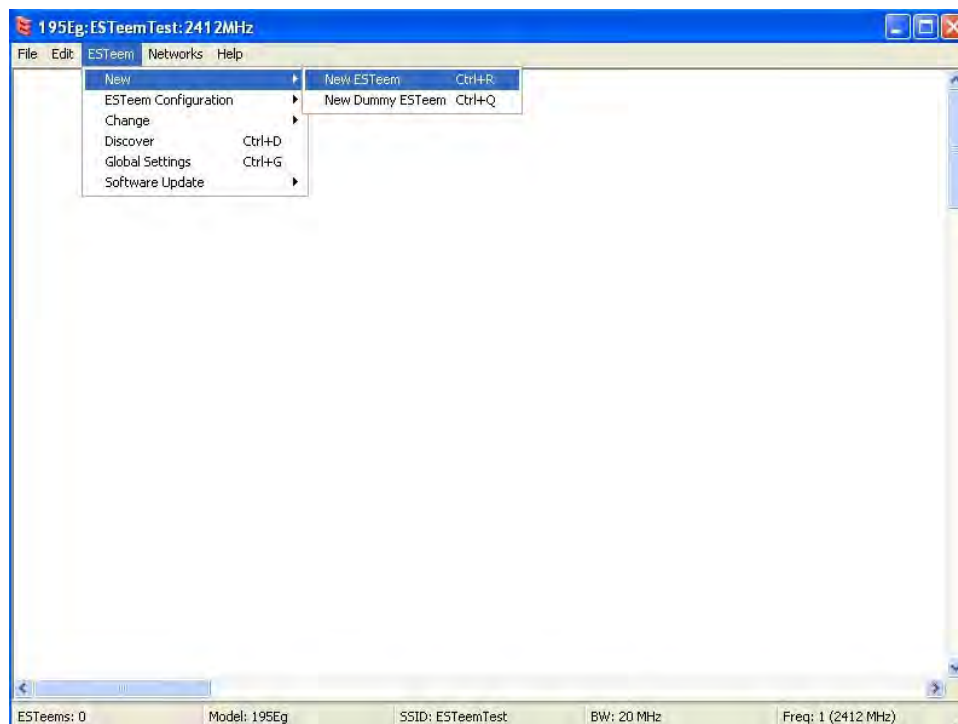

Figure 9: Adding ESTeem to Blank ENC Configuration Page

2. Enter in the ESTeem Horizon serial numbers used for the example (for example enter Z-14000 in the Set Serial Number Box) and press the OK button (Figure 10). The ENC Utility will look up the ESTeem Horizon's serial number in the database and match the correct Wireless LAN MAC (WLAN MAC) address to the modem. This WLAN MAC address will be displayed above the modem symbol on the screen (Figure 11).

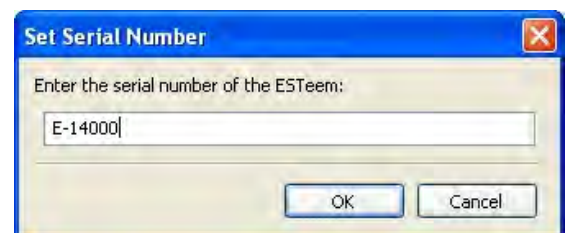

Figure 10: Enter the Serial Number

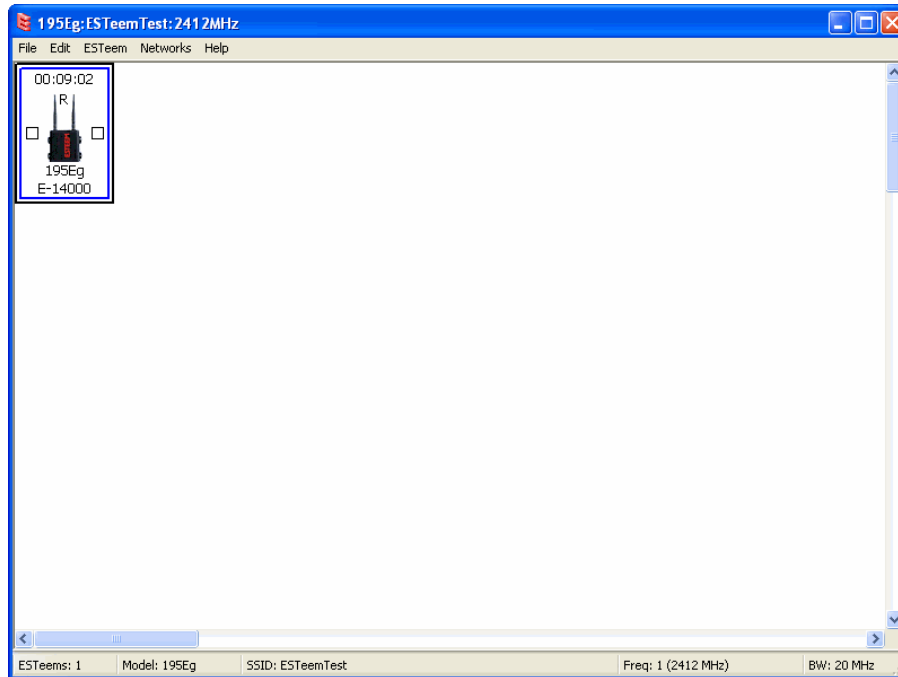

Figure 11: Main Office ESTeem Horizon

3. To change the name of the ESTeem Horizon from the WLAN MAC address to “Main Office” (or any other location name) to match the example configuration, Right-Mouse click on the ESTeem icon and select Change>Change Modem ID (Figure 12). Enter “Main Office” in the pop-up window and select OK.
4. Duplicate the above procedure for each ESTeem Horizon added to the network.

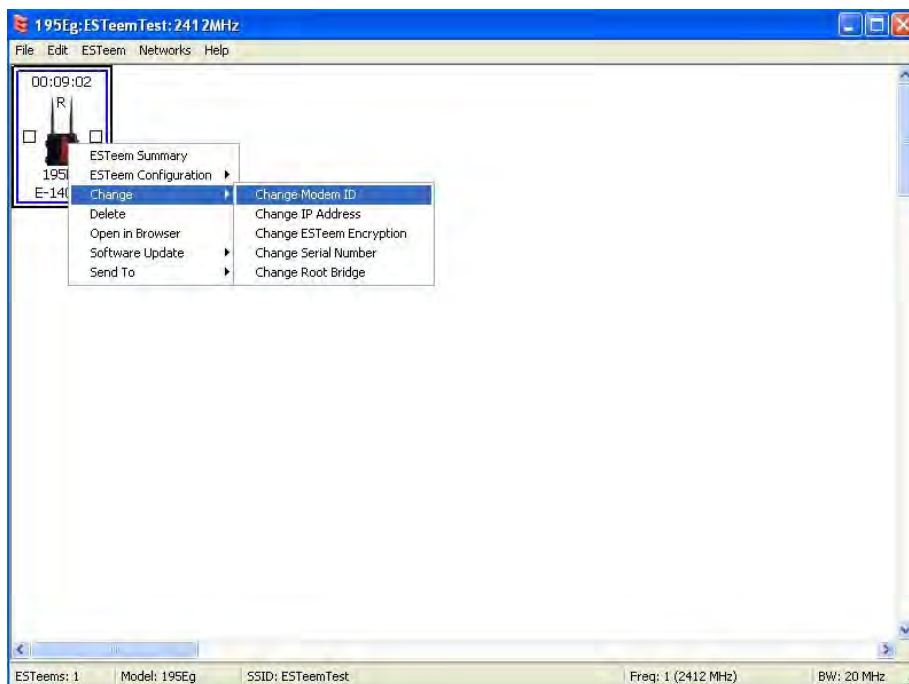

Figure 12: Change Modem ID

Ethernet Bridge Mode Example 1 (Figure 1)

Point to Point Ethernet Bridge

(2) ESTeem Horizon

Serial Numbers: Z-14000 (Main Office) and Z-14001 (Remote Office)

1. Add the two ESTeem Horizons to the network using the above procedure. Once both ESTeem Horizons are on the configuration page, create a wireless link by clicking on one of the two connection boxes and dragging a line to the other modem (Figure 13).
5. Verify both ESTeem modems are connected to the same switch as the computer running the ENC Utility and send the configuration to both modems at the same time by selecting ESTeem>ESTeem Configuration>Send Configuration to All ESTeems (Figure 14).
6. Once the ENC Utility has downloaded the configuration for both ESTeem Horizons, the status box around the ESTeems will change from yellow to blue. This indicates that the configuration was completed successfully and the ESTeem Horizons are ready to be installed in the application.

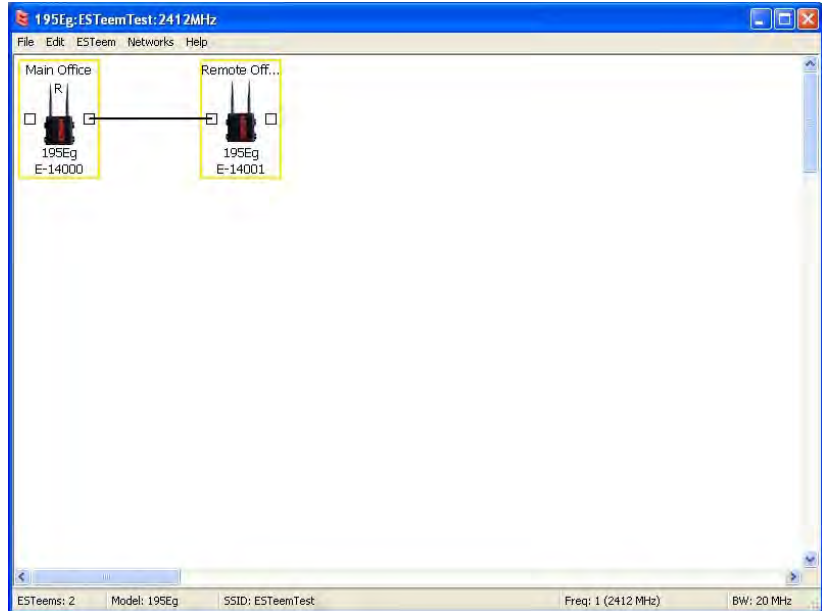

Figure 13: Create Wireless Link

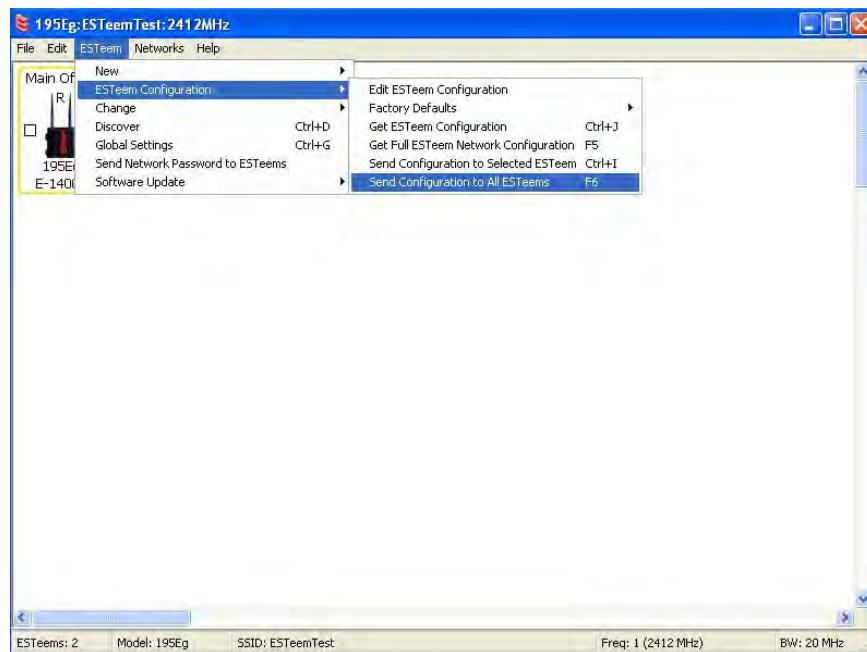

Figure 14: Send Configuration to ESTeem's

Ethernet Bridge Mode Example 2 (Figure 2)

Point to Point with Repeater Ethernet Bridge

(3) ESTeem Horizon

Serial Numbers:

Z-14000 (Main Office)

Z-14001 (Remote Office)

Z-14002 (Repeater)

1. Using the above procedure, enter the three ESTeem Horizons into the ENC Utility. Your layout should appear like Figure 14.
2. Move the ESTeem Horizon icons on the screen to simulate the layout of the diagram. Draw connection lines between the modems to make the wireless link in the same order as the network layout (Figure 15).

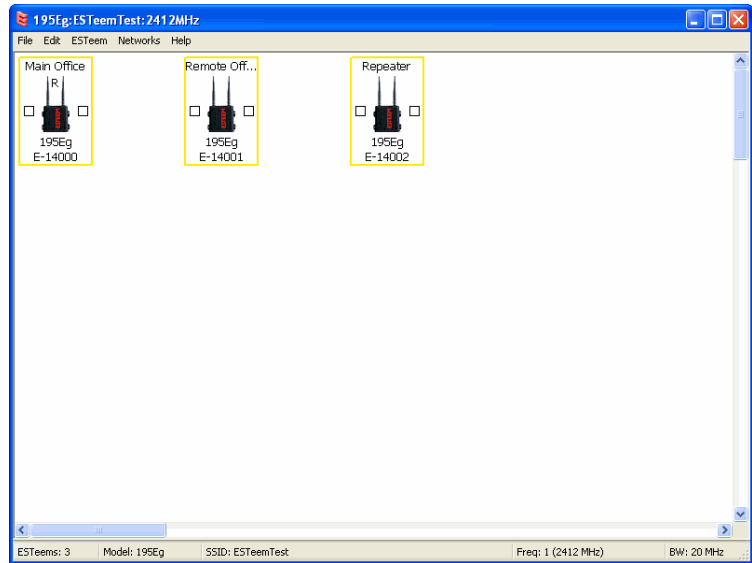

Figure 14: Example 2 Modems

3. Verify all ESTeem modems are connected to the same switch as the computer running the ENC Utility and send the configuration to both modems at the same time by selecting ESTeem>ESTeem Configuration>Send Configuration to All ESTeems. Once the ENC Utility has downloaded the configuration for both ESTeem Horizon's, the status box around the ESTeem's will change from yellow to blue. This indicates that the configuration was completed successfully and the ESTeem Horizon's are ready to be installed in the application.

Technical Tip: Although it does not matter where the ESTeem icons are located on the screen, putting them in the same layout as the application makes it easier to visually verify the network connections.

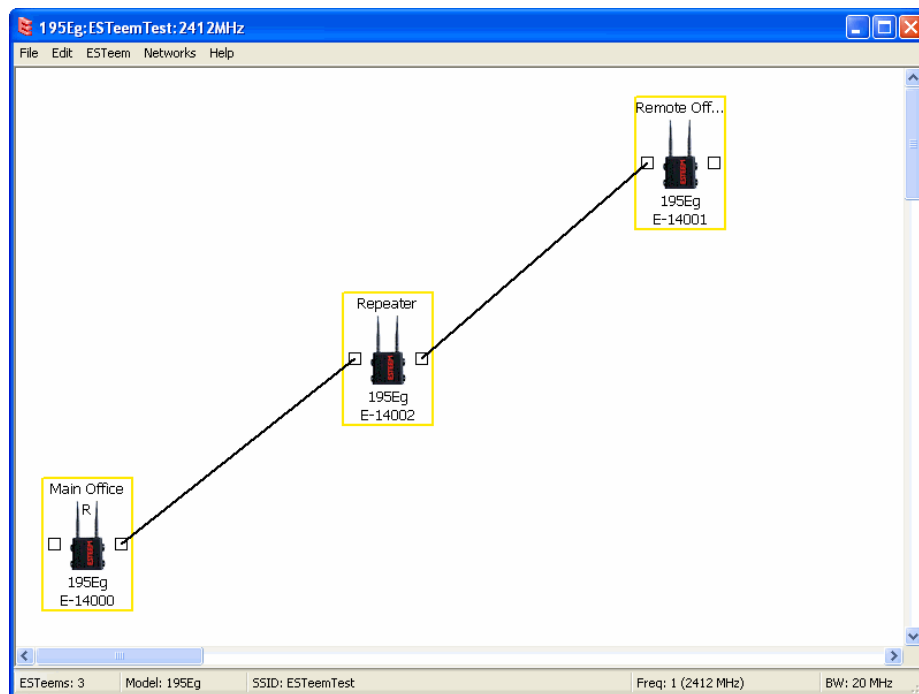

Figure 15: Example 2 Layout

Ethernet Bridge Mode Example 3 (Figure 3)

Point to Multipoint with Mesh Repeater Links

(6) ESTeem Horizon

Serial Numbers:

Z-14000 (Main Office)

Z-14001 (Remote Office)

Z-14002 (Repeater)

Z-14003 (Remote Site 1)

Z-14004 (Remote Site 2)

Z-14005 (Remote Site 3)

- Using the above procedure for adding ESTeem Horizons, add the six ESTeem Horizons for this example and rename by location. Your layout should appear like Figure 16.
- Move the ESTeem Horizon icons on the screen to simulate the layout of the diagram. Draw connection lines between the primary wireless links modems in the same order as the network layout (Figure 17).

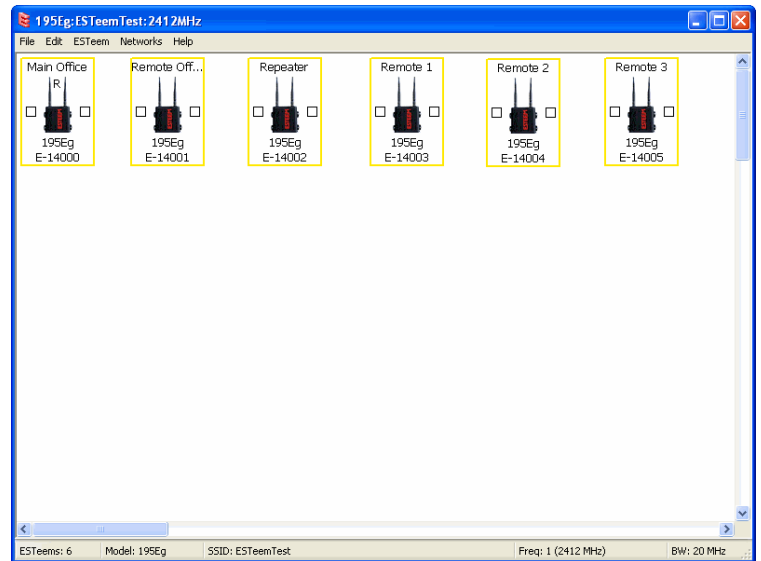

Figure 16: Example 3 Modems

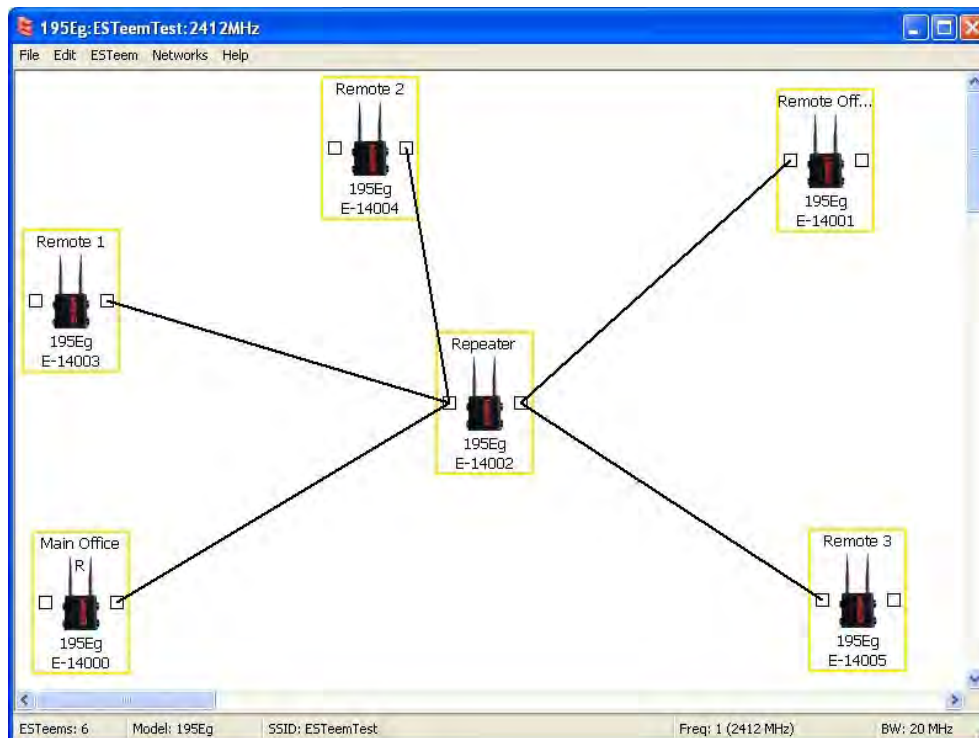

Figure 15: Example 2 Layout

- To create the backup link between Remote 1 and Remote 2 and the other backup link from Remote 2 to the Remote Office, draw a wireless connection as you would on the primary link. Double-click on the line created. The Link Editor box will be displayed (Figure 16). Any Path Length greater than 1 will display as a dashed line indicating a backup link in the repeater

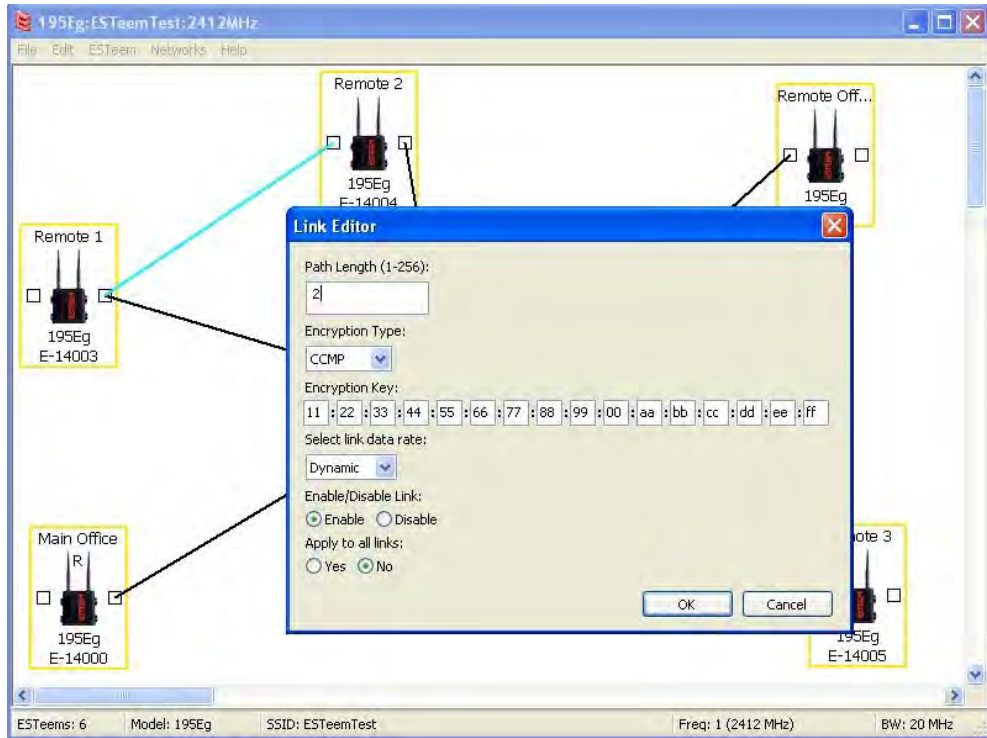

Figure 16: Backup Link Configuration

Mesh configuration (Figure 17). For detailed instruction on Mesh network configuration, refer to Chapter 7 of this User's Manual.

4. Verify all ESTeem modems are connected to the same switch as the computer running the ENC Utility and send the configuration to all modems at the same time by selecting ESTeem>ESTeem Configuration>Send Configuration to All ESTeems. Once the ENC Utility has downloaded the configuration for both ESTeem Horizon's, the status box around the ESTeem's will change from yellow to blue. This indicates that the configuration was completed successfully and the ESTeem Horizon's are ready to be installed in the application.

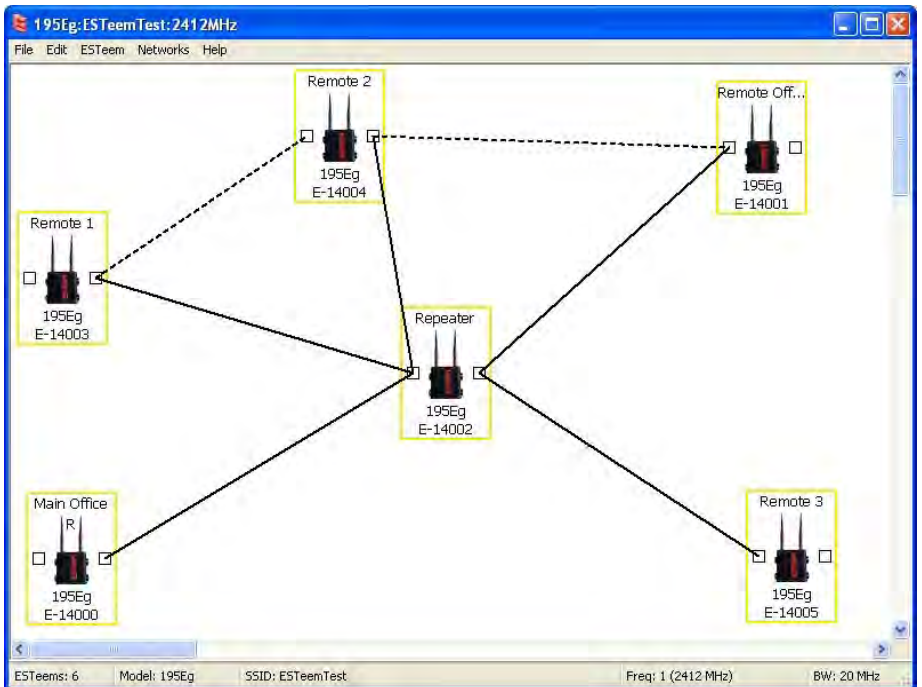

Figure 17: Mesh Network Configuration

Ethernet Router Mode Example (Figure 4)

Point to Multipoint Router Mode

(4) ESTeem Horizon

Serial Numbers:

Z-14000 (Router at Network)

Z-14001 (Remote Site 1)

Z-14002 (Remote Site 2)

Z-14003 (Remote Site 3)

- Using the above procedure for adding ESTeem Horizons, add the four ESTeem Horizons for this example and rename by location. Your layout should appear like Figure 18.
- Move the ESTeem Horizon icons on the screen to simulate the layout of the diagram. Draw connection lines between the wireless links modems in the same order as the network layout (Figure 19).

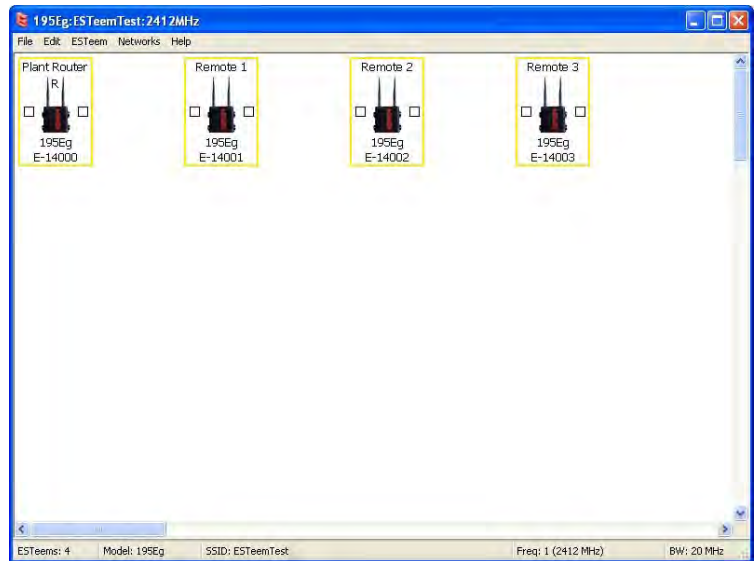

Figure 18: Router Mode Example Modems

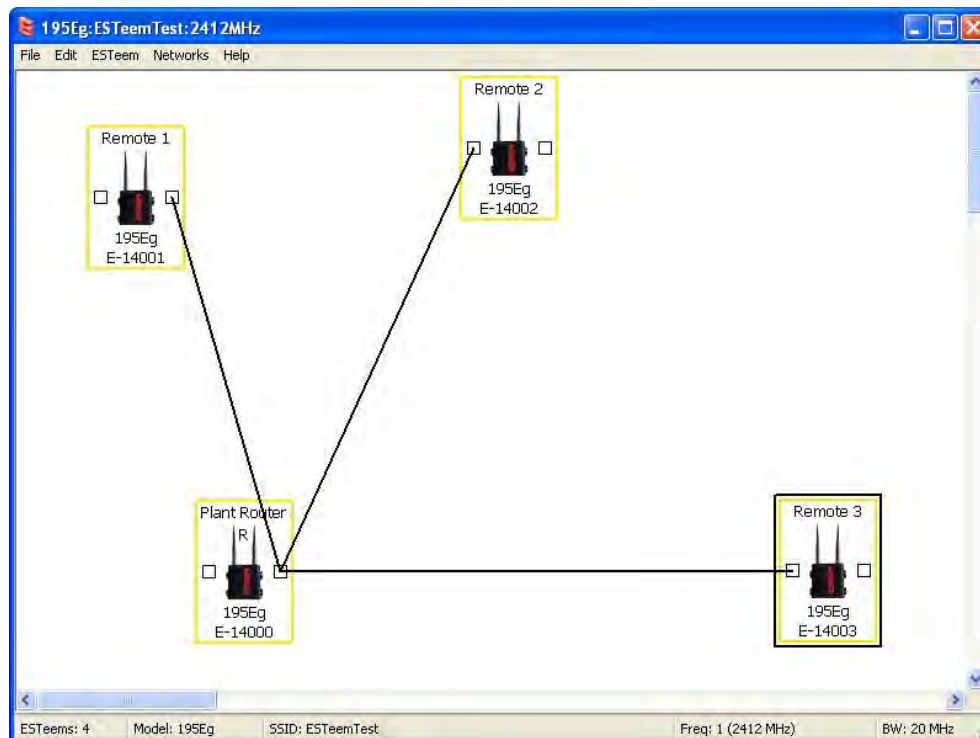

Figure 19: Router Example Layout

- By default, the ENC Utility sets all ESTeem modems in AP Bridge mode. To change the Plant Router ESTeem to AP Router mode, double-click on the icon to bring up the ESTeem Summary window and press the Edit button (Figure 20).
- Change the Mode of Operation from AP Bridge to AP Router (or Masquerade if desired) and press the Next button at the bottom of the window (Figure 21).

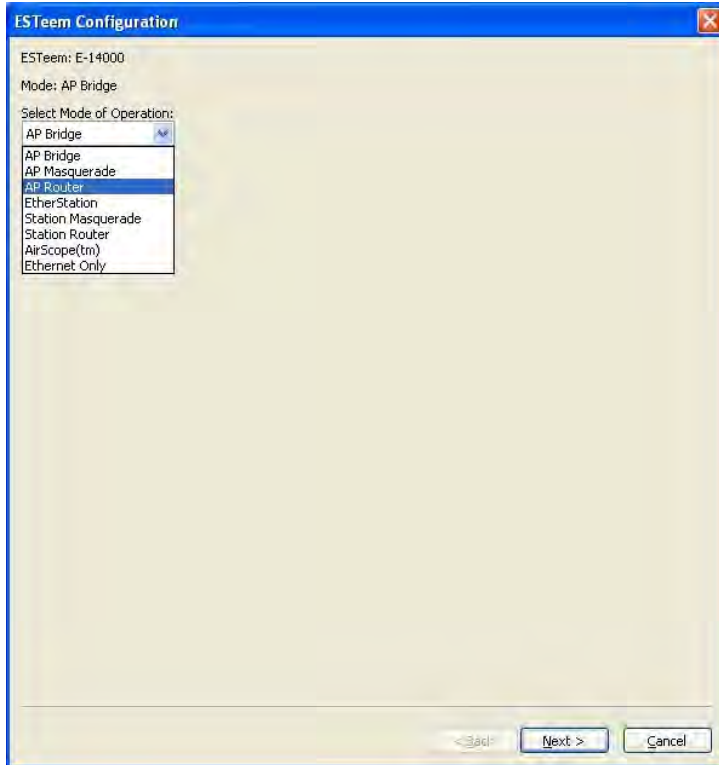

Figure 21: AP Router Configuration

- Continue through the configuration screens setting the AP Router addressing to match the IP address ranges for your network. For help with setting the router addressing please refer to Router Address Examples later in this chapter. You will end on the screen in Figure 22. Press the Finish button to return to the configuration page.
- Verify all ESTeem modems are connected to the same switch as the computer running the ENC Utility and send the configuration to all modems at the same time by selecting ESTeem>ESTeem Configuration>Send Configuration to All ESTeem's. Once the ENC Utility has downloaded the configuration for both ESTeem Horizons, the status box around the ESTeem's will change from yellow to blue. This indicates that the configuration was completed successfully and the ESTeem Horizons are ready to be installed in the application.

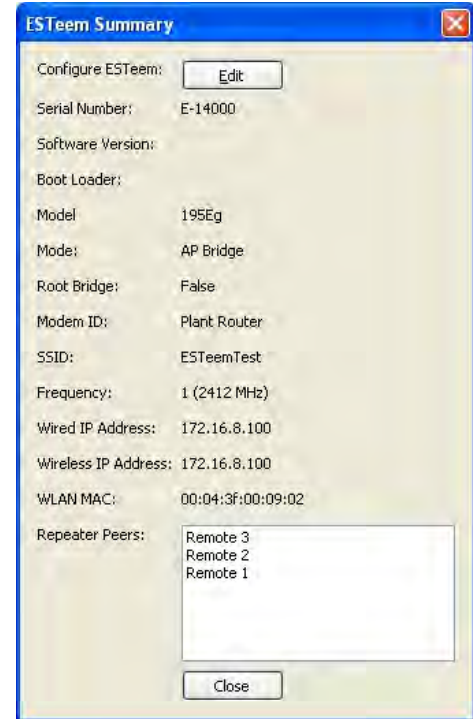

Figure 20: ESTeem Summary Page

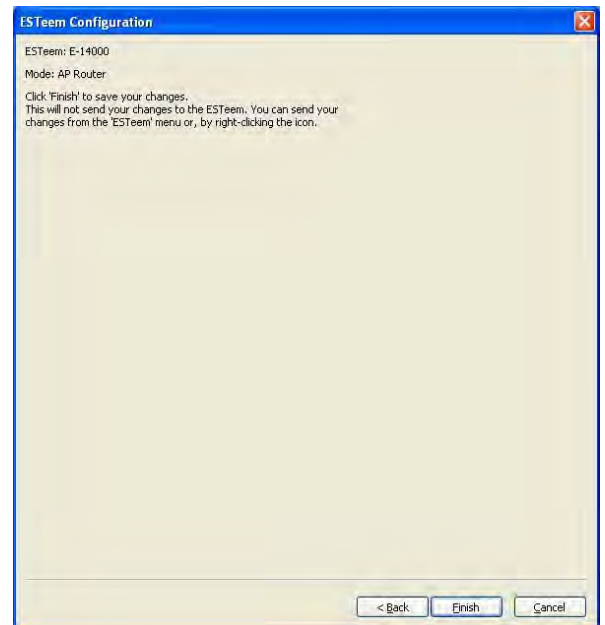

Figure 22: ESTeem Summary Page

Mobile Client Mode Example (Figure 5)

EtherStation, Station Router and Station Masquerade Modes

- (3) ESTeem Horizon
 Serial Numbers:
 Z-14000 (EtherStation)
 Z-14001 (Station Router)
 Z-14002 (Station Masquerade)

Technical Tip: The ESTeem Horizon’s in Mobile Client modes do not have a specific frequency of operation as can be seen in Figure 24.

Setting the ESTeem for Mobile Client (station) mode with the ENC Utility is different than the Bridge/Router or Access Point (AP) modes. ESTeem modems configured in as a Mobile Client will not link with a specific fixed modem; but will roam between any 802.11 Access Point with the correct Network Name (SSID) and Encryption. The ESTeem configured as a client is also not set on a specific operating frequency (channel) but will scan all channels looking for the AP. Use the following procedure to configure an ESTeem Horizon in one of the three mobile client modes:

1. Starting a new network of ESTeem Horizons in Mobile Client mode is the same as any of the Bridge modes except when you are asked for the frequency (channel) of operation, select “Station” (Figure 23).
2. Add the three mobile client modems to the ENC Utility configuration page as instructed above and set the Modem ID to match the three modes of operation. Your configuration will appear as in Figure 24.

EtherStation

3. By default, the ENC Utility sets all station mode ESTeem modems to EtherStation mode. The only adjustment necessary to the EtherStation modem in our example is to enter the connected Ethernet device’s MAC address. The ESTeem Horizon will “clone” the Ethernet MAC address of the connected Ethernet device. To configure the EtherStation modem, double-click on the icon to bring up the ESTeem Summary window and press the Edit button (Figure 20).
4. EtherStation mode should be selected in the Mode of Operation. Press the Next button at the bottom of the window to continue. Enter the connected Ethernet device’s MAC address in the “Device MAC Address” box (Figure 25) and press the Next button at the bottom of the window to continue.
5. Verify the encryption settings are correct for the 802.11 AP network in which the EtherStation modem will be working and press the Finish button to return to the configuration page.

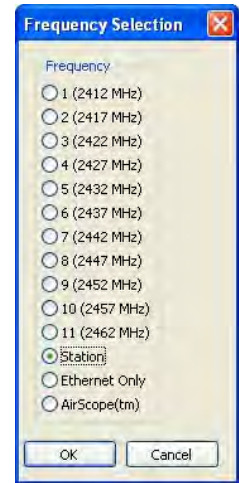

Figure 23: Station

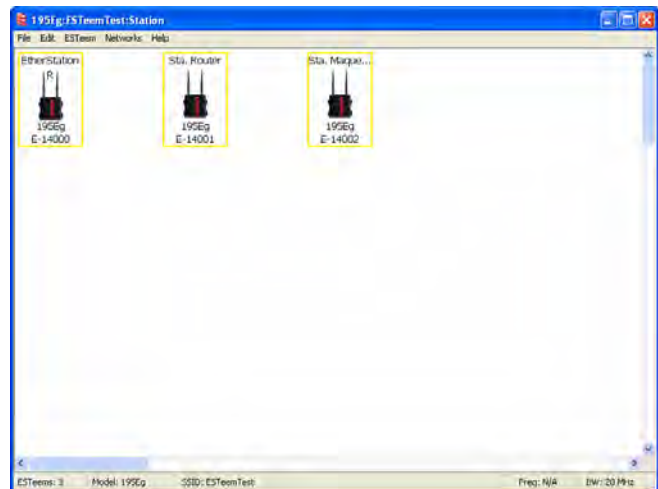

Figure 24: Station Mode Example Modems

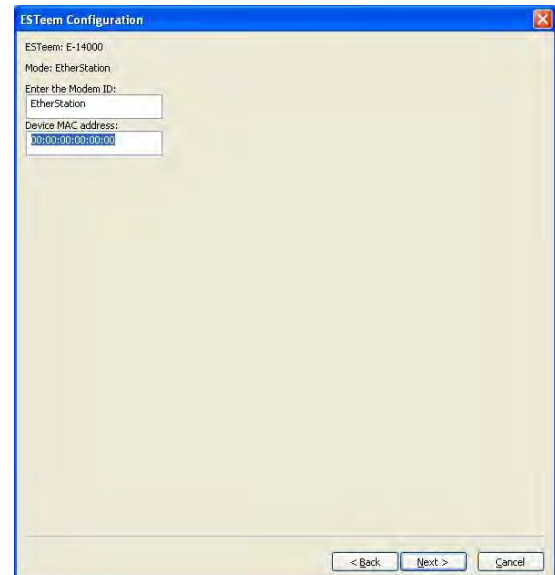

Figure 25: MAC Address Entry

Station Router and Station Masquerade

6. To configure the two other modems, double-click on their icons to bring up the ESTeem Summary window and press the Edit button (Figure 20).
7. Select Station Router for Z-14001 and Station Masquerade for Z-14002 in the Mode of Operation (Figure 26). Press the Next button at the bottom of the window to continue.
8. Continue through the configuration screens setting the Station Router/Masquerade addressing to match the IP address ranges for your network. For help with setting the router addressing please refer to Router Address Examples later in this chapter.
9. Verify the encryption settings are correct for the 802.11 AP network in which the EtherStation modem will be working and press the Finish button to return to the configuration page.
10. Verify all ESTeem modems are connected to the same switch as the computer running the ENC Utility and send the configuration to all modems at the same time by selecting ESTeem>ESTeem Configuration>Send Configuration to All ESTeems. Once the ENC Utility has downloaded the configuration for both ESTeem Horizons, the status box around the ESTeems will change from yellow to blue. This indicates that the configuration was completed successfully and the ESTeem Horizons are ready to be installed in the application.

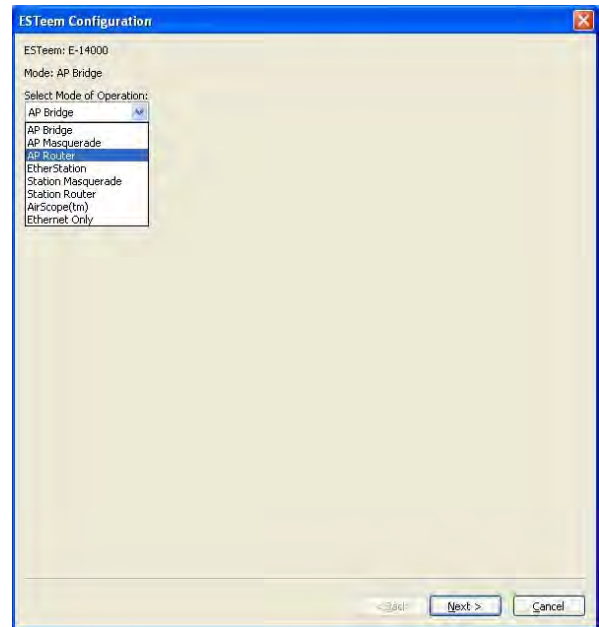

Figure 26: Mode of Operation Selection

802.11 Access Point Modes (Figures 6-8)

Access Point Bridge, Router or Masquerade Modes

Configuring the ESTeem Horizon as an Access Point for 802.11 clients (as seen Figures 6-8) is exactly the same as configuration for AP Bridge, AP Router and AP Masquerade as shown above. The only difference being that a wireless link is only added between ESTeem Horizons where a wireless connection is necessary. In figures 6 and 7 there would be no wireless link listed in the ENC Utility. In figure 8, the configuration would be exactly as shown in Figure 2 with the addition of the mobile clients in the network.

The 802.11 clients will use the SSID configured during the setup of the network with the ENC Utility. The encryption will be set at the factory default settings for clients (WPA PSK). To adjust the encryption type, right-mouse click on the ESTeem icon and select *Change>Change ESTeem Encryption* (Figure 27).

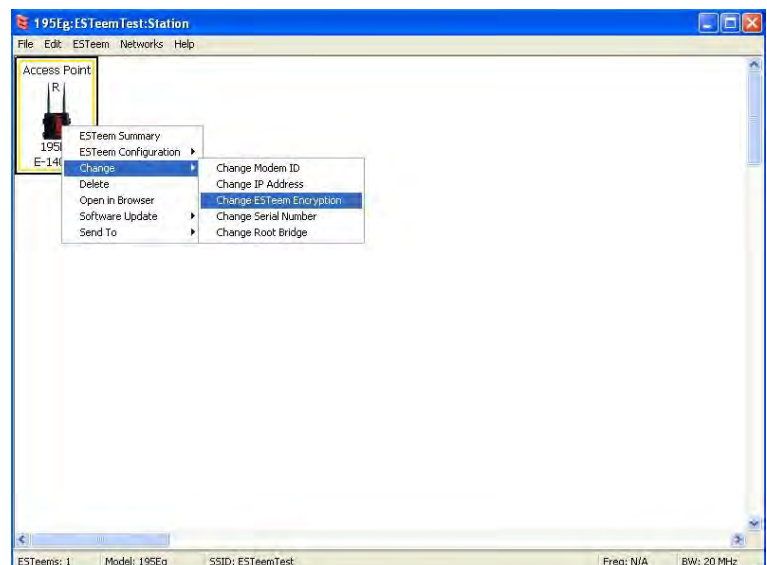

Figure 27: Encryption Configuration

ROUTER ADDRESSING EXAMPLES

The following are examples of the IP addressing and subnets required for the ESTeem Router modes.

Point to Point Access Point Router to Station Router

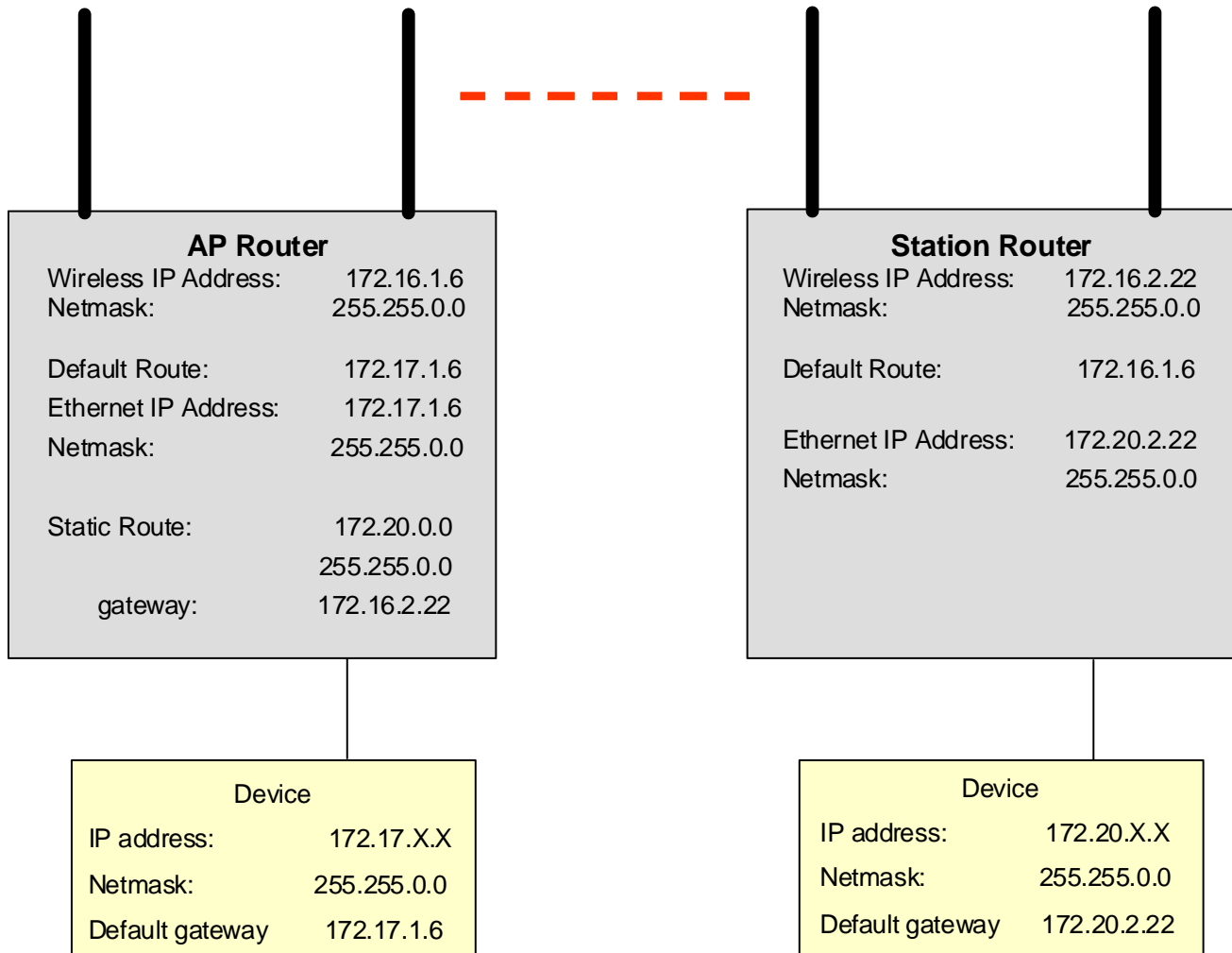

Figure 28: AP Router Addressing Example

Stand-Alone Access Point Router and Single Station Router

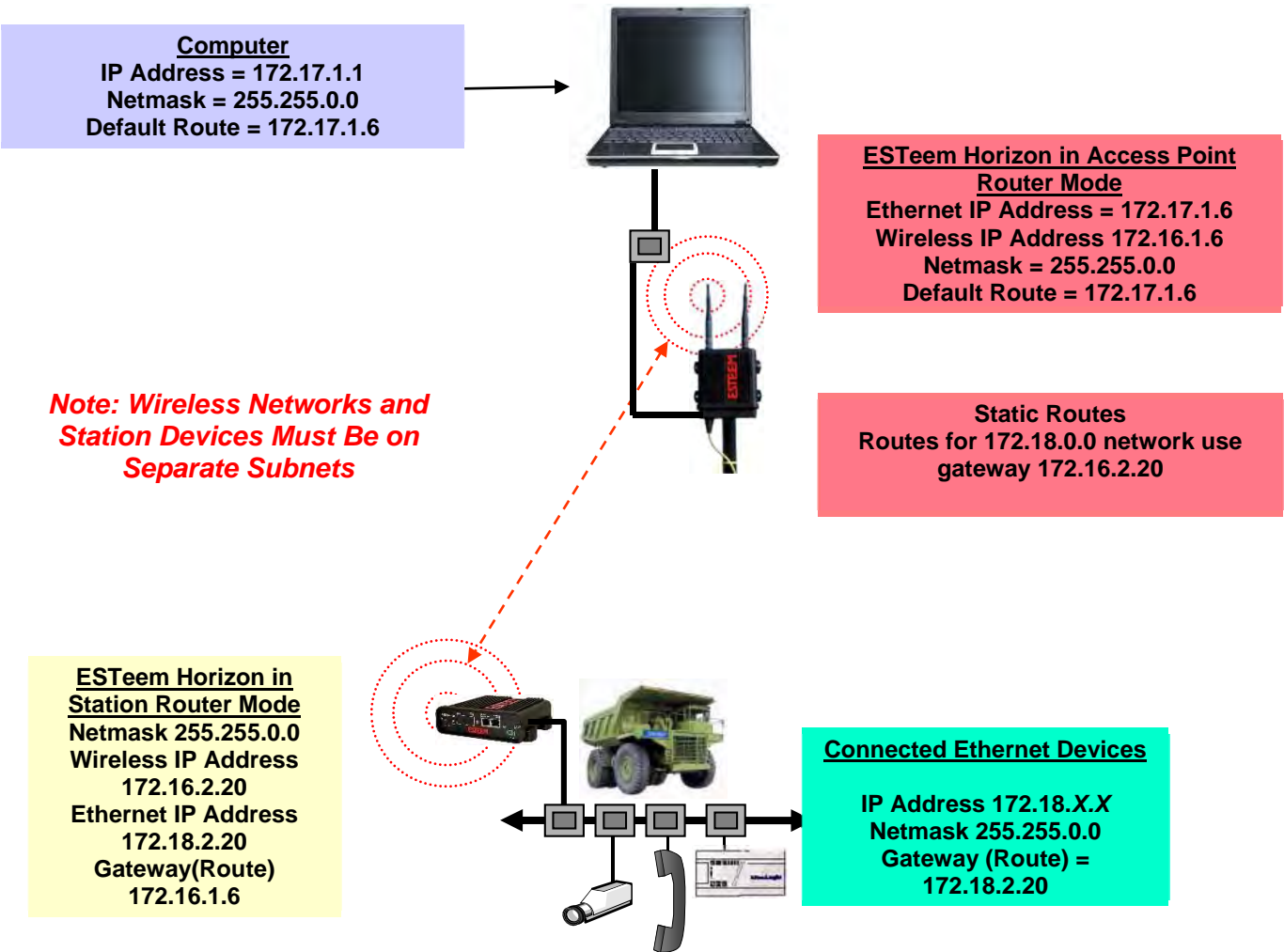

Figure 29: Station Router Addressing Example

Stand-Alone Access Point Router with Multiple Station Routers

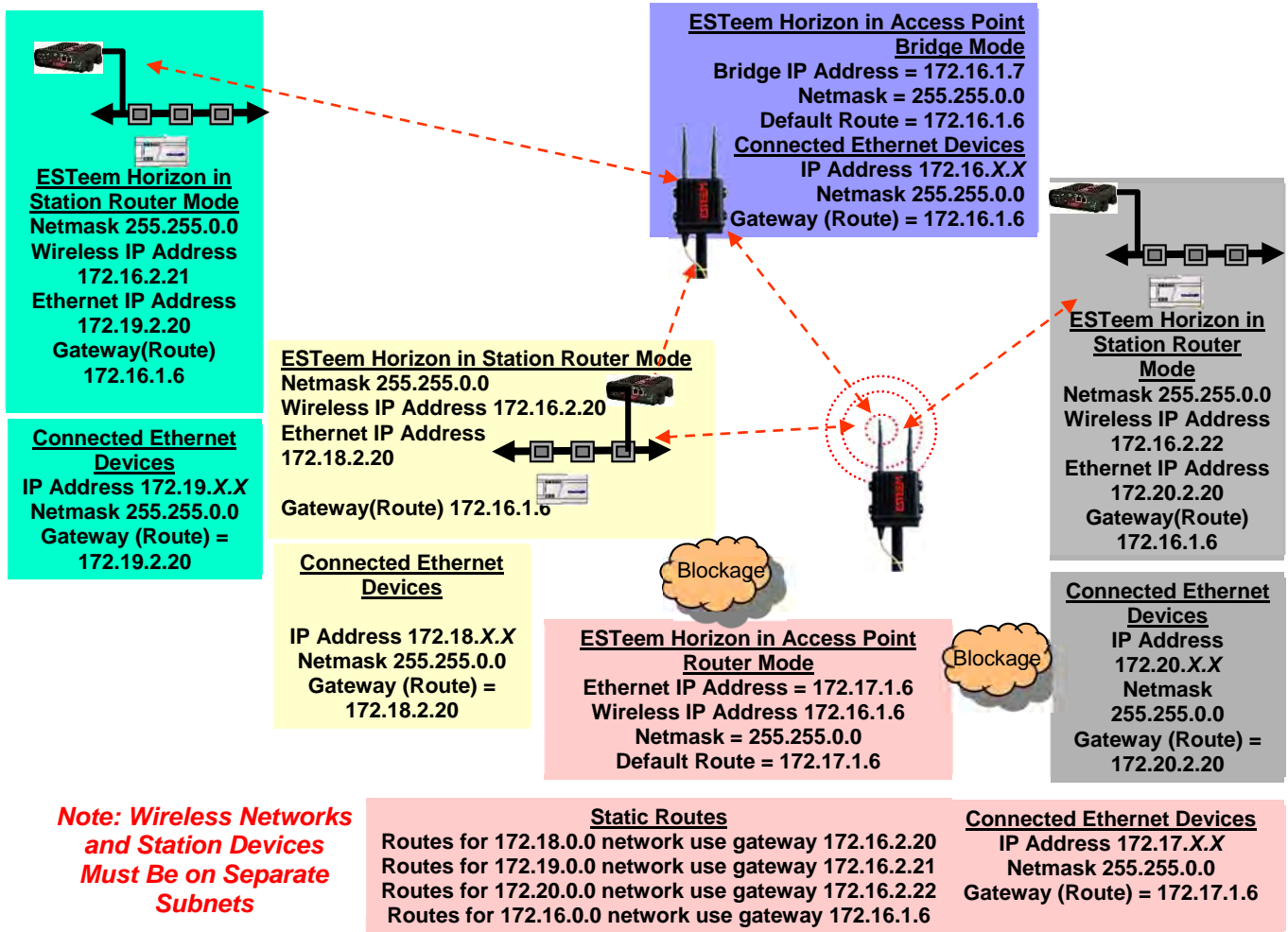

Figure 30: Complete Router Addressing Example

ESTeem Network Configuration Utility (ENC)

The ESTeem Network Configuration (ENC) Utility is a software program designed to greatly simplify the configuration of your Horizon wireless Ethernet network. The ENC Utility will allow graphical, point-and-click configuration of your network routing, then configure each ESTeem wireless modem for the network as designed (Figure 1). The ENC Utility will eliminate the need to program or update each ESTeem wireless modem individually. The ENC Utility can send all wireless modem configuration changes simultaneously to a new or existing network.

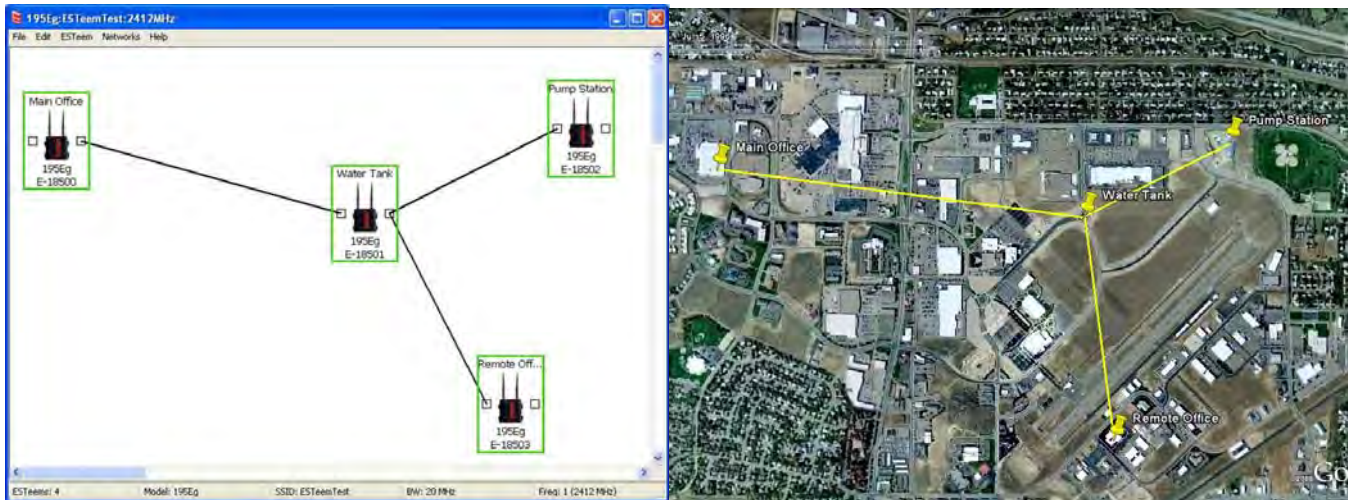

Figure 1: ESTeem Network Configuration Utility

The ENC Utility will be used for all wireless network programming in this User's Manual. For detailed instructions on the use of the ESTeem Network Configuration (ENC) Utility please refer the ENC Utility User's Guide available on the ESTeem Resource CD or in the application itself.

ESTeem Discovery Utility

The ESTeem Discovery Utility will allow you to configure the IP address on the Horizon radio to match your network regardless of its current IP subnet. This utility will also allow you to update the software in the Horizon and open the web configuration for that wireless modem.

Technical Tip: If your computer is configured for DHCP and not attached to the network, you will need to assign a static IP address to program the Horizon.

Installation

The Discovery Utility can be downloaded from the ESTeem web site (<http://www.esteem.com>) or is available on the Software Resource media that was shipped with the Horizon radios.

1. The Discovery Utility is a Java™ based application compatible with any computer operating system (Window, Linux, etc). The application requires two (2) additional support files to operate:

Java – Downloadable from <http://www.java.com>. The version required will be based upon your operating system.
Note: The installation and updates from Java may try and install additional web browser toolbars. Uncheck the optional installation if they are not desired.

WinPcap – Downloadable from <http://www.winpcap.org/>. The version required will be based upon your operating system.

- Once both the above programs have been installed, save the ESTeem.exe file to any location on your computer such as the Desktop. Double click the ESTeem.exe program and Figure 2 will be displayed.

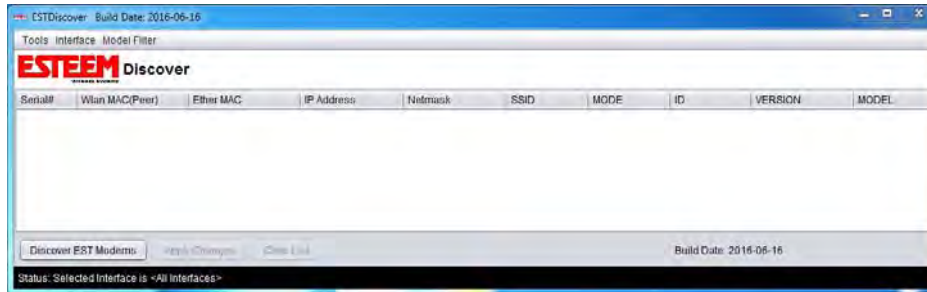

Figure 2: ESTEem Discovery Utility

- Connect the Horizon modem to your computer either directly to the Ethernet card or through a Switch using a CAT-5e Ethernet cable. The Ethernet port supports Auto-Negotiation, so either a patch cable or crossover cable will work. Press the *Discover EST Modems* button.
- The ESTeem Horizon will be displayed (Figure 3). If the ESTeem Horizon is not on the same IP subnet as the computer, double click on the IP, Netmask or Gateway and make the necessary changes. Press the *Apply Changes* button when complete.

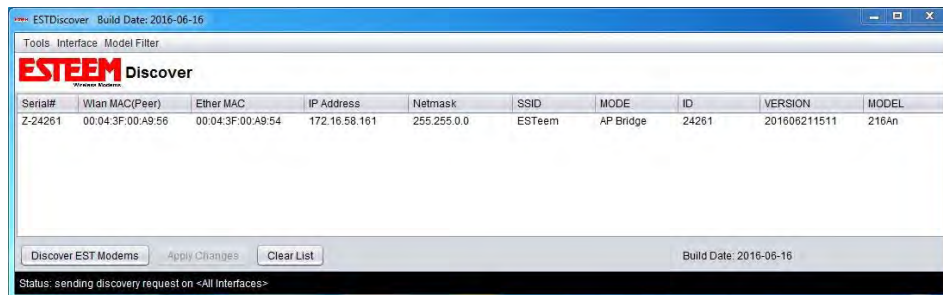

Figure 3: ESTEem Discovery Utility

- If changes were made to the IP address, you will need to press the *Discover EST Modems* button again to show the changes. Right-mouse click on the Horizon and select *Configure Radio* button to begin programming.

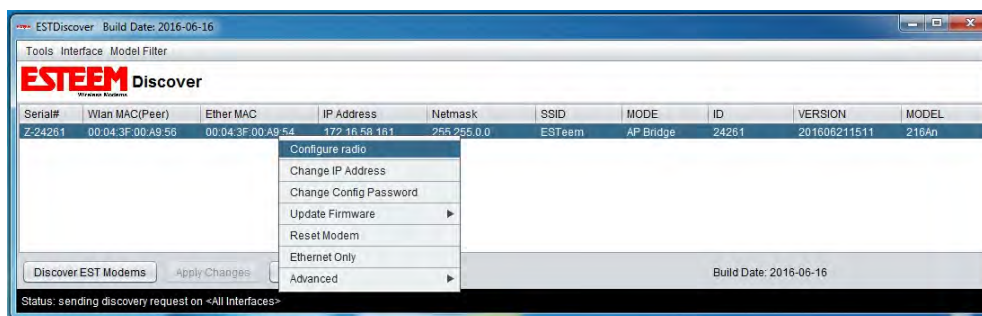

Figure 4: Opening Radio Configuration Software

Firmware Updates

To update firmware on any ESTEem Horizon that is shown on the Discovery program, “right-mouse” click on the Horizon’s MAC address and select Update Firmware from the menu (Figure 5). There are two firmware update options available, “Normal” and “Congestion Aware”. Select Normal for most updates and use Congestion Aware when sending the update over the wireless link on a busy network. Once you locate the update file, select the Open button and the Horizon will update, validate and then reboot with the updated operating system.

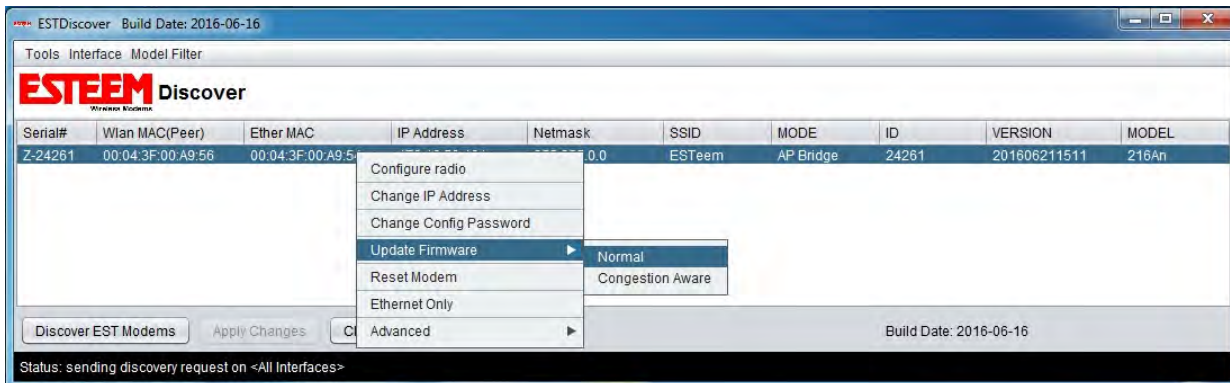

Figure 5: Discovery Features Menu

Opening Web Browser

To quickly open a web browser page to the IP address programmed in the Horizon, “right-mouse” click on the Horizon’s MAC address and select Configure radio from the menu (Figure 5). If your computer is configured for the same IP subnet at the ESTEem Horizon wireless modem, you will be asked to sign in with the Username and Password (Figure 6). You can now begin programming the Horizon for your application.

Technical Tip: The default Username and Password is “admin” (all lower case).
Example
 Username: admin
 Password: admin

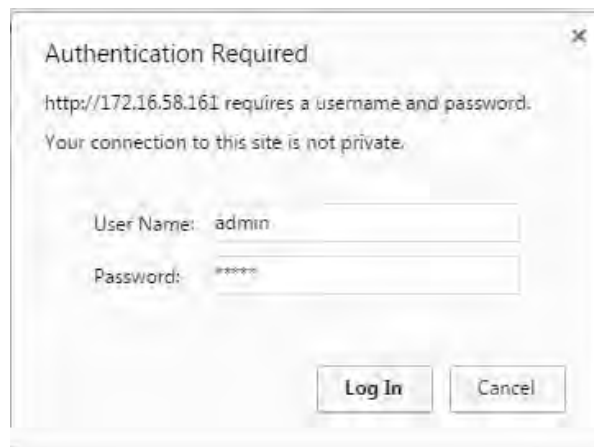

Figure 6: ESTEem Web Page Log-on Screen

SETTING LOCAL TIME

The ESTeem Horizon will be shipped from the factory with the internal real-time clock set to Pacific Time. To change the clock settings to the local time for accurate log file entries:

2. Select **Advanced** from the top Menu, select **Global Settings>Set System Time** (Figure 7) from the menu and press the **Next** button to continue.
3. Select the correct date and time from the drop-down menus (Figure 8) and press the **Set System Time** button to save the time to the real time clock.



Figure 7: Advanced Features Screen

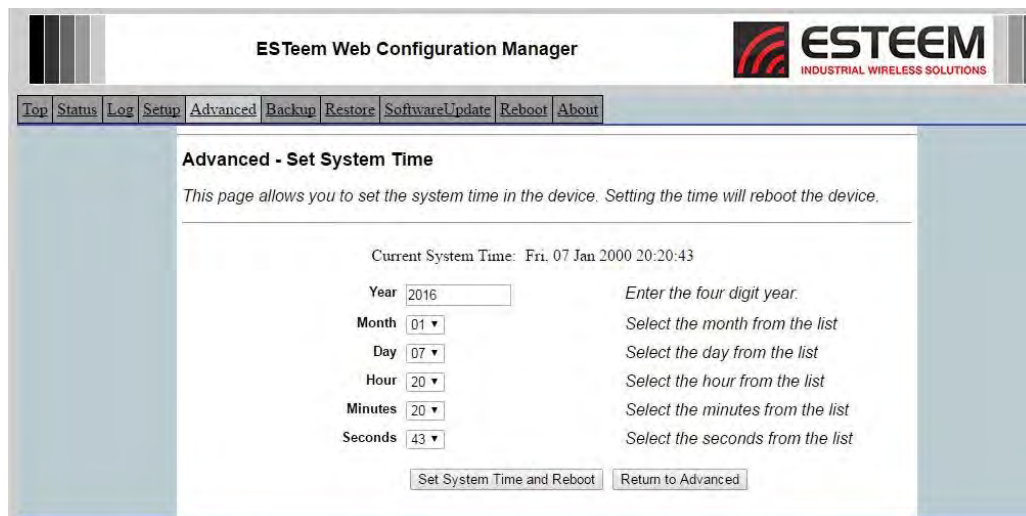

Figure 8: Advanced Features Screen

CONFIGURING TIME SERVER

Enabling NTP time synchronization services on the Horizon will allow usage of time services from upstream services to keep the time on the system accurate.

To allow time synchronization, the Horizon must be configured with the NTP Daemon enabled and the appropriate IP address of the upstream network NTP server.

1. Select **Advanced** from the menu items and **Global Variables** (Figure 7).
2. Press the Next button and Figure 9 will be displayed. At the bottom of the page are the NTP server configurations.
3. The NTP daemon is enabled by selecting ON for **NTP Client** (Figure 9). When enabled, the NTP daemon will use time services from upstream services to keep the time on this system accurate.
4. Next, the **NTP Server** should be configured to “On,” if you want to allow the system to provide NTP service for clients wishing time synchronization (Figure 9).
5. The final step in configuring NTP services is to enter the IP address or the host name of the upstream NTP server. Once configuration is complete, press the Accept button.
6. To complete the configuration, select “Commit and Reboot.” The Horizon will now commit the configuration changes and reboot.

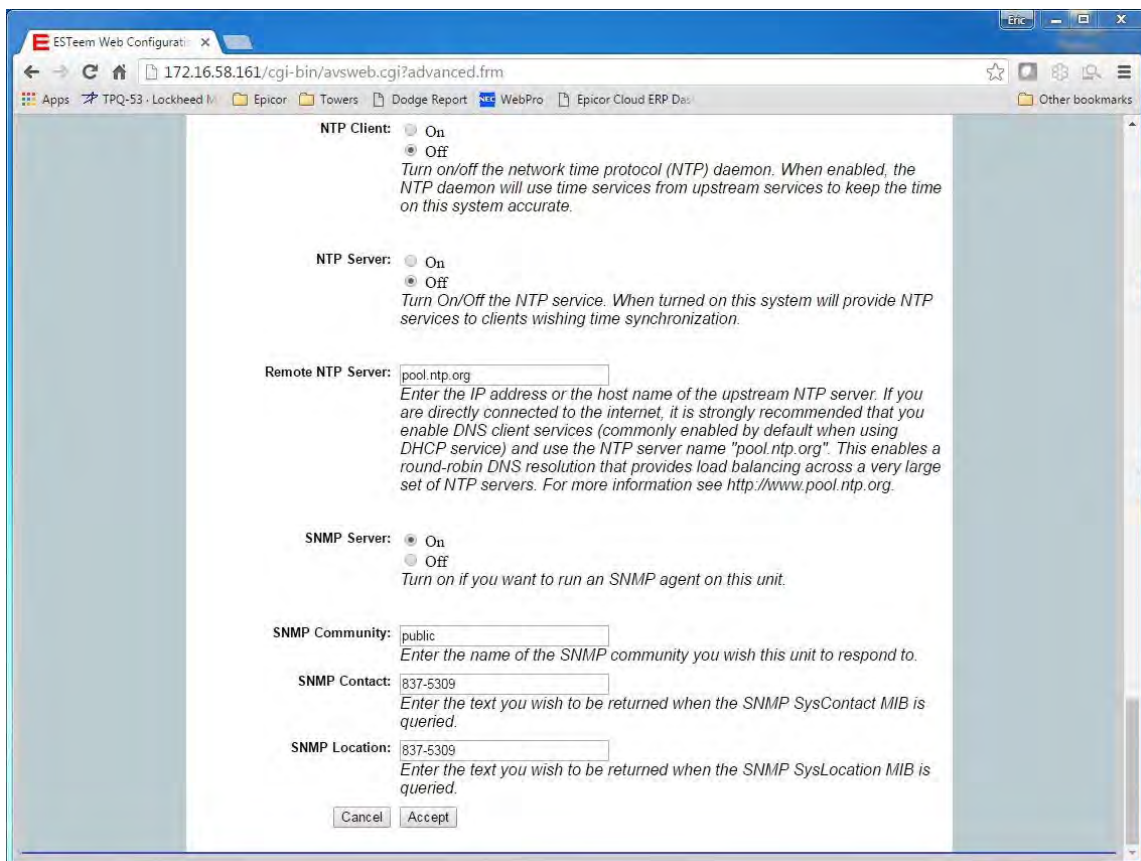

ESTeem Web Configurati: X

172.16.58.161/cgi-bin/avswweb.cgi?advanced.frm

Apps TPQ-53 Lockheed M Epicor Towers Dodge Report WebPro Epicor Cloud ERP Das Other bookmarks

NTP Client: On
 Off
Turn on/off the network time protocol (NTP) daemon. When enabled, the NTP daemon will use time services from upstream services to keep the time on this system accurate.

NTP Server: On
 Off
Turn On/Off the NTP service. When turned on this system will provide NTP services to clients wishing time synchronization.

Remote NTP Server:
Enter the IP address or the host name of the upstream NTP server. If you are directly connected to the internet, it is strongly recommended that you enable DNS client services (commonly enabled by default when using DHCP service) and use the NTP server name "pool.ntp.org". This enables a round-robin DNS resolution that provides load balancing across a very large set of NTP servers. For more information see <http://www.pool.ntp.org>.

SNMP Server: On
 Off
Turn on if you want to run an SNMP agent on this unit.

SNMP Community:
Enter the name of the SNMP community you wish this unit to respond to.

SNMP Contact:
Enter the text you wish to be returned when the SNMP SysContact MIB is queried.

SNMP Location:
Enter the text you wish to be returned when the SNMP SysLocation MIB is queried.

Figure 9: NTP Settings

VLAN OPERATION

Virtual LAN (VLAN) systems are rapidly becoming the desired configuration on larger Ethernet networks. The ESTeem Horizon software will allow the Ethernet modems to transparently pass the VLAN packets for these networks. The Horizon currently can not be used as a VLAN switch, but will pass VLAN tagged Ethernet packets through the wireless bridge.

IGMP SNOOPING

Internet Group Management Protocol (IGMP) Snooping allows the ESTeem Horizon to operate more efficiently in networks with high Multicast (UDP, etc.) traffic. IGMP Snooping will define the destination for the Multicast traffic and send the data to the correct wireless Ethernet modem, not the entire network. This limiting of Multicast traffic to specific destinations greatly increases the overall network efficiency.

The problem with using multicast traffic over a wireless connection is that multicast packets do not require an Acknowledge on the protocol layer. If the wireless network misses a data packet on the RF network, that multicast data packet is lost.

Theory of Operation

There are two types of Ethernet packets on a network, unicast and multicast. Unicast is intended for exactly one recipient (and ignored by all others). Multicast is intended to be received by multiple recipients. Interested parties can listen for particular multicast packets, but most nodes ignore it. In any case, the network medium is still utilized no matter how many nodes are listening. Broadcast packets are a special type of multicast traffic which all nodes always receive. These are particularly useful for global announcements (Hey, I'm Alice!) and queries (Hey, I'm Alice and I'm looking for Bob!). More relevantly, it is how hosts on a network find out each other's addresses, and are absolutely crucial to the proper functioning of a network.

As the network grows physically, it encounters some growing pains. The first is more physical, relating to the cabling limitations. Bridges solve this problem by joining two physical networks together so they appear to be a single large network. Through use of bridges, a network can scale to hundreds or even thousands of hosts. There is a downside, however. Well before the physical limitations of bridging hit, you start to run into efficiency problems, as all traffic has to travel everywhere on the network. The raw carrying capacity of this shared medium, often referred to as bandwidth, is the second scaling problem.

Smart bridges, or switches, help alleviate the bandwidth problem by only passing traffic across the bridge if the destination host was on the other side. This greatly increases the capacity and efficiency of the network by allowing two pairs of hosts communicating simultaneously on each side of the switched bridge. Only when the packet needs to go to the other side is both mediums utilized simultaneously for the same packet.

Unfortunately, broadcast and multicast traffic by its very nature must always be relayed across the bridge. While the number of network nodes may grow linearly, the multicast traffic tends to grow exponentially. This isn't generally a problem for wired networks, as they have a considerable amount of bandwidth to spare, but wireless networks have, at best, an order of magnitude less bandwidth to begin with. If a wireless network is bridged with a wired network, while the absolute numbers are the same, a much higher proportion of the wireless network's available bandwidth is used up by multicast traffic. This effect is further magnified if multiple wireless repeaters are in use.

The preferred way of dealing with excess multicast traffic is to put the wireless network on a different sub-network (subnet) and use a router to join it to the wired network. This ensures that only unicast traffic intended for the wireless network crosses over, as multicast and broadcast traffic stays within its local subnet. Normally this is fine, but there are times where you need multicast traffic to span subnets. For IP traffic, this can be obviated by using a multicast-capable router, but for legacy multicast protocols that were not designed to be routed, another solution must be found.

There are two primary types of communication networks used in wireless Ethernet systems; fixed points communicating to each other through an Ethernet Bridge and mobile devices communicating to these fixed points. The fixed point Ethernet bridge communication in the Horizon is through Repeater Peer links, while the mobile communication is from the Client modes (EtherStation, Station Router and Station Masquerade) to the Access Points (Fixed Locations) in the network. Each of these networks handles Multicast traffic differently as explained below.

Ethernet Bridge Mode (with Peers)

When the ESTeem Horizon is configured as a peer, all multicast traffic is “wrapped” in a Unicast frame and sent to all other repeater peers. (Figure 10) This operation allows the ESTeem network to receive an acknowledge packet and retransmit the data if the packet is lost during transmission. This unicast encapsulation will work regardless if the protocol can support IGMP or not.

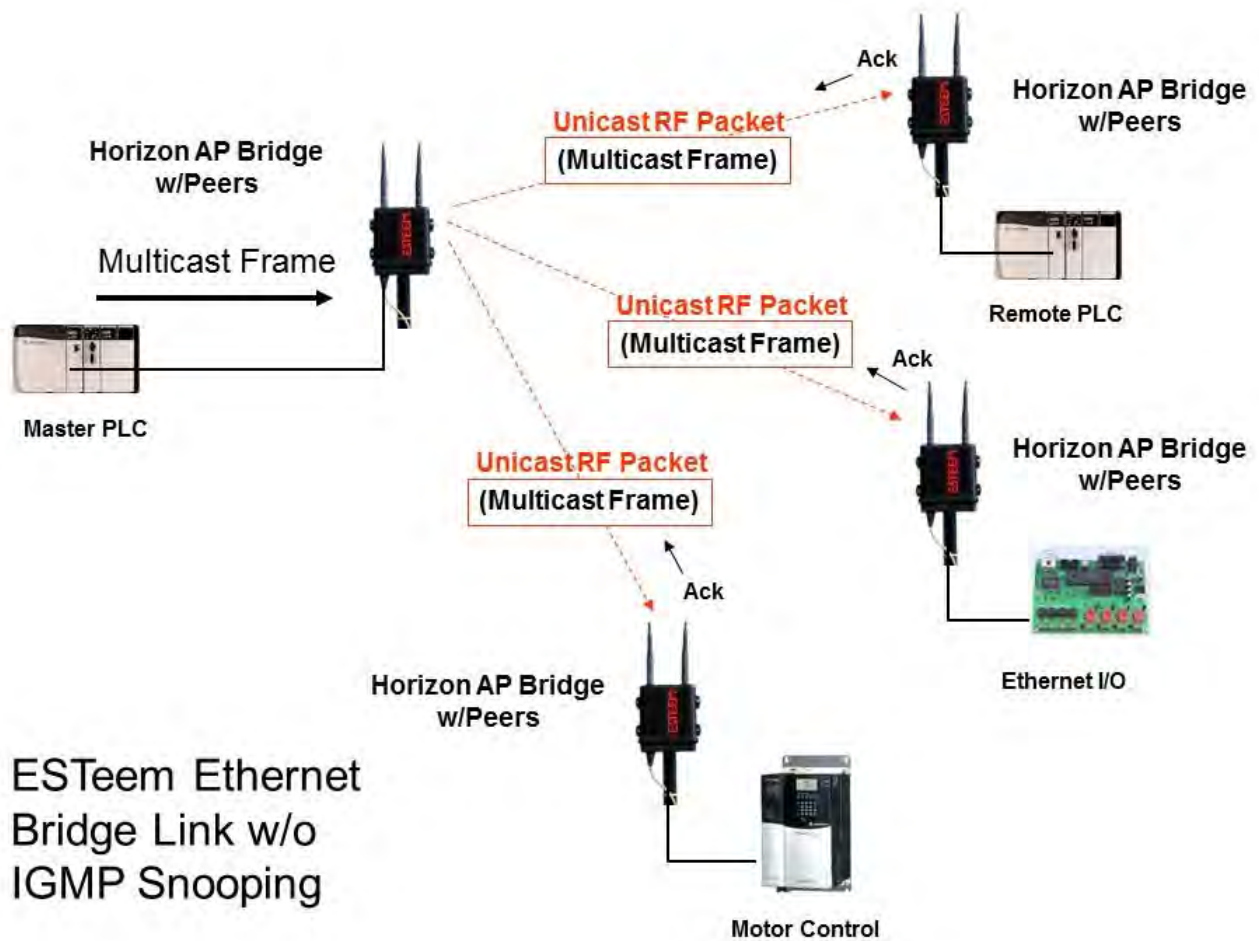

Figure 10: Repeater Peer Operation

Ethernet Bridge Mode (Repeater Peers) With IGMP Snooping

When the ESTeem Horizon is configured as a repeater peer, IGMP Snooping is enabled and the network supports IGMP protocol, the Horizon will begin to identify the connected Ethernet devices using Multicast transmissions and report this information to the network. As this process continues, all sites that have Multicast traffic on the wireless network will only send these requests to the specific ESTeem reporting the Ethernet device (see Figure 11).

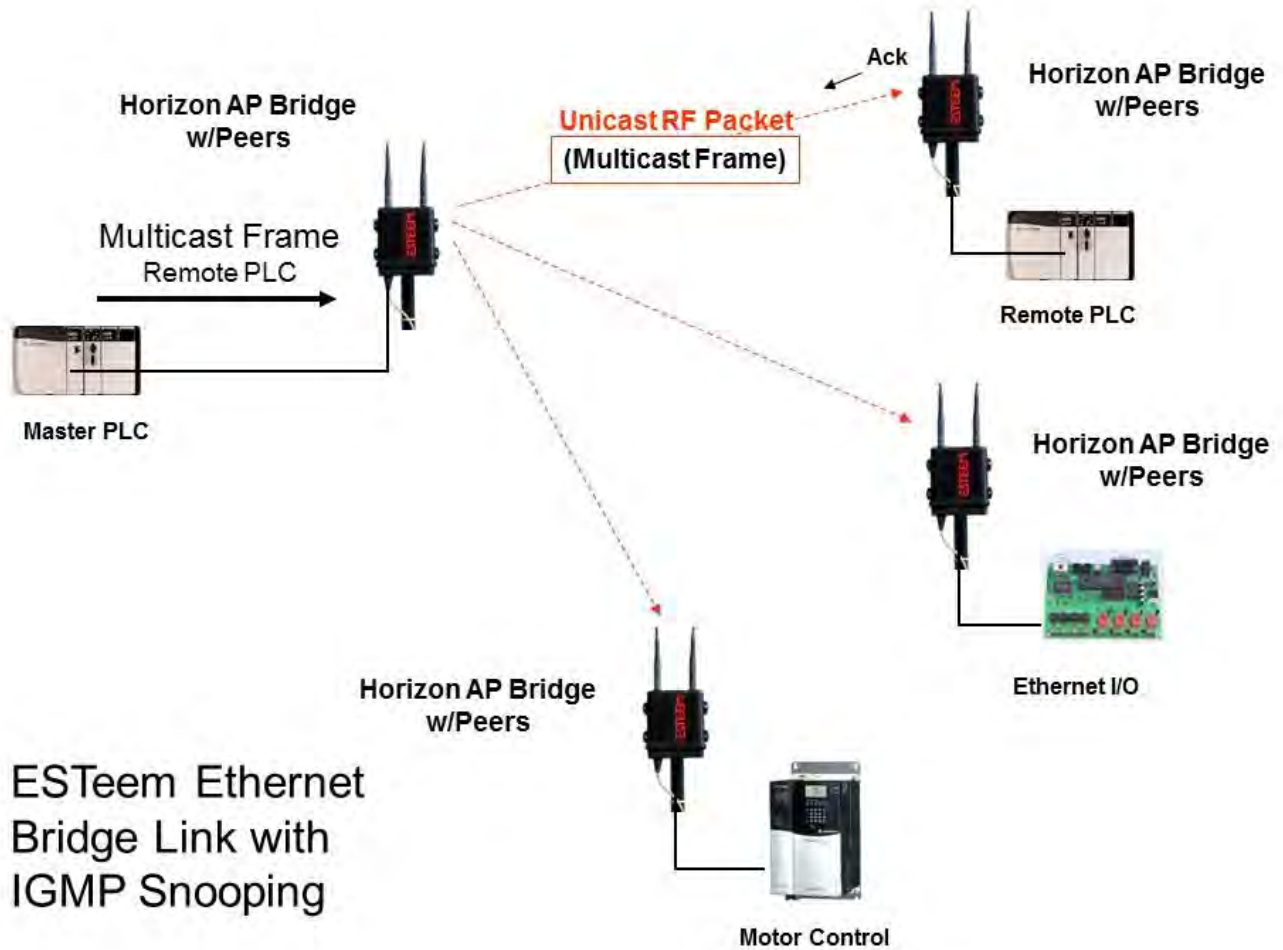

Figure 11: Repeater Peer with IGMP Enabled

Enabling IGMP Snooping

To enable the ESTeem Horizon for IGMP Snooping, select **Advanced>Bridge Variables** and press the **Next** Button (Figure 15). Select IGMP Snoop to On, press the **Accept** Button and then **Commit and Reboot**.



ESTeem Web Configuration Manager

Top Status Log Setup **Advanced** Backup Restore SoftwareUpdate Reboot About

Advanced - Bridge Settings

The following is a list of those configuration variables under the **Bridge Settings** category. These variables contain values for configuring bridges.

Bridge devices:	<input type="text" value="br0"/>	Enter the name(s) of all the bridge devices separated by a single comma
br0 devices:	<input type="text" value="eth0 eth1 wlan0"/>	Enter all the device names, separated by a single space, that will form a bridge device
br0 Spanning Tree Protocol:	<input checked="" type="radio"/> On <input type="radio"/> Off	Turn STP on or off. NOTE: the Root Bridge and Bridge Priority, settings have no effect if STP is turned off.
br0 Root Bridge:	<input type="radio"/> On <input checked="" type="radio"/> Off	If you select 'On' here you will override the br0 Bridge Priority below and the bridge priority will be forced to 0.
br0 Bridge Priority:	<input type="text" value="8"/>	Enter a priority level (0-65535) for the bridge device
br1 devices:	<input type="text"/>	Enter all the device names, separated by a single space, that will form a bridge device
IGMP Snoop:	<input type="radio"/> On <input checked="" type="radio"/> Off	Turn on IGMP snooping to reduce multicast traffic across the bridge.

Figure 12: IGMP Enabled

Simple Network Management Protocol (SNMP)

The ESTeem Horizon supports SNMP Version 1 (SNMPv1) and Version 2 (SNMPv2c) protocol. This protocol enables any SNMP server to view the status of the wireless network while the system is in operation. The following are a list of the Management Information Base (MIB) items that are supported in the ESTeem Horizon and their MIB location:

MIB Name	MIB Directory Location	Notes
System Temperature	EST-MIB::sysInternalTemp.0	in C * 1000
Uptime	HOST-RESOURCES-MIB::hrSystemUptime.0	System Update
ModemID	EST-MIB::sysIdentifier.0	User-specified "nickname" for ESTeem
Serial Number	EST-MIB::sysSerialNumber.0	ESTeem serial number
Model	EST-MIB::sysModel.0	ESTeem model number
Firmware Version	EST-MIB::sysFirmwareRevision.0	Firmware revision
System Mode	EST-MIB::sysMode.0	AP_BRIDGE/STA_ETHERSTA, etc
Free Memory	UCD-SNMP-MIB::memTotalFree.0	Total Free Memory
Idle CPU	UCD-SNMP-MIB::ssCpuIdle.0	Percentage of CPU Idle
[[per-interface]]		
IP Address	IF-MIB::ifAddress	
Port Speed	IF-MIB::ifSpeed	In bps
Port Status	IF-MIB::ifOperStatus	
Mac Address	IF-MIB::ifPhysAddress	
[[per-wlandev entry]]	EST-MIB::wirelessDevicesNumber.0	Wireless Port Identification
Device Name	EST-MIB::wirelessDeviceTable.1.wName.1	Name of device (wlan0 standard)
MAC Address	EST-MIB::wirelessDeviceTable.1.wMacAddress.1	MAC address of WLAN port
Mode	EST-MIB::wirelessDeviceTable.1.wMode.1	Current Mode ap=access point, sta=station mode and airscape
Frequency	EST-MIB::wirelessDeviceTable.1.wFreq.1	Frequency in MHz
Bandwidth	EST-MIB::wirelessDeviceTable.1.wBandwidth.1	Bandwidth (5, 10, or 20 MHz if used)
SSID	EST-MIB::wirelessDeviceTable.1.wSSID.1	Service Set Identification
BSSID	EST-MIB::wirelessDeviceTable.1.wBSSID.1	Basic Service Set Identification
Operational Rates	EST-MIB::wirelessDeviceTable.1.wOpRates.1	List of RF Data Rates in Rate Set
Basic Rates	EST-MIB::wirelessDeviceTable.1.wBasRates.1	List of RF Basic Rates for status messages

[[peer table entry]]		All entries in the Peer Table will have a device entry index, both ESTeem and other wireless devices
	EST-MIB::wirelessPeersNumber.0	Total number of peer entries in table
wlan device	EST-MIB::wirelessPeerTable.1.pDevice.1	index into the wirelessDeviceTable (each entry will have a unique number)
Peer MAC Address	EST-MIB::wirelessPeerTable.1.pMacAddr.1	MAC address of peer
isRepeater?	EST-MIB::wirelessPeerTable.1.pRepeater.1	Is the peer an ESTeem repeater
isAP?	EST-MIB::wirelessPeerTable.1.pAP.1	Is the peer an Access Point
isAssocSta?	EST-MIB::wirelessPeerTable.1.pAssoc.1	Is the peer an Mobile Client
isAdhoc?	EST-MIB::wirelessPeerTable.1.pAdhoc.1	Is the peer an AdHoc Station (802.11 only)
Frequency	EST-MIB::wirelessPeerTable.1.pFreq.1	Frequency in MHz
current rate set	EST-MIB::wirelessPeerTable.1.pCurRates.1	Current Operating Rates
last rx signal	EST-MIB::wirelessPeerTable.1.pSignal.1	Receive Signal in -dBm
last rx noise	EST-MIB::wirelessPeerTable.1.pNoise.1	Background Noise in -dBm
BSSID	EST-MIB::wirelessPeerTable.1.pBssid.1	Basic Service Set ID (In Hex)
SSID	EST-MIB::wirelessPeerTable.1.pSSID.1	SSID in Text
isValid?	EST-MIB::wirelessPeerTable.1.pCurrent.1	True if peer info is for a "current" peer.
last rx	EST-MIB::wirelessPeerTable.1.pLastRx.1	seconds since last received packet from peer
last tx	EST-MIB::wirelessPeerTable.1.pLastTx.1	seconds since last transmitted packet to peer
current tx rate	EST-MIB::wirelessPeerTable.1.pCurrentRate.1	current tx rate in bps.

Downloading MIB Tables

To download the MIB items listed above and import into your SNMP server, log into any ESTeem Horizon and select the **About** page (Figure 16). Press the [Download MIB Files](#) hyperlink on the page and save the files to your computer.

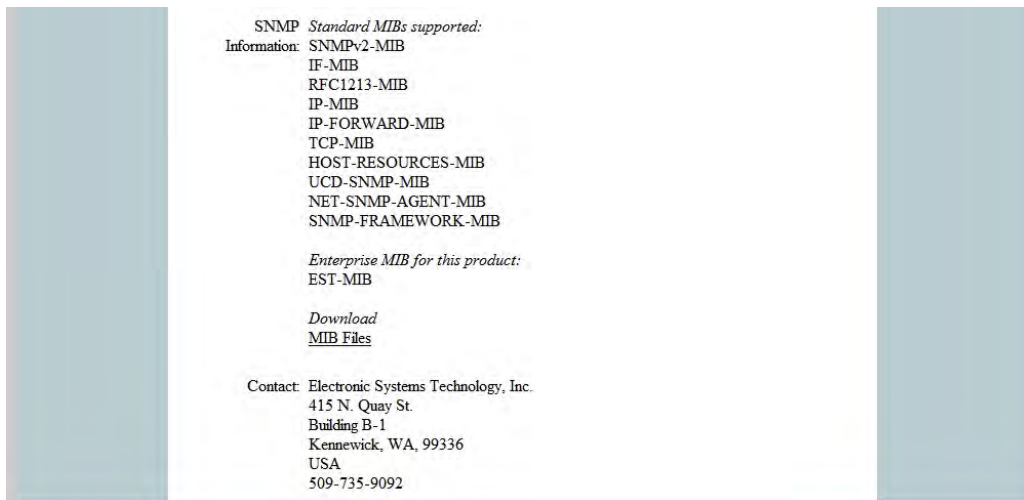

SNMP *Standard MIBs supported:*
 Information: SNMPv2-MIB
 IF-MIB
 RFC1213-MIB
 IP-MIB
 IP-FORWARD-MIB
 TCP-MIB
 HOST-RESOURCES-MIB
 UCD-SNMP-MIB
 NET-SNMP-AGENT-MIB
 SNMP-FRAMEWORK-MIB

Enterprise MIB for this product:
 EST-MIB

Download
[MIB Files](#)

Contact: Electronic Systems Technology, Inc.
 415 N. Quay St.
 Building B-1
 Kennewick, WA, 99336
 USA
 509-735-9092

Figure 16: MIB Table Download

The ESTeem Horizon Web Configuration Manager is an internal web server that will allow setup, monitoring and diagnostics of all operating parameters in the Horizon. The Horizon can be configured using any current web browser software such as Internet Explorer, Mozilla, FireFox or Google Chrome®.

LOGGING ON TO THE ESTeem WEB PAGE

1. Using your Web Browser connect to the Horizon Web Page with the IP Address that you have assigned it in Chapter 3.
2. You will now see the Log-on Menu on Figure 1. To enter the Horizon Top Menu you will need to log into the system with a User Name and Password.
3. For the User Name enter **admin** and press the Enter key (<Enter>). The User Name is defined at the factory and is not changeable.
4. Enter your Password and press the Enter key (<Enter>).

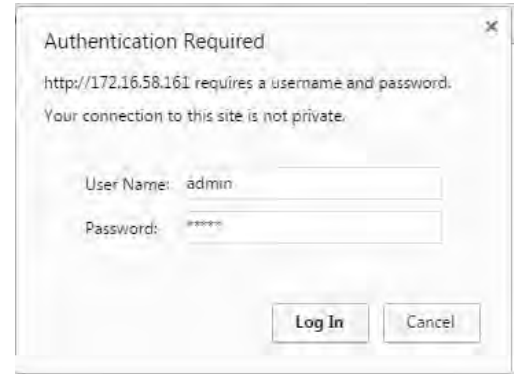

Figure 1: ESTeem Web Page Log-on Screen

Technical Tip: If this is the first time the Horizon has been programmed and the Password was not changed from the factory default values, the factory default Password is also **admin**.

5. After Log-in the next screen displayed will be the Horizon Top Menu page (Figure 2). This example screen shows the Top Menu screen.

Note: Throughout the Configuration Manager are Help Screens that can be accessed for further information on each item.

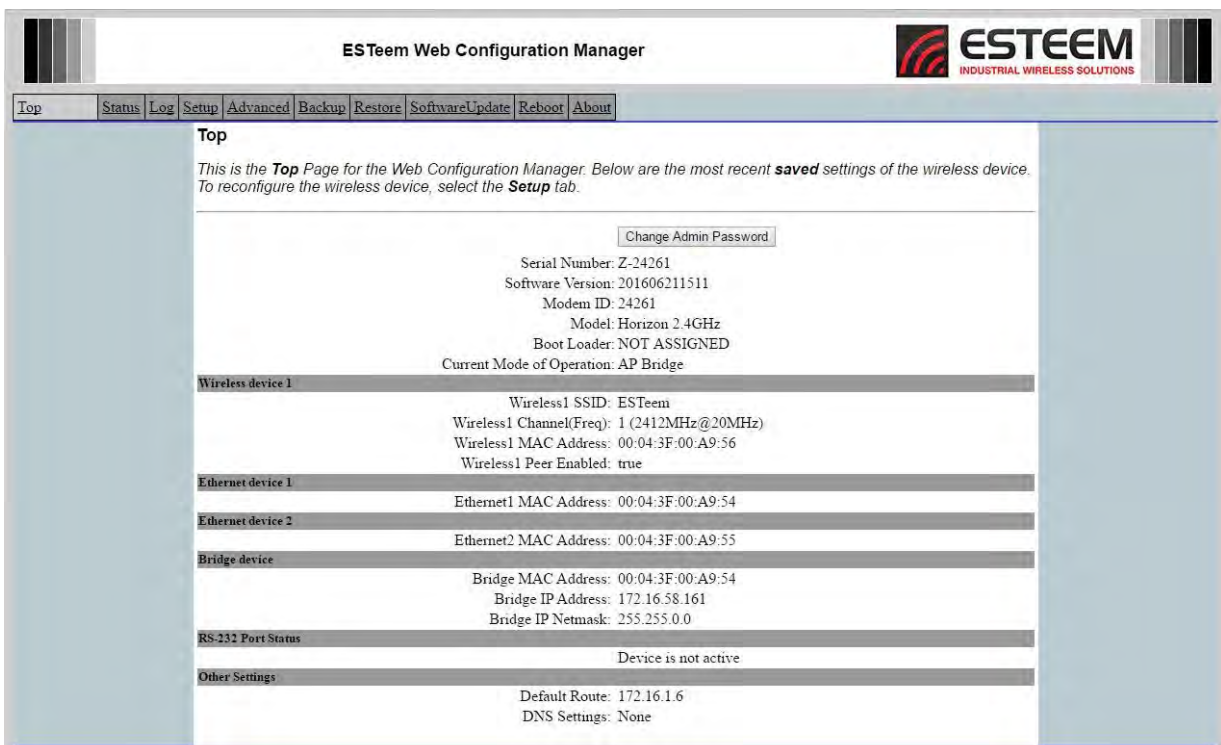

Figure 2: Top Menu Screen

WEB CONFIGURATION MANAGER SECTIONS

The following sections will describe the features in each of the main and sub menu items in the web pages. For step-by-step examples of how to configure the Horizon in different Modes of Operation, please refer to Chapter 3 – Example Applications.

Top Menu

The Top Menu will be the default web page for the Horizon Web Configuration Manager (Figure 2). This section will display the current configuration summary for the Horizon and allow changing of the default password. This page will also display the Modem ID field that can be used to easily identify the Horizon you are programming. This Modem ID field can be set to any text combination for example, location name, GPS coordinates or addresses.

Setting the Modem ID

1. The Modem ID field can be adjusted under the *Global Variables* of the Advanced Menu tab. Select Global Variables and press the *Next* button. Figure 3 will be displayed.
2. Scroll to the bottom of the Global Variables window and enter the text you would like displayed in the Modem ID field (Figure 4). When complete, press the *Save Settings* button and the *Commit Changes* button on the next screen to save the name to the Horizon.

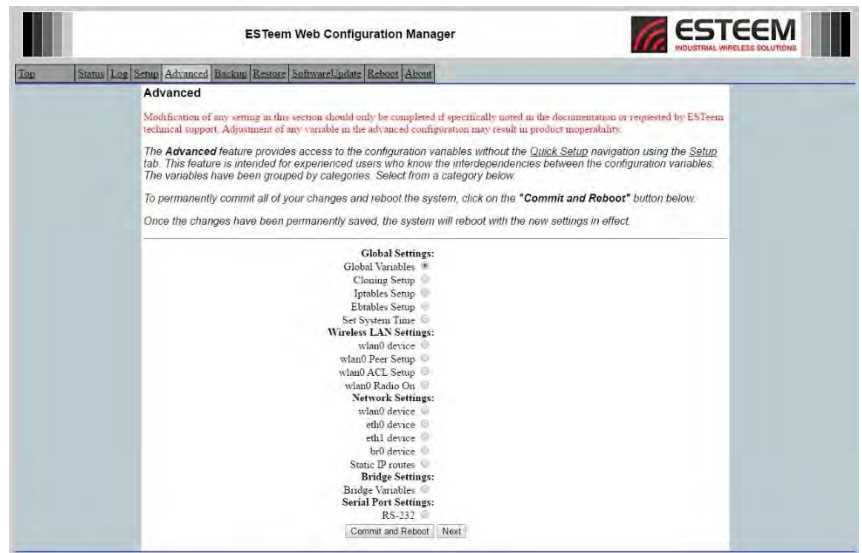

Figure 3: Global Variables Screen

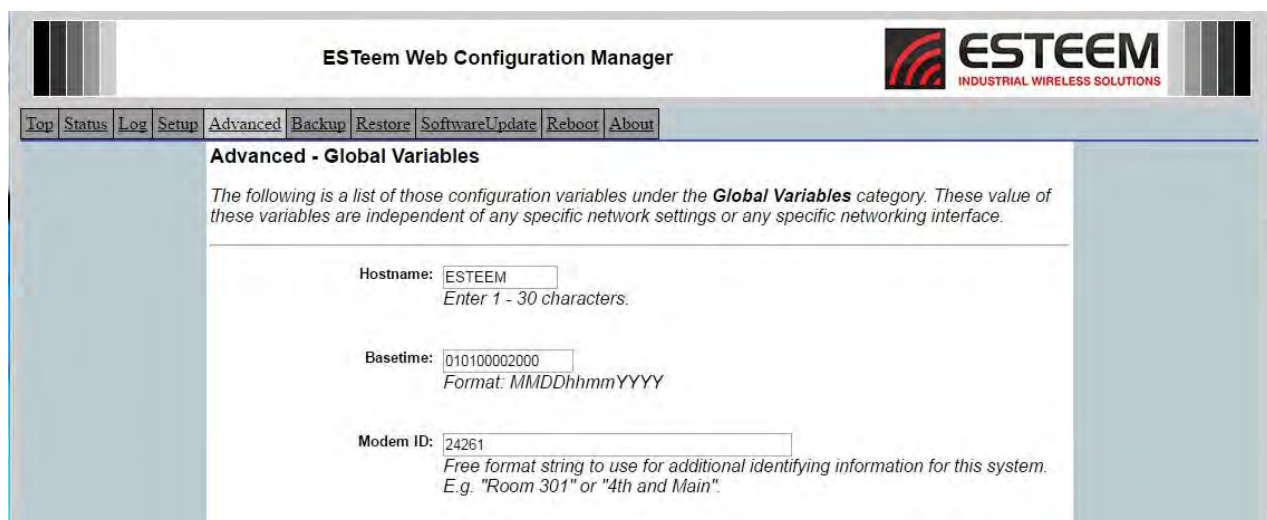

Figure 4: Modem ID Field in Global Variables Screen

Status Menu

The Status Menu provides a summary of the current mode of operation, system time, processor usage, internal temperature and status of the communication links to other wireless devices. An example is shown below in Figure 5. Most of the communication troubleshooting is done in this section of the Web Configuration Manager.

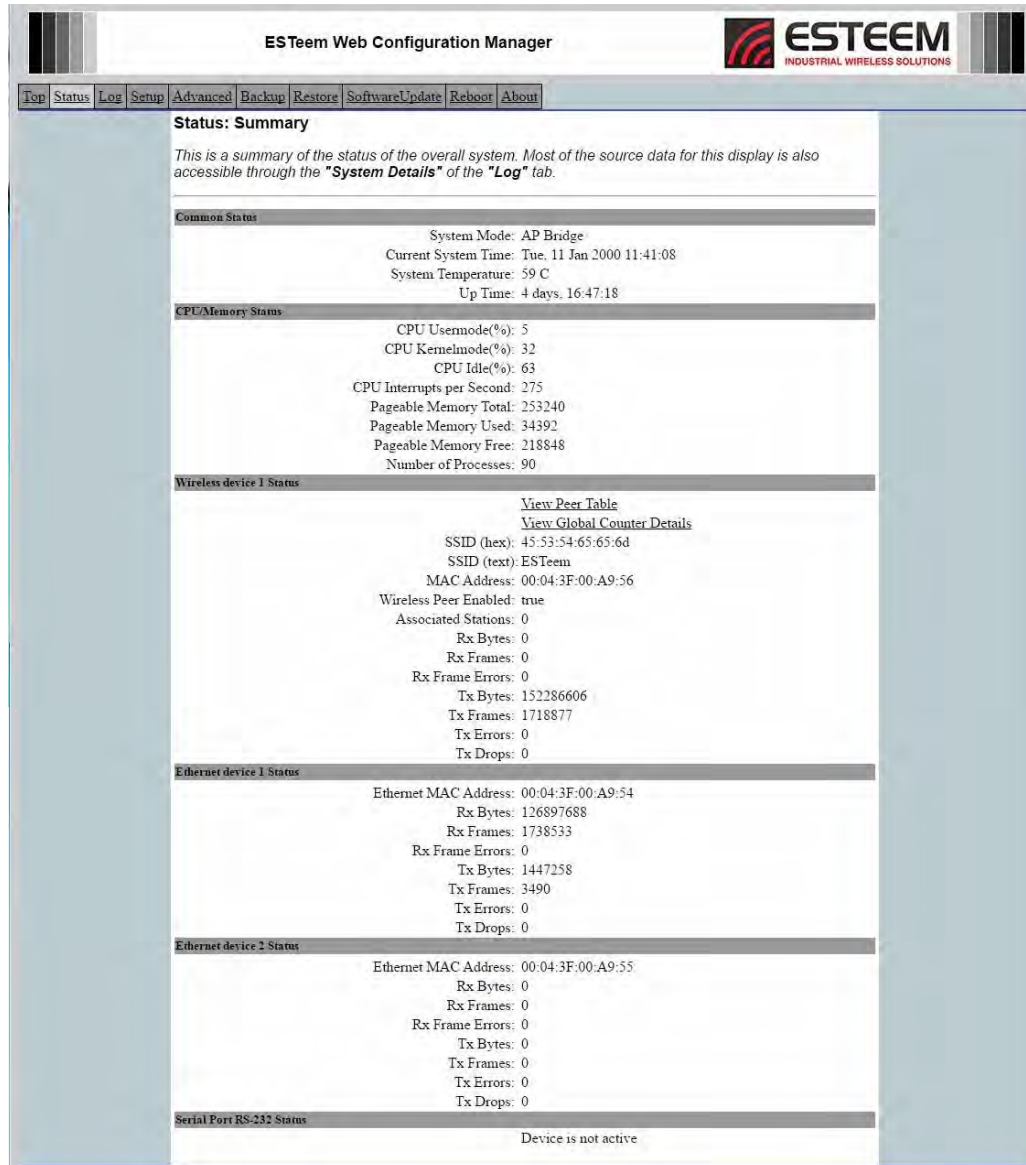

Figure 5: Status Screen

Peer Status Table

The Peer Status submenu lists the connected wireless devices (Horizon’s or 802.11 clients), their signal strength, data rate and time of last packet sent. Press the [View Peer Table](#) link and Repeater Peer Status Table will be displayed (Figure 6). For a detailed analysis of the information provided in this table, please review Appendix E – Troubleshooting.

Associated Station – This section will list all the associated stations that are attached to the Access Point. These could be other Horizon’s in one of the three Client modes or 802.11 devices.

Peers – This section will list all connected Horizon peers (Ethernet Bridge links) by their Wireless MAC address. For detailed information on peer links, bridging and wireless Mesh, see Chapter 7 – Wireless Bridging and Mesh Features.

Access Points – This section will list all other 802.11 Access Points that are sharing the operating channel (frequency) of the Horizon. You can also note that the Peers listed above are also included in this list.



The screenshot shows the 'Peer Table' section of the ESTeem Web Configuration Manager. It includes a navigation menu at the top with options like 'Top', 'Status', 'Log', 'Setup', 'Advanced', 'Backup', 'Restore', 'Software Update', 'Reboot', and 'About'. Below the navigation is a 'Status: Peer Table' heading and a brief description: 'This page is a summary view of the peer table for the WLAN device indicated below. Click on a given MAC address for more details about that peer.' There is a 'Return to Status Summary Page' link. The main content area is titled 'Peer Table Summary for Wireless device 0' and contains three tables: 'Associated Stations', 'Peers', and 'Access Points'. Each table has columns for MAC Address, AntSignal A1 | A2, LastRx (sec @mbps), SSID, and Modem ID.

MAC Addr	AntSignal A1 A2	LastRx (sec @mbps)	SSID	Modem ID
fc:db:b3:b8:c8:e3	-54 -80	3 @136		

MAC Addr	AntSignal A1 A2	LastRx (sec @mbps)	SSID	Modem ID
00:04:3f:00:a9:96	-58 -91	0 @72.2	ESTeemTB	

MAC Addr	AntSignal A1 A2	LastRx (sec @mbps)	SSID	Modem ID
00:04:3f:00:0b:1a	-65 -104	42 @1	EsteemAP	TestingID2
00:04:3f:00:a9:7a	-82 -101	42 @1	ESTeem Test Bench	ESTeem
00:04:3f:00:a9:96	-60 -92	0 @72.2	ESTeemTB	
00:1d:7e:d8:21:f4	-91 -104	0 @1	Techbench	

Figure 6: Peer Table Screen

System Log Screen

The Log Screen is a trouble-shooting tool that shows the current log of Horizon system messages. See Figure 7. The System Details button will display a more detailed system diagnostic that may be requested by ESTeem technical support.



The screenshot shows the 'System Log' section of the ESTeem Web Configuration Manager. It includes the same navigation menu as Figure 6. Below the navigation is a 'System Log' heading and a description: 'The following display is the system log. To view more detailed system information, click on the System Details button.' There is a 'System Details' button. The main content area displays a list of system log messages with timestamps and kernel messages.

```

Jan 11 11:44:23 kernel: davinci_mdio 4a100000.mdio: detected phy mask ffffffff
Jan 11 11:44:23 kernel: libphy: 4a100000.mdio: probed
Jan 11 11:44:23 kernel: davinci_mdio 4a100000.mdio: phy[0]: device 4a100000.mdio:00, driver Micrel K52001 Gigabit PHY
Jan 11 11:44:23 kernel: davinci_mdio 4a100000.mdio: phy[1]: device 4a100000.mdio:01, driver Micrel K52001 Gigabit PHY
Jan 11 11:44:23 kernel: spsw 4a100000.ethernet: Detected MACID = b4:99:4c:07:4f:b6
Jan 11 11:44:23 kernel: cpw 4a100000.ethernet: cpsi: Detected MACID = 04:09:4c:09:4f:b7
Jan 11 11:44:23 kernel: rtc-ds1307 0-0068: setting system clock to 2000-01-11 11:44:20 UTC (947551060)
Jan 11 11:44:23 kernel: vfs: Mounted root (squashfs filesystem) readonly on device 254:0.
Jan 11 11:44:23 kernel: dm-stmpfs: mounted
Jan 11 11:44:23 kernel: Freeing unused kernel memory: 244K (c04a3000 - c0520000)
Jan 11 11:44:23 kernel: lm75 0-0048: hum000: sensor 'lm75'
Jan 11 11:44:24 kernel: rc.sysinit [130]: drop_caches: 3
Jan 11 11:44:26 kernel: ctf60211: world regulatory domain updated.
Jan 11 11:44:26 kernel: ctf60211: DFS Master region: unset
Jan 11 11:44:26 kernel: ctf60211: (start_freq - end_freq @ bandwidth), (max_antenna_gain, max_eirp)
), (dfs_cac_time)
Jan 11 11:44:26 kernel: ctf60211: (2402000 KHz - 2472000 KHz @ 40000 KHz), (N/A, 2000 mBm), (N/A)
Jan 11 11:44:26 kernel: ctf60211: (2457000 KHz - 2482000 KHz @ 40000 KHz), (N/A, 2000 mBm), (N/A)
Jan 11 11:44:26 kernel: ctf60211: (2474000 KHz - 2484000 KHz @ 20000 KHz), (N/A, 2000 mBm), (N/A)
Jan 11 11:44:26 kernel: ctf60211: (3375000 KHz - 5250000 KHz @ 80000 KHz, 160000 KHz, AUTO), (N/A, 2000 mBm), (N/A)
Jan 11 11:44:26 kernel: ctf60211: (5250000 KHz - 5230000 KHz @ 80000 KHz, 160000 KHz, AUTO), (N/A, 2000 mBm), (0 0)
Jan 11 11:44:26 kernel: ctf60211: (5490000 KHz - 5730000 KHz @ 160000 KHz), (N/A, 2000 mBm), (0 0)

```

Figure 7: System Log Screen

Setup Screen

The Setup screen allows the step-by-step configuration of the Horizon using the Web Configuration Manager (Figure 8). Please see Chapter 3 for complete description on Modes of Operation and example system configurations.

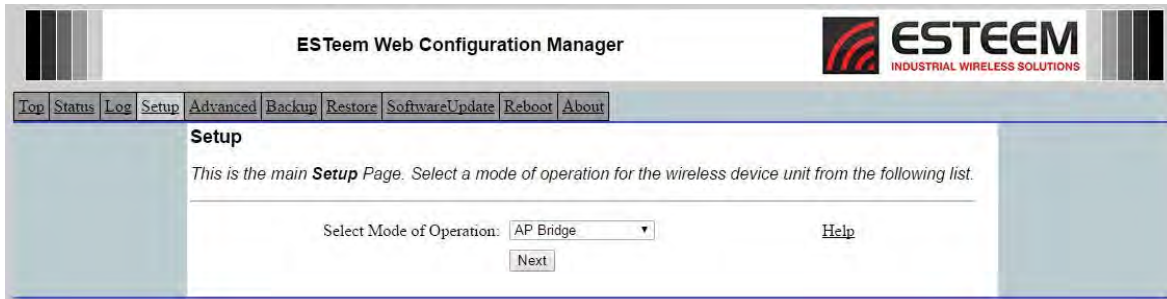

Figure 8: Setup Screen

Advanced Configuration Screen

The Advanced screen allows the user to access all configuration parameters. The parameters are grouped based upon their variable. **It is recommended that only advanced users of the Horizon enter this section unless instructed by ESTEEM technical support.** See Figure 9.



Figure 9: Advanced Features Screen

Backup Screen

The Backup Screen saves the current configuration in the Horizon to a file on the computer or network. See Figure 10. Pressing the Backup Button will create a configuration file that can be saved to the computer. This saved file can then be later opened, if necessary, by the Restore menu to quickly replace a Horizon with a spare modem.

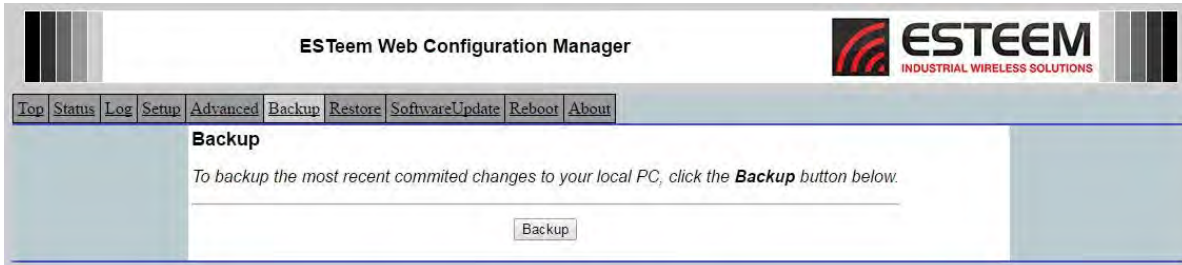

Figure 10: Backup Screen

Restore Screen

The Restore screen is used to restore the Horizon to factory defaults, return to the last saved configuration or to access the configuration files that were backed up to the computer. See Figure 11.

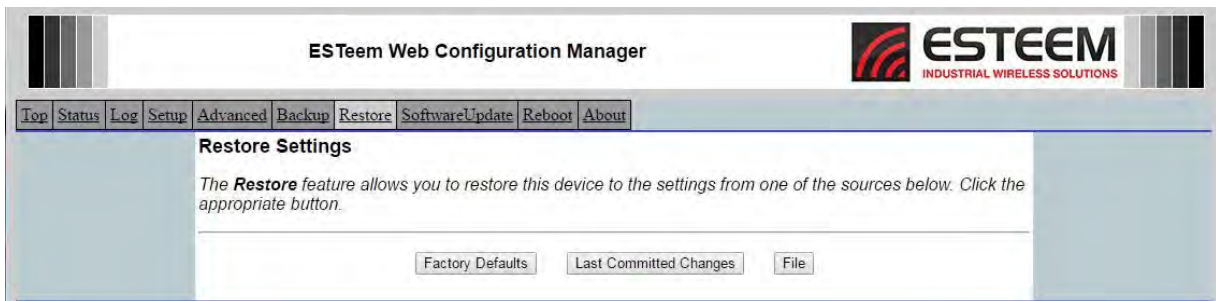

Figure 11: Restore Setting Screen

Factory Default – Returns the Horizon to all factory default values.

Last Committed Changes – This button will remove any changes to the modem that have been done since the last committed changes. The last committed changes will be read from the Flash file and reset in the Horizon.

File – Pressing this button will bring up a selection of where the restore file was saved during the Backup (Figure 12). Select “Upload via web browser” to browse for files saved on a local computer or select “Download from an http or ftp URL” for files saved on a network or over the Internet.

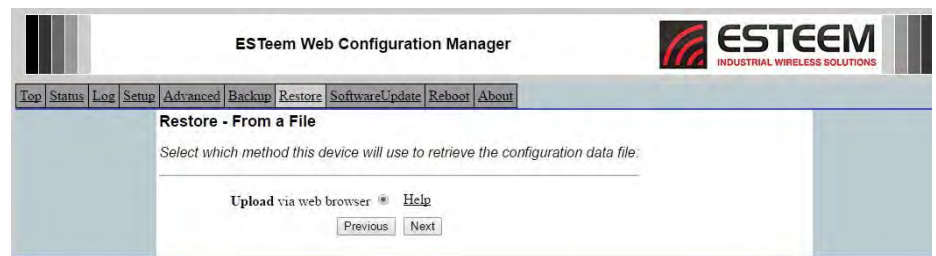

Figure 12: Restore from Local File Screen

Software Update Screen

The Software Update feature allows the user to update the latest Horizon operating system software from a file supplied by the factory or the Internet to the Horizon's flash memory. To upload from a file on your computer, select *Upload via web browser* and a file selection window will be displayed. To upload directly from the Internet, select *Download from an http or ftp URL* and enter the site address. See Figure 13.

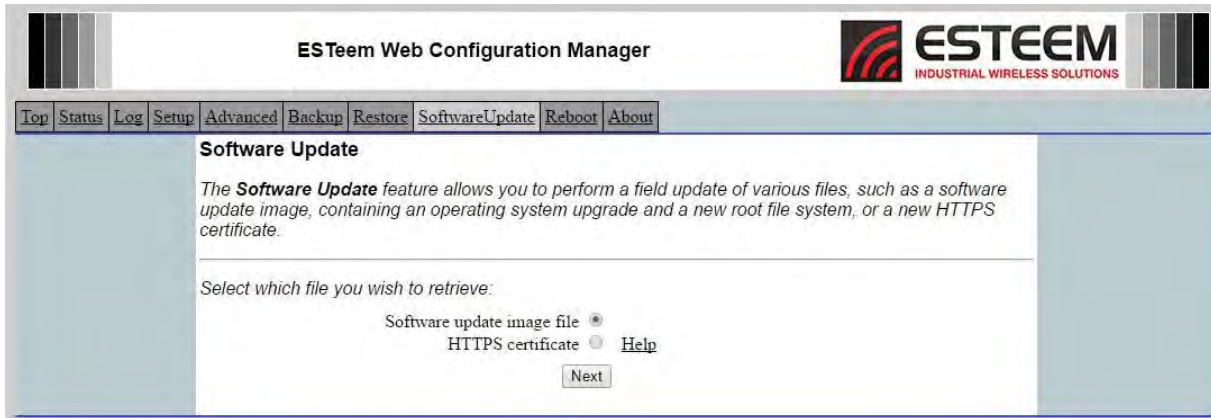

Figure 13: Software Update Screen

System Reboot Screen

The Reboot screen allows the user to reset the Horizon. See Figure 14.



Figure 14: System Reboot Screen

Using The RS-232 Programming Port

The RS-232 Programming Port will provide a limited set critical programming features such as setting the IP address or restoring the Horizon radio to factory faults. Any terminal emulation program that can run with VT100 emulation can be used for this configuration of the ESTeem Horizon. Any RS-232 terminal program (such as PuTTY - <http://www.putty.org>) will work. Configure your RS-232 port for a Baud Rate to 38,400, Data Bits to 8, Parity to None, Stop Bits to 1 and Handshaking to None. Once your Horizon has an IP address, you can attach the ESTeem to your network and use the Web Configuration Manager (Chapter 5 for complete details) for further programming.

Programming Using the RS-232 Programming Port

1. Connect the serial cable (EST P/N: AA0621.1) between the RS-232 connector (RJ-45) on the Horizon's RS-232 Programming Port to the serial port on the computer.
2. If your computer is configured properly, you will see the ESTeem Horizon booting sequence on your Terminal Emulation program. Once the ESTeem boot sequence is complete (approximately 60 seconds) you will receive this message:

“Please press Enter to active this console.”

If you don't see this message press the Reset button on the front panel of the Horizon and/or check the programming of your RS-232 port.

3. Press the Enter key and you will be at the Configuration Menu Horizon login prompt. See Figure 1.
4. To enter the Horizon Main Menu you will need to log into the system with a login name and password.
5. If this is not the first time configuration of the Horizon, see your network systems administrator for the password.
6. At the Horizon login prompt type **admin** for the login name and press the Enter key (<Enter>). **The login name is defined at the factory and is not changeable by the user. Note that all characters are lower case.**

If this is the first time the Horizon has been programmed or the Password was not changed from the factory default values, the factory default password is also **admin**. Enter **admin** for the password and press the Enter key (<Enter>).

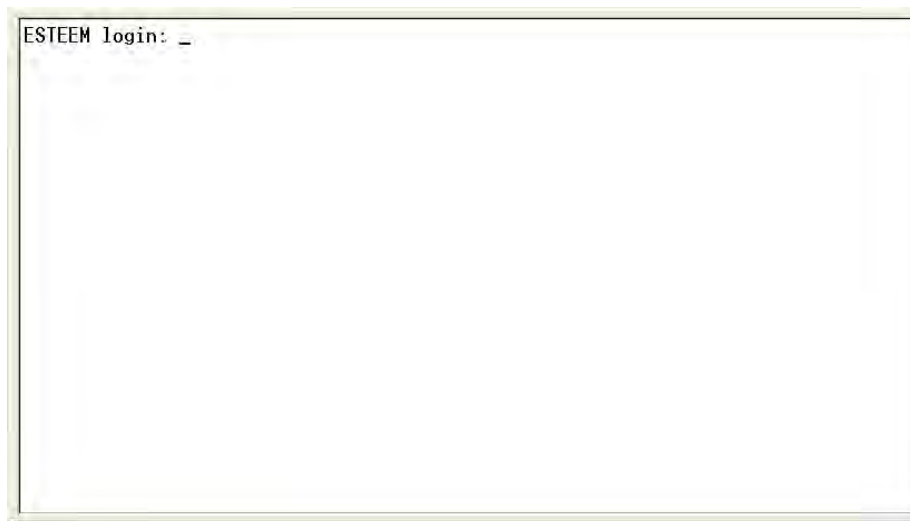

Figure 1: RS-232 Port Log-in Screen

7. To set the IP address in the ESTeem Horizon, type the letter “A” and press the Enter key. Enter the value for the IP address, Netmask and default route pressing the Enter key after each entry.

```
ESTEEM login: admin
Password:
a) Configure ethernet (and reboot)
b) Ping a host
c) Restore factory defaults (and reboot)
d) Log
e) Show devices
f) Reboot
q) Quit
Enter selection: _
```

Figure 2: RS-232 Welcome Screen

8. After the basic parameters have been entered into the Horizon you will need to commit the changes to the Horizon (Figure 3). Press the C key and then Enter. The changes will be saved to flash memory. You can use programming features in the ESTeem Web Configuration Manager to configure the unit for your application.

```
ESTEEM login: admin
Password:
a) Configure ethernet (and reboot)
b) Ping a host
c) Restore factory defaults (and reboot)
d) Log
e) Show devices
f) Reboot
q) Quit
Enter selection: a
eth0      Link encap:Ethernet  HWaddr 00:04:3F:00:26:DC
Enter IP address: 172.16.38.8
Enter netmask: 255.255.0.0
Enter default route: 172.16.1.6
Commit/Redo/Undo [c/r/u]: c_
```

Figure 3: RS-232 Welcome Screen

Using The RS-232 Data Port

The ESTeem Horizon has a serial data port that can provide RS-232 communication between two or more serial devices using the wireless broadband link. The serial data is encapsulated and transferred as a standard Ethernet packet over an operating Horizon wireless Ethernet system. The configuration for a serial Horizon network will be the same as an Ethernet or a serial (RS-232) based communication network.

The serial interface option can be used to link two or more serial devices in a new or existing system. The serial data has very little impact on the network bandwidth and will allow for both Ethernet and serial applications simultaneously. A possible application would be installation of the Horizon in an existing serial based network that was looking for future upgrade to an Ethernet based system. Another would be using the high-bandwidth Ethernet connections to provide a link to remote video hardware while also providing a serial link to the existing PLC in a SCADA type application.

Serial Connections

The RJ-45 serial data port is the far-left port on the face of the Horizon (Figure 4). Using the ESTeem AA0621.1 interface cable, the Horizon can be connected to a standard DTE-device (PC) with a male 9-pin Sub-D connector. The complete cable configuration is available in Appendix C – Interface Ports.



Figure 4: Horizon Front Panel Overview

Serial Configuration

Configuration of the serial port is done in **Advanced>Serial Port Settings**. Select **Serial Port Settings>RS-232** and press the *Next* button, the Serial Port Setup screen (Figure 5) will be displayed. Each section in the Serial Port Setup screen is described in detail with the following:

Data Serial Port

Enabling the serial data port allows the modem to send RS-232 data over the broadband wireless connection established with the ESTeem repeater peers. The modem can be configured in a point-to-point or point-to-multipoint system. Select *Yes* if you wish to enable the serial data port.

Serial Mode

There are two distinct modes of operation for the serial port in the Horizon. The Redirector mode will provide two-way serial communication between two or more serial devices, while the Terminal Server mode will allow serial communication to a specific remote site by connecting through telnet or SSH. Select one of the following modes of operation:

Full Redirector Mode - This mode allows bi-directional RS-232 data communication with other ESTeem Horizon's. The RS-232 data transmission will appear transparent to the connected devices as if a serial cable is connected between the two ports. This mode will also be used in a multi-point serial network were all serial devices will need bi-directional communication (Figure 6).

Terminal Server Mode - This mode of operation translates RS-232 serial data into a network-oriented terminal protocol, such as telnet or SSH. This mode would be selected if an interactive RS-232 session at remote locations is desired over the wireless Ethernet link.

Serial Baud Rate

Select the data rate of the RS-232 connection to match your serial device.

Advanced - Serial Port Settings

The following is a list of those configuration variables under the **Serial Port Settings** category. These variables contain values for configuring the **sp0** serial port.

<p>Data Serial Port: <input type="radio"/> On <input checked="" type="radio"/> Off</p> <p>Serial Mode: <input checked="" type="radio"/> Full Redirector Mode <input type="radio"/> Terminal Server Mode</p> <p>Serial Baud Rate: <input type="radio"/> 2400 baud <input type="radio"/> 4800 baud <input type="radio"/> 9600 baud <input checked="" type="radio"/> 19200 baud <input type="radio"/> 38400 baud <input type="radio"/> 57600 baud <input type="radio"/> 115200 baud</p> <p>Serial Data Bits: <input type="radio"/> 7 <input checked="" type="radio"/> 8</p> <p>Serial Stop Bits: <input checked="" type="radio"/> 1 <input type="radio"/> 2</p> <p>Serial Parity: <input type="radio"/> Even <input type="radio"/> Odd <input checked="" type="radio"/> None</p> <p>Serial Flow Control: <input type="radio"/> Hardware <input type="radio"/> Software <input checked="" type="radio"/> None</p> <p>Serial Multicast TTL: <input type="text" value="2"/></p> <p>Destination IP: <input type="text" value="0.0.0.0"/></p> <p>Destination Port: <input type="text" value="1412"/></p> <p>Maximum Packet Size: <input type="text" value="1024"/></p> <p>Dwell Time: <input type="text" value="10"/></p> <p>Delimiter 1: <input type="radio"/> On <input checked="" type="radio"/> Off</p> <p>Delimiter 1 (hex): <input type="text" value="00"/></p>	<p>Select whether you want to turn on the data serial port.</p> <p>Select whether you want the full redirector mode or the terminal server mode.</p> <p>Select the serial data rate.</p> <p>Select the number of data bits</p> <p>Select the number of stop bits.</p> <p>Select the parity.</p> <p>Select the serial flow control.</p> <p>Enter the maximum bridge links for multicast packets (1-255). Time To Live(TTL).</p> <p>Enter the destination IP address for the serial packets (this address can be multicast)</p> <p>Enter the serial IP port number (1024-64535), which must be the same for all serial peers</p> <p>Enter the maximum packet size in bytes (1-1024)</p> <p>Enter the number of milliseconds (10-10000) of silence on the serial port for packetization.</p> <p>Select whether to turn on the use of delimiter character 1.</p> <p>Enter the packetization and Tx delimiter character 1 in hexadecimal (00-ff).</p>
---	--

Figure 5: Serial Configuration Screen

Serial Data Bits

Select the number of data bits on the RS-232 connection to match your serial device.

Serial Stop Bits

Select the number of stop bits on the RS-232 connection to match your serial device.

Serial Parity

Select the parity of the RS-232 connection to match your serial device.

Serial Flow Control

Select the type of data flow control used on the RS-232 connection. The ESTeem can support Hardware flow control (RTS/CTS control lines) or Software Flow Control (XON/XOFF). Select None if no serial flow control is necessary.

Serial Multicast TTL (Maximum Bridge Links for Multicast Packets)

This value sets the maximum number of Ethernet bridge links that the multicast packets will be sent through when used in a multi-point system. A multi-point serial network uses multicast packets (UDP) to send the data to more than one remote ESTeem. You want to limit the number of network bridge links that these UDP packets will be passed through to make the network more efficient.

If you are using multiple ESTeem repeater links to send the serial data to remote locations, the value for the maximum bridge link needs to be increased to a number greater than the longest repeater chain. For example, if you are using four repeater (peer) links to send the serial data between two or more sites the number will need to be five (5) or greater (Figure 4).

Destination IP Address

The ESTeem configured for the correct destination IP and port number will send and receive the serial data from another modem. Set the destination IP address for the ESTeem where the serial data will be sent. If sending to more than one ESTeem (Multipoint) set to a multicast address (i.e 224.0.0.1).

Note: If you are using the ESTeem Horizon in a multipoint application (multicast), you must have default Gateway configured in the ESTeem set to the IP address of the Root Bridge modem.

Destination Port

The ESTeem configured for the correct destination IP and port number will send and receive the serial data from another modem. Set the IP port numbers to match where the serial data will be sent. The serial data will not be sent if both the IP address and port number is not correct.

Maximum Packet Size

This number represents the maximum size of the serial data packet in bytes. If the number of bytes of data in the serial port buffer exceeds the maximum packet size before the timer or delimiter character is reached, the ESTeem will send forward the serial packet. For example, if the maximum packet size is set to a value of 100, when the serial port receives 100 bytes the data will be sent through the wireless connection.

Dwell Time (Number of Milliseconds for Packetization)

This number represents the time the ESTeem will hold data in the serial data buffer before sending to the remote ESTeem. This feature is generally used if the serial data does not have a consistent packet length or delimiter character. For example, if the number of milliseconds is set to a value of 10 the ESTeem will monitor the incoming serial data stream and any break in characters longer than 10 milliseconds will cause the data will be sent through the wireless connection.

Delimiter Characters

Enabling and specifying a delimiter character will transmit the data in the serial buffer when the delimiter character is recognized in the serial data stream. There are two unique delimiter characters that can be configured and enabled independently.

Modem Control Lines

Enabling this feature will allow the ESTeem in the Terminal Server mode to read and generate modem control lines to the connected device.

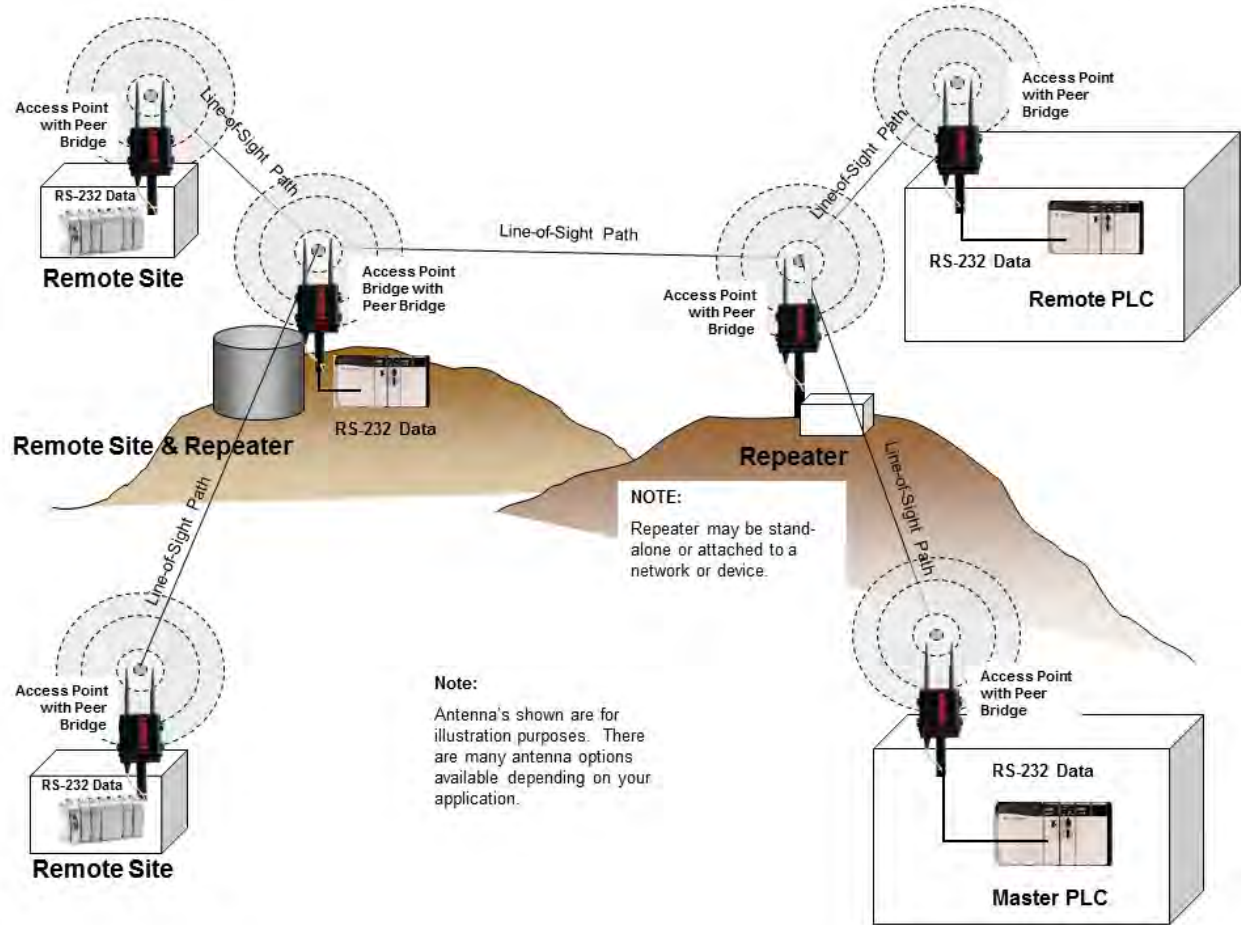

Figure 6: Serial Full Redirector Example

To increase the wireless network's area of coverage for both indoor and outdoor applications, the Horizon utilizes a custom meshing feature that allows increased coverage areas without the added expense of hard cabling or adding an additional point to point radio link.

With a conventional IEEE 802.11 (Wi-Fi) Access Point (AP) network, all of the APs have to be interfaced to a common network either by hardwire, see Figure 1, or a separate, dedicated RF backbone. The Model Horizon can create this RF backbone, bridge Ethernet networks connected to the wired Ethernet port and provide the wireless canopy for 802.11 clients simultaneously.

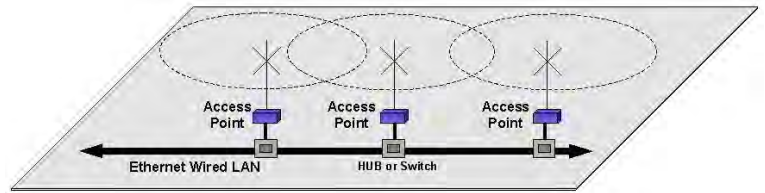

Figure 1: Conventional Access Point Diagram

When programmed in any of the three Access Point (AP) Modes (Bridge, Router or Masquerade), the Horizon will create a wireless network with other Horizon units in radio range that are programmed in the Peer table during setup. This feature adds the increased functionality of repeaters to the typical Ethernet Bridge configuration.

ESTeem Mesh Network

One of the most powerful features of the AP Peer Mode is the ability to input multiple communication routes and designate the priority for each of these routes to create a wireless Mesh network. The ESTeem Horizon will automatically change communication routes in the network if a route has failed. The new route will be based upon the priority level set during configuration. This wireless Meshing technology allows the RF network to "self-heal" if any of the communication paths fail.

The routing priority is manually set during the configuration of the Horizon. A manual path configuration is far superior to standard "self-discovery" networks, because you have direct control over the best RF paths and can easily identify any failed routes for easy troubleshooting. For example, Figure 2 shows a typical wireless Ethernet system used in the Water/Waste Water Industry. The problem with a standard "self-discovery" Mesh network is the selection of routes. Notice that the communication between the Water Plant (Site A) and Pump Site D has a marginal link, but it is the most direct route between the Ethernet devices.



Figure 2: Small Mesh Network Diagram

This scenario poses the question, which path will the network select? The ESTeem Mesh Network takes out the guessing games by allowing the user to select and prioritize all communication routes in the system. In our example we would want the primary link to go through Tank B (Repeater) and use the direct link only if this primary link fails. The following sections will show how this completed.

Configuration

The configuration of the wireless paths is completed during setup of the Access Point modes. All three Access Point modes support repeating and Meshing features. The Mesh network configuration using the ESTeem Network Configuration (ENC) Utility is shown in detail in Chapter 3 of this User's Manual.

You can also configure the Mesh networking directly through the web configuration setup (Chapter 5). Figure 3 shows an example repeater peer table from the setup menus. For the Horizon to communicate with another Horizon, select Yes must at **Enable Peer Capability**. Next, the Serial Number or Wireless LAN (WLAN) MAC address of each Horizon that will have direct communications must be added to the Peer List. Finally, **enabling the link** allows the corresponding Horizon to be included in the communication routing. Mobile clients do not require input in the repeater peer table. If multiple Mesh routes are configured, you will also need to set the values for Priority and Path Costs (explained in Rapid Spanning Tree below). For multiple examples of repeater configurations, please refer to Chapter 3 of this user's manual.

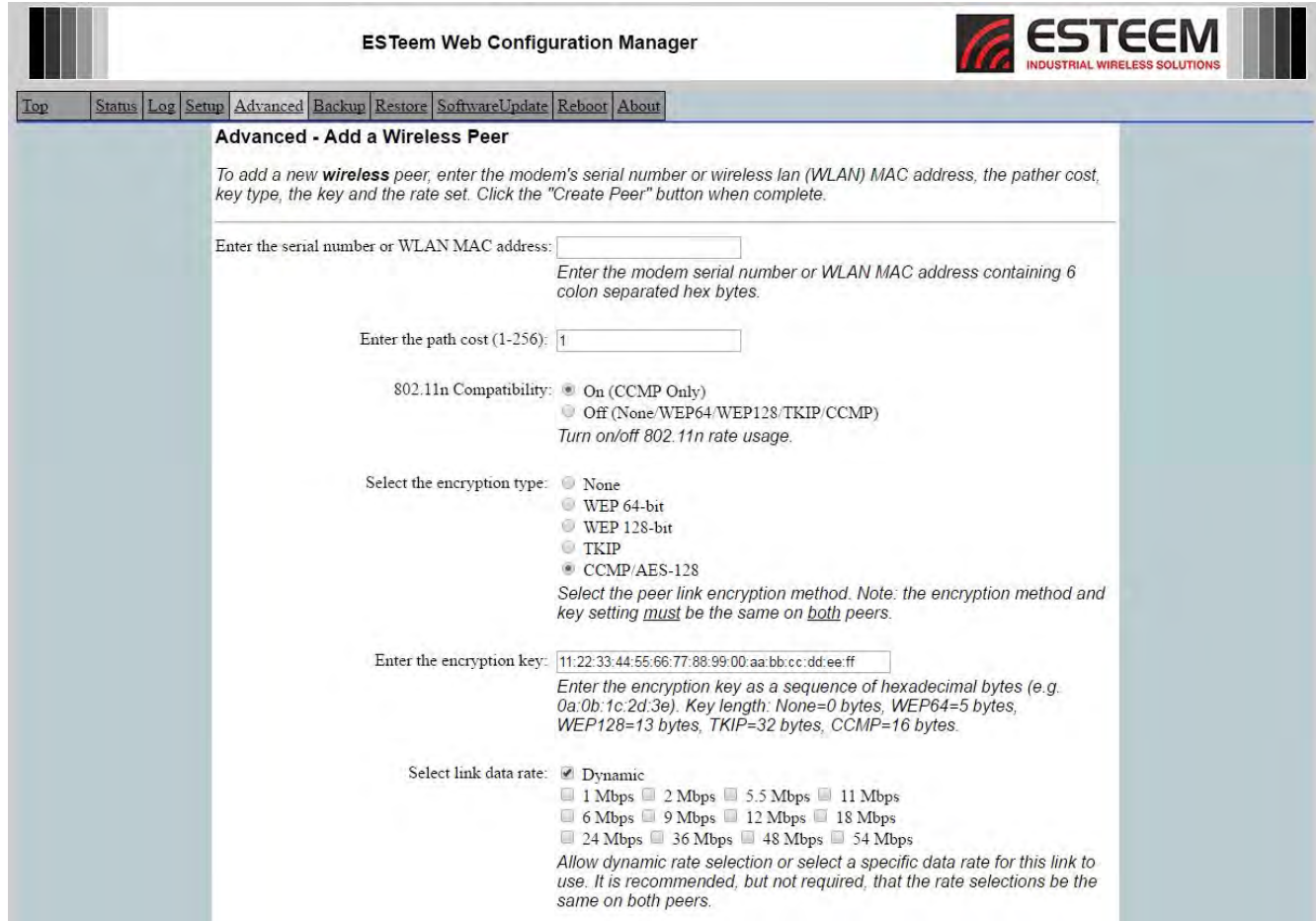

The screenshot displays the 'ES Teem Web Configuration Manager' interface. At the top, there is a navigation menu with options: Top, Status, Log, Setup, Advanced, Backup, Restore, SoftwareUpdate, Reboot, and About. The main content area is titled 'Advanced - Add a Wireless Peer'. Below the title, there is a descriptive text: 'To add a new wireless peer, enter the modem's serial number or wireless lan (WLAN) MAC address, the path cost, key type, the key and the rate set. Click the "Create Peer" button when complete.' The form contains several input fields and radio button options: 1. 'Enter the serial number or WLAN MAC address:' with a text input field and a note: 'Enter the modem serial number or WLAN MAC address containing 6 colon separated hex bytes.' 2. 'Enter the path cost (1-256):' with a text input field containing the value '1'. 3. '802.11n Compatibility:' with radio buttons for 'On (CCMP Only)' (selected) and 'Off (None/WEP64/WEP128/TKIP/CCMP)'. A note below says 'Turn on/off 802.11n rate usage.' 4. 'Select the encryption type:' with radio buttons for 'None', 'WEP 64-bit', 'WEP 128-bit', 'TKIP', and 'CCMP/AES-128' (selected). A note below says 'Select the peer link encryption method. Note: the encryption method and key setting must be the same on both peers.' 5. 'Enter the encryption key:' with a text input field containing '11:22:33:44:55:66:77:88:99:00:aa:bb:cc:dd:ee:ff' and a note: 'Enter the encryption key as a sequence of hexadecimal bytes (e.g. 0a:0b:1c:2d:3e). Key length: None=0 bytes, WEP64=5 bytes, WEP128=13 bytes, TKIP=32 bytes, CCMP=16 bytes.' 6. 'Select link data rate:' with a checked radio button for 'Dynamic' and several unchecked radio buttons for specific rates: 1 Mbps, 2 Mbps, 5.5 Mbps, 11 Mbps, 6 Mbps, 9 Mbps, 12 Mbps, 18 Mbps, 24 Mbps, 36 Mbps, 48 Mbps, and 54 Mbps. A note below says 'Allow dynamic rate selection or select a specific data rate for this link to use. It is recommended, but not required, that the rate selections be the same on both peers.'

Figure 3: Repeater Configuration Example

Rapid Spanning Tree Protocol (RSTP)

The ESTEem Horizon uses standard Ethernet Rapid Spanning Tree Protocol (RSTP) to determine the radio routing structure of the wireless network. The primary purpose of RSTP is to make sure that “network loops” are not created. A network loop is having two communication paths to the same destination where the remote device would receive the same data multiple times. If there were no way to control the data flow, this data would be constantly passed around this loop causing a “packet storm” that would shut down the entire network. The Spanning Tree Protocol will block all these redundant links.

The RSTP operation begins by determining which Ethernet device on the network will be the Root Bridge. All Ethernet networks have a Root Bridge that is selected by the lowest MAC address. All path costs are evaluated against this Root Bridge device to determine routing and which paths will be blocked. On a wired Ethernet network, the location of the Root Bridge is not really important, but in a wireless network selection of the Root Bridge is critical to the wireless network routing. Let’s use one of the Example network diagrams from Chapter 3 to continue the discussion (Figure 4).

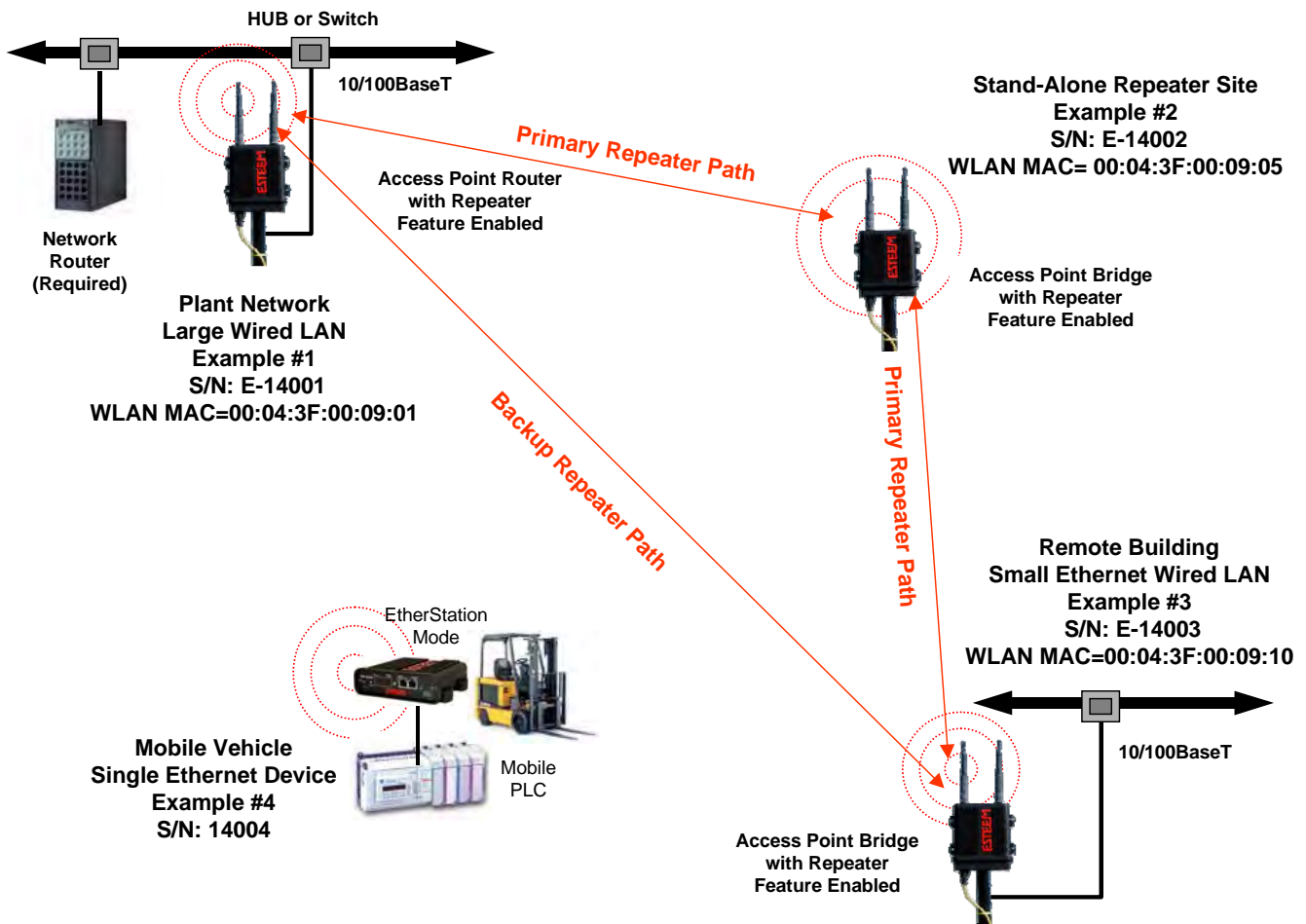

Figure 4: Programming Example #1 Diagram

RSTP Phases

The following sections describe the process of the RSTP in the ESTeem Horizon as how it would happen in the above example.

Learning Phase - Once properly configured, each Horizon will begin to search out the other Horizon units in radio range that are programmed in the AP Repeater Peer table. All Horizon's will calculate their routes to every Horizon in the network based upon the lowest "path length" to the Root Bridge. Path length is the total number of wireless links (repeater peer links) to transmit a packet through the wireless network to the Root Bridge. **Note: The Root Bridge in a network should be the Horizon where the majority of the data flow is processed.** In every wireless network of two or more radios, the Root Bridge should be user defined. If not defined, the Horizon with the lowest MAC address will be designated as the Root Bridge.

In Figure 4, the Plant network (Example 1) is the most logical location for the Root Bridge based upon the amount of data flow. Setting this site as the root bridge is discussed below in Root Bridge.

Blocking and Forwarding Phase – To ensure you do not have a network loop situation due to redundant paths in your wireless network, the Model Horizon will recognize and disable (block) one or more redundant links and provide back up links should the primary link fail. This establishes a wireless mesh network with a series of forwarding links, based upon the shortest path length to the Root Bridge.

For example, looking at Figure 4, the Remote Building has two routes to the Root Bridge (Plant Network – Example #1); directly to the site and through the repeater. The direct link between the two sites is the shortest route (lowest Path Length) and will be selected as the primary route unless overridden by manually changing the Path Length in the configuration.

Path Cost

If more than one communication path to the Root Bridge is found, the Horizon must determine which route to take based upon the lowest Path Cost. The default path cost to all links in the Horizon network is 1. If the Path Costs are equal then the lowest MAC address will determine the priority route. In the ESTeem Mesh Network we want to directly control all data flow so do **not** want the routes to be automatically determined.

Looking again at our Example in Figure 4, if we made no changes to the default path cost of 1 (note values in Figure 3) the lowest path cost would be direct from the Remote Building to the Root Bridge (Plant Network).

Link Description	Total Path Length
Direct from Remote Building	1
Remote Build to Root Bridge Through Repeater	2 (Length 1 to repeater + Length 1 to Master = 2)

To configure the Horizon to select the repeater as the primary radio path, set the path cost value for the direct link greater than 2 (such as a value of 3) to make this the primary radio path. The lowest path length will identify the highest priority. The Model Horizon will use this routing, but also switch to direct communication if the repeater were to disappear.

Root Bridge

In any Access Point Repeater network consisting of more than two sites, one Model Horizon should be designated as the Root Bridge. Only one Model Horizon can be designated as the Root Bridge in a given network and should be located where the majority of the Ethernet data flow is processed. This site may be the Master location in a SCADA network or could be configured at a repeater site. Selection is important because all Model Horizon's **NOT** configured as the Root Bridge will choose routing based upon the Path Length to the Root Bridge. If you have any question as to which site in your AP Repeater application should be the Root Bridge, contact ESTeem Customer Support at 509-735-9092 or e-mail your application to support@esteem.com.

The Root Bridge will be selected in one of two ways: the Root Bridge can be manually set (recommended) during the configuration of the Repeater Peer table (Figure 3) **or** the Root Bridge designation will default to the lowest MAC address of all the Model Horizon's in the network. The manual Root Bridge configuration is located in the "Advanced Settings" section.

Redundant Backup

The ESTeem Horizon configured in Access Point mode will automatically function as a redundant backup if two Horizons are installed at the same location (Figure 7). If two Horizons are connected to the same switch, one of the Horizons will be **Blocked** when the Rapid Spanning Tree Protocol is completed. The network will continue to use this route until any problem with the original Model Horizon is detected and the second Horizon will begin operation at that site.

Redundant Master Configuration

The configuration in Figure 7 will also provide a redundant backup for the Master Site (Root Bridge). Configure both Horizons as Root Bridges (see above) giving the primary Root Bridge a value of 1 and the secondary Root Bridge a value of 2.

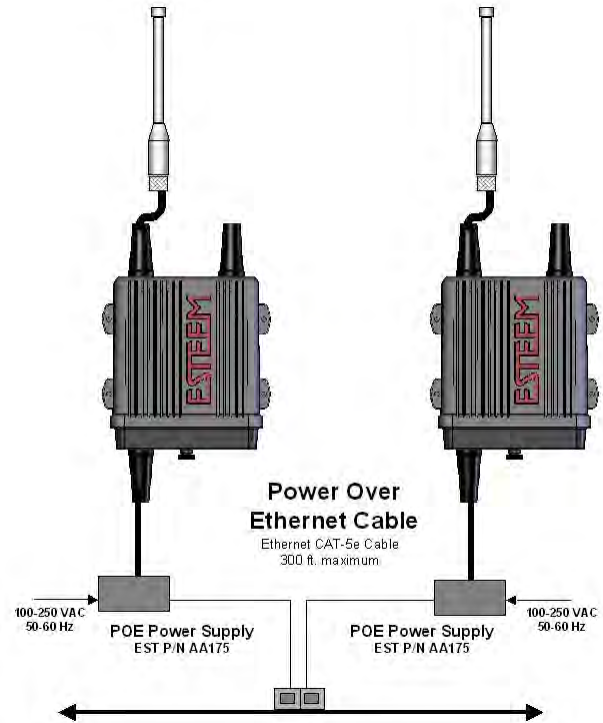

Figure 7: Redundant Backup Diagram

Horizon 2.4 GHz Antenna and Cable Configurations

ESTeem offers different types of antennas for both indoor and outdoor configurations. To reduce potential radio interference to other users, the antenna type and its gain should be chosen so that the equivalent isotropically radiated power (e.i.r.p.) is not more than that permitted for successful communication.

This radio transmitter ESTeem Horizon 2.4 GHz (HVIN: 216AN) has been approved by Industry Canada to operate with the antenna types listed below with the maximum permissible gain and required antenna impedance for each antenna type indicated. Antenna types not included in this list, having a gain greater than the maximum gain indicated for that type, are strictly prohibited for use with this device.

Le present emetteur radio ESTeem HVIN: 216AN a ete approuve par Industrie Canada pour fonctionner avec les types d'antenne enumeres ci-dessous et ayant un gain admissible maximal et l'impedance requise pour chaque type d'antenne. Les types d'antenne non inclus dans cette liste, ou dont le gain est superieur au gain maximal indique, sont strictement interdits pour l'exploitation de l'emetteur.

Warning: *Only the tested cable lengths and antennas provided by ESTeem meet the FCC maximum peak output power requirements. Any other combination of antennas or coax cables is not authorized. This device has been designed to operate in a pole mount configuration with the antennas listed below, having a maximum gain of 6 dB in a multi-point system or 15dB in a point to point network. Antennas not included in this list or having a gain greater 6 dB in a multi-point system or 15dB in a point to point network are strictly prohibited for use with this device. The required antenna impedance is 50 ohms.*

Part Number: AA20DMEg

- Omni-directional direct mount antenna, 5 dBi gain.
- Indoor and outdoor applications.
- There must be a minimum separation distance of 24 cm. from the antenna to the user. **See Warnings.**

Part Number: AA203Eg

- Directional pole mount antenna, 6 dBi gain with 3-ft. integral feedline and connector.
- Point to point and point to multi-point outdoor applications.
- Antenna port B is not used in this configuration.
- There must be a minimum separation distance of 24 cm. from the antenna to the user. **See Warnings.**

Part Number: AA204Eg.1

- Directional pole mount antenna, 15 dBi gain with 3-ft. integral feedline and connector.
- Point to point applications only.
- Maximum Output Power of 250mWatts (Power Level = Low Power)
- Antenna port B is not used in this configuration.
- There must be a minimum separation distance of 50 cm. from the antenna to the user. **See Warnings.**

Transmit/Receive
Antenna Port 1

Receive Only
Antenna Port 2



Warnings:

Only pre-made coax cables from the factory used in conjunction with either the AA203Eg or AA204Eg.1 directional antennas meet all FCC Section 15.247(b) EIRP maximum power requirements.

Use of the AA204Eg.1, directional antenna is limited to fixed point to point applications only. In accordance FCC Section 15.247(b)iii, this antenna must be professionally installed. The installer must ensure the system is used exclusively for fixed, point-to-point applications and the ESTeem Horizon is set for 0.25 Watts output power (Power Level = Min).

Horizon 900 MHz Antenna and Cable Configurations

ESTeem offers different types of antennas for both indoor and outdoor configurations. This device has been designed to operate with the antennas listed below, and having a maximum gain of 7 dB. Antennas not included in this list or having a gain greater than 7 dB are strictly prohibited for use with this device. The required antenna impedance is 50 ohms.

This radio transmitter ESTeem Horizon 900 MHz (HVIN: 216AD) has been approved by Industry Canada to operate with the antenna types listed below with the maximum permissible gain and required antenna impedance for each antenna type indicated. Antenna types not included in this list, having a gain greater than the maximum gain indicated for that type, are strictly prohibited for use with this device.

Le present emetteur radio ESTeem HVIN: 216AD a ete approuve par Industrie Canada pour fonctionner avec les types d'antenne enumeres ci-dessous et ayant un gain admissible maximal et l'impedance requise pour chaque type d'antenne. Les types d'antenne non inclus dans cette liste, ou dont le gain est superieur au gain maximal indique, sont strictement interdits pour l'exploitation de l'emetteur.

Warning: Only the tested cable lengths and antennas provided by EST meet the FCC and DOC maximum peak output power requirements. Any other combination of antennas or coax cables is not authorized. To reduce potential radio interference to other users, the antenna type and its gain should be so chosen that the equivalent isotropically radiated power (e.i.r.p.) is not more than that permitted for successful communication.

Transmit/Receive
Antenna Port 1

Receive Only
Antenna Port 2

Part Number: AA20DMs

- Omni-directional direct mount antenna, 2 dBi gain.
- Indoor and outdoor applications.
- There must be a minimum separation distance of 23 cm. from the antenna to the user. **See Warnings.**

Part Number: AA20Es900

- Omni-directional external pole mount antenna, 7 dBi gain with 3-ft. integral feedline and connector.
- Outdoor applications.
- There must be a minimum separation distance of 23cm. from the antenna to the user. **See Warnings.**

Part Number: AA203Es900

- Directional pole mount antenna, 7 dBi gain with 3-ft. integral feedline and connector.
- Point to point and point to multi-point outdoor applications.
- There must be a minimum separation distance of 23 cm. from the antenna to the user. **See Warnings.**



Notes:

Antenna Port A is a transmit and receive port for use in all applications.

Antenna Port B is a receive only port and is used for dual diversity antennas applications only. This port is not used for point to point applications.

Warnings:

Only pre-made coax cables from the factory used in conjunction with either the AA20Es900 omni-directional and AA203Es900 directional antennas meet all FCC Section 15.247(b) EIRP maximum power requirements.

WEATHER PROOFING COAX CONNECTIONS

1. Lightly coat the threads of the connectors with silicone lubricant prior to assembly (See Note 1) and hand tighten. Make sure to use the silicon sparingly so when assembled, any excess does not get on center conductor. Care should be taken not to get any lubricant on the center conductor.
2. Wrap the connector assembly with a non-adhesive silicone tape, EST part number AA243, for weather proofing (See Note 2 and instructions below).
 - a) Clean surface to be wrapped. Cut off length to be used.
 - b) Peel back a short length of protective film. Keep tape clean and dry.
 - c) Begin with one complete overlap of tape onto itself.
 - d) STRETCH CoaxWrap while continuing to wrap object with “half-laps”, removing clear film as you go (Figure 1). For greater pressure resistance, use 2 or more tightly wrapped layers.
 - e) End of tape at final wrap should be completely positioned onto itself.

Note: CoaxWrap’s bond begins to cure immediately upon contact with itself. Repositioning or removal is not recommended after 2 minutes of wrapping.

3. Apply an electrical coating (sealing agent), over the vapor barrier patch for added protection (See Note 3).

NOTES:

1. Dow Corning RTV-3140 or equivalent.
2. CoaxWrap, CW10B or equivalent.
3. SCOTCHKOTE, 3-M Company, or equivalent.

**ANTENNA DIVERSITY**

The dual diversity antenna configuration on the Horizon allows the radio to operate more efficiently in areas with high reflections (such as indoors or in a city) without direct line of sight (LOS) between the antennas. One of the most difficult conditions to control in a radio system is the effect of a destructive reflected radio signal called mutipathing. Multipathing occurs when waves emitted by the transmitter travel along a different path and interfere destructively with waves traveling on a direct line-of-site path. The phenomenon occurs because waves traveling along different paths may be completely out of phase when they reach the antenna, thereby canceling each other out. The dual diversity antenna configuration places a physical distance between the antennas where one reflected signal will be out of phase, but the second will be not. The ESTeem Horizon will sample both antennas and select the best receive signal. Both antenna ports are active by default in the Horizon series.

Assembling The AA195PM Two Hole Outdoor Pole Mounting Kit

The AA195PM mounting kit contains everything required for pole mounting and weatherproofing the ESTeem Horizon for outdoor installations. The Horizon with AA195PM mounting kit can be directly mounted to a round pole from 1.25" to a diameter of 2.25" OD. Any mounting structure greater than 2" requires hose clamp strapping run through the Pole Mount Brackets. The mounting kit requires the following assembly:

1. If you purchased an AA195PM mounting kit with your Horizon, the kit will be packed in the same packing box as the ESTeem (Figure 4).

2. Remove and inventory the two (2) Pole Mounting Brackets, one (1) Two-Hole Face Plate Cover (with single port cover installed), one (1) Heat Shield and (1) AA195PM Hardware bag from the packing box (Figure 4). Report any missing or damaged items to ESTeem Customer Support (Phone 509-735-9092) as soon as possible for replacement.



Figure 4: Packet Box Contents

3. Inventory the AA195PM Hardware bag for all the components listed in Figure 5.

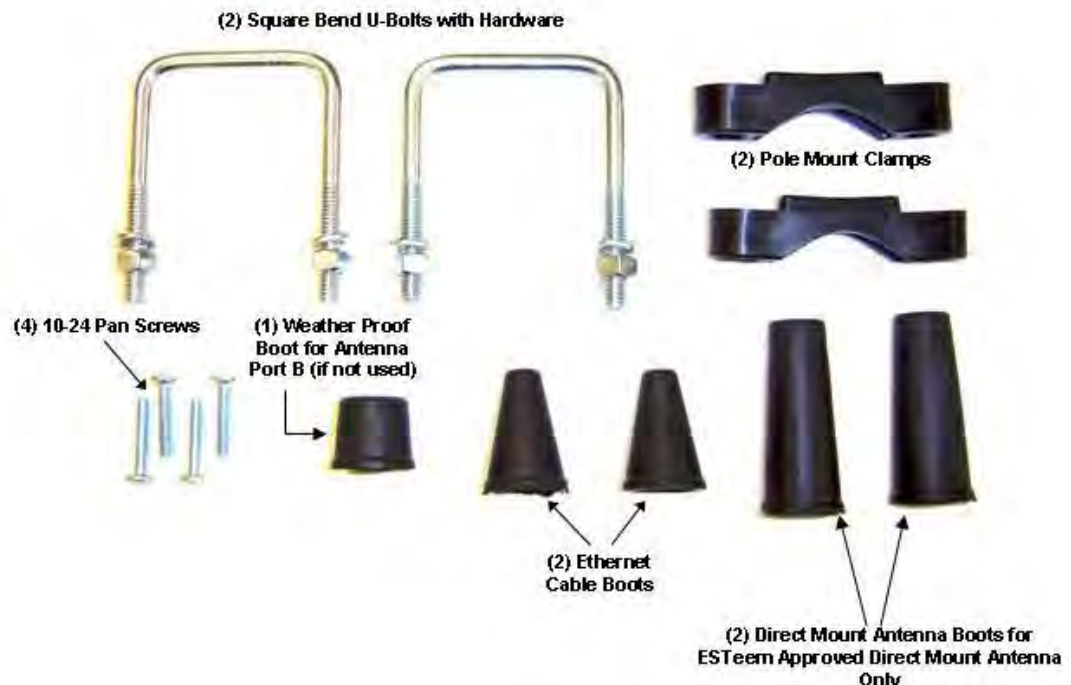

Figure 5: AA195PM Hardware Contents

4. Assemble the two Pole Mounting Brackets with the included U-bolts, hardware and Pole Mount Clamps. Reference Figure 6.

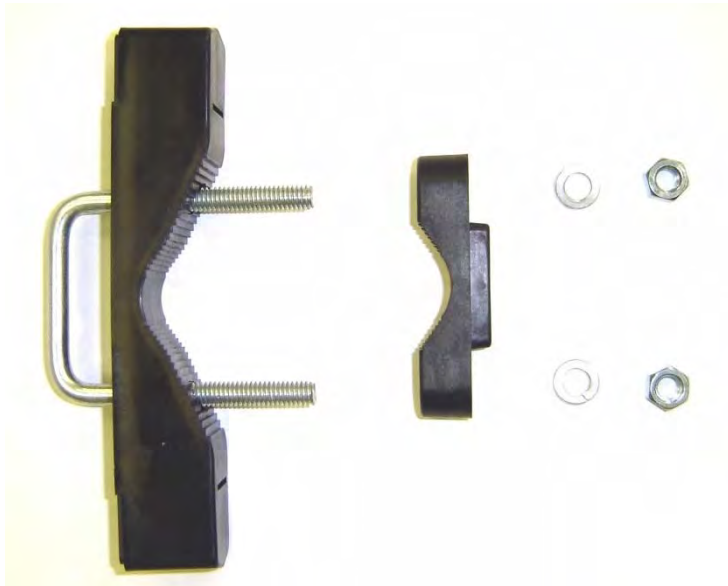

Figure 6: Pole Mount Assembly

5. Place the four supplied 10-24 x 1" Phillips Pan Head screws through the mounting holes of the Heat Shield and attach to the top of the ESTeem Horizon (Figure 7).
6. Attach the two Pole Mounting Brackets to the ESTeem Horizon with the 10-24 x 1" Phillips Pan Head screws through the top of the heat shield. Reference Figure 8 (Heat Shield removed for detail).



Figure 7: Heat Shield Attachment

7. Assemble the outdoor rated CAT-5e Ethernet cable (Not Provided) with the supplied Ethernet Cable Boot (Figure 9).



Figure 8: Pole Mount Connection to Case
(Heat Shield Removed for Detail)



Figure 9: Ethernet Cable Assembly

- Feed the CAT-5e Ethernet connector(s) through the Face Plate Cover and secure the Ethernet Cable Boot to the cover. Reference Figure 10.

NOTE: The Ethernet cable boot must be installed before the RJ-45 end is installed. If using the ESTeem AA09.1 outdoor Ethernet cable, verify that the Ethernet cable boot end is routed toward the ESTeem Horizon.

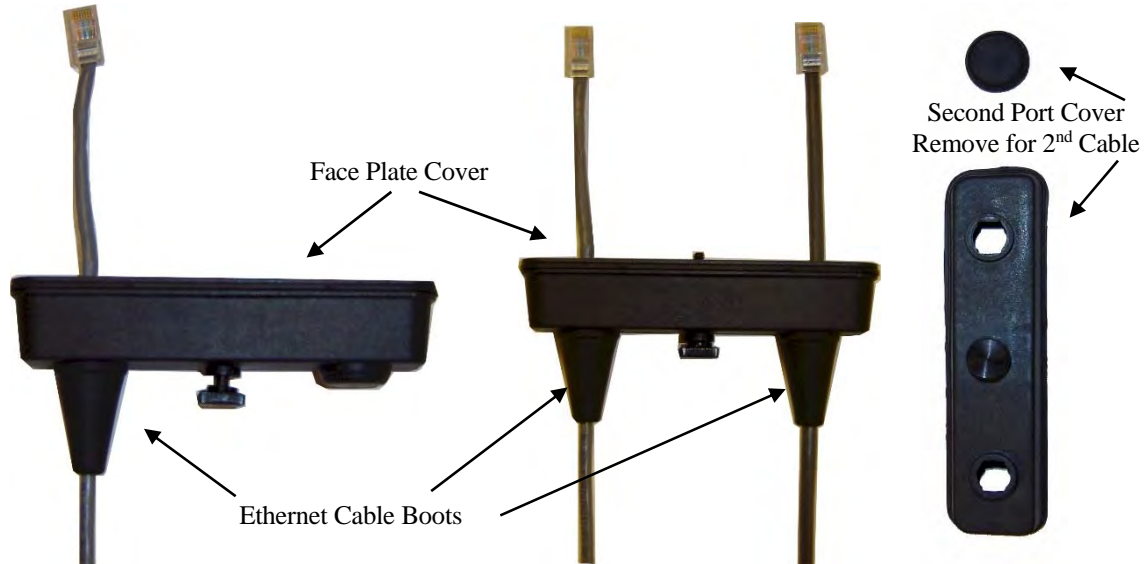

Figure 10: Ethernet Cable Routing

- Route the CAT-5e Ethernet cable through the molded strain-relief fins in the Face Plate Cover (Figure 11) to secure the cable and provide strain-relief for the connector. If a second Ethernet cable is installed, remove the second port cover and route cable.



Figure 11: Face Plate Cover Strain Relief

- Plug the CAT-5e Ethernet cable to the Horizon's Ethernet port and secure the Face Plate Cover with the attached thumb screw. Verify that the weatherproof seal on the Face Plate Cover is sealed against the outer rim of the Horizon. Reference Figure 12.
- Attach the antenna connector boots as show in Figure 13 for either dual attached antennas or external antennas. You are now ready to mount the ESTeem Horizon

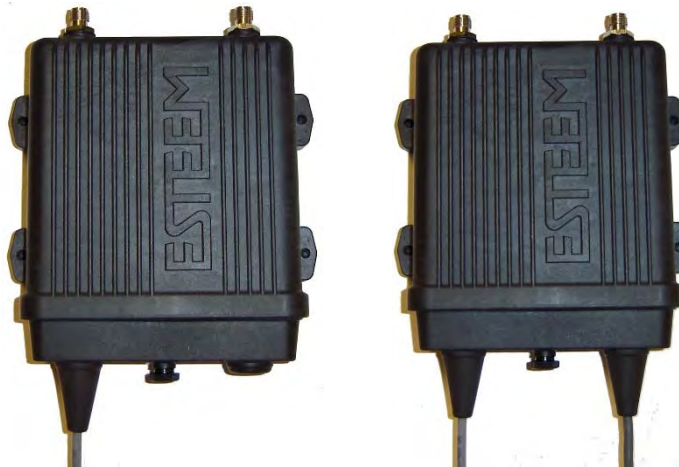

Figure 12: Face Plate Cover Installed on ESTeem

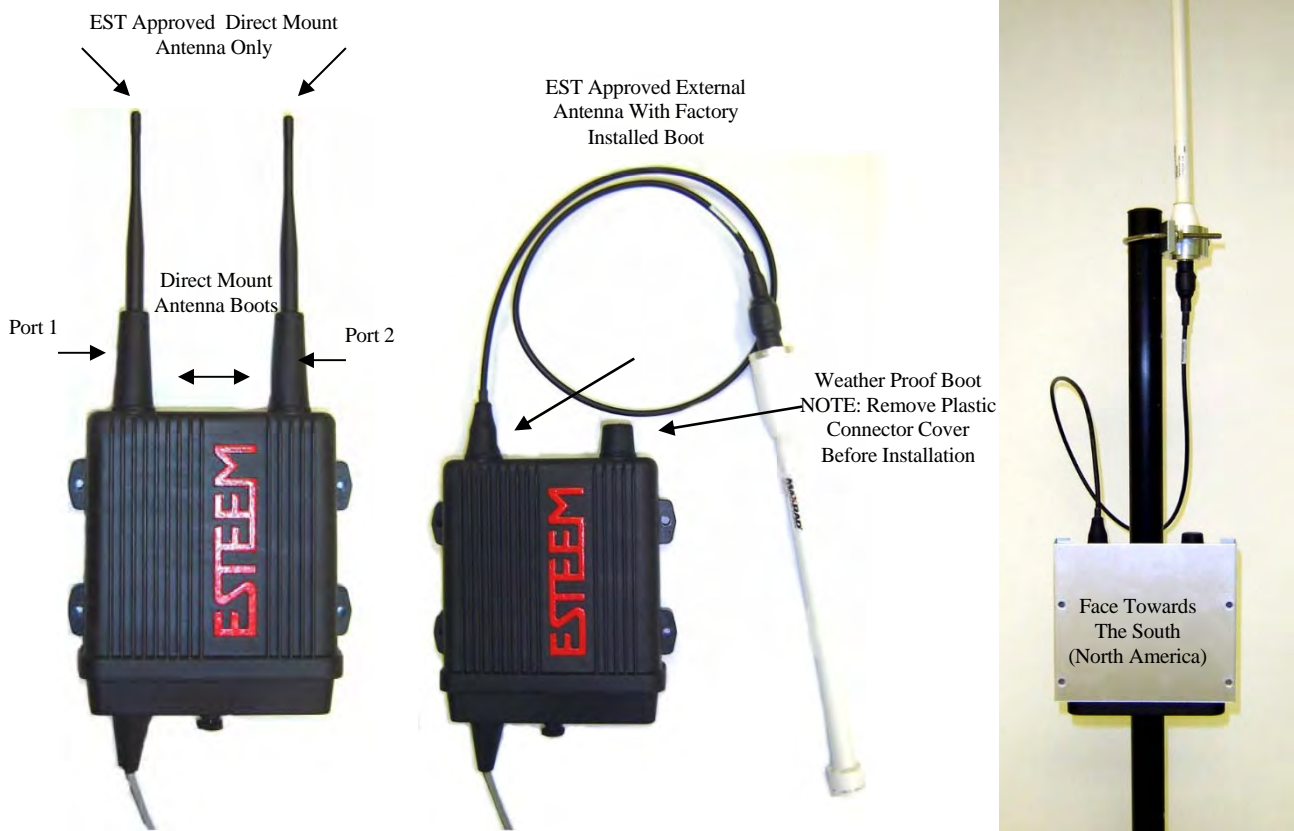

Figure 13: Completed AA195PM Mounts

Caution: Outdoor mounting of the Horizon requires the use of weatherproof boots. Improper installation could result in radio failure.

Caution: Always mount the Horizon vertically with the antenna ports on top.

Horizon Pole Mount Grounding Procedures

Mounting the Horizon series radio modem outdoors requires proper grounding procedures to prevent damage to both the radio hardware and the connected Ethernet and Serial peripherals. The case on the Horizon series wireless modem is electrically conductive, but the AA195 Pole Mount kit provides isolation from the connected structure. To bring the Horizon case to a ground potential with Earth ground and eliminate any static buildup on the case itself, the shield on the Ethernet cable is used to provide the ground connection.

Outdoor Ethernet Cable

A critical component of this grounding protection system is the ESTeem AA09.1 outdoor, shielded CAT-5E Ethernet cable. This cable provides three, necessary elements; Ethernet data, DC Power over Ethernet (PoE) applications, and a ground from the Horizon case to the AA166 surge protector. The Ethernet cable is outdoor rated and protected from UV breakdown.

Installation

The following diagram outlines all the critical components and connections in the Horizon series system. The Earth ground connection to the surge protector must be installed to comply with local Electrical code requirements.

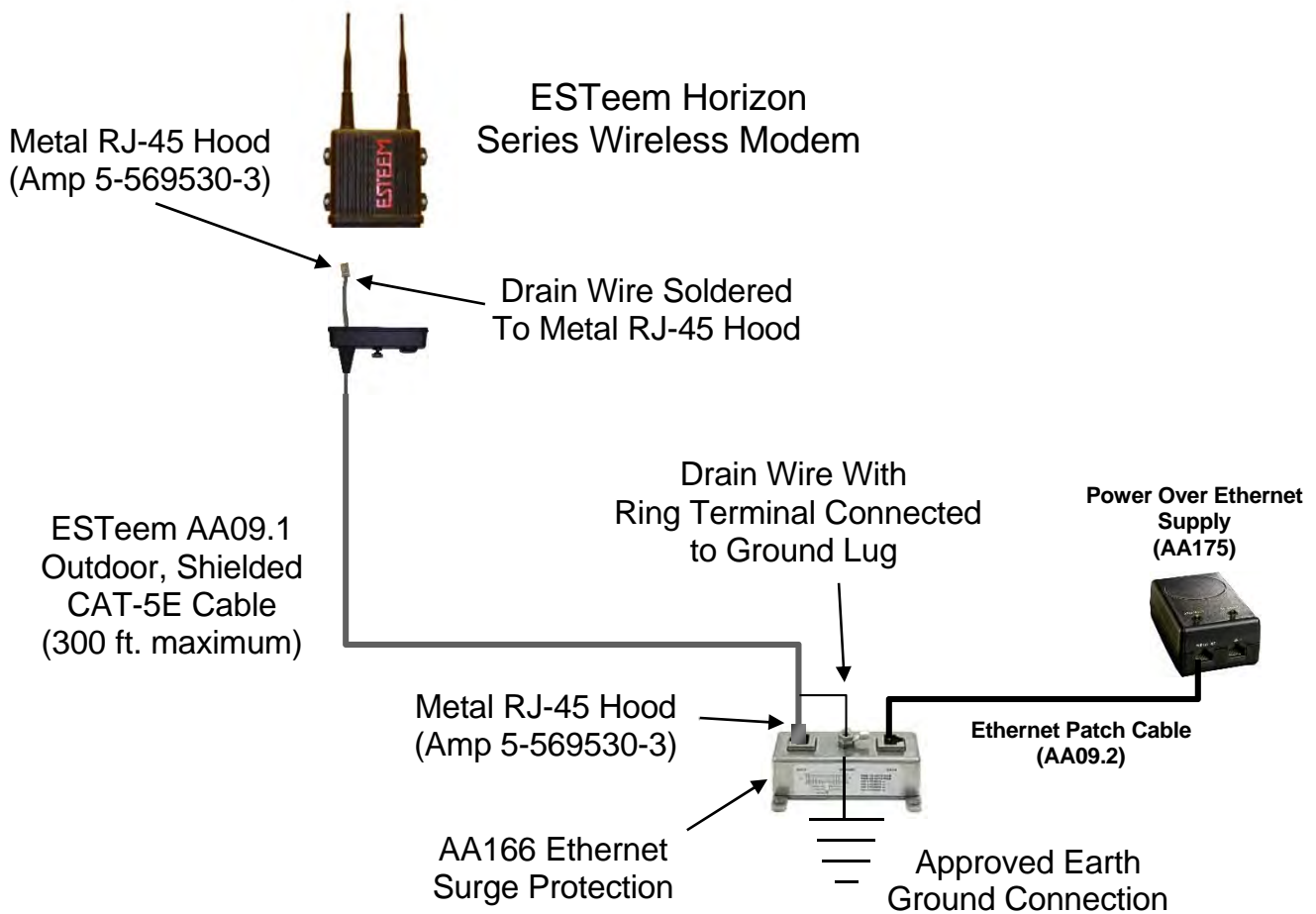

Figure 14: Pole Mount Installation Diagram

Fresnel Zone

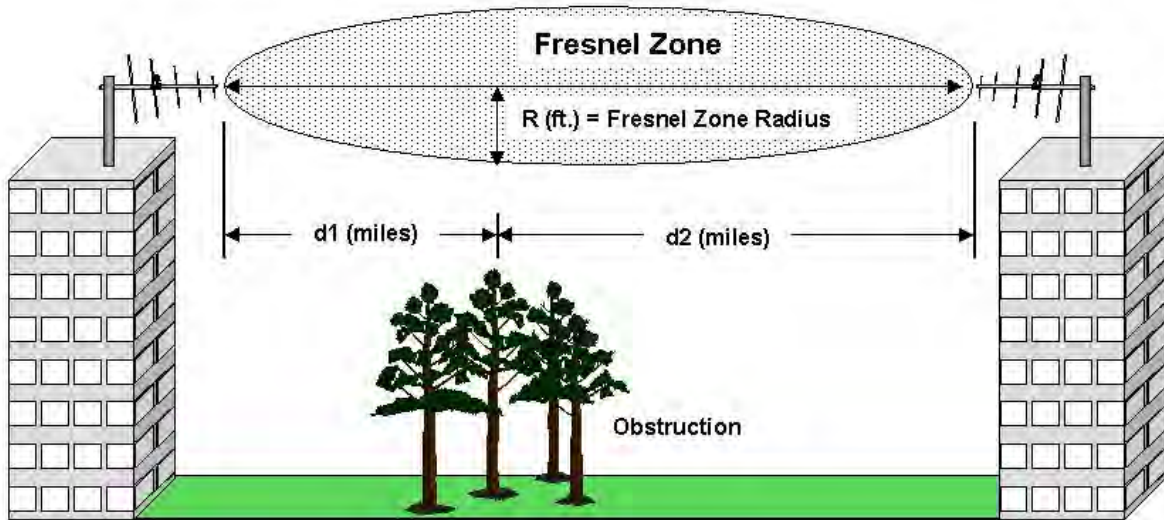

Figure 15: Fresnel Zone Diagram

The Fresnel zone shows the ellipsoid spread of the radio waves around the visual line-of-sight after they leave the antenna (see Figure 15). This area must be clear of obstructions or the signal strength will be reduced due to signal blockage. Typically, 20% Fresnel Zone blockage introduces little signal loss to the link. Beyond 40% blockage, signal loss will become significant. This calculation is based on a *flat earth*. It does not take into account the curvature of the earth. It is recommended for RF path links greater than 7 miles to have a microwave path analysis done that takes the curvature of the earth and the topography of the terrain into account.

$$\text{Fresnel Zone Radius} = 72.1 \text{ SQRT } [(d_1 d_2) / (F (d_1 + d_2))]$$

Units

Fresnel Zone Radius in feet.

d1 and d2 in statute miles

F in GHz

Information to Users

FCC Statement

The ESTeem Horizon complies with Part 15 of the FCC Rules. Operation is subject to the following two conditions: (1) This device may not cause harmful interference, and (2) this device must accept any interference received, including interference that may cause undesired operation.

Caution: Changes or modifications to this equipment not expressly approved by ESTeem Wireless Modems for compliance could void the user's authority to operate the equipment.

IC Statement

"This device complies with Industry Canada licence-exempt RSS standard(s). Operation is subject to the following two conditions: (1) this device may not cause interference, and (2) this device must accept any interference, including interference that may cause undesired operation of the device."

"Cet appareil est conforme avec Industrie Canada exempts de licence standard RSS (s). Son fonctionnement est soumis aux deux conditions suivantes: (1) cet appareil ne doit pas provoquer d'interférences et (2) cet appareil doit accepter toute interférence, y compris celles pouvant causer un mauvais fonctionnement de l'appareil."

Emissions Information

Horizon 2.4 GHz (Model 216An)

HVIN: 216AN

Direct Sequence/OFDM Spread Spectrum Device

(USA) FCC ID: **ENPHZN216AN**

(Canada) IC No: **2163A-216AN**

Horizon 900 MHz (Model 216Ad)

HVIN: 216AD

Direct Sequence/OFDM Spread Spectrum Device

(USA) FCC ID: **ENPHZN216AD**

(Canada) IC No: **2163A-216AD**

The equipment has been tested and found to comply with the limits for a Class B digital device, pursuant to Part 15 of the FCC Rules. These limits are designed to provide reasonable protection against harmful interference when the equipment is operated in a commercial environment. This equipment generates, uses, and can radiate radio frequency energy and, if not installed and used in accordance with the instruction manual, may cause harmful interference to radio communications. Operation of this equipment in a residential area is likely to cause harmful interference in which case the user will be required to correct the interference at his own expense.

FEDERAL COMMUNICATIONS COMMISSION FIELD OFFICES

ALASKA

1011 E. Tudor Rd.
Rm 240 Box 2955
Anchorage, AK 99510

CALIFORNIA

Interstate Office Park
4542 Ruffner St., Room 370
San Diego, CA 92111-2216

Los Angeles Office (LA)

Ceritos Corporate Tower
18000 Studebaker Rd., Room 660
Cerritos, CA 90701-3684

San Francisco Office (SF)

5653 Stoneridge Drive, Suite 105
Pleasanton, CA 94588-8543

COLORADO

Denver Office (DV)
215 S. Wadsworth Blvd., Suite 303
Lakewood, CO 80226-1544

FLORIDA

919 Federal Bldg
51 SE First Ave.
Miami, FL 33130

Tampa Office (TP)

2203 N. Lois Ave., Room 1215
Tampa, FL 33607-2356

GEORGIA

Atlanta Office (AT)
3575 Koger Blvd., Suite 320
Duluth, GA 30096-4958

HAWAII

7304 Prince Kuhi
Federal Building
Honolulu, HI

ILLINOIS

Chicago Office (CG)
Park Ridge Office Ctr., Room 306
1550 Northwest Highway
Park Ridge, IL 60068-1460

LOUISIANA

New Orleans Office (OR)
2424 Edenborn Ave. Suite 460
Metairie, LA 70001

MARYLAND

1017 Geo. Fallon
Building 31
Hopkins Plaza
Baltimore, MD

MASSACHUSETTS

Boston Office (BS)
1 Batterymarch Park
Quincy, MA 02169-7495

MICHIGAN

Detroit Office (DT)
24897 Hathaway Street
Farmington Hills, MI 48335-1552

MINNESOTA

691 Federal Building
316 N Robert St.
St. Paul, MN

MISSOURI

Kansas City Office (KC)
520 NE Colbern Road
Second Floor
Lee's Summit, MO 64086

NEW YORK

1307 Federal Building
111 W. Huron
Buffalo, NY 14202

NEW YORK

New York Office (NY)
201 Varick Street, Suite 1151
New York, NY 10014-4870

OREGON

1782 Federal Building
1220 SW 3rd Avenue
Portland, OR 97204

PENNSYLVANIA

Philadelphia Office (PA)
One Oxford Valley Office Bld.
Room 404
2300 E. Lincoln Hwy
Langhorne, PA 19047-1859

PUERTO RICO

747 Federal Building
Carlo Chardon Ave.
Hato Rey, PR 00918

TEXAS

Dallas Office (DL)
9330 LBJ Freeway, Room 1170
Dallas, TX 75243-3429

5636 Federal Building

515 Rusk Avenue
Houston, TX 77002

WASHINGTON DC

Columbia Office (CF)
9300 East Hampton Drive
Capitol Heights, MD 20743







WASHINGTON

Seattle Office (ST)
11410 NE 122nd Way
Room 312
Kirkland, WA 98034-6927

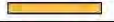
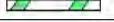
ETHERNET INTERFACE

The ESTEem Horizon's Ethernet Port is a Full and Half-Duplex Auto-negotiation interface supporting 10Mbps, 100Mbps and 1Gbps (10/100/1000BaseT). The Ethernet port is compliant with IEEE 802.3at-2009 Power Over Ethernet Plus (PoE+) to provide both data and power over the same CAT-5E grade Ethernet cable. The port is compatible with TIA/EIA-568B cable configuration (Figure 1).

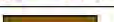

RJ45 Pin No.	Wire Color	Wire Diagram	10Base-T Signal 100Base-TX Signal
1	White/Orange		Transmit +
2	Orange		Transmit -
3	White/Green		Receive +
4	Blue		Unused
5	White/Blue		Unused
6	Green		Receive -
7	White/Brown		Unused
8	Brown		Unused





RJ45 Pin No.	Wire Color	Wire Diagram	10Base-T Signal 100Base-TX Signal
1	White/Orange		Transmit +
2	Orange		Transmit -
3	White/Green		Receive +
4	Blue		+ Power
5	White/Blue		+ Power
6	Green		Receive -
7	White/Brown		- Power
8	Brown		- Power

Figure 1: Ethernet Pin Layout

A second Ethernet port is included with the ESTEem Horizon. This second Ethernet port can be configured to bridge to the primary Ethernet port or configured to communicate on the Wireless or Ethernet side of the Horizon in router mode.

CONFIGURING DHCP SERVER

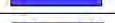
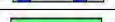
The ESTeem Horizon Ethernet port supports both client and server Dynamic Host Configuration Protocol (DHCP). Figure 2 shows the DHCP host configuration screen that will be shown if DHCP server is selected in the setup screens. Enter the values that match the DHCP configuration for your network.

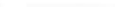
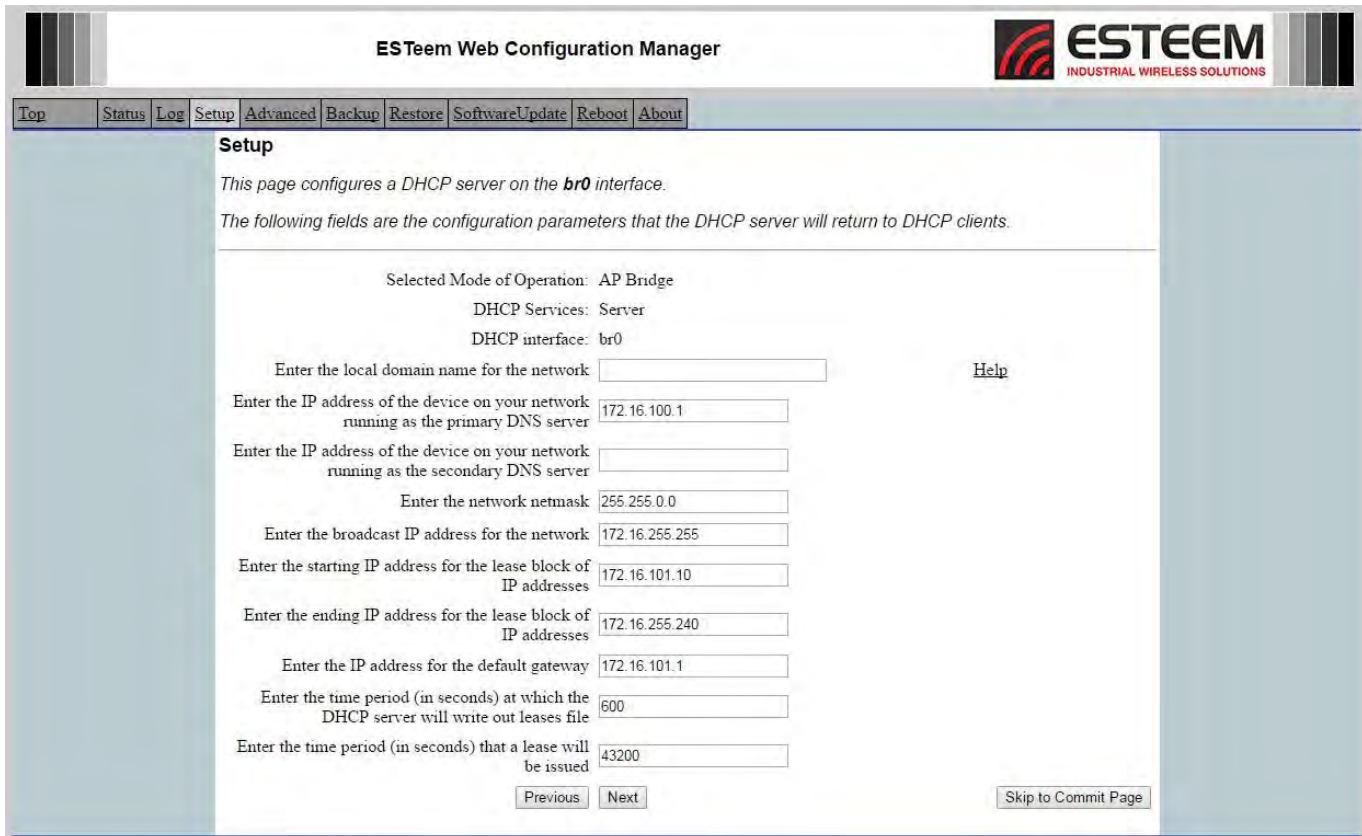

The screenshot shows the 'ESTeem Web Configuration Manager' interface. At the top, there is a navigation menu with options: Top, Status, Log, Setup, Advanced, Backup, Restore, SoftwareUpdate, Reboot, and About. The 'Setup' tab is selected. The main content area is titled 'Setup' and contains the following text: 'This page configures a DHCP server on the br0 interface.' and 'The following fields are the configuration parameters that the DHCP server will return to DHCP clients.' Below this, the configuration parameters are listed with input fields: Selected Mode of Operation: AP Bridge; DHCP Services: Server; DHCP interface: br0; Enter the local domain name for the network (empty field); Enter the IP address of the device on your network running as the primary DNS server (172.16.100.1); Enter the IP address of the device on your network running as the secondary DNS server (empty field); Enter the network netmask (255.255.0.0); Enter the broadcast IP address for the network (172.16.255.255); Enter the starting IP address for the lease block of IP addresses (172.16.101.10); Enter the ending IP address for the lease block of IP addresses (172.16.255.240); Enter the IP address for the default gateway (172.16.101.1); Enter the time period (in seconds) at which the DHCP server will write out leases file (600); Enter the time period (in seconds) that a lease will be issued (43200). At the bottom, there are 'Previous', 'Next', and 'Skip to Commit Page' buttons.

Figure 2: DHCP Server Configuration

RS-232C Programming Port Configuration

The ESTeem Horizon uses a proprietary RS-232C interface in a RJ-45 connector on the front panel. To interface the Horizon to the serial port on the computer, you need ESTeem cable AA0621 that combines a standard Ethernet patch cable to a 9-pin Female adapter.

The RS-232 Programming Port on the ESTeem Horizon can be used to access the configuration menu in the ESTeem for system and network configuration. The ESTeem communications port operates at 38,400 bps, No Parity, 8 Data Bits and 1 Stop Bit (38,400,N,8,1). Configure your terminal program to match these settings.



RS-232 Programming Port Pin-Out Table

ESTeem Model AA0621
 RS-232C Port Pin-Out Table

RJ-45 Pin No.	Function	DB-9 Pin No.
4	Signal Ground (GND)	5
5	Receive Data (RxD)	2
6	Transmit Data (TxD)	3

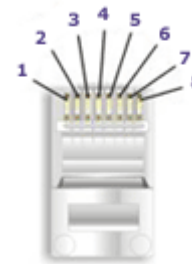

Ethernet Pin-out

RS-232C Data Port Configuration

The ESTeem Horizon has an RS-232C data interface in a RJ-45 connector on the front panel. See Chapter 6 for further information on serial data port configuration. To interface the Horizon to the serial port on the computer, you need serial cable with the following pin-out:

ESTeem Model AA0621
 RS-232C Port Pin-Out Table

RJ-45 Pin No.	Function	DB-9 Pin No.
1	Data Set Ready (DSR)	6
2	Data Carrier Detect (DCD)	1
3	Data Terminal Ready (DTR)	4
4	Signal Ground (GND)	5
5	Receive Data (RxD)	2
6	Transmit Data (TxD)	3
7	Clear to Sent (CTS)	8
8	Request to Sent (RTS)	7

Horizon Frequencies of Operation

In a wireless Ethernet network all of the ESTeem Horizon must be set to the same radio frequency of operation (channel) and bandwidth. The following table shows the channels and corresponding frequencies of operation for each model of ESTeem. The frequency of operation is selectable when configuring the mode of operation of the Horizon (reference Chapter 3).

Technical Tip: The shaded frequency channels are available for 802.11 (Wi-Fi) client use. All other non-shaded channels are proprietary.

Channel Number	Frequency	Bandwidths
Horizon 900 MHz		
4	907 MHz	5/10 MHz
5	912 MHz	5/10/20 MHz
6	917 MHz	5/10/20 MHz
7	922 MHz	5/10 MHz

Channel Number	Frequency	Bandwidths
Horizon 2.4 GHz		
1	2412 MHz	5/10/20/40 MHz
2	2417 MHz	5/10/20/40 MHz
3	2422 MHz	5/10/20/40 MHz
4	2427 MHz	5/10/20/40 MHz
5	2432 MHz	5/10/20/40 MHz
6	2437 MHz	5/10/20/40 MHz
7	2442 MHz	5/10/20/40 MHz
8	2447 MHz	5/10/20/40 MHz
9	2452 MHz	5/10/20/40 MHz
10	2457 MHz	5/10/20/40 MHz
11	2462 MHz	5/10/20/40 MHz

Figure 1: Radio Frequency Channel Selection

RF Data Rate Configuration

The RF data rate of the Horizon can be programmed for operation at multiple data rates. The RF data rate can be set for a fixed rate or a specific range that is dynamically scaled by the Horizon from monitoring the received signal quality. Dynamic scaling means that the Horizon will operate at the highest RF data rate that is programmed into unit. If the received data quality drops below the required minimums for reliable communications, the Horizon will reduce the data rate to the next lowest step to increase signal quality. Conversely if the signal quality increases above the minimums the Horizon will increase the RF data rate the next highest level.

The ESTeem Horizon is set at the factory to operate at maximized scaling speed data rates and should not need adjustment. The RF Data Rate is programmed in the Horizon through the **Advanced Menu>Wireless LAN Settings>wlan0 device** and the value for **Communication Rates and 802.11n Communication Rate Index**. In the example shown in Figure 2 the RF Date Rate is programmed to dynamic scale all data rates (recommend factory default setting). To set the values for the data rate, check the box next to the listed data rate to enable this rate for operation.

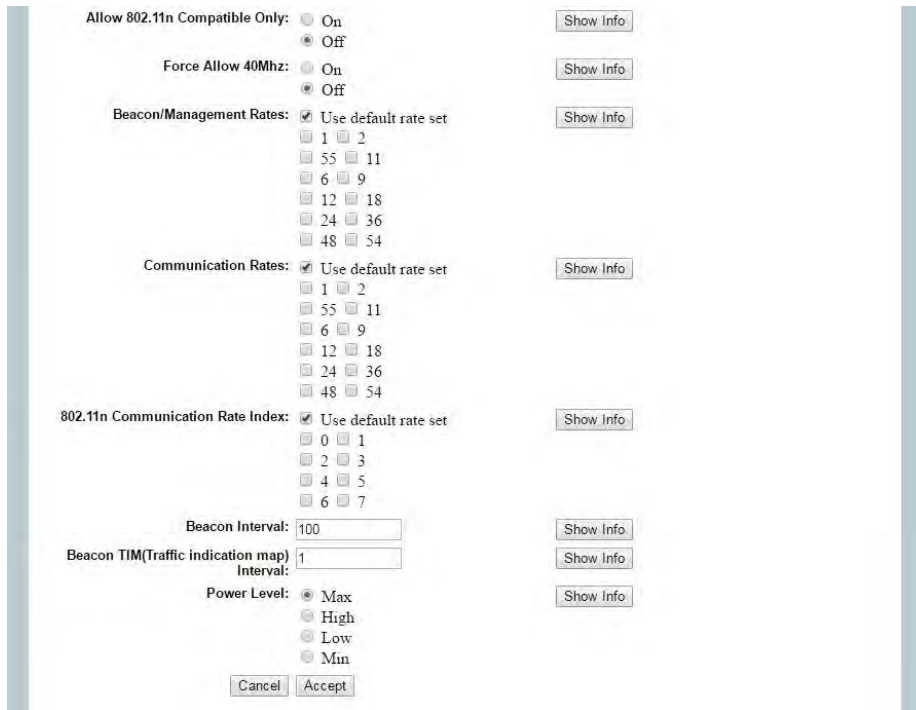

Allow 802.11n Compatible Only: On Off Show Info
 Force Allow 40Mhz: On Off Show Info
 Beacon/Management Rates: Use default rate set Show Info
 1 2
 55 11
 6 9
 12 18
 24 36
 48 54
 Communication Rates: Use default rate set Show Info
 1 2
 55 11
 6 9
 12 18
 24 36
 48 54
 802.11n Communication Rate Index: Use default rate set Show Info
 0 1
 2 3
 4 5
 6 7
 Beacon Interval: Show Info
 Beacon TIM(Traffic indication map) Interval: Show Info
 Power Level: Max High Low Min Show Info

Figure 2: Advanced Data Rate Selection

RF Bandwidths

The Horizon radios have adjustable RF bandwidths for operation. Reducing the RF bandwidth increases the number of available channels and the radio's ability to reject RF interference. Different models of the Horizon series will have different available bandwidths depending upon the frequency of operation. For example, Figure 3 shows the configuration of the Horizon 2.4 GHz's available bandwidths.

NOTE: All ESTeem radios in the same network MUST be on the same frequency channel and use the same bandwidth selection.

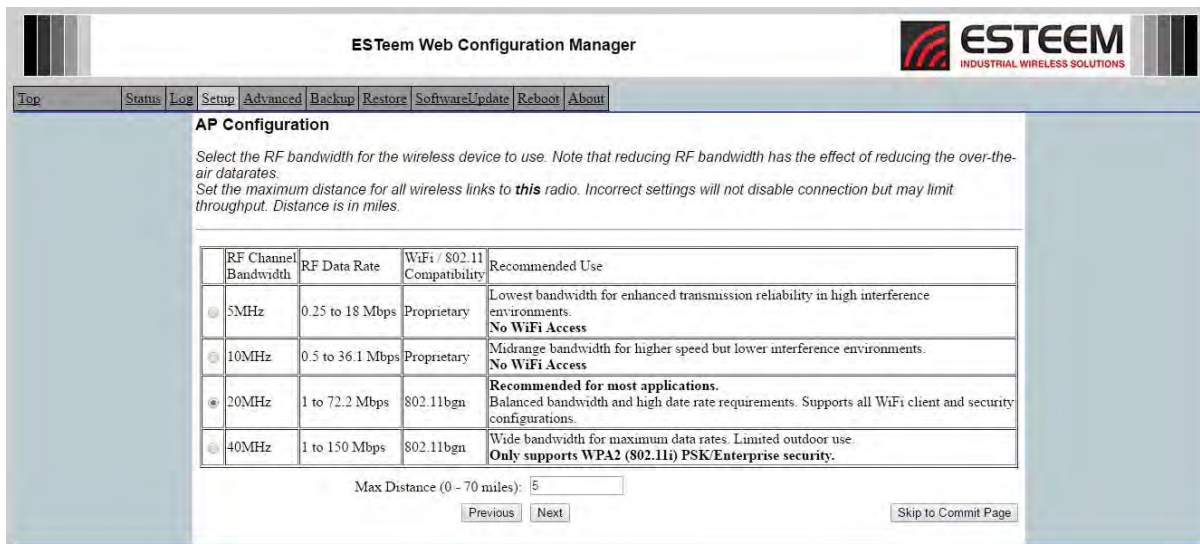

ESTeem Web Configuration Manager

[Top](#) [Status](#) [Log](#) [Setup](#) [Advanced](#) [Backup](#) [Restore](#) [Software Update](#) [Reboot](#) [About](#)

AP Configuration

Select the RF bandwidth for the wireless device to use. Note that reducing RF bandwidth has the effect of reducing the over-the-air data rates.
Set the maximum distance for all wireless links to this radio. Incorrect settings will not disable connection but may limit throughput. Distance is in miles.

RF Channel Bandwidth	RF Data Rate	WiFi / 802.11 Compatibility	Recommended Use
<input type="radio"/> 5MHz	0.25 to 18 Mbps	Proprietary	Lowest bandwidth for enhanced transmission reliability in high interference environments. No WiFi Access
<input type="radio"/> 10MHz	0.5 to 36.1 Mbps	Proprietary	Midrange bandwidth for higher speed but lower interference environments. No WiFi Access
<input checked="" type="radio"/> 20MHz	1 to 72.2 Mbps	802.11bgn	Recommended for most applications. Balanced bandwidth and high data rate requirements. Supports all WiFi client and security configurations.
<input type="radio"/> 40MHz	1 to 150 Mbps	802.11bgn	Wide bandwidth for maximum data rates. Limited outdoor use. Only supports WPA2 (802.11i) PSK/Enterprise security.

Max Distance (0 - 70 miles):

Figure 3: Horizon 2.4 GHz Bandwidth Selection

Data Rates and Throughput

The Horizon series radios are designed to dynamically change their data rate, modulation and guard index (GI) based upon their current receive signal strength and background noise. It is highly recommended to allow the Horizon to dynamically scale to the best data rate given the operation conditions. Dynamic scaling means that the Horizon will operate at the highest RF data rate that is programmed into unit. The following tables show the interactions of data rate, channel bandwidth (CW) and guard interval (GI):

Legacy Rates	DSSS or OFDM	Modulation	Coding	Data Rate	Throughput	Data Rate	Throughput	Data Rate	Throughput		
				5MHz	5MHz	10MHz	10MHz	20MHz	20MHz		
1	DSSS	BPSK	1/11	0.25	0.01	0.5	0.03	1	0.60		
2	DSSS	QPSK	1/11	0.5	0.03	1	0.06	2	0.11		
5.5	DSSS	CCK	4/8	1.375	0.43	2.75	0.86	5.5	1.72		
11	DSSS	CCK	4/8	2.75	0.86	5.5	1.72	11	3.44		
6	OFDM	BPSK	1/2	1.5	0.47	3	0.09	6	1.88		
9	OFDM	BPSK	3/4	2.25	1.05	4.5	2.11	9	4.22		
12	OFDM	QPSK	1/2	3	0.94	6	1.88	12	3.75		
18	OFDM	QPSK	3/4	4.5	2.11	9	4.22	18	8.44		
24	OFDM	16-QAM	1/2	6	1.88	12	3.75	24	7.50		
36	OFDM	16-QAM	3/4	9	4.22	18	8.44	36	16.88		
48	OFDM	64-QAM	2/3	12	5.00	24	10.00	48	20.00		
54	OFDM	64-QAM	3/4	13.5	6.33	27	12.66	54	25.31		

802.11n Index	Spatial Streams	Modulation	Coding	Data Rate	Throughput	Data Rate	Throughput	Data Rate	Throughput	Data Rate	Throughput	
				GI = -->	800ns	800ns	400ns	400ns	800ns	800ns	400ns	400ns
				CW = -->	5MHz	5MHz	5MHz	5MHz	10MHz	10MHz	10MHz	10MHz
0	1	BPSK	1/2	1.625	0.56	1.8	0.62	3.25	1.12	3.6	1.24	
1	1	QPSK	1/2	3.25	1.12	3.6	1.24	6.5	2.23	7.2	2.48	
2	1	QPSK	3/4	4.875	2.51	5.425	2.8	9.75	5.03	10.85	5.59	
3	1	16-QAM	1/2	6.5	2.23	7.225	2.48	13	4.47	14.45	4.97	
4	1	16-QAM	3/4	9.75	5.03	10.825	5.58	19.5	10.05	21.65	11.16	
5	1	64-QAM	2/3	13	5.96	14.45	6.62	26	11.92	28.9	13.25	
6	1	64-QAM	3/4	14.625	7.54	16.25	8.38	29.25	15.08	32.5	16.76	
7	1	64-QAM	5/6	16.25	9.31	18.05	10.34	32.5	18.62	36.1	20.68	
				CW = -->	20MHz	20MHz	20MHz	20MHz	40MHz	40MHz	40MHz	
0	1	BPSK	1/2	6.5	2.23	7.2	2.48	13.5	4.64	15	5.16	
1	1	QPSK	1/2	13	10.05	14.4	4.95	27	9.28	30	10.31	
2	1	QPSK	3/4	19.5	10.05	21.7	11.19	40.5	20.88	45	23.20	
3	1	16-QAM	1/2	26	8.94	28.9	9.93	54	18.56	60	20.63	
4	1	16-QAM	3/4	39	20.11	43.3	22.33	81	41.77	90	46.41	
5	1	64-QAM	2/3	52	23.83	57.8	26.49	108	49.5	120	55.00	
6	1	64-QAM	3/4	58.5	30.16	65	33.52	121.5	62.65	135	69.61	
7	1	64-QAM	5/6	65	37.24	72.2	41.36	135	77.34	150	85.94	

Table 1: Data Rates and Throughput

SETTING RF POWER LEVEL

The ESTeem Horizon peak power is adjustable in output power from the advanced configuration menu. The output power is adjusted on the **Advanced Menu>Wireless LAN Settings>wlan0 device** screen (Figure 4) of the Web Configuration Manager. Select the value and press the *Save Settings* button.

Max (Maximum)	Full Power
Hi (High)	75% Power
Lo (Low)	50% Power
Min (Minimum)	25% Power

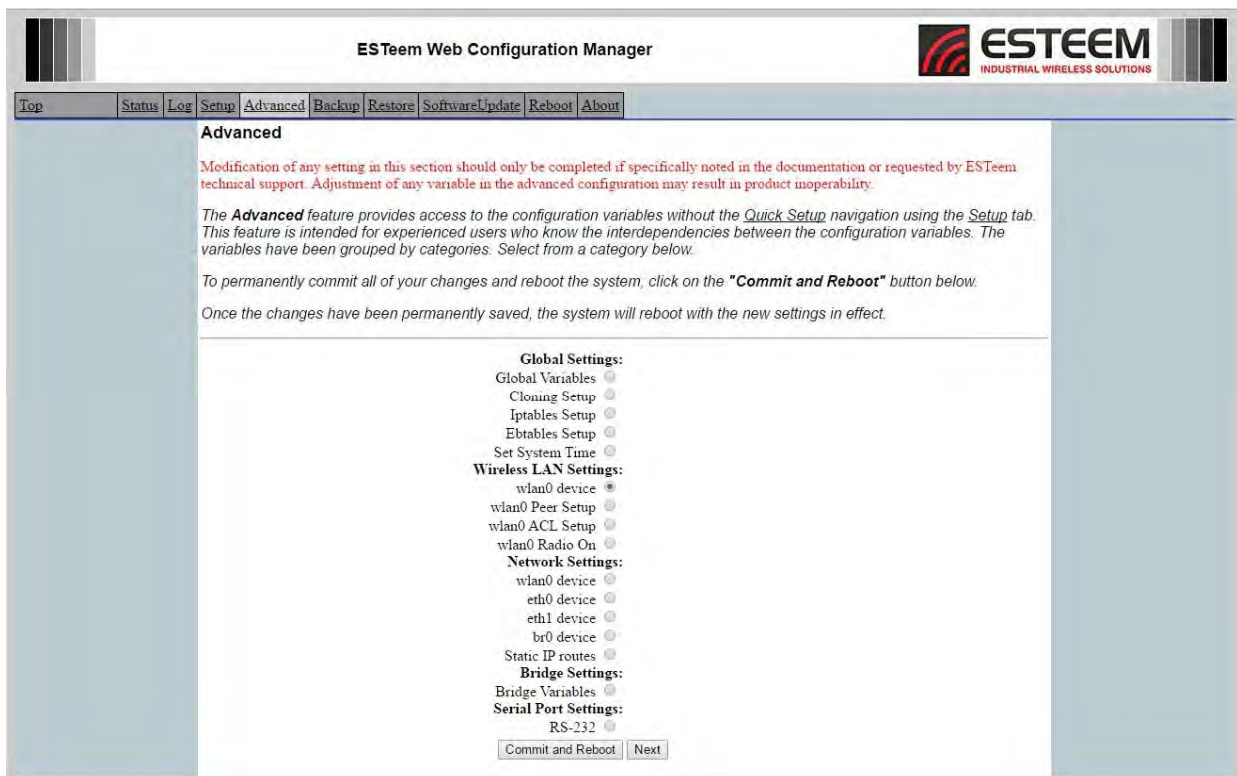

Figure 4: Advanced Global Variables



Figure 5: Power Level Settings

OVERVIEW

The security for the ESTeem Horizon, like all network security, must be multi-layered. One level of security is never enough to make sure that data does not end up in the wrong hands. Please review the following security levels and decide what is the most appropriate for your network.

AES-CCMP (802.11i and WPA-2)

AES-CCMP (Advanced Encryption Standard-Counter Mode CBC-MAC Protocol) is the encryption algorithm used in the IEEE 802.11i and WPA-2 security protocols. This national encryption standard uses a 128 bit-AES block cipher and CCMP technique to ensure the highest level of security and integrity available on a wireless network. AES-CCMP incorporates two sophisticated cryptographic techniques (counter mode and CBC-MAC) and adapts them to Ethernet frames to provide a robust security protocol between the mobile client and the access point. AES itself is a very strong cipher, but counter mode makes it difficult for an eavesdropper to spot patterns, and the CBC-MAC message integrity method ensures that messages have not been tampered with. The ESTeem Horizon is compatible as either an Access Point or client in either WPA2 or IEEE 802.11i security systems.

Wi-Fi Protected Access 2 with Preshared Key (WPA2 PSK)

WPA2 PSK uses a common passphrase (preshared key) between the Access Point (AP) and the client to begin a secure communication session. This passphrase must be entered exactly the same in both the Access Point and the client. This passphrase is used to authenticate communication session between the AP and client to begin the secure wireless networking session.

Wi-Fi Protected Access 2 with Enterprise Server (WPA Enterprise)

Like WPA2 PSK, WPA2 Enterprise verifies the authenticity of the Access Point and client, but uses an 802.1x backend authentication server handling the authentication decision. The most commonly type of authentication server is a RADIUS server. The ESTeem Horizon can be configured to operate with an established RADIUS server on the network.

WPA

Wi-Fi Protected Access with Preshared Key (WPA PSK)

WPA, which uses 802.1x, was introduced in 2003 to improve on the authentication and encryption features of WEP. All authentication is handled within this access point device. WPA has two significant advantages over WEP:

1. An encryption key differing in every packet. The TKIP (Temporal Key Integrity Protocol) mechanism shares a starting key between devices. Each device then changes their encryption key for every packet. It is extremely difficult for hackers to read messages even if they have intercepted the data.
2. Certificate Authentication (CA) can be used, blocking a hacker posing as a valid user.

Wi-Fi Protected Access with Enterprise Server (WPA Enterprise)

Like WPA PSK, WPA Enterprise verifies the authenticity of the Access Point and client, but uses an 802.1x backend authentication server handling the authentication decision. The most commonly type of authentication server is a RADIUS server. The ESTeem Horizon can be configured to operate with an established RADIUS server on the network.

WPA is server/client relationship from a software driver on a computer's wireless LAN (WLAN) card to an Access Point. The scope of WPA is limited in use to this configuration only. The ESTeem Horizon can support WPA Enterprise and PSK as an Access Point, but the level of security on the Bridging layer is configured separately.

128-BIT WEP

The 128 WEP uses a particular algorithm called RC4 encryption to encode and decode traffic that is based on a 104-bit encryption key and a 24-bit Initialization Vector (IV). RC4 starts with a relatively short encryption key (104 bits) that is expanded into a nearly infinite stream of keys to accompany the stream of packets.

The basic concept of RC4 is good, but the way it's implemented in WEP leaves it open to compromise. The researchers that test the integrity of the system usually focus on one piece of the implementation, the Initialization Vector (IV).

The IV (24 bits) is the algorithm component that's supposed to keep expanded keys from repeating. From the researcher's point of view, a high-volume access point is mathematically guaranteed to reuse the same key stream at least once a day. When this happens, it's called an IV collision this becomes a soft spot to enter the system.

The researchers aren't saying that it's easy to break into the system, or that it's being done on a regular basis, only that it is possible and administrators should consider ways to reduce the possibility

Access Control List (ACL)

The ACL is one of the simplest yet most secure methods of network security. The ACL is a configurable MAC filter in the Model 192E that can be set to allow specific MAC address on the wireless network by individual address or address ranges. The same filter can also be set to reject individual MAC addresses or address ranges.

The MAC address is a unique, 6 hexadecimal field address assigned at the manufacturer that can not be changed. The MAC address is traceable through the IEEE governing body to the manufacturer and is the "fingerprint" for all Ethernet devices.

Using a combination of both the WPA or 128-Bit WEP encryption and the ACL filter provide the ESTeem an extremely secure wireless networking layer.

Disabling Broadcast Probes and Hiding SSID

A simple but very effective way of securing a network is to make the network difficult to find. By disabling broadcast probes and hiding the Service Set Identification (SSID), wireless and network "sniffers" will not be able to find your ESTeem Horizon network. To gain access to the wireless network, you would be required to have the SSID and all security loaded in the WLAN card software prior to entering the network.

Proprietary Bridge Communication

Although the ESTeem Horizon is compatible with the open communication standards IEEE 802.11g and 802.11b, the repeater communication between the units is a proprietary communication link. No other manufacturer of wireless hardware can access the ESTeem repeater network when bridging between Ethernet networks. This proprietary communication layer, in combination with the other security settings, allows you as the user to reject wireless clients into the network if so desired. When used in conjunction with the Access Control List the 802.11g and 802.11b client access can be removed.

The security level of the bridge communication link is configurable for 64-Bit WEP, 128-Bit WEP or TKIP and is completely independent of the client access level or any other communication link level. For example, an ESTeem Horizon can be configured for WPA Enterprise for client level access, communicate to another ESTeem Horizon using a TKIP bridge link and also communicate 128-Bit WEP to our older ESTeem Model 192E radio modems all running simultaneously.

Masquerade Modes

When the ESTeem Horizon is configured in either the Access Point Masquerade or the Client Masquerade modes, the wireless modem functions as a network firewall. If access to the wired network is the greatest concern, place the ESTeem in the Masquerade mode and the wireless network will be completely isolated from the wired Ethernet network.

Increasing Network Security

The following are a few suggestions to help improve the overall security of your wireless network:

1. Enable the security. If you research all of the articles regarding hackers, they have gotten into the user's network due to the security not being enabled.
2. Set the ACL filter to include only those MAC address of the wireless Ethernet device being used on the network.
3. Make sure the keys are not reused in your company, since reuse increases the statistical likelihood that someone can figure the key out and change the default password on your access point or wireless router
4. As a network administrator, you should periodically survey your company using a tool like NetStumbler to see if any "rogue" access points pop up within your company without authorization. All of your hard work to "harden" your wireless network could be wasted if a rogue AP was plugged into your network behind the firewall.
5. Many access points allow you to control access based on the MAC address of the NIC attempting to associate with it. If the MAC address of your NIC isn't in the table of the access point, you won't associate with it. And while it's true that there are ways of spoofing a MAC address that's been sniffed out of the air, it takes an additional level of sophistication to spoof a MAC address. The downside of deploying MAC address tables is that if you have a lot of access points, maintaining the tables in each access point could be time consuming. Some higher-end, enterprise-level access points have mechanisms for updating these tables across multiple access points of the same brand.
6. Consider using an additional level of authentication, such as Remote Access Dialin User Service (RADIUS), before you permit an association with your access points through WPA and WPA2 Enterprise.
7. If you're deploying a wireless router, think about assigning static IP addresses for your wireless NICs and turn off Dynamic Host Configuration Protocol (DHCP). If you're using a wireless router and have decided to turn off DHCP, also consider changing the IP subnet. Many wireless routers default to the 192.168.1.0 network and use 192.168.1.1 as the default router.
8. Only purchase Access Points that have flashable firmware. There are a number of security enhancements that are being developed, and you want to be sure that you can upgrade your access point.
9. A simple security technique used by the military is to have the administrator periodically change the key for the system i.e. weekly, monthly, etc.

Testing Communication Link

After you have configured at least two of the Horizon wireless Ethernet modems for operation, you can verify communication with each the following steps:

Status Light

The quickest source of link status is to view the Status LED on the face of the Horizon (Figure 1). If the Status light is solid, the Horizon has a connection to another Horizon listed in the Peer Table.

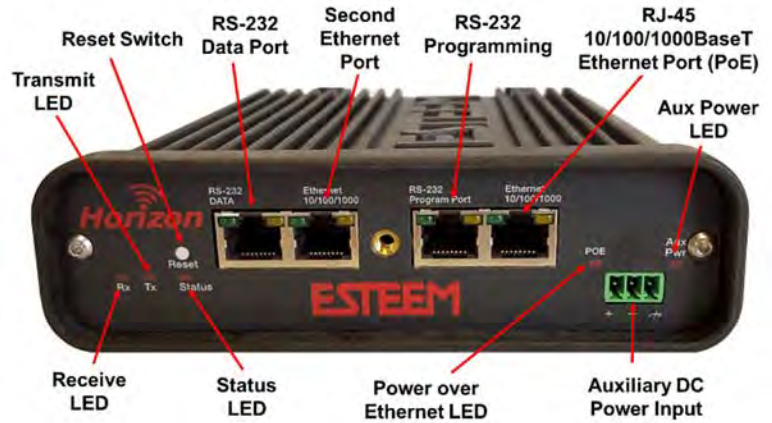

Figure 1: Connection Status Light

Status Screen/Peer Table

To view detailed information on the status of the communication link (such as connection speed, signal strength and last update time) you can open the Status Screen from the Web Interface. After press the Status tab at the top of the screen the Status: Summary will be displayed showing the status of all ports and memory in the Horizon. Under the Wireless Status heading click on the [View Peer Table](#) (Figure 2).

Peers - The Peer Table will display all connected Horizons configured as a Peer link to this ESTEem by their Wireless (WLAN) MAC address.

Received Signal Strength – The AntSignal column will display the receive signal strength for each of the two antenna ports. The first antenna port is listed as A1 while the second (receive only) port is listed as A2. You may receive a signal level on A2 although no antenna is attached. This signal strength value is listed in dBm.

Last RX and Data Rate – This is the time of the last received data packet. When



Figure 2: Peer Status

monitoring the status menu, it is important to note the time the last transmission was updated so you are not looking at “stale” data. A value of 0 in the time represents a current (less than 1 second) receive value. The current data rate of the last data packet received will also be shown by the Horizon. The speed is displayed in Mbps. For example, in Figure 2 a LastRx value of 0@72.2 represents an RF packet received within the last second running at 72.2Mbps.

Note: The ESTeem Horizon uses spread spectrum technology that analyzes each data packet for signal strength and data quality (strength vs. noise). The higher your signal, the more background noise you can sustain without causing degradation in the data transfer. This is also true for lower signal strengths with a very low background noise. These values are provided for guidance and if you have any questions about the values in your application, please contact ESTeem Customer Support at 509-735-9092 or e-mail your application to support@esteem.com.

Modem ID – This is Modem ID for the opposite ESTeem peer.

TROUBLESHOOTING TIPS

General (Applicable to All Modes of Operation)

Where do I find the latest firmware version number? – We have the latest version number of the Horizon firmware listed on the ESTeem Web site (www.esteem.com) under the Horizon product page.

How and when do I update the Horizon firmware? - You should only update the Horizon firmware if you are having a specific problem and it is recommended that you do so by ESTeem Customer Support personnel. All the update instructions and files are located on the ESTeem FTP site at the following address:

<ftp://www.esteem.com/Horizon>

Do all firmware versions have to be the same to communicate between the Horizon? – It is not necessary for all the firmware versions to be the same revision to communication, but the later version may have added features that the other versions will not recognize.

What characters are valid for WEP Key entry? - Only the Hexadecimal characters 0-9 and A-F are valid for key entry.

What ESTeem Utility version is required to program the Horizon? – The ESTeem Utility program is not required to program the Horizon. The Horizon can be programmed using any Terminal Emulation program (such as Windows HyperTerminal) and any web browser program.

What is the speed and duplex configuration on the Horizon – The Horizon is an auto-negotiation full/half-duplex 10/100 Base-T interface. Either a cross-over or patch cable is supported.

Access Point Mode

Wireless LAN cards are not connecting – Verify that the wireless LAN cards are set to Infrastructure Mode, have a matching SSID (or ESSIS) set the same as the Horizon and that all encryption codes are the same.

My Wireless LAN card shows a solid connection, but I can not pass any data – Verify the encryption and the ACL setting on the Horizon match the wireless LAN card.

Access Point Peer Mode

How long does it take to re-establish the Wireless Ethernet Network? - If a communication link is lost and the Wireless Network needs to re-establish the repeater routes, the time can take up to 10 seconds.

Should the AP Repeater Mode be used on mobile equipment? - The AP Repeater mode should be used on equipment that will not change the Repeater Route as it moves. For example, if a mobile device such as a crane can communicate directly to another ESTeem and will not lose the link in its travel, the AP Repeater Mode could be used. If the device requires two ESTeem Horizon's

(Base and Repeater) to maintain communication across its complete travel, the Station Modes should be used on the mobile device. The problem will be in the time that the mobile ESTeem will take to transfer between the two sites. In Access Point Repeater mode the transfer can take up to 30 seconds, while the EtherStation mode will transfer without a packet loss.

Does WEP have to be used? – The WEP does not have to be enabled for the modems to communicate, but all modems must be configured the same way.

Correct configuration, but cannot establish communications. – In addition to the network configuration, all Horizon modems configured in the AP mode must share the same SSID and be on the same frequency channel. The most likely cause of the error is the WLAN MAC address is not configured in **both** Horizon's repeater tables. If only one side is configured, everything will appear to be correct but no communication will function.

EtherStation

How do I access the Horizon web page in EtherStation Mode? The Horizon does not have an active web browser when configured in EtherStation mode. You must access the ESTeem with the ESTeem Discovery Program or through the RS-232 port after configuration in this mode. To monitor the link status, you can use the EtherStation Status program.

What IP address do I configure the ESTeem in EtherStation mode? – The Horizon will not have an IP address in EtherStation mode.

I can not link my device into the wireless network – Verify that the MAC address of the device is **exactly** the same as configured in the Horizon. The MAC address must have colons between the values.

Can I connect my Horizon in EtherStation mode to a HUB or Ethernet Switch? – No. The modem must be connected directly to the Ethernet device for which it is programmed. In EtherStation mode the Horizon can only service ONE Ethernet device.

Horizon 2.4 GHz Specifications

ESTeem Horizon 2.4 GHz Specifications	
Transmitter/Receiver	
Frequency of Operation (Software Selectable)	2.412 to 2.462 GHz (11-channels)
RF Data Rate	1 to 150 Mbps (20 steps)
Tx Output Power (Software Selectable)	250 to 1000 mW (Pk) (4-levels)
Tx Output Impedance	50 ohms
Rx Sensitivity	-92 to -69 dBm
FCC Type Acceptance	ENPHZN216AN
Industry Canada Type Acceptance	2163A-216AN
LED Indicators	Power (On/Off) - Carrier Detect (On/Off) - Transmitter (On/Off) - Receiver (On/Off)
Power Requirements	
Receive	600ma @ 12 VDC
Transmit	1.350A (Cont) 3A (Peak) @ 12 VDC
PoE Power Supply	(IEEE 802.3at,30 watts) (opt)
External Power Input	10 to 28 VDC @ 3A
Input/Output Connectors	
Ethernet Port 1 (10/100)	RJ-45 Female
Ethernet Port 2 (10/100)	
802.11 Compatibility	802.11n/g/b
RS-232C Comm Port (2,400 to 115.2 K baud)	RJ-45 Female
RS-232C Programming Port (38,400, N, 8, 1)	
Antenna Input/Outputs	TNC Reverse Female
External DC Input Power	Mini-Combicon, 3 pin female
Case	
Temperature Range	-30° to +60° C
Humidity	95% Non-condensing
Dimensions	1.9 in. H x 6.7 in. W x 6.2 in. L
Weight	1.25 lbs.
Product Warranty	1 Year
Other	
Outdoor Pole Mt. Kit	AA195PM (opt)
PoE Power Supply	AA175.2 (opt)
External DC Input Power Connector	AA195PP (opt)

Horizon Case Specifications

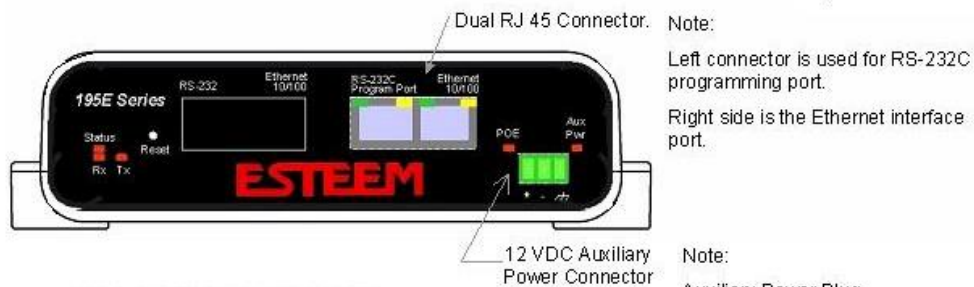
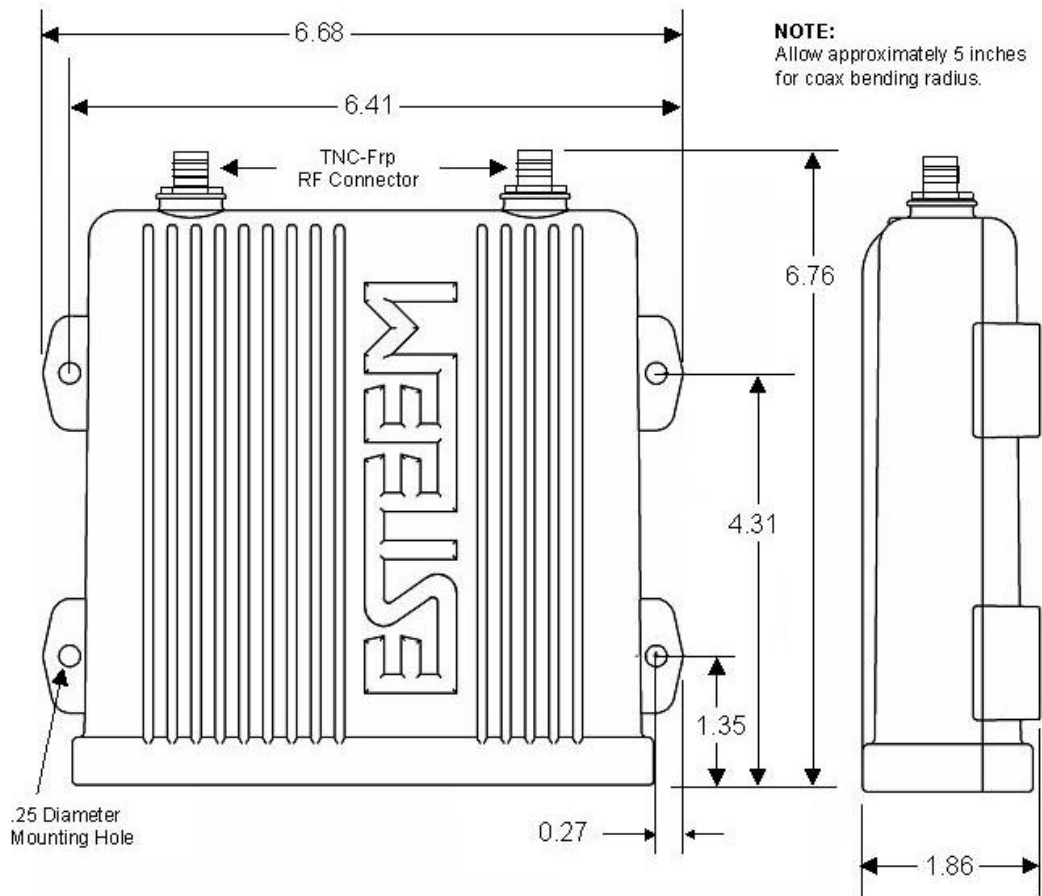

Note: All dimensions are in inches.

Note:
Auxiliary Power Plug with screw termination for wiring is available.

Antenna Specifications

Model: AA20DMEg

Applications: Model 195Eg direct case mount

Antenna Type: Omni-Directional, Sleeve dipole

Frequency: 2400 to 2485 MHz

Polarization: Vertical

Impedance: 50 ohms

Gain: 5 dBi (3 dBd)

VSWR: < 2:1

Power: 10 W

Front To Back Ratio: n/a

Horizontal Beamwidth: n/a

Vertical Beamwidth: n/a

Antenna Material: Polyurethane Plastic Radome

Recommended Mounting Hardware: n/a

Antenna Connector: TNC-R Male

Flexibility: +/- 20 °

Antenna Envelope: 8.28 in. length by .54 in. width

Temperature: -40 to +70 C°

Weight: 33 grams

Caution

Omni-directional antenna should not be located within 24 cm of personnel.



Model AA20DMEg

Antenna Specifications

Model No:	AA203Eg
Antenna Type:	Directional, DC grounded
Applications:	Fixed base.
Frequency:	2400 to 2485 MHz
Polarization:	Vertical or Horizontal
Impedance:	50 ohms
Gain:	6 dBi (4 dBd)
VSWR:	< 1.5
Front to Back Ratio:	>23 dB
Horizontal Beamwidth:	55 degrees @ ½ power
Vertical Beamwidth:	55 degrees @ ½ power
Antenna Material:	Sealed in UV stable fiberglass enclosed radome
Mounting Hardware:	Stainless steel U bolts (included) for mounting up to 1 5/8 in. diameter pipe.
Antenna Connector:	TNC-R Male with 36in. pig tail
Maximum Power Input:	5 Watts
Antenna Envelope:	4.5 in. length by 3 in. diameter
Windload (RWV):	125 mph
Lateral Thrust at Rated Wind:	5.8 lbs.
Wind Surface Area:	0.060 ft ²
Weight:	1 lbs.

Caution

To comply with the FCC exposure compliance requirements, a separation distance of at least 24 cm must be maintained between the antenna and all persons.



Model AA203Eg

Antenna Specifications

Model No:	AA204Eg.1
Applications:	Fixed base mounting
Antenna Type:	2.4 GHz ISM, Directional, DC Grounded, Parabolic Grid
Frequency:	2400-2485 MHz
Polarization:	Vertical or Horizontal
Impedance:	50 ohms
Gain:	15 dBi (13 dBd) nominal
VSWR:	< 1.5:1 nominal
Front to Back Ratio:	>24 dB
Horizontal Beamwidth:	16 degrees @ ½ power
Vertical Beamwidth:	11 degrees @ ½ power
Antenna Material:	Zinc plated cold rolled steel with polyester power coat finish
Recommended Mounting Hardware:	Standard U-bolt steel mast clamp complete with mounting hardware. Designed for masts of up to 2.5 in. O.D.
Antenna Connector:	TNC-R Male with 36 in. pig-tail
Maximum Power Input:	10 Watts
Wind Survival:	100 mph
Wind Load:	16 mph
Antenna Envelope:	34 in. length by 17 in. width by 11 in. height
Weight:	3 lbs.

Caution

To comply with the FCC exposure compliance requirements, a separation distance of at least 50 cm must be maintained between the antenna and all persons.



Model AA204Eg.1

Use of the AA204Eg.1, directional antenna is limited to fixed point-to-point applications only. In accordance with FCC Section 15.247(b)iii, this antenna must be professionally installed. The installer must ensure the system is used exclusively for fixed, point-to-point applications and the ESTeem Model 195Eg is set for 0.25 Watts output power (Power Level = Min).

Horizon 900 MHz Specifications

ESTeem Horizon 900 MHz Specifications	
Transmitter/Receiver	
Frequency of Operation (Software Selectable)	902 to 928 MHz (4-channels)
RF Data Rate	1 to 57.8 Mbps
Tx Output Power (Software Selectable)	250, 500, 750, and 1000 mW (Pk) (4-levels)
Channel Bandwidth	5 MHz, 10 MHz or 20 MHz
Tx Output Impedance	50 ohms
Rx Sensitivity	-97 to -78 dBm
FCC Type Acceptance	ENPHZN216AD (Preliminary)
Industry Canada Type Acceptance	2163A-216AD (Preliminary)
LED Indicators	Power (On/Off) - Carrier Detect (On/Off) - Transmitter (On/Off) - Receiver (On/Off)
Power Requirements	
Receive	600ma @ 12 VDC
Transmit	1.350A (Cont) 3A (Peak) @ 12 VDC
PoE Power Supply	(IEEE 802.3at, 30 watts) (opt)
External Power Input	10 to 28 VDC @ 3A
Input/Output Connectors	
Ethernet Port 1 (10/100/1000)	RJ-45 Female
Ethernet Port 2 (10/100/1000)	
802.11 Compatibility	n/a
RS-232C Comm Port (2,400 to 115.2 K baud)	RJ-45 Female
RS-232C Programming Port (38,400, N, 8, 1)	
Antenna Input/Outputs	TNC Reverse Female
External DC Input Power	Mini-Combicon, 3 pin female
Case	
Temperature Range	-30° to +60° C
Humidity	95% Non-condensing
Dimensions	1.9 in. H x 6.7 in. W x 6.2 in. L
Weight	1.25 lbs.
Product Warranty	1 Year
Other	
Outdoor Pole Mt. Kit	AA195PM (opt)
PoE Power Supply	AA175.2 (opt)

Horizon Case Specifications

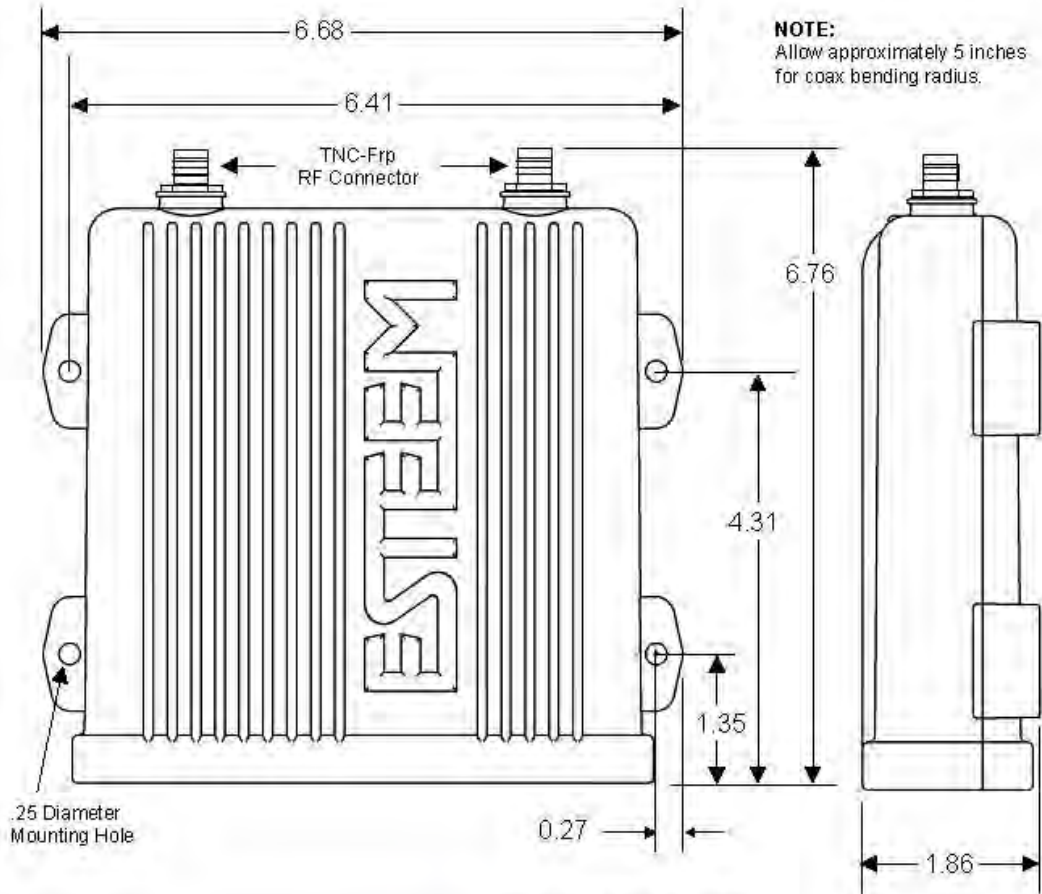

Note: All dimensions are in inches.

Antenna Specifications

Model No:	AA20Es900
Antenna Type:	Omni Directional, DC Grounded
Applications:	Fixed base
Frequency:	902 to 928 MHz
Polarization:	Vertical
Impedance:	50 ohms
Gain:	7 dBi (5 dBd)
VSWR:	1.5:1 Typical
Front to Back Ratio:	n/a
Horizontal Beamwidth:	n/a
Vertical Beamwidth:	22 degrees @ ½ power
Antenna Material:	Brass radiator, UV inhibited fiberglass enclosed
Mounting Hardware:	Base to Mast, Supplied.
Maximum Power Input:	150 Watts
Wind Survival:	100 mph
Bending Moment:	14.2 ft-lbs. @ 100 mph
Antenna Connector:	TNC-R Male with 36in. pig-tail.
Antenna Envelope:	48 in. L x 1-5/16 in. Dia.
Weight:	1.75 lbs.

Caution

To comply with the FCC exposure compliance requirements, a separation distance of at least 23 cm must be maintained between the antenna and all persons.



Model AA20Es900

Antenna Specifications

Model No:	AA203Es900
Antenna Type:	Directional, DC grounded
Applications:	Fixed base.
Frequency:	902 to 928 MHz
Polarization:	Vertical or Horizontal
Impedance:	50 ohms
Gain:	7 dBi (5 dBd)
VSWR:	< 1.5:1 Nominal
Front to Back Ratio:	> 16 dB
Horizontal Beamwidth:	130 degrees @ ½ power
Vertical Beamwidth:	70 degrees @ ½ power
Antenna Material:	Aluminum
Mounting Hardware:	Heavy duty U bolts for mounting up to 2.0 in. pipe (included).
Antenna Connector:	TNC-R Male with 2 ft. pigtail with ESTeem weatherproof boot.
Maximum Power Input:	50 Watts
Antenna Envelope:	1.1 ft. length by 6 in. width
Windload (RWV):	150 mph
Wind Surface Area:	.11 ft ²
Weight:	1 lbs.

Caution

To comply with the FCC exposure compliance requirements, a separation distance of at least 23 cm must be maintained between the antenna and all persons.

