

LDMOS UHF SERIES



MEDIUM POWER TV AMPLIFIER

User's manual

This page is intentionally blank

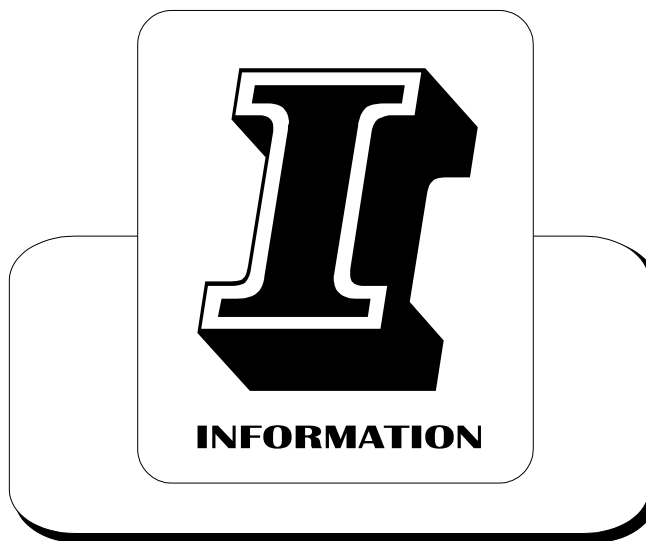

Section 1 - Information

Contents:

- 1.1 Description*
- 1.2 Main Features*
- 1.3 Technical characteristics*
- 1.4 Front panel*
- 1.5 Rear panel*
- Rear connections*

MEDIUM POWER TV AMPLIFIER SERIES

1.1 DESCRIPTION

The amplifier belongs to the Medium Power Amplifier products family of Television Amplifiers fully in solid state LDMOS technology.

These TV Amplifiers operate in the UHF Band with Common amplification process (separate amplification available) of the Video and Audio carriers. This Amplifier family has been designed to offer to the customer high performances, high reliability and greater simplicity in its operation and maintenance procedures.

The Video and Audio signal processing is provided for all TV Standards and all types of Audio applications (Mono & Dual Sound - NICAM) together with the different colour systems such as PAL - NTSC - SECAM. Thanks to the amplitude and phase and non linearity pre-correction circuit, it is possible to cancel the distortions in the output stage, thus cutting down the operating costs.

Due to the common amplification design, the transmitter is easily upgradeable to any digital TV standard: DVB-T, DVB-H, DMB-T, ATSC. It is only necessary to replace the modulator and the RF output band pass filter, all the other components are used without any change.

The cooling system is fully contained into the amplifier, and it is based on forced air flow. A powerful and very low acoustic noise blower is used. A front panel air dust filter is available, sized in order to enable easy replacement.

The user interface is based on a graphics display, where all the parameters are showed. A detailed log of events and alarm help the maintenance of the system.

The unit can be fully controlled in REMOTE mode via PC direct-link or via PSTN, GSM or Ethernet networks by means of Elettronika Remote Control System.

The system can be easily upgraded with dual drive option.

Besides, the transmitter can be easily integrated in a 1+1 or more complex N+1 redundancy configurations.

1.2 MAIN FEATURES

- *LDMOS Technology;*
- *Forced-air cooling system;*
- *Analog and Digital input signal;*
- *High efficiency;*
- *Wired and serial remote control (RS232 or RS485);*
- *All voltages and currents available on display;*
- *Output filter included.*

1.3 TECHNICAL CHARACTERISTICS

RF SECTION

- Analog Operation

Frequency Range	UHF
Output Power (± 0.5 dB)	1300W
Amplification Class	AB
Gain (± 2 dB)	28dB
Technology	Solid State LDMOS
RF Input Connector	N Female
Impedance	50 Ω
RF Output Connector (Amplifier / Rack)	7/16" Female / EIA 7/8"
Impedance	50 Ω

- Digital Operation

Frequency Range	UHF
Digital Output Power (DVB-T)	300W RMS
Digital Output Power (ATSC)	500W RMS
DVB-T Modes	All the modes listed in ETSI EN 300 744
DVB-T MER	≥ 33 dB RMS
DVB-T Shoulders Attenuation (After non-critical mask cavity filter)	≥ 40 dB RMS
DVB-T Output Spectrum	Compliant ETSI EN 300 744
ATSC Symbol Rate	10.76MBaud/s (Compliant to ATSC Doc. A/53)
ATSC SNR	≥ 27 dB RMS
ATSC Shoulders Attenuation (After simple mask cavity filter ref. total output power)	≥ 46 dB RMS
ATSC Output Spectrum	Compliant to ATSC Doc. A/64

REMOTE CONTROL SECTION

Parallel Interface	ON/OFF, Alarms, Interlock
Serial Interface	RS232 or RS485 Selectable

METERING

Output Forward Power (Peak or RMS)
Output Reflected Power (Peak or RMS)
Unbalance Power
Heat sink Temperature
Input Power (Peak or RMS)
RF Modules Current
Power Supply Voltage
Working Timer

INDICATIONS

Cooling Blower Working (With icon on front display)
Transmitter Interlock (With icon on front display)
Alarm (With red LED on front panel)
Transmitter ON/OFF (With green LED on front panel)
Remote ON/OFF (With orange LED on front panel)

PROTECTIONS

Output Forward Power
Output Reflected Power
Unbalance Power
RF Modules Current
Power Supply Voltage

PROTECTIONS

Forward Power (Analogue)	1500W
Reflected Power (Analogue)	150W
Forward Power (DVB-T)	400W
Reflected Power (DVB-T)	40W
Forward Power (ATSC)	600W
Reflected Power (ATSC)	60W
Unbalance (Analogue)	300W
Unbalance (DVB-T)	100W
Unbalance (ATSC)	150W
Temperature	75°C
I_{DC}	18A
V_{DC}	Min 10V - Max 33.5V

GENERAL

Power Supply Voltage	90 - 260V
Power Supply Frequency	50 - 60Hz
Power Factor	> 0.98
Analog Power Consumption (Black)	3.45kVA
Digital Power Consumption (DVB-T)	2.2kVA
Digital Power Consumption (ATSC)	2.5kVA
Housing (Amplifier / Rack)	6U / 20U
Weight (Amplifier / Rack)	63kg / 175kg
Airflow	From 330m ³ /h to 500m ³ /h
Temperature	-5°C to +45°C

Options

- Non critical mask, DVB-T, Output filter
- Critical mask, DVB-T, Output filter
- Stringent emission mask, ATSC, Output filter

¹AUTV/500LD, ²AUTV/1000LD, ³AUTV/1500LD

1.4 FRONT PANEL

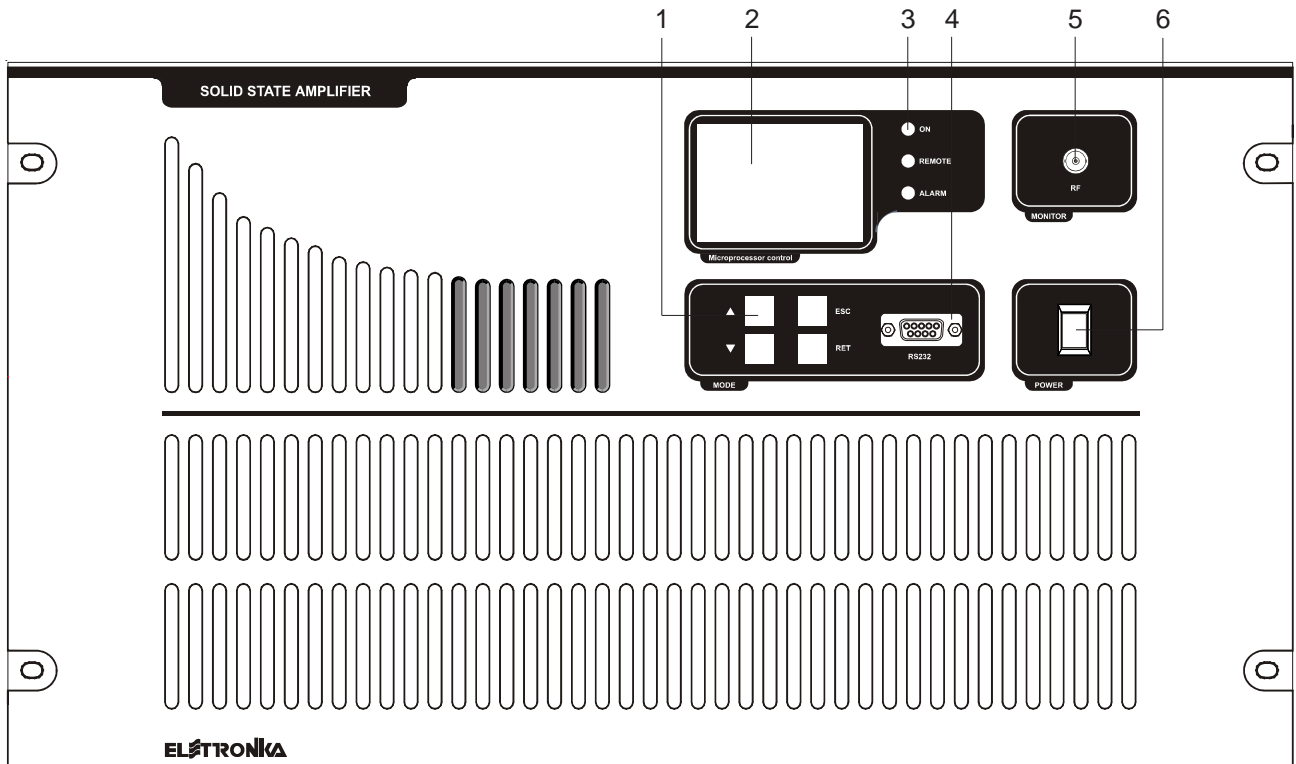

1. Function keys
2. LCD Graphic Display
3. Status LEDs
4. RS232 Socket
5. RF Monitor Connector
6. Main Switch

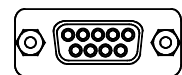

RS232 for connection
to PC with ERCoS software
and for firmware upgrade

Pin 2: TX
Pin 3: RX
Pin 5: GND

1.6 REAR PANEL

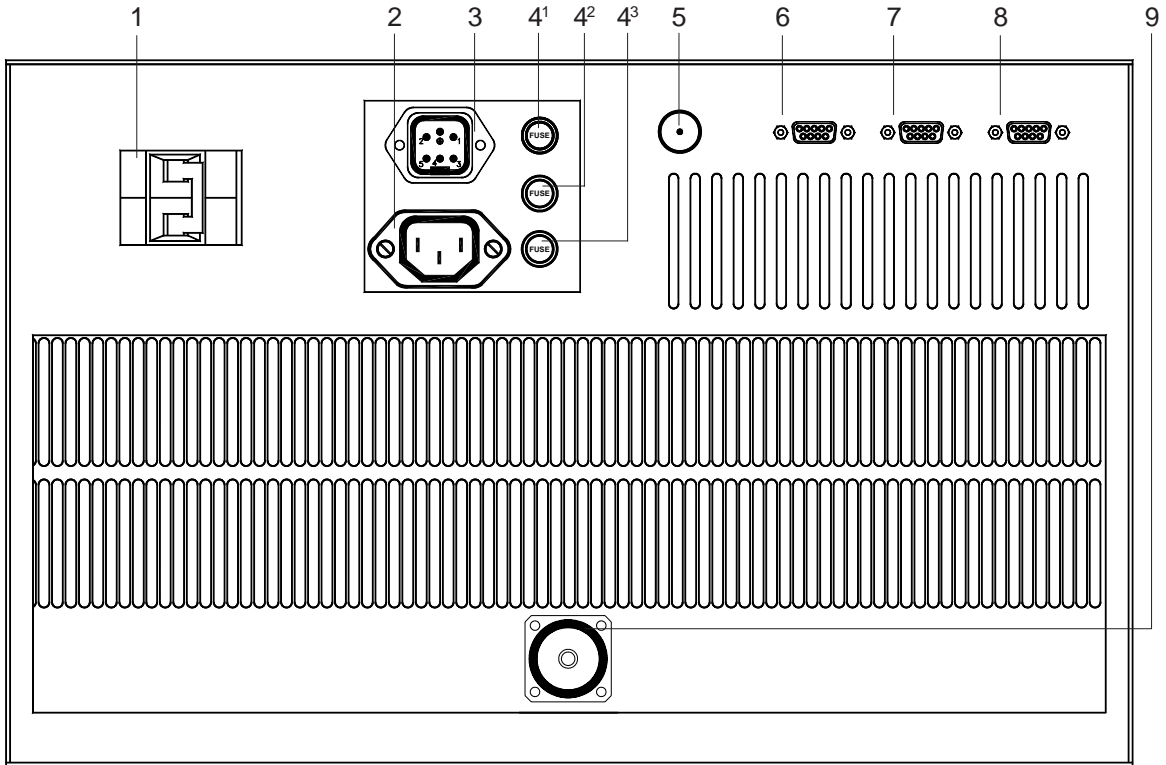

1. Breaker
2. AC 220V OUT Socket
3. AC 400V IN Socket
- 4¹. FAN 3.15A Fuse
- 4². CONTROL BOARD 1A Fuse
- 4³. EXCITER 4/8A Fuse
5. RF IN Connector
6. RS485 Socket
7. EXCITER Socket
8. TELEMEASURES Socket
9. RF OUT Connector

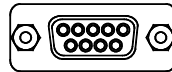

Wired Telemeasures connector

- Pin 1: FWD power (Analog out)
- Pin 2: REF power (Analog out)
- Pin 3: Temperature (Digital out)
- Pin 4: Interlock (Digital in)
- Pin 5: GND
- Pin 6-7: Free contact (Digital out)
Closed when Alarm
- Pin 8: 0V=ON / 5V=Normal (Digital in)
- Pin 9: 0V=OFF / 5V=Normal (Digital in)

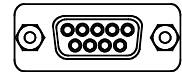

EXCITER for connection to Driver Module

- Pin 1: GND
- Pin 2: 0V=Normal / 5V=AGC Alarm (Digital out)
- Pin 3: 0V=Normal / 5V=AGC Alarm (Digital out)
- Pin 8: FWD power (Analog out)
- Pin 9: REF power (Analog out)

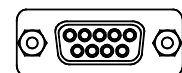

RS485 for connection to RCU or Amplifier Control

- Pin 2: RX-
- Pin 3: RX+
- Pin 4: +5V
- Pin 5: GND
- Pin 7: TX-
- Pin 8: TX+

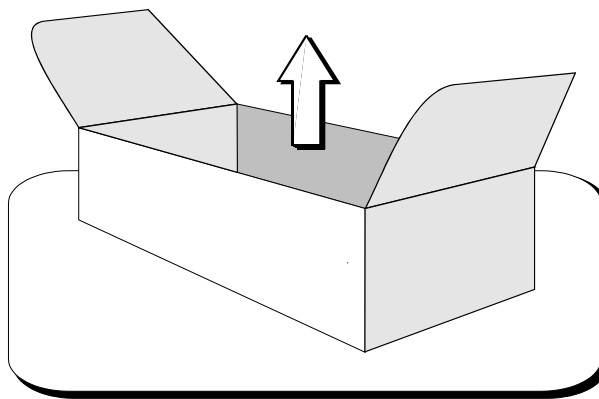

Section 2 - Installation

Contents:

- 2.1 Operating environment*
- 2.2 First installation*
- 2.3 Connection with VEGA Transmitter*
- 2.4 Stand-alone Amplifier configuration in Dual Drive version*
- 2.5 Slave multi-Amplifier configuration with Amplifier Control*
- 2.6 Stand-alone Amplifier configuration with Elettronika RCU*
- 2.7 Stand-alone Amplifier configuration with direct PC connection*

2.1 OPERATING ENVIRONMENT

You can install the equipment in a standard component rack or on a suitable surface such as a bench or desk. In any case, the area should be as clean and well-ventilated as possible. Do not locate the equipment directly above a hot piece of device. The upper lid can be dismantled to allow an easy internal access. The equipment is designed with a modular design, that is each circuit is realized inside different modules or boards. All interconnections between modules are made by means of connectable cables which allow an easy and quick maintenance of damaged modules.

2.2 FIRST INSTALLATION

Correct installation of the equipment is important for maximum performance and reliability. Antenna and earth connections must be installed with the greatest care. The equipment adjustment isn't need, because the unit is completely adjusted by our technical staff.

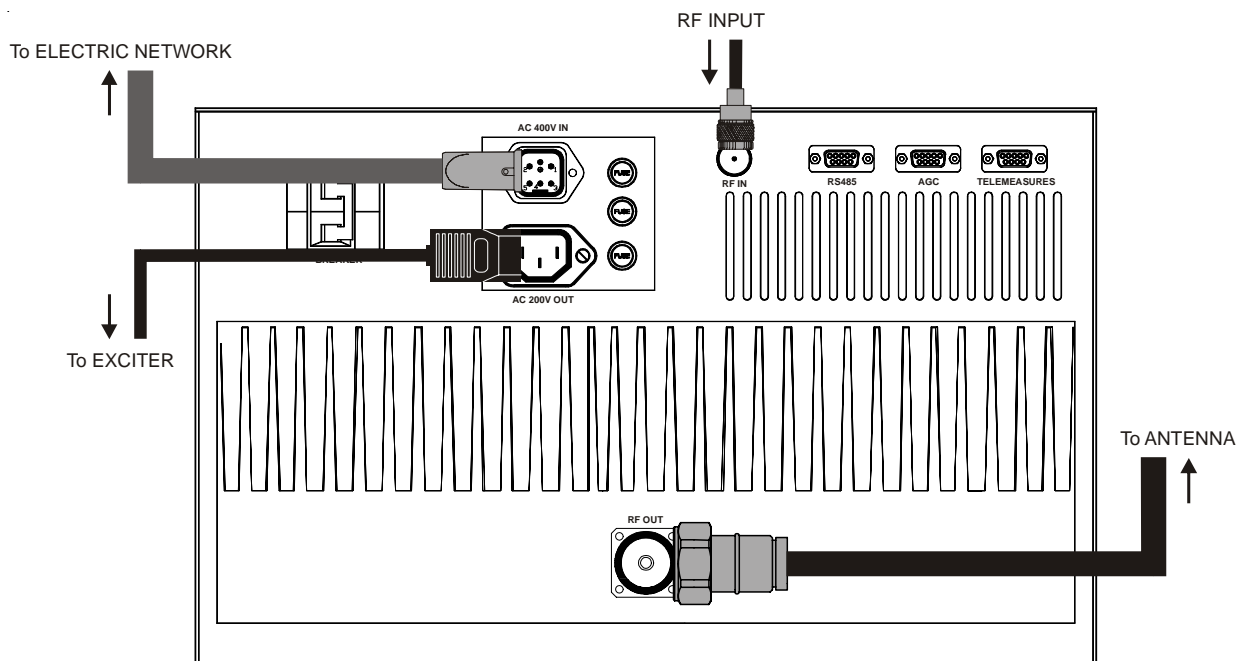

1. Connect Power Supply cable of the Exciter to the Auxiliary Socket on the rear panel of the Amplifier;
2. connect the Power Supply cable of the Amplifier to the electric network (230VAC Monophase or 400VAC Threephase); if present the Isolator Transformer, the Amplifier is provided with cable and plug;
3. connect the RF OUT Exciter cable to the RF IN connector on the rear panel of the Amplifier;
4. connect the Antenna cable to the RF OUT connector on the rear panel of the Amplifier.

When the equipment is put within a combined system it is directly connected to the input splitting and output combining systems.

Before fully powering the equipment, check that the output connections of the coaxial cable to the antenna system are working.

In order to this it is possible to check the indication of the Reflected Power at low power levels. Only if the SWR indication on the display is 0, the output power can be slowly increased. At maximum output power, some watts might be shown as Reflected Power.

2.3 CONNECTION WITH VEGA TV TRANSMITTER

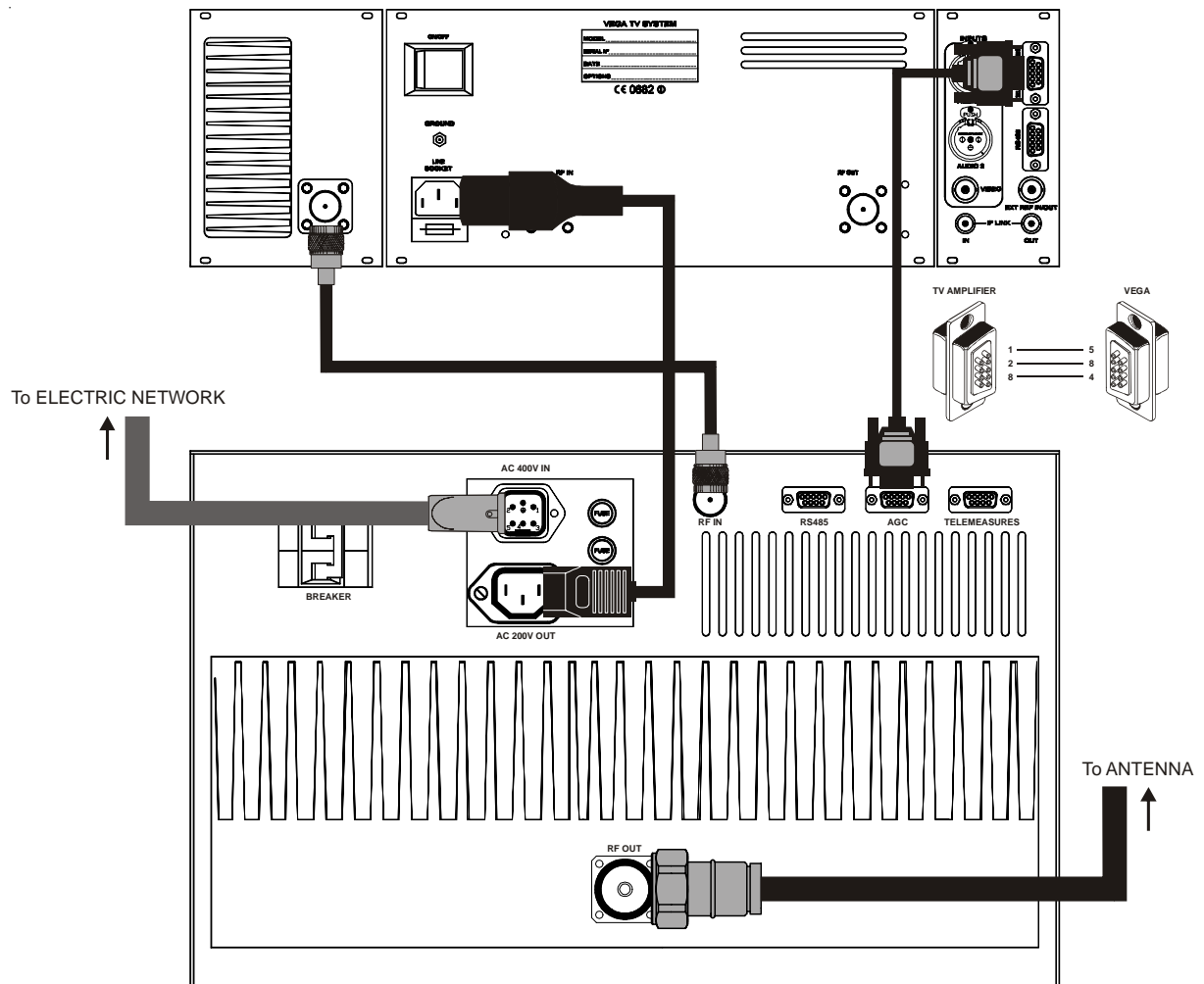

2.4 STAND-ALONE AMPLIFIER CONFIGURATION IN DUAL DRIVE VERSION

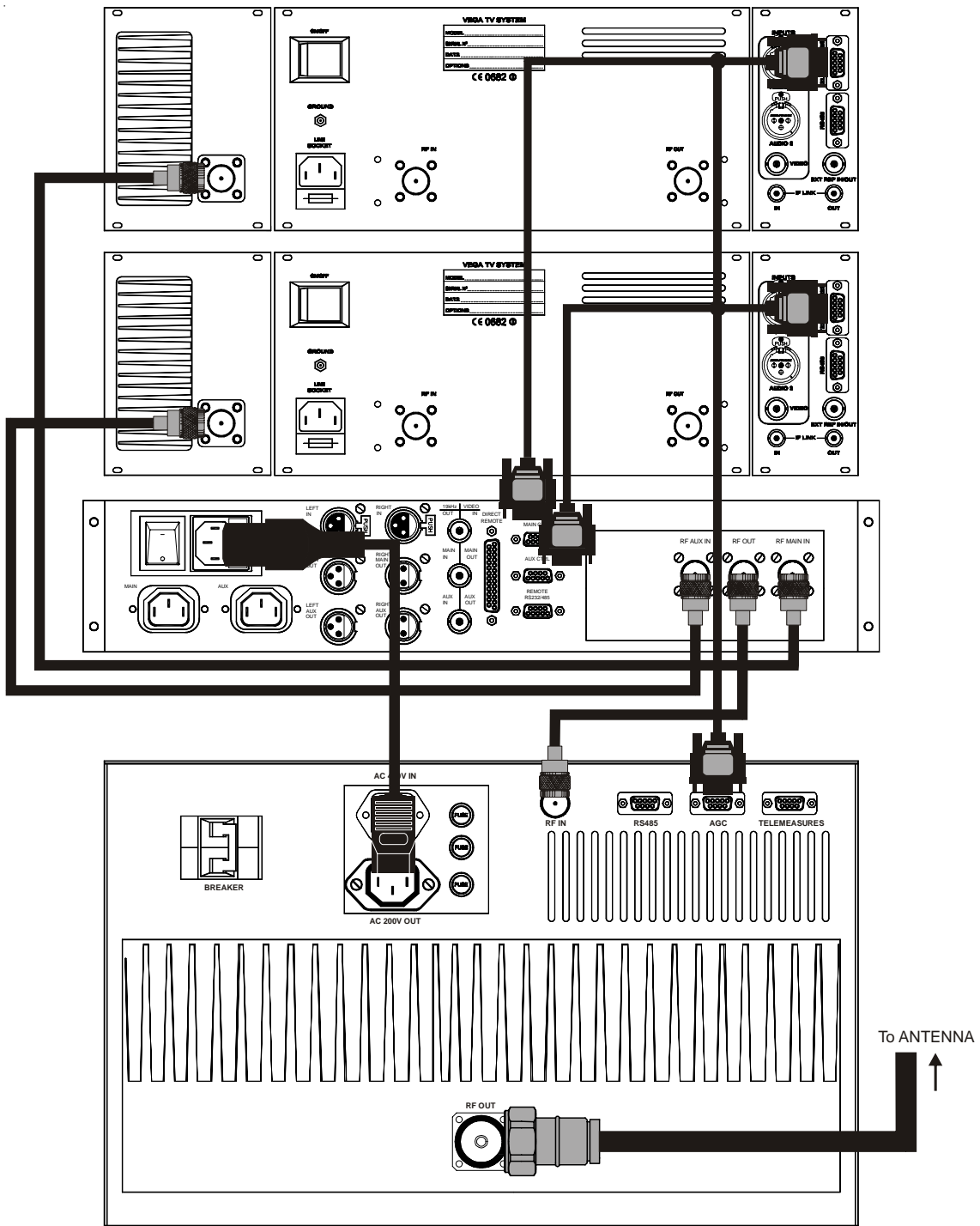

2.5 SLAVE MULTI-AMPLIFIER CONFIGURATION WITH AMPLIFIER CONTROL

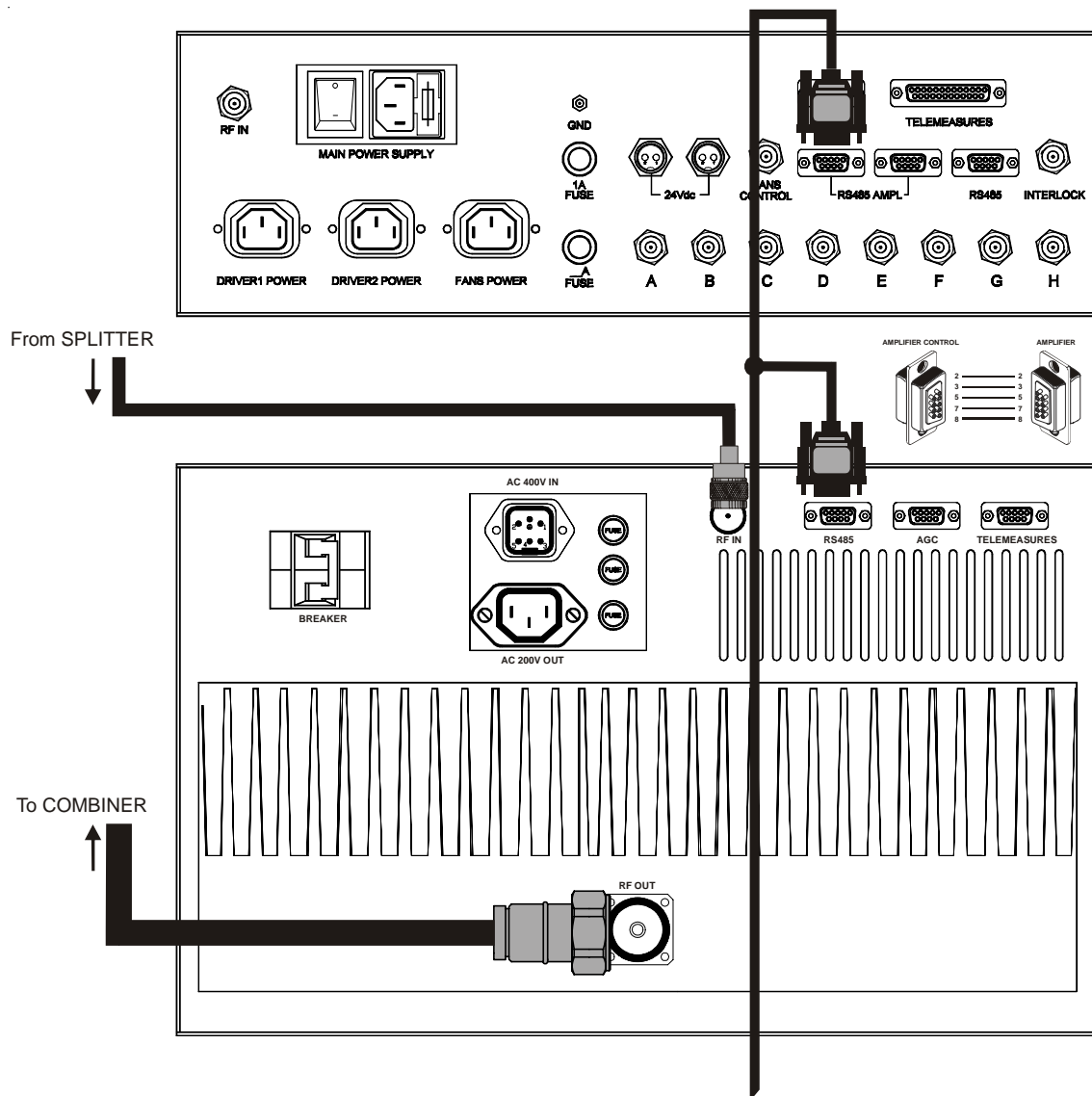

2.6 STAND-ALONE AMPLIFIER CONFIGURATION WITH ELETTRONIKA RCU

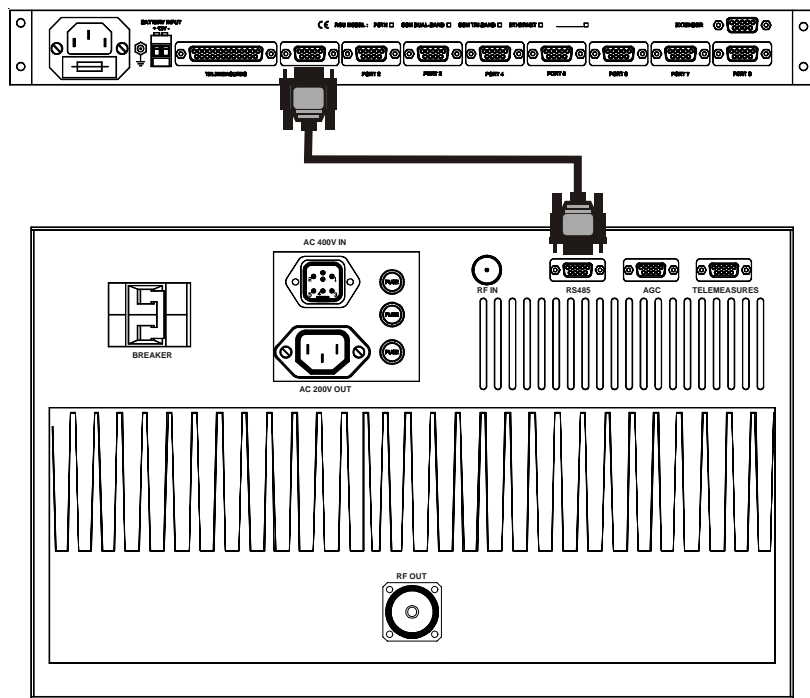

2.7 STAND-ALONE AMPLIFIER CONFIGURATION WITH DIRECT PC CONNECTION

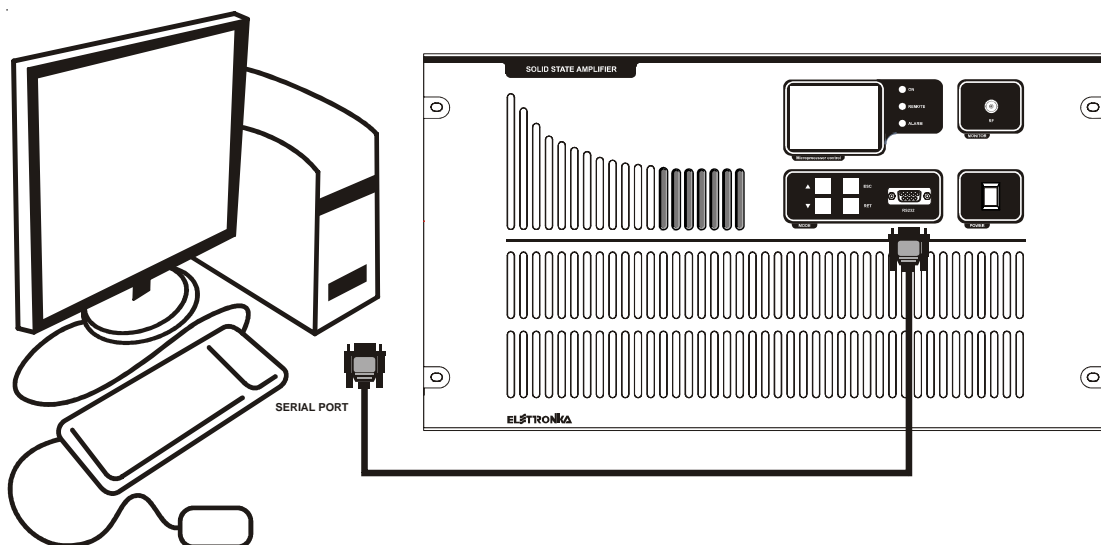

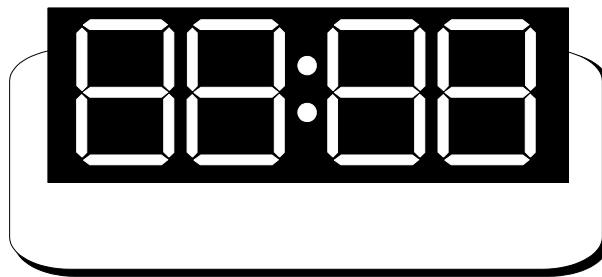

Section 3 - Operation

Contents:

- 3.1 Operation*
- 3.2 Display*
- 3.3 Menus*
- 3.4 Firmware upgrade*

3.1 OPERATION

At startup, after initial image, the display shows the main screen with the RF powers as below:

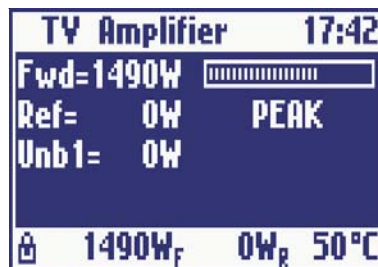

The user may turn on and off the amplifier by means of the switch on the front panel. The control board turns on all the power supplies, the exciter (if any), and internal cooling fans. While the amplifier is working, the micro-controller monitors continuously the most important parameters: power supply voltages, absorbed currents, high power zone temperature, forward and reflected powers, unbalances (if any). Each measure is associated to a maximum threshold beyond which the amplifier is immediately put in protection status by turning off one or more power supply, depending on the failed block. In order to prevent a temporary problem to trigger a definitive protection status, the failed block is turned on again, after some seconds, for up to five times. If it goes beyond the protection threshold for more than five times, it is declared as FAILED and it will no longer be turned on. In this case, the amplifier will have to be turned off manually by means of the switch on the front panel, then turned on again after performing the needed maintenance.

On the front panel there are also three LEDs labelled ON, REMOTE and ALARM. Their meanings are explained in Table 1.

LED	COLOUR	MEANING	MEANING WHEN BLINKING
ON	Green	The amplifier is on	The amplifier has been turned on locally but it has been turned off by remote
REMOTE	Yellow	Remote control is enabled	It never blinks
ALARM	Red	An alarm is present	It never blinks

Table 1: Meanings of the three LEDs on the front panel

¹ Screenshots in this manual are indicative, so they can be different from those on your equipment.

3.2 DISPLAY

The Control Board is provided with a modern pixels graphic display with blue background. Normally it always shows a title bar (on the top line) and a status bar (on the bottom line). The ‘Title bar’, shows the name of the amplifier (TV Amplifier) and the current time. If the amplifier is a single unit coupled externally with other units in a high power transmitter, the title bar shows the amplifier number (slave address) too.



The ‘Status bar’ indicates the forward and reflected powers and the temperature. It also contains two symbols for the interlock (lock) and the alarm (bell).



The bell symbol is continuously displayed in case of alarm. It blinks if there has been an alarm which has ended but has not yet been seen by the user. It stops blinking once the Log has been checked. The interlock symbol is displayed only when this function is enabled. It may be either a close lock, when there is no alarm (interlock chain closed) or an open lock in case of alarm (interlock chain open).

Since the status bar is always showed on the display, regardless of the screen, the user may monitor at any time the most important parameters and the presence of alarms while moving between different screens.

3.3 MENU

The user may see or modify locally some configuration parameters using the four buttons on the front panel. All screens are organized in a hierarchical menus and the user may move between them in a simple and intuitive way. To see the menu it's sufficient to press the ESC key.



The display only shows three items at a time: all the items can be scrolled by the UP and DOWN arrow keys. Any item can be chosen by selecting it and pressing the RET key. Menu entries with an arrow on the right  open sub-menus when chosen. Thus there is a hierarchical structure as below. To go back from a sub-menu to the previous menu, press the ESC key. If the ESC key is pressed in the main menu, the RF powers screen is accessed.

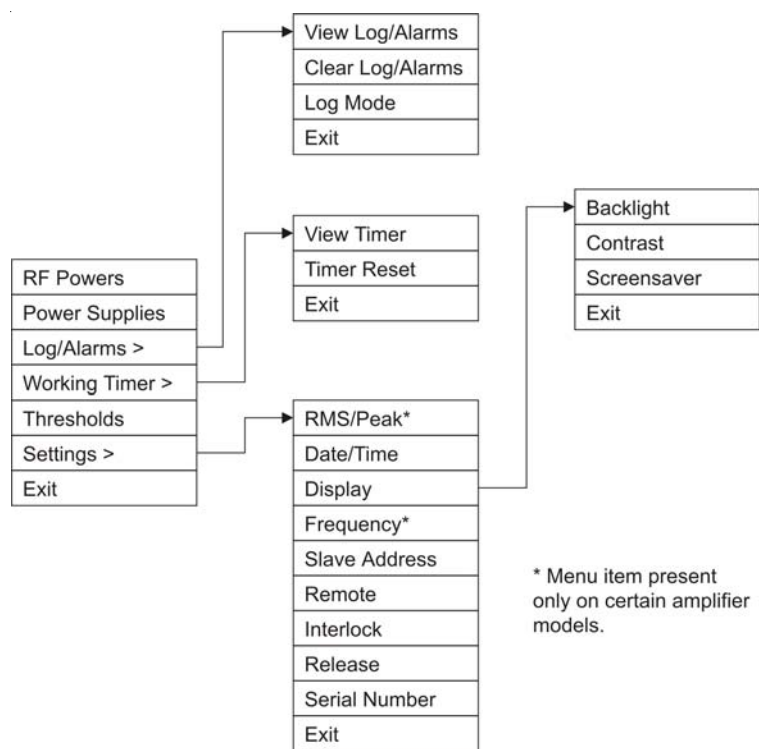

Hierarchical menu structure

RF Powers

This is the main screen showing the RF powers of the amplifier: forward power, reflected power, unbalances, if any. For forward power a level bar is displayed. See an example in Figure 1.

TV Amplifier		23 06
1 (ON)	2 (ON)	
V1=49.8V	V2=50.2V	
I1= 6.6A	I2= 6.9A	
500W _f	0W _r	44°C

Power Supply

This screen shows all the signals coming from two power supply. To check the next (previous) power supply press the UP (DOWN) key. For each power supply, the voltage, the absorbed current and the status (ON or OFF) are shown.



Log/Alarms

The control board is provided with an external EEPROM and a clock. Any alarm or switching event with the time at which it occurred is saved in the EEPROM. The Log/Alarms sub-menu allows to manage this log.

It is possible to see the events stored in the log by selecting Log/Alarms → View Log/Alarms. All events can be scrolled by pressing the UP and DOWN keys. For example, the event shown in Figure 7 is the turning on of the amplifier by means of the local switch. For every event/alarm a short description and the date and time at which it occurred is displayed.

In case of alarm, the value of the measure which caused the alarm is saved into the log. In case of alarm still existing after five turning-on attempts, the parameter is marked as FAILED. The table below is the list of all the events which can be logged.

EVENT	DESCRIPTION
Local ON	Amplifier turned on by means of the local switch
Local OFF	Amplifier turned off by means of the local switch
Remote ON	Amplifier turned on remotely
Remote OFF	Amplifier turned off remotely
Interlock open	Interlock chain open
Interlock closed	Interlock chain closed
Power Supply ON	Power supply on
Fwd Pwr xxxW	Alarm for forward power
Ref Pwr xxxW	Alarm for reflected power
UnbY xxxW	Unbalancing alarm
V1 xx.xV	Power supply voltage alarm
I1 xx.xA	Power supply current alarm

The log may be completely deleted by selecting Log/Alarms → Clear Log/Alarms. Amplifier can store in the log details about alarms and generic events. You can change this behaviour selecting Log/Alarms → Log/Mode menu item.

Working Timer

The control board has a working timer which is always enabled while the amplifier is

working (i. e. there is at least one power supply working). The menu entry Working Timer → View Timer allows to check the hours for which the timer has been enabled. Working Timer → Timer Reset resets the timer.

Thresholds

This is a screen showing the alarm threshold of each signals monitored by the control board. The list can be scrolled by means of the UP and DOWN keys.

RMS/Peak

The control board can monitor both the RMS and peak powers, the first used in digital systems. The menu entry Settings → RMS/Peak allows to choose the power to be displayed and monitored. This menu is present only in certain amplifiers.



Date/Time

This screen allows to set the current date and time. The setting is changed by pressing the arrow keys, then pressing the RET key to move to the following value and eventually save the changes. To go back to the previous menu and discard any change made, press the ESC key.

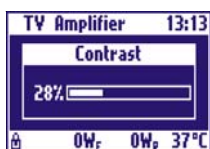

Display

The menu entry Settings → Display allows to change some settings of the display, such as back light, contrast and screensaver. The back light and the contrast are set by means of the UP and DOWN arrow keys. The changes made are saved by pressing the RET key or discarded pressing the ESC key.

With Settings → Display → Screensaver you can set an interval time after which display backlight is turned off. When display backlight is off, press any key to switch it on.

Frequency (only for some Amplifiers)

The forward and reflected RF powers is measured by means of a directional coupler. In order to compensate for the effect due to the sampling made by the coupler, it is possible to set the frequency by menu entry Settings → Frequency. The setting can be changed by pressing the arrow keys. The changes made are saved by pressing the RET key or discarded pressing the ESC key. Set the video carrier frequency.

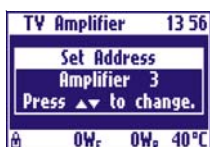

Slave Address

The amplifier may be used either in stand-alone mode or as a slave of a master in a high power multiple units transmitter. In the latter case an unique address for each amplifier has to be specified, in order for all of them to communicate with the master on the same RS485 bus. The menu entry Settings → Slave Address allows to choose the stand-

alone mode or set a slave address by means of the UP and DOWN arrow keys. The changes made are saved by pressing the RET key or discarded pressing the ESC key.

Remote

The amplifier may be controlled either locally, by means of the keys and display, or remotely. There are three possibilities for remote control:

- using a direct serial connection between amplifier RS232 connector and a PC RS232;
- using the remote control device manufactured by Elettronika S.r.l. (RCU), on the RS485;
- using a general-purpose control system connected to telemeasures.

You can enable / disable remote control choosing menu item Settings → Remote. When remote control is enabled, the yellow REMOTE LED on the front panel is lit.

Interlock

One of the pins of the telemeasure connector, located on the rear panel, is used for the interlock alarm. It is an input line which turns off the amplifier in case of alarm. The interlock check can be enabled or disabled using menu item Settings → Interlock. When it is enabled, the status bar shows the lock symbol, which is close if the interlock chain is closed (no alarm) or open if it is open (alarm).

Firmware Release

The menu entry Settings → Firmware Release allows to display the firmware version number and the hardware release of the amplifier.

Serial Number

The menu entry Settings → Serial Number allows to display the serial number of the apparatus.

3.4 FIRMWARE UPGRADE

The microcontroller is provided with a built-in Flash memory containing the firmware. The firmware can be updated with a later version without removing the apparatus from the rack and/or replacing the chip.

To upgrade it, connect a PC to the RS232 socket on the front panel of the apparatus by means of a cable DB9 male - DB9 female (pin-to-pin).

Launch on the PC the EKAFlash application, select the serial port in use on the PC, choose the update file by pressing the “...” key and click on Download button.

Eventually, turn off the amplifier from the main switch and then turn it on again. The upgrade of the firmware begins on the EKAFlash window. The figure below shows this window while a firmware is being updated.

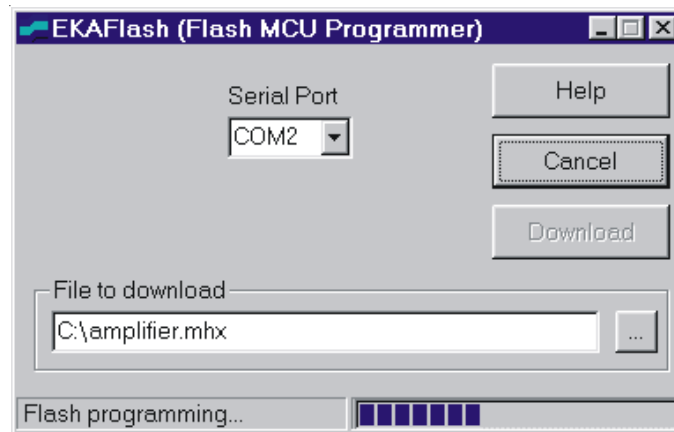

The EKAFlash window while updating a firmware

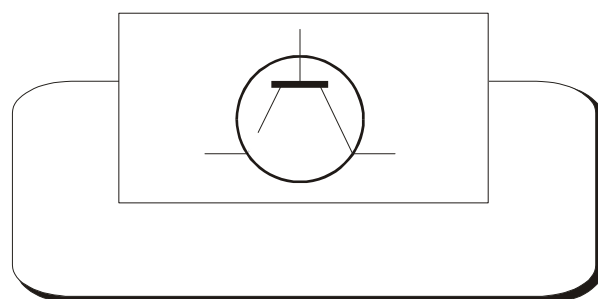

Section 4 - Diagram

Contents:

- *APT144 AUTV/1500LD Cable diagrams*
- *APT144C_APT144CM AUTV/1500LD Component list*
- *APT144DM_APT144DM/DIG AUTV/1500LD Component list*
- *Modules description*

0 1 2 3 4 5 6 7 8 9

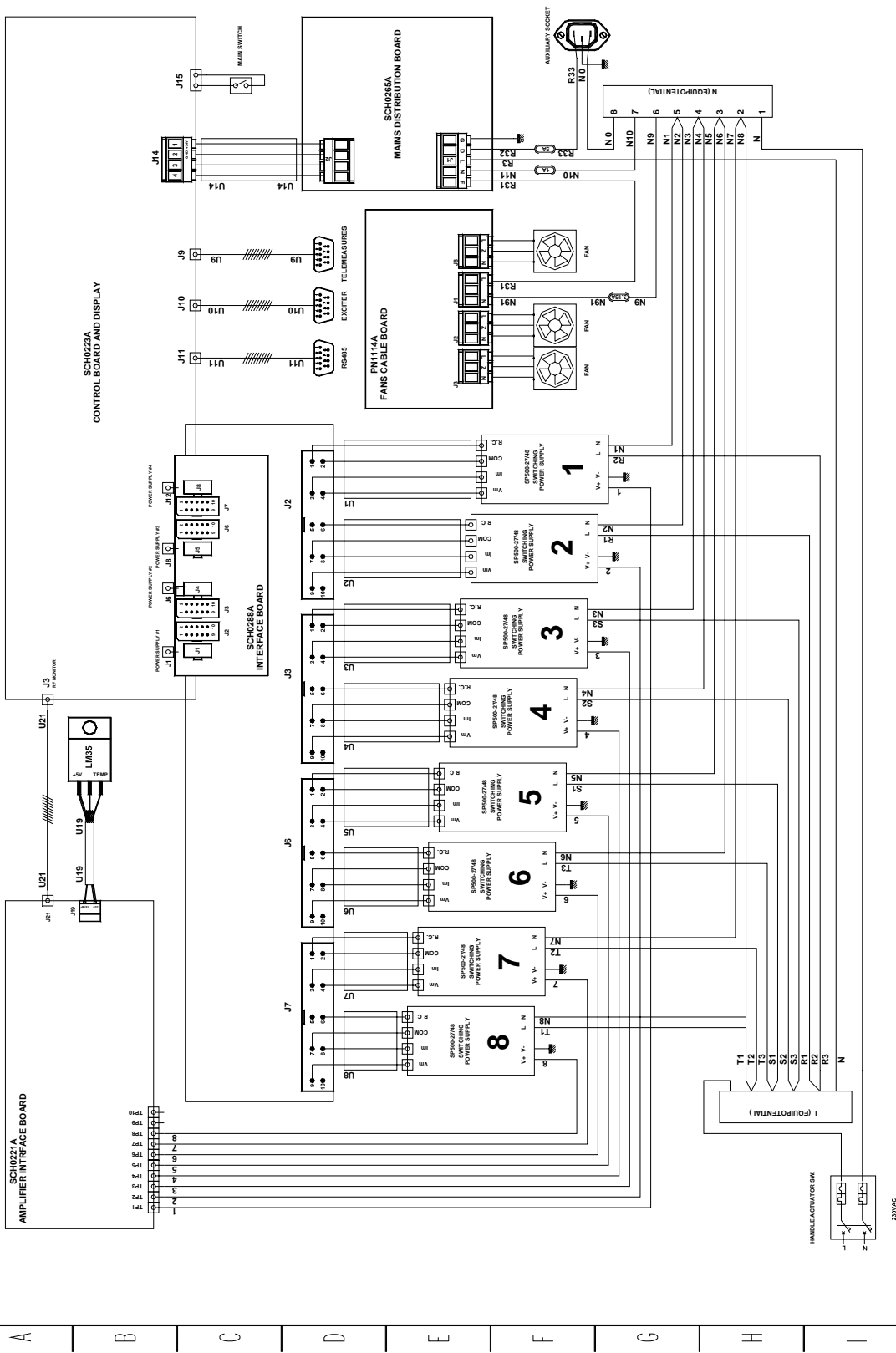

	CABLE DIAGRAM		DESIGNER COLASUONNO	SIGNATURE	DATE 10/02/05
	ASSEMBLY CODE APT144	TITLE AUTV/1500LD LDMOS UHF TV AMPLIFIER 1 PHASE POWER SUPPLY	PCB DESIGNER COLASUONNO	SIGNATURE	PCB REF APT144

0 1 2 3 4 5 6 7 8 9

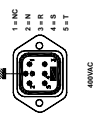
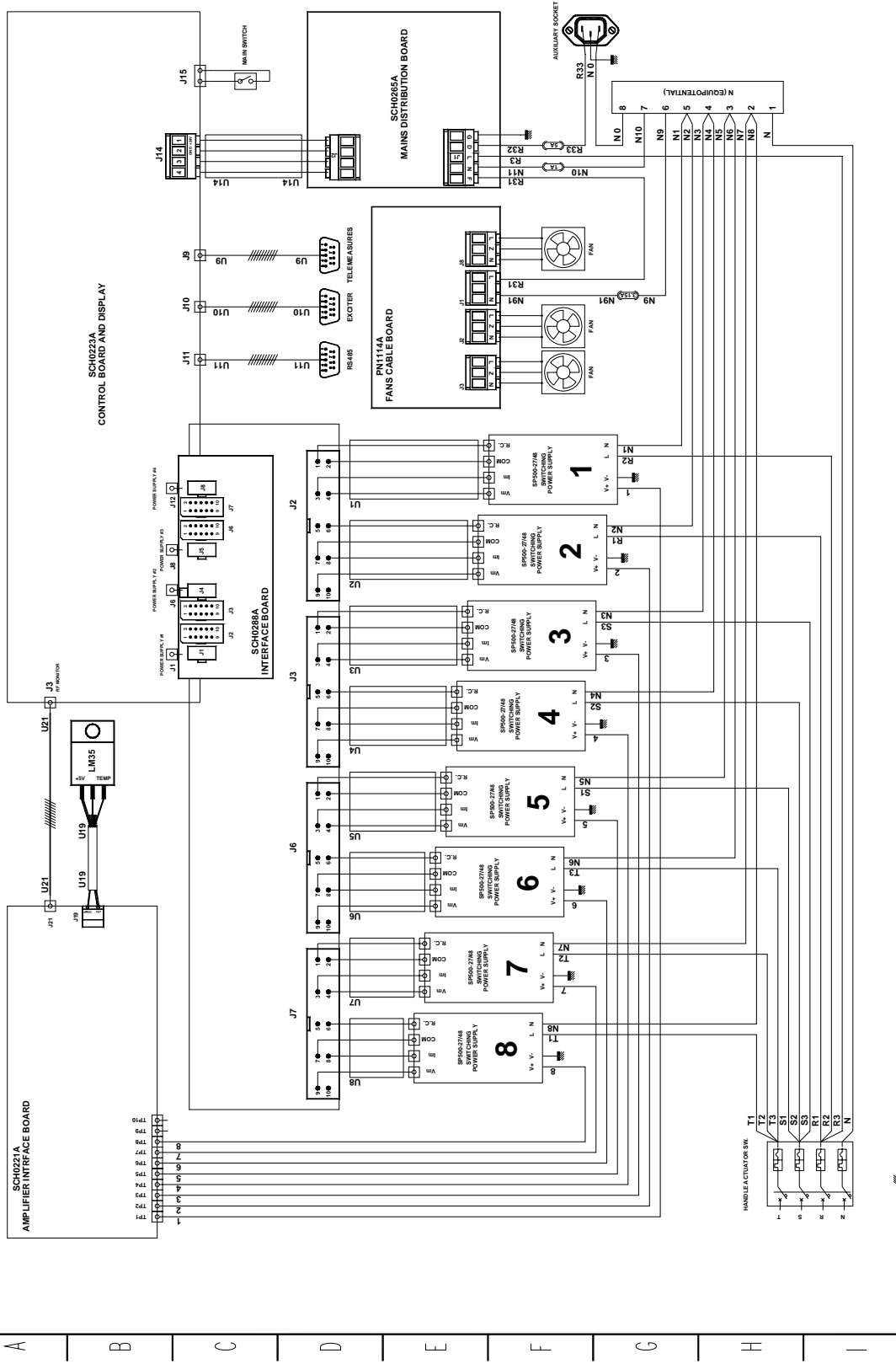

ASSEMBLY CODE	AP1144	DESIGNER	COLASUONNO	SIGNATURE	DATE	10/02/05
TITLE	AUTV/1500LD LDMOS UHF TV AMPLIFIER 3 PHASE POWER SUPPLY	PCB DESIGNER	COLASUONNO	SIGNATURE	PCB REF	AP1144
					SHEET	2/2

Component list**APT144C_APT144CM**

Elettronika Code	Description	Qty	Page 1/2
00664	LM35DT THERMAL SENSOR	1	
01041	1nF 50V CERAMIC CAPACITOR	2	
02228	N FEMALE CONNECTOR	1	(APT144CM)
02502	SMA SOCKET FOR RG58	1	
02695	DB9 CONNECTOR FOR IU008059 CABLE	3	
02699	FEMALE 10WIRE CONNECTOR	9	
02700	FEMALE 16WIRE CONNECTOR	1	
02830	10A GREEN PLUG	1	
02876	5 POLES 16A ILME AC SOCKET	1	(APT144CM)
02877	5 POLES 16A ILME SOCKET PANEL MOUNTING	1	(APT144CM)
02893	3 WAY MALE EXTRACTABLE TERMINAL BLOCK	4	(APT144CM)
02894	3 WAY FEMALE EXTRACTABLE TERMINAL BLOCK	4	(APT144CM)
05064	FERRITE	8	(APT144CM)
05553B	5-6U HANDLE KIT	2	
07515C	4x16A AUTOMATIC SWITCH	1	(APT144C)
07524A	SWITCH	1	
07541	10A FUSE-HOLDER PANEL MOUNTING	3	
07605C	FAN	3	
07605D	1.5uF 400V CAPACITOR	3	
07605F	GRID FAN	6	
07925	PVC PROTECTION	1	
08503	RG 303 50W TEFLON CABLE	1.20	
09419	PN419/A PRINTED CIRCUIT BOARD	1	
CON0245	CON0245R1 MECHANICAL DETAIL	1	
CON0249	CON0249R0 MECHANICAL DETAIL	1	
CON0276	CON0276R3 MECHANICAL DETAIL	1	
CON0277	CON0277R3 MECHANICAL DETAIL	1	
CON0280	CON0280R2 MECHANICAL DETAIL	1	
C0205	MULTIPOLES WIRE	3.00	
DET0516	DET0516R0 MECHANICAL DETAIL	1	
DET0575	DET0575R1 MECHANICAL DETAIL	8	
DET0772	DET0772R0 MECHANICAL DETAIL	2	
DET0798	DET0798R0 MECHANICAL DETAIL	6	
DET0996	DET0996R0 MECHANICAL DETAIL	1	
DET1022	DET1022R0 MECHANICAL DETAIL	1	
DET1054I	DET1054R1 MECHANICAL DETAIL	2	
DET1185	DET1185R1 MECHANICAL DETAIL	2	
E0012	SP-500-27 DE2 SWITCHING POWER SUPPLY	8	
FUS1A	1A FUSE	1	
FUS3A	3.15A FUSE	1	
FUS5A	5A FUSE	1	
MTF0070CR0	LDMOS UHF AMPLIFIER MODULE	1	
PAN0074	PAN0074AR2 FRONT PANEL	1	
PN1114A	PN1114AR1 PRINTED CIRCUIT BOARD	1	
R0012	18mm DIAMETER WHEEL	8	

Electronika Code	Description	Qty	Page 2/2
SCH0223AR1	CONTROL BOARD AND DISPLAY	1	
SCH0265AR0	MAINS DISTRIBUTION BOARD	1	
SCH0288AR1	POWER SUPPLY INTERFACE BOARD	1	
V0760	BLACK PLASTIC TAP	1	(APT144CM)
V0962	TERMINAL BLOCK	3	(APT144CM)
Z0021	MECHANICAL DETAIL	2	
Z0081	MECHANICAL DETAIL	1	
Z0673	COVER	1	

Component list**APT144DM_APT144DM/DIG**

Elettronika Code	Description	Qty
02029	UG909 CONNECTOR FOR RG 58 CABLE	1
02410	7/16" CONNECTOR FOR 1/2" CABLE	1
02450	EIA 7/8" CONNECTOR FOR 1/2" CABLE	1
02458	EIA 7/8" INNER	1
02502	SMA SOCKET FOR RG58 CABLE	1
02791	DB9 MALE SOCKET PANEL MOUNTING	5 (APT144DM) 2 (APT144DM/DIG)
02871	DB9 SHELL	5 (APT144DM) 2 (APT144DM/DIG)
06674	UHF ATV BANDPASS FILTER	1 (APT144DM)
06676A	UHF DTV BANDPASS FILTER	1 (APT144DM/DIG)
07595	FAN	1
07595A	6uF CAPACITOR	1
07595B	GRID	1
07596	GRID	1
08504	RG 58 50Ω CABLE	1.00
08515C	1/2" CABLE	1.00
APT144CM	AUTV/1500LD LDMOS UHF TV AMPLIFIER	1
CMS6006	1m 1/2" CABLE FOR 7/16" MALE CONNECTOR	1
CSS5011	1.5m RG 58 CABLE FOR N - N MALE CONNECTOR	1
DET0434	DET0434R2 MECHANICAL DETAIL	1
DET0536	DET0536R3 MECHANICAL DETAIL	2 (APT144DM)
DET0564	DET0564R0 MECHANICAL DETAIL	1
DET0565	DET0565R0 MECHANICAL DETAIL	1
DET1028	DET1028R0 MECHANICAL DETAIL	2 (APT144DM/DIG)
DET1051	DET1051R0 MECHANICAL DETAIL	2 (APT144DM)
DET1069	DET1069R0 MECHANICAL DETAIL	2 (APT144DM)
PAN0080	PAN0080R0 1U FRONT PANEL	1 (APT144DM)
PAN0081	PAN0081R0 2U FRONT PANEL	1 (APT144DM) 2 (APT144DM/DIG)
PAN0082	PAN0082R0 3U FRONT PANEL	3 (APT144DM) 2 (APT144DM/DIG)
R0159	20U RACK	1
Z0114	MECHANICAL DETAIL	1
Z0500	MECHANICAL DETAIL	8

DESCRIPTION

The Control Board SCH0223A manages the operational logic of the amplifier: switching on and off, power supply and fans, alarms and protections, remote control, human-machine interface. All of that is performed by a modern and powerful 16 bit micro-controller, which is the main part of the board.

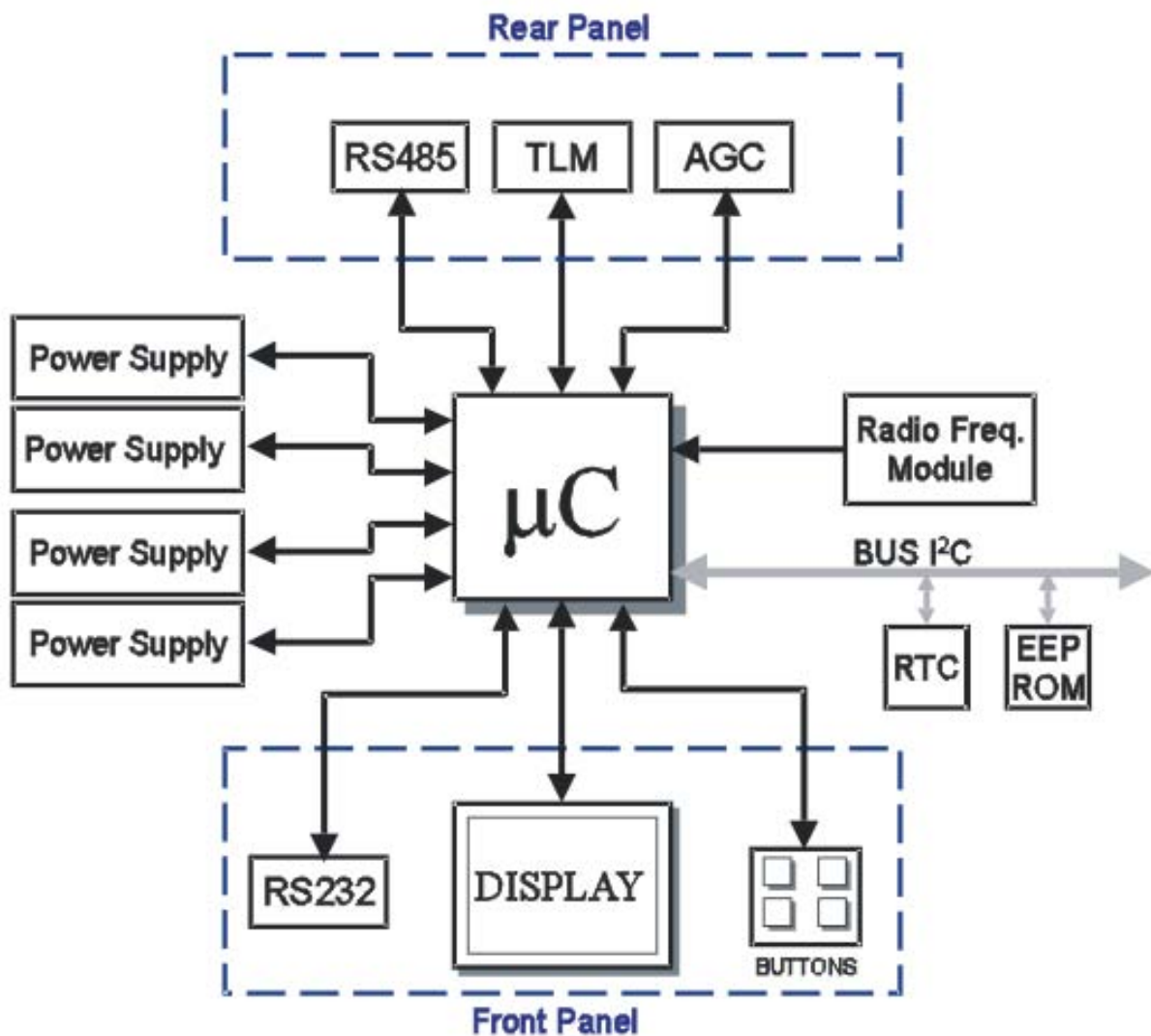

Figure 1: Simplified block diagram of the control and display board

It can be seen that the micro-controller is the heart of the control system, to which the various peripherals (power supply, serial ports, telemeasure socket, AGC port, RF amplifier module, ROM, clock, display and keys) are interfaced.

- Power Supply

The board is powered with a continuous +24V voltage applied on the J14 connector. From that the +5V voltage, powering the most of the chips (micro-controller, operational amplifiers, display, etc.) is derived by means of a switching converter (see IC19). A +12Vdc voltage is obtained from it as well, by means of a linear conversion provided by the integrated circuit IC8. From this, a -12Vdc voltage is obtained by means of the integrated circuit IC5. The -12V voltage is used to adjust the contrast of the display.

- Connectors

On the board SCH0223A there are several connectors used as interfaces for the peripherals of the apparatus and the ports for external communication.

POWER SUPPLY

The connectors J1, J6, J8 e J12 are used to connect the power supply powering the RF modules. The number of power supply used changes depending on the amplifier, up to eight power supply. They are connected in the order shown in Table 1 below. Remaining connectors, if any, are left unconnected.

CONNECTOR	POWER SUPPLY N°
J1	1 - 2
J6	3 - 4
J8	5 - 6
J12	7 - 8

Table 1: Interface connectors for the power supply

Through this connection, each power supply provides the level of voltage and current acquired by the micro-controller by means of an internal ADC. Besides the connectors allow the control board to turn on or off the individual power supply (for instance when an alarm occurs).

RF AMPLIFICATION

The J3 connector interfaces the control board with the RF amplification section. Through this connector the

micro-controller acquires the forward and reflected powers, unbalancing (if any), and temperature of the critic amplification area. It also allows to inhibit the transistors in case of reflected power alarm, by means of a totally hardware, thus extremely fast protection.

Depending on the apparatus, this connector may also allow to enable or disable the cooling fans of the critic area.

RS485

The J11 connector (10 pin socket) is directly wired to a DB9 female connector placed on the rear panel of the apparatus. This communication bus allows to connect the amplifier to the control (Amplifier Control) module of a high-power transmitter composed by several individual amplifiers. In this case, each amplifier and the Amplifier Control are connected to the same 4-wires RS485 bus and each of them has a unique address (which can be set by means of the keys and the display) for correct communication.

In case of single (stand-alone) amplifier, the RS485 connector can be used to interface to the Remote Control Unit (RCU) made by Elettronika S.r.l. This unit allows to monitor and control the remote transmitter from any site provided with PSTN or GSM¹ phone connection.

Table 2 shows the wiring between the J11 connector on the board and the DB9 female connector on the rear panel, along with the description of the lines.

PIN N° ON DB9	PIN N° ON J11	DESCRIPTION
1	1	Not used
2	3	Rx-
3	5	Rx+
4	7	+5V
5	9	GND
6	2	Not used
7	4	Tx-
8	6	Tx+
9	8	Not used

Table 2: Description of the RS485 connector

¹ For more details about the control system contact the distributor or the manufacturer.

TELEMEASURES

The J9 telemeasure connector (10 pins socket) is directly wired on a DB9 female connector placed on the rear panel. There are input and output digital lines (TTL level) and analog output lines on this connector, which are used to monitor and control the amplifier by means of a general-purpose remote control system.

The correspondence between the pins of the J9 connector on the board and the DB9 female connector on the rear panel, as well as the meaning of the various lines, is shown in table 3 below (the directions are in respect to the micro-controller on the board).

PIN N° ON DB9	PIN N° ON J9	TYPE	DIRECTION	DESCRIPTION
1	1	Analog	Output	Forward power (*)
2	3	Analog	Output	Reflected power (*)
3	5	Analog	Output	Temperature
4	7	Digital	Input	Interlock: 0V = Interlock Alarm 5V = Normal
5	9	-	-	Ground
6-7	2-4	Digital	Output	Free Contact (closed when amplifier is in alarm)
8	6	Digital	Input	Turning-on control (normally high, active when low)
9	8	Digital	Input	Turning-off control (normally high, active when low)

(*) You can select by means of two jumpers on the board (JP1 and JP2) RMS or peak power. If there are two jumpers on pins 1 and 2 of JP1 and JP2 connectors, RMS power is selected. Otherwise, if there are two jumpers on pins 2 and 3 of the same connectors, peak power is selected.

Table 3: Description of the telemeasures connector

The input stage of the digital pins has an internal pull-up towards the 5V power supply voltage. To use these lines it only takes setting a switch to close to earth. When closed, the relevant control (turning on or off) is enabled and the switch may be open again (impulse controls).

The interlock pin may be used as protection so that the amplifier is switched off when the digital input level is low. It is possible to use several serially connected switches to make an interlock chain. Usually all switches are closed and the interlock level is low, thus the amplifier is on. If even only one of the switches is open, the

level of the interlock signal becomes high (this line has a pull-up towards the +5V power supply voltage as well) and the interlock protection activates switching off the amplifier. Note that in case the interlock protection is not used, the pin 4 of the DB9 telemeasure connector and the earth pin (pin 5) must be short circuited. Otherwise it is possible to disable the monitoring of the interlock chain from menu (see user manual). Figure 2 shows a typical usage for the digital input signals to turn on and off the amplifier and for the interlock alarm.

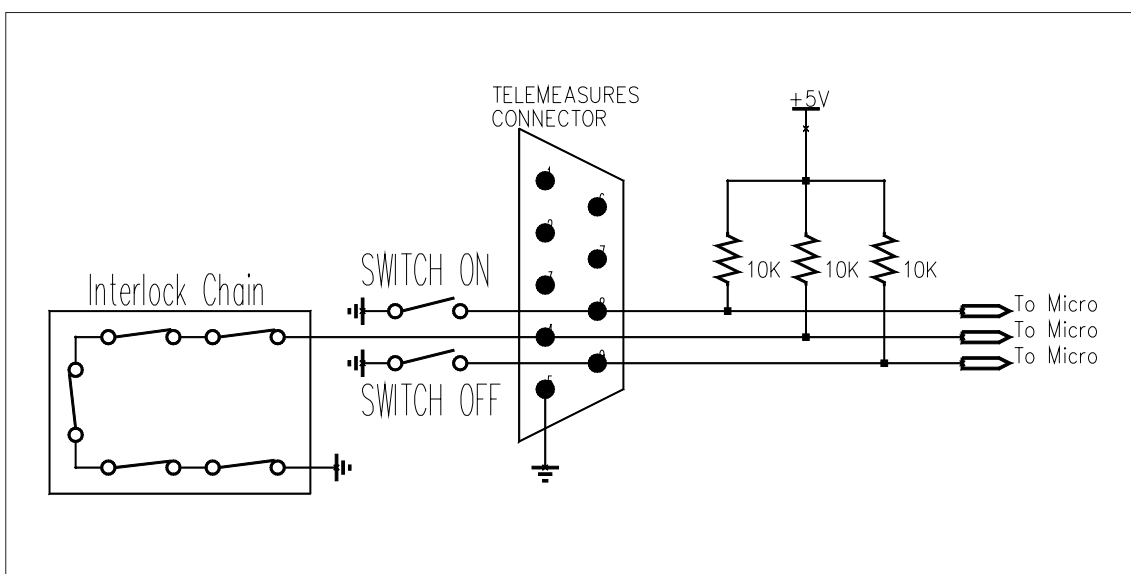

Figure 2: Usage of the digital input signals of the telemeasures connector

AGC / EXCITER

The connector called J10, as the telemeasures connector and the RS485 bus, is wired to a DB9 female connector placed on the rear panel of the amplifier. This connector allow the implementation of an automatic gain control between an exciter and the amplifier. A voltage signal related to the forward output power supplied by the amplifier is provided through two pins of the AGC connector. Connecting one of these to the relevant input pin of the exciter, this can pursuit a given voltage level, so that the output power is always constant. In order to avoid that, in case of an alarm decreasing the forward power, the exciter increases its output level due to the AGC, thus damaging the amplification stages, the connector is provided with two digital output lines called AGC Alarm. Under alarm conditions, this lines are brought by the micro-controller at a low level, so that the exciter can stop the AGC.

Table 4 shows the connection between the J10 connector on the board and the DB9 connector on the rear panel, along with the description of each pin (the direction of the pin is referred to the position of the micro-controller on the board).

PIN N° ON DB9	PIN N° ON J10	TYPE	DIRECTION	DESCRIPTION
1	1	-	-	Ground
2	3	Digital	Output	AGC Alarm 0V = Alarm 5V = Normal
3	5	Digital	Output	AGC Alarm 0V = Alarm 5V = Normal
4	7	-	-	Not used
5	9	-	-	Not used
6	2	-	-	Not used
7	4	-	-	Not used
8	6	Analog	Output	Forward power
9	8	Analog	Output	Forward power

Table 4: Description of the AGC connector

RS232

The DB9 female connector on the front panel is an external communication RS232 serial port, through which a PC can be connected directly to the amplifier in order to perform operations such as the remote control (by means of an adequate software²) and the update of the microcontroller firmware.

The used communication protocol is asynchronous, at a 19200bps speed, 1 start bit, 8 data bits, 1 stop bit, no parity. No hardware flow control is used. The connector is DCE type and the pin used are shown in Table 5.

PIN N° ON DB9	1	2	3	4	5	6	7	8	9
DESCRIPTION	-	TxD	RxD	-	GND	-	-	-	-

Table 5: Description of the RS232 connector

MISCELLANEOUS

The J2 (called AUX), J4, J5 and J17 connectors are not used and are there only for future updates. The SW1 dip-switches are partially used for the configuration of the correct mode for the micro-controller. The other switches are not used. It is important that the position of the dip-switches is left unchanged, because changing it may set a wrong mode for the micro-controller, affecting the work of the whole amplifier.

² For more information about this application contact the distributor of the manufacturer.

SCH0223AR1 Top layer Component layout

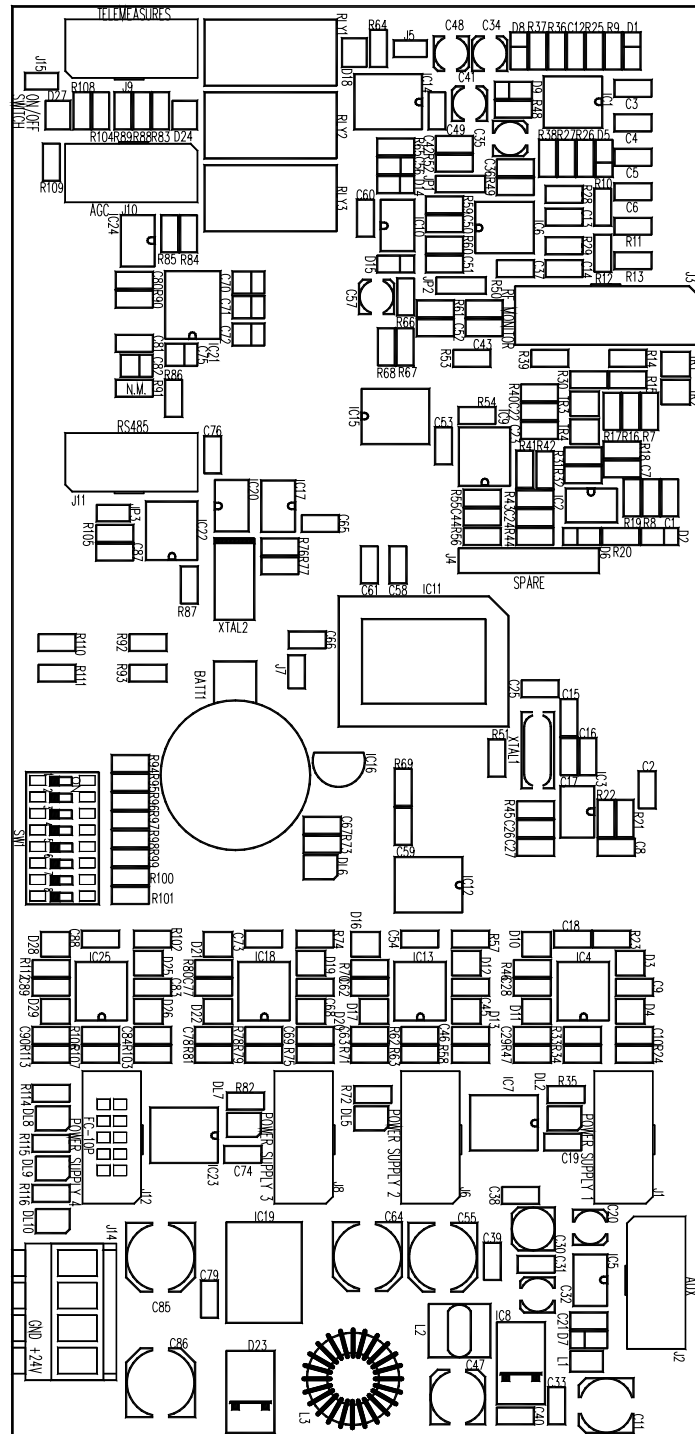

SCH0223AR1 Bottom layer Component layout

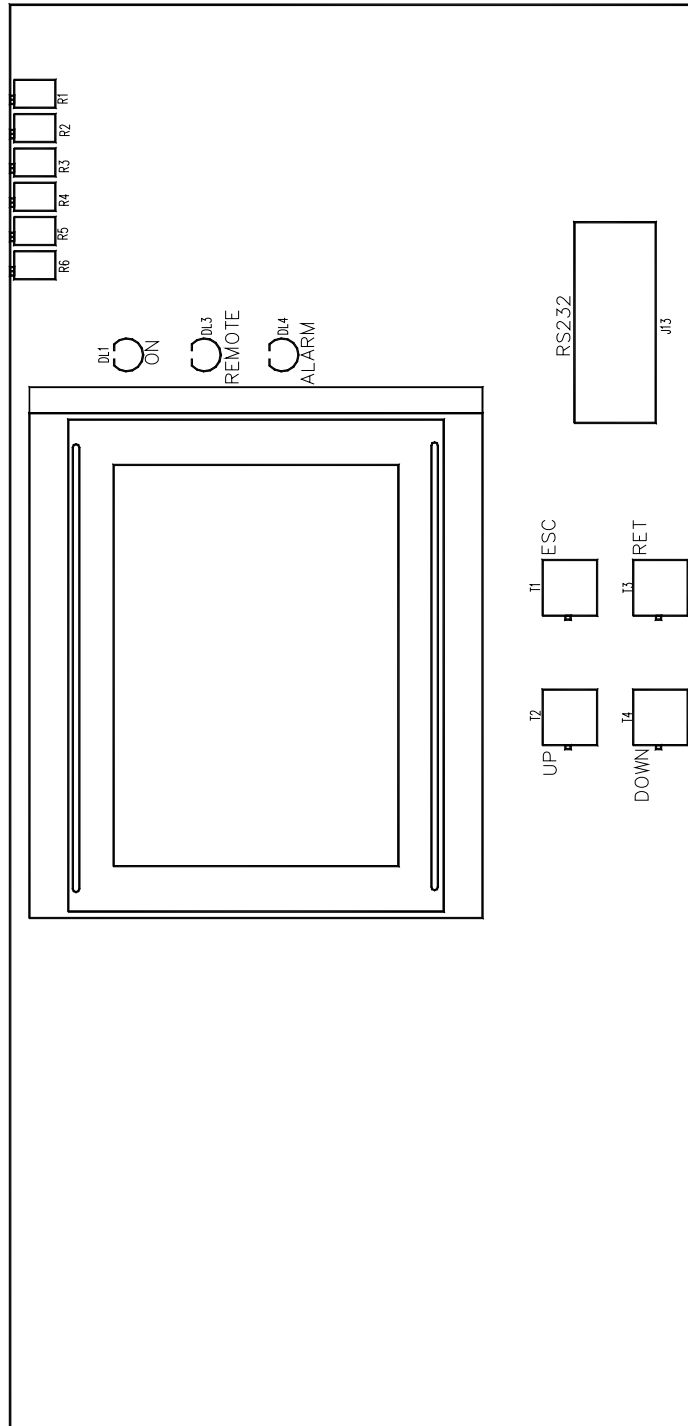

SCH0223ARI COMPONENT LIST

Part Name/Number	Description	Qty.	Comps.	Page 1/2
BATT BH001RB 3093_90	03093 03090 BATTERY HOLDER	1	BATT1	
CC 100nF-S 01065C	01065C Y5V 1206 CAPACITOR	46	C2, C7-10, C12, C16, C19, C21-27, C29, C31, C33, C37-40, C44-46, C49, C58-61, C63, C65, C66-69, C74, C76, C78-81, C83-84, C87, C90	
CC 15pF-S 01088	01088 SMD 1206 CAPACITOR	4	C13-15, C17	
CC 1nF-S 01096	01096 SMD 1206 CAPACITOR	7	C3-6, C50-51, C53	
CC 1uF100V-S 01760A	01760A 1206 50V CAPACITOR	11	C1, C18, C28, C36, C43, C54, C62, C73, C77, C88-89	
CC 47pF-S 01100	01100 SMD 1206 CAPACITOR	2	C42, C52	
CE 100uF25V-S 01793B	01793B ELET. SMD CAPACITOR	2	C11, C47	
CE 10uF16V-S	01626B TANT. ELET. SMD CAP.	2	C56-57	
CE 10uF35V-S 01778A	01778A ELET. SMD CAPACITOR	2	C20, C32	
CE 1uF35V-S 01613A	01613A TANT. ELET. SMD CAP.	5	C70-72, C75, C82	
CE 220uF50V LOW ESR	01799A ELET. SMD CAPACITOR	4	C55, C64, C85-86	
CE 22uF16V-S	01780A ELET. SMD CAPACITOR	4	C34-35, C41, C48	
CE 47uF35V-S 01790A	01790A ELET. SMD CAPACITOR	1	C30	
D 1N4148-S 03002	03002 SMD DIODE	7	D1-2, D5-9	
D 50WQ06FN	03019A SMD DIODE SCHOT. 5.5A	1	D23	
D BAS85-S	03024 SMD DIODE SCHOTTKY	2	D14-15	
D BAT54S	03199 SMD SCHOTTKY DIODE	19	D3-4, D10-13, D16-22, D24-29	
DIS MGLS12864T	03083A 128x64 DOT	1	DIS1	
DL KA-3528SGC 03057	03057 GREEN SMD LED DIODE	7	DL2, DL5-10	
DL LEDG5 03060	03060 GREEN LED DIODE 5mm	1	DL1	
DL LEDR5 03061	03061 RED LED DIODE 5mm	1	DL4	
DL LEDY5 03054B	03054B YELLOW LED DIODE 5mm	1	DL3	
IC 24LC64 04815	04815 SMD INTEG CIRCUIT	1	IC17	
IC 78M12 4307B	04307B SMD VOLTAGE REGUL.	1	IC8	
IC CD4051BM-S	04615 SMD INTEG CIRCUIT	3	IC7, IC14, IC23	
IC LM2596S-5.0	04580 SMD INTEG CIRCUIT	1	IC19	
IC LM358M-S 04660	04660 SMD INTEG CIRCUIT	1	IC3	
IC LM393-S 04639	04639 SMD INTEG CIRCUIT	1	IC2	
IC LMC6482-S	04632 SMD INTEG CIRCUIT	1	IC24	
IC LMC6484-S	04634 SMD INTEG CIRCUIT	7	IC1, IC4, IC6, IC9, IC13, IC18, IC25	
IC M41T56 04611	04611 SMD INTEG CIRCUIT	1	IC20	
IC MAX232-S 04804B	04804B SMD INTEG CIRCUIT	1	IC21	
IC MAX3080-S 04770	04770 SMD INTEG CIRCUIT	1	IC22	
IC MAX942CSA-S	04572 SMD INTEG CIRCUIT	1	IC10	
IC MB90F543PF	04596 SMD INTEG CIRCUIT	1	IC11	
IC MPC100-450DI-TO	04608 INTEG CIRCUIT	1	IC16	
IC TC7662BCOA 04758A	04758A SMD INTEG CIRCUIT	1	IC5	
IC ULN2003A 4870	04870 SMD INTEG CIRCUIT	2	IC12, IC15	
IND 2u2H-S 05020A	05020A INDUCTOR	1	L1	
IND MS85 10uH-S	04948 2.7A INDUCTOR	1	L2	

Part Name/Number	Description	Qty.	Comps.
IND T100uH-1.8A 4958	04958 TOROIDAL-STORAGE	1	L3
J CON HD515V/05-4PVE	02881+02882 PANDUIT PCB CON.	1	J14
J DB9_F-0° LT	02794 PCB CONNECTOR DB9	1	J13
J FC-10P 02697-02699	02697+02699 PCB CONNECTOR	8	J1-2, J6, J8-12
J FC-16P 02701-02700	02701+02700 PCB CONNECTOR	1	J3
J PAN2 02739	02739 PCB CONNECTOR	2	J5, J7
J PAN2 02739-40-41	02739+02740+02741 PCB CONNEC.	1	J15
J PAN8 02716	02716 PCB CONNECTOR	1	J4
JU JUMP2 02739-02742	02739+02742 PAN2 MALE	1	JP3
JU JUMP3 02707-02742	02707+02742 PAN3 MALE	2	JP1-2
R 100K-1%-S 00065B	00065B RES 1/4W 1% SMD 1206	16	R33-34, R62-63, R78-79, R94-101, R106-107
R 100R-1%-S 00029D	00029D RES 1/4W 1% SMD 1206	12	R24, R47, R58, R71, R75, R81, R83, R89, R103-105, R113
R 10K-1%-S 00053B	00053B RES 1/4W 1% SMD 1206	24	R7, R10, R12, R14-16, R22, R25, R27, R30, R36, R38, R51, R64, R84-85, R87-88, R92, R93, R108-111
R 10R-S 00017A	00017A RES 1/4W 5% SMD 1206	1	R68
R 1206 N. M.	N. M. RES 1/4W 5% SMD 1206	1	R91
R 1K0-1%-S 00041B	00041B RES 1/4W 1% SMD 1206	8	R17, R54, R59-60, R76-77, R86, R90
R 22K-1%-S 00057B	00057B RES 1/4W 1% SMD 1206	11	R9, R21, R26, R28-29, R37, R45, R48-50, R69
R 2K2-1%-S 00045B	00045B RES 1/4W 1% SMD 1206	3	R52, R55, R61
R 330K-1%-S 00071D	00071D RES 1/4W 1% SMD 1206	1	R66
R 330K-S 00071A	00071A RES 1/4W 5% SMD 1206	1	R65
R 470K-S 00073A	00073A RES 1/4W 5% SMD 1206	11	R8, R23, R40, R42, R46, R57, R70, R74, R80, R102, R112
R 470R-1%-S 00037B	00037B RES 1/4W 1% SMD 1206	6	R11, R13, R39, R53, R56, R67
R 4K7-1%-S 00049B	00049B RES 1/4W 1% SMD 1206	3	R18, R31, R43
R 68K-1%-S 00063B	00063B RES 1/4W 1% SMD 1206	4	R19-20, R32, R44
R 820R-S 00040A	00040A RES 1/4W 5% SMD 1206	7	R35, R72-73, R82, R114-116
R 8K2-1%-S 00052B	00052B RES 1/4W 1% SMD 1206	1	R41
RL 30.22.24 07569	07569 RELE	3	RLY1-3
RV 1M-3266X	00815 VARIABLE RESISTOR	6	R1-6
SW SWITCH-8DIP	07530A PCB DIP SWITCH SMD	1	SW1
T 06086 N 7630 7632	7630 7632 KTI06086 2 WAY KEY	4	T1-4
TR BC848 03457	03457 NPN SMD TRANSISTOR	2	TR1-2
TR BC856 03455	03455 PNP SMD TRANSISTOR	2	TR3-4
XTAL 32.768k-S 05146	05146 QUARTZ	1	XTAL2
XTAL 4MHz-S 05101A	05101A QUARTZ	1	XTAL1

SCH0265AR0 Component layout

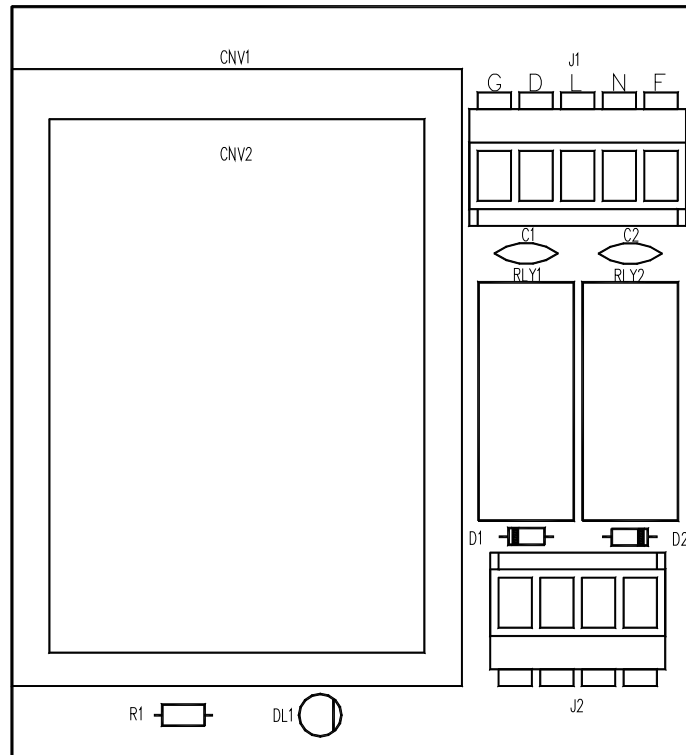

SCH0265AR0 COMPONENT LIST

Part Name/Number	Description	Qty.	Comps.
CC 2nF2 2kV 01045A	01045A CERAMIC CAPACITOR	2	C1-2
CNV AC-DC ATC-12S	E0037 AC DC CONVERTER	1	CNV1
D 1N4148 03001	03001 DIODE	2	D1-2
DL LEDG3 03053	03053 GREEN LED DIODE 3mm	1	DL1
J CON HD515V/05-4PVE	02881+02882 PANDUIT PCB CON.	1	J2
J CON HD515V/05-5PVE	02895+02896 PANDUIT PCB CON.	1	J1
R 2K7 0046	0046 RES 1/4W 5%	1	R1
RL 40.31.24	7567C RELE	2	RLY1-2

SCH0288ARI Component layout

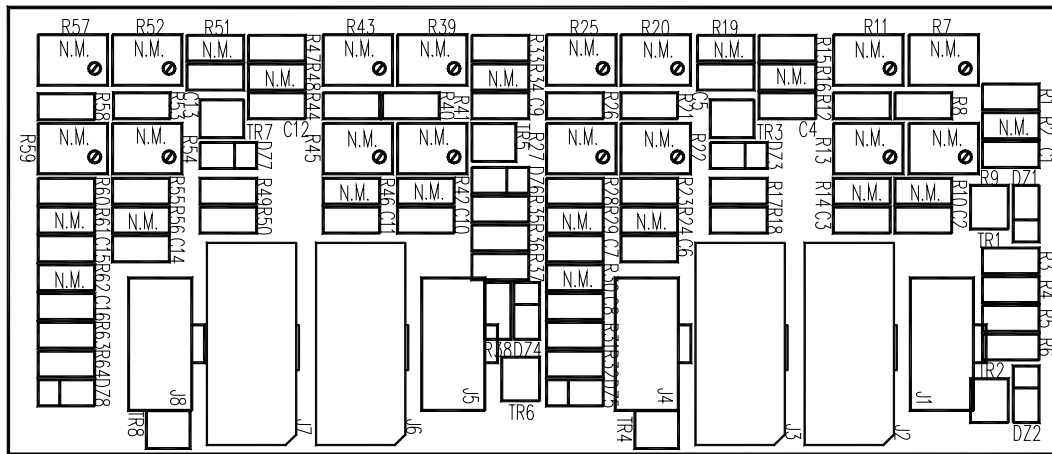

SCH0288ARI COMPONENT LIST

Part Name/Number	Description	Qty.	Comps.
CC 1nF-S 01096	01096 SMD 1206 CAPACITOR	16	C1-16
DZ 5V1-S 03128	03128 SMD ZENER DIODE	8	DZ1-8
JFC-10P 02697-02699	02697+02699 PCB CONNECTOR	4	J2-3, J6-7
JFC-10P PCB FEMALE	02706 PCB FEM. CONNECTOR	4	J1, J4-5, J8
R 0R0-S 00001	00001 RES 1/4W 5% SMD 1206	16	R1, R8, R12, R15, R21, R23, R26, R28, R33, R40, R44, R47, R53, R55, R58, R60
R 100K-1%-S 00065B	00065B RES 1/4W 1% SMD 1206	8	R3, R6, R17, R32, R35, R38, R49, R64
R 1206 N. M.	N. M. RES 1/4W 5% SMD 1206	16	R2, R10, R14, R16, R19, R24, R29-30, R34, R42, R46, R48, R51, R56, R61-62
R 8K2-1%-S 00052B	00052B RES 1/4W 1% SMD 1206	8	R4-5, R18, R31, R36-37, R50, R63
RV 3266W N. M.	N. M. VARIABLE RESISTOR	16	R7, R9, R11, R13, R20, R22, R25, R27, R39, R41, R43, R45, R52, R54, R57, R59
TR BC847 03456	03456 NPN SMD TRANSISTOR	8	TR1-8

DESCRIPTION

The MTF0070C is the RF Amplifier module of the AUTV/1500LD based on LDMOS technology. The RF Amplifier module is composed by eight broadband amplifier boards (SCH0192A) coupled together by means of Wilkinson combiners, driven by means another amplifier board. The module also includes the cooling heatsink and a small Interface board (SCH0221A) which forwards power supply to the two stages, groups the power and temperature into a single connector, more easily managed inside the transmitter. The driver stage of the amplifier module is provided with a Gate control to inhibit the output power.

TECHNICAL CHARACTERISTICS

Frequency Range	470 - 860MHz
Output Power	1300W
Gain	23dB (± 2)
Driver Stage Quiescent Current (cold)	4A (2A for each transistor to 32V)
Amplifier Stage Quiescent Current (cold)	2A (1A for each transistor to 32V)
RF Input Impedance	50 Ω
RF Output Connector / Impedance	7/16" Female / 50 Ω

MTF0070CR0 COMPONENT LIST

Elettronika Code	Description	Qty
00001	0 Ω 1206 SMD RESISTOR	2
00221B	75 Ω 1206 SMD RESISTOR	2
01041D	1nF 1206 SMD CERAMIC CAPACITOR	2
01400	BYPASSING CAPACITOR	13
01408	BYPASSING CAPACITOR	2
02402	7/16" FEMALE CONNECTOR	1
02512	SMA SOCKET PANEL MOUNTING	1
03017	MBR3045PT DIODE	4
03207	HSMS2802 DIODE	2
08502	RG 316 50 Ω CABLE	3.00
08527	HF-85 ENDIFORM CABLE	0.20
PN0998A	PN0998AR1 BIAS ADDER PCB	2
PN1091A	PN1091AR3 UHF DIRECTIONAL COUPLER PCB	1
SCH0192AR0	200W LDMOS UHF AMPLIFIER MODULE	9
SCH0221AR0	AMPLIFIER INTERFACE BOARD	1
SCH0248AR0	8 INPUTS WILKINSON PCB	1
SCH0249AR0	4 WAY WILKINSON PCB	1
SCH0250AR0	4 WAY WILKINSON PCB	1
SCH0251AR0	2 WAY WILKINSON PCB	1
SCH0252AR0	UHF INPUT COUPLER	1

0 1 2 3 4 5 6 7 8 9

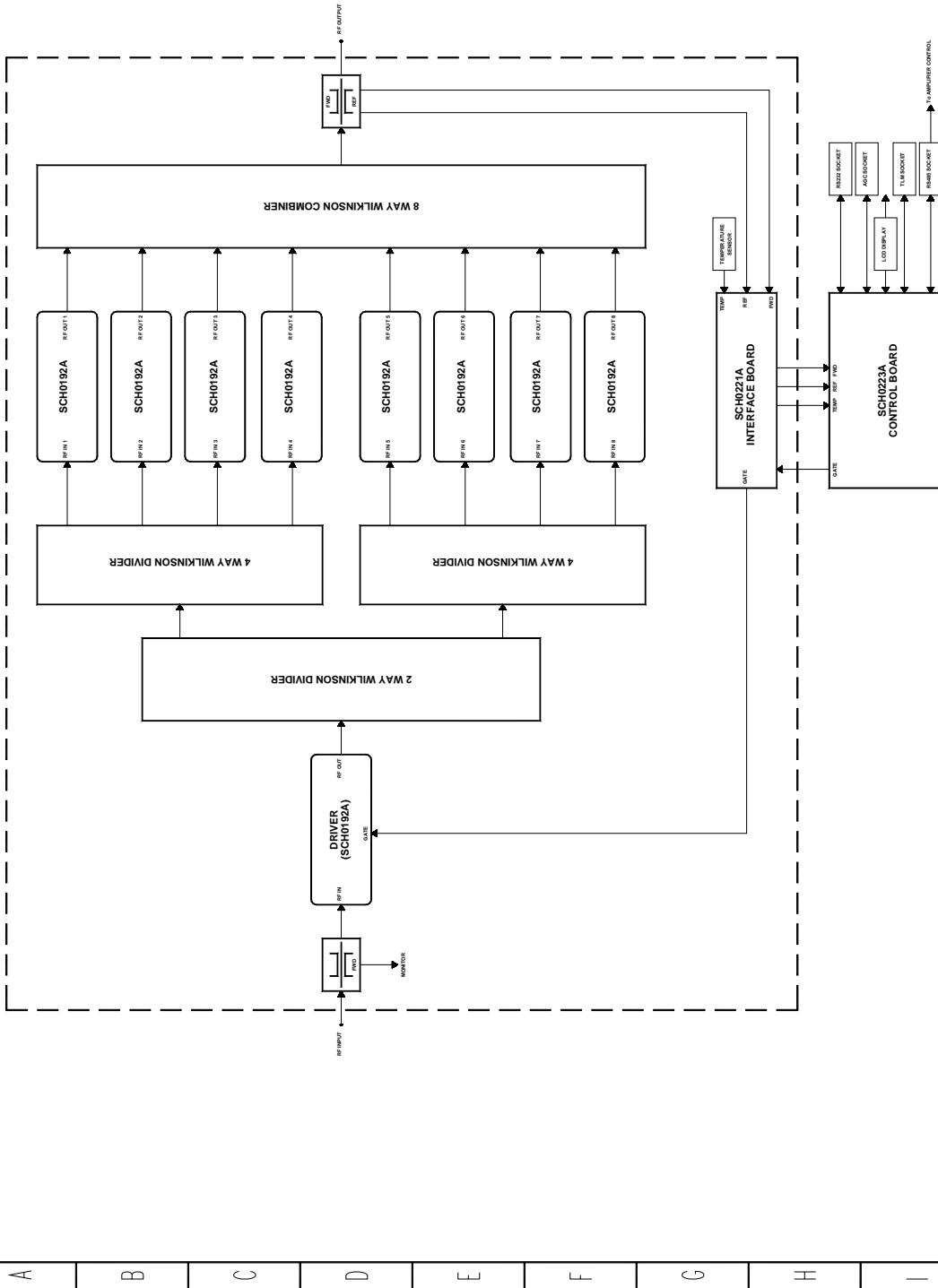

	BLOCK DIAGRAM	DESIGNER	SIGNATURE	DATE
		LATTANZIO	LATTANZIO	15/11/07
ASSEMBLY CODE	TITLE	PCB DESIGNER	SIGNATURE	PCB REF
MTF0070C	LD MOS UHF AMPLIFIER MODULE	LATTANZIO		MTF0070C0
				SHEET
				1/1

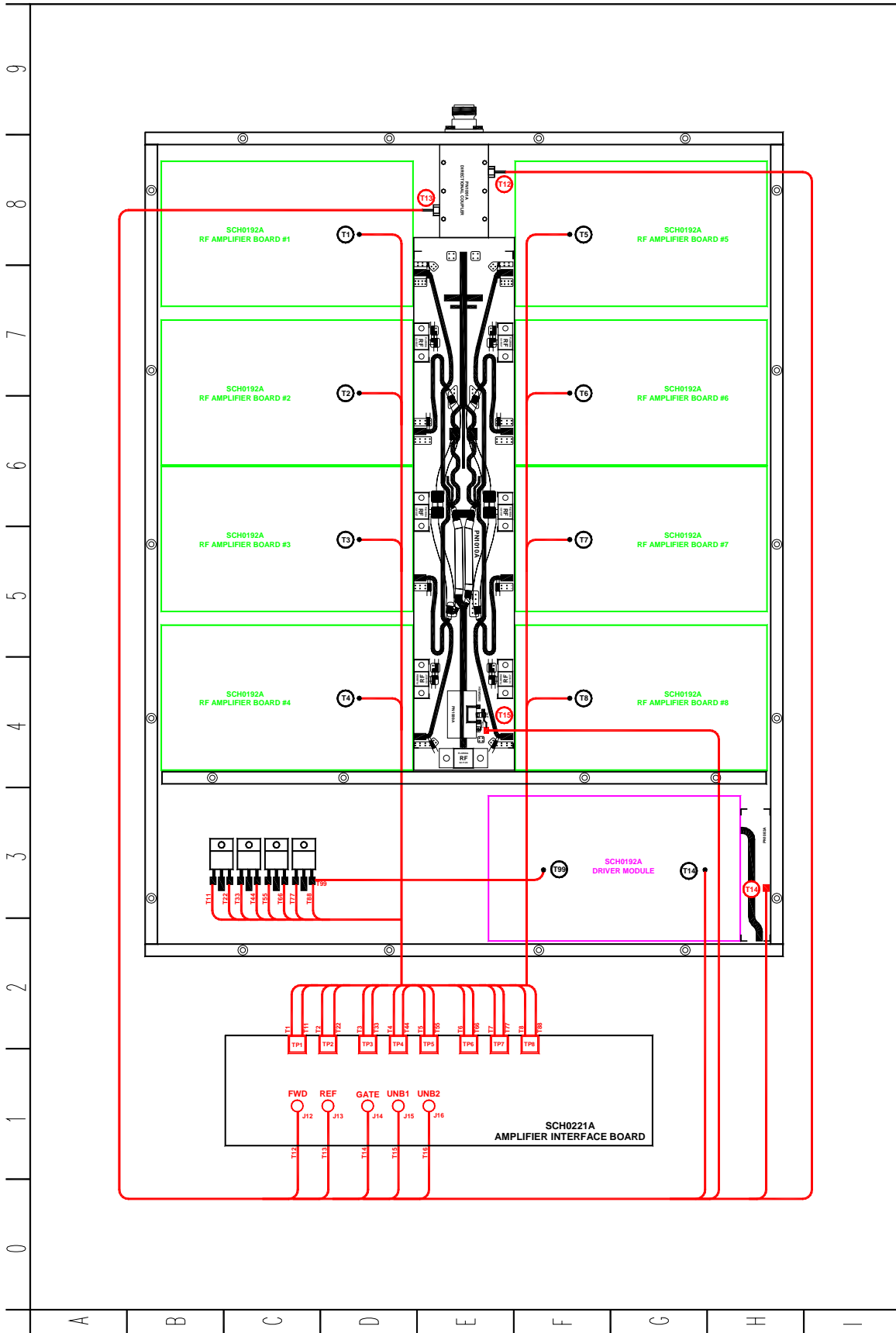

	COMPONENT LAYOUT		DATE	15/11/07
	DESIGNER	LATTANZIO	PCB REF	MTF0070C0
ASSEMBLY CODE	LDMS UHF AMPLIFIER MODULE	PCB DESIGNER	SHEET	1/1
MTF0070C	RF SECTION	LATTANZIO		

DESCRIPTION

The RF module is an integrated TV linear amplifier designed for UHF band, this module employs push-pull LDMOS technology in order to achieve very good efficiency, high linearity and reliability.

LDMOS transistors operate in AB class. It is a wideband amplifier over the full frequency, no adjustment is required for the channel change. The board includes RF section amplifier, bias circuit, protection circuit and matching networks. A silver plated copper plate is brazed with PCB in order to obtain low thermal resistance. Providing a minimum of 200W Pk sync linear power, this module is the perfect amplifier for any broadband UHF power transmitter.

TECHNICAL CHARACTERISTICS

Frequency Range	470 - 860MHz
Output Power	200W PEP
Gain	14dB (± 1)
Output LDMOS Power Supply	32V ($\pm 2\%$)
Output LDMOS Bias Current @ +32V Vdd	1A
RF Input Impedance	50 Ω
RF Output Impedance	50 Ω

Curve response graphic

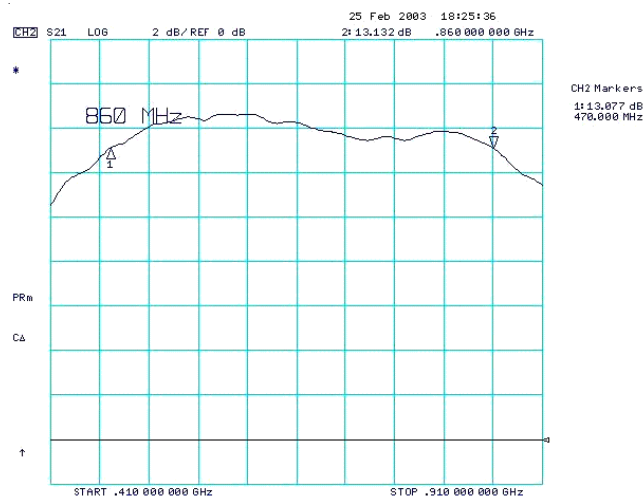

Middle frequency 660MHz, span 500MHz, 2dB/div., reference to the arrow

CALIBRATION PROCEDURE

- *Technical characteristics*

Power supply voltage	32V ($\pm 2\%$)
Polarisation current	1.0 cold for each device (2A total), ± 0.1 A
Gain for low signal	Not less than 13dB in the 470-860MHz band (± 1 dB) Compare to the typical curve enclosed

- *Adjustment procedure*

Polarisation current calibration	32V stabilised power supply 10A amperometer
Gain curve	Network analyser

- *Adjustment points description*

R7-R8 (Trimmers)	Adjust the current absorbed in stand-by (1.0A per device)
------------------	---

- *Calibration steps*

STEP 1: Close the input and the output of the module by connecting them to a 50 Ω dummy load and connect the spectrum analyser through a directive sample, in order to look for self-oscillation of the module, if any (anyway the module has been designed so that it would not self-oscillate even if totally de-coupled, without any input or output load).

STEP 2: Check the voltages of the polarisation circuits *without assembling the transistors first*: connect the 32V power supply to the proper turret by means of a fastening screw, then give power and check data:

- the stabilised voltage on the zener diodes DZ1 and DZ2 is about 15V compared to the ground;
- the stabilised voltage on the zener diodes DZ3 and DZ4 is about 6.8V compared to the ground;
- the voltage on the pads to which the gates of the LDMOS transistors will be soldered (R23 and R24 resistors side) changes from 0V to a maximum value of about 6V when moving the relevant trimmer (R7-R8).

STEP 3: Check the work of the protections.

- Set both trimmers so that there is a value of about 4.5V on the pads of the gates;
- solder some wire to the pad between the two LEDs, next to the serigraphy of the input hybrid H1;
- in order to check the work of the protections aboard, a power of about 4V has to be supplied to the wire, for example by touching with it the reophore of C23 or C24 which is not connected to ground; the two red LEDs will immediately light up and the two RF transistors will be switched off at the same time: the polarisation current (2A) will decrease to 0 and of course the gain curve displayed by the spectrum analyser will decrease;
- after this it is **important** to restore the position of the two trimmers for the minimum voltage! Then disconnect the 32V power supply.

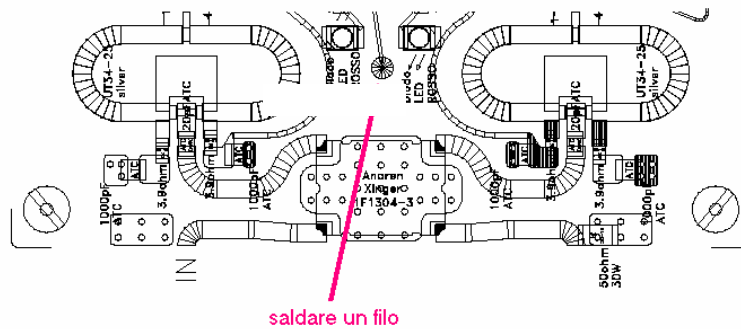

Solder a wire

STEP 4: Fastening of the LDMOS transistors: after properly cleaning the plate surface, smear a thin layer of silicone fat on the lower side of the flange of the MOSFETs, fasten them to the heat sink and solder the gate first, then the drain. Solder the two 13pF (ATC) chip capacitors and above them the two 1-5pF capacitive trimmers, between the two pair of gates, as shown by the mounting plan.

STEP 5: Connect serially a c.c. amperometer to the power supply, with scale starting from more than 5A (i.e. 10A).

STEP 6: Power the module and check the MOSFET is not absorbing current; this means that the device is integral and working correctly.

STEP 7: Slowly turn the R7 trimmer until the MOSFET absorbs 1A, always checking that there are no self-oscillation; under this conditions it is possible to check by means of a digital tester that the voltage on the gate is about 5.2-5.4V.

STEP 8: Repeat the previous step for the other section of the module, this time turn R8 and checking that the indication of the current on the amperometer increases to 2A total (which includes the current of the other device left on).

STEP 9: Check the response curve of the module by means of the *network analyser*.

STEP 10: Check the response curve for low signal with centre 660MHz and span 500MHz, 2dB/div.

STEP 11: The curve should be similar to the one enclosed, with a tolerance of ± 0.5 dB. To obtain this, act on the four trimmers C41-C41a and C42-C42a with the proper “calibrator”, in order to flatten the curve as much as possible, especially at the edged of the band which represents the minimum values.

STEP 12: Finally, check that the current in stand-by does not increase by more than 15÷20%, reaching at worst 2.3÷2.4A when the heat sink is hot and not ventilated.

Note: when mounting-removing the PALLET on the heat sink, tightly fasten the screw of each all “N” input and output connectors. These are mounted with a single 3mm screw and if it is not properly fastened it may be detached from the PCB by a movement of the connector once it has already been soldered to the path.

SCH0192AR0 LDMOS UHF Amplifier Board Component layout

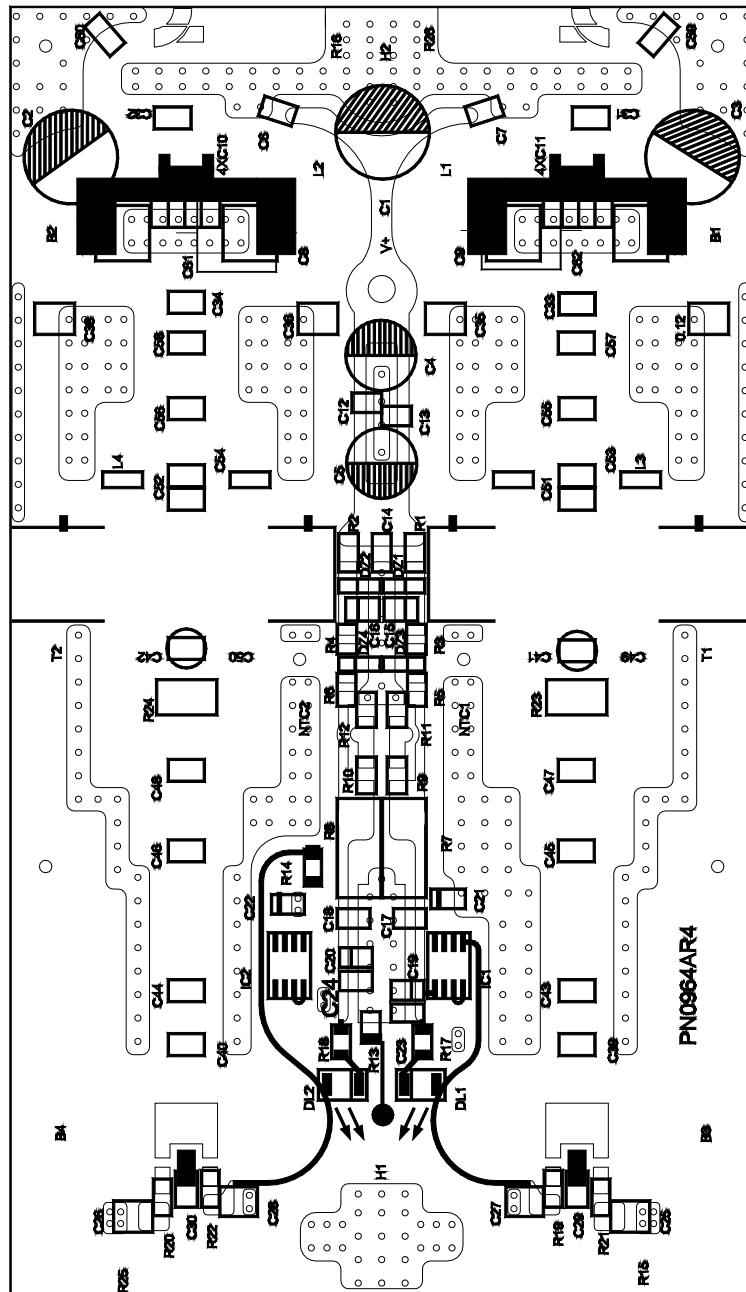

SCH0192AR0 COMPONENT LIST

Eletronika Code	Description	Manufacturer, Mfr. Code	Qty	Comps.
00045A	2K2 1206 5% 1/4W RESISTOR	PHICOMP, RC1206JR072K2L	4	R1-4
00042A	1K2 1206 1% 1/4W RESISTOR	PHICOMP, RC1206FR071K2L	4	R5-6, R9-10
00800	50K 3.8" SQUARE TRIMMER	BOURNS, 3296W-1-503	2	R7-8
00056B	18K 1206 5% 1/4W RESISTOR	PHICOMP, RC1206JR0718KL	2	R11-12
00075A	680K 1206 5% 1/4W RESISTOR	PHICOMP, RC1206JR07680KL	1	R13
00001	0R 1206 RESISTOR	PHICOMP, RC1206JR070RL	1	R14
00432	50 OHM 60W TERMINATION	DICONEX, 17-0185	2	R25-26
00049A	4K7 1206 1% 1/4W RESISTOR	PHICOMP, RC1206FR074K7L	2	R17-18
00012A	3R9 1206 5% 1/4W RESISTOR	PHICOMP, RC1206JR073R9L	4	R19-22
00396	1K0 2512 5% 1W RESISTOR	TYCO, 35201K0JT	2	R23-24
01807B	470uF 50V ELECTROLITIC CAPACITOR	ADIMPEX, CL514750	3	C1-3
01795	100uF PTH 50V ELET. VERT. CAPACIT.	ADIMPEX, CL211050	2	C4-5
01145	1nF 50V PORCELAIN CAPACITOR	ATC, ATC100B102JT50XT	6	C6-7, C25-28
01065H	100nF 2220 1kV CERAMIC CAPACITOR	SYFER, 2220J1K00104KXT	4	C8-9
01135	100pF 500V PORCELAIN CAPACITOR	ATC, ATC100B101KT500XT	8	C10-11
01065G	100nF 1210 250V CAPACITOR	SYFER, 1210J2500104KXT	9	C12-14, C21-24
01613A	1uF SMD 35V TANTALUM CAPACITOR	NIC COMPONENTS CORP., NTC-T105M35TRB	2	C15-16
01626A	10uF SMD 16V TANT. CAPACITOR	KEMET, KEMT491C106K016AT	2	C19-20
01123	20pF 500V PORCELAIN CAPACITOR	ATC, ATC100B200JT500XT	4	C29-32
01104	1.3pF 500V PORCELAIN CAPACITOR	ATC, ATC100B1R3DT500XT	2	C33-34
01143	470pF 200V PORCELAIN CAPACITOR	ATC, ATC100B471KW200X	4	C35-38
01108	4.7pF 500V PORCELAIN CAPACITOR	ATC, ATC100B4R7DT500XT	2	C57-58
01117	10pF 500V PORCELAIN CAPACITOR	ATC, ATC100B100JT500XT	2	C55-56
01104B	3.6pF 500V PORCELAIN CAPACITOR	ATC, ATC100B3R6DT500XT	2	C43-44
01119A	13pF 500V PORCELAIN CAPACITOR	ATC, ATC100B130KT500XT	2	C49-50
01113	8.2pF 500V PORCELAIN CAPACITOR	ATC, ATC100B8R2JT500XT	4	C51-54
01160	0.3pF 500V PORCELAIN CAPACITOR	ATC, ATC100B0R3CT500XT	1	C60
01485	VARIABLE CAPACITOR 1-5pF	JOHANSON, 9702-1	2	C41-42
04034	LDMOS TRANSISTOR BLF861	PHILIPS, BLF861/A	2	T1-2
00661	NTC THERMISTOR 100K	VISHAY, 238164063104	2	NTC1-2
04583	IC SPDT ANALOG SWITCH	MAXIM, DG419DY-E3	2	IC1-2
03135	DIODE 15V ZENER	FAIRCHILD, MMSZ5245B	2	DZ1-2
03137	DIODE 6.8V ZENER	DIOTEC, GSEZMM6.8/D2	2	DZ3-4
03056	LED RED SMD	KINGBRIGHT, KA3528EC	2	DL1-2
07684	SILVERED WIRE 1.2MM	ELETTRONIKA, 07684	0.25	L1-2
DET0643K	200W LDMOS PALLET	ELETTRONIKA, DET0643K	1	
01111	6.8pF 500V PORCELAIN CAPACITOR	ATC, ATC100B6R8KT500XT	4	C45-48
V0774	SPACER 3X10 F/F	ELEKTROZUBEHOR, DD10H305010	1	
08491	PRE-FOLDED CABLE	EZ FORM CABLE, EZ9025	2	B1-2
08492	PRE-FOLDED CABLE	EZ FORM CABLE, EZ3425 SILVER	2	B3-4
01109	5.6pF 500V PORCELAIN CAPACITOR	ATC, ATC100B5R6DT500XT	2	C39-40
01077A	1uF PTH 100V POLYESTER CAPACITOR	ARCOTRONICS, R82EC4100DQ70J2	2	C61-62

SCH0221AR0 Component layout

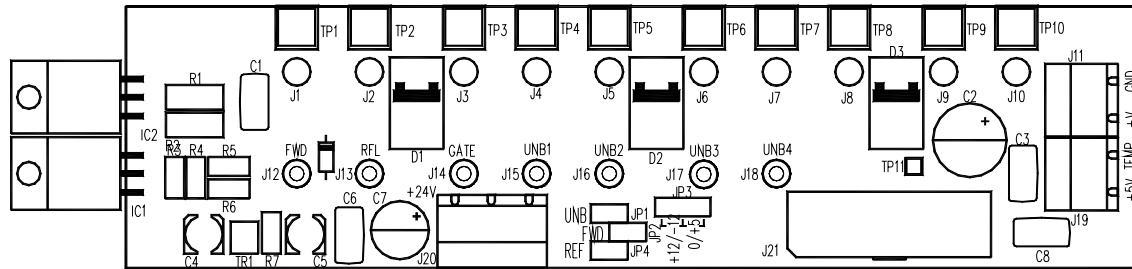

SCH0221AR0 COMPONENT LIST

Part Name/Number	Description	Qty.	Comps.
CC 100nFAVX 01065A	01065A CERAMIC CAPACITOR	4	C1, C3, C6, C8
CE 100uF100V	01795B ELET. CAPACITOR	1	C2
CE 100uF50V 01795	01795 ELET. CAPACITOR	1	C7
CE 10uF35V-S 01778A	01778A ELET. SMD CAPACITOR	2	C4-5
D 1N4007 03009	03009 DIODE	1	D4
D 6CWQ10FN	03026 2x3.5A SMD DIODE SCHOT.	3	D1-3
ICLM317HV	04340A INTEG CIRCUIT	2	IC1-2
J FC-16P 02701-02700	02701+02700 PCB CONNECTOR	1	J21
J SCREWCONN2 02853	02853 PCB SCREW CONNECTOR	2	J11, J19
J SCREWCONN3 02860	02860 PCB SCREW CONNECTOR	1	J20
J TESTP1.3mm 07913	07913 TEST POINT	17	J1-10, J12-18
JU JUMP2 02739-02742	02739+02742 PAN2 MALE	3	JP1-2, JP4
JU JUMP3 02707-02742	02707+02742 PAN3 MALE	1	JP3
R 0R33-1W-S	00380 RES 1W 5% SMD 2512	2	R1-2
R 100K-S 00065A	00065A RES 1/4W 5% SMD 1206	1	R7
R 220R-S 00033A	00033A RES 1/4W 5% SMD 1206	1	R4
R 22K-S 00057A	00057A RES 1/4W 5% SMD 1206	1	R5
R 270R-S 00034A	00034A RES 1/4W5% SMD 1206	1	R3
R 4K7-S 00049A	00049A RES 1/4W 5% SMD 1206	1	R6
TR BC856 03455	03455 PNP SMD TRANSISTOR	1	TR1



MAIN FEATURES

- Universal AC input / Full range
- Built-in active PFC function, PF>0.95
- Protections: Short circuit / Over load / Over voltage / Over temp.
- Forced air cooling by built-in DC fan
- Built-in cooling Fan ON-OFF control
- Built-in remote sense function
- Fixed switching frequency at 110kHz

MECHANICAL SPECIFICATION

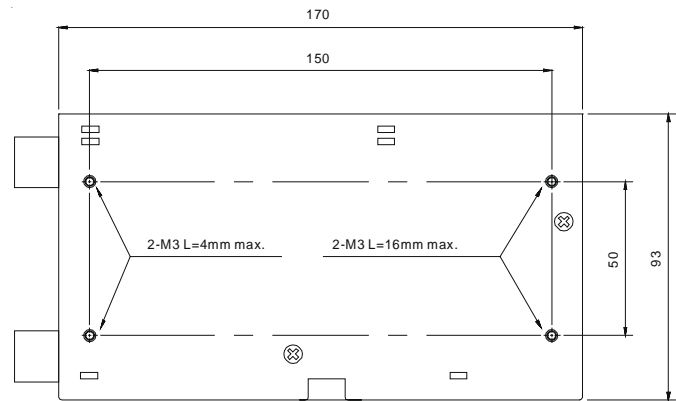
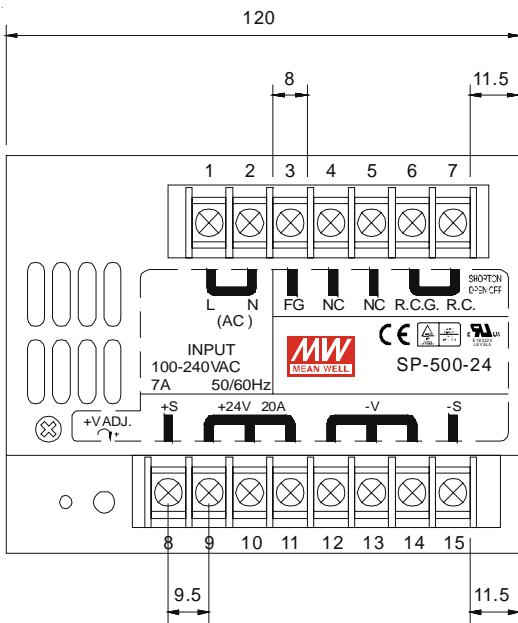

PIN N°	ASSIGNMENT	PIN N°	ASSIGNMENT
--------	------------	--------	------------

1	AC/L	7	R.C.
2	AC/N	8	+S
3	FG \perp	9 ~ 11	DC OUTPUT +V
4, 5	NC	12 ~ 14	DC OUTPUT -V
6	R.C.G.	15	-S

TECHNICAL CHARACTERISTICS

MODEL		SP500-27	SP500-48
OUTPUT	DC VOLTAGE	27V	48V
	RATED CURRENT	18A	10A
	CURRENT RANGE	0 ~ 18A	0 ~ 10A
	RATED POWER	486W	480W
	RIPPLE & NOISE (max.) Note 2	200mVp-p	300mVp-p
	VOLTAGE ADJ. RANGE	24 ~ 30V	41 ~ 56V
	VOLTAGE TOLERANCE Note 3	± 1.0%	± 1.0%
	LINE REGULATION	± 0.5%	± 0.5%
	LOAD REGULATION	± 0.5%	± 0.5%
	SETUP, RISE, HOLD TIME	1500ms, 50ms, 20ms at full load	
INPUT	VOLTAGE RANGE	88 ~ 264VAC 124 ~ 370VDC	
	FREQUENCY RANGE	47 ~ 63Hz	
	POWER FACTOR	PF>0.95/230VAC PF>0.95/115VAC at full load	
	EFFICIENCY (Typ.)	86.5%	87%
	AC CURRENT	7A/115VAC 3.5/230VAC	
	INRUSH CURRENT (Max.)	18A/115VAC 36A/230VAC	
	LEAKAGE CURRENT	<3.5A/240VAC	
PROTECTION	OVER LOAD	105 ~ 135% rated output power Protection type: Fold back current limiting, recovers automatically after fault condition is removed	
	OVER VOLTAGE	31 ~ 36.5V	57.6 ~ 67.2V
		Protection type: Hiccup mode, recovers automatically after fault condition is removed	
	FAN CONTROL O.T.P.	RTH1 or RTH2 >= 50°C FAN ON, <= 45°C FAN OFF, >= 70°C output shutdown	
FUNCTION	REMOTE CONTROL	RC+/RC-: Short = power on; Open = power off	
ENVIRONMENT	WORKING TEMP.	-10 ~ +50°C (Refer to output load derating curve)	
	WORKING HUMIDITY	20 ~ 90% RH non-condensing	
	STORAGE TEMP., HUMIDITY	-20 ~ +85°C, 10 ~ 95% RH	
	TEMP. COEFFICIENT	± 0.03%/°C (0 ~ 50°C)	
	VIBRATION	10 ~ 500Hz, 2G 10min./1cycle, period for 60min. each along X, Y, Z axes	
SAFETY & EMC (Note 4)	SAFETY STANDARDS	UL1950, TUV EN60950 Approved	
	WITHSTAND VOLTAGE	I/P-O/P:3KVAC I/P-FG:1.5KVAC O/P-FG:0.5KVAC	
	ISOLATION RESISTANCE	I/P-O/P, I/P-FG, O/P-GD:100M Ohms/500VDC	
	EMI CONDUCTION & RADIATION	Compliance to EN55022 (CISPR22) Class B	
	HARMONIC CURRENT	Compliance to EN61000-3-2,-3	
	EMS IMMUNITY	Compliance to EN61000-4-2,3,4,5,6,8,11; ENV50204, Light industry level, criteria A	
OTHERS	MTBF	133.4K hrs min. MIL-HDBK-217F (25°C)	
	DIMENSION	170*120*93mm (L*W*H)	
	PACKING	1.9kg; 8pcs/15.2kg/1.06CUFT	



S.S. 96 km 113 - Zona Industriale
70027 PALO DEL COLLE (Bari)
ITALY

Phone: +39 080 626755
+39 335 5824900

Fax: +39 080 629262

www.elettronika.it
elettronika@elettronika.it