

Liebert® Challenger™ 3000/Liebert Challenger ITR™ with Liebert iCOM® Control

Operation & Maintenance Manual - 50 & 60Hz



TABLE OF CONTENTS

IMPORTANT SAFETY INSTRUCTIONS	1
SAVE THESE INSTRUCTIONS	1
1.0 INTRODUCTION	3
1.1 System Descriptions	3
1.1.1 Compressorized Systems	3
1.1.2 GLYCOOL™ (Chilled Glycol Cooling) Systems	3
1.1.3 Chilled Water Systems	3
2.0 STARTUP	4
2.1 Startup Procedure	4
3.0 OPERATION WITH ICOM CONTROL	6
3.1 Features	6
4.0 LIEBERT ICOM DISPLAY COMPONENTS AND FUNCTIONS	7
4.1 Navigating Through the Liebert iCOM Display	9
4.1.1 Control Interface—Three Main Menus	10
4.1.2 Accessing Menus and Settings	11
4.1.3 Entering the Password	11
4.1.4 Accessing Submenus	12
4.2 Changing Operational Settings	14
4.3 Changing Liebert iCOM's Display Settings	15
4.4 Graphical Data Record	16
4.5 Liebert iCOM Service Menu Icons and Legend	16
4.6 Wiring for Unit-to-Unit Communications—U2U	17
4.6.1 Liebert iCOM U2U Ethernet Network	17
4.6.2 Wiring a Liebert iCOM U2U Network	17
4.7 Entering Network Setup Information	25
4.8 Viewing Multiple Units with a Networked Large Display	26
5.0 OPERATION	27
5.1 Single Unit Functions	27
5.1.1 Unit/Fan Control	27
5.1.2 General Compressor Requirements	28
5.1.3 Compressor Timing	29
5.2 Control Types	30
5.2.1 Proportional Control	30
5.2.2 PI Control	30
5.2.3 Intelligent Control (Chilled Water Only)	31
6.0 ALARM DESCRIPTIONS	32

6.1	Standard Alarms	32
6.1.1	Change Filter	32
6.1.2	Compressor Overload	32
6.1.3	High Head Pressure	33
6.1.4	High Humidity	33
6.1.5	High Humidity and Low Humidity (Simultaneously)	33
6.1.6	High Temperature	33
6.1.7	High Temperature and Low Temperature (Simultaneously)	33
6.1.8	Humidifier Problem	33
6.1.9	Loss of Air Flow	34
6.1.10	Loss of Power	34
6.1.11	Low Humidity	34
6.1.12	Low Suction Pressure	34
6.1.13	Low Temperature	34
6.1.14	Main Fan Overload	34
6.1.15	Short Cycle	34
6.2	Optional Alarms	35
6.2.1	Loss of Water Flow	35
6.2.2	Smoke Detected	35
6.2.3	Standby GC Pump On	35
6.2.4	Standby Unit On	35
6.2.5	Water Under Floor	35
6.3	Set Alarms—User Menus	35
7.0	COMPONENT OPERATION AND MAINTENANCE	36
7.1	System Testing	36
7.1.1	Environmental Control Functions	36
7.2	Filters	39
7.3	Blower Package	39
7.3.1	Fan Impellers and Bearings	39
7.3.2	Belt	39
7.3.3	Air Distribution	40
7.4	Refrigeration System	40
7.4.1	Suction Pressure	40
7.4.2	Discharge Pressure	41
7.4.3	Superheat	41
7.4.4	Thermostatic Expansion Valve	41
7.4.5	Hot Gas Bypass Valve—Not Available on Digital Scroll Units	42
7.4.6	Air Cooled Condenser	42
7.4.7	Water/Glycol Cooled Condensers	43
7.4.8	Motorized Ball Valve—Digital Scroll Compressor	44
7.4.9	Regulating Valve—Scroll Compressor	44
7.4.10	Drycooler Settings	46
7.4.11	Compressor Oil	47
7.5	Compressor Replacement	47
7.5.1	Compressor Functional Check	47
7.5.2	Standard Scroll Compressor Replacement	48
7.5.3	Digital Scroll Compressor Replacement Procedure	49

7.6	Facility Fluid and Piping Maintenance for Water and Glycol Systems	49
7.7	Humidifier.	50
7.7.1	Infrared Humidifier	50
7.7.2	Steam Generating Humidifier	52
8.0	TROUBLESHOOTING	56
9.0	MONTHLY MAINTENANCE INSPECTION CHECKLIST	62
10.0	SEMIANNUAL MAINTENANCE INSPECTION CHECKLIST	63

FIGURES

Figure 1	Liebert iCOM components	6
Figure 2	Liebert iCOM display components.	7
Figure 3	Liebert iCOM default screen symbols	9
Figure 4	Liebert iCOM default home screen—Graphical view	9
Figure 5	Liebert iCOM default home screen—Simple view	10
Figure 6	Entering the password	11
Figure 7	Menu tree—Large and small displays, stand-alone or networked.	13
Figure 8	Liebert iCOM User Menu icons	14
Figure 9	Display setup screen	15
Figure 10	Temperature graph.	16
Figure 11	Liebert iCOM Service Menu icons	16
Figure 12	U2U network setup diagram	19
Figure 13	Liebert iCOM wiring—Unit as shipped.	21
Figure 14	Wiring a small display for U2U network operation	22
Figure 15	Wiring a large display for U2U network operation.	23
Figure 16	Liebert iCOM input-output control board	24
Figure 17	Control board U2U network setup screen	25
Figure 18	Liebert iCOM display U2U network setup screen	25
Figure 19	Menu tree—Large display, networked.	26
Figure 20	Start-stop priority switches	27
Figure 21	Liebert leak detection units	37
Figure 22	Recommended liquid sensor locations	38
Figure 23	Outdoor fan/condenser configuration.	43
Figure 24	Johnson Controls valve adjustment.	45
Figure 25	Metrex valve adjustment	45
Figure 26	Infrared humidifier lamps	51
Figure 27	Steam generating humidifier	52

TABLES

Table 1	Keyboard icons and functions	8
Table 2	Sample Liebert iCOM network configurations	17
Table 3	Set alarms—User Menus	35
Table 4	Zone leak detection kit installation scenarios	38
Table 5	Recommended free area ft ² (m ²) for grilles or perforated panels at output velocities of 550 and 600 fpm (2.8 and 3.1 m/s)	40
Table 6	Suction pressures - R407c	40
Table 7	Discharge pressures	41
Table 8	Water/glycol system conditions requiring optional settings for aquastats	46
Table 9	Aquastat settings—two-fan through four-fan drycoolers	46
Table 10	Compressor oil types	47
Table 11	Humidifier canister part numbers	54
Table 12	Blower troubleshooting	56
Table 13	Chilled water troubleshooting	56
Table 14	Compressor and refrigeration system troubleshooting	57
Table 15	Dehumidification troubleshooting	59
Table 16	Glycol pump troubleshooting	59
Table 17	Infrared humidifier troubleshooting	59
Table 18	Steam generating humidifier troubleshooting	60
Table 19	Reheat troubleshooting	61

IMPORTANT SAFETY INSTRUCTIONS

SAVE THESE INSTRUCTIONS

This manual contains important safety instructions that should be followed during the installation and maintenance of the Liebert Challenger 3000/Liebert Challenger ITR with Liebert iCOM. Read this manual thoroughly before attempting to install or operate this unit.

Only qualified personnel should move, install or service this equipment.

Adhere to all warnings, cautions and installation, operating and safety instructions on the unit and in this manual. Follow all operating and user instructions.



WARNING

Risk of electric shock. Can cause injury or death.

Disconnect local and remote power supplies before working within.

Before proceeding with installation, read all instructions, verify that all the parts are included and check the nameplate to be sure the voltage matches available utility power.

The Liebert iCOM microprocessor does not isolate power from the unit, even in the “Unit Off” mode. Some internal components require and receive power even during the “Unit Off” mode of Liebert iCOM control.

The factory-supplied optional disconnect switch is inside the unit. The line side of this switch contains live high-voltage.

The only way to ensure that there is NO voltage inside the unit is to install and open a remote disconnect switch. Refer to unit electrical schematic.

Follow all local codes.



WARNING

Risk of explosive discharge from high-pressure refrigerant. Can cause injury or death.

This unit contains fluids and gases under high pressure. Relieve pressure before working with piping.



WARNING

Risk of refrigerant system rupture or explosion from overpressurization. Can cause equipment damage, injury or death.

If a pressure-relief device is not provided with the condenser unit, the system installer must provide and install a discharge pressure-relief valve rated for a maximum of 500 psig (34bar) in the high side refrigerant circuit. Do not install a shutoff valve between the compressor and the field installed relief valve.

One or more additional pressure-relief valves are required downstream of any and all field-installed isolation valves. Do not isolate any refrigerant circuits from overpressurization protection.

For systems requiring EU CE compliance (50Hz), the pressure-relief valve must be CE certified to the EU Pressure Equipment Directive by an EU “Notified Body.”



NOTE

A pressure-relief valve is provided with Liebert Lee-Temp™ condensers. A fusible plug is provided on Liebert Fan Speed Control condensers. The Liebert indoor cooling unit has a factory-installed high pressure safety switch in the high side refrigerant circuit.



WARNING

Risk of high-speed moving parts. Can cause injury or death.

Disconnect all local and remote electric power supplies before working in the unit.

Do not operate upflow units without installing a plenum, ductwork or guard over the blower opening(s) on the top of the unit cabinet.

Ductwork must be connected to the blower(s), or a plenum must be installed on the blower deck for protection from rotating blower wheel(s) on upflow units.



CAUTION

Risk of contact with hot surfaces. Can cause injury.

The compressors, refrigerant discharge lines, humidifiers and reheats are extremely hot during unit operation. Allow sufficient time for them to cool before working within the unit cabinet. Use extreme caution and wear protective gloves and arm protection when working on or near hot compressors, discharge lines, humidifiers and reheats.

NOTICE

Risk of leaking water. Can cause equipment and building damage.

This unit requires a water drain connection. It may also require an external water supply to operate.

Improper installation, application and service practice can result in water leaking from the unit. Water leaks can cause severe property damage and loss of critical data center equipment.

Do not locate unit directly above any equipment that could sustain water damage.

Emerson recommends installing leak detection equipment for unit and supply lines.

1.0 INTRODUCTION

1.1 System Descriptions

The Liebert Challenger 3000™ and Liebert Challenger ITR™ Precision Cooling systems are available in several configurations.

1.1.1 Compressorized Systems



NOTE

Compressorized systems may be a self-contained system, with the compressor in the Liebert Challenger 3000/Liebert Challenger ITR unit, or a split system, with the compressor in a separate condensing unit.

These systems may be air, water, or glycol cooled, depending on the heat rejection method selected.

Cooling—One stage standard; variable capacity with digital scroll, optional.

Heating—Two stages of electric reheat standard; SCR controlled electric reheat, hot water reheat, hot gas reheat on water and glycol cooled systems optional.

Humidification—Infrared standard; steam generating optional.

Dehumidification—Hot gas bypass locked out standard

1.1.2 GLYCOOL™ (Chilled Glycol Cooling) Systems

GLYCOOL systems have all of the features of a compressorized water or glycol system, plus a second cooling coil that is connected into the water circuit. When fluid temperature is sufficiently low (below room temperature), cooling is provided by circulating the fluid through the second cooling coil (flow is controlled by a motorized valve.) This is then the primary cooling source, and it greatly reduces the compressor operation.

Cooling—Modulated cooling valve opens proportionally to match room needs (primary), one or two stages of mechanical refrigeration (secondary)

Heating—Two stages of electric reheat standard; hot water reheat optional

Humidification—Infrared standard; steam generating optional

Dehumidification—Hot gas bypass locked out standard

1.1.3 Chilled Water Systems

These systems utilize a central chiller and control cooling by modulating a control valve in the chilled water line.

Cooling—Proportional in response to room needs

Heating—Two stages of electric reheat standard; hot water reheat optional

Humidification—Infrared standard; steam generating optional

Dehumidification—Chilled water valve opens proportionally in response to room needs

2.0 STARTUP

Before beginning startup, make certain that unit was installed according to the instructions in the installation manual, SL-11962. Verify that the fan shipping bolt has been removed, the check valve has been installed (on air cooled units), and that the scroll compressor is rotating in the proper direction. All exterior panels must be in place with the front panel open.

Locate the startup form supplied with your unit documents. Complete the form during startup and mail it to Liebert when startup is completed. Contact your Liebert supplier if you have any questions or problems during unit installation, startup or operation.



WARNING

Risk of electric shock. Can cause injury or death.

Potentially lethal voltages exist within this equipment during operation. Observe all cautions and warnings on unit and in this manual.

The Liebert iCOM microprocessor does not isolate power from the unit, even in the “Unit Off” mode. The only way to ensure that there is NO voltage inside the unit is to install and open a remote disconnect switch. Refer to unit electrical schematic.

2.1 Startup Procedure

- ___ 1. Disconnect all power to the environmental control unit.
- ___ 2. Tighten all electrical wiring connections that may have loosened during shipping (on electric panel and at all major components, such as compressor, reheats, humidifier and motor). Retighten according to values listed on component by component manufacturer.
- ___ 3. Remove all line voltage fuses except the main fan fuses at the far right of the electric panel and the Control Voltage fuses at the far left of the electric panel. For units supplied with circuit breakers, open the circuit breakers instead of removing fuses.
- ___ 4. Turn on power and check line voltage on main unit disconnect switch. Line voltage must be within 10% of nameplate voltage.
- ___ 5. Turn On main unit disconnect switch and check secondary voltage at transformer T1. Voltage at T1 must be 24 VAC \pm 2.5 VAC (check at TB1-1 and TB1-8). T1 voltage must not exceed 28 VAC. Change primary tap if necessary.
- ___ 6. Push the On button. Blower will start.
- ___ 7. If you do not want your unit to operate at factory default settings, set temperature and humidity setpoints, alarms, and other control functions. Refer to **3.0 - Operation with iCOM Control** or **5.0 - Operation**.
- ___ 8. Stop the unit by depressing the On/Off button on the front display. Turn Off main unit disconnect and main breaker.
- ___ 9. Replace all fuses (or reset circuit breakers) that were removed in **Step 3**.
- ___ 10. Restore power to unit; turn On the main unit disconnect switch.
- ___ 11. Push the On button—putting the unit into operation.
- ___ 12. Check the current draw on all line voltage components and match with serial tag.
- ___ 13. Verify that the scroll compressor is rotating in the proper direction.

NOTICE

Risk of improper scroll compressor installation. Could cause poor performance and compressor damage.

Three-phase power must be connected to the unit line voltage terminals in the proper sequence so that the scroll compressor rotates in the proper direction. Rotation in the wrong direction will result in poor performance and compressor damage. Use a phase sequence and motor rotation sensor to ensure that the three-phase power is correctly connected and that the compressor is rotating properly.

14. Check for unusual noises and vibration.
15. Check all refrigerant and fluid lines for leaks.
16. Test all functions of your unit for proper operation.
17. Close high voltage dead front cover and latch.
18. Close front accent panel and latch.

Return completed startup form to:

Liebert Corporation
Warranty Registration
1050 Dearborn Drive
P.O. Box 29186
Columbus, OH 43229

3.0 OPERATION WITH ICOM CONTROL

The Liebert iCOM™ control offers the highest capabilities in unit control, communication and monitoring of Liebert mission-critical cooling units.

Liebert iCOM may be used to combine multiple cooling units into a team that operates as a single entity, enhancing the already-high performance and efficiency of Liebert's units.

3.1 Features

Large and Small Displays

The Liebert iCOM control is available with either a large or small liquid crystal display.

- The **Liebert iCOM with small display** has a 128 x 64 dot matrix screen that shows text and icons. This display is capable of controlling only the unit it is directly connected to.
- The **Liebert iCOM with large display** has a 320 x 240 dot matrix screen that shows text and icons of 32 connected units (see **Figure 4**). This display can be used to control a single cooling unit or any cooling unit within a connected group over a network.

Liebert iCOM's menu-driven display is used for all programming functions. The Status menu shows the temperature of the return or supply air and the humidity of the return air.

Figure 1 Liebert iCOM components



4.0 LIEBERT iCOM DISPLAY COMPONENTS AND FUNCTIONS

The small and the large display have a common key layout, as shown in **Figure 2**.

Figure 2 Liebert iCOM display components

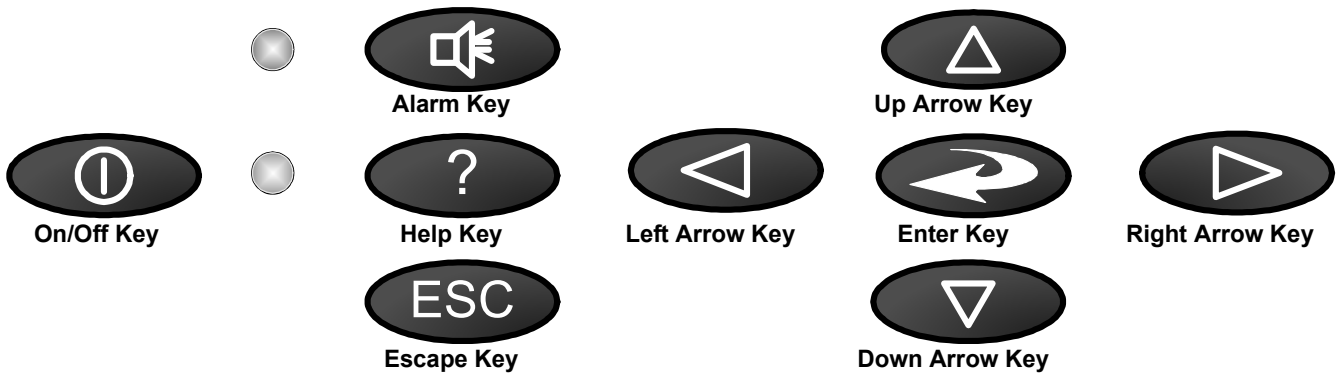
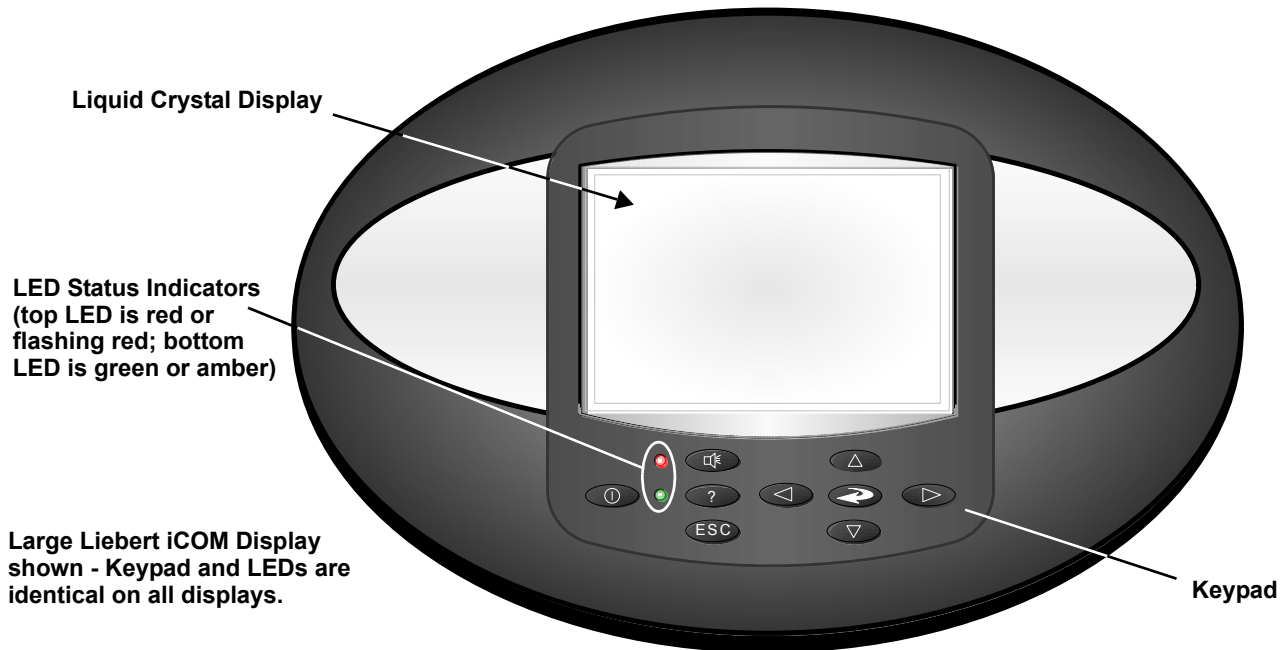

NOTE

The Help key may be pressed at any time for a brief explanation of what is being viewed.

Table 1 Keyboard icons and functions













Icon	Key Name	Function
	On/Off Key	Controls the operational state of the cooling unit.
	Alarm Key	Silences an alarm.
	Help Key	Accesses integrated help menus.
	ESCape Key	Returns to the previous display view.
	Enter Key	Confirms all selections and selects icons or text.
	Increase Key (Up Arrow)	Moves upward in a menu or increases the value of a selected parameter.
	Decrease Key (Down Arrow)	Moves downward in a menu or reduces the value of a selected parameter.
	Left and Right Arrow Keys	Navigates through text and sections of the display.
	Upper LED	Blinking Red—Active, unacknowledged alarm exists
		Solid Red—Active, acknowledged alarm exists
	Lower LED	Amber—Power is available to the unit, unit is NOT operating
		Green—Power is available to the unit, unit is operating

Figure 3 Liebert iCOM default screen symbols

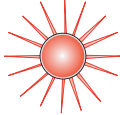

4.1 Navigating Through the Liebert iCOM Display

Liebert iCOM displays icons and text for monitoring and controlling your Liebert cooling unit. The number of icons and amount of text shown depends on the display size.

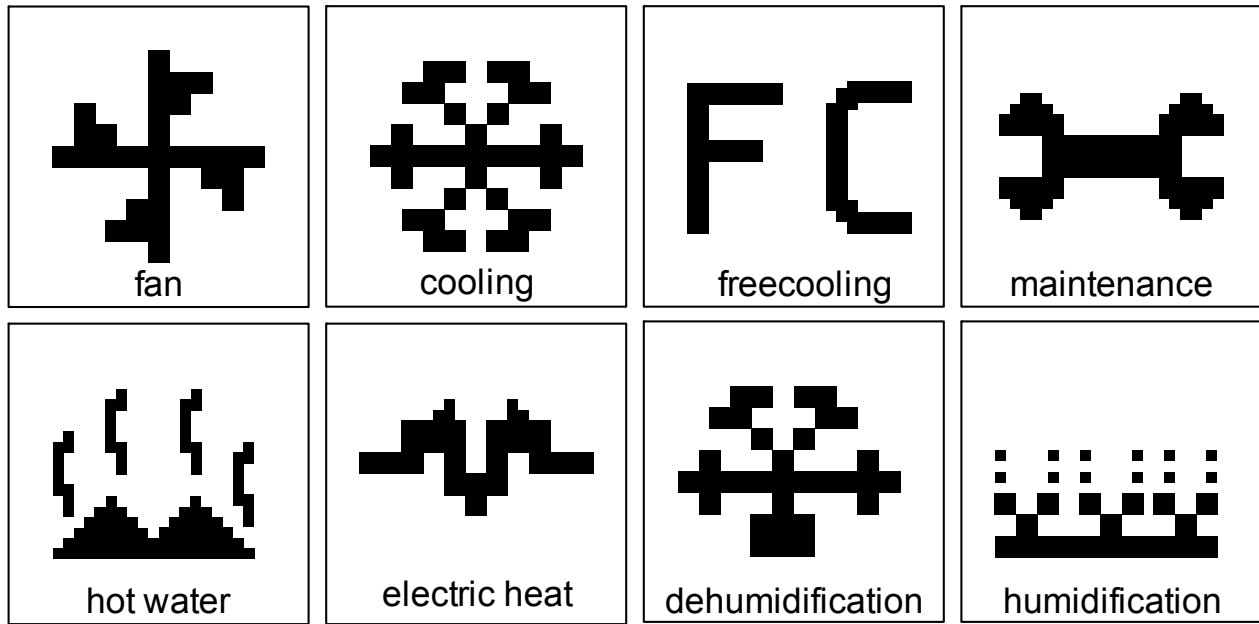
The Liebert iCOM offers two different types of views: graphical and simple. The graphical view is the default; to set the simple view refer to 4.3 - Changing Liebert iCOM's Display Settings. The Liebert iCOM's home screen is shown in Figure 4 (graphical view) and in Figure 5 (simple view).

Figure 4 Liebert iCOM default home screen—Graphical view

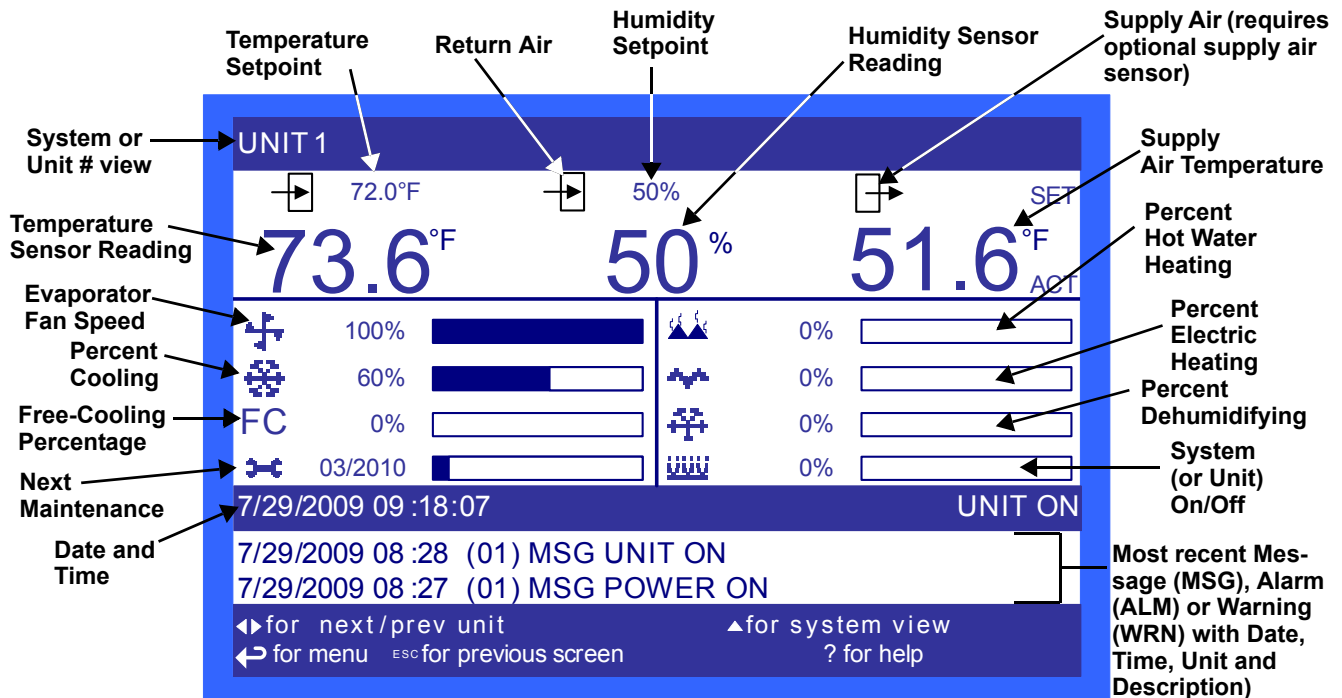
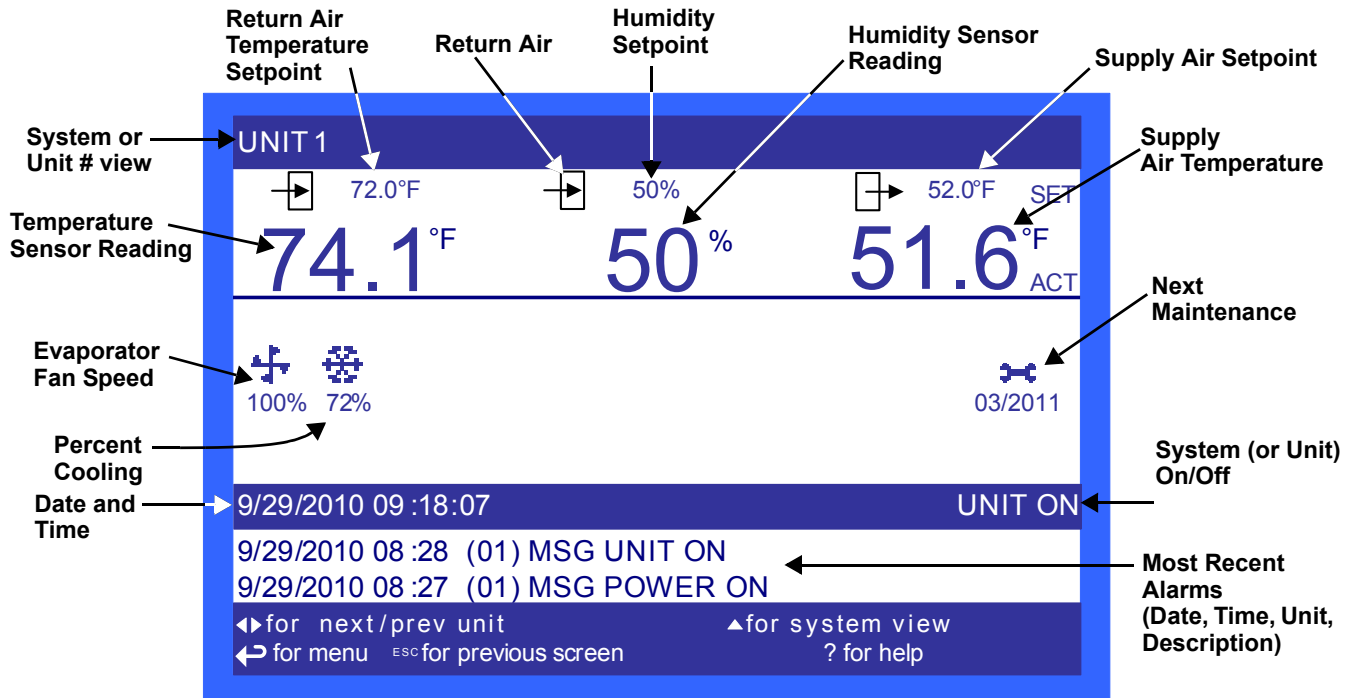

Figure 5 Liebert iCOM default home screen—Simple view



4.1.1 Control Interface—Three Main Menus

The Liebert iCOM control has three main menus: User, Service and Advanced.

The User menu contains the most frequently used features, settings and status information. The Service menu contains settings and features used to set up unit communications and for unit maintenance. The Advanced menu contains settings used to set up the unit at the factory.



NOTE

The Liebert iCOM's Advanced menu is for factory use only or in consultation with the factory service department.



NOTE

*Menu settings may be viewed without a password, but changing settings requires a password. If a password is required, the Liebert iCOM shows a prompt to enter the password. The password for the User menu is 1490. The password for Service menu is 5010. For details on entering a password, see 4.1.3 - **Entering the Password***

When the buttons on the Liebert iCOM control have not been pressed for a short period, the display backlight turns Off. Pressing any key will turn the backlight On (wake up the screen) and display the Status menu of the last cooling unit viewed. The Status menu will show the cooling unit's operational mode(s), return air temperature and humidity readings, temperature and humidity setpoints and any active alarm conditions.

If the cooling unit has a large display and is not on a network, or if the unit has a small display, whether it is networked or stand-alone, the Status menu will display only that cooling unit's information. Any large display that is connected to a network can be used to view any cooling unit on the network or show an average view of the entire system of cooling units.

4.1.2 Accessing Menus and Settings

Viewing Data

No password is required to view data or settings.

To view data:

1. From the home screen, press the **Enter** key to view the User Menu (see **Figure 8**).
2. Press **Enter** again to highlight the first icon.
3. Use the keyboard's arrow keys to move to the icon for the data you wish to view.
4. Once that icon is highlighted, press **Enter** again to open that menu.
 - If a password is required, see **4.1.3 - Entering the Password**.
 - If a menu has more than one screen, the Liebert iCOM display will have text at the top similar to this: (*page 1 of 2*).
5. Press **Enter** to select the first line of data.
6. Use the **Up** and **Down** arrow keys to scroll to the desired data point.
7. Press **ESC** to move back to higher level menus.

4.1.3 Entering the Password

Most settings in the Liebert iCOM are protected by a factory-set password, 1490. To enter the password:

1. From the home screen, press the **Enter** key to view the User Menu (see **Figure 8**).
2. Press **Enter** again to highlight the first icon.
3. Use the keyboard's arrow keys to move to the icon for the data you wish to change.
4. Once that icon is highlighted, press **Enter** again to open that menu.
5. Press **Enter** to highlight the Password line.
6. With the Password line highlighted, press **Enter** to highlight the first digit in the password
7. Enter the password, 1490.

Use the **Up** and **Down** arrow keys to select a numeral for the first digit of the password.

Move to the next digit of the password with the **Right** arrow key.

Select the numerals for all four digits with the same process.

8. After all four digits of the password have been entered, press the **Enter** key.



NOTE

Do not press the ESC key or the Liebert iCOM will move to the previous screen and the password must be re-entered before changes may be made.

Figure 6 Entering the password

Password command line—highlight by pressing **Enter**

After highlighting the Password command line, press **Enter** again to highlight the first digit. Use the **Up** and **Down** arrow keys to change the first digit. Move to the next digit in the Password with the right arrow.

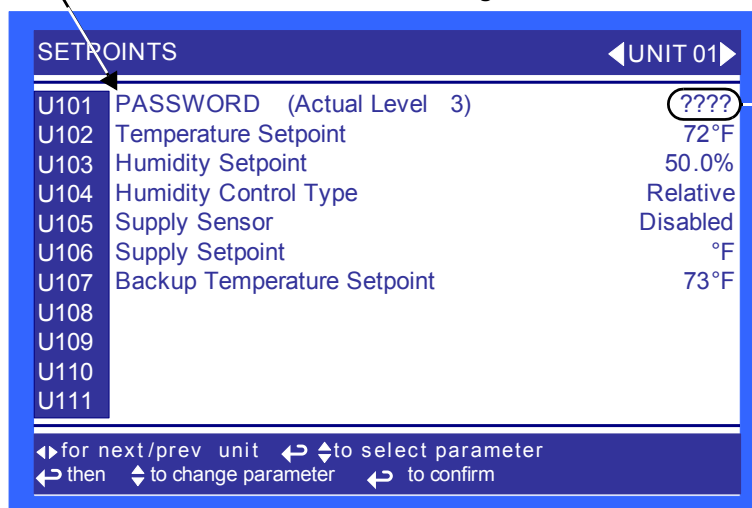

Password is factory-set at 1490

4.1.4 Accessing Submenus

To access the User, Service or Advanced menu, press the Enter or down arrow key while viewing the Status menu of the unit you wish to access. The User menu will be displayed first. To view the Service or Advanced menus, press the right arrow key.

Accessing Submenus on Small Displays

While viewing the menu you wish to access (User, Service or Advanced), use the up and down arrow keys to scroll through the icons page-by-page. To scroll through the icons one-by-one, press the enter key and then use the up and down arrow keys. With the desired icon highlighted, press the enter key to enter that submenu. Once in a Submenu, a list of parameters is displayed.

Press the enter key and use the up and down arrow keys to scroll through the parameters one-by-one. Pressing the ESC key will go back a level. **Figure 7** shows the Liebert iCOM control menus for a small display.

Accessing Submenus on Large Displays

While viewing the menu you wish to access (User, Service or Advanced), press the enter key to highlight the first icon. Use the arrow keys to navigate through the icons. With the desired icon highlighted, press the enter key to enter that submenu. Once in a Submenu, a list of parameters will be displayed.

The up and down arrow keys may be used to scroll through the parameters page-by-page if the submenu has multiple pages. To scroll item-by-item, press the Enter key and then use the up and down arrow keys. Using the right or left arrow keys on large displays attached to a network will change the unit being viewed. Pressing the ESC key will go back a level. **Figures 7** and **19** show the Liebert iCOM control menus for a stand-alone large display and for a networked large display, respectively.

**NOTE**

Settings are readable without a password, but changing settings requires a password.

Figure 7 Menu tree—Large and small displays, stand-alone or networked

Unit 1 will be displayed in the top left corner of the screen on the large display only.

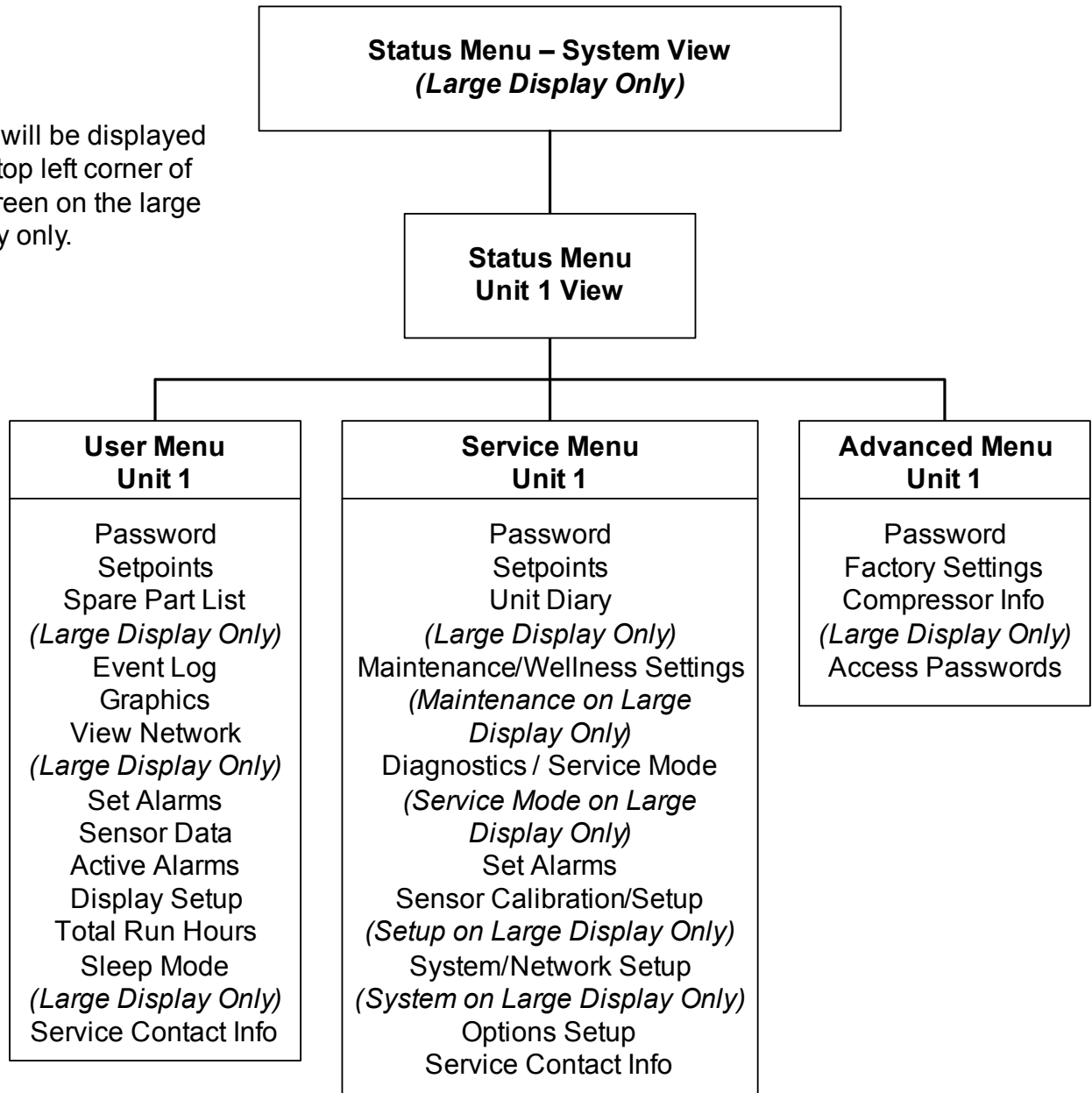









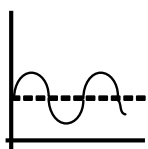
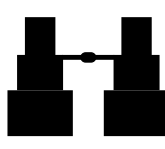

4.2 Changing Operational Settings

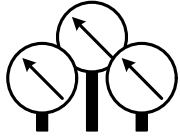
Changes to the Liebert Challenger 3000/Liebert Challenger ITR's operation settings in the **Set Alarms** and **Setpoints** menus require a password.

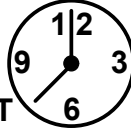
1. From the home screen, press the **Enter** key to view the User Menu (see **Figure 8**).
2. Press **Enter** again to highlight the first icon.
3. Use the keyboard's arrow keys to move to the icon for the data you wish to change.
4. Once that icon is highlighted, press **Enter** again to open that menu.
 - If a password is required, see **4.1.3 - Entering the Password**.
5. After entering the password, use the **Up** and **Down** arrow keys to scroll to and highlight the operational setting to be changed.
6. Press **Enter** to highlight the values for that setting.
7. Use the **Up** and **Down** arrow keys to change the value.
8. Press **Enter** to accept the change. (The value will no longer be highlighted.)
9. Press **ESC** to deselect the operational setting. (The setting will no longer be highlighted.)
10. Press **ESC** again to move to previous screens.

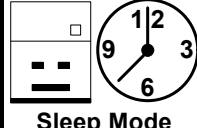
Figure 8 Liebert iCOM User Menu icons

 <p>Setpoints View and change operational setpoints</p>	 <p>Spare Parts List Contains spare parts available on site; Large Display Only</p>	 <p>Event Log Lists last 400 events and alarms View Only</p>	 <p>Graphic Data Record Displays average room air temperature and supply refrigerant temperature graphs; Data is View Only; Display scale is adjustable</p>	 <p>View Network Shows status of all connected units; View Only; Large Display Only</p>	 <p>Set Alarms Allows user to change settings for alarms</p>
 <p>Sensor Data Shows readings of sensors; View Only</p>	 <p>ACTIVE ALARMS Lists all current alarms; View Only</p>	 <p>Display Setup Change settings for display: language and time</p>	 <p>Total Run Hours Records the run time of all components and allows setting of limits on run time; View Only</p>	 <p>Sleep Mode Used to set operating period, including startup and shutdown; Large Display Only</p>	 <p>Service Contacts Contains key contact information for service</p>



NOTE

Menu shows icons only; text is explanatory and does not appear on the Liebert iCOM display.

4.3 Changing Liebert iCOM's Display Settings

No password is required to change the way Liebert iCOM displays data. The Display Setup controls how the unit shows data, such as temperature, date and time.

To change the display settings:

1. From the home screen, press the **Enter** key to view the User Menu (see **Figure 8**).
2. Press **Enter** again to highlight the first icon.
3. Use the keyboard's arrow keys to move to the Display Setup icon.
4. Once that icon is highlighted, press **Enter** again to open that menu.
5. Press the **Enter** key to select the first setting.
Either change that setting or navigate to another setting with the **Up** and **Down** arrow keys.
6. Once the desired setting is highlighted, press the **Enter** key to access that parameter's display setting options.
7. Use the **Up** and **Down** arrow keys to make changes.
8. Press the **Enter** key to accept the changes.
9. Press the **ESC** key twice to return to Liebert iCOM's user menu.

Figure 9 Display setup screen

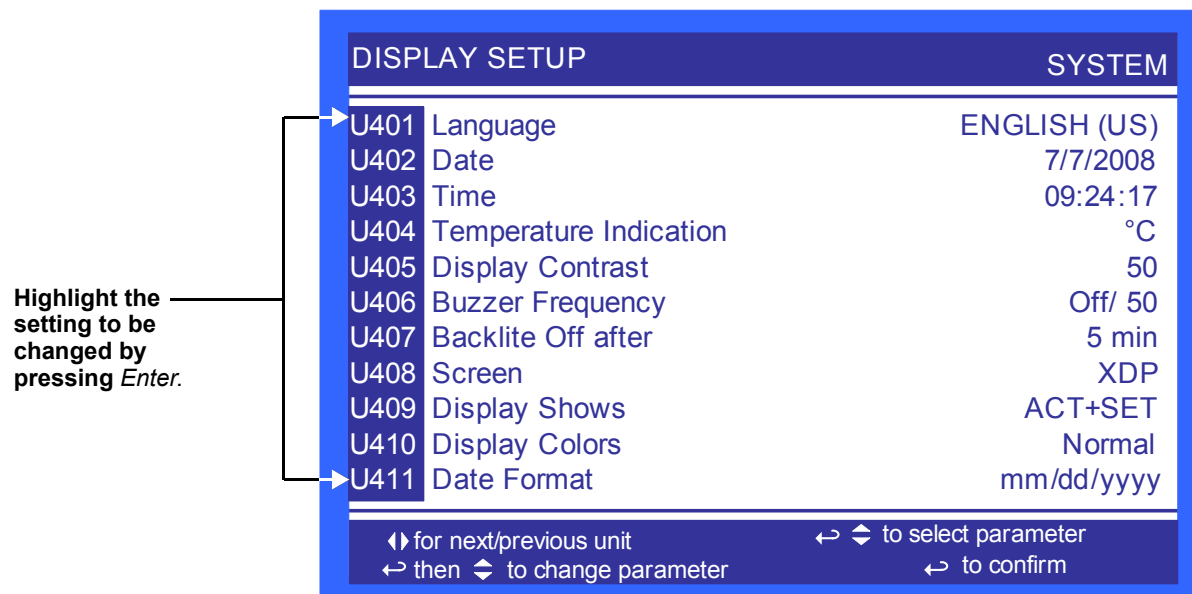

4.4 Graphical Data Record





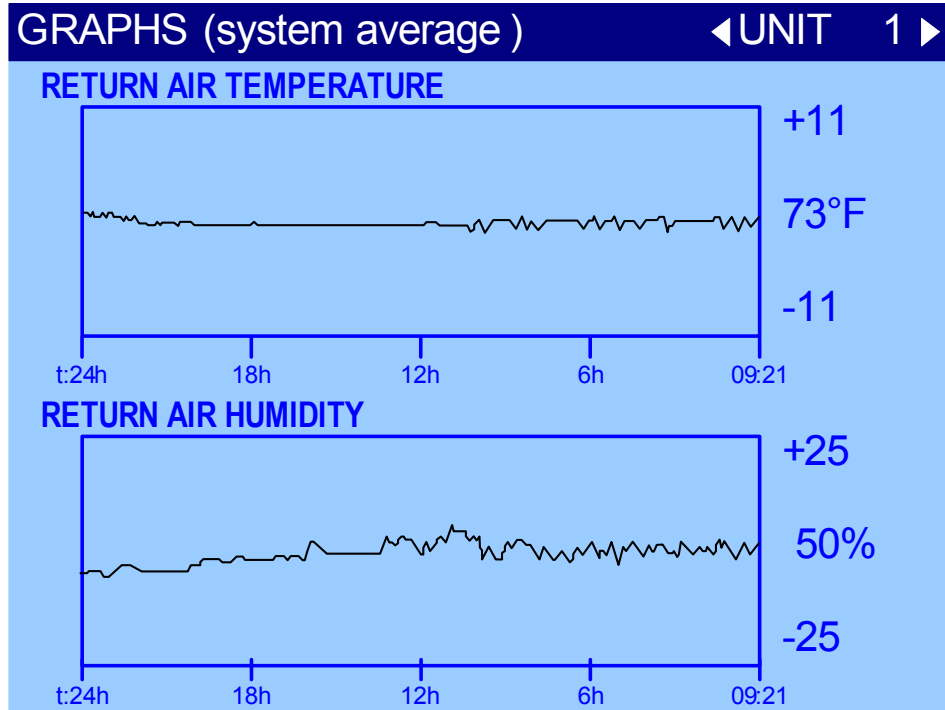

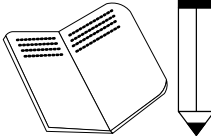

The Graphical Data Record charts the average temperature from the return air temperature sensor (see **Figure 10**). The temperature scales can be changed to expand or compress the data. The time scale also can be altered to any of several selectable values. Changing the time scale eliminates all previous graphical data and the unit will begin recording new data.

Figure 10 Temperature graph

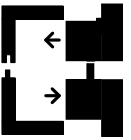

4.5 Liebert iCOM Service Menu Icons and Legend

Figure 11 Liebert iCOM Service Menu icons

<p>°C / °F % RH SET Setpoints View and change operational setpoints</p>	 <p>Unit Diary Shows all program changes and maintenance performed,</p>		 <p>WELLNESS Maintenance/Wellness Settings Shows all maintenance records, calculates next maintenance date</p>	 <p>SERVICE Diagnostics/Service Mode Enter Diagnostics/Service Mode for troubleshooting and repair; Large Display Only</p>	 <p>Set Alarms Change settings for alarms</p>
 <p>Sensor Calibration/Setup Setup and calibrate sensors for site</p>		<p>NETWORK</p>  <p>Network Setup or alter network setting.</p>	 <p>SET UP Options Setup Enter specific settings for various options</p>		 <p>Service Contacts Contains key contact information for service</p>



NOTE

Menu shows icons only; text is explanatory and does not appear on the Liebert iCOM display.

4.6 Wiring for Unit-to-Unit Communications—U2U

The Liebert Challenger 3000/Liebert Challenger ITR with Liebert iCOM comes from the factory wired for stand-alone operation. Multiple units can be set up in a network for efficiency, ease of operation and easier control.



NOTE

U2U connections can be set up to link these units: Liebert Challenger 3000, Liebert Challenger ITR, Liebert DS and Liebert CW. Each unit must be equipped with a Liebert iCOM.

4.6.1 Liebert iCOM U2U Ethernet Network

The Liebert iCOM U2U network must be isolated from other network traffic. The network switch(es) that connect Liebert iCOM controls need to be dedicated to supporting only Liebert iCOM communication. The U2U network cannot be connected to the building or IT network. If network communication is ever lost (failed network switch, etc.), all Liebert iCOM-controlled cooling units will continue to operate as independent units.

The Liebert iCOM control can support up to 64 nodes on one network. An input/output board, large display and large wall-mount display are each considered one node. No more than 32 nodes may be input/output boards (32 cooling units). A small display is not considered a node. Small displays connect directly to input/output boards that do not have large displays attached to them. The following table illustrates how a network can be configured.

Table 2 Sample Liebert iCOM network configurations

Sample Configuration	Input/Output Boards	Large Displays	Small Displays	Wall Mount Large Displays	Private Switch Required	Ports Required on Switch
1	2	0	2	0	No	NA
2	2	0	2	1	Yes	3
3	3	0	3	0	Yes	3
4	2	1	1	0	Yes	3
5	8	4	4	1	Yes	13
6	32	32	0	0	Yes	64
7	32	27	5	5	Yes	64
8	32	0	32	32	Yes	64

Network communication can be configured during system startup by a Liebert-trained technician. For technical issues contact:

Liebert Technical Service
 1050 Dearborn Drive
 Columbus, Ohio 43235
 Telephone: 1-800-LIEBSRV (1-800-543-2778)
 E-Mail: technicalservice@emersonnetworkpower.com

4.6.2 Wiring a Liebert iCOM U2U Network

Small Displays

Two cooling units, each with a small display: To network two cooling units, each with a small display, connect a crossover CAT5 cable between the P64 connectors on each cooling unit's Liebert iCOM input/output board. A network switch is not needed, because the small display connects directly to the Liebert iCOM.

Three or more units with small displays: To network three or more cooling units, each equipped with a small display, connect a straight-through CAT5 Ethernet cable from the P64 connector on each cooling unit's Liebert iCOM input/output board to a common network switch (see **Figure 13**).

Large Displays

A network switch is required to enable Ethernet communication on one or more cooling units with large displays. Each cooling unit with a large display requires two straight-through Ethernet cables from a network switch. One cable connects to port P64 on the Liebert iCOM input/output board and the other straight-through cable connects to the female-female coupler provided with the unit. Connect the red crossover cable, which is provided with the cooling unit, between the coupler and the P64 port on the back of the large display (see **Figure 15**).



NOTE

Only cooling units with large displays are supplied with a female-female coupler inside the unit from the factory.

Wall-Mount Large Display

Only large displays can be used for remotely monitoring and controlling cooling units connected on the same network. Each wall-mount large display requires 120V input power; Liebert provides an AC adapter wall plug. A straight-through Ethernet cable must be connected between the network switch and the P64 port on the back of the display. This will enable control and monitoring capabilities to any cooling unit connected to the network.

Combining Large and Small Displays on a U2U Network

Setting up a network of cooling units equipped with large and small displays requires a network switch. The controls are to be connected to the switch as described above.

To connect multiple units in a U2U network, the Network IP address, U2U Group Number and the U2U Address must be changed. The Network IP and the U2U Address must be unique on the network.

Figure 12 U2U network setup diagram

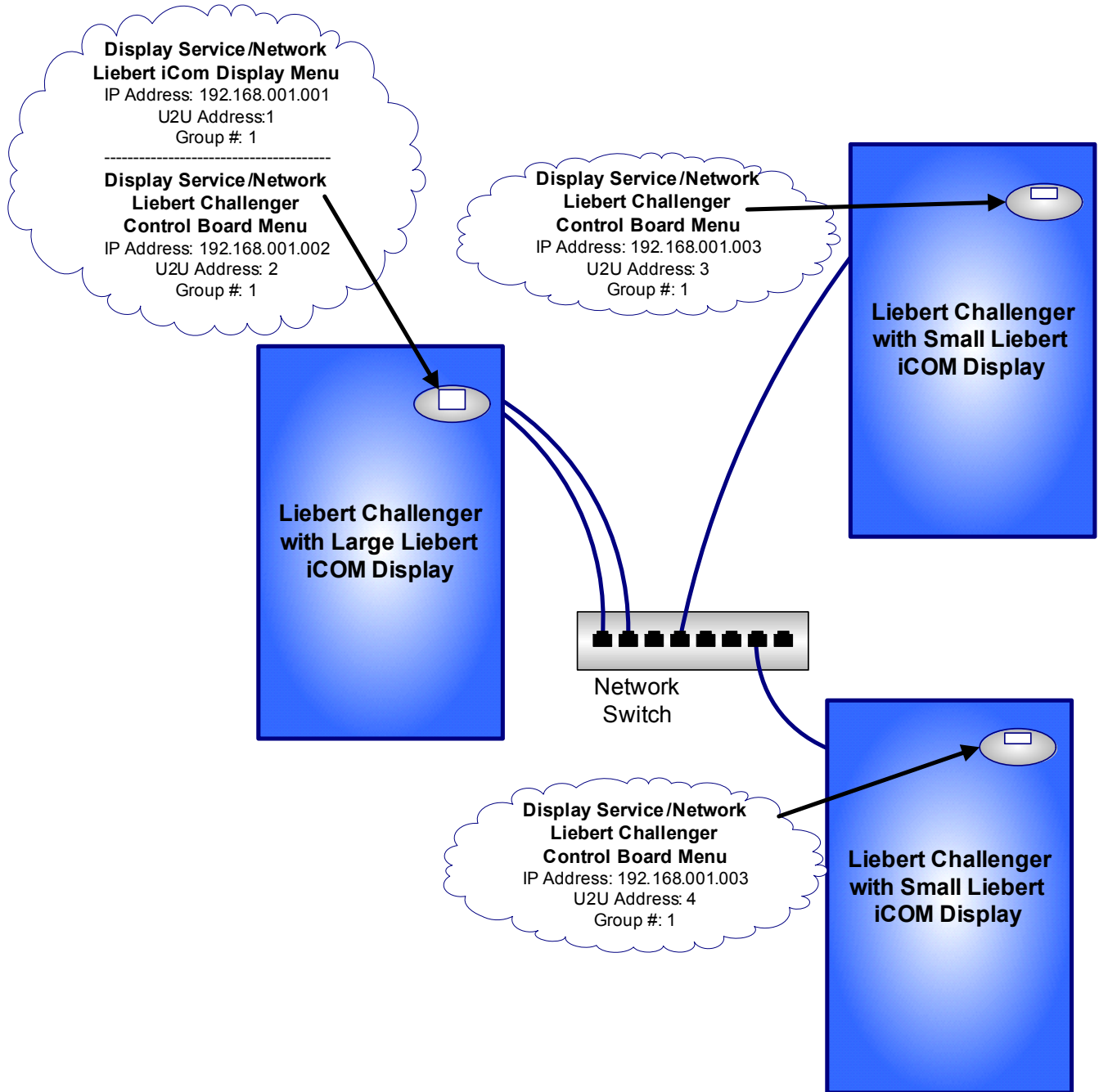

Notes on Wiring for a U2U Network—Refer to Figures 13 and 15

1. See unit electrical schematic.
2. Cable 'A' and 'B' are provided with each unit. One only is used as follows:
 - Liebert IntelliSlot based communications - Cable 'A' is preconnected to P65 on I/O board and P65 on the Liebert IntelliSlot power supply
 - Non-Liebert IntelliSlot-based communications—Cable 'B' is pre-connected to Terminals 77 & 78 but must be exchanged with Cable 'A' at P65 on the I/O board.
3. A Liebert IntelliSlot option bay is provided for a maximum of two optional Liebert IntelliSlot Web-LBDS or Liebert IntelliSlot 485-LBDS cards.
4. When a large display is used, both cables (P64A and P66) are required.
5. On units with the standard small display, Cable 'C' is provided for unit to unit (U2U) networking. Cable 'C' is pre-connected to P64A on the I/O board. The customer connection point is in the field-wiring area near the Liebert IntelliSlots.
6. On units with the optional large display, Cable 'C,' Cable 'D,' and a crossover coupler are provided for unit-to-unit (U2U) networking. To enable U2U networking, unplug the red cable from P64A near the I/O board and connect to one side of the crossover coupler. Connect Cable 'C' to P64A as shown. The customer connection point for Cable 'C' is located in the field wiring area, near the Liebert IntelliSlot bays. Connect Cable 'D' to the other side of the crossover coupler as shown. The customer connection point for Cable 'D' is also in the field wiring area, near the Liebert IntelliSlot bays. This connects the I/O board and the display to the private U2U network.
7. When the optional remote T/H sensors are supplied, the customer connection point is in the field wiring area, near the Liebert IntelliSlot bays. The cable supplied with the remote T/H sensors is marked *unit end* and *sensor end*. Match the six-pole plug on the unit end of the cable with the six-pole connector in the unit. Secure the fork terminal on the cable shield to the metal plate adjacent to the six-pole connector.

Figure 13 Liebert iCOM wiring—Unit as shipped

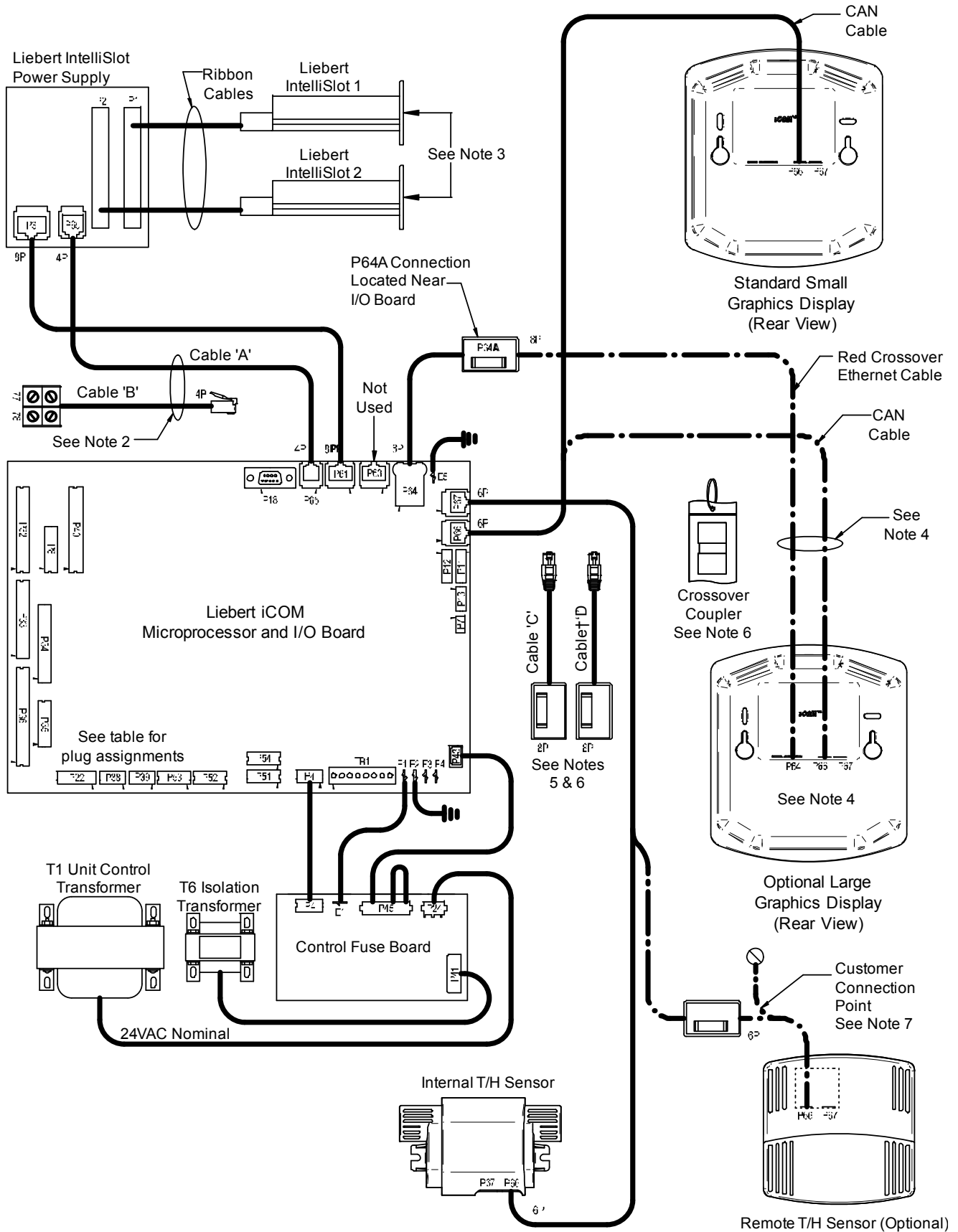

194273

Figure 14 Wiring a small display for U2U network operation

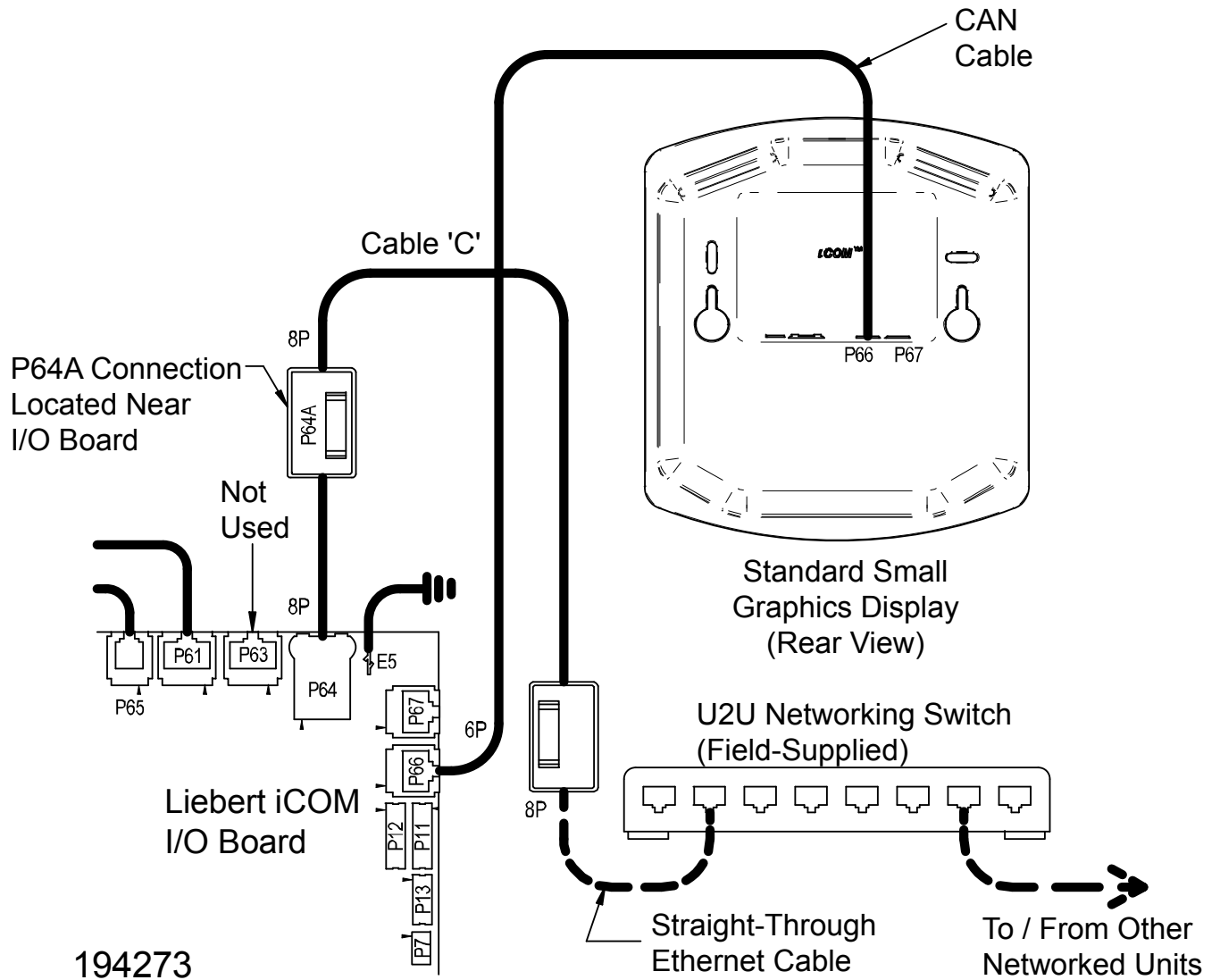

Figure 15 Wiring a large display for U2U network operation

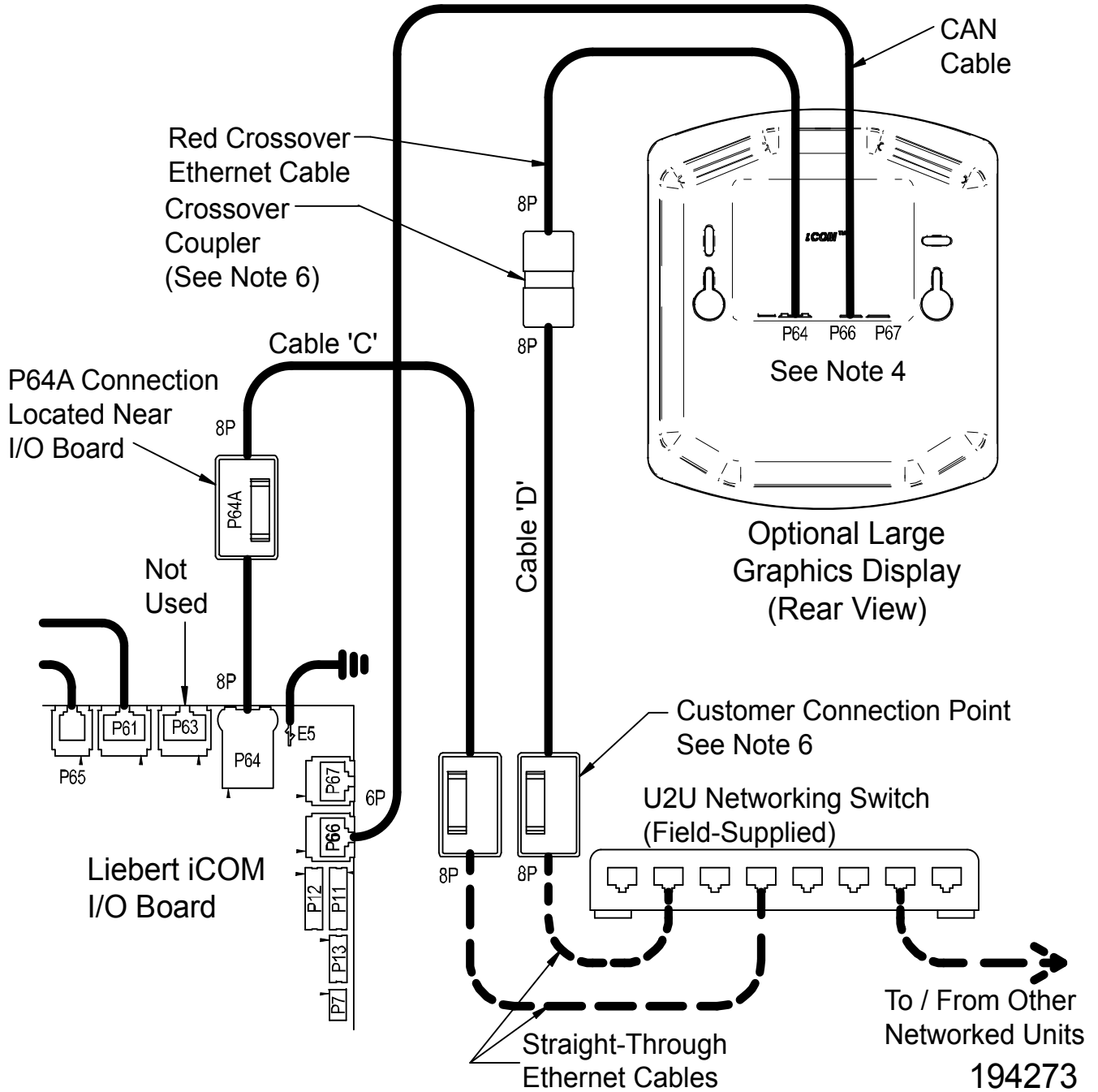
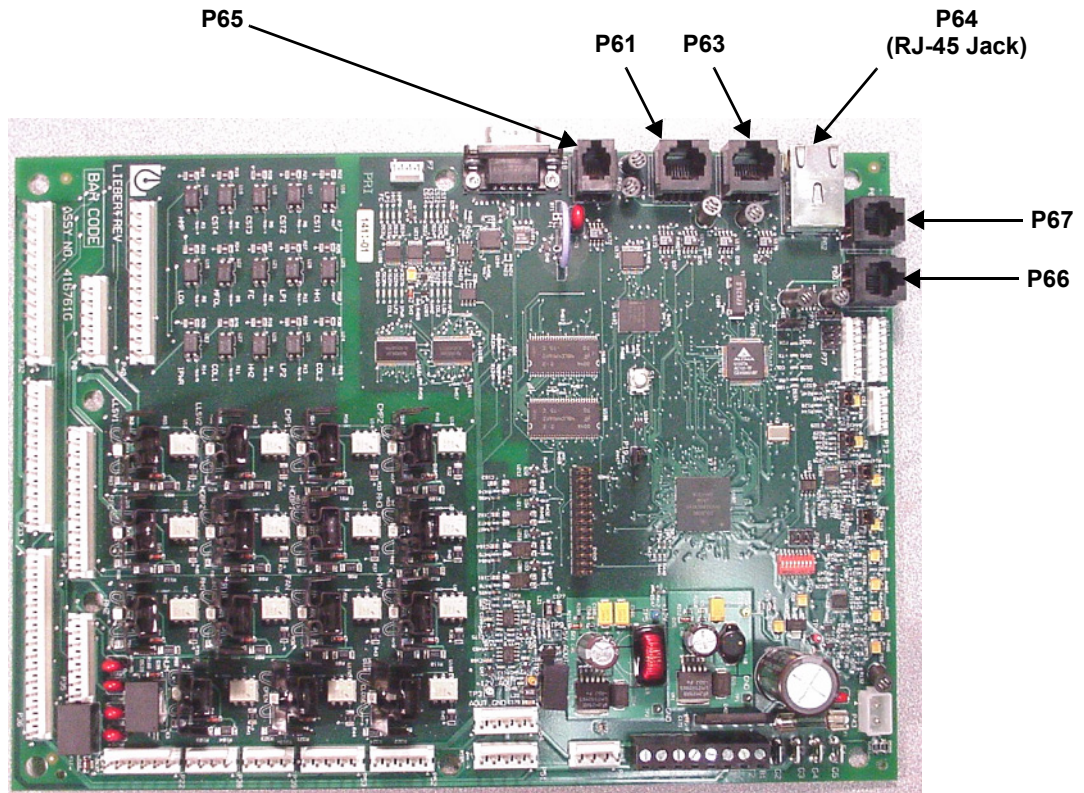

Figure 16 Liebert iCOM input-output control board



4.7 Entering Network Setup Information

Setting up a U2U network requires setting a unique IP addresses for each unit, choosing a U2U address and designating the U2U group. Refer to **Figure 17** for the setup screen for the control board (installed inside the Liebert Challenger 3000/Liebert Challenger ITR) and **Figure 18** for the setup screen for the Liebert iCOM on the front of the Liebert Challenger 3000/Liebert Challenger ITR.

Figure 17 Control board U2U network setup screen

SYSTEM/NETWORK SETUP (page 2 of 2)			SYSTEM
S834	PASSWORD (Actual Level 3)		????
S835	Monitoring Protocol		Velocity
S836	IP Address		126.001.060.212
S837	Netmask		255.255.255.192
S838	Gateway		126.001.060.213
S839	MAC		00:00:68:19:02:03
S840	U2U Protocol		GBP
S841	U2U Address		1
S842	U2U Group		15
S843	Bootloader Variables	OK	No
S844	Static RAM	OK	No

Attention: any changes done on these parameters must be followed by a 'Save+Reboot' command

Figure 18 Liebert iCOM display U2U network setup screen

SYSTEM/NETWORK SETUP (page 2 of 2)			SYSTEM
S812	PASSWORD (Actual Level 3)		????
S813	IP Address		126.001.060.212
S814	Netmask		255.255.255.192
S815	Gateway		126.001.060.212
S816	MAC		00:00:68:19:21:23
S817	U2U Protocol		GBP
S818	U2U Address		33
S819	U2U Group		15
S820			
S821	Bootloader Variables	OK	No
S822			

Attention: any changes done on these parameters must be followed by a 'Save+Reboot' command

4.8 Viewing Multiple Units with a Networked Large Display

When you first wake up the control, press the ESC key to return to the System view Status menu. This view shows an average of all the units on the network and any alarms present. To view a specific unit on the network, press either the enter key or down arrow key. When you do this, you will see the word *System* in the top left of the screen change to a unit number. Using the left and right arrow keys you can toggle through the various units on the network. To go back to the System view, or back one level from any menu in the control, press the ESC key.

Figure 19 Menu tree—Large display, networked

Unit # or *System* will be displayed in the top left corner of the screen .

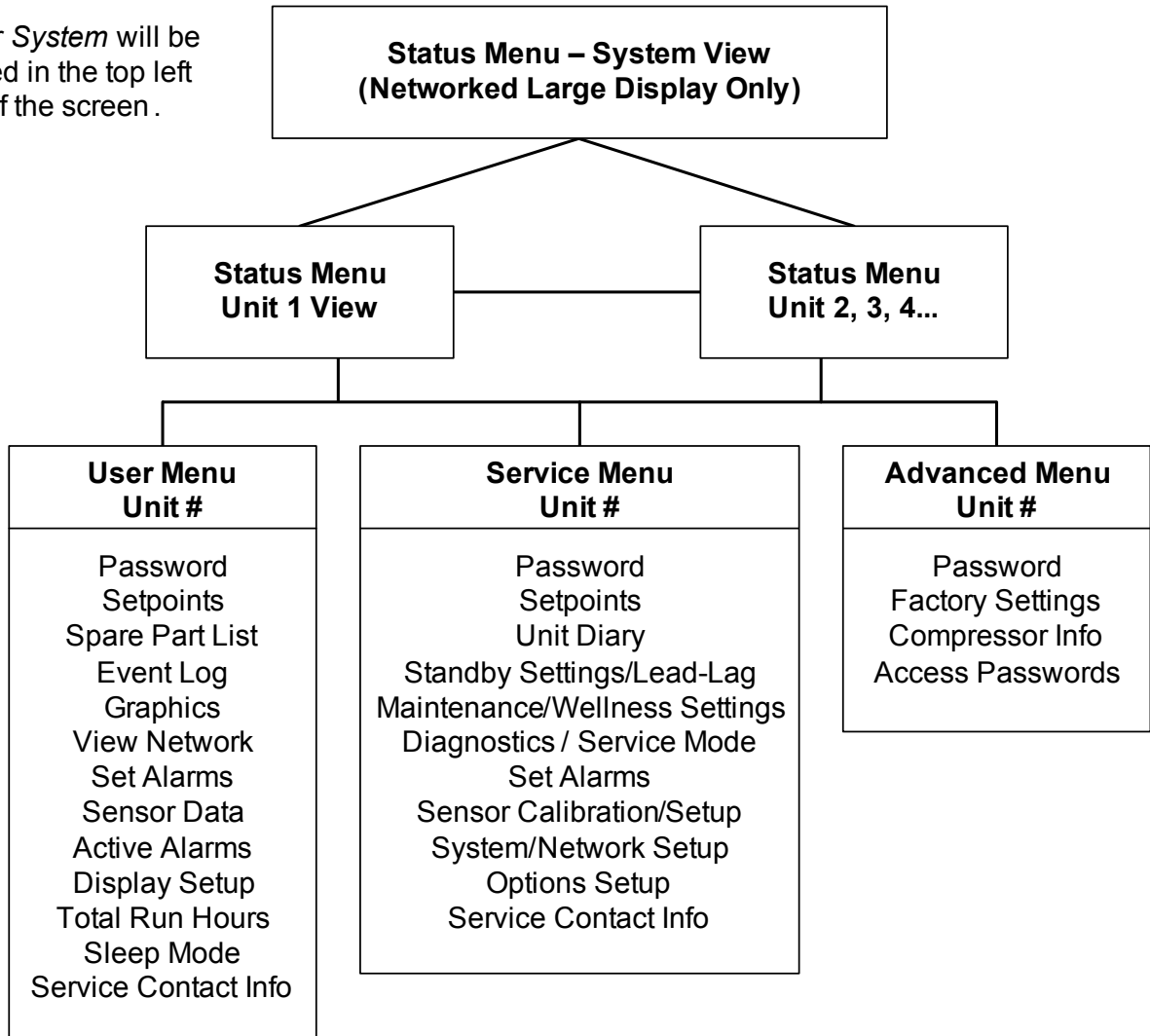

5.0 OPERATION

The Liebert iCOM display for your Liebert cooling unit features an easy-to-use, menu-driven liquid crystal display (LCD). All unit settings and parameters can be viewed and adjusted through three menus: User, Service and Advanced. All active alarms are displayed on the LCD and annunciated.

The control is shipped from the factory with default selections for all necessary settings. Adjustments can be made if the defaults do not meet your requirements.

References to menu items in this manual are followed by the main menu and the submenu where they can be found.

For example:

- **Temperature Setpoint (User Menu, Setpoints)** - The Temperature Setpoint parameter is located in the User menu under the Setpoints submenu.
- **High Return Humidity (Service Menu, Set Alarms)** - The High Return Humidity alarm is located in the Service menu under the Set Alarms submenu.

5.1 Single Unit Functions

5.1.1 Unit/Fan Control

Start - Stop

Unit On means the fan output is activated. The unit can be switched On and Off from two inputs:

- Remote On/Off input
- Display button

Pressing the On/Off key on a small display will control only the cooling unit it is connected to regardless, of whether the cooling unit is a stand-alone unit or part of a network.

Pressing the On/Off key on a large display of a stand-alone cooling unit will control only that unit.

The effect of pressing the On/Off key on a large display connected to a network depends on the view: System or Unit.

- In System view, pressing the On/Off key shows a warning asking for confirmation to **shut down the entire system**.
- In Unit view, pressing the On/Off key affects only the unit being viewed, without a confirmation request.

Each time a unit is powered On or Off, an event is added to the Event Log in the User menu.



NOTE

Customer switches: remote On/Off (if used) and display On/Off switches are in series. A cooling unit will start only if both switches are On; if one of these switches is Off, the unit will stop. Safety devices within the unit are also in series and will shut the unit down if required.

Figure 20 Start-stop priority switches

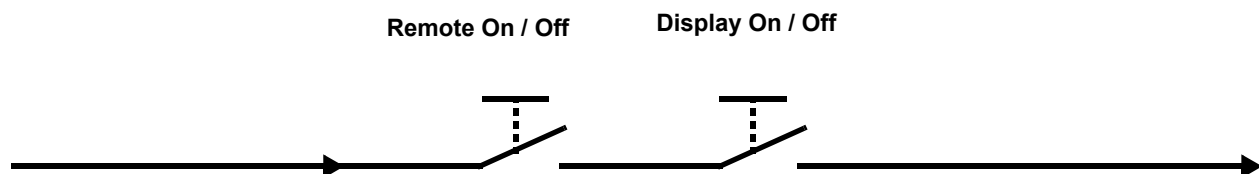

NOTE

If Remote On/Off is not used, a jumper is inserted to bypass the switch. Unit auto restart will begin once the control has booted.



WARNING

Risk of electric shock. Can cause injury or death.

The Liebert iCOM microprocessor does not isolate power from the unit, even in the “Unit Off” mode. Some internal components require and receive power even during the “Unit Off” mode of Liebert iCOM control.

The only way to ensure that there is NO voltage inside the unit is to install and open a remote disconnect switch. Refer to unit electrical schematic.

Autorestart

When there is a loss of power to the cooling unit and power comes back, the unit will return to its previous operating status—On if it was On before the power failed, Off if it was Off.

When power returns, the autorestart time—time-selectable: Single Unit Auto Restart (Service Menu, Options Setup)—controls the start of the unit. The autorestart time runs in a loop, starting the next unit each time when elapsed. With units in a U2U network, the autorestart will begin with Unit #1.

Loss of Power Alarm

A Loss of Power Alarm is activated when power is restored after an interruption. If acknowledged, the alarm resets automatically after 30 minutes. This alarm can be set to different event types (Message, Alarm or Warning) and can be disabled under menu item Loss of Power (Service Menu, Set Alarms).



NOTE

Loss of power alarm will be activated only on units that had the fan on before power was lost.

Fan Alarm / Fan Protection Settings

The fan operation is protected by two devices: motor protection (optional) and a differential pressure switch. The differential pressure switch ensures that the blower(s) are moving air and the motor protection monitors for main fan overload. If either protection device triggers, an alarm will be announced by a buzzer, alarm relay and event to monitoring after an adjustable time-delay (Main Fan Overload and Loss Of Airflow in Service Menu, Set Alarms).

The time delay at the unit start is always five seconds shorter than the control delay (to avoid short component starting when the fan is not working). During operation, the fan delay is fixed to 15 seconds.

There are two selection possibilities for both, Loss Of Airflow and Main Fan Overload:

- **Shutdown**—stops the unit (intended for DX models).
- **Disable**—stops the humidifier, electrical heaters and dehumidification; allows cooling and free-cooling only (intended for chilled water models / external cooling).



NOTE

When the Main Fan Overload alarm is active, the Loss of Airflow alarm is masked out. If a loss of airflow occurs, the compressor, heaters and humidifier will all turn Off until airflow is restored.

5.1.2 General Compressor Requirements

Low-Pressure Time Delay

When the compressor starts, the low-pressure input is ignored for a selected period of time based on the setting of the Low Pressure Alarm Delay (Service Menu, Options Setup). This permits the pumps to begin operating normally without nuisance alarms at startup.



NOTE

Low-pressure condition could be read through contacts or through pressure transducers with threshold setting.

Pump Down—Air Cooled with Condenser Only Units



NOTE

Pump down activation is determined by the type of unit; these units do not have a pump-down function: Glycol, GLYCOOL and remote condensing units.

The Pump Down operation is performed to protect the compressor oil from being diluted with liquid refrigerant, which helps ensure that the compressor is properly lubricated for the next startup. The Pump Down operation operates in the following manner:

Pump down is always performed loaded (for digital scroll: control solenoid valve disabled).

Digital Scroll Only: When pump down has finished successfully, pump down will be continued for another half-second with the control solenoid valve energized.

High Pressure Alarm

When the compressor is initially activated, the system will be monitored for a high pressure situation. When a high pressure situation is detected during the first 10 minutes of operation, the unit will attempt to correct the problem several times without notification. This alarm will automatically reset when the pressure drops to an acceptable operating range. If the unit is unsuccessful in correcting the problem, an alarm will occur and the affected compressor will be locked Off. If high head pressure alarm trips three times in a rolling 12 hour period, the affected compressor will be locked Off.

Once the compressor is locked Off, it will not come back On until main power is reset, or until the HP Alarm Counters (Service Menu, Diagnostics) are reset to 0.



NOTE

If the unit is equipped with manual reset high head pressure switches, or if the auto reset high head pressure switches don't reset, the compressor will not be turned back On, but there will be a 30-second delay from when the high head pressure situation occurs and when the alarm is annunciated.

Digital Scroll High Temperature

A protective maximum operating compressor temperature limit is imposed on units with digital scroll compressor(s) with thermistor. Once the digital scroll temperature reaches the maximum temperature threshold, the compressor will be locked out for at least 30 minutes and an alarm will be annunciated. If after 30 minutes the temperature has cooled to a safe operating temperature, the compressor will resume operation.

The HT 1 Alarm Counter (Service Menu, Diagnostics) records the number of high-temperature alarms. Once these counters reach five occurrences in a rolling four-hour period, the compressor will be locked out. The alarm can be reset once the temperature returns to a safe level by:

1. Setting the counter back to 0 from the display and pressing the alarm reset button.
2. Shutting Off power to the control board by turning the cooling unit's main power disconnect switch Off and On.

5.1.3 Compressor Timing

To help maximize the life of your compressor(s), there is a start-to-next start delay for each single compressor.

A Minimum On time and a Minimum Off time may be selected in the Advanced menu (minimum three minutes for single phase compressors). Consult the factory on how to modify the Minimum On and Off time settings.

Evaluate the start operation of the unit (with pump down).

1. Close LLSV
2. Wait for LPS to make or ignore for WSK time
If LPS is made before WSK has expired, allow the compressor to continue running, if not then stop compressor and alarm low pressure alarm.
3. Once LPS makes start compressor.
4. Verify the alarm phrase for the WSK and the low pressure switch.

5.2 Control Types

5.2.1 Proportional Control

This is a standard control method that maintains the room at a temperature proportional to the load. The temperature maintained increases as the room load increases. At full load the room would be controlled at a temperature equal to the temperature setpoint plus the temperature sensitivity.

5.2.2 PI Control

The PI control combines two individual terms to determine the control output for a given set of conditions. Note that PI control is used only for temperature. If PI control is selected, humidity will continue to use proportional control.

The proportional (P term) is determined by the difference between the current temperature and the control setpoint. This term is expressed in % cooling (heating) desired for each degree above (below) the setpoint. It is adjustable from 0% to 100% per degree. The purpose of this term is to adjust the control output for any deviation between the current temperature and the control setpoint.

The integral (I term) is determined by two things: the difference between the temperature and control setpoint and the amount of time this difference has existed. This term is expressed in % cooling (heating) desired for each minute and degree above (below) the setpoint. It is adjustable from 0% to 100% per degree-minute. The purpose of this term is to force the control to maintain the temperature around the setpoint by slowly but continuously adding (subtracting) a small amount of cooling (heating) to the total control output until the temperature is at the setpoint.

A suggested tuning procedure is as follows:

1. Initially adjust the integral setting to 0%.
2. Starting with 20%, adjust the proportional setting in small increments (10% steps) until the control sustains a constant hunting action (the temperature swings are approximately the same amplitude from one peak to the next).
3. Note the time in minutes between peaks of adjacent temperature swings and the amplitude of the temperature swing (degrees above the setpoint).
4. Adjust the proportional control setting to about 1/2 the value obtained in **Step 2**.
5. Adjust the integral setting to a value calculated by the following equation:

$$\frac{\text{Approximate room load (in \% full load)}}{\text{Time between peaks} \times \text{peak amplitude} \times 4}$$



NOTE

If this calculation results in a value of less than 1%, then set the integral to 1%.

The tuning procedure above is only an approximation for an initial set of adjustments and are based on the “average” room characteristics. Your particular settings may need to be further adjusted for optimum PI control performance. Some suggestions for additional tuning are as follows:

- If cooling output overshoot is occurring on load changes, decrease the proportional setting.
- If system hunting occurs with constant room load, decrease the integral setting.
- If the control responds too slowly, resulting in large temperature excursions on a load change, increase the proportional setting.
- If a constant temperature deviation exists between the temperature and setpoint, increase the integral setting.

5.2.3 Intelligent Control (Chilled Water Only)

The intelligent control operates from a set of general rules that define how the control output should be adjusted for different system conditions. The rules are designed to duplicate the actions that an experienced human operator would take if manually controlling the system.

Just as an operator might take several things into consideration before making a temperature control decision, the intelligent control can be programmed to do likewise. For example, not only is the current temperature used in making temperature control decisions, but also conditions such as:

- How fast is the temperature changing?
- What direction is the temperature changing?
- What is the cooling output now?
- What was the cooling output in the past?
- How long ago was the cooling output changed?
- and other factors.

Any number of rules can be used in an intelligent control to define the controls operation under various operating conditions. Hence, several advantages are gained from this type of control over a more standard control approach that uses a fixed mathematical equation to define the operation of the control for all conditions (such as a proportional or PI control). You can expect intelligent control to be more efficient and precise for most applications, but system performance based on room conditions is not as predictable as standard approaches that use a fixed equation.

6.0 ALARM DESCRIPTIONS

The Liebert iCOM will audibly and visually annunciate all enabled alarms. Alarms are wired from Terminal 24 through a normally open contact to locations 50, 51, 55 and 56, respectively, for alarms 1 through 4.

The alarms can be delayed from 0 to 255 seconds.

The alarms can be designated as WARNING, URGENT, or DISABLED. Alarms designated as WARNINGS are annunciated after the Time Delay, but do not energize the Common Alarm Relay. If designated as URGENT, they are annunciated after the Time Delay as a WARNING alarm and then re-annunciated after a user programmable period from 0 minutes to 999 hours as an URGENT alarm. When annunciated as an URGENT alarm, the Common Alarm Relay is activated.

When a new alarm occurs, it is displayed on the screen and the audible alarm is activated. If the Liebert Challenger 3000/Liebert Challenger ITR with iCOM is communicating with a Liebert site monitoring product, the alarm is also transmitted. The display will also show a message to “PRESS ENTER KEY TO SILENCE” the alarm. After the alarm is silenced, the display will return to the Normal Status Display.

The alarms can also be silenced through communications with a Liebert site monitoring unit. Most alarms will reset automatically when the alarm condition is no longer present and only after it has been acknowledged by being “Silenced.” The exceptions are:

- The three software alarms: Loss of Power, Low Suction Pressure, and Short Cycle, which reset automatically 90 minutes after being “Silenced” or acknowledged.
- Some alarms, such as overloads and high pressure switches, may require a manual reset depending on your model.

An alarms history is retained in nonvolatile memory.

6.1 Standard Alarms

6.1.1 Change Filter

Periodically, the return air filters in the environmental units must be changed. The Change Filter alarm notifies the user that filter replacement is necessary. A differential air pressure switch closes when the pressure drop across the filters becomes excessive. The switch is adjustable using the procedure on the switch label.

6.1.2 Compressor Overload

An optional tri-block overload device can be used for the compressor. Compressor overload may be manual or automatic reset, depending on your model. Overload is located at the electric connection box on the compressor.

6.1.3 High Head Pressure

Compressor high head is monitored with a pressure switch. One SPDT pressure switch is used for the compressor in the unit. If head pressure exceeds 360 PSIG, the switch opens the compressor contactor and sends an input signal to the control. On a self-contained system, the head pressure switch located at the compressor requires a manual reset and the alarm condition to be acknowledged on the front display panel. On a split system, the high head pressure condition is acknowledged by pressing the alarm silence button that will clear the alarm if the high head pressure condition no longer exists. On a split system, if the compressor is Off for 1 hour, the control goes into a special "cold start mode." In the cold start mode on a call for cooling or dehumidification, the Liquid Line Solenoid Valve (LLSV) is energized. If the high pressure switch does NOT trip within 10 seconds, the control returns to normal operation of monitoring the high head pressure switch for three occurrences in a 12-hour period. It is a rolling timer; after the third high head alarm occurs and is acknowledged by the user, it will lock Off the compressor. If while in the cold start mode, the high head pressure switch DOES trip within 10 seconds of the activation of the LLSV, the control does not annunciate the alarm. The control will turn Off the LLSV and delay 10 seconds. The control will permit this occurrence two more times or a total of three times. If on the fourth try the high head pressure switch trips within 10 seconds, the control will annunciate the alarm, turn Off the LLSV, wait for the user to acknowledge the alarm and hold the compressor Off for three minutes, which is the normal short cycle control. On the third occurrence, the control will lock the compressor Off until the control power is reset.

On air cooled systems, check for power shut Off to the condenser, condenser fans not working, defective head pressure control valves, closed service valves, dirty condenser coils, and crimped lines. Also, make sure that when the compressor contactor is energized, the side switch on the contactor closes to energize the control circuit on the air cooled condenser.

On water/glycol/GLYCOOL systems, check water regulating valves. Verify water/glycol flow (are pumps operating and service valves open?). Is water tower or drycooler operating? Is the coolant temperature entering the condenser at or below design conditions? Is relay R5 operating during cooling to turn On the drycooler?

6.1.4 High Humidity

The return air humidity has increased to the High Humidity Alarm setpoint. Is the unit setup for dehumidification (check DIP switch)? Check for proper setpoints. Does the room have a vapor barrier to seal it from outdoor humidity? Are doors or windows open to outside air? Run diagnostics to make sure the cooling system is working properly (the cooling system dehumidifies).

6.1.5 High Humidity and Low Humidity (Simultaneously)

If these two alarms are displayed at the same time, the humidity input signal is lost. Dashes will be displayed for the humidity reading. The control system will deactivate humidification and dehumidification. Check for a disconnected cable or a failed sensor.

6.1.6 High Temperature

If the return air temperature has increased to the High Temperature Alarm setpoint, check for proper setpoints. Is the room load more than the unit can handle (is the unit capacity too small)? Run diagnostics to make sure all cooling components are operating (compressor and/or valves).

6.1.7 High Temperature and Low Temperature (Simultaneously)

If these two alarms are displayed at the same time, the temperature input signal is lost (or the humidity is out of sensor range: 15 to 85% RH). Dashes will be displayed for the temperature reading. The control system will initiate 100% cooling. Check for a disconnected cable or a failed sensor.

6.1.8 Humidifier Problem

Infrared Humidifiers

This alarm is activated by the high-water float switch in the humidifier pan assembly. The high-water float switch is normally closed and opens upon alarm condition. Check for drain clog and, if present, clean drain. Check for float switch stuck high; replace the switch as necessary. Check for proper operation of the humidifier water makeup valve.

Steam Generating (Canister) Humidifiers

This alarm is activated by a signal from the humidifier control indicating that the canister needs to be replaced.

6.1.9 Loss of Air Flow

A differential air pressure switch is used to indicate loss of air flow in Liebert Challenger 3000/Liebert Challenger ITR units.

Check for blockage of unit air outlet or inlet. Check blower motor fuses and overload reset. Check for broken belts. Make sure blower wheels are tight to shaft. Run diagnostics to see if the fan contactor is working properly.

6.1.10 Loss of Power

If the unit has lost power, or the disconnect switch was turned Off before the unit On switch was pressed (to turn the unit Off), this local alarm will occur when power is restored to the unit. A Liebert remote monitoring unit (optional) will immediately indicate loss of power.

6.1.11 Low Humidity

If the return air humidity has decreased to the Low Humidity Alarm setpoint, check to make sure that the unit is setup for humidification (check DIP switch). Check for proper setpoints. Does the room have a vapor barrier to seal it from outdoor humidity? Are doors or windows open to outside air? Run diagnostics to make sure the humidifier system is working properly.

6.1.12 Low Suction Pressure

A pressure switch monitors the suction pressure at the compressor inlet to monitor whether pressure has dropped below a factory preset point while the compressor is in cooling operation. When pressure drops below a factory preset point, the switch opens. After the positive start kit time delay, and the switch stays open for five minutes, the alarm is activated. The alarm stays active for 90 minutes.

Look for conditions that would cause loss of refrigerant. Check for piping problems such as leaks or crimped lines. Check for inoperative components such as liquid line solenoid valve, low pressure switch, expansion valve, and head pressure control valve. Check for closed service valves in the liquid line or at the condenser or receiver.

6.1.13 Low Temperature

If the return air temperature has decreased to the Low Temperature Alarm setpoint, check for proper setpoints. Run diagnostics to make sure all heating components are operating (contactors and reheats). Are reheats drawing the proper current? (See nameplate for amp rating.)

6.1.14 Main Fan Overload

An optional tri-block overload is required for this alarm, and may or may not replace internal motor overload, depending on your model. The overload device is located next to the main fan contactor in the line voltage section. The alarm is activated when the overload is tripped.

6.1.15 Short Cycle

On compressorized systems, if the compressor has exceeded 10 cooling starts in one hour or if the compressor has cycled five times in 10 minutes on the low pressure switch during non-cooling, the Short Cycle alarm will occur. This can be caused by low refrigerant level (but not low enough to activate Low Suction Pressure alarm) or room cooling load is small compared to capacity of the unit.

Check for leaks, crimped lines, and defective components. If room load is low, increase sensitivity to reduce cycling (proportional control). On GLYCOOL units, dirty filters can cause the coil freeze stats to cycle the compressor.

6.2 Optional Alarms

6.2.1 Loss of Water Flow

Available only with 3-way valves and occurs when no water flow is detected in the chilled water or condenser water supply line. An optional flow switch is required for this alarm. Check for service valves closed, pumps not working, etc.

6.2.2 Smoke Detected

Smoke is detected in the return air by an optional Liebert Smoke Detector. Check for source of smoke or fire, and follow appropriate emergency procedures.

6.2.3 Standby GC Pump On

The primary pump has failed, and the standby pump is activated (glycol cooled and GLYCOOL units only).

Check for problems with the primary pump (fuses blown, motor burnout, service valve shut, stuck check valve, impeller damage, etc.).

6.2.4 Standby Unit On

The primary environmental control system has had an alarm condition, and the standby system is activated.

6.2.5 Water Under Floor

Water is detected by an optional Liebert Water Detection System. Check under the raised floor for water or other leaks.



NOTE

The alarms are specified by the customer at the time of order. All alarms will report to a Liebert remote monitoring unit. Additional devices and wiring may be required at the factory for some of the alarms.

6.3 Set Alarms—User Menus

Table 3 Set alarms—User Menus

	Large Display	Small Display	Alarm Description	Range Large Display	Range Small Display	Res.	Std.
U201	PASSWORD	-	-	-	-	-	-
U202	Return Sensor Alarms	RTN SNSR	Std. Sensor Alarms Enable	0 = Disabled 1 = Enabled	0 = No, 1 = Yes	-	Enabled
U203	High Return Temperature	HI TEMP	Std. Sensor High Temperature Alarm	34-210 °F (1-99°C)	34-210 °F 1-99°C	1	80°F 27°C
U204	Low Return Temperature	LO TEMP	Std. Sensor Low-Temperature Alarm	34-210 °F (1-99°C)	34-210 °F (1-99°C)	1	65°F 18°C
U205	High Return Humidity	HI HUM	Std. Sensor High-Humidity Alarm	1-99%	1-99%	1	60%
U206	Low Return Humidity	HI HUM	Std. Sensor Low-Humidity Alarm	1-99%	1-99%	1	40%
U207	Sensor A Alarms	SENSOR A	Sensor A Alarms Enable	0 = Disabled 1 = Enabled	0 = No, 1 = Yes	-	Disabled
U208	High-Temperature Sensor A	HI TEMPA	Sensor A High-Temperature Alarm	34-210 °F (1-99°C)	34-210 °F (1-99°C)	1	90°F 32°C
U209	Low Temperature Sensor A	LO TEMPA	Sensor A Low-Temperature Alarm	34-210 °F (1-99°C)	34-210 °F (1-99°C)	1	55°F 13°C
U210	High Humidity Sensor A	HI HUM A	Sensor A High-Humidity Alarm	1-99%	1-99%	1	70%
U211	Low Humidity Sensor A	LO HUM A	Sensor A Low-Humidity Alarm	1-99%	1-99%	1	30%

7.0 COMPONENT OPERATION AND MAINTENANCE

7.1 System Testing

7.1.1 Environmental Control Functions

The performance of all control circuits can be tested by actuating each of the main functions. This is done by temporarily changing the setpoints.

Cooling

To test the cooling function, set the setpoint for a temperature of 10°F (5°C) below room temperature. A call for cooling should be seen and the equipment should begin to cool. A high temperature alarm may come On. Disregard it. Return setpoint to the desired temperature.

Heating

Reheat may be tested by setting the setpoint for 10°F (5°C) above room temperature. A call for heating should be seen and the heating coils should begin to heat. Disregard the temperature alarm and return the setpoint to the desired temperature.

Humidification

To check humidification, set the humidity setpoint for an RH 10% above the room humidity reading. For infrared humidifiers, the infrared element should come On. Steam generating humidifiers should click immediately as it energizes. After a short delay, the canister will fill with water. The water will heat and steam will be produced. Return the humidity setpoint to the desired humidity.

Dehumidification

Dehumidification can be checked by setting the humidity setpoint for an RH 10% below room relative humidity. The compressor should come On. Return humidity setpoint to the desired humidity.

Electric Panel

The electric panel should be inspected for any loose electrical connections.



WARNING

Risk of electric shock. Can cause injury or death.

The Liebert iCOM microprocessor does not isolate power from the unit, even in the “Unit Off” mode. Some internal components require and receive power even during the “Unit Off” mode of Liebert iCOM control.

The only way to ensure that there is NO voltage inside the unit is to install and open a remote disconnect switch. Refer to unit electrical schematic.

Be sure that all power has been disconnected from the unit before attempting to tighten any fittings or connections.

Control Transformer and Fuses

The control system is divided into four separate circuits. The control voltage circuits are individually protected by fuses located on the transformer/fuse board. If any of the fuses are blown, first eliminate shorts, then use spare fuses supplied with unit. Use only type and size of fuse specified for your unit.

The small isolation transformer on the board supplies 24 volts to the main control board. The transformer is internally protected. If the internal protector opens, the transformer/fuse board must be replaced. Also check the control voltage fuse on the main control board before replacing the transformer/fuse board.

Fan Safety Switch

The Fan Safety Switch is located in the low voltage compartment and consists of a diaphragm switch and interconnecting tubing to the blower scroll. The Fan Safety switch is wired directly to the control circuit to activate the alarm system if the airflow is interrupted

High-Temp Sensor

The optional high-temp sensor is a bimetal-operated sensing device with a normally closed switch. This device will shut down the entire unit when the inlet air temperature exceeds a preset point. It is connected between Terminals 1 and 2 at Plug P39.

Smoke Detector

The optional smoke detector power supply is located on the base of the upflow units, and at the top of downflow units. It is constantly sampling return air through a tube. No adjustments are required.

Water Detection Sensor



WARNING

Risk of fire or explosion. Can cause injury or death.

Do not use near flammable liquids or for flammable liquid detection.

The optional water detection devices available are a point leak detection sensor and a zone leak detection kit.

Figure 21 Liebert leak detection units



**Liebert Liqui-tect Point
Leak Detection Sensor**

LT460 Zone Leak Detection Kit

The point leak detection sensor provides leak detection at a critical point. A simple two-wire connection signals the alarms at a Liebert environmental unit or at a monitoring panel. Run wires to the Liebert unit and connect them to terminals 24 and 51, 55 or 56. Use NEC Class 2, 24V wiring. The sensor contains a solid state switch that closes when water is detected by the twin sensor probes. The sensor is hermetically sealed in all thread PVC nipple and is to be mounted where water problems may occur. The sensor should be located 6-8 feet (2-2.5m) from the environmental control unit in a wet trap or near a floor drain. It should not be mounted directly under the unit.

Figure 22 Recommended liquid sensor locations

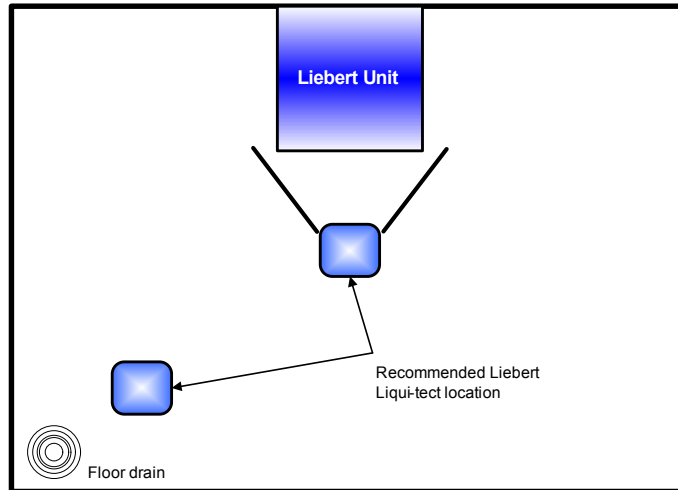

The zone leak detection kit provides leak detection for a defined zone. This kit is ideal for perimeter sensing or serpentine coverage of small areas. A simple, two-wire connection signals the alarms at a Liebert environmental unit or at a monitoring panel. Run wires to the Liebert unit and connect them to terminals 24 and 51, 55 or 56. The sensor utilizes Liebert's LT500Y leak detection cable. The kit is offered with five different lengths of cable sized specifically for the type of Liebert Environmental unit (see matrix below). Refer to matrix below for the recommended location of leak detection cable.

Table 4 Zone leak detection kit installation scenarios

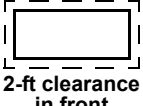
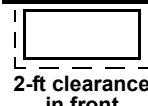
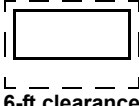
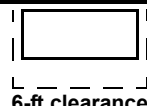
	Scenarios			
	Upflow Unit Detection around entire unit  2-ft clearance in front	Upflow Unit Detection on sides and in front of unit  2-ft clearance in front	Downflow Unit Detection around entire unit  6-ft clearance in front	Downflow Unit Detection on sides and in front of unit  6-ft clearance in front
	Distance From Unit, feet (m)			
In back	2 (0.6)	No cable behind	1 (0.3)	No cable behind
On sides	2 (0.6)	2 (0.6)	1 (0.3)	1 (0.3)
In front	2 (0.6)	2 (0.6)	6 (1.8)	6 (1.8)
Unit (footprint-in.)	Part Number			
Liebert Challenger 3000 and Liebert Challenger ITR (32.5 x 32.5)	LT460-Z30	LT460-Z20	LT460-Z30	LT460-Z25

Remote Shutdown

A connection point is provided for customer supplied remote shutdown devices. This terminal strip is located at the top of upflow units, and at the base of downflow units. Terminals 37 and 38 on the terminal strip are jumpered when no remote shutdown device is installed.

7.2 Filters

Filters are usually the most neglected item in an environmental control system. To maintain efficient operation, they should be checked monthly and changed as required. Because replacement intervals vary with environmental condition and filter type, each unit is equipped with a filter clog switch. This warns of restricted airflow through the filter compartment by activating the Change Filter alarm.

Turn power Off before replacing filters.

Liebert Challenger 3000 Liebert and Challenger ITR filters are 28-1/2" by 29-1/2", either 2" or 4" thick, plus an optional 2" thick pre-filter. The filter is replaced from the front of the unit. On upflow units, the filter is vertical, in front of the lower compartment. Pull the filter out toward you to remove it. On downflow units, the filter is horizontal, above the electrical panel. Slide the filter out toward you to remove it.

After replacing the filter(s), test the operation of the filter clog switch. Turn the adjusting screw counter clockwise to trip the switch — this will energize the Change Filter alarm. To adjust the switch proceed as follows: With the fan running, set the switch to energize the light with clean filters. The unit panels must all be in place and closed to accurately find this point. Then turn the adjusting knob one turn clockwise, or to the desired filter change point.

7.3 Blower Package

Periodic checks of the blower package include: belt, motor mounts, fan bearings, and impellers.

7.3.1 Fan Impellers and Bearings

Fan impellers should be periodically inspected and any debris removed. Check to see if they are tightly mounted on the fan shaft. Rotate the impellers and make sure they do not rub against the fan housing.

Bearings used on the units are permanently sealed and self-lubricating. They should be inspected for signs of wear when the belt is adjusted. Shake the pulley and look for movement in the fan shaft. If any excessive movement is noticed, bearings should be replaced. However, the cause of the wear must be determined and corrected before returning the unit to operation.

7.3.2 Belt

The drive belt should be checked monthly for signs of wear and proper tension. Pressing in on belts midway between the sheave and pulley should produce from 1/2" to 1" (12 to 25 mm) of movement. Belts that are too tight can cause excessive bearing wear.

Belt tension can be adjusted by raising or lowering the fan motor base. Loosen nut above motor mounting plate to remove belt. Turn nut below motor mounting plate to adjust belt tension. If belt appears cracked or worn, it should be replaced with a matched belt (identically sized). With proper care, a belt should last several years.

NOTICE

Risk of improper adjustment. Can cause equipment damage.

After adjusting or changing the belt, check to ensure that the motor base nuts are tightened. The bottom adjustment nut should be finger tight. The top locking nut should be tightened with a wrench.

7.3.3 Air Distribution

All unit models are designed for constant volume air delivery. Therefore any unusual restrictions within the air circuit must be avoided. For downflow models operating on a raised floor, refer to the following table for recommended free area for proper air flow.

Table 5 Recommended free area ft² (m²) for grilles or perforated panels at output velocities of 550 and 600 fpm (2.8 and 3.1 m/s)

Model	550 FPM (2.8 m/s)	600 FPM (3.1 m/s)
60 Hz Units		
3 Ton	3.3 (0.31)	3.0 (0.28)
5 Ton	5.1 (0.41)	4.7 (0.44)
50 Hz Units		
3 Ton	3.3 (0.31)	3.0 (0.28)
5 Ton	4.7 (0.44)	4.3 (0.40)

Grilles used in raised floors vary in size, the largest being 18" x 6" (46 cm x 15 cm). This type of grille has approximately 56 in² (361 cm²) of free area. Perforated Panels are usually 2' x 2' (61 cm x 61 cm) and have a nominal free area of approximately 108 to 144 in² (697 to 929 cm²).

NOTICE

Risk of airflow restriction. Can cause inefficient operation and equipment overheating.

In raised-floor use, all under-floor restrictions, such as clusters of cables or piping, must be avoided because they may form barriers to airflow. Whenever possible, cables and pipes should be run parallel to the airflow. Never stack cables or piping.

7.4 Refrigeration System

Each month, the components of the refrigeration system should be inspected for proper function and signs of wear. Since, in most cases, evidence of malfunction is present prior to component failure, periodic inspections can be a major factor in the prevention of most system failures.

Refrigerant lines must be properly supported and not allowed to vibrate against ceilings, floors or the unit frame. Inspect all refrigerant lines every six months for signs of wear and proper support. Also inspect capillary and equalizer lines from the expansion valve and support as necessary.

Each liquid line has a sight glass that indicates liquid refrigerant flow and the presence of moisture. Bubbles in the sight glass indicate a shortage of refrigerant or a restriction in the liquid line. The moisture indicator changes from green to yellow when moisture is present in the system.

7.4.1 Suction Pressure

Suction pressure will vary with load conditions. The low pressure switch will shut the compressor down if suction pressure falls below the cut-out setting. High suction pressure reduces the ability of the refrigerant to cool compressor components and can result in compressor damage. Minimum (pressure switch cut-out setting) and maximum (design operating) suction pressures are in **Table 6**.

Table 6 Suction pressures - R407c

System	Minimum PSIG (kPa)	Maximum PSIG (kPa)
Air w/FSC (Fan Speed Control)	15 (103)	95 (654)
Air w/Lee-Temp Control (Floodback head pressure control)	20 (137)	95 (654)
Water Cooled	20 (137)	95 (654)
Glycol Cooled	20 (137)	95 (654)

7.4.2 Discharge Pressure

Discharge Pressure can be increased or decreased by load conditions or condenser efficiency. The high pressure switch will shut the compressor down at its cut-out setting. Refer to **Table 7**, below.

Table 7 Discharge pressures

System Design		Discharge Pressure PSIG (kPa)
Air Cooled		260 (1795)
Water/Glycol Cooled	65-75°F (18-24°C) fluid	210 (1450)
	85°F (29°C) fluid	225 (1550)
	115°F (46°C) fluid	295 (2035)
Maximum		330 (2275)
High Pressure Cut-Out		360 (2482)

7.4.3 Superheat

Superheat can be adjusted by the Thermostatic Expansion Value (TEV). To determine superheat:

1. Measure the temperature of the suction line at the point the TEV bulb is clamped.
2. Obtain the gauge pressure at the compressor suction valve.
3. Add the estimated pressure drop between bulb location and suction valve.
4. Convert the sum of the two pressures to the equivalent temperature.
5. Subtract this temperature from the actual suction line temperature. The difference is superheat.

7.4.4 Thermostatic Expansion Valve

Operation

The thermostatic expansion valve performs one function. It keeps the evaporator supplied with enough refrigerant to satisfy load conditions. It does not effect compressor operation.

Proper valve operation can be determined by measuring superheat. If too little refrigerant is being fed to the evaporator, the superheat will be high; if too much refrigerant is being supplied, the superheat will be low. The correct superheat setting is between 10 and 15°F (5.6 and 8.3°C).

Adjustment

To adjust the superheat setting:

1. Remove the valve cap at the bottom of the valve.
2. Turn the adjusting stem counterclockwise to lower the superheat.
3. Turn the adjusting stem clockwise to increase the superheat.



NOTE

Make no more than one turn of the stem at a time. As long as 30 minutes may be required for the new balance to take place.

7.4.5 Hot Gas Bypass Valve—Not Available on Digital Scroll Units

Operation—Self-Contained Units

The hot gas bypass is inserted between the compressor discharge line and the leaving side of the expansion valve through the side outlet distributor. The system, with normal operation when the evaporator is under full load, will maintain enough pressure on the leaving side of the hot gas valve to keep the valve port closed.

If the load on the evaporator decreases, the evaporator will get colder. When the coil is too cold, the internal pressure in the evaporator drops and allows the hot gas bypass valve to open. Hot gas then mixes with the liquid coolant on the discharge side of the expansion valve raising the temperature and pressure in the evaporator. The net result is a reduction in the cooling capacity of the unit to match the load.

To aid in lubricating the compressor, the hot gas bypass solenoid is delayed for 30 seconds on the initial call for cooling and de-energized for 30 seconds during every 60 minutes of continuous operation.



NOTE

These procedures are not applicable to condensing units. For condensing unit information, refer to Liebert's condensing unit manual, SL-10059, available at the Liebert Web site, www.liebert.com

Adjustment

Upon deciding what evaporator temperature is desired, the following procedure should be used to adjust the hot gas bypass valve:

1. Install the suction and discharge pressure gauge.
2. Adjust the temperature setpoint to call for cooling so that the refrigeration compressor will run.
3. Remove the TOP adjusting nut from the valve.
4. Insert an Allen wrench in the brass hole at top of the valve in adjusting port, and turn CLOCKWISE if a higher evaporator temperature is required.
5. After obtaining the suction pressure required, reinstall the cap tightly making sure there are no leaks.
6. Let the evaporator operate for approximately 10 to 15 minutes to make sure the suction pressure is within the desired range.
7. There will be a fluctuation of approximately 3 to 6 PSIG (21 to 41 kPa) on the evaporator due to the differential on the hot gas bypass.
8. Return the temperature setpoint to desired number.

7.4.6 Air Cooled Condenser

Restricted airflow through the condenser coil will reduce the operating efficiency of the unit and can result in high compressor head pressure and loss of cooling.

Clean the condenser coil of all debris that will inhibit air flow. This can be done with compressed air or commercial coil cleaner. Check for bent or damaged coil fins and repair as necessary. In winter, do not permit snow to accumulate around the sides or underneath the condenser.

Check all refrigerant lines and capillaries for vibration isolation. Support as necessary. Visually inspect all refrigerant lines for signs of oil leaks.

Checking Refrigerant Charge (Lee-Temp/Flood Back Head Pressure Control)

The system refrigerant level must be checked periodically. To do so:

1. Adjust temperature setpoint in the unit so that the compressor will run continuously.
2. The refrigerant level is visible through two sight glasses on the receiver and will vary with ambient temperature.
 - a. 40°F (4.4°C) and lower — Midway on the bottom sight glass.
 - b. 40 to 60°F (4.4 to 15.6°C) — Bottom sight glass should be clear with liquid.
 - c. 60°F (15.6°C) and above — Midway on the top sight glass.
3. Return temperature setpoint to desired number.

Figure 23 Outdoor fan/condenser configuration

FAN SPEED CONDENSER

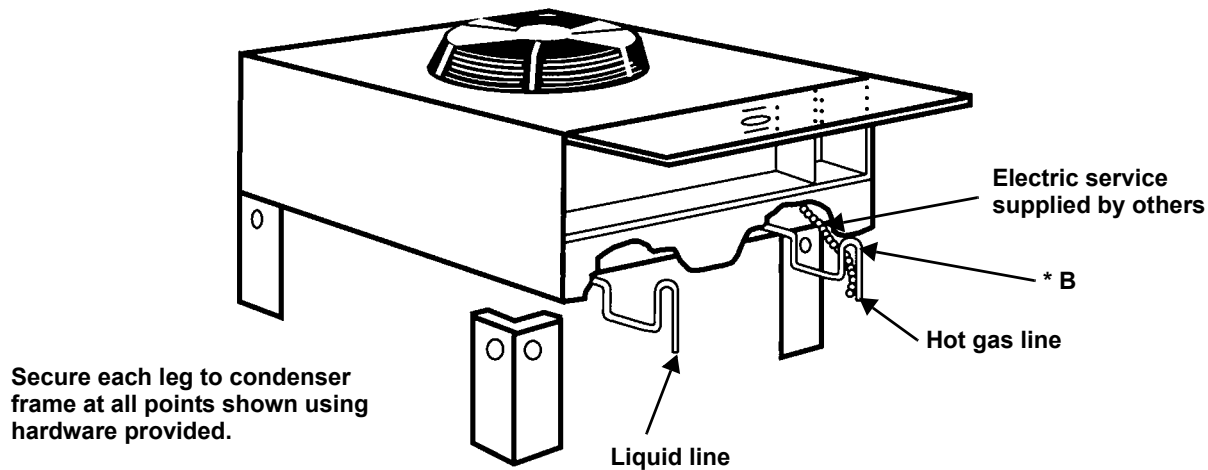

LEE-TEMP CONDENSER

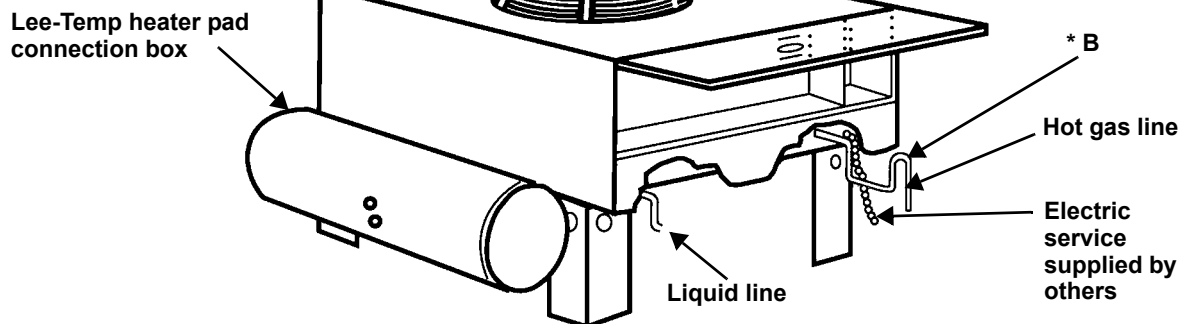

*B - Inverted traps are to be field-supplied and installed (typical). When installing traps, provide clearance for swing end of access door. Traps are to extend above base of coil by a minimum of 7-1/2" (190 mm).

7.4.7 Water/Glycol Cooled Condensers

Coaxial Condenser

Each water- or glycol-cooled module has a coaxial condenser that consists of a steel outside tube and a copper inside tube.

Coaxial condensers do not normally require maintenance or replacement if the water supply is clean. If your system operates at high head pressure with reduced capacity, and all other causes have been eliminated, the coaxial condenser may be obstructed and needs to be replaced.

7.4.8 Motorized Ball Valve—Digital Scroll Compressor

On water-cooled and glycol-cooled digital scroll units, the discharge pressure is controlled by a motorized ball valve. During unloaded operation, the pressure changes during each digital cycle could result in excessive repositions with a pressure operated water regulating valve. The control algorithm for the motorized ball valve uses an intelligent sampling rate and adjustable pressure thresholds to reduce valve repositions. The valve assembly consists of the brass valve, linkage and actuator.

Control

The valve actuator operates on 24VAC power and is controlled by a 2-10VDC proportional control signal. The valve full open to full close time is 60 seconds. At 2VDC the valve is closed; at 10VDC the valve is fully open. There is a 20-second delay to position the motorized ball valve before starting the compressor.

Control Method

The control utilizes an upper and lower pressure threshold with a 35 PSI (241 kPa) deadband to reduce valve movement. If the liquid pressure is between the upper and lower threshold the valve remains at the current position. If the liquid pressure exceeds the upper threshold the valve opens, and if the pressure falls below the lower threshold the valve closes. There are multiple adjustment bands to ease discharge pressure back into control range.

Adjustment

Both pressure thresholds can be shifted simultaneously over a 50 PSI (345 kPa) range (the 35 PSI [241 kPa] differential remains constant). The ball valve setpoint offset parameter in the Service menu can be adjusted from 0 to 50 PSI (345 kPa) to raise or lower the control band similar to the pressure adjustment on a water regulating valve. Units are factory set at a 30 PSI (207 kPa) setpoint offset (30 PSI [207 kPa] above minimum). This results in a 220 PSIA (1517 kPa) lower threshold and a 255 PSIA (1758 kPa) upper threshold pressure.

Startup

The setpoint offset is adjusted to the minimum value during startup, then transitions to the set value once the compressor reaches normal operating pressures. Additionally changes in fluid temperature could cause pressure changes that do not result in valve movement within the dead band on drycoolers. Fan cycling stats should be set to prevent continuous fluid temperature swings greater than 10°F (5.6°C) (see 7.4.10 - Drycooler Settings).

Location

The motorized ball valves are located in the condenser fluid return line. The three-way valve is piped in a mixing arrangement with the common port at the valve outlet.

Manual Control

The valve can be manually set by disconnecting AC power, depressing the manual override button on the valve actuator, and adjusting the valve position with the handle. You also have the option to control the motorized ball valves through the Service menu using manual mode to override the normal control.

7.4.9 Regulating Valve—Scroll Compressor

The water regulating valve automatically regulates the amount of fluid necessary to remove the heat from the refrigeration system, permitting more fluid to flow when load conditions are high and less fluid to flow when load conditions are low. The valve consists of a brass body, balance spring, valve seat, valve disc holders, capillary tube to discharge pressure, and adjusting screw.

Standard Valve - 150 psig (1034 kPa) system for 3 & 5 ton units (Johnson Controls Valve)
High Pressure Valve - 350 psig (2413 kPa) system for 5 ton units (Johnson Controls Valve)

Adjustment—The valve may be adjusted with a standard refrigeration service valve wrench or screw driver. Refer to **Table 7** for recommended refrigerant pressures.

To lower the head pressure setting, turn the square adjusting screw clockwise until the high pressure gauge indicates the desired setting.

To raise the head pressure setting, turn the adjusting screw counterclockwise until the desired setting is obtained.

Figure 24 Johnson Controls valve adjustment

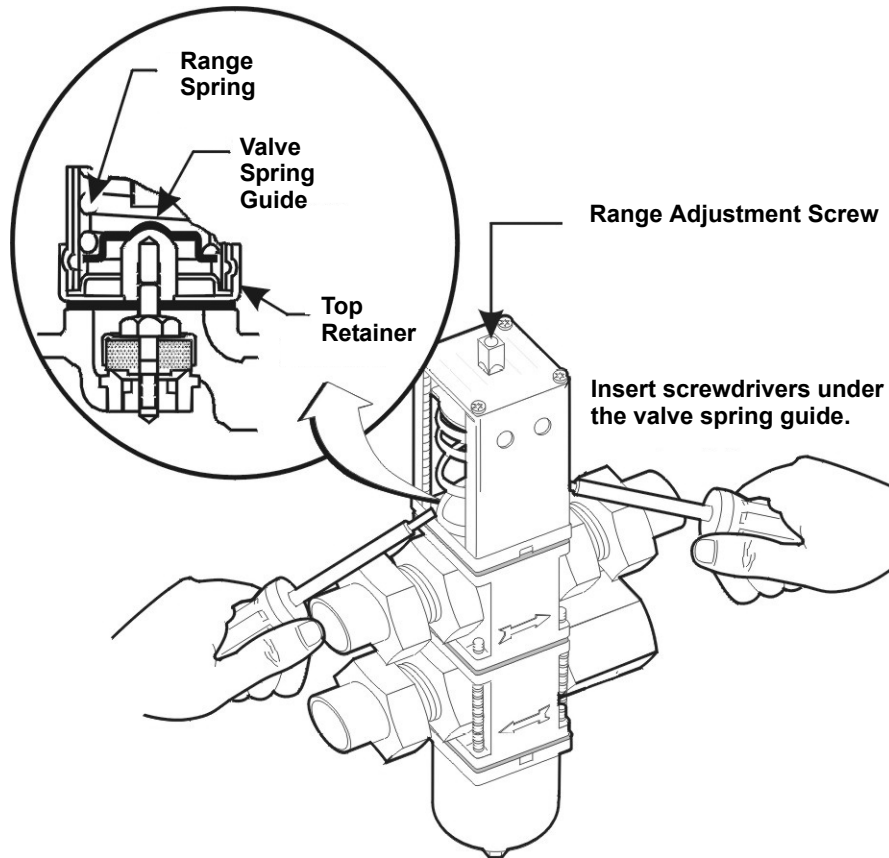

Manual Flushing—The valve may be flushed by inserting a screwdriver or similar tool under the two sides of the main spring and lifting. This action will open the valve seat and flush any dirt particles from the seat. If this fails, it will be necessary to disassemble the valve and clean the seat.

High Pressure Valve - 350 PSIG System (2413 kPa) for 3 Ton Units (Metrex Valve)

Adjustment—The valve may be adjusted using a 1/8" diameter rod. Turn adjusting collar nut counterclockwise to raise head pressure. Turn it clockwise to lower head pressure. Rotation directions are as viewed from top of valve spring housing.

Figure 25 Metrex valve adjustment

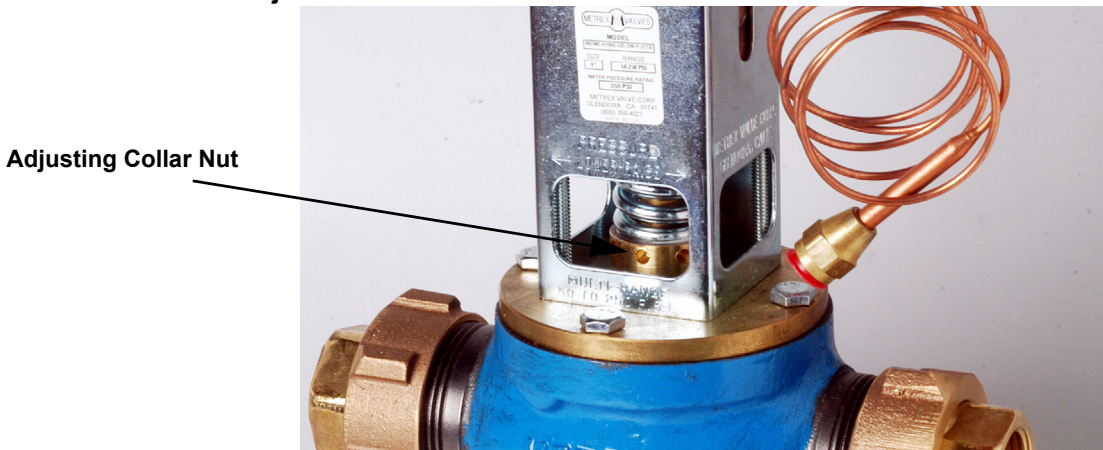

Manual Flushing—The valve may be flushed by rotating the socket head screw clockwise. This screw must be in the OUT position (counterclockwise) for normal valve operation.

Valve Disassembly

1. Shut off the water supply by using isolating valves.
2. Relieve the tension on the main spring by turning the adjusting screw (or collar) as far as it will go (provide a container to catch water below the valve).
3. Remove four screws extending through the main spring housing.
4. Remove the center assembly screws for access to all internal parts.
5. Clean the seat if possible. If the seat is pitted or damaged, replace the valve rubber disc and valve seat.
6. After valve is reassembled check for leaks.
7. Readjust head pressure control.

Testing Function of Valve—When the refrigeration system has been Off for approximately 10 to 15 minutes, the water flow should stop.

If the water continues to flow, the valve is either improperly adjusted (with head pressure too low) or the pressure sensing capillary is not connected properly to the condenser.

7.4.10 Drycooler Settings

Applications with the Optional Stat Setting require field piping to be insulated to prevent condensation. **Table 8** shows acceptable applications where stats must be adjusted to Optional Setting. Aquastats must be field-adjusted to Optional Setting for:

- GLYCOOL/Dual Cool applications
- Single Drycooler loops with motor ball valve flow controls (motor ball valves are used on all Liebert Challenger 3000 and ITR units with digital compressors).

Table 8 Water/glycol system conditions requiring optional settings for aquastats

Cooling Type	Glycool				Glycol			
	MBV		WRV		MBV		WRV	
Drycoolers in Loop	1	Multiple	1	Multiple	1	Multiple	1	Multiple
Stat Setting ¹	Optional	Optional	Optional	Optional	Optional	Factory	Factory	Factory
Insulate Field Piping	Yes	Yes	Yes	Yes	Yes	No	No	No

1. See **Table 9**.
2. MBV=motor ball valve; WRV=water regulating valve

Table 9 Aquastat settings—two-fan through four-fan drycoolers

Dial Setting (Stat Open Temp) Set for Mid Differential 8°F (4.4°C) Rise to Close			
Aquastat #	Fans	Factory Setting (Glycol) (see Notes 1 and 2)	Optional Setting (GLYCOOL) (see Note 3)
AQ1	F1	65°F (18.3°C)	35°F (1.7°C)
AQ2	F2 & F3	75°F (23.9°C)	45°F (7.2°C)
AQ3	F4	70°F (21.1°C)	40°F (4.4°C)



NOTE

1. All drycoolers are shipped at Factory Setting.
2. Factory Setting is used for all glycol applications, except single drycooler loops with motor ball valve controls.
3. Stats must be field-adjusted to Optional Setting for GLYCOOL/Dual Cool applications and all single drycooler loops using motor ball valve flow controls.

7.4.11 Compressor Oil

NOTICE

Risk of improper compressor lubrication. Can cause compressor and refrigerant system damage.

Failure to use oil types, viscosities and quantities recommended by the compressor manufacturer may reduce compressor life and void the compressor warranty. See oil types specified in **Table 10**.

- Do NOT mix polyol ester (POE) and mineral-based oils.
- Do NOT mix oils of different viscosities.

Consult Emerson or the compressor manufacturer if you have questions.

Table 10 Compressor oil types

Compressor Type	R-407c
Copeland Scroll and Digital Scroll	POE Oil - ISO 22 Viscosity ¹

1. Use Copeland POE Oil ULTRA 22CC, Mobil EAL Arctic 22CC or other Copeland-approved oils.

7.5 Compressor Replacement

Replacement compressors are available through your local Emerson office. Compressors are shipped in reusable packaging. If unit is under warranty, complete and include Liebert Service Credit Application (LSCA) with the compressor that is being returned. The original compressor should be returned in the same packaging.

Before Replacing or Returning a Compressor

Be certain that the compressor is actually defective. At a minimum, recheck a compressor returned from the field in the shop or depot for Hipot, winding resistance and ability to start before returning it. More than one-third of compressors returned for warranty analysis are determined to have nothing wrong. They were misdiagnosed in the field as being defective. Replacing working compressors unnecessarily costs everyone.

7.5.1 Compressor Functional Check

The following diagnostic procedure should be used to evaluate whether the compressor is working properly.

1. Proper voltage to the unit should be verified.
2. The normal checks of motor winding continuity and short to ground should be made to determine if the inherent overload motor protector has opened or if an internal motor short or ground fault has developed. If the protector has opened, the compressor must be allowed to cool sufficiently to allow it to reset.
3. Proper indoor and outdoor blower/fan operation should be verified. Condenser glycol flow should be verified.
4. With service gauges connected to suction and discharge pressure fittings, turn On the compressor. If suction pressure falls below normal levels, either the system charge is low on or there is a flow blockage in the system.
5. If suction pressure does not drop and discharge pressure does not rise to normal levels, reverse any two of the compressor power leads and reapply power to make sure compressor was not wired to run in reverse direction. If pressures still do not move to normal values, system is properly charged and solenoid valves function, the compressor is faulty. Reconnect the compressor leads as originally configured and use normal diagnostic procedures to check operation of the reversing valve.
6. To test if the compressor is pumping properly, the compressor current draw must be compared to published compressor performance curves using the operating pressures and voltage of the system. If the measured average current deviates more than $\pm 15\%$ from published values, a faulty compressor may be indicated. A current imbalance exceeding 15% of the average on the three phases should be investigated further.

7.5.2 Standard Scroll Compressor Replacement

Infrequently a fault in the motor insulation may result in a motor burn, but burnouts rarely occur in a properly installed system. Of those that do, most are the effects of mechanical or lubrication failures, resulting in the burnout as a secondary consequence.

If problems that can cause compressor failures are detected and corrected early, a large percentage can be prevented. Periodic maintenance inspections by alert service personnel on the lookout for abnormal operation can be a major factor in reducing maintenance costs. It is easier and far less costly to take the steps necessary to ensure proper system operation than it is to allow a compressor to fail and require replacement.

When troubleshooting a compressor, check all electrical components for proper operation.

1. Check all fuses and circuit breakers.
2. Check Hi-Lo Pressure switch operation.
3. If a compressor failure has occurred, determine whether it is an electrical or mechanical failure.

Mechanical Failure

A mechanical compressor failure will be not be indicated by a burned odor. The motor will attempt to run. If you have determined that a mechanical failure has occurred, the compressor must be replaced.

If a burnout occurs, correct the problem that caused the burnout and clean the system. It is important to note that successive burnouts of the same system are usually caused by improper cleaning.

Electrical Failure

An electrical failure will be indicated by a distinct pungent odor. If a severe burnout has occurred, the oil will be black and acidic.

In the event that there is an electrical failure and a complete burnout of the refrigeration compressor motor, the proper procedures must be performed in order to clean the system to remove any acids that would cause a future failure.

For clean-out warnings and procedures, see Copeland Application Engineering Bulletin 24-1105 “Principles of Cleaning Refrigeration Systems” or Carlyle Service Guide, Literature # 020-611.



WARNING

Risk of explosive discharge from high-pressure refrigerant. Can cause injury or death.

This unit contains fluids and gases under high pressure. Relieve pressure before working with piping. Do not loosen any refrigeration or electrical connections before relieving pressure.



CAUTION

Risk of contact with hot substances or surfaces. Can cause injury.

Avoid touching or contacting the gas and oils with exposed skin. Severe burns will result. Use long rubber gloves in handling contaminated parts. Use extreme caution and wear protective gloves and arm protection when working on or near hot compressors, discharge lines, humidifiers and reheats.



NOTE

Release of refrigerant to the atmosphere is harmful to the environment and is unlawful. Refrigerant must be recycled or discarded in accordance with federal, state, and local regulations.

NOTICE

Damage to a replacement compressor caused by improper system cleaning constitutes abuse under the terms of the warranty, and the warranty will be void.

NOTICE

Risk of improper scroll compressor installation. Could cause poor performance and compressor damage.

Three-phase power must be connected to the unit line voltage terminals in the proper sequence so that the scroll compressor rotates in the proper direction. Rotation in the wrong direction will result in poor performance and compressor damage.

Record compressor motor connections when removing a failed compressor. Wire the replacement compressor motor the same way to maintain proper rotation direction.

7.5.3 Digital Scroll Compressor Replacement Procedure

1. Disconnect power and follow all warnings at front of this manual.
2. Attach suction and discharge gauges to access fittings.
3. Front-seat service valves to isolate the compressor. Reclaim charge from compressor.
4. Remove marked pressure transducer and discharge pressure switch. Disconnect all electrical connections.
5. Detach service valves from compressor.
6. Remove failed compressor.
7. If required, follow compressor manufacturer's suggested clean-out procedures.
8. Install replacement compressor and make all connections. Replace gaskets or seals on service valves. Replace unloading solenoid.
9. Evacuate and charge as detailed in the user manual, SL-11962.

NOTICE

Risk of improper component reinstallation. Can cause equipment damage.

Identify and mark location of suction pressure transducer and discharge pressure switch. These devices look similar and they must be reinstalled in their original location.

Digital Compressor Unloading Solenoid(s)—Models 040, 042, 047, 049, 061 and 072

When replacing a digital scroll compressor, digital solenoid valve and coil must be replaced. Compressor and valve kit are shipped separately. Valve kit must be field-brazed to top of compressor in proper orientation and supported with original factory bracket.

7.6 Facility Fluid and Piping Maintenance for Water and Glycol Systems

Facility water and glycol quality remain a requirement throughout the life of the piping system. Fluid and piping system maintenance schedules must be established and performed. A local fluid maintenance program must be established that will evaluate fluid chemistry and apply necessary treatment. A periodic leak inspection of facility and unit fluid piping is recommended.

Glycol Solution Maintenance

It is difficult to establish a specific schedule of inhibitor maintenance since the rate of inhibitor depletion depends upon local water conditions. Analysis of water samples at time of installation and every six months should help to establish a pattern of depletion. A visual inspection of the solution and filter residue is often helpful in judging whether or not active corrosion is occurring.

The complexity of water caused problems and their correction makes it important to obtain the advice of a water treatment specialist and follow a regularly scheduled maintenance program. It is important to note that improper use of water treatment chemicals can cause problems more serious than using none.

Proper inhibitor maintenance must be performed in order to prevent corrosion of the glycol system. Consult glycol manufacturer for testing and maintenance of inhibitors. Do not mix products from different manufacturers. For further details, refer to filling instructions in the installation manual, Liebert part number SL-11925, available at the Liebert Web site, www.liebert.com

7.7 Humidifier

7.7.1 Infrared Humidifier

During normal humidifier operation, deposits of mineral solids will collect in the humidifier pan. This should be cleaned out periodically to ensure efficient operation. Each water supply has different characteristics, so the time interval between cleanings must be determined locally. A monthly check (and cleaning if necessary) is recommended.

Removing the Pan

To remove humidifier pan, first open disconnect switch and open front panel. Allow time for pan and water to cool. Unlatch front retainer clip (or remove screw from bracket on some units). Pull pan forward. Remove stand pipe to allow pan to drain. Disconnect drain line. Pull pan forward to remove it.



WARNING

Risk of electric shock and contact with hot liquids. Can cause injury or death.

The Liebert iCOM microprocessor does not isolate power from the unit, even in the “Unit Off” mode. Some internal components require and receive power even during the “Unit Off” mode of Liebert iCOM control.

The only way to ensure that there is NO voltage inside the unit is to install and open a remote disconnect switch. Refer to unit electrical schematic.

Before removing pan, be sure power is disconnected from the unit and water in the humidifier pan is no hotter than lukewarm.

Cleaning the Pan

An autoflush system can greatly increase the time between cleanings but does not eliminate the need for periodic checks and maintenance.

Scale on the side and bottom can be loosened with a stiff brush. Flush with water and replace pan in humidifier.

Changing Humidifier Lamps

1. Open disconnect switch.
2. Open front panel.
3. Remove screws securing line voltage compartment cover, then remove the cover.
4. In line voltage compartment, disconnect one end of the purple jumpers, then locate the burned out bulb with a continuity meter.
5. Remove humidifier pan. Refer to **Removing the Pan on page 50**.
6. Remove lamp brackets (2) under lamps.

Figure 26 Infrared humidifier lamps

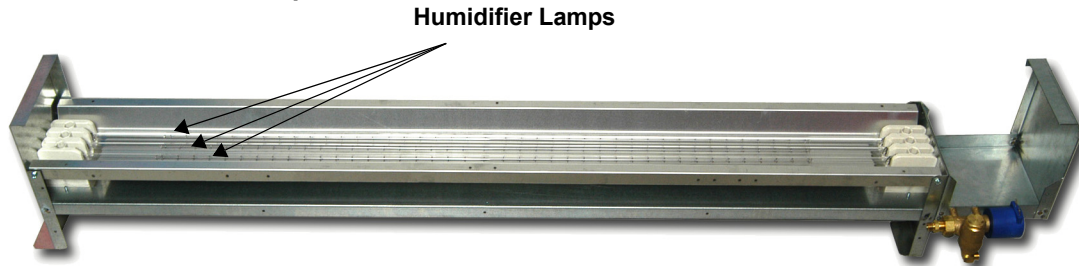

7. Loosen two screws securing bulb wires to junction block.
8. Pull bulb straight down.
9. Replace bulb. Wrap wires once loosely around bulb. This will support the bulb and also allow for thermal expansion. Make sure lamp wires are secure in the junction block.

NOTICE

Risk of oily deposits. Can shorten component life.

Do not touch the quartz lamps with your bare hands. Oily deposits such as fingerprints will severely shorten bulb life. Use clean cotton gloves at all times.

10. Reverse **Steps 1** through **6** to reassemble.

Autoflush Infrared Humidifier Cleaning System

NOTICE

Risk of improper water pressure. Can cause improper component operation.

To operate properly, the Autoflush Humidifier requires a water source that can deliver at least 1 gpm (0.063 l/s) with a minimum pressure of 20 psig (138 kPa).

The autoflush system will periodically flush the humidifier pan with water to prevent the buildup of water minerals due to saturation. Because water conditions vary, the amount of water flushing through the system may be programmed to match local needs.

Water amounts between 110% and 500% of the amount needed for humidification may be selected. Operation of the flushing system is then automatic and no further adjustments need to be made.

Autoflush Operation

The operation of the autoflush is divided into four steps, beginning with a call for humidification.

1. If the humidifier has not been activated for over 30 hours, the autoflush will flow water into the pan for about 30 seconds. This will provide a minimum amount of water in the pan and prevent heat damage to the humidifier pan. Humidifier lamps are Off.
2. If the humidifier has been activated within the last 30 hours, **Step 1** is bypassed. The autoflush will flow water into the pan for about 4 minutes. The humidifier lamps are On and the humidifier is operational during this period. When the pan is filled (the fill cycle has timed out), the water make-up valve is closed.
3. The water make-up valve remains Off and the humidifier lamps are On for a maximum of 9-1/2 minutes.
4. After the 9-1/2 minute delay, the autoflush adds water to the pan to replenish the water used in humidification and flush the pan of mineral solids. This amount of water is adjustable from 110% to 500% in increments of 10%. At the end of this cycle, the make-up valve is closed. **Steps 3** and **4** repeat as long as humidification is required.

Autoflush Controls

Use the LCD display, menu, and keys on the front control panel to program the autoflush controls.

7.7.2 Steam Generating Humidifier

Steam generating humidifiers are designed to operate in voltage ranges from 200 to 575 volts and generate 11 pounds (5 kg) of steam per hour. These humidifiers operate efficiently over a wide range of water quality conditions and automatically adjust to changes in the conductivity of water. The humidifiers drain and refill to maintain an amperage setpoint and alert the operator when the humidifier canister needs to be replaced. The humidifier is in the lower section of upflow units; it is in the middle section of downflow units.

Figure 27 Steam generating humidifier



Operation

1. During startup, when the humidity control calls for humidification, the fill valve opens and allows water to enter the canister. When the water level reaches the electrodes, current flows and the water begins to warm. The canister fills until the amperage reaches the setpoint and the fill valve closes. As the water warms, its conductivity increases and the current flow, in turn, rises. If the amperage reaches 115% of the normal operating amperage, the drain valve opens and flushes some of the water out of the canister. This reduces electrode contact with the water and lowers the current flow to the amperage setpoint. Boiling soon commences, and the canister operates normally.
2. If the conductivity of the water is low, the canister fills and the water level reaches the canister full electrode before the amperage setpoint is reached. The humidifier stops filling to prevent overflow. Boiling should commence in time. As water is boiled off, the mineral concentration in the canister increases and current flow also increases. The canister eventually reaches full output and goes to normal operation. No drain is permitted until then.
3. When full output is reached the circuit board starts a time cycle which is factory set at 60 seconds. During this repeating time cycle, the fill valve will open periodically to replenish the water being boiled off and maintain a “steady state” output at the set point. The amperage variance will depend on the conductivity of the water.
4. After a period of time, the mineral concentration in the canister becomes too high. When this occurs, the water boils too quickly. As the water quickly boils off and less of the electrode is exposed, the current flow decreases. When the current crosses the low threshold point (factory set at 90%) before the end of the time cycle, the drain valve opens, draining the mineral laden water out and replacing it with fresh water. This lowers the mineral concentration and returns the canister to “steady state” operation and prolongs canister life. The frequency of drains depends on water conductivity.
5. Over a period of time, the electrode surface will become coated with a layer of insulating material, which causes a drop in current flow. As this happens, the water level in the canister will slowly rise exposing new electrode surface to the water to maintain normal output. Eventually, the steady state water level will reach the canister full electrode and indicate so by activating the canister full alarm. At this point, all of electrode surface has been used up and the canister should be replaced.
6. After the entire electrode surface has been coated, the output will slowly begin to fall off. This usually occurs in the last several hours of electrode life and should allow enough time to schedule maintenance. During these last hours, the mineral concentration can increase. If the mineral concentration is too high, arcing can occur. If the electrodes start to arc, turn Off the humidifier immediately and replace the canister with the identical part.

Controls

The humidifier RUN/DRAIN switch is located at the upper right of the humidifier assembly. This switch should be in the RUN position when the humidifier is in normal operation, and in the DRAIN position when a manual drain sequence is required. The electronic control board for the humidifier is located on the right side of the humidifier assembly. When the main unit is energized, power is available to the humidifier circuits.

Replacing the Canister

Over a period of operation, the humidifier electrodes become coated with mineral solids. This coating insulates the electrodes and decreases the current flow. To maintain humidifier capacity, the water level slowly rises to expose fresh electrode. Eventually, the entire electrode becomes coated and the water level reaches the top. At this point, the canister full alarm is activated and the output begins to fall. When this happens, it is necessary to replace the full canister.

To replace the canister:

1. Turn the humidifier Off by lowering the humidity setpoint below the ambient humidity level. Record the original setpoint.
2. Place the RUN/DRAIN switch in the DRAIN position to drain the water from the canister.
3. Return the RUN/DRAIN switch to the RUN position after the canister has drained.



WARNING

Risk of electric shock. Can cause injury or death.

To avoid a shock hazard, all power to the unit must be disconnected before proceeding with the canister replacement procedure.

4. Turn Off the power at the main unit.
5. Remove the cover from the humidifier cabinet.



CAUTION

Risk of contact with hot surfaces. Can cause injury.

The canister and steam hose may be hot. Allow sufficient time for them to cool before working within the unit cabinet. Use extreme caution and wear protective gloves and arm protection when working on or near the canister or steam hose.

6. Locate the power wires to the steam canister. They are connected to the canister with 1/4" quick connects. Make note of the wiring configuration before removing any wires. Refer to the schematic on the unit. Slide the rubber boot back to expose the connections. Remove the three power wires and the two canister full wires. Do not loosen the screws that secure the electrodes.
7. Loosen the steam outlet hose clamp and slide the steam hose away from the canister top fitting.
8. The canister is now ready to be removed. Pull the canister straight up and out of the cabinet toward you.
9. Replace the canister with the part indicated in **Table 11**.

Table 11 Humidifier canister part numbers

Part Number	Voltage	Capacity lb/hr (kg/hr)
136798P1	200-460*	11 (5)
136798P2	380-575	11 (5)

* Can operate on 575V unit with transformer

10. Replace the canister by reversing the above procedure. Make special note of the following:



NOTE

When replacing the canister:

1. Make sure the two "O" rings are lubricated and properly seated on the bottom neck.
2. Always check the fill and drain solenoids for proper operation.



NOTE

When replacing the wiring, connect the red wire from Terminal #1 on the interface to the red top terminal on the canister. It is in the middle of a group of three terminals. The black wire from Terminal #2 on the interface connects to the power terminal farthest from the red terminal/wire. The power wire to this terminal is routed through the current sensing coil.

Circuit Board Adjustments



WARNING

Risk of electric shock. Can cause injury or death.

The Liebert iCOM microprocessor does not isolate power from the unit, even in the “Unit Off” mode. The only way to ensure that there is NO voltage inside the unit is to install and open a remote disconnect switch. Refer to unit electrical schematic.

Only properly trained and qualified personnel should perform adjustment of the circuit board. Hazardous voltages are present in the equipment throughout the procedure. Disconnect all power from the unit before working within the cabinet.

Humidifier operation is governed by the humidifier control board. This board is located on the right side of the humidifier compartment. There are three potentiometers mounted on the board. These pots can be used to adjust for extreme water conductivity conditions and capacity.

The “%” pot controls the amperage at which the drain will energize. The pot is clearly marked in percentages. This adjustment is factory set at 90%, which indicates that the unit will drain when the amperage falls off to 90% of the capacity setpoint. Raising the value increases the frequency of drain cycles. Lowering the value decreases the frequency of drain cycles. The frequency should be increased for highly conductive water and decreased for less conductive water. If adjustment is necessary, and a change of three to four percent in either direction does not permit normal operation of the unit, consult your Liebert supplier.

The pot marked “SEC” controls the duration of the drain cycle. The pot is clearly marked in seconds. This adjustment is factory set at 60 seconds and should not be readjusted without consulting your Liebert supplier.

The pot marked “CAP ADJ” is factory set at 100%. The maximum capacity is determined by a fixed resistor (R4) which is factory selected based on unit voltage.

Drain Tempering Feature

All units are equipped with a drain tempering feature which mixes cold fill water with hot drain water to protect drain piping. This feature can lower drain water temperature to as low as 140°F (60°C), depending on water pressure. To deactivate this feature, remove the diode from socket CR18 on the circuit board (lower left, above LED).

8.0 TROUBLESHOOTING

Use this section to assist in troubleshooting your unit. Also refer to **6.0 - Alarm Descriptions**. Suggestions are grouped by product function for convenience.

WARNING

Risk of electric shock. Can cause injury or death.

The Liebert iCOM microprocessor does not isolate power from the unit, even in the “Unit Off” mode. Some internal components require and receive power even during the “Unit Off” mode of Liebert iCOM control.

The only way to ensure that there is NO voltage inside the unit is to install and open a remote disconnect switch. Refer to unit electrical schematic.

Only properly trained and qualified personnel should service these units. Lethal voltage is present in some circuits. Use caution when troubleshooting with power On. Disconnect and lock out power before replacing components.

WARNING

Risk of explosive discharge from high-pressure refrigerant. Can cause injury or death.

This unit contains fluids and gases under high pressure. Relieve pressure before working with piping.

NOTICE

Risk of improper control connection. Can cause equipment damage.

When using jumpers for troubleshooting, always remove jumpers when maintenance is complete. Jumpers left connected could override controls and cause equipment damage.

Table 12 Blower troubleshooting

Symptom	Possible Cause	Check or Remedy
Blower will not start	No main power	Check L1, L2 and L3 for rated voltage.
	Blown fuse or tripped circuit breaker (CB)	Check fuses or CBs to main fan.
	Overloads tripped	Push reset button on main fan overload. Check amp draw.
	No output voltage from transformer	Check for 24 VAC between P24-2 and P24-1. If no voltage, check primary voltage.
	Control fuse blown or circuit breaker tripped	Check for 24 VAC between P4-4 and E1. If no voltage, check for short. Replace fuse or reset circuit breaker.

Table 13 Chilled water troubleshooting

Symptom	Possible Cause	Check or Remedy
Chilled water or hot water/steam valve not opening	Motor operates but valve won't open	Check linkage for adjustment and be sure that it is tight on the valve.
Modulating Motors	No 24 VAC power to motor	Check linkage for adjustment and be sure that it is tight on the valve.
	No signal from control	Check DC voltage on printed circuit board in motor. Terminal No. 1 is grounded and No. 3 is positive. DC voltage should vary from 0.8 to 2.0 VDC or above as temperature control is varied below room temperature on cooling valve or above room temperature on heating valve.
	Motor not working	Remove wires on Terminal No. 1 and No. 3 from the motor (do not short). With 24 VAC power from TR to TR jumper terminal 1 and 2 on motor to drive open. Remove jumper to drive closed, if motor fails to work, replace it.
Actuator Motors	No 24 VAC power to motor	Check for 24 VAC between P22-3 and P22-5 (open), or P22-1 and P22-5 (closed).

Table 14 Compressor and refrigeration system troubleshooting

Symptom	Possible Cause	Check or Remedy
Compressor will not start	Power Off	Check main switch, fuses or CBs and wiring
	Current overload open	Re-set units with overload option manually. Allow compressor to cool for internal overloads to reset.
	Loose electrical connections	Tighten connections
	Compressor motor burned out	Check and replace compressor if defective.
Compressor will not operate, contactor not pulling in	No call for cooling	Check monitor status.
	Solenoid valve not energizing	Hold screwdriver over solenoid and check for magnetic field. This indicates solenoid is energized.
	Low pressure switch not making contact	Check gas pressure - manually energize low pressure switch.
Compressor will not operate, contact not pulling in	High pressure switch open	Reset switch. Refer to other refrigeration troubleshooting suggestions.
Compressor contactor pulled in but compressor will not operate	Blown fuse or tripped CB	Check for line voltage after fuses or CBs, and after contactors.
Compressor runs for three minutes then stops; contactor drops out.	Low pressure switch not closing	Check for low gas pressure. Compressor is running on Positive Start Kit (air cooled systems only)
	Liquid line solenoid valve not opening	Check magnetic field to see if energized.
High discharge pressure	Dirty condenser or drycooler fins	Clean coil.
	Condenser equipment not operating	Check operation.
	High refrigerant charge	Check refrigerant charge.
	Hot gas bypass valve adjusted improperly	Adjust properly.
	Water regulating valve adjusted improperly	Adjust properly.
Low discharge pressure	Excessive fluid flow through condenser	Adjust fluid regulating valve
	Suction service valve partially closed	Open the valve.
	Faulty head pressure control valve or condenser fan speed control	Replace if defective.
	Compressor rotation in reverse direction	Check for proper power phase wiring to unit and to compressor motor.
Low suction pressure	Insufficient refrigerant in system	Check for leaks, repair, and add refrigerant for air cooled. Evacuate and recharge for water/glycol unit.
	Dirty air filters	Change filters.
	Plugged filter-drier	Replace filter.
	Improper superheat adjustment	Reset expansion valve for 10-15°F (6-8°C)
	Defective expansion valve sensing element	Replace element
	Poor air distribution	Check duct work for closed dampers. Check for under-floor restrictions at or near the unit.
	Low condensing pressure	Check head pressure control device.
	Slipping belts	Inspect and adjust

Table 14 Compressor and refrigeration system troubleshooting (continued)

Symptom	Possible Cause	Check or Remedy
Flooding	Defective or improperly set expansion valve	Increase superheat or replace valve
	Evaporator fan motor or belt	Correct problem or replace fan motor and/or belts.
	Low condensing pressure	Check head pressure control device
	Slipping belts	Inspect and adjust
Low compressor capacity or inability to pull down system	Compressor rotation in reverse direction.	Check for proper power phase wiring to unit and to compressor motor.
	Leaking liquid line solenoid valve or dirt in valve	Replace valve if clean; clean out valve if dirty.
Compressor noisy	Loose compressor or piping support	Tighten clamps.
Pipe rattle	Loose pipe connections	Check pipe connections
Compressor running hot	Compression ratio too high	Check setting of high and low pressure switches. Check condenser -- is it plugged? Check that all evaporator and condenser fans are operating properly.
Compressor cycles intermittently	Low-pressure switch erratic in operation	Check tubing to switch to see if clogged or crimped. Check for proper switch operation.
	Insufficient refrigerant in system	Check for leaks, fix, and add refrigerant on air cooled unit. Evacuate and recharge water/glycol unit.
	Suction service valve closed	Open valve.
	Insufficient fluid flowing through condenser or clogged condenser, or dirty air cooled condenser coils	Adjust fluid regulating valve to condenser. Flush the condenser.
	Discharge service valve not fully open	Open valve
Compressor cycles continually	Faulty low pressure switch	Repair or replace.
	Dirt or restriction in tubing to pressure stat	Check and clean tubing.
	Defective liquid line solenoid valve	Check valve and solenoid operator; replace if necessary.
	Plugged filter-drier	Replace filter.
Compressor motor protectors tripping or cycling	High discharge pressure	Check for loss of condenser water or blocked condenser fan or coil.
	Defective overload relay	Replace.
	High suction temperature	Reduce suction temperature by expansion valve adjustment or provide desuperheating.
	Loose power or control circuit wiring connection	Check all power and control circuit connections.
	Defective motor	Check for motor ground or short. Replace compressor, if either condition is found.
Compressor cycles on locked rotor	Low line voltage	Check line voltage and determine location of voltage drop.
	Compressor motor defective	Check for motor winding short or ground.
	Single phasing	Check voltage across all 3 legs at contactor. Correct source problem.
Motor burnout	Check control panel for welded contactor contacts or welded overload contacts	Replace defective components

Table 15 Dehumidification troubleshooting

Symptom	Possible Cause	Check or Remedy
No dehumidification	Control not calling for dehumidification	Check monitor status.
	Compressor contactor not pulling in	See 7.5.1 - Compressor Functional Check and Table 14 .
	Compressor won't run; fuse blown or CB tripped	See 7.5.1 - Compressor Functional Check and Table 14 . Check fuses or CBs and contacts. Check line voltage

Table 16 Glycol pump troubleshooting

Symptom	Possible Cause	Check or Remedy
Suddenly stops pumping	Clogged strainer or impeller	Clean out debris.
Suddenly slow pumping	Clogged impeller, diffuser, or line	Clean out debris and use strainer.
Excessive leakage around the pump shaft while operating	Worn seal or packing	Replace seal or packing.
Performance poor	Worn impeller or seal	Replace with new impeller or seal.
	Suction lift too high	Relocate pump closer to supply.
	Motor not up to speed; low voltage	Larger lead wires may be required. Check for proper line voltage ($\pm 10\%$).
	Worn bearings	Replace pump
Noisy operation	Worn motor bearings	Replace pump
	Low discharge head	Throttle discharge-improve suction conditions.
	Debris lodged in impeller	Remove cover and clean out.
	Cavitating pumps	Adjust system pressures.

Table 17 Infrared humidifier troubleshooting

Symptom	Possible Cause	Check or Remedy
No humidification	Humidifier pan not filling	Check water supply.
		Check fill valve operation
		Check drain stand pipe adjustment
		Check for clogged waterline
	Control not calling for humidity	Check monitor status
	Humidity contact not pulling in	Check visually. If contact is made, check line voltage after contactor and fuses or CBs.
		Check for open humidifier safety stat. Jumper between terminals P35-6 and P35-15. If contactor pulls in, replace safety. Remove jumper.
Humidifier bulb burned out	Replace bulb. Loosen lead on old bulb. Trim excess lead length on new bulb to avoid shorts.	

Table 18 Steam generating humidifier troubleshooting

Symptom	Possible Cause	Check or Remedy
False canister full indication	Foaming	Check drain valve to ensure that it drains freely. Check and replace if defective.
		Check water supply. If commercially softened, reconnect to raw water supply. If connected to hot water reconnect to cold water.
Main 24 VAC fuse or circuit breaker trips	Shorts or loose connections	Check the wiring connections of the 24 VAC circuit.
	Faulty circuit board	Replace the circuit board.
Main fuses blow approximately 15 seconds after unit is activated	Faulty solenoid	Check for magnetic field at coil.
	Conductivity too high	Check amp draw of humidifier on startup. If it exceeds rated amps, increase setting of the % pot on the circuit board
Main fuses blow when drain valve is activated.	Mineral deposits obstruct drain valve	Check drain valve for obstructions and clean if necessary.
	Faulty solenoid	Check for magnetic field at coil.
	Faulty circuit board	Replace circuit board.
Unit On, humidifier will not operate	Humidifier not receiving power	Verify that RUN/DRAIN switch is in the RUN position.
		Check fuses or CBs and replace or reset if necessary.
		Make sure molex connector is securely plugged into circuit board and that no wires are loose.
Contactor pulled in, but no water enters canister	No water available to unit	Check external shutoff valves.
	Clogged fill line strainer	Clean or replace fill line strainer.
	Wiring breaks or loose connections	Check for faulty wiring and loose connections.
	Faulty circuit board	Replace circuit board.
Water enters canister, but canister full circuit activates at a low water level	Foaming	Check drain valve and water supply.
	Canister interface connections incorrect	Check connection on component plate in humidifier cabinet. Terminal #1 on the square block interface device must be connected to L2 of the power terminal block. L2 must also be connected to the electrode closest to the steam outlet port. Verify that the red wire from Terminal #2 on the interface connects to the red top terminal on the canister. This is the one farthest from the steam outlet port and is the high water sensor probe.
	Full isolation has broken down	Remove red canister full wire from canister. If normal operation resumes, canister must be replaced. Remove the wire from Terminal #3 on the interface. If normal operation resumes, canister full interface must be replaced.
	Drain assembly not operating freely	Check and replace coil or valve if necessary.
	Faulty circuit board	Replace circuit board
Canister fills but overflows	Canister full circuit does not activate	Check wiring of canister full interface. Replace circuit board.

Table 18 Steam generating humidifier troubleshooting (continued)

Symptom	Possible Cause	Check or Remedy
Excessive arcing in the canister	Drain valve clogged or defective	Verify that drain valve operates freely when activated. Clean valve and replace coil or valve if defective. Flush canister several times and replace if arcing persists.
	Improper water supply	If water is commercially softened, reconnect humidifier to raw water supply, drain canister, and restart. If connected to hot supply, reconnect to cold water.
	Insufficient drain rate	Increase drain rate by adjusting % pot on circuit board above the preset 70% to roughly 80%.
	Excessive iron content in water	Analyze iron content of water. If it exceeds 0.1 mg./l, install a filter to remove iron from water supply.
On cold startup, canister fills, high water alarm activates and humidifier fails to reach full amperage	Conductivity of water too low	Drain canister and add one Alka-Seltzer tablet to canister. Refill. Turn the % pot to roughly 60%. Restart humidifier. If amperage rises rapidly, it may be necessary to dilute the water to prevent blown fuses. If it rises too slowly, add another Alka-Seltzer tablet.
On cold startup, canister fills, high water alarm activates and humidifier fails to reach full amperage	Fill solenoid not closing tightly	If humidifier returns to canister full condition, verify that the fill solenoid closes tightly.

Table 19 Reheat troubleshooting

Symptom	Possible Cause	Check or Remedy
Reheat will not operate; contactor not pulling in	Control not calling for heat	Check monitor status.
	Reheat safety stat open	Jumper between terminals P34-1 and P34-2. If reheat operates, safety is open. Remove jumper. Replace safety.
Reheat not operating; contactor pulling in	Heater burned out	Turn Off power and check heater continuity with Ohm meter.



NOTE:

Reheat element sheaths and fins are manufactured with stainless steel. Regular inspections are necessary to ensure proper cleanliness of the reheating element. Should inspection reveal corrosion particles on the reheating element or adjoining surfaces (including ducts and plenums), appropriate cleaning should be performed. Periodic reheating element replacement may be required to meet specific application requirements.

9.0 MONTHLY MAINTENANCE INSPECTION CHECKLIST

Date: _____

Prepared by: _____

Model #: _____

Serial #: _____

Filters

- ___ 1. Restricted air flow
___ 2. Check filter switch
___ 3. Wipe section clean

Blower Section

- ___ 1. Impellers free of debris and move freely
___ 2. Check belt tension and condition
___ 3. Bearings in good condition

Compressor

- ___ 1. Check oil leaks
___ 2. Check for leaks

Air Cooled Condenser (if applicable)

- ___ 1. Condenser coil clean
___ 2. Motor mounts tight
___ 3. Bearings in good condition
___ 4. Refrigerant lines properly supported

Reheat

- ___ 1. Check reheat element operation
___ 2. Inspect elements for cleanliness

Steam Generating Humidifier

- ___ 1. Check canister for deposits
___ 2. Check condition of steam hoses
___ 3. Check water make-up valve for leaks

Infrared Humidifier

- ___ 1. Check pan drain for clogs
___ 2. Check humidifier lamps
___ 3. Check pan for mineral deposits

Refrigeration Cycle/Section

- ___ 1. Check refrigerant lines
___ 2. Check for moisture (sight glass)
___ 3. Check suction pressure
___ 4. Check head pressure
___ 5. Check discharge pressure
___ 6. Check hot gas bypass valve
___ 7. Check thermostatic exp. valve

Air Distribution Section

- ___ 1. Restriction in grille free area

Refrigerant Charge

- ___ 1. Check refrigerant level

NOTES

Multiple horizontal lines for handwritten notes.

Signature

Make photocopies of this form for your records

10.0 SEMIANNUAL MAINTENANCE INSPECTION CHECKLIST

Date: _____

Prepared by: _____

Model #: _____

Serial #: _____

Filters

- ___ 1. Restricted air flow
- ___ 2. Check filter switch
- ___ 3. Wipe section clean

Blower Section

- ___ 1. Impellers free of debris and move freely
- ___ 2. Check belt tension and condition
- ___ 3. Bearings in good condition
- ___ 4. Inspect & tighten electrical connections

Compressor

- ___ 1. Check oil leaks
- ___ 2. Check for leaks
- ___ 3. Inspect & tighten electrical connections

Air Cooled Condenser (if applicable)

- ___ 1. Condenser coil clean
- ___ 2. Motor mounts tight
- ___ 3. Bearings in good condition
- ___ 4. Refrigerant lines properly supported
- ___ 5. Inspect & tighten electrical connections

Water/Glycol Condenser (if applicable)

- ___ 1. Copper tube clean
- ___ 2. Water regulating valves function
- ___ 3. Glycol solution
- ___ 4. Check for water/glycol leaks

Glycol Pump

- ___ 1. Glycol leaks
- ___ 2. Pump operation
- ___ 3. Inspect & tighten electrical connections

Steam Generating Humidifier

- ___ 1. Check canister for deposits
- ___ 2. Check condition of steam hoses
- ___ 3. Check water make-up valve for leaks
- ___ 4. Inspect & tighten electrical connections

Infrared Humidifier

- ___ 1. Check pan drain for clogs
- ___ 2. Check humidifier lamps
- ___ 3. Check pan for mineral deposits
- ___ 4. Inspect & tighten electrical connections

Refrigeration Cycle/Section

- ___ 1. Check refrigerant lines
- ___ 2. Check for moisture (sight glass)
- ___ 3. Check suction pressure
- ___ 4. Check head pressure
- ___ 5. Check discharge pressure
- ___ 6. Check hot gas bypass valve
- ___ 7. Check thermostatic exp. valve

Air Distribution Section

- ___ 1. Restriction in grille free area

Refrigerant Charge

- ___ 1. Check refrigerant level

Electrical Panel

- ___ 1. Check fuses
- ___ 2. Inspect & tighten electrical connections
- ___ 3. Check operation sequence
- ___ 4. Check contactor operation

Reheat

- ___ 1. Check reheat element operation
- ___ 2. Inspect elements for cleanliness
- ___ 3. Inspect & tighten electrical connections

Notes

Signature

Make photocopies of this form for your records

Ensuring The High Availability Of Mission-Critical Data And Applications.

Emerson Network Power, the global leader in enabling business-critical continuity, ensures network resiliency and adaptability through a family of technologies—including Liebert power and cooling technologies—that protect and support business-critical systems. Liebert solutions employ an adaptive architecture that responds to changes in criticality, density and capacity. Enterprises benefit from greater IT system availability, operational flexibility and reduced capital equipment and operating costs.

Technical Support / Service

Web Site

www.liebert.com

Monitoring

liebert.monitoring@emerson.com

800-222-5877

Outside North America: +00800 1155 4499

Single-Phase UPS & Server Cabinets

liebert.upstech@emerson.com

800-222-5877

Outside North America: +00800 1155 4499

Three-Phase UPS & Power Systems

800-543-2378

Outside North America: 614-841-6598

Environmental Systems

800-543-2778

Outside the United States: 614-888-0246

Locations

United States

1050 Dearborn Drive

P.O. Box 29186

Columbus, OH 43229

Europe

Via Leonardo Da Vinci 8

Zona Industriale Tognana

35028 Piove Di Sacco (PD) Italy

+39 049 9719 111

Fax: +39 049 5841 257

Asia

29/F, The Orient Square Building

F. Ortigas Jr. Road, Ortigas Center

Pasig City 1605

Philippines

+63 2 687 6615

Fax: +63 2 730 9572

While every precaution has been taken to ensure the accuracy and completeness of this literature, Liebert Corporation assumes no responsibility and disclaims all liability for damages resulting from use of this information or for any errors or omissions.

© 2009 Liebert Corporation

All rights reserved throughout the world. Specifications subject to change without notice.

® Liebert is a registered trademark of Liebert Corporation.

All names referred to are trademarks

or registered trademarks of their respective owners.

SL-11963_REVO_08-09

Emerson Network Power.

The global leader in enabling *Business-Critical Continuity*.

■ AC Power

■ Embedded Computing

■ Outside Plant

■ Racks & Integrated Cabinets

■ Connectivity

■ Embedded Power

■ Power Switching & Controls

■ Services

■ DC Power

■ Monitoring

■ Precision Cooling

■ Surge Protection

EmersonNetworkPower.com

Business-Critical Continuity, Emerson Network Power and the Emerson Network Power logo are trademarks and service marks of Emerson Electric Co.

©2009 Emerson Electric Co.