

**CoreSense™ Diagnostics
for Copeland Scroll® UltraTech® Air Conditioning Compressors**

TABLE OF CONTENTS

Safety	
Safety Instructions.....	2
Safety Icon Explanation	2
Instructions Pertaining to Risk of Electrical Shock, Fire, or Injury to Persons	3
Safety Statements.....	3
Introduction	
Overview	4
Application Restrictions and Types	4
Product Specifications.....	4
Installation	
Mounting	4
Terminal Description.....	4
Operation	
Compressor Protection	4
Module LED Description	5
Module Operation/Code Description	5
Resetting Alert Codes	6
Service	
Module History Download	6
Warranty Information.....	6
Support.....	6
Figures and Tables	
Wires Pulled Through Module	6
Module Dimensions in Millimeters.....	7
Terminal Locations	7
Wiring Diagram	8
Flash Code Description.....	9
LED Troubleshooting Information.....	10-12

Safety Instructions

Copeland Scroll® compressors with CoreSense™ Diagnostics technology are manufactured according to the latest U.S. and European Safety Standards. Particular emphasis has been placed on the user's safety. Safety icons are explained below and safety instructions applicable to the products in this bulletin are grouped on Page 3. These instructions should be retained throughout the lifetime of the compressor. **You are strongly advised to follow these safety instructions.**

Safety Icon Explanation

**DANGER**

DANGER indicates a hazardous situation which, if not avoided, will result in death or serious injury.

**WARNING**

WARNING indicates a hazardous situation which, if not avoided, could result in death or serious injury.

**CAUTION**

CAUTION, used with the safety alert symbol, indicates a hazardous situation which, if not avoided, could result in minor or moderate injury.





**NOTICE**

NOTICE is used to address practices not related to personal injury.

**CAUTION**

CAUTION, without the safety alert symbol, is used to address practices not related to personal injury.

Instructions Pertaining to Risk of Electrical Shock, Fire, or Injury to Persons

	<p>ELECTRICAL SHOCK HAZARD</p> <ul style="list-style-type: none"> • Failure to follow these warnings could result in serious personal injury. • Disconnect and lock out power before servicing. • Discharge all capacitors before servicing. • Use compressor with grounded system only. • Molded electrical plug must be used when required. • Refer to original equipment wiring diagrams. • Electrical connections must be made by qualified electrical personnel.
	<p>PRESSURIZED SYSTEM HAZARD</p> <ul style="list-style-type: none"> • Failure to follow these warnings could result in serious personal injury. • System contains refrigerant and oil under pressure. • Remove refrigerant from both the high and low compressor side before removing compressor. • Use appropriate back up wrenches on rotalock fittings when servicing. • Never install a system and leave it unattended when it has no charge, a holding charge, or with the service valves closed without electrically locking out the system. • Use only approved refrigerants and refrigeration oils. • Personal safety equipment must be used.
	<p>BURN HAZARD</p> <ul style="list-style-type: none"> • Failure to follow these warnings could result in serious personal injury or property damage. • Do not touch the compressor until it has cooled down. • Ensure that materials and wiring do not touch high temperature areas of the compressor. • Use caution when brazing system components. • Personal safety equipment must be used.
	<p>COMPRESSOR HANDLING</p> <ul style="list-style-type: none"> • Failure to follow these warnings could result in personal injury or property damage. • Use the appropriate lifting devices to move compressors. • Personal safety equipment must be used.

Safety Statements

- Refrigerant compressors must be employed only for their intended use.
- Only qualified and authorized HVAC or refrigeration personnel are permitted to install, commission and maintain this equipment.
- Electrical connections must be made by qualified electrical personnel.
- All valid standards and codes for installing, servicing, and maintaining electrical and refrigeration equipment must be observed.

INTRODUCTION

Overview

CoreSense™ Diagnostics is a breakthrough innovation for troubleshooting residential air conditioning and heat pump systems. The CoreSense Diagnostics module is easily installed in the unit electrical panel near the compressor contactor. By using the compressor as a sensor, CoreSense Diagnostics helps the service technician more accurately troubleshoot system and compressor fault conditions.

CoreSense Diagnostics also provides compressor and system protection through its proprietary lockout feature. Depending on the severity and frequency of the fault that caused the trip condition, the CoreSense Diagnostics module can lockout the compressor contactor to prevent damage to the compressor and system components. Less severe fault conditions resulting in an occasional trip will not result in a lockout condition.

Flashing LEDs communicate **ALERT** and **LOCK** codes to the service technician.

Application Restrictions and Types

The CoreSense Diagnostics (571-0072-00) module is designed and qualified for use with ZPS*K5 single-phase Copeland Scroll® UltraTech™ compressors.

Product Specifications

Operating Temp: - 40° to 150°F (- 40° to 65°C)
Storage Temp: - 40° to 175°F (- 40° to 80°C)
Supply Voltage: 18 to 28VAC , 48 to 62Hz
Module Current Sensing Range: 2 to 30A
Maximum Power Consumption: 2.5 VA (Excluding solenoid load)

INSTALLATION

Mounting

Four #8 or #10 self tapping or sheet metal screws are required for installation of the module. The maximum mounting screw torque is 20 in.lbs. Locate the module near the compressor contactor (wire routing for compressor run, common, and start wires will be easier in this position). The module can be mounted in any orientation and LEDs should be visible for ease of service.

The compressor's run (R), common (C), and start (S) wires are routed through the holes in the CoreSense module marked "R", "C", and "S". See **Figure 1**.

Terminal Description

The terminals for the CoreSense Diagnostics module are 1/4" spade terminals.

- **COMMON (C)**
The 24 volt common terminal for module power.
- **DEMAND (Y)**
The demand terminal requires a 24VAC signal measured with respect to the COMMON (C) terminal when there is a call for heating or cooling. A signal above 6VAC indicates the thermostat wants the compressor to be on, while 0-6VAC signal indicates the thermostat wants the compressor to be off.
- **SECOND STAGE DEMAND (Y2)**
The demand (Y) and second stage demand (Y2) terminals require a 24VAC signal measured with respect to the COMMON (C) terminal when there is a call for heating or cooling. A signal above 10VAC indicates the thermostat wants the Ultratech solenoid to be energized, while 0-10VAC signal indicates the thermostat wants the Ultratech solenoid to be deenergized.
- **PROTECTION (PROT)**
The protection terminal is internally connected to the COMMON terminal through a solid state switch.
- **POWER (R)**
The module requires a constant 24VAC supply power to this terminal. The module must receive an independent power supply in order to operate properly. See **Figure 4**.
- **Thermostat Communication (L)**
Provides a 24V signal to an indoor thermostat indicating the number of ALERT flashes displayed on the module. (Reference thermostat manual for available capability)
- **Solenoid (DC SOL)**
Provides a connection to the Copeland Scroll UltraTech second stage compressor solenoid. This solenoid is internal to the compressor, and has a voltage range of 18 to 28VDC. Please refer to bulletin **AE-1311** for information on the Copeland Scroll® UltraTech® compressor.

OPERATION

Compressor Protection

The CoreSense Diagnostics module utilizes proprietary algorithms to protect the compressor and system from repeated trips of system pressure controls and the compressor internal overload. The protection terminal of the module should be wired in series with the system low pressure and high pressure cutouts, as well as the compressor contactor. When the module detects a series of trips as described below, it will activate a lockout feature that opens the solid state switch in the module, thereby cutting power to the contactor and de-energizing the compressor.

Module LED Description

POWER LED (Green): indicates the module is powered with 18 to 28 volts.

ALERT LED (Yellow): communicates an abnormal system condition through a unique flash code. The ALERT LED will flash a number of times consecutively, pause and then repeat the process. The number of consecutive flashes, defined as the Flash Code, correlates to a particular abnormal condition. Detailed descriptions of specific ALERT **Flash Codes** are shown in Table 1.

TRIP/LOCK LED (Red): indicates either a TRIP or LOCK condition.

- TRIP: is indicated by a solid illumination of the LED. This means the compressor is not running and demand is present at the module.
- LOCK: is indicated by a flashing LED correlating to a LOCK condition in which the module will prevent the compressor from starting.

Module Operation/Code Description

Code 1 – Long Run Time

The module will flash yellow one time when the compressor operates for longer than 18 continuous hours. This is an alert code only, and the module will not lockout the compressor for this condition. This code is inactive for heat-pumps.

Code 2 – Compressor (Pressure) Trips

The module will flash yellow two times when the compressor operates from 12 seconds to 15 minutes followed by a trip condition lasting longer than 7 minutes. When four consecutive or ten total Code 2 events are recorded, the module will lockout the compressor and flash red two times.

Code 3 – Pressure Switch Cycling

The module will flash yellow three times when the compressor operates from 12 seconds to 15 minutes followed by a trip condition lasting between 35 seconds to 7 minutes. When four consecutive or ten total Code 3 events are recorded, the module will lockout the compressor and flash red three times.

Code 4 – Locked Rotor Trip

The module will flash yellow four times when the compressor trips within 12 seconds of operation and does not reset and start within 35 seconds. When ten consecutive Code 4 events are recorded the module will lockout the compressor and flash red four times.

Code 5 – Compressor (Moderate Run) Trip

The module will flash yellow five times when the compressor has operated between 15 minutes and 18 hours, followed by a compressor trip lasting longer than 7 minutes. When four consecutive or ten total Code 5 events are recorded, the module will lockout the compressor and flash red five times.

Code 6 – Open Start Circuit

The module will lockout the compressor and flash red six times if the module detects a demand signal in the “Y” terminal and current in the “R” winding of the compressor, but no current is detected in the “S” winding of the compressor for 2 seconds.

Code 7 – Open Run Circuit

The module will lockout the compressor and flash red seven times if the module detects a demand signal in the “Y” terminal and current in the “S” winding of the compressor, but no current is detected in the “R” winding of the compressor for 2 seconds.

Code 8 – Welded Contactor

The module will flash yellow eight times if it has detected line currents in the “S” and “R” windings and demand is absent for 15 seconds.

Code 9 – Low Voltage

The module will flash nine times if the module supply voltage drops below 17VAC for 2 seconds. The module will prevent the compressor from starting until adequate voltage is established.

Code 10 – Over-Current Protection

When the current at the PROT terminal is greater than 2A for 40ms, the module will flash a Code 10. The red LED will flash 10 times with the yellow LED remaining

off. This event will cause a lockout of the compressor and indicates that the module is mis-wired or the contactor coil is shorted to ground.

NOTICE

Code 10 is not specified on the module label.

Resetting Alert Codes

When the CoreSense Diagnostics module has detected a series of adverse conditions that have caused it to lockout the compressor, and after the issue has been resolved, it is necessary to manually reset the module in order to clear the present alert code.

The primary way of clearing the code and resetting the ALERT or TRIP/LOCK is to cycle the power to the module by disengaging the COMMON (C) Terminal. This will not clear the seven day operating history contained in the module memory. It will only clear the present ALERT or TRIP/LOCK and allow for normal operation.

SERVICE

WARNING

Always disconnect and lockout the power supply before beginning electrical troubleshooting.

Module History Download

The CoreSense Diagnostics module is capable of communicating with a personal computer, tablet, or laptop, via Emerson Climate Technologies computer

software interface and USB connection, in order to download and store fault history and module operation time. This information can be used to help diagnose and review data from troubled systems in the field. For more information, please contact your Emerson Climate Application Engineer.

Warranty Information

Emerson Climate Technologies, Inc. warrants its diagnostic module to be free from defects in materials and workmanship under normal use for a period of one year from the date of purchase or twenty months from manufacture, whichever comes first. During this period, Emerson Climate Technologies, Inc. will replace any defective diagnostic module without charge.

For more information on product warranty please visit www.EmersonClimate.com

Support

For more information visit www.EmersonClimate.com, or contact Emerson Climate Technologies, Inc. at 1-888-EMR-9950.

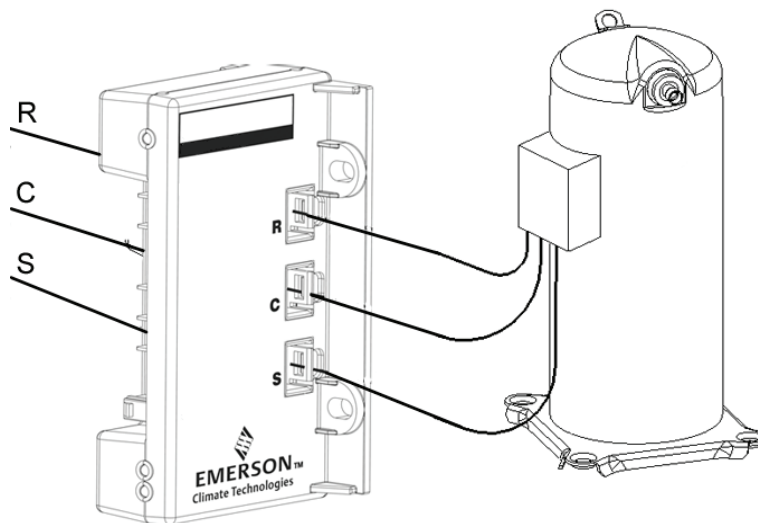

Figure 1
Wires Pulled Through Module

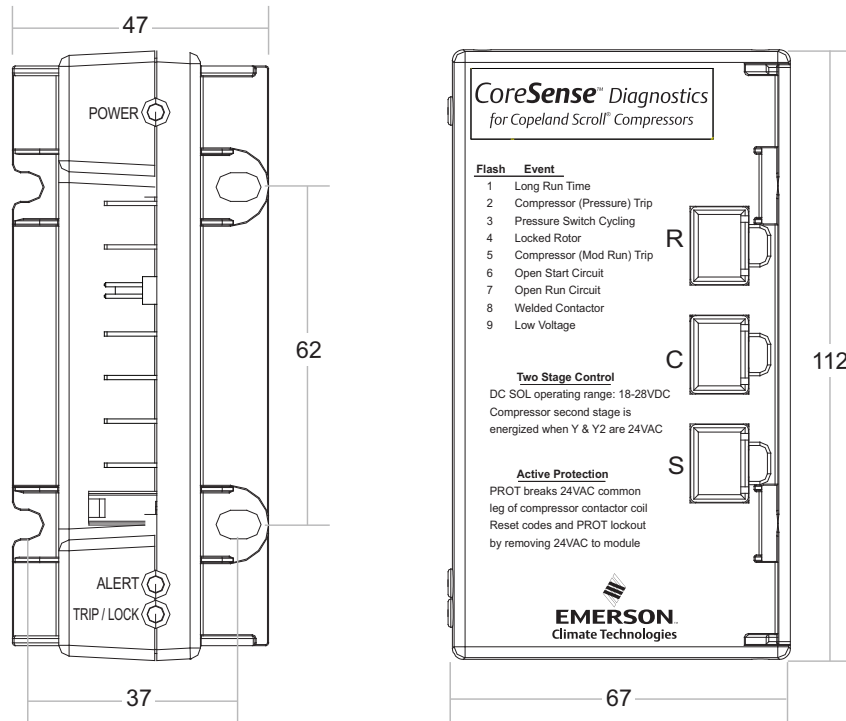

Figure 2 – Module Dimensions in Millimeters

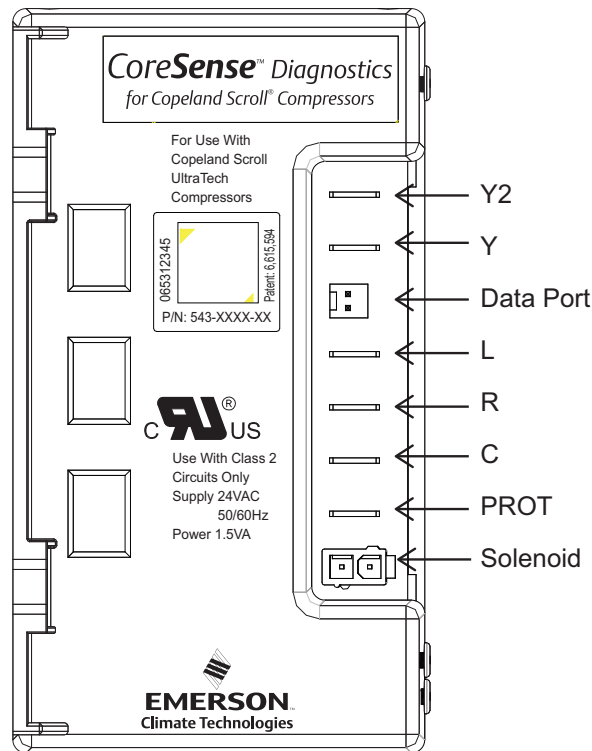

Figure 3 – Terminal Locations

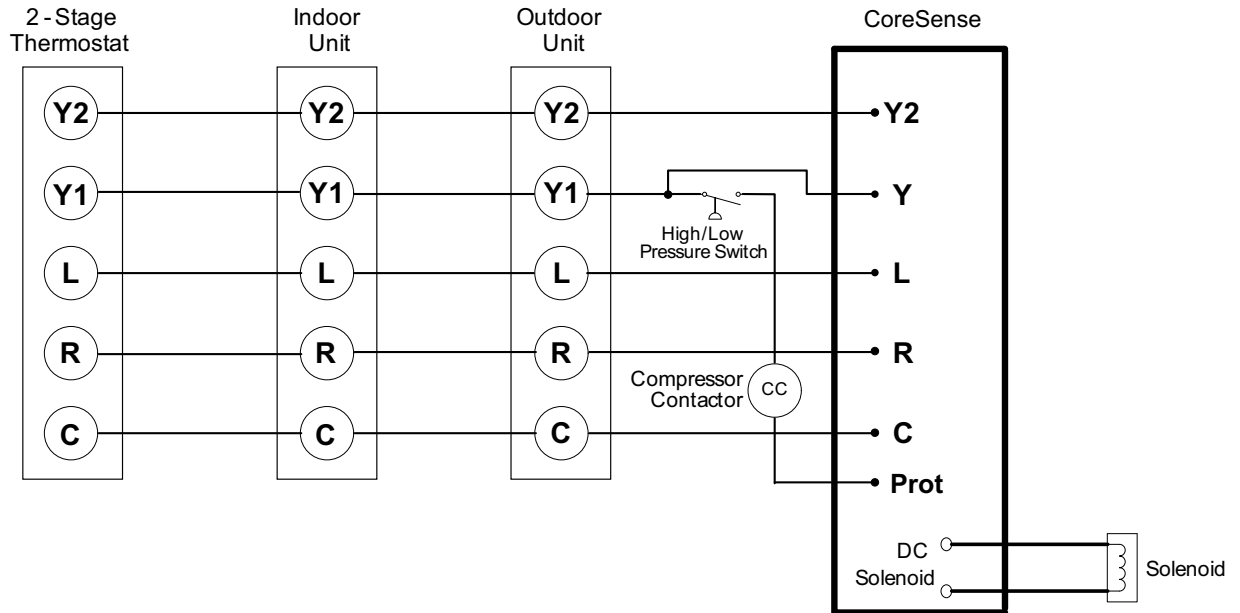

Figure 4
Wiring Diagram

Table 1 – Flash Code Description

Alert Code	Alert Condition	Lockout Level	Lockout Indication
Normal Run Solid Green	Normal operation, no trip.	N/A	N/A
Code1 Yellow Flash 1	Long run time. Compressor is running for more than 18 hours at full load. (Code1 is disabled in Heat Pump mode.)	N/A	N/A
Code2 Yellow Flash 2	Compressor Pressure trip. Compressor runs for 12sec to 15min followed by a compressor trip condition lasting longer than 7min.	4x consecutive, 10x total	Red: Flash 2
Code 3 Yellow Flash 3	Pressure switch cycling. Compressor runs for 12sec to 15min followed by a compressor trip lasting between 35sec to 7min.	4x consecutive, 10 total	Red: Flash 3
Code4 Yellow Flash 4	Locked rotor. Compressor trips within a compressor run time of 12sec and does not start within 35sec.	10x consecutive	Red: Flash 4
Code5 Yellow Flash 5	Compressor moderate run trip. Compressor runs for 15min to 18hrs followed by a compressor trip lasting longer than 7min.	4x consecutive, 10x total	Red: Flash 5
Code6 Red Flash 6	Open start circuit. Module has detected Y or Y1, and current in the R winding of the compressor and no current in the S winding of the compressor for 2 seconds.	1 occurrence	Red: Flash 6
Code7 Red Flash 7	Open run circuit. Module has detected Y or Y1, and current in the S winding of the compressor and no current in the R winding of the compressor for 2 seconds.	1 occurrence	Red: Flash 7
Code8 Yellow Flash 8	Welded Contactor. Module has detected line currents in R and S windings, and Y or Y1 is at 0 VAC for 15 seconds.	N/A	N/A
Code9 Yellow Flash 9	Low Voltage. Module has detected a 24 VAC supply voltage below 17 VAC +/- 1 VAC for 2 seconds	N/A	N/A
Code10 Red Flash 10	Over Current Protection. PROT terminal has above a 2A input for more than 40 milliseconds.	1 occurrence	Red: Flash 10

Table 2 – CoreSense Diagnostics LED Troubleshooting Information

Flash Code number corresponds to the number of LED flashes, followed by a pause and then repeated.
 TRIP and ALERT LEDs flashing at same time means control circuit voltage is too low for operation (brown-out conditions).

Status	Description	Troubleshooting Information
Solid Green "RUN"	Module has power and operating normally	Supply voltage is present at module terminals
Solid Red "TRIP"	Thermostat demand signal Y is present, but the compressor is not running	<ol style="list-style-type: none"> Compressor protector is open <ul style="list-style-type: none"> Check for high head pressure Check compressor supply voltage Outdoor unit power disconnect is open Compressor circuit breaker or fuse(s) is open Broken wire or connector is not making contact High pressure switch open if present in system Compressor contactor has failed open
"ALERT" Flash Codes		
Yellow "ALERT" Flash Code 1	Long Run Time Low Refrigerant Charge Compressor is running extremely long run cycles	<ol style="list-style-type: none"> Low refrigerant charge Evaporator blower is not running <ul style="list-style-type: none"> Check blower relay coil and contacts Check blower motor capacitor Check blower motor for failure or blockage Check evaporator blower wiring and connectors Check indoor blower control board Check thermostat wiring for open circuit Evaporator coil is frozen <ul style="list-style-type: none"> Check for low suction pressure Check for excessively low thermostat setting Check evaporator airflow (coil blockages or return air filter) Check ductwork or registers for blockage Faulty metering device <ul style="list-style-type: none"> Check TXV bulb installation (size, location and contact) Check if TXV/fixed orifice is stuck closed or defective Liquid line restriction (filter drier blocked if present in system) Thermostat is malfunctioning <ul style="list-style-type: none"> Check thermostat sub-base or wiring for short circuit Check thermostat installation (location, level)
Yellow "ALERT" Flash Code 2	Compressor (Pressure) Trip High Refrigerant Charge Discharge pressure out of limits or compressor overloaded	<ol style="list-style-type: none"> Condenser fan is not running <ul style="list-style-type: none"> Check fan capacitor Check fan wiring and connectors Check fan motor for failure or blockage High head pressure <ul style="list-style-type: none"> Check high pressure switch if present in system Check if system is overcharged with refrigerant Check for non-condensable in system Condenser coil poor air circulation (dirty, blocked, damaged) Return air duct has substantial leakage
Yellow "ALERT" Flash Code 3	Pressure Switch Cycling Compressor is running only briefly due to pressure switch cycling	<ol style="list-style-type: none"> Time delay relay or control board defective If high pressure switch present go to Flash Code 2 information

Table 2 Continued

Yellow "ALERT" Flash Code 4	Locked Rotor	<ol style="list-style-type: none"> 1. Run capacitor has failed 2. Low line voltage (contact utility if voltage at disconnect is low) <ul style="list-style-type: none"> • Check wiring connections 3. Excessive liquid refrigerant in compressor 4. Compressor bearings are seized <ul style="list-style-type: none"> • Measure compressor oil level
Yellow "ALERT" Flash Code 5	Compressor (Moderate Run) Trip	<ol style="list-style-type: none"> 1. Evaporator blower is not running <ul style="list-style-type: none"> • Check blower relay coil and contacts • Check blower motor capacitor • Check blower motor for failure or blockage • Check evaporator blower wiring and connectors • Check indoor blower control board • Check thermostat wiring for open circuit 2. Faulty metering device <ul style="list-style-type: none"> • Check TXV bulb installation (size, location and contact) • Check if TXV/fixed orifice is stuck closed or defective 3. Condenser coil poor air circulation (dirty, blocked, damaged) 4. Low refrigerant charge
Yellow "ALERT" Flash Code 8	Welded Contactor Compressor always runs	<ol style="list-style-type: none"> 1. Compressor contactor has failed closed 2. Thermostat demand signal not connected to module
Yellow "ALERT" Flash Code 9	Low Supply Voltage Voltage below 18V	<ol style="list-style-type: none"> 1. Control Circuit transformer is overloaded 2. Low line voltage (contact utility if voltage at disconnect is low)
"LOCKOUT" Flash Codes		
Red "LOCKOUT" Flash Code 2 Yellow Off	Compressor (Pressure) Trip Compressor is locked out after 4 consecutive or 10 total compressor (pressure) trip events	<ol style="list-style-type: none"> 1. Condenser fan is not running <ul style="list-style-type: none"> • Check fan capacitor • Check fan wiring and connectors • Check fan motor for failure or blockage 2. High head pressure <ul style="list-style-type: none"> • Check high pressure switch if present in system • Check if system is overcharged with refrigerant • Check for non-condensable in system 3. Condenser coil poor air circulation (dirty, blocked, damaged) 4. Return air duct has substantial leakage
Red "LOCKOUT" Flash Code 3 Yellow Off	Pressure Switch Cycling Compressor is locked out after 4 consecutive or 10 total pressure cycling events	<ol style="list-style-type: none"> 1. Time delay relay or control board defective 2. If high pressure switch present go to Flash Code 2 information
Red "LOCKOUT" Flash Code 4 Yellow Off	Locked Rotor Compressor is locked out after 10 consecutive locked rotor events	<ol style="list-style-type: none"> 1. Run capacitor has failed 2. Low line voltage (contact utility if voltage at disconnect is low) <ul style="list-style-type: none"> • Check wiring connections 3. Excessive liquid refrigerant in compressor 4. Compressor bearings are seized <ul style="list-style-type: none"> • Measure compressor oil level

Table 2 Continued

<p>Red "LOCKOUT" Flash Code 5 Yellow Off</p>	<p>Compressor (Moderate Run) Trip Compressor is locked out after 4 consecutive or 10 total compressor (moderate run) trip events</p>	<ol style="list-style-type: none"> 1. Evaporator blower is not running <ul style="list-style-type: none"> • Check blower relay coil and contacts • Check blower motor capacitor • Check blower motor for failure or blockage • Check evaporator blower wiring and connectors • Check indoor blower control board • Check thermostat wiring for open circuit 2. Faulty metering device <ul style="list-style-type: none"> • Check TXV bulb installation (size, location and contact) • Check if TXV/fixed orifice is stuck closed or defective 3. Condenser coil poor air circulation (dirty, blocked, damaged) 4. Low refrigerant charge
<p>Red "LOCKOUT" Flash Code 6 Yellow Off</p>	<p>Open Start Circuit Current only in run circuit</p>	<ol style="list-style-type: none"> 1. Run capacitor has failed 2. Open circuit in compressor start wiring or connections <ul style="list-style-type: none"> • Check wiring and connectors between supply and the compressor "S" terminal 3. Compressor start winding is damaged <ul style="list-style-type: none"> • Check compressor motor winding resistance
<p>Red "LOCKOUT" Flash Code 7 Yellow Off</p>	<p>Open Run Circuit Current only in start circuit</p>	<ol style="list-style-type: none"> 1. Open circuit in compressor run wiring or connections <ul style="list-style-type: none"> • Check wiring and connectors between supply and the compressor "R" terminal. Confirm proper wire routing per Figure 1. 2. Compressor run winding is damaged <ul style="list-style-type: none"> • Check compressor motor winding resistance
<p>Red "LOCKOUT" Flash Code 10</p>	<p>Over Current Protection Current to PROT is greater than 2A mps</p>	<ol style="list-style-type: none"> 1. Check for contactor shorted to ground 2. Check for mis-wiring to the PROT terminal

The contents of this publication are presented for informational purposes only and they are not to be construed as warranties or guarantees, express or implied, regarding the products or services described herein or their use or applicability. Emerson Climate Technologies, Inc. reserves the right to modify the designs or specifications of such products at any time without notice. Emerson Climate Technologies, Inc. does not assume responsibility for the selection, use or maintenance of any product. Responsibility for proper selection, use and maintenance of any Emerson Climate Technologies, Inc. product remains solely with the purchaser and end-user.