

Liebert® GXT3™ UPS 120V/208V 500VA-3000VA

User Manual



TABLE OF CONTENTS

IMPORTANT SAFETY PRECAUTIONS	1
SAVE THESE INSTRUCTIONS	1
GLOSSARY OF SYMBOLS	3
1.0 PRODUCT DESCRIPTION	4
1.1 Features	4
1.2 Available Models	4
1.3 Appearance and Components	5
1.3.1 Front Panel and Controls	5
1.3.2 Rear Panel Features	5
1.4 Major Components	8
1.5 Operating Mode	9
1.5.1 Utility (AC) Mode	9
1.5.2 Manual Bypass Mode	9
1.5.3 Battery Mode	10
1.5.4 Battery Recharge Mode	10
1.5.5 Frequency Converter Mode	10
2.0 INSTALLATION	11
2.1 Unpacking and Inspection	11
2.2 What's Included	11
2.3 Preparation for Installation	11
2.3.1 Installation Environment	11
2.4 Mechanical Installation	12
2.4.1 Tower Installation	12
2.4.2 Rack Installation	14
2.5 Cable Connection	17
2.5.1 Connecting Input Plug and Loads	17
2.5.2 Connecting Battery Cables	17
2.6 Connecting Communication Cables	18
2.6.1 Connecting USB Communication Cables	18
2.6.2 Installing the Optional Liebert IntelliSlot [®] Card and Communication Cables	18
3.0 CONTROLS AND INDICATORS	19
3.1 Control Buttons	19
3.1.1 On/Alarm Silence/Manual Battery Test Button	19
3.1.2 Standby/Manual Bypass Button	19
3.2 Indicators	20
3.2.1 Level Indicators	20
3.2.2 UPS Status Indicators	21

4.0	OPERATION	22
4.1	Startup Checklist for the Liebert GXT3	22
4.2	Starting the UPS	22
4.3	Manual Battery Test	22
4.4	Manual Bypass	22
4.5	Shut Down the Liebert® GXT3™	23
4.6	Disconnecting Input Power from the Liebert GXT3	23
5.0	COMMUNICATION	24
5.1	Liebert IntelliSlot Communication Cards	24
5.1.1	Liebert MultiLink	24
5.2	USB Port Communication	25
5.2.1	Configuration Program	25
5.3	Terminal Block Communication	26
5.3.1	Any-Mode Shutdown	26
5.3.2	Battery Mode Shutdown	27
5.3.3	On Battery	27
5.3.4	Low Battery	27
6.0	MAINTENANCE	28
6.1	Replacing the Internal Battery Pack	28
6.1.1	Battery Replacement Procedures	28
6.2	Battery Charging	30
6.3	Precautions	30
6.4	Checking UPS Status	30
6.5	Checking UPS Functions	30
7.0	TROUBLESHOOTING	31
7.1	UPS Symptoms	31
7.1.1	Indicators	31
7.1.2	Audible Alarm	32
7.2	Troubleshooting	32
8.0	BATTERY CABINET	34
9.0	SPECIFICATIONS	35
9.1	Product Warranty Registration	39

FIGURES

Figure 1	Liebert GXT3 rack/tower models—front view	5
Figure 2	Liebert GXT3 minitower—front view	5
Figure 3	Liebert® GXT3™ 120V rack/tower models—rear panel components	6
Figure 4	Liebert® GXT3™ 208V rack/tower models—rear panel components	7
Figure 5	Liebert GXT3-1000MT120™—rear panel components	7
Figure 6	Operating principle diagram	8
Figure 7	Support bases	12
Figure 8	Remove the front plastic bezel cover	12
Figure 9	Rotate the operation and display panel	13
Figure 10	Tower installation	13
Figure 11	Pulling inner member from each slide rail assembly	14
Figure 12	Installing rear member of each slide rail assembly	14
Figure 13	Installing front member of each slide rail assembly	15
Figure 14	Fastening rear member and front member together	15
Figure 15	Installing inner members	15
Figure 16	Installing rack-mount handles	16
Figure 17	Insert the UPS	16
Figure 18	Operation and display panel	19
Figure 19	Battery level indicators	20
Figure 20	Load level indicators	20
Figure 21	Terminal block communication pin layout	26
Figure 22	Removing the front bezel cover and battery door	29
Figure 23	Disconnecting the battery plug and battery receptacle (front view)	29
Figure 24	Pull out the battery	29
Figure 25	Battery level indicator	31
Figure 26	Battery cabinet	34

TABLES

Table 1	UPS models, power ratings	4
Table 2	Input circuit breaker specification	17
Table 3	Functions of On/Alarm Silence/Manual battery test button	19
Table 4	Functions of Standby/Manual Bypass button	19
Table 5	UPS status indicators	21
Table 6	Output voltage option	25
Table 7	Replacement internal battery pack model number	28
Table 8	Indicator descriptions	31
Table 9	Audible alarm description	32
Table 10	Troubleshooting	32
Table 11	Specifications of GXT3-500RT120 - GXT3-1000RT120 and GXT3-1000MT120 UPS	35
Table 12	Specifications of GXT3-1500RT120 - GXT3-3000RT120 and GXT3-3000RT208 UPS	36
Table 13	Operating temperature parameters	37
Table 14	Battery cabinet specifications	37
Table 15	Battery run times	38

IMPORTANT SAFETY PRECAUTIONS



WARNING

Observe all cautions and warnings in this manual. Failure to do so may result in serious injury or death.

Refer all UPS and battery service to properly trained and qualified service personnel. Do not attempt to service this product yourself.

Opening or removing the cover may expose you to lethal voltages within this unit even when it is apparently not operating and the input wiring is disconnected from the electrical source.

Never work alone.

SAVE THESE INSTRUCTIONS

This manual contains important safety instructions that must be followed during the installation and maintenance of the UPS and batteries. Read this manual thoroughly before attempting to install or operate this UPS.

UPS Safety Notes

This UPS contains no user-serviceable parts except the internal battery pack. The Off/Bypass push button does not electrically isolate internal parts. Under no circumstances attempt to gain internal access other than to replace the batteries due to risk of electric shock or burn. Do not continue to use the UPS if the front panel indications are not in accordance with these operating instructions or if the UPS performance alters in use. Refer all faults to your local dealer, Emerson Network Power representative or Emerson Network Power Channel Support.

This UPS has an internal battery, and the output receptacles of the UPS may carry live voltage even if the UPS is not connected to utility input power.

Before moving or rewiring this UPS, disconnect utility input power and the battery and make sure that the UPS is completely shut down. Otherwise, the output terminal may carry live voltage, presenting an electric shock hazard.

To ensure human safety and normal UPS operation, the UPS must be properly grounded before use. When the UPS is connected to an IT power distribution system, a short-circuit protection device must be installed on the neutral line.

Install and use the Liebert® GXT3™ in the following environments:

- Temperature: 32°F - 104°F (0°C - 40°C), relative humidity: 0% ~ 95% non-condensing
- Out of direct sunlight
- Away from heat sources
- Stable surface, not subject to vibrations or shocks
- Away from dust and other particulates
- Away from corrosive substances, salts and flammable gases

Keep the air inlet and outlet of this UPS unobstructed. Poor ventilation will increase the internal temperature of the UPS and can adversely affect the UPS and its batteries.

Keep liquid and foreign objects away from the UPS.

In case of fire, use a dry chemical fire extinguisher to put out the fire. Using a fluid fire extinguisher may cause electric shock.

This UPS is not intended for use with life support and other designated critical devices. Maximum load must not exceed that shown on the UPS rating label. This UPS is designed for data processing equipment. If uncertain, consult your local dealer or Emerson representative.

This UPS is not for use in a computer room as defined in the standard for the Protection of Electronic Computer/Data Processing Equipment, ANSI/NFPA 75.

The Liebert® GXT3-3000RT120™ was tested under 30A branch circuit in accordance with the National Electrical Code, ANSI/NFPA 70. To reduce the risk of fire, connect only to a circuit provided with 30A maximum branch overcurrent protection.

The Liebert® GXT3™-3000RT208 was tested under 20A branch circuit in accordance with the National Electrical Code, ANSI/NFPA 70. To reduce the risk of fire, connect only to a circuit provided with 20A maximum branch overcurrent protection.

Battery Safety



CAUTION

Do not dispose of batteries in a fire. The batteries may explode.

Do not open or mutilate the batteries. Released electrolyte is toxic and is harmful to skin and eyes.

Dispose of used batteries according to the instructions.



CAUTION

A battery can present a risk of electrical shock and high short circuit current. The following precautions should be observed when working on batteries:

- Remove watches, rings and other metal objects.
- Use tools with insulated handles.
- Wear rubber gloves and boots.
- Do not lay tools or metal parts on top of batteries.
- Disconnect charging source prior to connecting or disconnecting battery terminals.
- Determine if the battery is inadvertently grounded. If it is inadvertently grounded, remove the source of the ground. Contact with any part of a grounded battery can result in electrical shock. The likelihood of such shock will be reduced if grounds are removed during installation and maintenance (applicable to a UPS and a remote battery supply not having a grounded supply circuit).











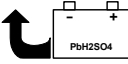

ELECTROMAGNETIC COMPATIBILITY—The Liebert GXT3 complies with the limits for a CLASS A DIGITAL DEVICE, PURSUANT TO Part 15 of FCC rules. Operation is subject to the following two conditions: (1) This device may not cause harmful interference and (2) this device must accept any interference received, including interference that may cause undesired operation. Operating this device in a residential area is likely to cause harmful interference that users must correct at their own expense.

The Liebert GXT3 series complies with the requirements of EMC Directive 2004/108/EC and the published technical standards. Continued compliance requires installation in accordance with these instructions and use of accessories approved by Emerson.

Information for the Protection of the Environment

UPS Servicing: UPS makes use of components dangerous for the environment (electronic cards, electronic components). The components removed must be taken to specialized collection and disposal centers.

GLOSSARY OF SYMBOLS

	Risk of electrical shock
	Indicates caution followed by important instructions
	AC input
	AC output
	Requests the user to consult the manual
	Indicates the unit contains a valve-regulated lead acid battery
	Recycle
	DC voltage
	Equipment grounding conductor
	Bonded to ground
	AC voltage
	ON/Alarm Silence/Battery Test
	OFF/Bypass
	WEEE

1.0 PRODUCT DESCRIPTION

The Liebert® GXT3™ is a compact, online uninterruptible power system (UPS) that continuously conditions and regulates its output voltage. The Liebert GXT3 is designed to supply microcomputers and other sensitive equipment with clean sine wave input power.

Upon generation, AC power is clean and stable. However, during transmission and distribution it is subject to voltage sags, spikes and complete failure that may interrupt computer operations, cause data loss and damage equipment.

The Liebert GXT3 protects equipment from these disturbances. The Liebert GXT3 continuously charges its batteries from utility power, enabling it to supply power to connected loads, even when utility power fails.

This sections describes the UPS, its features, models, appearance and components, operating principles and operating mode.

1.1 Features

- Intelligent battery management to extend the battery life
- Operation and display panel with LED for monitoring load percentage and battery capacity independently
- Flexible network management with Liebert MultiLink™ software
- Fan fault self-inspection and automated diagnostic function
- Intelligent fan operation, automatically changing rotation speed depending on system requirements, to decrease power consumption and noise
- Input circuit breaker to ease recovery from overloads
- Safety approval from UL and cUL
- Communication options: USB port, Liebert IntelliSlot® port and terminal block communication
- Dry contacts for remote monitoring
- Input power factor greater than 0.99
- Output voltage selection function

1.2 Available Models

Eight UPS models are available.

Table 1 UPS models, power ratings

Model	Nominal Power Rating
GXT3-500RT120	500VA/450W
GXT3-700RT120	700VA/630W
GXT3-1000RT120	1000VA/900W
GXT3-1000MT120	1000VA/900W, minitower
GXT3-1500RT120	1500VA/1350W
GXT3-2000RT120	2000VA/1800W
GXT3-3000RT120	3000VA/2700W
GXT3-3000RT208	3000VA/2700W

1.3 Appearance and Components

1.3.1 Front Panel and Controls

The Liebert® GXT3™ rack/tower and minitower models in various power ratings have the same general appearance, controls and features (see **Figure 1**). The various rack/tower and minitower models differ largely in the type of receptacles each has.

Figure 1 Liebert GXT3 rack/tower models—front view

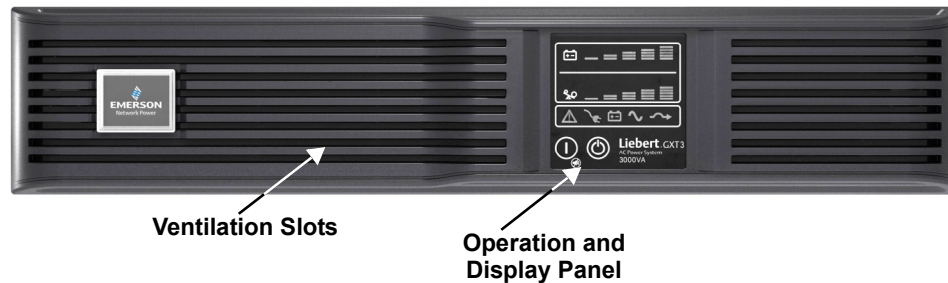

The Liebert GXT3-1000MT120™ has the same controls and features in a minitower arrangement (see **Figure 2**).

Figure 2 Liebert GXT3 minitower—front view

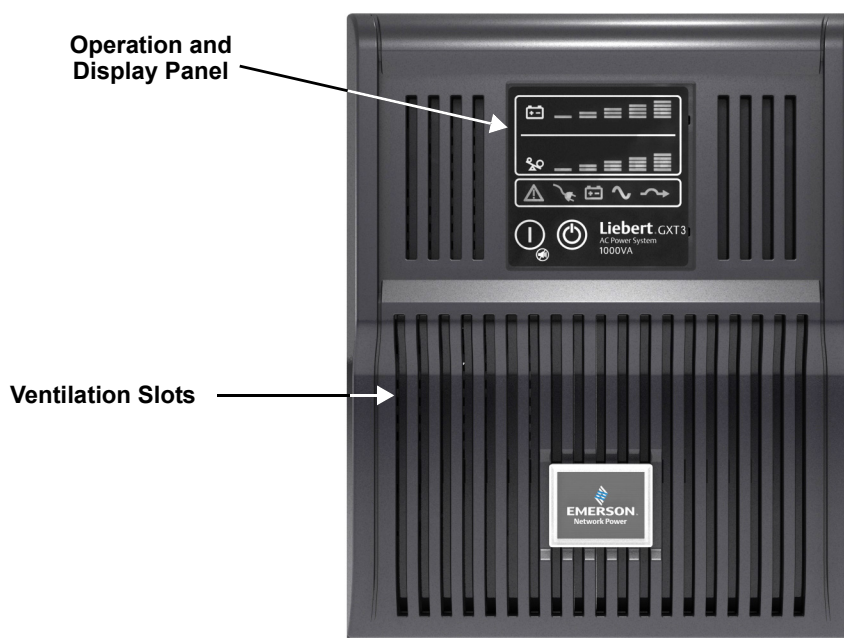

1.3.2 Rear Panel Features

The rear panel of the Liebert GXT3 has these features:

- USB port
- Cooling fan
- Power output receptacles
- Input circuit breaker
- Liebert IntelliSlot® port
- Communication terminal block
- Input power cable

Figure 3 Liebert® GXT3™ 120V rack/tower models—rear panel components

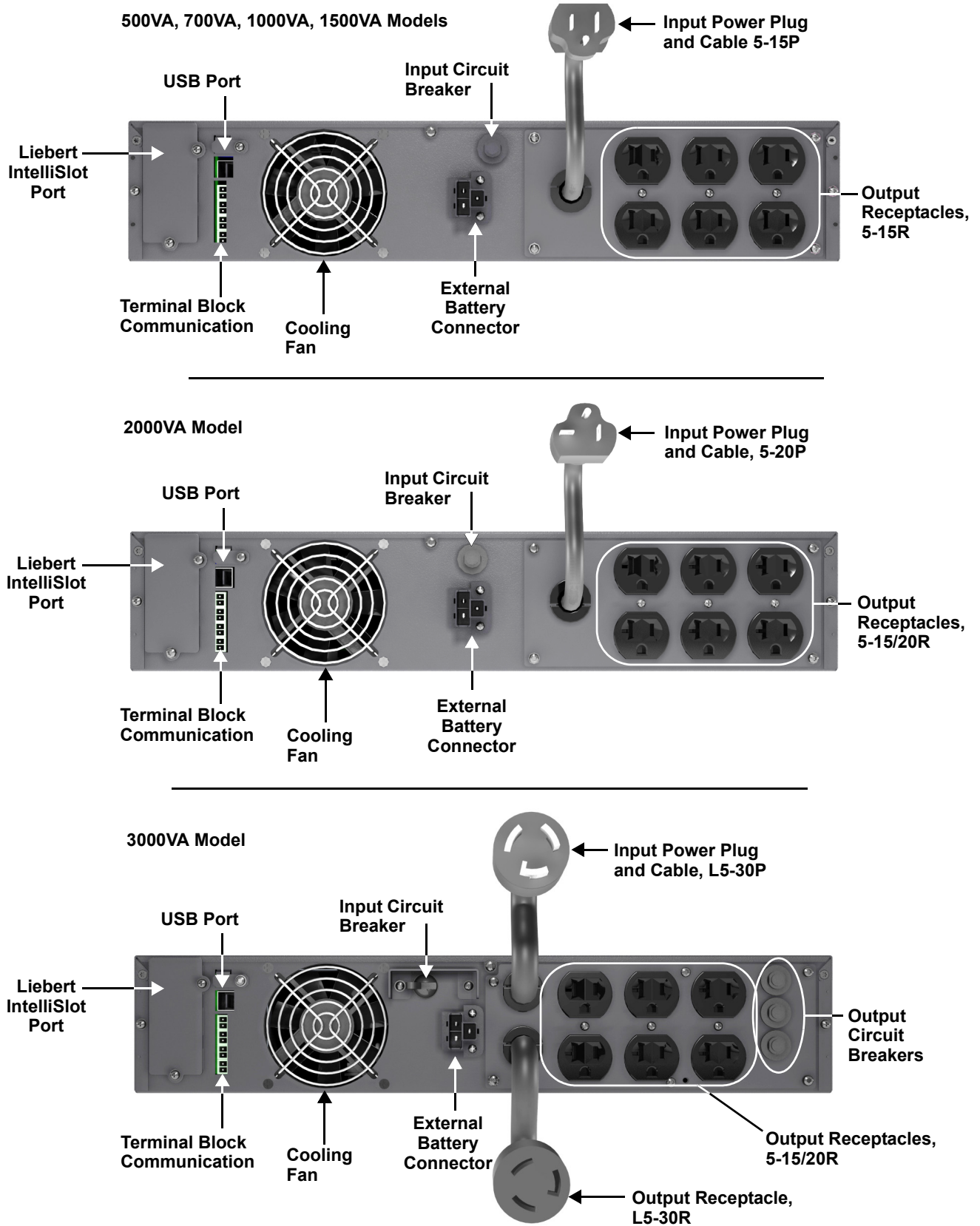

Figure 4 Liebert® GXT3™ 208V rack/tower models—rear panel components

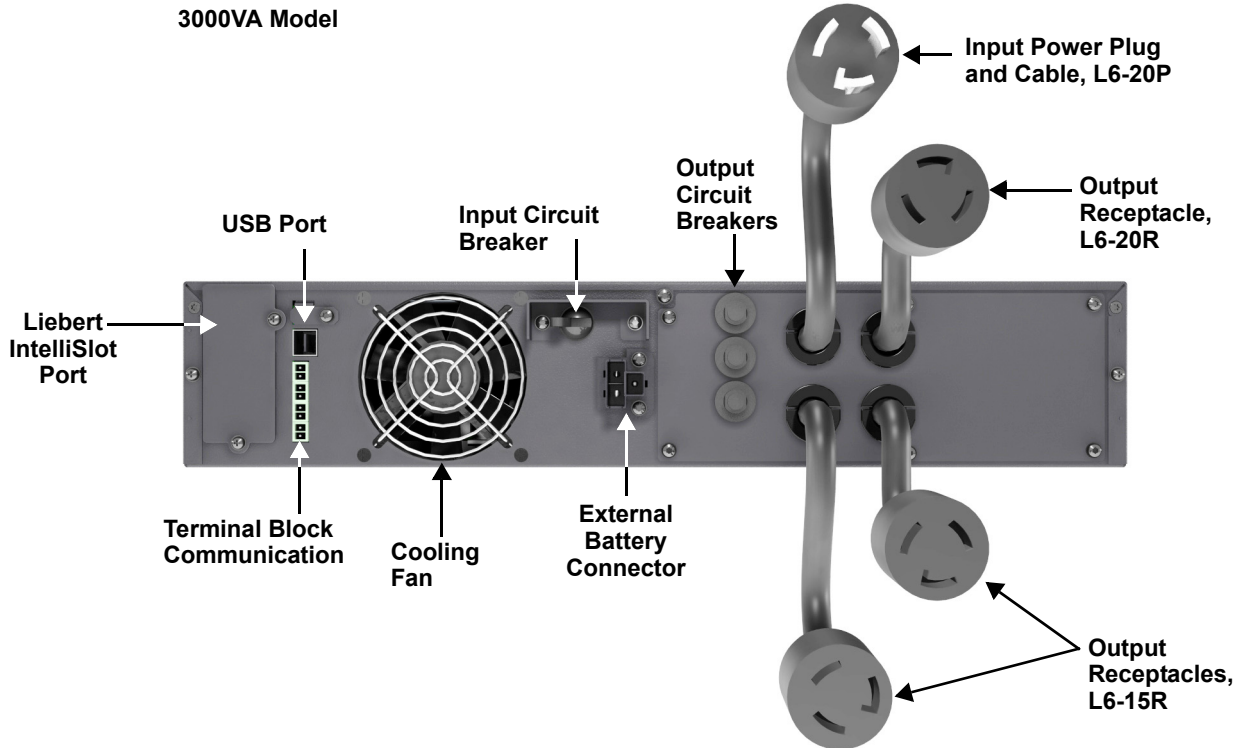
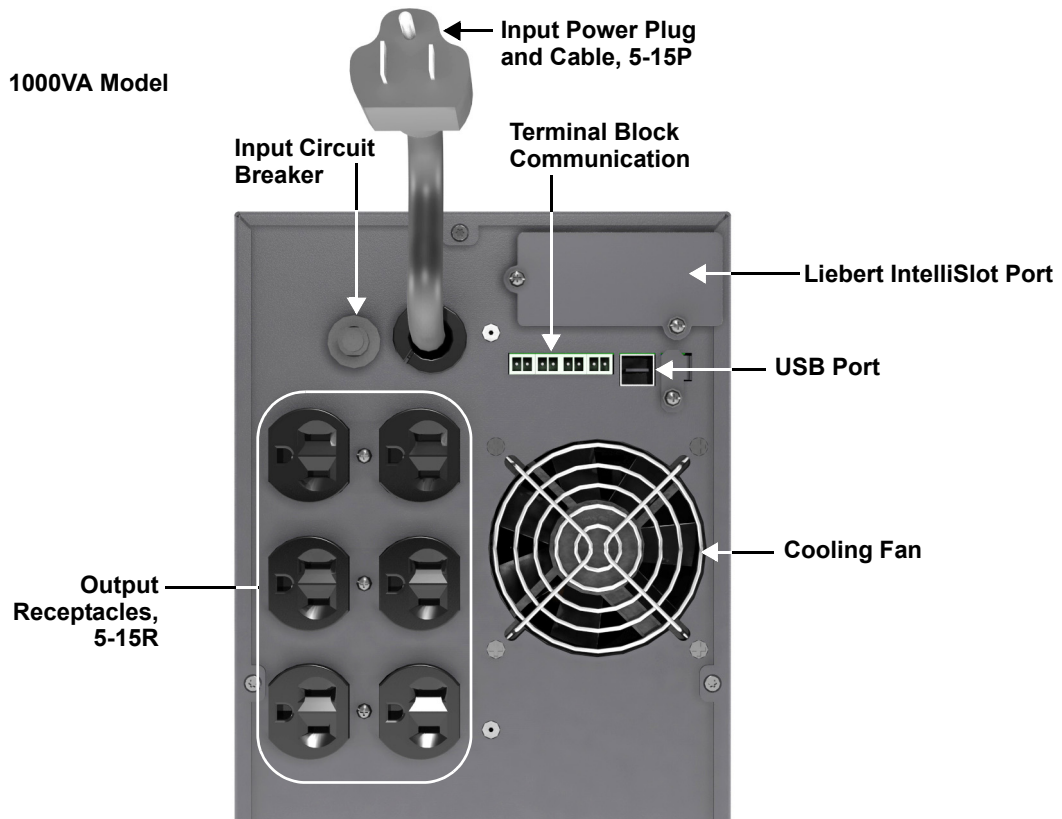

Figure 5 Liebert GXT3-1000MT120™—rear panel components



1.4 Major Components

The operating principle of the UPS is illustrated in **Figure 6**.

Figure 6 Operating principle diagram

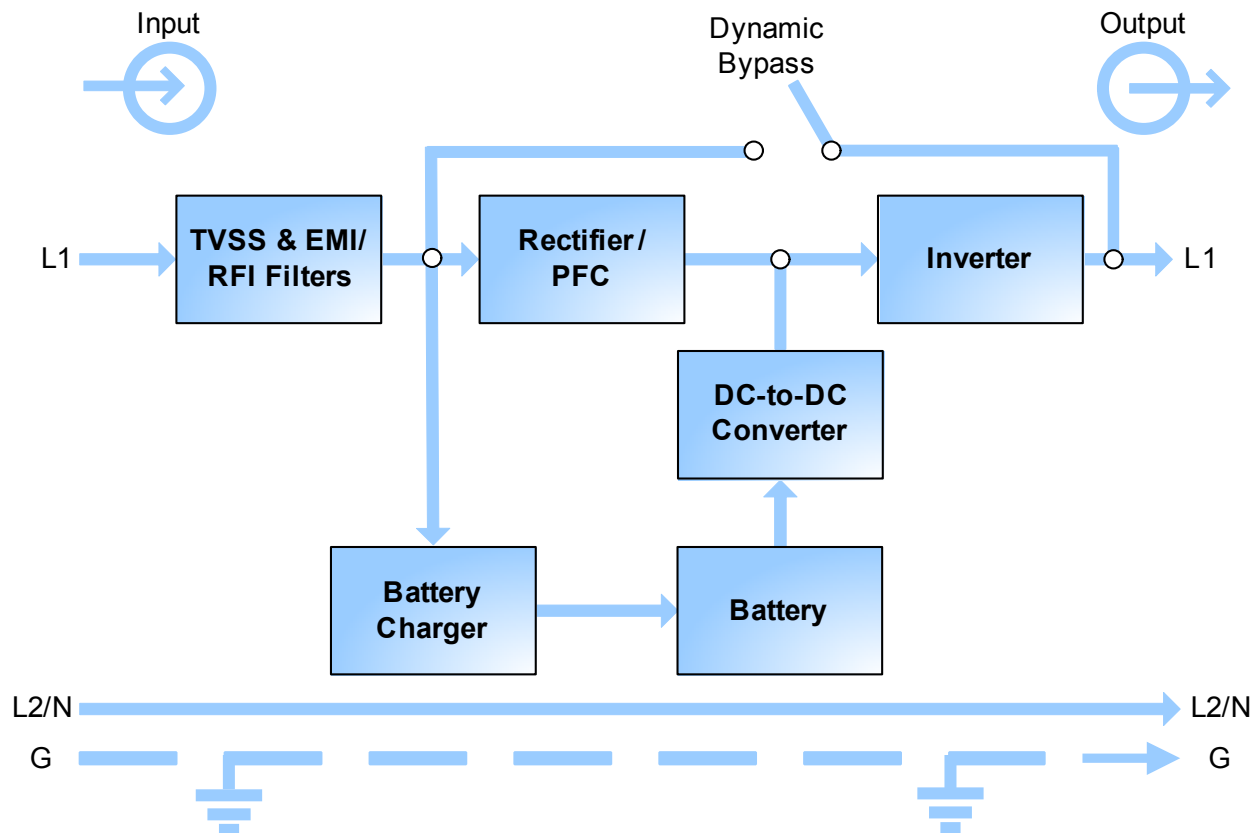

The UPS is composed of utility input, TVSS and EMI/RFI filters, rectifier/PFC, inverter, battery charger, DC-to-DC converter, battery, dynamic bypass and UPS output.

Transient Voltage Surge Suppression (TVSS) and EMI/RFI Filters

The Liebert® GXT3™ has surge protection and filters that protect the connected load from power surges, electromagnetic interference (EMI) and radio frequency interference (RFI). These features can minimize any surges or interference present in the utility power. The filters also prevent surges or interference generated by the UPS from adversely affecting devices connected on the same branch as the UPS.

Rectifier/Power Factor Correction (PFC) Circuit

In normal operation, the Liebert GXT3's rectifier/power factor correction (PFC) circuit converts utility power to regulated DC power for use by the inverter while ensuring that the wave shape of the input current used by the UPS is near ideal. Extracting this sinewave input current achieves two objectives:

- Efficient power use by the UPS
- Reduced reflected harmonics

This results in cleaner power being available to other devices in the building not being protected by the Liebert GXT3.

Inverter

In normal operation, the Liebert GXT3's inverter utilizes the DC output of the PFC to produce precise, regulated sine wave AC power. When utility power fails, the inverter receives DC power from the DC-to-DC Converter. In either operation mode, the UPS inverter is online, continuously generating clean, precise, regulated AC output power.

Battery Charger

The battery charger utilizes energy from the utility power and precisely regulates it to continuously float charge the batteries. The batteries are being charged whenever the Liebert® GXT3™ is plugged in, even when the UPS is not turned On.

DC-to-DC Converter

The DC-to-DC converter raises the DC voltage from the battery to the optimum operating voltage for the inverter. This allows the inverter to operate continuously at its optimum efficiency and voltage, thus increasing reliability.

Battery

The Liebert GXT3 uses valve-regulated, nonspillable, lead acid batteries. To maintain battery design life, operate the Liebert GXT3 in an ambient temperature of 32°F to 77°F (0°C to 25°C).

Optional external battery cabinets are available to extend battery run times.

Dynamic Bypass

The Liebert GXT3 provides an alternate path for utility power to the connected loads in the unlikely event of a UPS malfunction. Should the Liebert GXT3 have an overload, overtemperature or UPS failure condition, the UPS automatically transfers the connected loads to bypass.



NOTE

The bypass power path does not protect the connected loads from disturbances on the utility.

1.5 Operating Mode

The UPS operation modes include: Utility (AC) mode, bypass mode, battery mode, battery recharge mode and frequency converter mode.

For the descriptions of indicators and control buttons in this section, refer to **3.0 - Controls and Indicators**.

1.5.1 Utility (AC) Mode

During Utility (AC) Mode, utility power provides energy to the Liebert GXT3. The filters, PFC circuit and the inverter process this power to provide computer-grade power to connected loads. Meanwhile, the UPS maintains the batteries in a fully charged state.

1.5.2 Manual Bypass Mode

Manual Bypass Mode occurs when the Standby/Manual bypass button is pressed and held for about 2 seconds while the Liebert GXT3 is in Utility (AC) Mode. Bypass operation is indicated by an audible alarm and illuminated amber bypass indicator (If other indicators are illuminated, refer to **7.0 - Troubleshooting**). During manual bypass mode, utility power bypasses the inverter and provides energy to the connected load.

NOTICE

Turning Off the UPS in bypass mode will result in loss of output power and dropped loads.

1.5.3 Battery Mode

The Liebert® GXT3™ enters Battery Mode when utility power fails or is outside acceptable values. The battery system supplies power through the DC-to-DC converter to the inverter to generate clean AC power for the connected loads.

When the Liebert GXT3 enters Battery Mode, the UPS sounds a half-second beep at 10-second intervals. When approximately 2 minutes of run time remains, the beeps sound every 5 seconds to warn that the battery is getting low (this Low Battery Warning is user-configurable).

In Battery Mode, the AC Input indicator goes Off and the Battery Level indicators illuminate. Each battery level indicator represents a 20% capacity level. As capacity decreases, fewer indicators remain illuminated. Refer to **7.0 - Troubleshooting**.

For approximate battery run times, refer to **9.0 - Specifications**.

NOTICE

Turning Off the Liebert GXT3 when it is in Battery Mode will result in loss of output power. If the UPS is turned Off manually, it must be manually restarted after utility power returns. If the UPS is turned Off by a communication signal or because the batteries are depleted, it will operate as selected in the configuration program for Auto-Restart (Refer to **5.2.1 - Configuration Program**).

1.5.4 Battery Recharge Mode

Once utility power is applied to the Liebert GXT3, the Battery Charger begins charging the batteries.

1.5.5 Frequency Converter Mode

All models of the Liebert GXT3 are capable of frequency conversion. Frequency Conversion Mode can be selected using the configuration program. Allowable frequency operating modes include:

- Auto Sensing - 50Hz or 60Hz – Bypass Enabled
- Auto Sensing - 50Hz or 60Hz – Bypass Disabled
- Frequency Converter - 50Hz – Bypass Disabled
- Frequency Converter - 60Hz – Bypass Disabled

The default for all models of the Liebert GXT3 is “Auto Sensing - 50Hz or 60Hz – Bypass Enabled.”

2.0 INSTALLATION

2.1 Unpacking and Inspection

Unpack the UPS and conduct the following checks:

- Inspect the UPS for shipping damage. If any shipping damage is found, report it to the carrier and your local dealer or your Emerson representative immediately.
- Check the accessories included in packaging list. If there is any discrepancy, contact your local dealer or your Emerson representative immediately.

2.2 What's Included

With GXT3 UPS

- Compact Disk with:
 - Liebert MultiLink®
 - Configuration Program
 - User Manual
- Terminal Block Communication terminals
- USB Cable: one, 6-1/2 ft. (2m) long
- Mounting hardware, including screws and handles
- Plastic tower stand sets: 2 (four pieces)
- Warnings, Safety Instructions booklet and WEEE recycling sheet (ISO 14001 compliance)



NOTE

The GXT3 External Battery Cabinet shipping package includes one battery cabinet, two spacers for tower configuration and one DC power cable.

2.3 Preparation for Installation

2.3.1 Installation Environment

- Install the UPS indoors in a controlled environment, where it cannot be accidentally turned Off. The installation environment should meet the specifications listed in **9.0 - Specifications**).
- Place it in an area of unrestricted airflow around the unit, away from water, flammable liquids, gases, corrosives, and conductive contaminants. Avoid direct sunlight.



NOTE

Operating the Liebert GXT3™ in temperatures above 77°F (25°C) reduces battery life.

Installation Clearances

Maintain at least 4 inches (100mm) clearance in the front and rear of the Liebert GXT3. Do not obstruct the air inlets on the front panel and rear panel of the UPS; blocking the air inlets reduces ventilation and heat dissipation, shortening the service life of the Liebert GXT3.

2.4 Mechanical Installation

The Liebert® GXT3™ may be installed as a tower or in a rack, depending on space and use considerations. The Liebert GXT3 may be used alone, as a single UPS, or with up to four battery cabinets.



NOTE

When installing the UPS or making input and output connections, comply with all relevant safety codes and standards

2.4.1 Tower Installation

To install the Liebert GXT3 as a tower:

1. Take out support bases from the accessories (see **Figure 7**).

Figure 7 Support bases

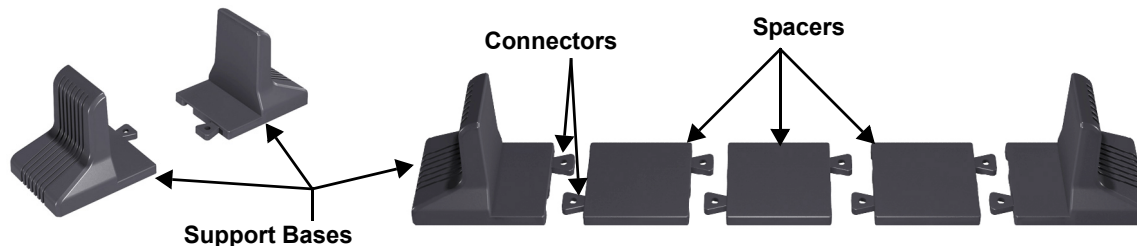

2. If optional Liebert external battery cabinets will be connected to the Liebert GXT3, take out the spacers shipped with the battery cabinet.
3. Connect the spacers and the support bases as shown in **Figure 7**. Each Liebert GXT3 needs two assembled support bases, one in the front and one in the rear.
4. Adjust the direction of the operation and display panel and logo on the Liebert GXT3.
 - a. Remove the front plastic bezel cover as shown in **Figure 8**.

Figure 8 Remove the front plastic bezel cover



- b. Pull the operation and display panel gently, rotate it 90 degrees clockwise and snap it back into position, as shown in **Figure 9**.

Figure 9 Rotate the operation and display panel

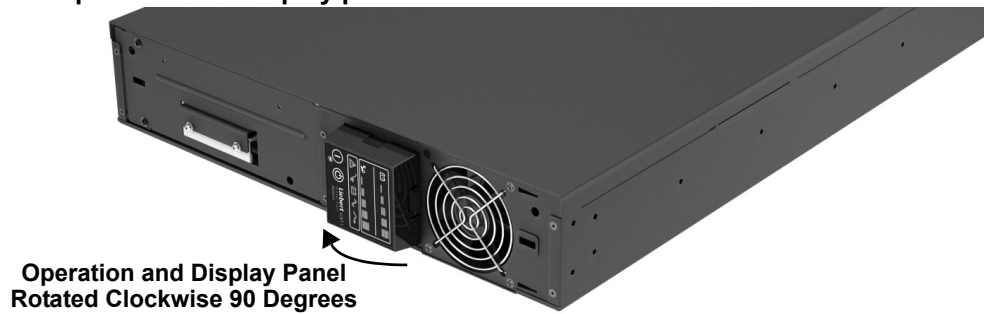

- c. Pull the logo on the front plastic bezel cover gently, rotate it 90 degrees clockwise and snap it back into position. The rotated front plastic bezel cover is shown in **Figure 10**.
 - d. Replace the front plastic bezel cover on the Liebert® GXT3™. At this point, the UPS operation and display panel and logo have been rotated 90 degrees clockwise, which provides upright viewing for users.
5. Place the Liebert GXT3 and any battery cabinets on the support bases. Each Liebert GXT3 needs two support assemblies, as shown in **Figure 10**.

Figure 10 Tower installation

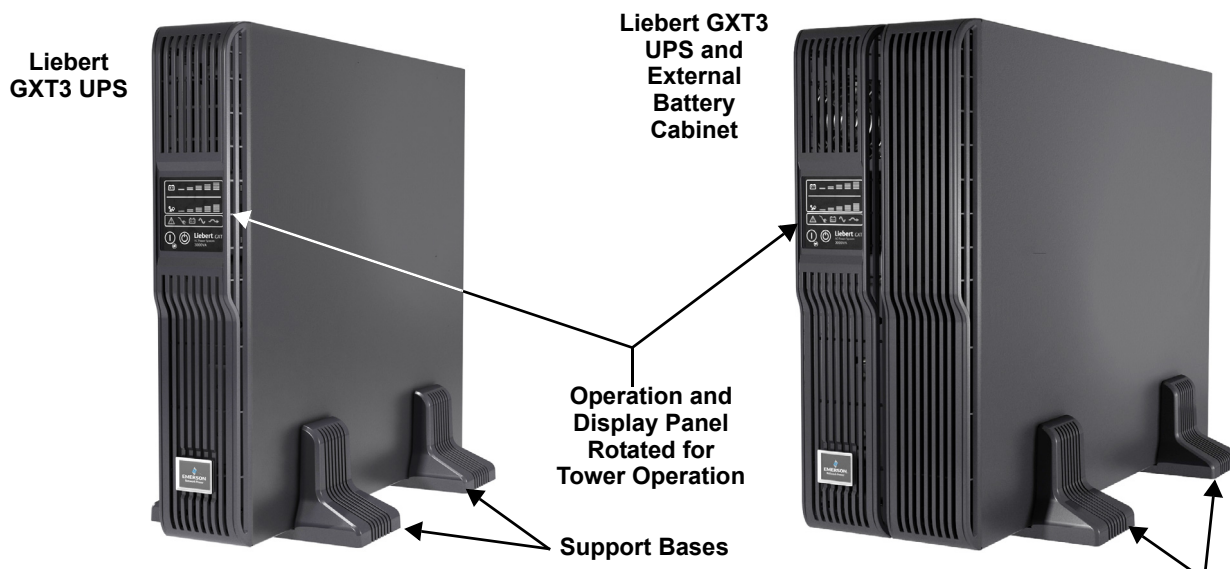

2.4.2 Rack Installation



NOTE

- When the Liebert® GXT3™ is installed in a rack, it must be supported by a shelf, fixed rails or slide rails on each side. The factory-supplied rack mount handles cannot support the weight of the UPS. They are used to move the UPS into and out of the rack and attach the UPS to the rack.
- Mounting hardware and slide rails are sold separately. Contact your local Emerson representative for these options and any assistance.
- GXT3-1000MT120 cannot be installed in a rack. The unit is a minitower only.

To install a Liebert GXT3 rack/tower UPS in a rack:

1. Unpack the two slide rails assemblies and mounting hardware from the rack-mounting kit (P/N: RMKIT18-32).

Slide rail assembly includes inner member and front and rear members. They are interchangeable between left-hand or right-hand. Mounting hardware includes M4 screws and M5 screws.

2. Remove inner member of each slide rail assembly by extending it to its outermost position, depressing the retaining latch and then pulling inner member from slide rail assembly (see **Figure 11**).

Figure 11 Pulling inner member from each slide rail assembly

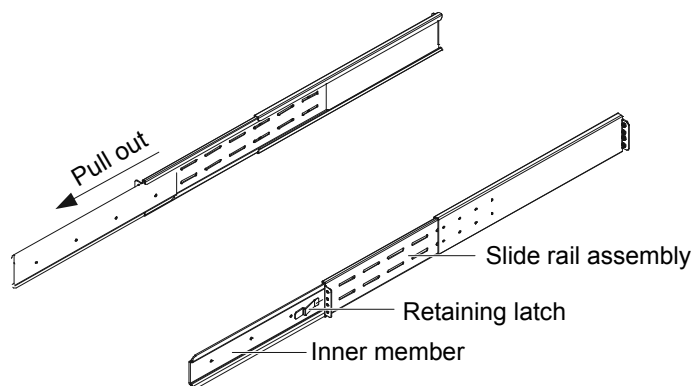

3. Determine the Liebert GXT3's mounting position inside the rack's vertical rails.



CAUTION

Reduce the risk of tipping the rack by installing the Liebert GXT3 as low as possible in the rack.

4. Attach the rear member of each slide rail assembly to the rack's rails with two factory-supplied M5 screws (see **Figure 12**).

Figure 12 Installing rear member of each slide rail assembly

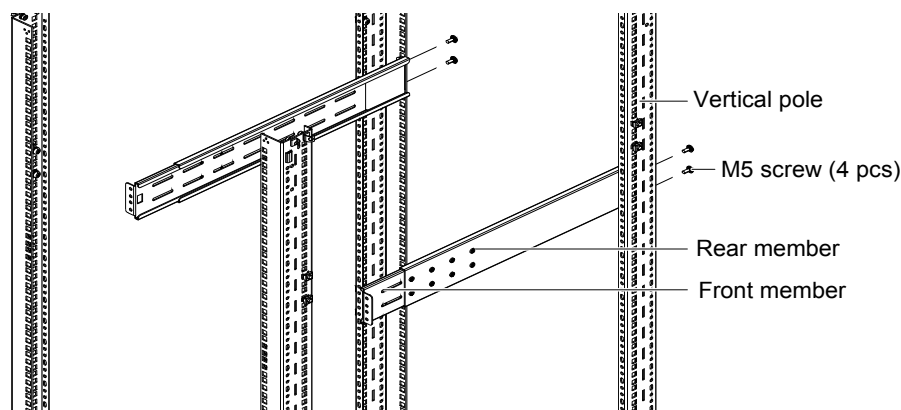

5. Extend the slide rail assembly by sliding the front member forward until it touches the rack's front vertical rails (adjustable length: 18 to 32 inches [457-813mm]). Use two M5 screws to fix each front member onto the front vertical rails through the installation holes. Make sure that slide rail assemblies are at the same mounting height on all four rack rails, as shown in **Figure 13**.

Figure 13 Installing front member of each slide rail assembly

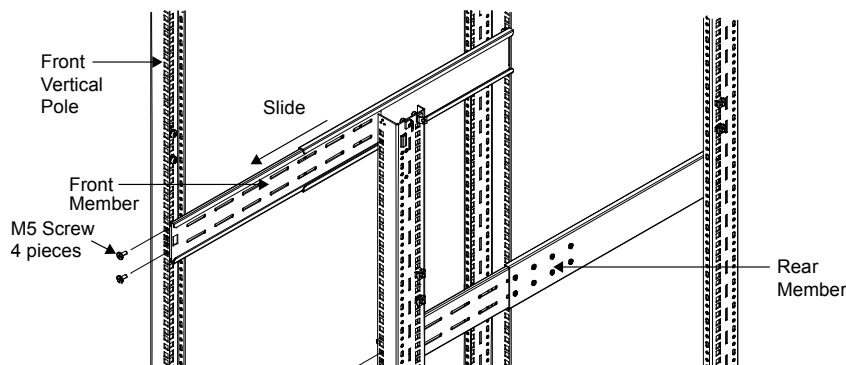

6. Fasten rear member and front member together using four M4 screws and four M4 nuts (M4 nuts have been factory-installed on the rear member) per slide rail assembly, as shown in **Figure 14**.

Figure 14 Fastening rear member and front member together

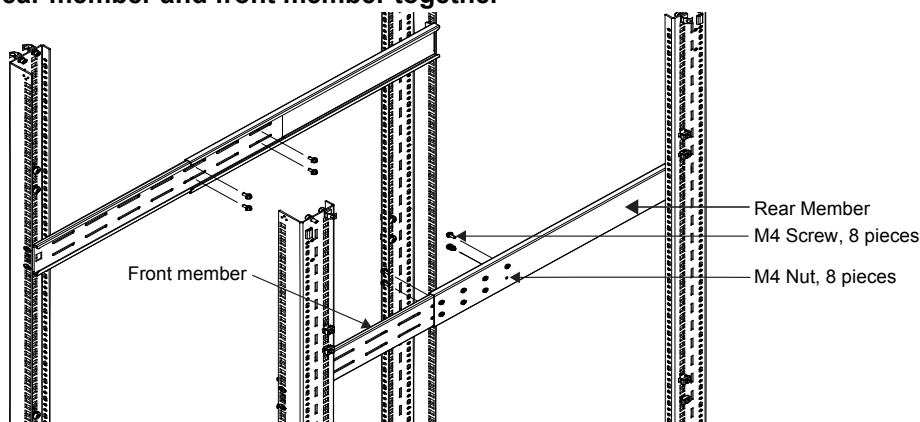

7. Fasten inner members pulled from the slide rail assemblies in **Step 2** to the UPS on both sides with eight M4 screws provided in this kit. Make sure that the retaining latch is near the rear of the UPS, as shown in **Figure 15**.

Figure 15 Installing inner members

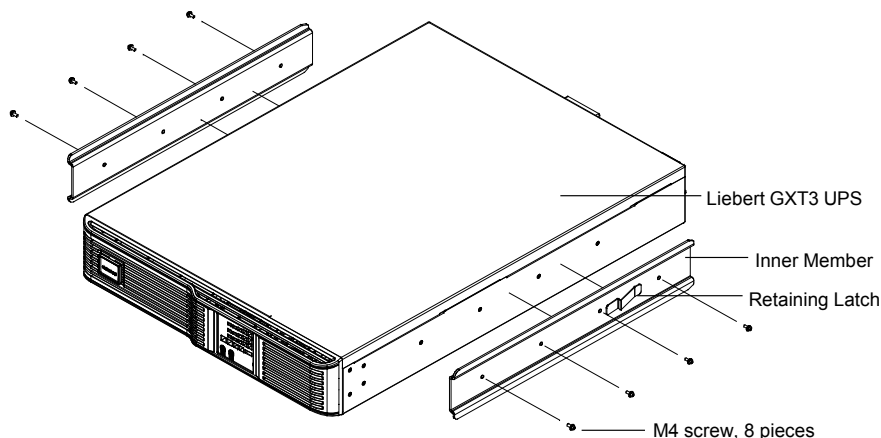

8. Use M4 screws to install ears of accessories on both sides of the UPS, as shown in **Figure 16**.

Figure 16 Installing rack-mount handles

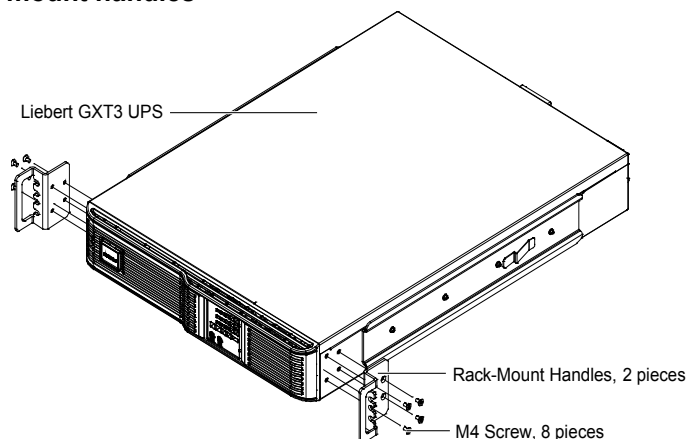

9. Insert the UPS, with inner members attached, into slide rail assemblies by inserting top and bottom edges of inner members into the top and bottom, curved tracks of front members and sliding the UPS into rack, as shown in **Figure 17**.

Figure 17 Insert the UPS

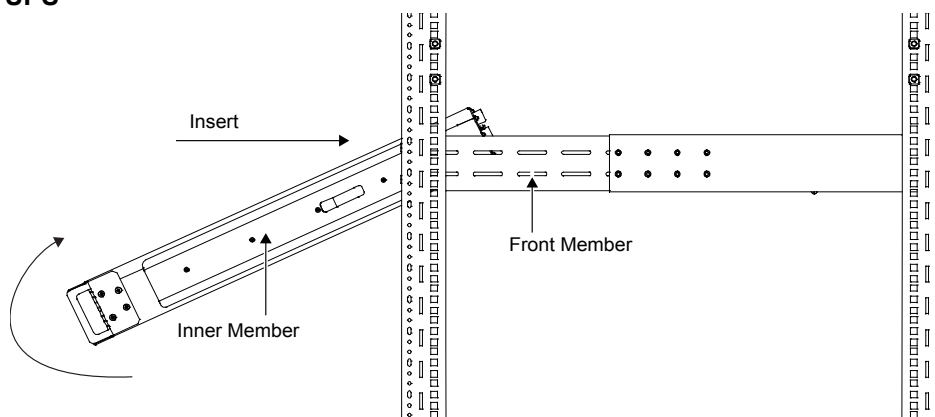
**NOTE**

Ends of inner members are tapered to allow rear of the UPS to be angled upward before insertion, if space allows.

*The UPS should move smoothly into slide rail assemblies. If not, recheck alignment of front and rear members from **Steps 4 through 6**.*

Factory-supplied rack handles are not intended to be used to lift the UPS. These are intended to be used to slide the UPS into and out of the rack.

10. Through the rack mount handles, use M5 screws provided in this kit to secure front of the UPS to rack EIA rails to prevent the UPS from sliding out of position.
11. If optional Liebert® external battery cabinets are connected to the UPS, they can be placed all on one side of the UPS or stacked beneath the UPS. The installation procedures are the same as those of the UPS.

2.5 Cable Connection

The Liebert® GXT3™ rear panel has an input cable and plug, output receptacles and output cable(s) (Output cables are on GXT3-3000 models only). Refer to **1.3.2 - Rear Panel Features** for details. The battery cables are supplied with the battery cabinet.

2.5.1 Connecting Input Plug and Loads



NOTE

Ensure that all the loads are turned Off.

Prepare an input power supply that is properly protected by a circuit breaker in accordance with national and local electrical codes. The wall receptacle must be grounded.

The plug on the power supply cord is intended to serve as the disconnect device. The socket-outlet must be installed near the equipment and must be easily accessible.

Emerson recommends installing an upstream circuit breaker of the same series as the Liebert GXT3's input circuit breaker.

The specification of input circuit breaker on the rear panel of UPS is given in **Table 2**.

Table 2 Input circuit breaker specification

Model	Rated Circuit Breaker
GXT3-500RT120	8A
GXT3-700RT120	10A
GXT3-1000RT120	15A
GXT3-1000MT120	15A
GXT3-1500RT120	15A
GXT3-2000RT120	20A
GXT3-3000RT120	30A
GXT3-3000RT208	20A

1. Plug all loads into the output receptacles on the rear panel of the Liebert GXT3.



NOTE

1. *Distribute loads evenly across all receptacles to prevent overloading individual receptacles.*
2. *Output cable length should not exceed 32.8 ft (10m).*

3. Insert the input plug of Liebert GXT3 into the input power connection.

2.5.2 Connecting Battery Cables

1. Switch Off the input breaker of the battery cabinet.
2. Take out the battery cable included with the battery cabinet.
3. Connect one end of the battery cable to the external battery connector on the rear panel of the UPS, and connect the other end to any battery port on the rear panel of the battery cabinet.
4. Switch On the battery breaker on the rear of the external battery cabinet.
5. Use the Configuration Program included with the UPS to specify the number of external battery cabinets connected to the Liebert GXT3. See **Table 15** for approximate battery run times.

2.6 Connecting Communication Cables

Communication cable connection includes: USB and cables for option cards.

2.6.1 Connecting USB Communication Cables

1. Take the USB communication cables out of the accessories box.
2. Insert one end of the USB communication cable to the USB port on the rear panel of the Liebert® GXT3™ (see **Figures 3** and **5**).
3. Insert the other end of the USB communication cable to the USB port of the computer.

2.6.2 Installing the Optional Liebert IntelliSlot® Card and Communication Cables

1. Remove the protective cover of the Liebert IntelliSlot port on the Liebert GXT3 and set it aside.
2. Insert the Liebert IntelliSlot card into the Liebert IntelliSlot port and secure it with screws.
3. To connect any cable associated with a Liebert IntelliSlot card, refer to the user manual provided with the card.

To configure and use the Liebert IntelliSlot communication card, refer to the card's user manual. Manuals for the various Liebert IntelliSlot cards are available at Liebert's Web site:

www.liebert.com

3.0 CONTROLS AND INDICATORS

The operation and display panel, shown in **Figure 18**, is on the front panel of the Liebert® GXT3™ (see **Figures 1** and **2**).

Figure 18 Operation and display panel

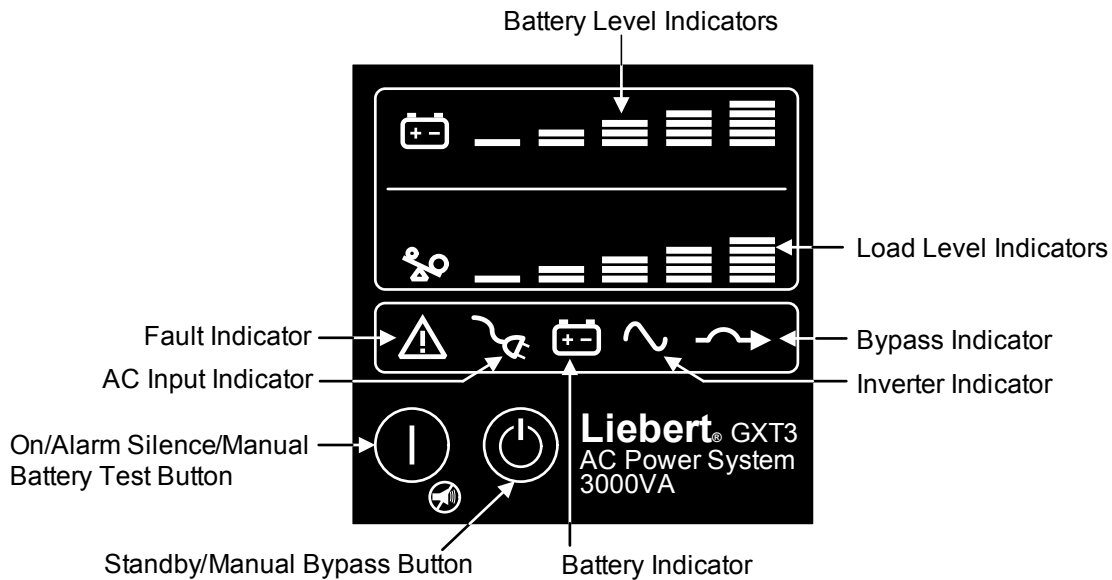

3.1 Control Buttons

The operation and display panel has two control buttons: On/Alarm Silence/Manual Battery Test and Standby/Manual bypass.

3.1.1 On/Alarm Silence/Manual Battery Test Button

The On/Alarm Silence/Manual Battery Test button controls output power to connected load(s) and has three functions (see **Table 3**).

Table 3 Functions of On/Alarm Silence/Manual battery test button

Function	Operation	Description
ON	Press the button once for 3 seconds	To start the UPS
Alarm Silence ¹	Press the button for at least half a second	To silence alarms ²
Manual Battery Test	Press the button for at least half a second while operating in Utility (AC) Mode with no alarms present.	To initiate a manual battery test

1. The low battery and bypass reminder alarms cannot be silenced.

2. After the alarm is silenced, UPS will reactivate the alarm system to alert of additional problems

3.1.2 Standby/Manual Bypass Button

The Standby/Manual Bypass button controls output power to connected load(s) and has two functions (see **Table 4**).

Table 4 Functions of Standby/Manual Bypass button

Function	Operation	Description
Manual Bypass	Press the button once and hold it for about 2 seconds ¹	To initiate a manual transfer of the connected loads to the internal bypass, if available
Standby	Press the button twice within four seconds while the UPS is in Manual Bypass or Battery Mode ²	To shut down the UPS and shut Off all power to the connected loads

1. If the bypass is not available due to voltage or frequency, pressing this button once will be ignored.

2. Perform all necessary shutdown procedures on connected loads before turning Off the Liebert GXT3.

3.2 Indicators

The operation and display panel has seven indicators (see **Figure 18**). The indicators can be divided into two groups according to the applications: level indicators and UPS status indicators.

3.2.1 Level Indicators

Battery Level Indicators

The battery level indicator is composed of five sets of LED bars that illuminate and flash to indicate the battery capacity level. The Liebert® GXT3™ battery capacity level is shown in 20% increments (±5%). The battery level indicators will illuminate as shown in **Figure 19**.

Figure 19 Battery level indicators

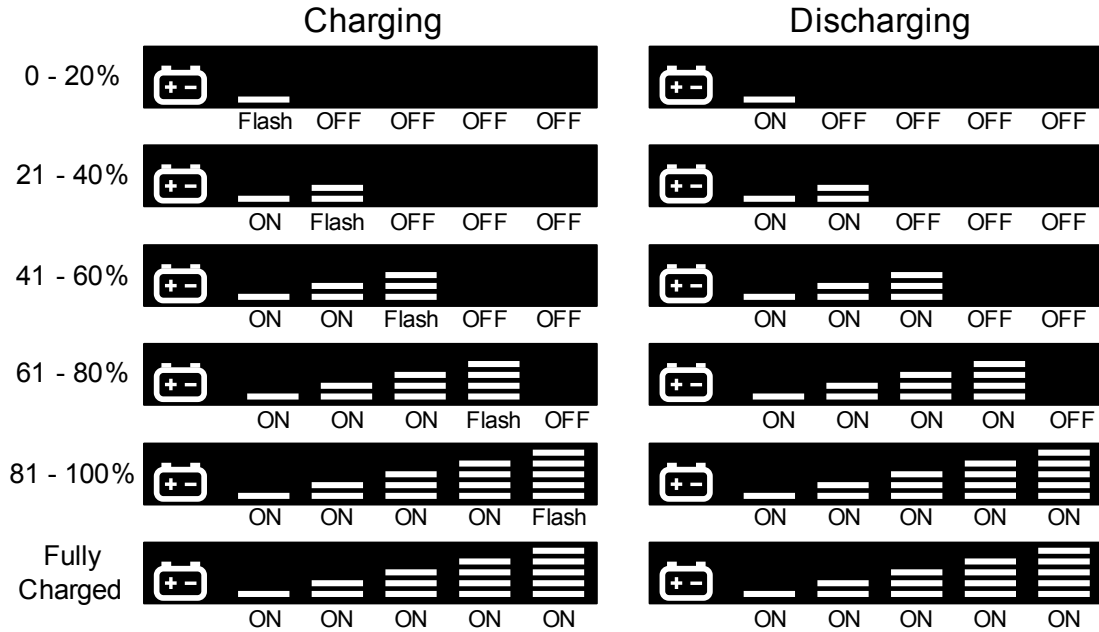

Load Level Indicators

The load level indicator is composed of five LED bars that illuminate to indicate the relative load on the UPS output in 25% increments (± 5%). The load level indicator will illuminate as shown in **Figure 20**.



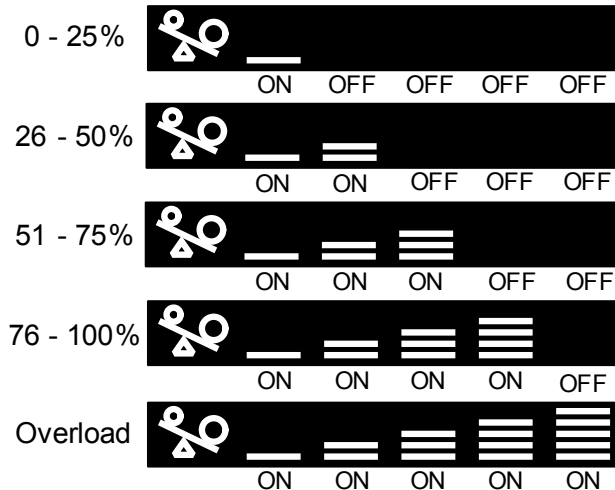

Figure 20 Load level indicators



3.2.2 UPS Status Indicators

UPS status is indicated by five symbols: fault indicator, AC input indicator, battery indicator, inverter indicator and bypass indicator. **Table 5** shows the symbols and their meaning.

Table 5 UPS status indicators

UPS Status Indicator	Icon	Color	Description
Fault Indicator		Red	On if the UPS has detected a fault; Off if there is no fault
AC Input Indicator		Green	On when the utility input power is normal; Off during utility failure; flashing when utility power is outside specifications
Battery Indicator		Amber	On when the battery is supplying power; Off when the battery is not supplying power
Inverter Indicator		Green	On when the inverter is supplying power; Off when the inverter is not supplying power
Bypass Indicator		Amber	On when the bypass is supplying power; Off when the inverter is not supplying power; and flashing when utility power is outside specifications

4.0 OPERATION

This section describes checks to be made before starting the UPS, how to start the UPS, manual battery test, manual bypass, shutting down the UPS and disconnecting the utility power from the UPS.



NOTE

The Liebert® GXT3™'s battery has been fully charged before delivery, but some charge will be lost during storage and shipping. To ensure that the battery has adequate reserve power to protect the connected load, charge the battery for three hours before putting the UPS into service.

4.1 Startup Checklist for the Liebert GXT3

Before starting the UPS, perform these checks:

- ___ 1. Check that the input plugs and loads are connected properly and reliably.
- ___ 2. Check that all of the battery cables are connected properly.
- ___ 3. Check that the communication cables are connected properly.

4.2 Starting the UPS

1. Turn On the input circuit breaker—see **Figures 3** and **5** for its location.
2. Turn On the UPS by pressing the On/Alarm Silence/Manual Battery Test button for three seconds.
After the button is pressed, the LEDs on the display will signal that the unit has initiated the startup process.
3. Once the inverter LED has been illuminated, turn On the connected loads.
4. Check the status indicators to determine whether the Liebert GXT3 is operating normally.
5. Check the load level indicators to verify that the connected load does not exceed the UPS' rated capacity.

The UPS is now providing conditioned power to the load.

4.3 Manual Battery Test

To initiate a manual battery test, press the On/Alarm Silence/Manual Battery Test button for at least half a second while operating from utility power with no alarm conditions present.

- If only first two of the five LED segments illuminate, allow the UPS to recharge the batteries for 24 hours.
- Retest the batteries after 24 hours of charging the batteries.
- After the batteries have been retested, if only two of the five Battery LEDs illuminate, contact your local Emerson representative or Emerson Channel Support.
- If none of the five Battery LEDs illuminate during a manual battery test, check the battery connection and allow the UPS to recharge the batteries for 1 hour and initiate a manual battery test again.
- If none of the five Battery LEDs illuminate during the manual battery test a second time, replace the batteries, and contact your local Emerson representative or Emerson Channel Support.

4.4 Manual Bypass

Press the Standby/Manual Bypass button once while the UPS is in utility (AC) mode and hold it for about 2 seconds. The UPS will transfer the connected loads to the internal bypass. If the internal bypass is not available due to utility power problems, pressing this button once will be ignored. Bypass operation is indicated by an audible alarm and illuminated amber Bypass indicator. If other indicators are illuminated, refer to **7.0 - Troubleshooting**.

4.5 Shut Down the Liebert® GXT3™

1. Transfer the UPS to manual bypass by pressing the Standby/Manual Bypass button and holding it for about 2 seconds.
If manual bypass is not available, disregard the first step.
2. Press the Standby/Manual Bypass button twice within four seconds to shut down the UPS. The UPS will shut down about 30 seconds after the button is pressed.

Power to the connected loads is now Off.

4.6 Disconnecting Input Power from the Liebert GXT3

1. Once the UPS has been shut down as detailed in **4.5 - Shut Down the Liebert® GXT3™**, disconnect the input cable plug.
2. Wait 30 seconds and verify that all indicators have turned Off and the fan has stopped; this indicates that the power-off is complete.
3. Turn the external battery cabinet breaker switch to the Off position if the UPS has an external battery cabinet.

After powering Off the UPS, the UPS ceases output and the load is powered Off.

5.0 COMMUNICATION

This section describes UPS communication over the three types of communication connections on the rear of the Liebert® GXT3™:

- Liebert IntelliSlot® port
- USB port (standard B-type)
- Terminal Block Communication



CAUTION

To maintain safety (SELV) barriers and for electromagnetic compatibility, signal cables should be segregated and run separate from all other power cables.

5.1 Liebert IntelliSlot Communication Cards

The Liebert IntelliSlot port accepts three optional cards:

- Liebert IntelliSlot SNMP Card
- Liebert IntelliSlot Relay Card
- Liebert IntelliSlot 485 Card.

The Liebert IntelliSlot SNMP Card provides SNMP monitoring and control of the UPS across the network.

The Liebert IntelliSlot Relay Card provides dry contact relay outputs for custom-wired applications and delivers support for built-in shutdown for AS/400 systems.

The Liebert IntelliSlot 485 Card is used to connect the UPS and computer system.

Follow instructions provided with the Liebert IntelliSlot card to configure Liebert MultiLink®, the UPS or any additional ancillary product for the Liebert GXT3. These instructions are available at

multilink.liebert.com

5.1.1 Liebert MultiLink

Liebert MultiLink monitors the UPS continuously and can shut down your computer or server in the event of an extended power failure. Liebert MultiLink can also be configured to shut down the UPS.

Liebert's MultiLink can also be configured for use without the USB cable when the Liebert IntelliSlot SNMP Card or Liebert IntelliSlot Web Card is installed in the UPS. An optional Liebert MultiLink License Kit permits shutting down the UPS over a network.

For more information about the Liebert IntelliSlot SNMP Card, Liebert IntelliSlot Web Card and Liebert MultiLink license kits, visit the Liebert Web site (www.liebert.com) or contact your local Emerson representative.

5.2 USB Port Communication

The standard B-type USB port is used to connect the UPS and network server or other computer system using Liebert® MultiLink®. Configuration program can be accessed through the communication port.

5.2.1 Configuration Program

Accessing the Configuration Program via USB is a new feature of the Liebert GXT3™. For most users, the factory default settings will be adequate. This section illustrates the features available for modification, as well as the factory default setting.

The USB configuration program allows these features of the Liebert GXT3 to be changed:

- Enable/Disable Auto-Restart
- Select frequency converter operation with a fixed output frequency of 50Hz or 60Hz, bypass disabled
- Set the Low Battery Warning alarm time from 2 to 30 minutes
- Enable/Disable the Auto-Battery test
- Enable/Disable Auto-Restart after removing Remote Shutdown
- Set the wiring mode of Remote Shutdown
- Set the Auto-Enable output
- Set the Auto-Battery test to 7, 14, 21 or 28 days
- Select the number of external battery cabinets connected to the UPS to adjust the remaining run time calculated by Liebert software products
- Select one of multiple output voltages to match various voltages, see **Table 6**.

Table 6 Output voltage option

UPS Model	Factory Default, VAC	Output Voltage Option, VAC
GXT3-500RT120 - GXT3-3000RT120 GXT3-1000MT120	120	110, 115, 120 and 127
GXT3-3000RT208	208	208 / 220 / 230 / 240

NOTICE

The output voltage settings cannot be changed while the UPS is On and powering connected loads.



NOTE

*For all 120V models, when the output voltage is programmed for 110VAC, the UPS will be automatically derated as follows (refer to 9.0 - **Specifications** for VA and watt ratings):*

- 500VA - 1000VA: derated to 95% of both the VA and Watt ratings
- 1500VA - 3000VA: derated to 90% of both the VA and Watt ratings



NOTE

- *This program is compatible with UPS models beginning with 'GXT3', as in 'GXT3-3000RT120.' It is not compatible with earlier versions of the Liebert GXT UPS.*
- *A computer running Windows 2000®, XP® or Vista® is required to set up and run the configuration program.*

5.3 Terminal Block Communication

The Terminal Block includes eight pins, as shown in **Figure 21**.

Figure 21 Terminal block communication pin layout

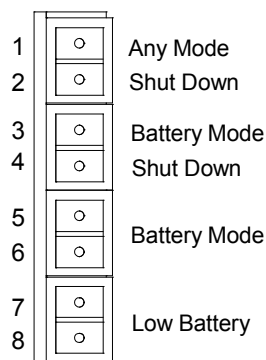

5.3.1 Any-Mode Shutdown

The purpose of Any Mode Shutdown is to shut down the UPS output by turning Off the rectifier, inverter and bypass so that there is no power to the loads.

Any Mode Shutdown can be operated locally and remotely, as described as follows:

- Local Any Mode Shutdown can be performed by shorting Pin1 and Pin2,
- Remote Any Mode Shutdown can be performed by a switch connected to Pin1 and Pin2 and mounted at a remote location.



NOTE

Remote Power Off will be performed either by NO or NC contact of Any Mode Shutdown, depending on the settings in the configuration program.

A current-limited source for this optocoupler (+12VDC, 50mA) will be available from the UPS.

The connection to the UPS for remote connection will be via terminal block connector.

Any Mode Shutdown wiring must conform to all national, regional and local wiring regulations.



WARNING

When the Auto-Enable output option is selected and the UPS output is disabled using Pin 1 and Pin 2, the Liebert® GXT3™'s output can turn On automatically and without warning if the Pin 1 and Pin 2 connection is changed.

5.3.2 Battery Mode Shutdown

Battery Mode Shutdown permits shutting down the UPS by turning Off the rectifier, inverter and bypass so that there is no power to the load when the UPS is On Battery.

Battery Mode Shutdown can be performed locally or remotely:

- Local Any Mode Shutdown can be performed by shorting Pin 3 and Pin 4
- Remote Any Mode Shutdown can be achieved by a switch connected to Pin 3 and Pin 4 and mounted at a remote location.



NOTE

Remote Power Off will be performed by NO contact.

A current-limited source for this optocoupler (+12VDC, 50mA) will be available from UPS.

The connection to the Liebert® GXT3™ for remote connection will be via terminal block connector.

Battery mode shutdown wiring must conform to all national, regional and local wiring regulations.

This signal must last for 1.5 seconds or longer.

A battery shutdown signal will not cause an immediate shutdown. It will start a 2 minute shut down timer. This timer cannot be stopped once triggered. If utility power returns during this countdown, the Liebert GXT3 will still shut down and must remain shut down for 10 seconds.

Whether the UPS turns back On when the power is restored depends on the auto-restart setting.

5.3.3 On Battery

On Battery signal is a Normally Open (NO) dry contact. When the UPS is supplying output power from the battery this dry contact will be closed.

5.3.4 Low Battery

Low Battery signal is a Normally Open (NO) dry contact. When the UPS is supplying output power from the battery and has reached the Low Battery Warning time selected in the configuration program, this dry contact will be closed.



NOTE

The rated values for the dry contacts for the On Battery and Low Battery signals are:

- *Rated Voltage: 30V (AC or DC)*
- *Rated Current: 300mA*

6.0 MAINTENANCE

This section describes replacing the internal battery pack, precautions, checking the Liebert® GXT3's status and checking UPS functions.



WARNING

The battery can present a risk of electrical shock and high short circuit current. The following precautions should be observed before replacing the battery pack:

- Remove rings, watches and other metal objects.
- Use tools with insulated handles.
- Do not lay tools or other metal objects on the batteries.
- If the battery kit is damaged in any way or shows signs of leakage, contact your local Emerson representative immediately.
- Do not dispose of batteries in a fire. The batteries may explode.
- Handle, transport and recycle batteries in accordance with local regulations.

6.1 Replacing the Internal Battery Pack

The Liebert® GXT3™ is designed to allow the user to replace the internal battery pack safely. Refer to **Table 7** for internal battery pack part numbers for Liebert GXT3™ UPS:

Table 7 Replacement internal battery pack model number

UPS Model Number	Replacement Internal Battery Pack Model Number	Quantity Required
Liebert GXT3-500RT120	GXT3-5A48BATKIT	1
Liebert GXT3-700RT120	GXT3-5A48BATKIT	1
Liebert GXT3-1000RT120	GXT3-5A48BATKIT	1
Liebert GXT3-1000MT120	GXT3-1MTBATKIT	1
Liebert GXT3-1500RT120	GXT3-7A48BATKIT	1
Liebert GXT3-2000RT120	GXT3-9A48BATKIT	1
Liebert GXT3-3000RT120	GXT3-9A72BATKIT	1
Liebert GXT3-3000RT208	GXT3-9A72BATKIT	1

Read all safety cautions before proceeding. Contact your local dealer or Emerson representative to obtain the part number and pricing of the appropriate replacement battery pack.



CAUTION

Risk of explosion if battery is replaced by an incorrect type. Dispose of used batteries according to the instructions.

6.1.1 Battery Replacement Procedures

1. Remove the front plastic bezel cover from the UPS.
2. Loosen and remove the six screws on the battery door, as shown in **Figure 22**.
3. Lay the battery door and screws aside for reassembly.

Figure 22 Removing the front bezel cover and battery door



4. Gently pull the battery wire out and disconnect the battery plug and battery receptacle, as shown in Figure 23.

Figure 23 Disconnecting the battery plug and battery receptacle (front view)

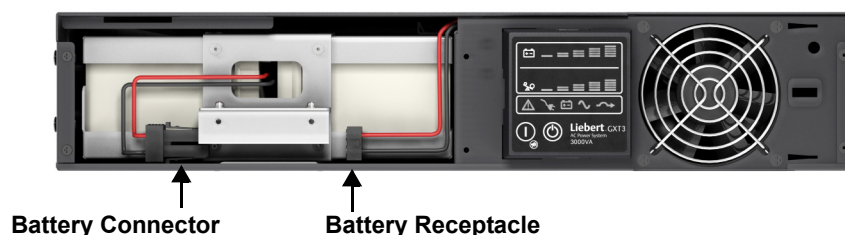

5. Grasp the battery handle, and pull the internal battery pack out of the UPS, as shown in Figure 24.

Figure 24 Pull out the battery



6. Unpack the new internal battery pack. Take care not to destroy the packing. Compare the new and old internal battery pack to make sure they are the same type and model. If so, proceed with **Step 7**; if they are different, stop and contact your local Emerson representative, or Emerson Channel Support.
7. Line up and slide in the new internal battery pack.
8. Reconnect the battery plug and battery receptacle
9. Push the battery wire and internal battery pack back into the UPS.
10. Reattach the front battery door with the six screws.
11. Reattach the front plastic bezel cover to the UPS.

**NOTE**

The internal battery pack is hot-swappable. However, caution should be exercised because during this procedure the load is unprotected from disturbances and power outages. Do not replace the battery while the UPS is operating in Battery Mode. This will result in a loss of output power and will drop the connected load.

6.2 Battery Charging

The batteries are valve-regulated, nonspillable, lead acid and should be kept charged to attain their design life. The Liebert® GXT3™ charges the batteries continuously when it is connected to the utility input power.

If the Liebert GXT3 will be stored for a long time, Emerson recommends connecting the UPS to input power for at least 24 hours every four to six months to ensure full recharge of the batteries.

6.3 Precautions

Although the Liebert GXT3 has been designed and manufactured to ensure personal safety, improper use can result in electrical shock or fire. To ensure safety, observe the following precautions:

- Turn Off and unplug the Liebert GXT3 before cleaning it.
- Clean the UPS with a dry cloth. Do not use liquid or aerosol cleaners.
- Never block or insert any objects into the ventilation holes or other openings of the Liebert GXT3.
- Do not place the Liebert GXT3 power cord where it might be damaged.

6.4 Checking UPS Status

Emerson recommends checking the UPS operation status every six months.

- Check if the UPS is faulty: Is the Fault Indicator On? Is the UPS sounding an alarm?
- Check if the UPS is operating in Bypass mode: Normally, the UPS operates in Normal Mode; if it is operating in Bypass Mode, stop and contact your local Emerson representative or Emerson Channel Support.
- Check if the battery is discharging: When the utility input is normal, the battery should not discharge. If the UPS is operating in Battery Mode, stop and contact your local Emerson representative or Emerson Channel Support.

6.5 Checking UPS Functions



NOTE

UPS function check procedures may interrupt power supply to the connected load.

Emerson recommends checking the UPS functions once every six months.

Back up the load data before conducting the UPS functions check. Procedures are as follows:

1. Press the Standby/Manual Bypass button to check whether the alarm and indicators are normal.
2. Press the On/Alarm Silence/Manual Battery Test button to check again whether the indicators are On and the UPS is operating normally.
3. Press the On/Alarm Silence/Manual Battery Test button for three seconds after Inverter Mode; the UPS should initiate battery self-test. Check to determine whether the battery is operating normally. If not, stop and contact your local Emerson representative or Emerson Channel Support.

7.0 TROUBLESHOOTING

This section indicates various UPS symptoms a user may encounter and troubleshooting steps in the event the UPS develops a problem. Use the following information to determine whether external factors caused the problem and how to remedy the situation.

7.1 UPS Symptoms

The following symptoms indicate the Liebert® GXT3™ has malfunctions.

- The related indicators will illuminate, indicating the UPS detected a problem.
- An alarm will sound, indicating that the UPS requires attention.

7.1.1 Indicators

In addition to the fault indicator being illuminated, one or more of LED segments of battery level indicator will also be illuminated to provide a diagnostic aid to the user, as shown in **Figure 25**. The descriptions are listed in **Table 8**.

Figure 25 Battery level indicator



Table 8 Indicator descriptions

Indicator	Diagnosis/Audible alarm
A - E	On bypass from output overload (half-second beep every half-second)
A	On bypass due to overtemperature condition (1-second beep every 4 seconds)
B	On bypass due to DC bus overvoltage (1-second beep every 4 seconds)
C	On bypass due to DC/DC power supply failure (1-second beep every 4 seconds)
D	On bypass due to PFC failure (1-second beep every 4 seconds)
E	On bypass due to inverter failure (1-second beep every 4 seconds)
A&B	UPS Failure (includes dual-fan failure, single-fan failure under certain conditions and battery charger failure) and continuous alarm
A&C	UPS failed battery test (2-second beep every 60 seconds)
A&E	Bypass feedback (1-second beep every 4 seconds)
B&E	Short circuit on the output
C&E	UPS shutdown by command from communication (USB port or Liebert IntelliSlot™ port) (no audible)
Utility LED flash	L-N reverse
Battery Indicator Flashing	Battery not connected (continuous horn); check battery connection, power down and restart UPS
Bypass Indicator Flashing	Utility power voltage or frequency is out of tolerance; bypass is unavailable

Indicators A - E are shown in **Figure 25**.

If the UPS experiences an overload, the UPS will transfer from bypass back to inverter approximately 5 minutes after the overload ends.

7.1.2 Audible Alarm

An audible alarm will be used in conjunction with the visual indicators to indicate to the user a change in UPS operating status. The audible alarm will enunciate as given in **Table 9**.

Table 9 Audible alarm description

Condition	Alarm
Battery discharge	half-second beep every 10 seconds
Low battery	Two half-second beeps every 5 seconds
UPS fault, load on bypass	1-second beep every 4 seconds
UPS fault, no power to load	Continuous
Overload	half-second beep every half second
Battery replacement	2-second beep every 60 seconds
Battery loss	Continuous
Wiring problem (including line-to-neutral reversal or a loss of proper grounding for UPS)	Continuous
Bypass reminder	1-second beep every 2 minutes

7.2 Troubleshooting

In the event of an issue with the UPS, refer to **Table 10** to determine the cause and solution. If the issue persists, contact Emerson Channel Support.

Table 10 Troubleshooting

Problem	Cause	Solution
UPS fails to start when the On/Alarm Silence/Manual Battery Test button is pressed	UPS is short-circuited or overloaded	Ensure UPS is Off. Disconnect all loads and ensure nothing is lodged in output receptacles. Ensure loads are not defective or shorted internally.
Battery indicator is illuminated	UPS not plugged in	UPS is operating from battery mode, ensure UPS is securely plugged into the wall receptacle.
	UPS input protection circuit breaker has opened	UPS is operating from battery mode. Save data and close applications. Reset UPS input breaker, then restart UPS.
	Utility power is out of tolerance	UPS is operating from battery mode. Save data and close applications. Ensure utility supply voltage is within acceptable limits for UPS.
UPS has reduced battery backup time	Batteries are not fully charged	Keep UPS plugged in continuously at least 24 hours to recharge batteries.
	UPS is overloaded	Check load level indicator and reduce the load on the UPS.
	Batteries may not be able to hold a full charge due to age	Replace batteries. Contact your local dealer, Emerson representative or Emerson Channel Support for replacement battery kit.
Fault and Bypass indicators and all LED segments of battery level indicator are illuminated	UPS overloaded or load is faulty	Check load level indicator and remove non-essential loads. Recalculate the load and reduce number of loads connected to UPS. Check load for faults.
Fault and Bypass indicators and diagnostic A indicator are illuminated	UPS shutdown due to overtemperature condition. Load is on bypass power	Ensure UPS is not overloaded, ventilation holes not blocked, or room ambient temperature is not excessive. Wait 30 minutes to allow UPS to cool, then restart UPS. If UPS will not restart, contact your local dealer, Emerson representative or Emerson Channel Support.

Table 10 Troubleshooting (continued)

Problem	Cause	Solution
Fault and Bypass indicators and diagnostic B indicator are illuminated	UPS internal DC bus overvoltage	UPS requires service. Contact Emerson Channel Support.
Fault and Bypass indicators and diagnostic C indicator are illuminated	UPS DC/DC fault	UPS requires service. Contact Emerson Channel Support
Fault indicator and diagnostic D indicator are illuminated	UPS PFC (Power Factor Correction Circuit) fault	UPS requires service. Contact Emerson Channel Support
Fault and Bypass indicators and diagnostic E indicator are illuminated	UPS inverter fault	UPS requires service. Contact Emerson Channel Support
Fault indicator and diagnostic A and C indicators are illuminated	UPS failed the battery test	Replace batteries. Contact your local dealer, Emerson representative or Emerson Channel Support
Fault and Bypass indicators and diagnostic C and E indicators are illuminated	UPS shut down by a command from the communications port(s)	Your UPS has received a signal or command from the attached computer. If this was inadvertent, ensure the communication cable used is correct for your system. For assistance, contact your local dealer, Emerson representative or Emerson Channel Support
Fault indicator and diagnostic A and B indicators are illuminated	UPS Failure (Includes Dual Fan failure, single fan failure under certain condition and Battery Charger Failure) and continuous alarm	Ensure fan is not blocked. If the fault is not removed, contact your local dealer, Emerson representative or Emerson Channel Support
AC input indicator is flashing	UPS detected a line-to-neutral reversal or a loss of proper grounding for UPS; continuous alarm and UPS will not start in standby status. This is active only when power is first applied to the input. Once the UPS is running, the AC input indicator will flash, unless the input wiring is correctly changed	Contact a qualified electrician to verify site wiring
Battery indicator is flashing	Battery source is not available; continuous alarm	Check battery connections, completely power down and restart UPS. NOTE: If the battery circuit opens while the UPS is running, it will be detected when the next battery test is performed
Bypass indicator is flashing	Because the voltage or frequency is outside acceptable limits, the bypass is disabled	The AC input powers the PFC input and serves as the bypass source. If the AC is present but the voltage or frequency exceeds the acceptable range for safe operation with a load, the bypass will be disabled and this indicator will flash, indicating that the bypass is unavailable

When reporting a UPS issue to Emerson, include the UPS model and serial number. These are on the top panel of the Liebert® GXT3™.

8.0 BATTERY CABINET

Optional battery cabinets are available for the Liebert® GXT3™. The battery connectors and input breaker are on the battery cabinet's rear panel, as shown in **Figure 26**. For battery cabinet specifications, refer to **Table 13**. The Liebert GXT3 may be equipped with a maximum of four extension battery packs.

For battery run times, refer to **Table 15**.

Figure 26 Battery cabinet

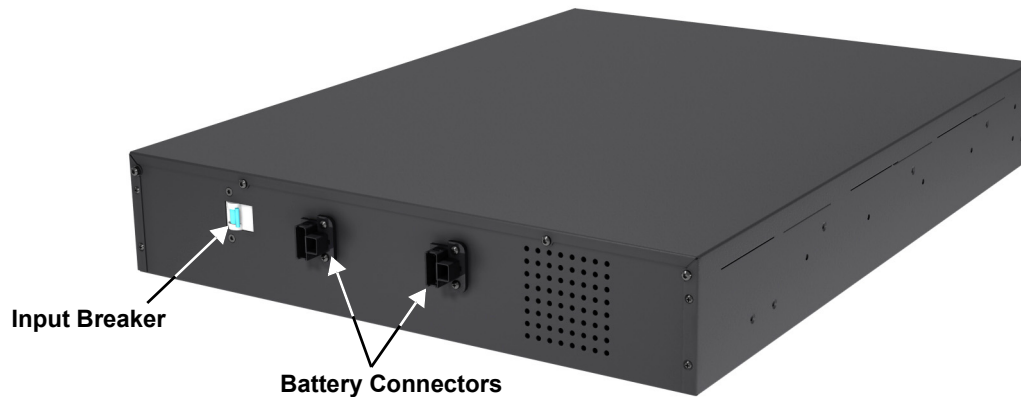

WARNING

Do not contact the battery connectors and ground without wearing protective gloves and clothing and taking other precautions against electrical shock. The battery loop and AC input are not insulated, which may cause a dangerous voltage between the battery connectors and ground.



NOTE

External Battery Connectors are wired in parallel. Either connector can be connected to the UPS or to another battery cabinet.

9.0 SPECIFICATIONS

Table 11 Specifications of GXT3-500RT120 - GXT3-1000RT120 and GXT3-1000MT120 UPS

Parameters	Product Model			
	GXT3-500RT120 (500VA/450W)	GXT3-700RT120 (700VA/630W)	GXT3-1000RT120 (1000VA/900W)	GXT3-1000MT120 (1000VA/900W)
Dimensions, D × W × H, in. (mm)				
Unit	19.7 × 16.9 × 3.4 (497 × 430 × 85)			15.4 × 6.9 × 8.9 (390 × 175 × 225)
Shipping	25.5 × 23.9 × 10.6 (647 × 607 × 270)			22.1 × 12.9 × 14 (562 × 327 × 355)
Weight, lb (kg)				
Unit	37 (16.8)			37.5 (17)
Shipping	44.1 (20)			36 (16.5)
Input AC				
Voltage Range (typical)	120VAC nominal; variable based on output load			
90% ~ 100% loading	90VAC/140VAC			
70% ~ 90% loading	86VAC/140VAC			
30% ~ 70% loading	77VAC/140VAC			
0 ~ 30% loading	60VAC/140VAC			
Frequency	40Hz ~ 70Hz; Auto Sensing			
Input Power Cord	10 ft. attached w/ NEMA 5-15P plug			
Output AC				
Output Receptacles	5-15R × 6			
Voltage	110/115/120VAC (user-configurable); ±3%			
Waveform	Sine wave			
Utility (AC) Mode Overload	200% for 2 seconds; 150% for 50 seconds with transfer to bypass			
Battery				
Type	Valve-regulated, nonspillable, lead acid			
Qty × V × Rating	4 × 12V × 5.0Ah			
Battery Mfr./Part #	YUASA/NPH5-12; CSB/ HR 1221W; CSB/GP1245			
Backup Time	See Table 15			
Recharge Time	3 Hours to 90% capacity after full discharge with 100% load till UPS auto-shutdown (Internal Batteries Only)			
Environmental Requirements				
Operating Temperature, °F (°C)	32 to 104 (0 to 40); see Table 14 - Operating temperature parameters			
Storage Temperature, °F (°C)	5°F to 122°F (-15°C to 50°C)			
Relative Humidity	0% to 95%, non-condensing			
Operating Elevation	Up to 10,000 ft. (3000m) at 77°F (25°C) without derating			
Storage Elevation	50,000 ft. (15000m) maximum			
Audible Noise	<43dBA max @ 3ft. (1m) front and sides <46dBA max @ 3ft. (1m) rear		< 50 dBA, at 3ft. (1m) rear < 45 dBA, at 3ft. (1m) front and sides	
Agency				
Safety	UL 1778, cUL Listed			
RFI/EMI	FCC Part 15, Class A=CISPR22 Class B			
Surge Immunity	IEC 62040-2 2nd Ed			
Transportation	ISTA Procedure 1A			

Table 12 Specifications of GXT3-1500RT120 - GXT3-3000RT120 and GXT3-3000RT208 UPS

Parameters	Product Model			
	GXT3-1500RT120 (1500VA/1350W)	GXT3-2000RT120 (2000VA/1800W)	GXT3-3000RT120 (3000VA/2700W)	GXT3-3000RT208 (3000VA/2700W)
Dimensions, D × W × H, in. (mm)				
Unit	19.7 × 16.9 × 3.4 (497 × 430 × 85)		23.7 × 16.9 × 3.4 (602 × 430 × 85)	
Shipping	25.5 × 23.9 × 10.6 (647 × 607 × 270)		29.4 × 23.4 × 10.6 (747 × 607 × 270)	
Weight, lb. (kg)				
Unit	51.1 (23.2)	56.1 (25.5)	71.4 (32.4)	
Shipping	57.3 (26)	61.7 (28)	77 (35)	
Input AC				
Voltage Range (typical)	120VAC nominal; variable based on output load		208VAC nominal; variable based on output load	
90 - 100% loading	102VAC/140VAC		177VAC/280VAC	
70 - 90% loading	96VAC/140VAC		168VAC/280VAC	
30 - 70% loading	84VAC/140VAC		150VAC/280VAC	
0 - 30% loading	60VAC/140VAC		115VAC/280VAC	
Frequency	40 - 70Hz; Auto Sensing			
Input Power Cord	10 ft. attached w/ NEMA 5-15P plug	10 ft. attached w/ NEMA 5-20P plug	10 ft. attached w/ NEMA L5-30P plug	10 ft. attached w/ NEMA L6-20P plug
Output AC				
Output Receptacles	5-15R × 6	5-20R × 6	L5-30R×1+5-20R×6	L6-20R×1+L6-15R×2
Voltage	110/115/120VAC (user-configurable); ±3%			208/220/230/240 VAC (user-configurable); ±3%
Waveform	Sine wave			
Utility (AC) Mode Overload	200% for 2 seconds 150% for 50 seconds		200% for 2 seconds 150% for 10 seconds	
Battery				
Type	Valve-regulated, nonspillable, lead acid			
Qty×V×Rating	4 × 12V × 7.2Ah	4 × 12V × 9.0Ah	6 × 12V × 9.0Ah	6 × 12V × 9.0Ah
Battery Mfr./Part #	Panasonic/UP-RW1236 CSB/GP 1272	Panasonic/UP- RW1245; CSB/HR 1234W F2		
Backup Time	See Table 15			
Recharge Time	3 Hours to 90% capacity after full discharge with 100% load till UPS auto-shutdown (Internal Batteries Only)			
Environmental				
Operating Temperature, °F (°C)	+32 to +104 (0 to 40); see Table 14 - Operating temperature parameters			
Storage Temperature, °F (°C)	5 to +122 (-15 to 50)			
Relative Humidity	0% to 95%, non-condensing			
Operating Elevation	Up to 10,000 ft. (3000m) at 77°F (25°C) without derating			
Storage Elevation	50,000 ft. (15000m) maximum			
Audible Noise	< 45dBA at 3ft (1m) rear < 46 dBA at 3ft. (1m) front and side	<48dBA max @ 3ft (1m) front and side <48dBA max @ 3ft. (1m) rear		
Agency				
Safety	UL 1778, c-UL Listed			
RFI/EMI	FCC Part 15, Class A=CISPR22 Class B			
Surge Immunity	IEC 62040-2 2nd Ed			
Transportation	ISTA Procedure 1A			

Table 13 Battery cabinet specifications

Parameter	Model Number	
	GXT3-48VBATT	GXT3-72VBATT
Used w/UPS Model	GXT3-500RT120,GXT3-700RT120 GXT3-1000RT120,GXT3-1500RT120, GXT3-2000RT120	GXT3-3000RT120 GXT3-3000RT208
Dimensions, D × W × H, in (mm)		
Unit	19.7 x 16.9 x 3.3 (497 x 430 x 85)	23.7 x 16.9 x 3.3 (602 x 430 x 85)
Shipping	24.3 x 22.4 x 10.3 (617 x 570 x 262)	28.2 x 22.4 x 10.3 (717 x 570 x 262)
Weight, lb (kg)		
Unit	57.3 (26)	83.8 (38)
Shipping	61.7 (28)	92.6 (42)
Battery parameters		
Type	Valve-regulated, nonspillable, lead acid	
Qty × V × Rating	2 × 4 × 12V × 9.0Ah	2 × 6 × 12V × 9.0Ah
Battery Mfr./Part #	Panasonic/UP-RW1245; CSB/HR 1234W F2	
Backup Time	See Table 15	
Environmental		
Operating Temperature, °F (°C)	32 to 104 (0 to 40)	
Storage Temperature, °F (°C)	19 to 122 (-15 to 50) High ambient temperatures will reduce battery life.	
Relative Humidity	0% to 95%, non-condensing	
Operating Elevation	Up to 10,000 ft. (3000m) at 104°F (40°C) without derating	
Storage Elevation	50,000 ft. (15000m) maximum	
Agency		
Safety	UL 1778, c-UL Listed	
RFI/EMI	FCC Part 15, Class A=CISPR22 Class B	
Surge Immunity	IEC 62040-2 2nd Ed	
Transportation	ISTA Procedure 1A	

Table 14 Operating temperature parameters

Ambient Temperature, °C (°F)	25-30 (77-86)	30-35 (86-95)	35 - 40 (95-104)
Maximum Output Power Factor Derating @ Maximum Load	100%-93%	93%-86%	86%-79%

Table 15 Battery run times

Number of Batteries/Cabinets	Load Percent of Capacity	120VAC RT Models						208 VAC RT Model
		500VA	700VA	1000VA	1500VA	2000VA	3000VA	3000VA
Internal Battery	10%	128	105	90	77	77	74	77
	20%	82	61	37	35	33	36	37
	30%	41	37	30	23	21	21	21
	40%	38	32	23	16	15	15	15
	50%	34	27	17	11	11	11	11
	60%	31	22	14	10	8	8	8
	70%	27	18	11	6	6	6	6
	80%	23	15	9	5	5	5	5
	90%	20	13	8	4	4	4	4
	100%	17	11	7	4	3	3	3
Internal Battery + 1 External Battery Cabinet	10%	328	306	212	199	183	166	183
	20%	209	182	151	133	124	121	123
	30%	166	149	123	97	80	79	79
	40%	152	130	100	72	41	53	53
	50%	139	109	80	41	38	46	45
	60%	125	98	68	38	34	39	38
	70%	109	81	41	35	30	31	31
	80%	100	72	39	32	25	26	26
	90%	92	63	37	27	21	21	22
	100%	79	41	35	23	17	18	18
Internal Battery + 2 External Battery Cabinets	10%	480	373	336	314	311	307	311
	20%	334	313	214	188	161	159	160
	30%	309	211	166	148	134	133	133
	40%	216	185	151	126	105	105	104
	50%	197	159	137	103	80	81	80
	60%	167	149	122	82	67	68	67
	70%	159	139	105	72	40	52	52
	80%	152	128	95	62	38	47	47
	90%	144	112	80	40	36	43	43
	100%	137	104	73	38	33	38	38
Internal Battery + 3 External Battery Cabinets	10%	480	480	480	341	335	332	335
	20%	401	341	321	227	206	203	205
	30%	338	318	218	185	157	157	157
	40%	322	224	191	154	139	139	138
	50%	306	205	162	139	120	120	113
	60%	219	186	152	123	99	100	100
	70%	205	163	141	105	80	81	81
	80%	191	155	131	93	70	71	71
	90%	167	148	120	79	60	62	62
	100%	162	140	106	71	40	51	51

Table 15 Battery run times (continued)

Number of Batteries/Cabinets	Load Percent of Capacity	120VAC RT Models						208 VAC RT Model
		500VA	700VA	1000VA	1500VA	2000VA	3000VA	3000VA
Internal Battery + 4 External Battery Cabinets	10%	480	480	480	480	480	346	480
	20%	480	480	339	317	304	301	303
	30%	398	337	315	216	188	187	187
	40%	340	321	220	183	156	156	155
	50%	328	304	199	157	141	142	141
	60%	316	217	167	145	126	127	126
	70%	304	202	159	133	107	108	108
	80%	221	186	151	120	95	97	97
	90%	210	164	143	105	79	81	81
	100%	199	158	134	96	71	73	73

Times in this table are approximate. They are based on new, fully charged batteries with 100% resistive loads and an ambient temperature of 77°F (25°C). To increase this time, turn Off non-essential loads (such as idle computers and monitors) or add optional external battery cabinets.

9.1 Product Warranty Registration

To register for warranty protection, visit the **Quick Links** section of the Liebert® Web site at:

<http://www.liebert.com>

Click on **Product Warranty Registration** and fill in the form.

If you have any questions, contact Emerson Channel Support at:

North America: 800-222-5877

Outside North America: 00-800-1155-4499

liebert.upstech@emerson.com

Ensuring The High Availability Of Mission-Critical Data And Applications.

Emerson Network Power, a business of Emerson (NYSE:EMR), is the global leader in enabling *Business-Critical Continuity™* from grid to chip for telecommunication networks, data centers, health care and industrial facilities. Emerson Network Power provides innovative solutions and expertise in areas including AC and DC power and precision cooling systems, embedded computing and power, integrated racks and enclosures, power switching and controls, infrastructure management, and connectivity. All solutions are supported globally by local Emerson Network Power service technicians. Liebert AC power, precision cooling and monitoring products and services from Emerson Network Power deliver Efficiency Without Compromise™ by helping customers optimize their data center infrastructure to reduce costs and deliver high availability.

While every precaution has been taken to ensure the accuracy and completeness of this literature, Liebert Corporation assumes no responsibility and disclaims all liability for damages resulting from use of this information or for any errors or omissions.

© 2010 Liebert Corporation

All rights reserved throughout the world. Specifications subject to change without notice.

® Liebert is a registered trademark of Liebert Corporation.

All names referred to are trademarks or registered trademarks of their respective owners.

SL-23180_REV3_04-12

Technical Support / Service

Web Site

www.liebert.com

Monitoring

liebert.monitoring@emerson.com

800-222-5877

Outside North America: +00800 1155 4499

Single-Phase UPS & Server Cabinets

liebert.upstech@emerson.com

800-222-5877

Outside North America: +00800 1155 4499

Three-Phase UPS & Power Systems

800-543-2378

Outside North America: 614-841-6598

Environmental Systems

800-543-2778

Outside the United States: 614-888-0246

Locations

United States

1050 Dearborn Drive

P.O. Box 29186

Columbus, OH 43229

Europe

Via Leonardo Da Vinci 8

Zona Industriale Tognana

35028 Piove Di Sacco (PD) Italy

+39 049 9719 111

Fax: +39 049 5841 257

Asia

29/F, The Orient Square Building

F. Ortigas Jr. Road, Ortigas Center

Pasig City 1605

Philippines

+63 2 687 6615

Fax: +63 2 730 9572

Emerson Network Power.

The global leader in enabling *Business-Critical Continuity™*

- | | | | |
|----------------|--|------------------------------|-------------------------------|
| ■ AC Power | ■ Embedded Computing | ■ Outside Plant | ■ Racks & Integrated Cabinets |
| ■ Connectivity | ■ Embedded Power | ■ Power Switching & Controls | ■ Services |
| ■ DC Power | ■ Infrastructure Management & Monitoring | ■ Precision Cooling | ■ Surge Protection |