

**Instruction Manual**

P/N 20001909, Rev. D

July 2006

# **ProLink<sup>®</sup> II Software for Micro Motion<sup>®</sup> Transmitters**

Installation and Use Manual





# Contents

|                  |   |          |
|------------------|---|----------|
| <b>Chapter 1</b> | <b>Before You Begin . . . . .</b>   | <b>1</b> |
| 1.1              | About this manual . . . . .   | 1        |
| 1.2              | About ProLink II software . . . . .   | 1        |
| 1.2.1            | Supported transmitters . . . . .  | 1        |
| 1.2.2            | Uses of ProLink II. . . . .   | 2        |
| 1.3              | ProLink II requirements . . . . .   | 2        |
| 1.3.1            | PC requirements . . . . .   | 2        |
| 1.3.2            | Installation kits . . . . .   | 2        |
| 1.4              | Determining your transmitter type . . . . .   | 3        |
| 1.5              | Micro Motion customer service . . . . .   | 3        |
| <br>             |   |          |
| <b>Chapter 2</b> | <b>Installation and Setup . . . . .</b>   | <b>7</b> |
| 2.1              | Overview . . . . .  | 7        |
| 2.2              | Installation and setup . . . . .  | 7        |
| 2.2.1            | Ensure required privileges . . . . .  | 7        |
| 2.2.2            | Install the ProLink II software . . . . .   | 8        |
| 2.2.3            | Generate the temporary license . . . . .  | 8        |
| 2.2.4            | Determine your connection type . . . . .  | 9        |
| 2.2.5            | Install the signal converter and connect the wires . . . . .                        | 11       |
| 2.2.6            | Configure ProLink II connection parameters and connect to the transmitter . . . . . | 26       |
| 2.2.7            | Obtain and configure a site key . . . . .   | 29       |
| 2.3              | Troubleshooting the ProLink II installation . . . . .                               | 30       |
| 2.3.1            | Insufficient privileges . . . . .   | 30       |
| 2.3.2            | Missing or corrupt registry entries . . . . .                                       | 30       |
| 2.4              | Troubleshooting the ProLink II connection . . . . .                                 | 31       |
| 2.4.1            | OPC server or OPC client issues . . . . .   | 31       |
| 2.4.2            | Other issues . . . . .  | 31       |

|                  |   |           |
|------------------|---|-----------|
| <b>Chapter 3</b> | <b>Using ProLink II Software</b>                                    | <b>33</b> |
| 3.1              | Overview  | 33        |
| 3.2              | ProLink II user interface   | 33        |
| 3.3              | Startup   | 33        |
| 3.3.1            | Connecting to a transmitter   | 34        |
| 3.3.2            | Disconnecting   | 36        |
| 3.4              | ProLink II help system  | 36        |
| 3.5              | Viewing installed options   | 36        |
| 3.6              | Viewing process data  | 37        |
| 3.7              | Viewing and resetting totalizers and inventories                    | 37        |
| 3.8              | Viewing meter status  | 38        |
| 3.9              | Viewing and acknowledging alarms                                    | 39        |
| 3.9.1            | Viewing alarms  | 39        |
| 3.9.2            | Acknowledging alarms  | 41        |
| 3.10             | Managing the ProLink II license                                     | 41        |
| 3.10.1           | Transferring to same PC   | 41        |
| 3.10.2           | Transferring to different PC  | 41        |
| <br>             |   |           |
| <b>Chapter 4</b> | <b>Initial Transmitter Startup Procedures</b>                       | <b>43</b> |
| 4.1              | Overview  | 43        |
| 4.2              | Loop tests  | 43        |
| 4.3              | Trimming the milliamp (mA) output(s)                                | 46        |
| 4.4              | Zeroing the meter   | 48        |
| <br>             |   |           |
| <b>Chapter 5</b> | <b>Transmitter Configuration, Characterization, and Calibration</b> | <b>51</b> |
| 5.1              | Overview  | 51        |
| 5.2              | Using configuration files   | 51        |
| 5.2.1            | Saving a configuration file to a PC                                 | 51        |
| 5.2.2            | Loading a configuration file to a transmitter                       | 52        |
| 5.3              | Configuring a transmitter   | 52        |
| 5.3.1            | Using the Gas Unit Configurator tool                                | 54        |
| 5.4              | Characterizing the meter  | 55        |
| 5.4.1            | When to characterize  | 55        |
| 5.4.2            | Characterization parameters   | 55        |
| 5.4.3            | How to characterize   | 58        |
| 5.5              | Calibrating the meter   | 58        |
| 5.5.1            | When to calibrate   | 59        |
| 5.5.2            | Density calibration   | 59        |
| 5.5.3            | Temperature calibration   | 63        |
| 5.6              | Compensating for pressure   | 64        |
| 5.6.1            | Options   | 64        |
| 5.6.2            | Pressure correction factors   | 64        |
| 5.6.3            | Configuration   | 64        |
| 5.7              | Compensating for temperature  | 65        |
| 5.8              | Configuring polling   | 66        |

## Contents

|                   |   |           |
|-------------------|---|-----------|
| <b>Chapter 6</b>  | <b>Meter Verification</b>                         | <b>67</b> |
| 6.1               | Overview  | 67        |
| 6.2               | Running the meter verification test               | 67        |
| 6.2.1             | First panel: Sensor and Transmitter Configuration | 67        |
| 6.2.2             | Second panel: Test Definition                     | 69        |
| 6.2.3             | Third panel: Start                                | 70        |
| 6.2.4             | Fourth panel: Test Results                        | 73        |
| 6.2.5             | Fifth panel: Report                               | 74        |
| <b>Chapter 7</b>  | <b>Data Logger</b>                                | <b>77</b> |
| 7.1               | Overview  | 77        |
| 7.2               | Using Data Logger                                 | 77        |
| 7.2.1             | Defining the log file                             | 77        |
| 7.2.2             | Specifying log contents                           | 78        |
| 7.2.3             | Starting and stopping the logging function        | 79        |
| 7.2.4             | Data Logger tools                                 | 79        |
| <b>Appendix A</b> | <b>Transmitter Terminal Reference</b>             | <b>81</b> |
| A.1               | Overview  | 81        |
| A.2               | Transmitter terminal diagrams                     | 82        |
| <b>Appendix B</b> | <b>Configuring the Discrete Batch Application</b> | <b>87</b> |
| B.1               | About this appendix                               | 87        |
| B.2               | About discrete batching                           | 87        |
| B.3               | Discrete batch configuration                      | 87        |
| B.3.1             | Flow source                                       | 89        |
| B.3.2             | Control options                                   | 90        |
| B.3.3             | Configure presets                                 | 92        |
| B.3.4             | Batch control methods                             | 94        |
| B.4               | Running a batch                                   | 97        |
| B.5               | Performing Batch AOC calibration                  | 98        |
| <b>Index</b>      |   | <b>99</b> |



# Chapter 1

## Before You Begin

### 1.1 About this manual

This manual explains how to install the Micro Motion® ProLink® II software program, v2.5 and later, on your personal computer (PC).

This manual also provides an overview of using ProLink II with Micro Motion transmitters. Before using this instruction manual, the reader should be familiar with the Microsoft Windows operating system.

There are a number of transmitter and application features that may appear in your ProLink II installation: for example, the enhanced density application, the petroleum measurement application, the custody transfer application, event configuration, or display configuration. This manual contains information on configuring and using the discrete batch application (see Appendix B). For detailed information on configuring and using other transmitter-specific or application-specific features, see the appropriate transmitter or application manual. If you still have questions, contact the Micro Motion Customer Service Department. Telephone numbers are listed in Section 1.5.

### 1.2 About ProLink II software

This section provides an overview of ProLink II software.

#### 1.2.1 Supported transmitters

The ProLink II program provides communication between a personal computer and the following Micro Motion transmitters and devices:

- Model 1700/2700
- Model 1500/2500
- Model 2400S
- Core processor and Enhanced core processor
- MVD™ Direct Connect™
- Series 3000 with 4-wire sensor interface (MVD™)
- RFT9739
- RFT9712
- IFT9701/9703

*Note: MVD Direct Connect is a direct host meter that does not include a transmitter. However, ProLink II can be used to communicate with the core processor component in MVD Direct Connect installations.*

## Before You Begin

### 1.2.2 Uses of ProLink II

Using ProLink II, you can:

- Perform initial transmitter startup procedures
- Read process variables
- Manage totalizers and inventories
- Configure the transmitter
- Perform verification and calibration procedures
- Read meter status information and alarm conditions
- Troubleshoot the meter

## 1.3 ProLink II requirements

Before starting the ProLink II installation, review the requirements in this section.

### 1.3.1 PC requirements

To install and run ProLink II, your PC must meet or exceed the following requirements:

- 200 MHz Pentium processor
- One of the following:
  - Windows 98 (initial release or second edition) with 32 megabytes (MB) RAM
  - Windows ME with 64 MB RAM
  - Windows NT 4.0 with Service Pack 6a and 64 MB RAM
  - Windows 2000 with Service Pack 3 and 128 MB RAM
  - Windows XP with Service Pack 1 and 128 MB RAM
- 24 MB of available hard disk space
- Video with support for 256 or more colors
- An available serial port or USB port

*Note: Windows NT does not support the USB port.*

### 1.3.2 Installation kits

Micro Motion provides ProLink II installation kits for RS-485 connections (serial port or USB) and for Bell 202 connections (serial port or USB). Kit contents are listed in Table 1-1. If you need a ProLink II installation kit, contact Micro Motion.



**Table 1-1 ProLink II installation kits**

| Physical layer | Connection  | Kit contents  |
|----------------|-------------|---|
| RS-485         | Serial port | <ul style="list-style-type: none"> <li>• Black Box Async RS-232 &lt;-&gt; 2-wire RS-485 Interface Converter (Code IC521A-F)</li> <li>• DB9-DB25 adapter</li> <li>• DB9-DB9 tester</li> <li>• Cable</li> </ul>   |
|                | USB         | <ul style="list-style-type: none"> <li>• Black Box Async RS-232 &lt;-&gt; 2-wire RS-485 Interface Converter (Code IC521A-F)</li> <li>• Black Box USB-to-serial (RS-232) converter (Code IC138A)</li> <li>• DB9-DB25 adapter</li> <li>• DB9-DB9 tester</li> <li>• Cable</li> </ul> |
| Bell 202       | Serial port | <ul style="list-style-type: none"> <li>• MACTek VIATOR RS232 HART Interface with integral HART cable terminating in two clips (Model 010001)</li> <li>• DB9-DB9 tester</li> </ul>   |
|                | USB         | <ul style="list-style-type: none"> <li>• MACTek VIATOR USB HART Interface with integral USB cable and integral HART cable terminating in two clips (Model 010031)</li> </ul>  |

*Note: If you use a different RS-232 to RS-485 signal converter or HART interface, it is your responsibility to ensure that your equipment provides equivalent functionality. See the README.txt file in the ProLink II installation directory, or contact Micro Motion customer support for assistance or additional information.*

*Note: A Windows driver is required for correct operation of the VIATOR USB HART Interface. This driver is provided with the VIATOR USB HART Interface. Ensure that the driver is installed before attempting to connect through the USB port. If this driver is not installed, Windows will not recognize the USB converter when it is plugged into the USB port.*

### 1.4 Determining your transmitter type

To configure, use, and troubleshoot the transmitter, you must know your transmitter type, installation/mounting type, and outputs option board type (Series 1000/2000 transmitters only). The transmitter’s model number, which is provided on a tag attached to the transmitter, provides this information. See Figure 1-1 for assistance in interpreting the model number.

If you are using MVD Direct Connect, refer to the model number on the sensor.

### 1.5 Micro Motion customer service

For customer service, phone the support center nearest you:

- In the U.S.A., phone 1-800-522-MASS (1-800-522-6277)
- In Canada and Latin America, phone (303) 527-5200
- In Asia, phone (65) 6770-8155
- In the U.K., phone 0870 240 1978 (toll-free)
- Outside the U.K., phone +31 (0) 318 495 670

## Before You Begin

Figure 1-1 Transmitter model numbers and codes

### RFT9739

RFT9739xxxxxxxx

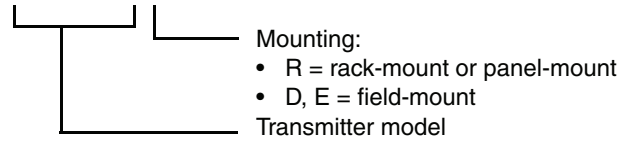

### RFT9712

RFT9712xxxxxxxx

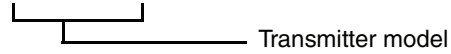

### Series 3000

3xx0xxxxxxxxxxxx

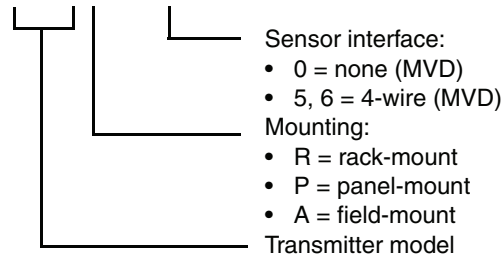

### IFT9701/9703

IFT970xxxxxxxxxx

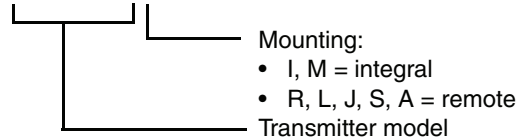

### Model 1500/2500

x500xxxxxxxxxxxx

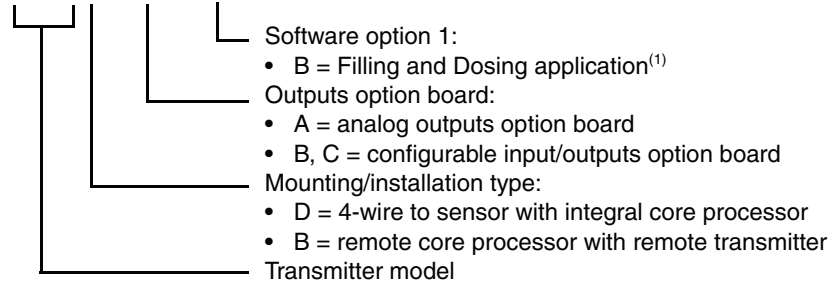

(1) Model 1500 transmitter with filling and dosing application only.  
Requires Outputs option board C.

### Model 1700/2700

x700xxxxxxxxxxxx

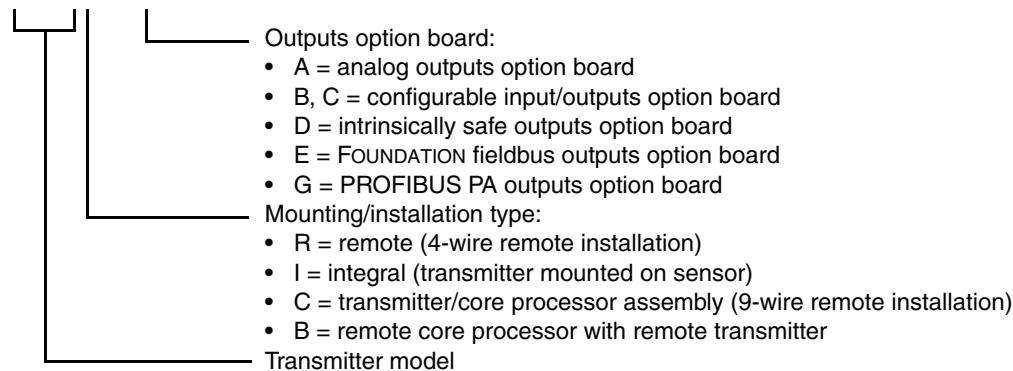
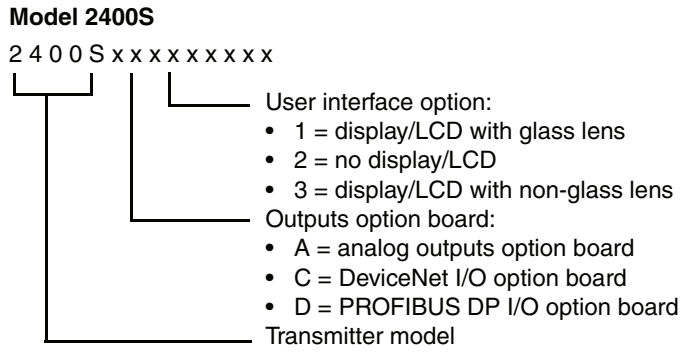

Figure 1-1 Transmitter model numbers and codes *continued*





# Chapter 2

## Installation and Setup

### 2.1 Overview

This chapter provides information on installing ProLink II software, connecting to the transmitter, and troubleshooting the installation or connection.

To install and set up ProLink II, the following steps are required:

1. Ensure required privileges (see Section 2.2.1)
2. Install the ProLink II software onto your PC (see Section 2.2.2)
3. Generate the temporary license (see Section 2.2.3)
4. Determine your connection type (see Section 2.2.4)
5. Install the signal converter and connect the wires between the PC and the transmitter (see Section 2.2.5)
6. Configure the connection and connect to the transmitter (see Section 2.2.6)
7. Obtain and configure a site key (see Section 2.2.7)

For troubleshooting information, see Section 2.3 and Section 2.4.

### 2.2 Installation and setup

To install and set up ProLink II, follow the steps below.

#### 2.2.1 Ensure required privileges

Installing and running ProLink II requires specific privileges. Install ProLink II using the required user account, and ensure that all persons who will run ProLink II have the required privileges. See Table 2-1.

**Table 2-1 Required privileges**

| Operating system | To install ProLink II                      | To run ProLink II  |
|------------------|--|--|
| Windows NT 4.0   | Must be the built-in Admin account         | <ul style="list-style-type: none"> <li>• Read/write local hard drive</li> <li>• Read/write Windows registry</li> </ul> |
| Windows 2000     | Must be member of the Administrators group | <ul style="list-style-type: none"> <li>• Read/write local hard drive</li> <li>• Read/write Windows registry</li> </ul> |
| Windows XP       | Must be member of the Administrators group | <ul style="list-style-type: none"> <li>• Read/write local hard drive</li> <li>• Read/write Windows registry</li> </ul> |
| Windows 98       | Not applicable                             | Not applicable   |
| Windows ME       | Not applicable                             | Not applicable   |

## Installation and Setup

During installation on a Windows NT, Windows 2000, or Windows XP system, if the installer is not in the Administrator group, the installation wizard may display a message warning that the installation may not be successful. If this occurs, the installation wizard will run to completion but the Windows registry may not be updated correctly. If you are subsequently unable to connect to a transmitter, reinstall the software using the required user account.

### 2.2.2 Install the ProLink II software

To install ProLink II software:

1. Insert the ProLink II CD-ROM into the PC's CD-ROM drive.
2. If the setup program does not start automatically, locate and run the SETUP.EXE file. The file is located in the root directory on the CD-ROM (e.g., D:\setup.exe, where "D" is your CD-ROM drive letter).
3. Follow the on-screen instructions to complete the installation. If you have a previous version of ProLink II installed on your PC, you may be prompted to remove it before installing the new version.

*Note: The ProLink II site key is associated with a disk drive and specific folder on your PC. If you decide to move ProLink II after installation, you will have to transfer the license and reinstall ProLink II. To avoid this step, be sure to install ProLink II into a location that you can use permanently.*

*Note: If you have a Model 2700 transmitter with transmitter software earlier than v3.4, and you have the enhanced density application installed, you cannot access the enhanced density functions with ProLink II v2.1 or later. To configure and manage the enhanced density application from ProLink II, you must either upgrade your transmitter software to v3.4 or later, or continue to use ProLink II v1.x with enhanced density support. You can install both ProLink II v1.x and ProLink II v2.0 or later on the same PC, and you can use ProLink II v2.0 or later with your pre-v3.4 transmitter for all functions except enhanced density. You can also use ProLink v1.2 with transmitter software v3.4 and later; however, not all transmitter functions will be accessible using the older program.*

### 2.2.3 Generate the temporary license

The first time ProLink II is run, you will be prompted to generate a temporary license. This license will allow you to run ProLink II with full functionality for seven days, starting from the current date and time. Follow the on-screen instructions to generate the temporary license.

*Note: If you are running Windows 98 or Windows ME, you must temporarily disable any anti-virus software running on your PC before you can generate the temporary license. You can re-enable the anti-virus software immediately after the temporary license has been successfully generated.*

Continue with Section 2.2.4 to use ProLink II for seven days. During this time period, follow the instructions in Section 2.2.7 to obtain and configure a site key.

*Note: If you attempt to use ProLink II after the temporary license has expired, ProLink II will no longer allow you to connect to a transmitter.*

### 2.2.4 Determine your connection type

Different transmitters and networks support different connection types.

- Table 2-2 lists the supported protocols and wiring methods for IFT97xx and RFT97xx transmitters.
- Table 2-3 lists the supported protocols and wiring methods for Model 1500/2500, Model 1700/2700, and Series 3000 transmitters.
- Table 2-4 lists the supported protocols and wiring methods for the Model 2400S transmitter.
- Table 2-5 lists the supported protocols and wiring methods for all MVD Direct Connect systems.

In these tables, and throughout the chapter:

- *Temporary* – refers to a connection that is not permanent and is typically used only for configuration and troubleshooting. Because the transmitter housing must be open for the duration of the connection, these connections should be removed and the housing closed as soon as possible. The operator should be aware of the safety hazards that result from opening the transmitter housing.
- *Hard-wired* – refers to a connection that is made to the permanent wiring, usually a transmitter output wire or the network that the transmitter is already using. Because hard-wired connections do not require the transmitter housing to be open, they can be left in place as desired.
- *AN* – refers to transmitters with the analog outputs option board
- *IS* – refers to transmitters with the intrinsically safe outputs option board
- *CIO* – refers to transmitters with the configurable input/outputs option board
- *FF* – refers to transmitters with the FOUNDATION fieldbus input/output option board
- *PA* – refers to transmitters with the PROFIBUS-PA input/output option board
- *DP* – refers to transmitters with the PROFIBUS-DP input/output option board
- *DN* – refers to transmitters with the DeviceNet input/output option board
- *MVD Direct Connect* – refers to meter installations that include the core processor but do not include a transmitter. ProLink II is connected directly to the RS-485 terminals on the core processor or the MVD Direct Connect I.S. barrier.

Once you have determined your connection type, use the Wiring Method # value in the table to direct you to the correct wiring procedure in Section 2.2.5.

**Table 2-2 Communication protocols and wiring methods for IFT97xx and RFT97xx transmitters**

| Wiring method  | Transmitter type   |         |         | Wiring method # |
|--|--------------------|---------|---------|-----------------|
|  | IFT9701<br>IFT9703 | RFT9712 | RFT9739 |                 |
| <b>HART protocol</b>   |                    |         |         |                 |
| <i>Bell 202 physical layer</i>   |                    |         |         |                 |
| • Temporary or hard-wired connection to transmitter or multidrop network | ✓                  | ✓       | ✓       | 1               |
| • Temporary connection to field-mount transmitters                       |                    | ✓       | ✓       | 2               |
| • Temporary connection to rack-mount transmitters                        |                    |         | ✓       | 3               |
| <i>RS-485 physical layer</i>   |                    |         |         |                 |
| • Temporary or hard-wired connection to transmitter or multidrop network |                    | ✓       | ✓       | 5               |
| <b>Modbus protocol (RS-485 physical layer)</b>                           |                    |         |         |                 |
| • Temporary or hard-wired connection to transmitter or multidrop network |                    |         | ✓       | 6               |

**Table 2-3 Communication protocols and wiring methods for Model 1500/2500, Model 1700/2700, and Series 3000 transmitters**

| Wiring method  | Transmitter type |                 |             | Wiring method # |
|--|------------------|-----------------|-------------|-----------------|
|  | Model 1500/2500  | Model 1700/2700 | Series 3000 |                 |
| <b>HART protocol</b>   |                  |                 |             |                 |
| <i>RS-485 physical layer</i>   |                  |                 |             |                 |
| • Temporary or hard-wired connection to RS-485 terminals                       |                  | AN              | ✓           | 5               |
| <i>Bell 202 physical layer</i>   |                  |                 |             |                 |
| • Temporary or hard-wired connection to primary mA output or multidrop network | ✓ <sup>(1)</sup> | AN<br>CIO       | ✓           | 1               |
| • Temporary or hard-wired connection to primary mA output or multidrop network |                  | IS              |             | 4               |
| <b>Modbus protocol (RS-485 physical layer)</b>                                 |                  |                 |             |                 |
| • Temporary or hard-wired connection to RS-485 terminals                       | ✓                | AN              | ✓           | 6               |
| • Temporary connection to service port   | ✓                | ✓               | ✓           | 7               |

(1) Except Model 1500 transmitter with the Filling and Dosing application. The Model 1500 transmitter with the Filling and Dosing application does not support HART communication.



**Table 2-4 Communication protocols and wiring methods for Model 2400S transmitters**

| Wiring method  | Transmitter type | Wiring method # |
|--|------------------|-----------------|
| <b>HART protocol</b> ( <i>Bell 202 physical layer</i> )                        |                  |                 |
| • Temporary connection to HART clips   | AN               | 8               |
| • Temporary or hard-wired connection to primary mA output or multidrop network | AN               | 1               |
| <b>Modbus protocol</b> ( <i>RS-485 physical layer</i> )                        |                  |                 |
| • Temporary connection to service port clips                                   | AN<br>DN<br>DP   | 7               |

**Table 2-5 Communication protocols and wiring methods for MVD Direct Connect**

| Wiring method  | Wiring method # |
|--|-----------------|
| <b>Modbus protocol</b> ( <i>RS-485 physical layer</i> )                                    |                 |
| • Temporary or hard-wired connection to RS-485 terminals on core processor or I.S. barrier | 9               |

**2.2.5 Install the signal converter and connect the wires**

All ProLink II connection methods require a signal converter. Micro Motion offers four different installation kits to cover all required signal converter types. See Section 1.3.2 for a list of the available installation kits and signal converters.

*Note: A Windows driver is required for correct operation of the VIATOR USB HART Interface. This driver is provided with the VIATOR USB HART Interface. Ensure that the driver is installed before attempting to connect through the USB port. If this driver is not installed, Windows will not recognize the USB converter when it is plugged into the USB port.*

To install the signal converter and connect the wires, follow the instructions for your connection type. Refer to the Wiring Method # value in Table 2-2, 2-3, 2-4 or 2-5.

**⚠ WARNING**

**On Model 1700/2700 transmitters, opening the power supply compartment in explosive atmospheres while the power is on can cause an explosion.**

Before using the service port to communicate with the transmitter in a hazardous area, make sure the atmosphere is free of explosive gases.

**⚠ WARNING**

**On Model 1700/2700 transmitters, opening the power supply compartment can expose the operator to electric shock.**

To avoid the risk of electric shock, do not touch the power supply wires or terminals while using the service port.

**⚠ WARNING**

**On Model 3350/3700 transmitters, opening the wiring compartment in explosive atmospheres can cause an explosion.**

Do not remove the compartment covers in an explosive atmosphere within three minutes after power is disconnected.

**⚠ WARNING**

**On Model 2400S transmitters, removing the transmitter housing cover in a hazardous area can cause an explosion.**

Because the housing cover must be removed to connect to this transmitter using the service port clips or HART clips, these connections should be used only for temporary connections, for example, for configuration or troubleshooting purposes.

When the transmitter is in an explosive atmosphere, use a different method to connect to your transmitter.

**⚠ WARNING**

**Removing the core processor lid can expose the operator to electric shock.**

To avoid the risk of electric shock, do not touch the power supply wires or terminals while removing or replacing the core processor lid, or while using the RS-485 terminals.

**⚠ CAUTION**

**Connecting a HART device to the transmitter's primary mA output could cause transmitter output error.**

If the primary mA output is being used for flow control, connecting the VIATOR HART Interface to the output loop, via either the mA terminals or the HART clips, could cause the transmitter's 4–20 mA output to change, which would affect flow control devices.

Set control devices for manual operation before connecting the VIATOR HART Interface to the transmitter's primary mA output loop.

**Method 1: HART/Bell 202 temporary or hard-wired connection to transmitter or multidrop network**

*Note: This method is supported by RFT9739, RFT9712, and IFT9701/9703 transmitters, by Model 1700/2700 transmitters with the analog outputs option board or configurable input/outputs options board, by Model 1500/2500 transmitters, by Model 2400S transmitters with the analog outputs option board, and by Series 3000 transmitters.*

Using a VIATOR HART Interface, the PC can be connected directly to a transmitter’s primary mA output terminals, to the output wires from these terminals, or to any point in a multidrop network that is wired to these terminals. Figure 2-1 shows the wiring for this connection type.

**Figure 2-1 HART/Bell 202 temporary or permanent connection to transmitter or multidrop network**

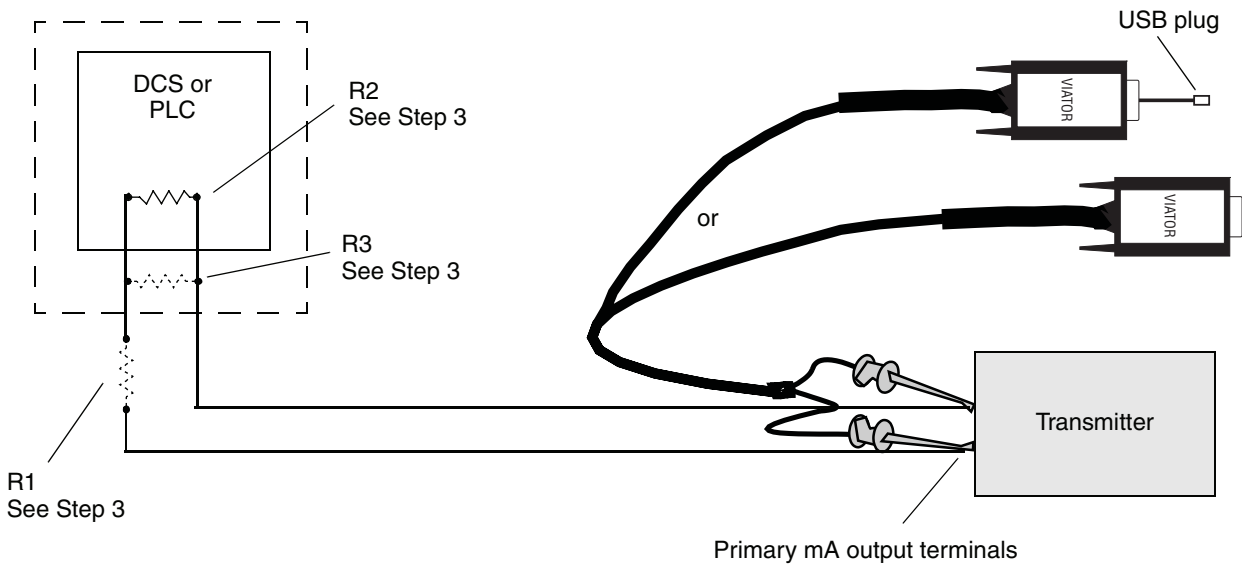

1. At the PC, connect the VIATOR HART Interface to the PC’s serial or USB port.
2. Attach the VIATOR HART Interface leads:
  - To any point on the network (hard-wired connection)
  - Directly to the primary mA output terminals on your transmitter (temporary connection). See Table 2-6
  - To the output wires from the primary mA output terminals on your transmitter (hard-wired connection). See Table 2-6

The connection is polarity-insensitive; you can attach either lead to either terminal. For assistance in identifying the primary mA output terminals, see Appendix A.

**Table 2-6 Primary mA output terminals – Method 1**

| Transmitter   | Terminals |         |
|---|-----------|---------|
|   | PV +      | PV –    |
| RFT9712   | 17        | 16      |
| RFT9739 rack-mount  | Z30       | D30     |
| RFT9739 field-mount   | 17        | 18      |
| IFT9701/9703  | 4–20 mA   | 4–20 mA |
| Model 1500/2500   | 21        | 22      |
| Model 1700/2700 AN<br>Model 1700/2700 CIO<br>Model 2400S AN | 1         | 2       |
| Series 3000 panel-mount with screw-type connectors          | c2        | a2      |
| Series 3000 panel-mount with I/O cables                     | 14        | 15      |
| Series 3000 rack-mount                                      | c2        | a2      |
| Series 3000 field-mount                                     | 2         | 1       |

3. If necessary, add a resistor to the connection as required by your transmitter (see Table 2-7).
  - If no other device is connected to the primary mA output, add the resistor in parallel with the primary mA output.
  - If the primary mA output is connected to a remote device such as a DCS or a PLC with an internal resistor (R2), ensure its value is within the range described in Table 2-7. If it is lower than 250 Ω, add resistor R1 to the connection so that the overall resistance (R1 + R2) is within the range described in Table 2-7.
  - If your DCS or PLC does not have an internal resistor, add resistor R3 and make sure its value is within the range described in Table 2-7.

**Table 2-7 Resistance requirements for HART/Bell 202 connection**

| Transmitter  | Resistance |
|--|------------|
| Model 1500/2500  | 250–600 Ω  |
| Model 1700/2700 AN<br>Model 2700 CIO<br>Model 2400S AN | 250–600 Ω  |
| Series 3000 (all models)                               | 250–600 Ω  |
| IFT9701<br>IFT9703                                     | 250–600 Ω  |
| RFT9712<br>RFT9739                                     | 250–1000 Ω |

**Method 2: HART/Bell 202 temporary connection to RFT9739 field-mount and RFT9712 transmitters**

1. At the PC, connect the VIATOR HART Interface to the PC's serial or USB port.
2. Open the transmitter's wiring compartment.
3. Locate the Bell 202 hookups inside the wiring compartment and attach the VIATOR HART Interface leads to the prongs (see Figure 2-2). The connection is polarity-insensitive; you can attach either lead to either prong. For assistance in locating the Bell 202 hookups, see Appendix A.
4. If necessary, add resistance in the loop by installing resistor R1 with a resistance of 250–1000  $\Omega$ . Note that the hookups use the same circuit as the primary mA output, so the required resistance may already be installed if the primary mA output loop is connected to a remote device.

**Figure 2-2 Attaching the VIATOR HART Interface to the prongs**

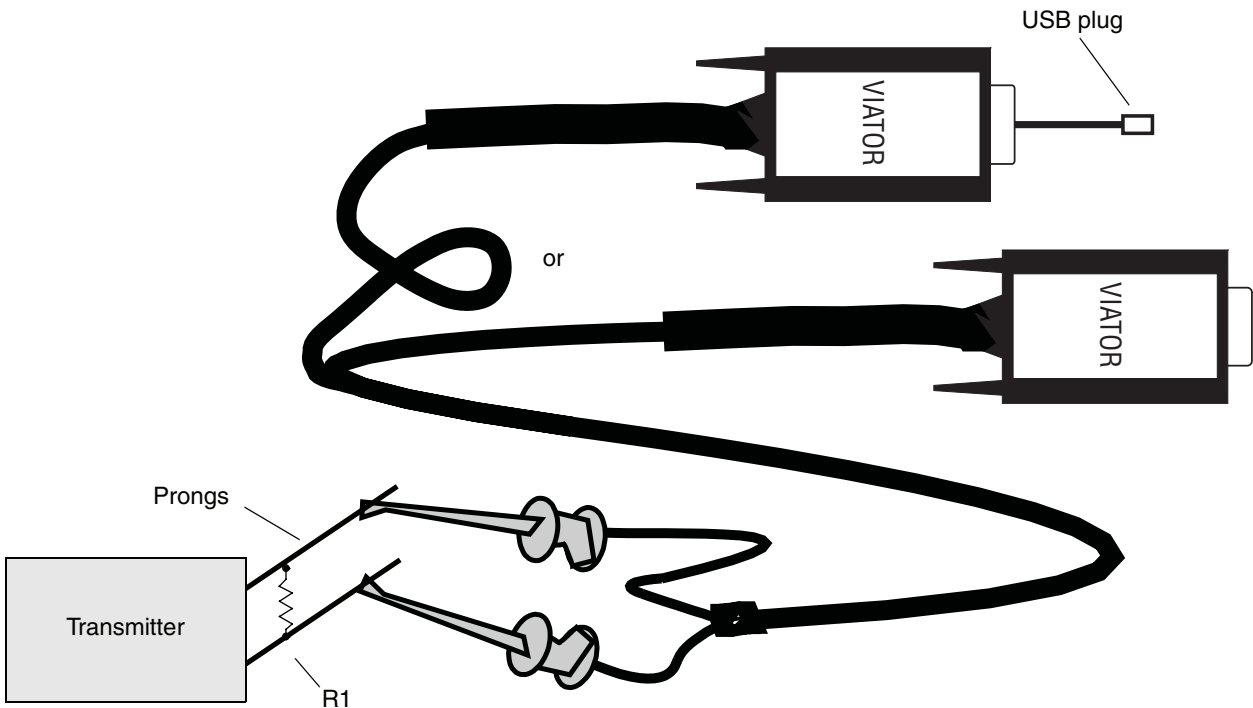

**Method 3: HART/Bell 202 temporary connection to RFT9739 rack-mount transmitters**

1. At the PC, connect the VIATOR HART Interface to the PC's serial or USB port.
2. Attach the leads of a Bell 202 cable to the leads of the VIATOR HART Interface, and insert the cable prongs into the HART jack on the transmitter's faceplate (see Figure 2-3). The connection is polarity-insensitive; you can insert the cable prongs in either direction.
3. If necessary, add resistance in the loop by installing resistor R1 with a resistance of 250–1000  $\Omega$ . Note that the hookups use the same circuit as the primary mA output, so the required resistance may already be installed if the primary mA output loop is connected to a remote device or a HART network.

**Figure 2-3 Using the HART jack**

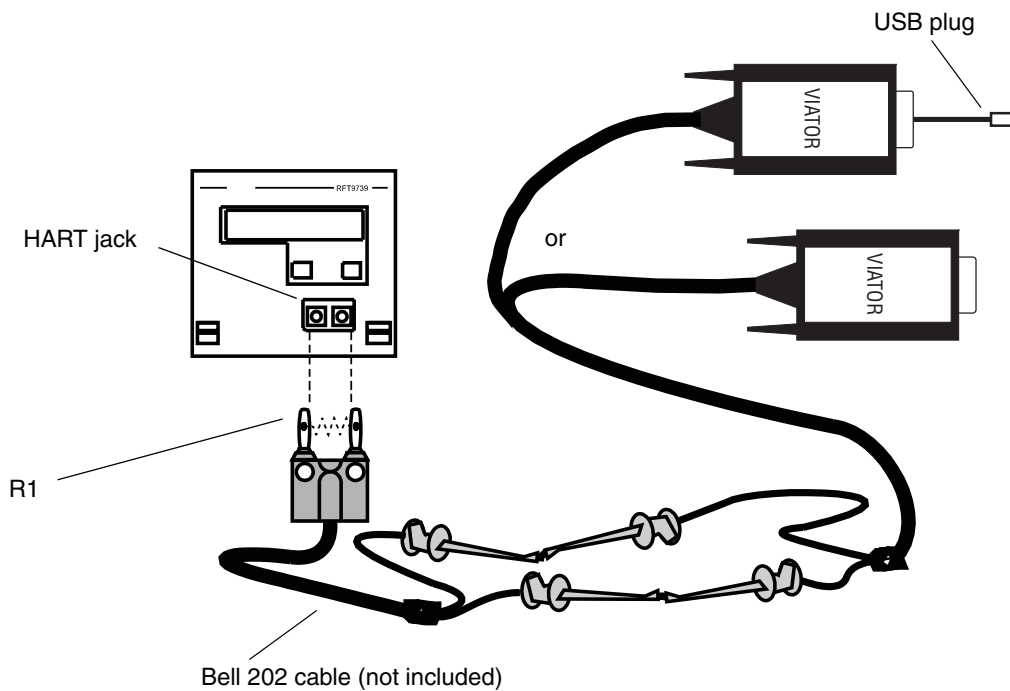

**Method 4: HART/Bell 202 temporary or hard-wired connection to Model 1700/2700 IS transmitters**

Using a VIATOR HART Interface, the PC can be connected directly to a transmitter’s primary mA output terminals, to the output wires from these terminals, or to any point in a multidrop network that is wired to these terminals. Figure 2-4 shows the wiring for this connection type.

1. At the PC, connect the VIATOR HART Interface to the PC’s serial or USB port.
2. Attach the VIATOR HART Interface leads:
  - To any point on the network (hard-wired connection)
  - Directly to the primary mA output terminals on your transmitter (temporary connection). See Table 2-8
  - To the output wires from the primary mA output terminals on your transmitter (hard-wired connection). See Table 2-8

The connection is polarity-insensitive; you can attach either lead to either terminal. For assistance in identifying the primary mA output terminals, see Appendix A.

**Table 2-8 Primary mA output terminals – Method 4**

| Transmitter        | Terminals |      |
|--------------------|-----------|------|
|                    | PV +      | PV – |
| Model 1700/2700 IS | 1         | 2    |

3. Ensure that your wiring meets the following requirements:
  - For basic analog output operation, the primary mA output requires an external power supply with a minimum of 250 Ω and 17.5 volts. See Figure 2-5.
  - For communication, the VIATOR HART Interface must be connected across a resistance of 250–600 Ω. See Figure 2-4.

To meet the resistance requirements, you may use any combination of resistors R1, R2, and R3:

- If no other device is connected to the primary mA output, add resistor R1 in series with the primary mA output.
- If the primary mA output is connected to a remote device such as a DCS or a PLC with an internal resistor (R2), ensure its value is between 250 and 600 Ω. If it is lower than 250 Ω, add resistor R1 to the connection so that the overall resistance (R1 + R2) is between 250 and 600 Ω.
- If your DCS or PLC does not have an internal resistor, add resistor R3 and make sure its value is between 250 and 600 Ω.

Installation and Setup

Figure 2-4 HART/Bell 202 connection to Model 1700/2700 IS transmitters

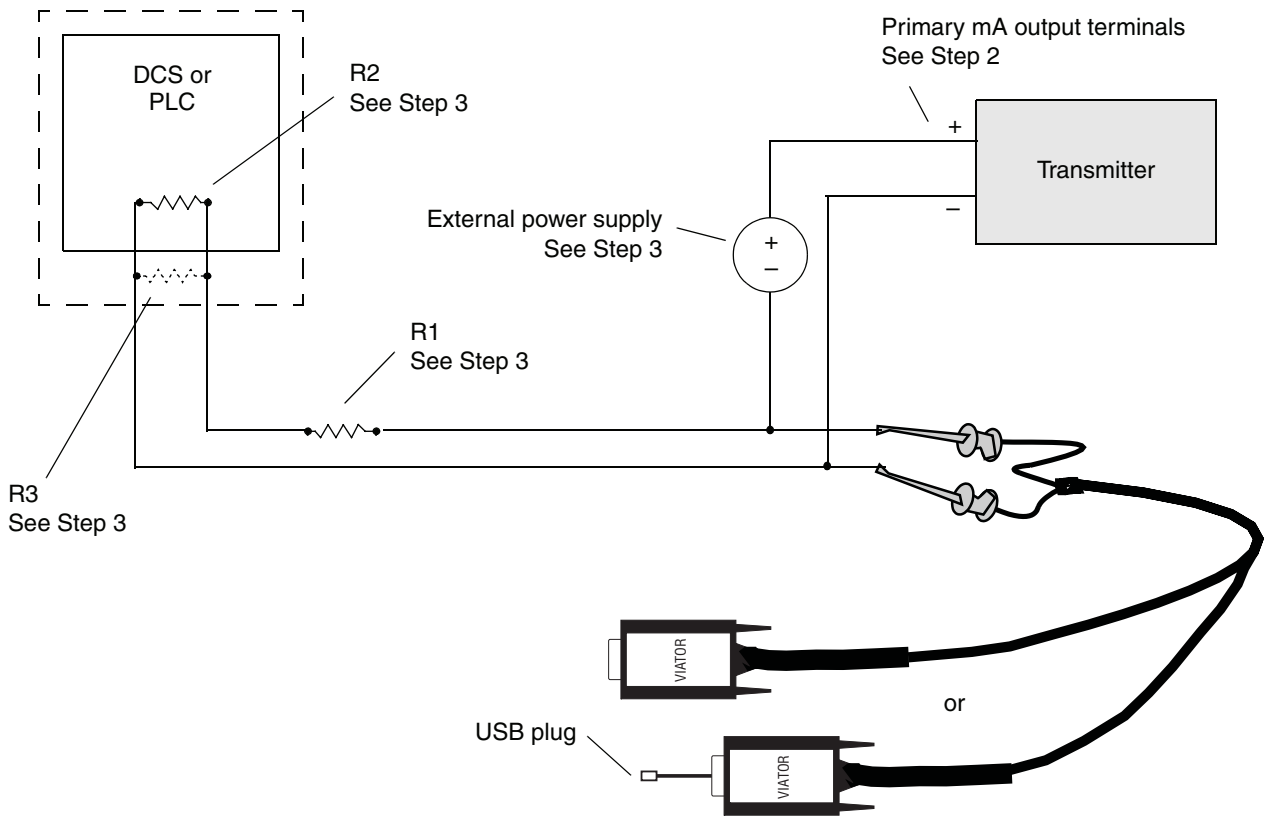
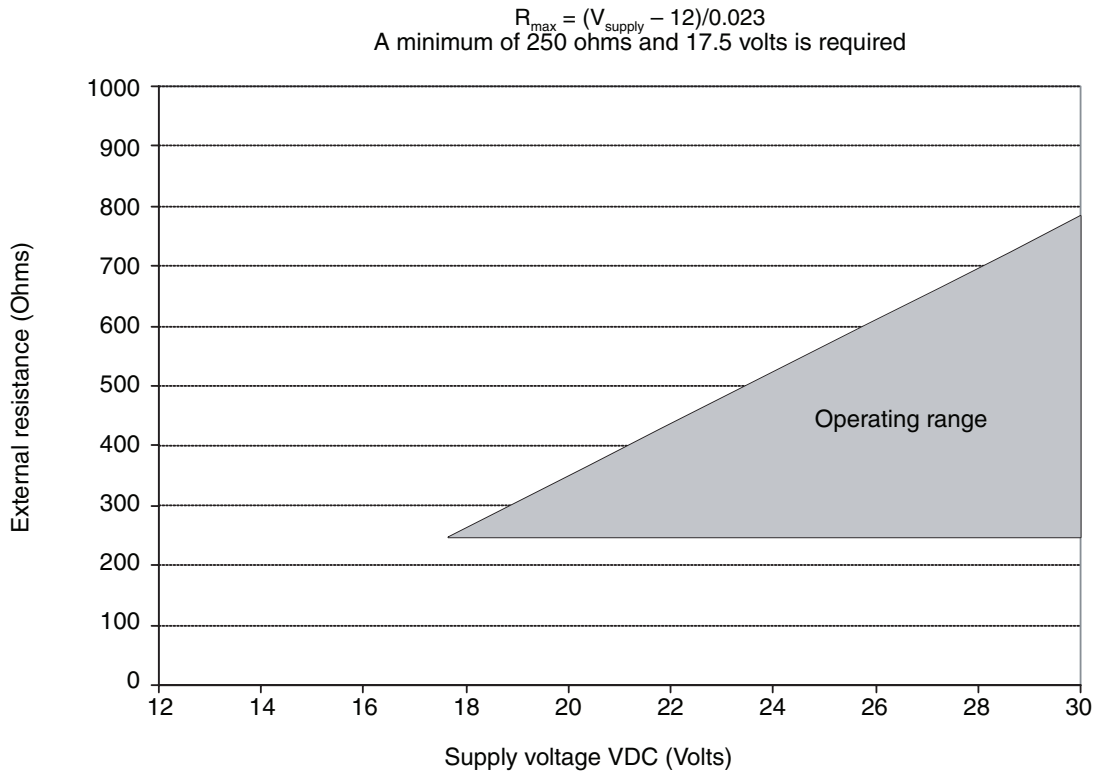

Figure 2-5 Model 1700/2700 IS transmitters: Resistance and voltage requirements for HART/Bell 202 connections





**Method 5: HART/RS-485 temporary or hard-wired connection to transmitter or multidrop network**

*Note: This method is supported by RFT9739 and RFT9712 transmitters, by Model 1700/2700 transmitters with the analog outputs option board, and Series 3000 transmitters.*

Using a Black Box signal converter, the PC can be connected directly to a transmitter’s RS-485 terminals, to the output wires from these terminals, or to any point on a multidrop network. Figure 2-6 shows the wiring for this connection type.

1. Ensure that your transmitter’s RS-485 terminals are configured for HART protocol. See the transmitter manual for instructions.
2. If you are using an RFT9712 transmitter, you must set a jumper on the transmitter for RS-485 communications. See the transmitter manual for instructions.
3. At the PC, attach the Black Box signal converter to the PC’s serial or USB port, using a 25-pin to 9-pin adapter if necessary. Ensure that the positive and negative wires are connected as shown in Table 2-9 and Figure 2-6.
4. Attach the other end of the signal converter leads:
  - To any point on the network (hard-wired connection)
  - Directly to the RS-485 terminals on your transmitter (temporary connection). See Table 2-9
  - To the output wires from the RS-485 terminals on your transmitter (hard-wired connection). See Table 2-9

For assistance in identifying the RS-485 terminals, see Appendix A.

5. For long-distance communication, or if noise from an external source interferes with the signal, add two 120-Ω terminating resistors (R1) at each end of the RS-485 network.

**Table 2-9 Lead-to-terminal assignments – Method 5**

| Transmitter  | Terminals |          |
|--|-----------|----------|
|  | RS-485/A  | RS-485/B |
| Model 1700/2700 AN                                 | 5         | 6        |
| Series 3000 panel-mount with screw-type connectors | a32       | c32      |
| Series 3000 panel-mount with I/O cables            | 25        | 24       |
| Series 3000 rack-mount                             | a32       | c32      |
| Series 3000 field-mount                            | 12        | 11       |
| RFT9712  | 21        | 22       |
| RFT9739 field-mount                                | 27        | 26       |
| RFT9739 rack-mount                                 | Z22       | D22      |

Figure 2-6 HART/RS-485 connection to transmitter or multidrop network

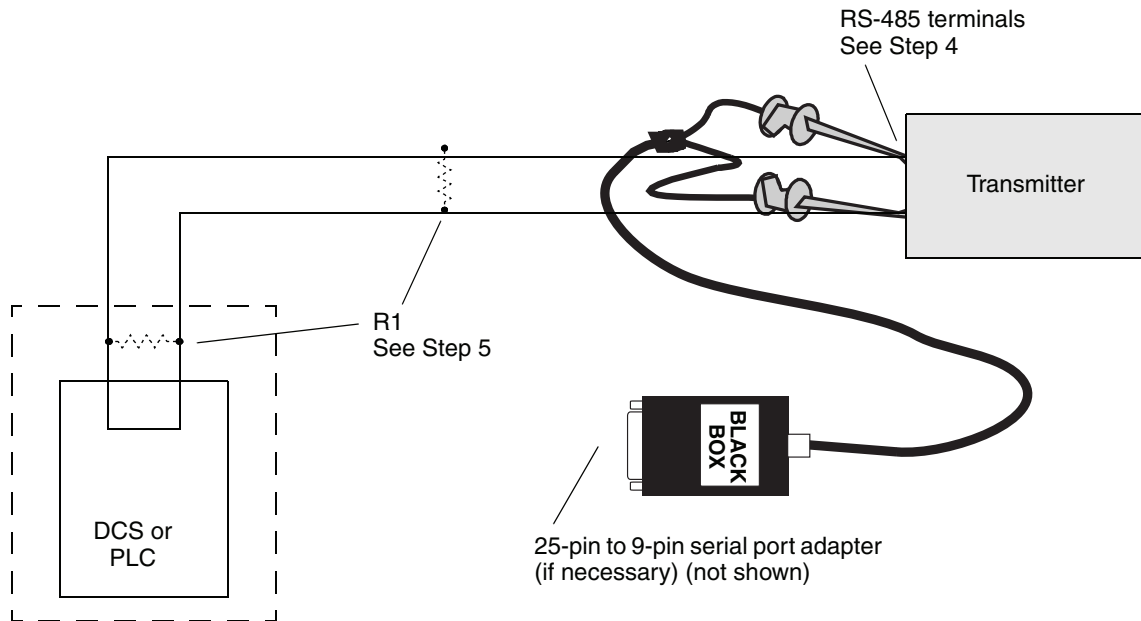

**Method 6: Modbus/RS-485 temporary or hard-wired connection to RS-485 multidrop network**

*Note: This method is supported by RFT9739 transmitters, by Model 1500/2500 transmitters, by Model 1700/2700 transmitters with the analog outputs option board, and by Series 3000 transmitters.*

Using a Black Box signal converter, the PC can be connected directly to a transmitter's RS-485 terminals, to the output wires from these terminals, or to any point on an RS-485 network. Figure 2-7 shows the wiring for this connection type.

1. At the PC, attach the Black Box signal converter to the PC's serial or USB port, using a 25-pin to 9-pin adapter if necessary.
2. Attach the other end of the signal converter leads:
  - To any point on the network (hard-wired connection). Ensure that the positive and negative wires are connected as shown in Table 2-9.
  - Directly to the RS-485 terminals on your transmitter (temporary connection). See Table 2-10.
  - To the output wires from the RS-485 terminals on your transmitter (hard-wired connection). See Table 2-10.

For assistance in identifying the RS-485 terminals, see Appendix A.

Table 2-10 Lead-to-terminal assignments – Method 6

| Transmitter  | Terminals |          |
|--|-----------|----------|
|  | RS-485/A  | RS-485/B |
| Model 1500/2500                                    | 33        | 34       |
| Model 1700/2700 AN                                 | 5         | 6        |
| Series 3000 panel-mount with screw-type connectors | a32       | c32      |
| Series 3000 panel-mount with I/O cables            | 25        | 24       |
| Series 3000 rack-mount                             | a32       | c32      |
| Series 3000 field-mount                            | 12        | 11       |
| RFT9712  | 21        | 22       |
| RFT9739 field-mount                                | 27        | 26       |
| RFT9739 rack-mount                                 | Z22       | D22      |

- For long-distance communication, or if noise from an external source interferes with the signal, install 120-Ω, 1/2-watt resistors (R1) across terminals of both end devices.

*Note: The Modbus protocol allows only one Modbus master to be active on the network at any given time. If you are connecting through a network, ensure that no other Modbus master devices are currently active.*

Figure 2-7 Modbus/RS-485 connection to RS-485 multidrop network

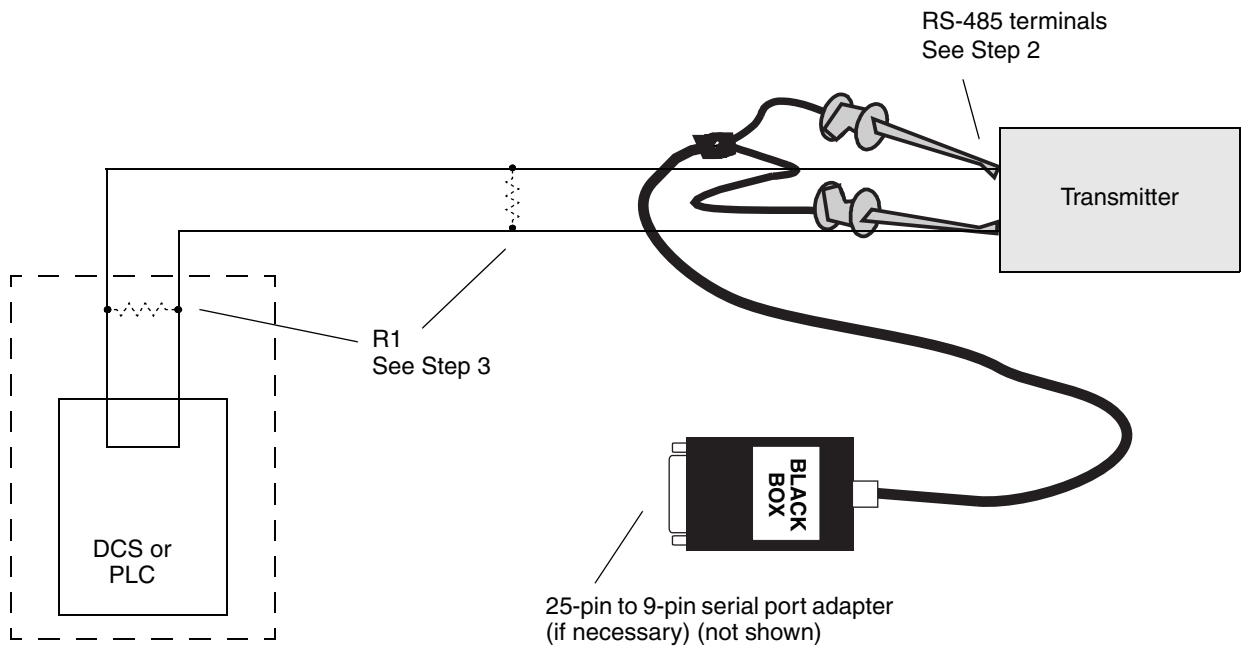

### Method 7: Modbus/RS-485 temporary connection to service port

*Note: This method is supported by all Series 1000, Series 2000 and Series 3000 transmitters.*

Using a Black Box signal converter, the PC can be connected directly to a transmitter's service port. Figure 2-8 shows the wiring for this connection type.

1. At the PC, attach the Black Box signal converter to the PC's serial or USB port, using a 25-pin to 9-pin adapter if necessary.
2. At the transmitter, connect the signal converter leads to the service port terminals. See Table 2-11. For assistance in identifying the terminals, see Appendix A.
  - If you are connecting to a Model 1700/2700 or to a Model 2400S transmitter, the service port terminals are available at any time.
  - If you are connecting to a Model 1500/2500 transmitter or a Series 3000 transmitter, the RS-485 terminals on these transmitters are accessible as a service port for a 10-second interval after power-up:
    - If a service port connection is made during this interval, the port will remain in service port mode indefinitely until power is cycled.
    - If no service port connection is made during this interval, the terminals switch to Modbus/RS-485 mode, and must be accessed using the RS-485 communication settings configured in the transmitter (see Method 6).

Service port connections to these transmitters are discussed in detail in Section 2.2.6.

*Note: The Modbus protocol allows only one Modbus master to be active on the network at any given time. If you are connecting through a network, ensure that no other Modbus master devices are currently active.*

*Note: All service ports are accessed using the default address of 111. If you are connecting over a multidrop network with multiple service ports, it is not possible to specify which device to connect to.*

**Figure 2-8 Modbus/RS-485 connection to the service port**

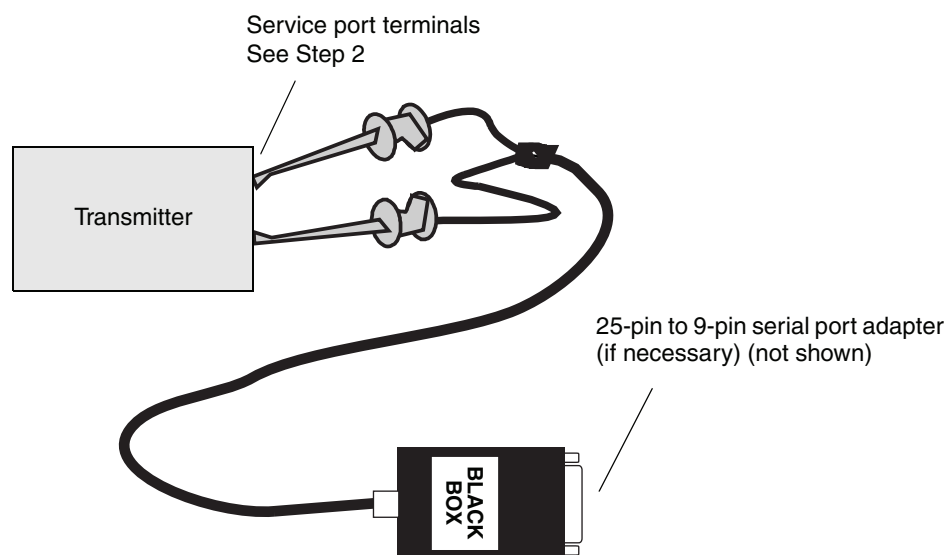

**Table 2-11 Lead-to-terminal assignments – Method 7**

| Transmitter  | Terminals |          |
|--|-----------|----------|
|  | RS-485/A  | RS-485/B |
| Model 1500/2500 transmitters                       | 33        | 34       |
| All Model 1700/2700 transmitters                   | 8         | 7        |
| All Model 2400S transmitters <sup>(1)</sup>        | A         | B        |
| Series 3000 panel-mount with screw-type connectors | a32       | c32      |
| Series 3000 panel-mount with I/O cables            | 25        | 24       |
| Series 3000 rack-mount                             | a32       | c32      |
| Series 3000 field-mount                            | 12        | 11       |

(1) On Model 2400S transmitters, service port connections are made via the service port clips which are located on the user interface. Alternatively, service port connections are possible via the transmitter infrared port. For more information on using the infrared port, refer to the transmitter configuration and use manual.

**Method 8: HART/Bell 202 temporary connection to HART clips**

*Note: This method is supported by Model 2400S transmitters that support HART communication.*

Using a VIATOR HART Interface, the PC can be connected directly to the HART clips on the face of the transmitter. Figure 2-9 shows the wiring for connection to the HART clips.

1. At the PC, attach the VIATOR HART Interface to the PC’s serial or USB port, using a 25-pin to 9-pin adapter if necessary.
2. At the transmitter, remove the housing cover.
3. Connect the HART interface leads to the HART clips.

**Figure 2-9 HART/Bell 202 connection to HART clips**

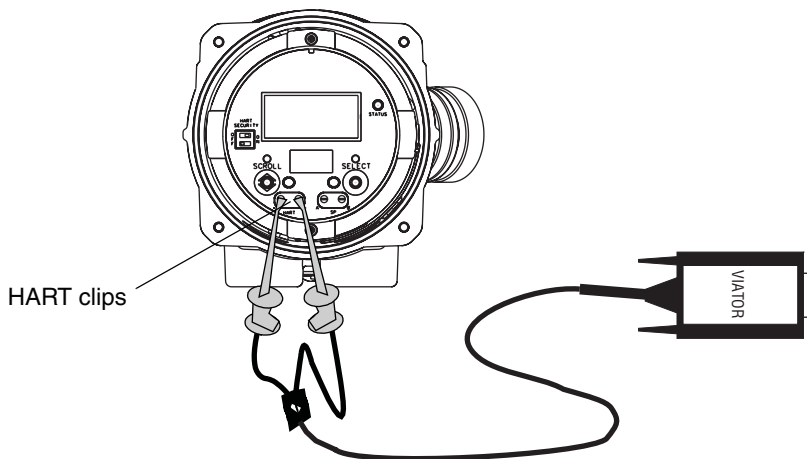

4. If necessary, add a resistance across the HART clips. The VIATOR HART interface must be connected across a resistance of 250–600 Ω. Note that the HART clips use the same circuit as the mA output, so the required resistance may already be installed if the mA output loop is connected to a remote device or a HART network (see Figure 2-1).

## Installation and Setup

### Method 9: Modbus/RS-485 temporary connection to MVD Direct Connect

Using a Black Box signal converter, the PC can be connected directly to the RS-485 terminals on the core processor or the MVD Direct Connect I.S. barrier.

1. At the PC, attach the Black Box signal converter to the PC's serial or USB port, using a 25-pin to 9-pin adapter if necessary.
2. If connecting to the core processor, remove the lid.
3. Connect the signal converter leads to the RS-485 terminals. See Table 2-12, and:
  - For connecting to the standard core processor, see Figure 2-10.
  - For connecting to the enhanced core processor, see Figure 2-11.
  - For connecting to the I.S. barrier, see Figure 2-12.

*Note: The Modbus protocol allows only one Modbus master to be active on the network at any given time. If you are connecting through a network, ensure that no other Modbus master devices are currently active.*

*Note: Before using ProLink II to communicate with the core processor, disconnect any wiring to a remote PLC. Be careful not to disconnect the power supply wiring. After using ProLink II to communicate with the core processor, reconnect the wiring to the remote PLC.*

**Table 2-12 Lead-to-terminal assignments – Method 9**

| Device                        | Terminals |          |
|-------------------------------|-----------|----------|
|                               | RS-485/A  | RS-485/B |
| I.S. barrier <sup>(1)</sup>   | 13        | 14       |
| Core processor <sup>(2)</sup> | 3         | 4        |

(1) Connection is intrinsically safe.

(2) Connection is not intrinsically safe.

**Figure 2-10 Modbus/RS-485 connection to RS-485 terminals on standard core processor**

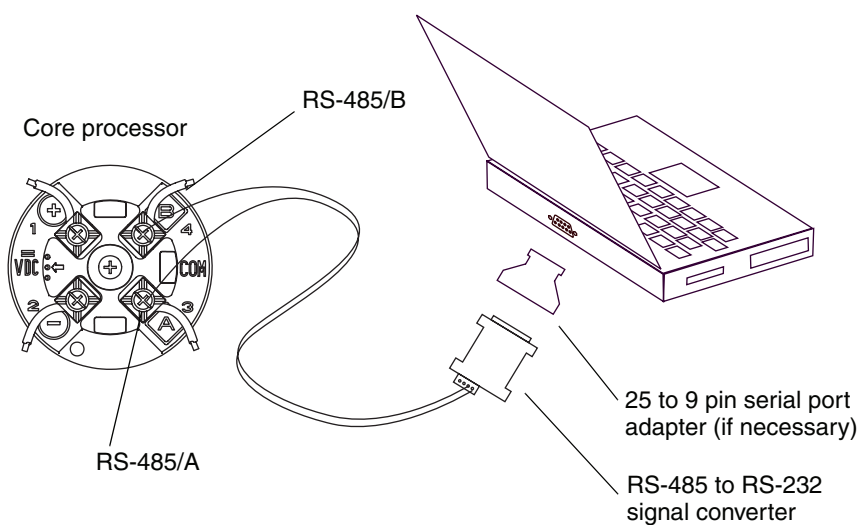

Figure 2-11 Modbus/RS-485 connection to RS-485 terminals on enhanced core processor

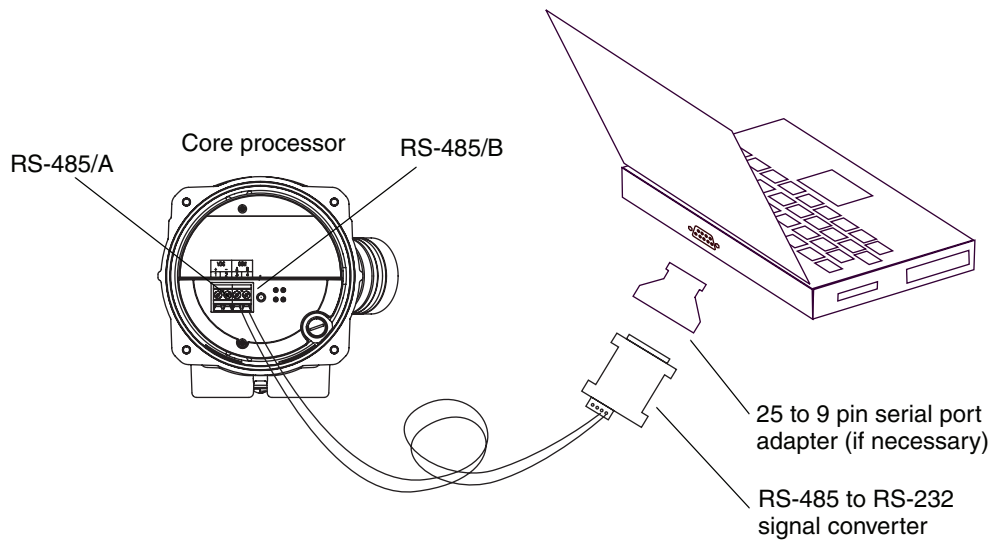
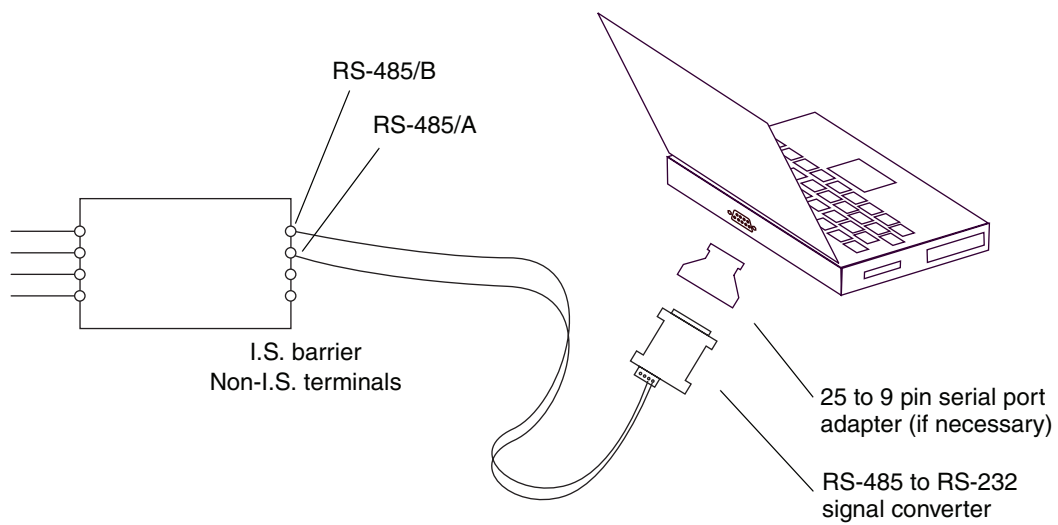

Figure 2-12 Modbus/RS-485 connection to RS-485 terminals on I.S. barrier



### 2.2.6 Configure ProLink II connection parameters and connect to the transmitter

To connect to the transmitter, ProLink II must use connection parameters appropriate to the transmitter.

- If you are connecting to an MVD Direct Connect system, ProLink II can use any of the supported communication settings listed in Table 2-13. The core processor auto-detects incoming communications parameters and switches to match.
- If you are connecting to a Model 2400S transmitter using the service port:
  - For point-to-point connections, you can use a service port connection type.
  - For multidrop network connections, you can use any Modbus/RS-485 connection type and specify the transmitter's Modbus address. The transmitter auto-detects incoming communications parameters and switches to match. The service port auto-detection limits are described in Table 2-14.
- If you use a service port or HART/Bell 202 connection type, the connection parameters are standard: when one of these connection types is specified, ProLink II automatically uses the appropriate parameters.
  - HART/Bell 202 connections are always available on all transmitters.
  - Service port connections are always available for all Model 1700/2700 transmitters and for all Model 2400S transmitters.
  - For Model 1500/2500 transmitters and Series 3000 transmitters, the RS-485 terminals are accessible as a service port for a 10-second interval after power-up:
    - If a service port connection is made during this interval, the port will remain in service port mode indefinitely until power is cycled.
    - If no service port connection is made during this interval, the terminals switch to Modbus/RS-485 mode, and must be accessed using the RS-485 communication settings configured in the transmitter.
- If you use any other connection type, you must configure ProLink II connection parameters to match the transmitter's configuration. If you do not know the transmitter's configuration, you can use a Communicator or the transmitter's display to view or change its configuration.
  - For all transmitters, if you are using HART protocol, you can specify the transmitter's HART tag (software tag) instead of the HART address, if a HART tag has been configured in the transmitter.
  - For all Series 1000/2000/3000 transmitters, see Table 2-15 for default values for each connection type.
  - For IFT97xx transmitters, communication parameters are not configurable. Settings are listed in Table 2-16. Configure ProLink II connection parameters to match these settings.
  - For RFT97xx transmitters, communication is configured using switches and jumpers on the transmitter. Check your transmitter and refer to the transmitter manual to determine your transmitter's configuration, then configure ProLink II connection parameters to match these settings. Factory default settings for these transmitters are listed in Table 2-16.

For a discussion of the advantages of each connection type, see Section 3.3.1.



**Table 2-13 MVD Direct Connect auto-detection limits**

| Parameter | Option                                     |
|-----------|--|
| Protocol  | Modbus RTU (8-bit)<br>Modbus ASCII (7-bit) |
| Baud rate | Standard rates between 1200 and 38,400     |
| Parity    | Even, odd, none                            |
| Stop bits | 1, 2                                       |

**Table 2-14 Model 2400S service port auto-detection limits**

| Parameter | Option  |
|-----------|---|
| Protocol  | Modbus RTU (8-bit)<br>Modbus ASCII (7-bit)  |
| Address   | Responds to both: <ul style="list-style-type: none"> <li>• Service port address (111)</li> <li>• Configured Modbus address (default=1)</li> </ul> |
| Baud rate | Standard rates from 1200 to 38,400  |
| Stop bits | 1, 2  |
| Parity    | Even, odd, none   |

**Table 2-15 Default communication parameters for Series 1000/2000/3000 transmitters**

| Transmitter                          | Physical layer             | Protocol              | Baud        | Default values           |             |             |         |
|--------------------------------------|----------------------------|-----------------------|-------------|--------------------------|-------------|-------------|---------|
|                                      |                            |                       |             | Data bits <sup>(1)</sup> | Stop bits   | Parity      | Address |
| Model 1500/2500                      | Bell 202 <sup>(2)(3)</sup> | HART <sup>(4)</sup>   | 1200        | 8                        | 1           | odd         | 0       |
|                                      | RS-485 <sup>(5)</sup>      | Modbus RTU            | 9600        | 8                        | 1           | odd         | 1       |
| Model 1700/2700 AN                   | Bell 202 <sup>(2)</sup>    | HART <sup>(4)</sup>   | 1200        | 8                        | 1           | odd         | 0       |
|                                      | RS-485 <sup>(5)(6)</sup>   | HART                  | 1200        | 8                        | 1           | odd         | 0       |
| Model 1700/2700 IS<br>Model 2700 CIO | Bell 202 <sup>(2)</sup>    | HART <sup>(4)</sup>   | 1200        | 8                        | 1           | odd         | 0       |
| Model 2400S AN                       | Bell 202 <sup>(2)</sup>    | HART <sup>(4)</sup>   | 1200        | 8                        | 1           | odd         | 0       |
|                                      | RS-485                     | Modbus (RTU or ASCII) | Auto-detect | Auto-detect              | Auto-detect | Auto-detect | 1       |
| Series 3000                          | Bell 202 <sup>(2)</sup>    | HART <sup>(4)</sup>   | 1200        | 8                        | 1           | odd         | 0       |
|                                      | RS-485 <sup>(5)</sup>      | Modbus RTU            | 9600        | 8                        | 1           | odd         | 1       |

(1) ProLink II automatically sets data bits appropriately for the configured protocol. Even though a data bits parameter may be configured in the transmitter, you do not need to configure it in ProLink II. HART protocol is always 8 data bits. If your transmitter is configured for Modbus with 7 data bits, specify Modbus ASCII; if your transmitter is configured for Modbus with 8 data bits, specify Modbus RTU.

(2) Connection to primary mA output, or to HART clips (Model 2400S transmitters only).

(3) Except Model 1500 transmitter with the Filling and Dosing application. The Model 1500 transmitter with the Filling and Dosing application does not support Bell 202 / HART communication.

(4) HART/Bell 202 parameters are not configurable. The settings shown here are always in effect.

(5) Connection to RS-485 terminals.

(6) Available only on Model 1700/2700 transmitters with analog outputs.

**Table 2-16 Default communication parameters for RFT97xx and IFT97xx transmitters**

| Transmitter                 | Physical layer           | Default values |      |                          |           |        |         |
|-----------------------------|--------------------------|----------------|------|--------------------------|-----------|--------|---------|
|                             |                          | Protocol       | Baud | Data bits <sup>(1)</sup> | Stop bits | Parity | Address |
| IFT9701/9703 <sup>(2)</sup> | Bell 202 <sup>(3)</sup>  | HART           | 1200 | 8                        | 1         | odd    | 0       |
| RFT9712                     | Bell 202 <sup>(3)</sup>  | HART           | 1200 | 8                        | 1         | odd    | 0       |
|                             | RS-485 <sup>(4)</sup>    | HART           | 1200 | 8                        | 1         | odd    | 0       |
| RFT9739 v2                  | Bell 202 <sup>(3)</sup>  | HART           | 1200 | 8                        | 1         | odd    | 0       |
|                             | RS-485 <sup>(4)</sup>    | HART           | 1200 | 8                        | 1         | odd    | 0       |
| RFT9739 v3                  | Bell 202 <sup>(3)</sup>  | HART           | 1200 | 8                        | 1         | odd    | 0       |
|                             | RS-485 <sup>(4)(5)</sup> |                |      |                          |           |        |         |
|                             | • Std. comm              | Modbus RTU     | 9600 | 8                        | 1         | odd    | 1       |
|                             | • User defined           | HART           | 1200 | 8                        | 1         | odd    | 0       |

(1) ProLink II automatically sets data bits appropriately for the configured protocol. Even though a data bits parameter may be configured in the transmitter, you do not need to configure it in ProLink II.

(2) IFT9701/9703 communication parameters are not configurable. The settings shown here are always in effect.

(3) Connection to primary mA output.

(4) Connection to RS-485 terminals.

(5) Dip switch settings on the transmitter are used to select either Std. comm or User defined.

To make the software connection from ProLink II to your transmitter.

1. Ensure that your PC is connected to the transmitter, according to one of the methods described in Section 2.2.5.
2. Start ProLink II software.
3. From the **Connection** menu, click on **Connect to Device**.
4. Specify connection parameters:
  - Use the **Protocol** parameter to specify your connection type. For HART/Bell 202 connections using the VIATOR USB HART Interface, enable **Converter Toggles RTS**.
  - Set **Serial Port** to the PC COM port you are using to connect to the transmitter.
  - If you are making a service port or HART/Bell 202 connection, default values are used for all remaining connection parameters.
  - If you are connecting to MVD Direct Connect, set the remaining connection parameters to any of the supported settings listed in Table 2-13.
  - For all other connection types:
    - For Model 2400S transmitters, set the address to the Modbus address configured for your transmitter.

*Note: Due to the transmitter's auto-detection feature, other connection parameters are not required.*

- For all other transmitters, set the remaining connection parameters to the values configured in your transmitter.

5. If you are making a service port connection to a Model 1500/2500 transmitter or a Series 3000 transmitter:
  - a. Power down the transmitter.
  - b. Restore power to the transmitter.
  - c. Wait 1–5 seconds. On the Series 3000, wait until the display begins to flash.
6. Click the **Connect** button. ProLink II will attempt to make the connection.
7. If an error message appears, see Section 2.4.

### 2.2.7 Obtain and configure a site key

To obtain and configure a site key:

1. Open the License Request file as follows:  
**Start > Programs > MMI > ProLink II v2.5 > ProLink II License Request Form**
2. Edit the file, supplying all requested information including the site code.  
The site code is provided in the **License** window (see Figure 2-13). The **License** window can be opened from the ProLink II **File** menu.

*Note: To minimize the possibility of error, Micro Motion recommends copying and pasting the site code, rather than typing the value.*

3. Save the edited file.
4. Contact Micro Motion in one of the following ways:
  - Send an email to:  
**ProLink.Support@EmersonProcess.com**  
and attach the edited file to the email. The file is named **LicenseRequest.txt**, and in typical installations is located in **Program Files > MMI > ProLink II v2.5**.

*Note: This is the default location. If the ProLink II installation program found an existing license file, the program and License Request file were installed in the location of the license file.*

- Telephone 800-522-6277 (toll-free in the U.S.), or 303-530-8350 (worldwide), and request a site key. Have the edited registration text file available for reference.

*Note: To minimize the possibility of error, Micro Motion recommends using the email method.*

5. When the site key is provided:
  - a. Start ProLink II.
  - b. From the **File** menu, click **License**. The window shown in Figure 2-13 is displayed.

Figure 2-13 License window



- c. Enter the site key into the **Site Key** textbox, then click the **Validate** button.

*Note: To minimize the possibility of error, Micro Motion recommends copying and pasting the site key, rather than typing the value.*

## 2.3 Troubleshooting the ProLink II installation

If you have problems with the ProLink II installation, review the information in this section and follow the suggestions. If you cannot resolve the problem, contact Micro Motion customer support.

### 2.3.1 Insufficient privileges

If you are unable to install ProLink II on a Windows NT, Windows 2000, or Windows XP system, verify that you have the required privileges (see Section 2.2.1). On Windows NT, you must be logged on as Administrator to perform the ProLink II installation.

### 2.3.2 Missing or corrupt registry entries

During a successful ProLink II installation, information is written to the Windows registry. If, for any reason, ProLink II information in the registry is corrupted or missing, you can replace or update the required information as follows:

1. Click **Start > Programs > MMI > ProLink II v2.5 > ProLink II Registrar**.
2. A batch file that updates the Windows registry will be executed. Click **OK** as required by the pop-up messages.
3. Close the command window.

*Note: To run the batch file on Windows NT, Windows 2000, or Windows XP systems, you must be authorized to write to the registry.*

## 2.4 Troubleshooting the ProLink II connection

If you cannot connect to the transmitter, review the information in this section and follow the suggestions. If you cannot resolve the problem, contact Micro Motion customer support.

### 2.4.1 OPC server or OPC client issues

If the Context message displays either of the following:

**The OPC server could not be started.**

**The OPC client database could not be opened.**

reinstall ProLink II, ensuring that you have the required privileges (see Section 2.2.1). On Windows NT, you must be logged on as Administrator to perform the ProLink II installation.

### 2.4.2 Other issues

If the Context message displays either of the following:

**The serial port could not be opened, or the device did not respond. Port availability and connection wiring should be checked.**

**An unexpected error code was returned.**

try the following:

1. Check all the wiring between the PC and the transmitter, and ensure that all components are powered up. See the setup information for your connection type in Section 2.2.5, or refer to the transmitter manual.
2. Check all the connection parameters – baud rate, parity, stop bits, protocol, address, and COM port – and ensure they are correct for both ProLink II and the transmitter.
3. Click **Start > Programs > MMI > ProLink II v2.5 > ProLink II Registrar**. This program updates registry entries.
4. Ensure that ProLink II is configured for the correct COM port. To do this, install the LED indicator/tester. (If you purchased the ProLink II installation kit from Micro Motion, this device was included.) Attempt a connection.
  - The indicators for the TD, RD, DTR, and RTS lines should be ON. Usually they are red, but if another program has used the COM port the RTS indicator may be green. If no indicators are ON, you are not connected to the COM port, ProLink II is configured for the wrong COM port, or there is a wiring problem.
  - When you try to connect, verify that the RTS LED changes color or flashes. If no LED change is detected, you are connected to the wrong COM port or the COM port isn't assigned correctly. Check the device manager on your PC for the proper COM port configuration.
5. Make sure that you don't have interference over the COM port. Other programs or devices may be trying to use the COM port. If the TD light is flashing while you are not using ProLink II, the COM port is in use by another program. Terminate the other program and try again.
6. If you use the configured COM port for any other program, verify that the other program is not currently running. Personal digital assistants (PDAs) often have automatic update programs that use the COM ports continually.
7. For HART connections to Model 1700/2700 transmitters with the intrinsically safe outputs option board, ensure that the terminals are externally powered.

## Installation and Setup

8. Try adding resistance to the connection.
  - For HART connections, refer to the installation instructions earlier in this chapter. Verify that there is a 250–600  $\Omega$  resistor in parallel in the communications circuit.
  - For HART connections to Model 1700/2700 transmitters with the intrinsically safe outputs option board, ensure that the resistor is in series. Attach the modem **across** the resistor.
  - RS-485 connections may require added resistance if the connection is long-distance or if there is external noise that interferes with the signal. Add two 120- $\Omega$  resistors in parallel with the output, one at each end of the communication segment.
9. For RS-485 connections, swap the leads between the two terminals and try again.
10. For Modbus network connections, ensure that ProLink II is the only Modbus master active on the network.
11. For RS-485 connections, try connecting through the service port, if available on your transmitter.
12. For HART/Bell 202 connections:
  - a. If burst mode is enabled, try disabling it.
  - b. Ensure that polling for external pressure/temperature is disabled.
  - c. Ensure that ProLink II is the only master on the network.
13. For HART connections using the VIATOR USB HART Interface:
  - a. Ensure that you have checked the box labeled **Converter Toggles RTS** in the ProLink II **Connect** window.
  - b. Ensure that the required Windows driver is installed on your PC. If this driver is not installed, Windows will not recognize the USB converter when it is plugged into the USB port.
14. For connections to the Model 2400S transmitter, if you are using Modbus ASCII protocol with an RS-485 connection rather than a service port connection, ensure that Modbus ASCII support is enabled on your transmitter.

# Chapter 3

## Using ProLink II Software

### 3.1 Overview

This chapter provides information on the ProLink II user interface, including:

- Starting ProLink II and connecting to a transmitter (see Section 3.3)
- The ProLink II help system (see Section 3.4)
- Viewing installed options (see Section 3.5)
- Viewing process data (see Section 3.6)
- Viewing and resetting totalizers and inventories (see Section 3.7)
- Viewing status and alarms (see Section 3.8)
- Managing the ProLink II license (see Section 3.10)

### 3.2 ProLink II user interface

ProLink II software is designed to be easy to use in a Windows environment. ProLink II uses standard Windows methods for viewing and selecting options.

### 3.3 Startup

ProLink II can be started from the Windows Start menu, where it is usually found in the MMI program group. You can also define a desktop shortcut for running ProLink II.

When ProLink II first starts up, the ProLink II main screen and **Connect** dialog box are displayed (see Figure 3-1). Until you connect to a transmitter, most of the menu options are disabled.

Figure 3-1 ProLink II main window and Connect dialog box

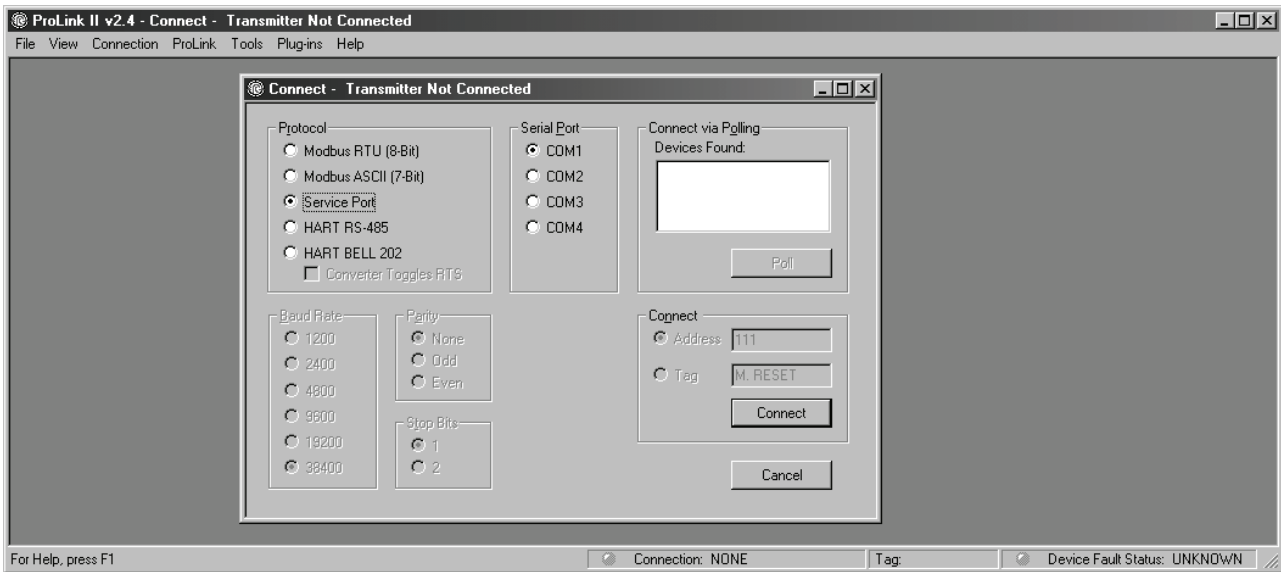

### 3.3.1 Connecting to a transmitter

Depending on your transmitter, you may have several different options for making the connection from ProLink II to the transmitter. Review the following connection guidelines when selecting your connection method. Instructions for making the connection are provided following the guidelines.

#### Connection guidelines

- You must have the appropriate signal converter for the connection type you choose. See Section 2.2.5.
- Modbus connections are faster than HART connections.
- Using a HART connection from ProLink II, you cannot have more than one client window open at a time.
- Service port connections
  - Service port connections are available on all MVD transmitters.
  - Service ports use standard connection parameters, so you do not have to know the transmitter’s configuration.
  - ProLink II uses Modbus protocol for service port connections, which is the fastest protocol available.
  - On Model 1700/2700 transmitters and Model 2400S transmitters, the service port is always available.
  - On Model 1500/2500 transmitters and Series 3000 transmitters, the service port is available only for ten seconds after power-up. For service port access, you will have to power down the transmitter, which may not be acceptable in your installation.
  - On Series 1700/2700 transmitters, you must open the wiring compartment to access the service port. On Model 2400S transmitters, you must remove the housing cover. Therefore, on these transmitters the service port is appropriate only for temporary connections.



- HART/Bell 202 connections
  - HART/Bell 202 connections are available on all transmitters that have an mA output, except the Model 1500 with the Filling and Dosing application. The transmitter Model 1500 with the Filling and Dosing application does not support HART communication.
  - HART/Bell 202 connections use standard connection parameters, so you don't have to know the transmitter's configuration.
  - Because the HART/Bell 202 connection is made over the primary mA output terminals, the communication signal can interfere with certain procedures such as loop testing, and may cause the output to change. Depending on how the primary mA output is being used, this may have significant consequences for process control.
  - Depending on the transmitter and wiring method, HART/Bell 202 connections may be appropriate for both temporary and permanent connections.
- RS-485 connections
  - RS-485 connections are not available on all transmitters.
  - To use an RS-485 connection, you must know the transmitter's configuration.
  - RS-485 connections are appropriate for both temporary and permanent connections.

### Making the connection

1. Ensure that your PC is connected to a transmitter, using one of the methods described in Chapter 2.
2. If the **Connect** dialog box is not displayed:
  - a. Open the **Connection** menu.
  - b. Click on the **Connect** option.
3. Select the protocol to use. Depending on the **Protocol** option that you choose, different communications options will be available for configuration.

*Note: Due to the design of HART protocol, connections made using HART protocol are slower than connections that use Modbus protocol. If you use HART protocol, you cannot open more than one ProLink II window at a time.*

*Note: Windows NT does not support USB connections.*

*Note: If you are using a service port connection to a Model 1500/2500 transmitter or a Series 3000 transmitter, see Section 2.2.6 for instructions on making this connection.*

4. Specify **Baud Rate**, **Parity**, **Stop Bits**, **COM Port**, and **Address/Tag** as appropriate for your connection and transmitter. See Section 2.2.6 for more information on these parameters.

*Note: If you are using HART protocol and a HART tag (software tag) has been configured for your transmitter, you can specify the HART tag instead of the HART address.*

5. If you are using the Viator USB HART Interface, enable **Converter Toggles RTS**.
6. Click the **Connect** button.

*Note: ProLink II can connect to only one transmitter at a time. To connect to another transmitter, you must first disconnect from the current connection.*

### Polling for devices

If you do not know the address of your transmitter:

1. Click the **Poll** button. ProLink II will poll the network for all Micro Motion transmitters, and display a list of all transmitters found.
2. Select the transmitter to connect to, and click **OK**.

### 3.3.2 Disconnecting

To disconnect from the currently connected transmitter:

1. Open the **Connection** menu.
2. Click on the **Disconnect** option.

### 3.4 ProLink II help system

ProLink II provides context-sensitive help for most windows and dialog boxes.

- To access the complete help system, click on **Help**.
- To access help for a specific window or dialog box, make the object active, then press F1.

### 3.5 Viewing installed options

A Series 1000/2000/3000 transmitter can be purchased with several application options. To view the list of installed options:

1. Open the **View** menu.
2. Click on **Installed Options**. A window similar to Figure 3-2 is displayed. In this window, the installed options are indicated with a checkmark.

Figure 3-2 Installed Options window

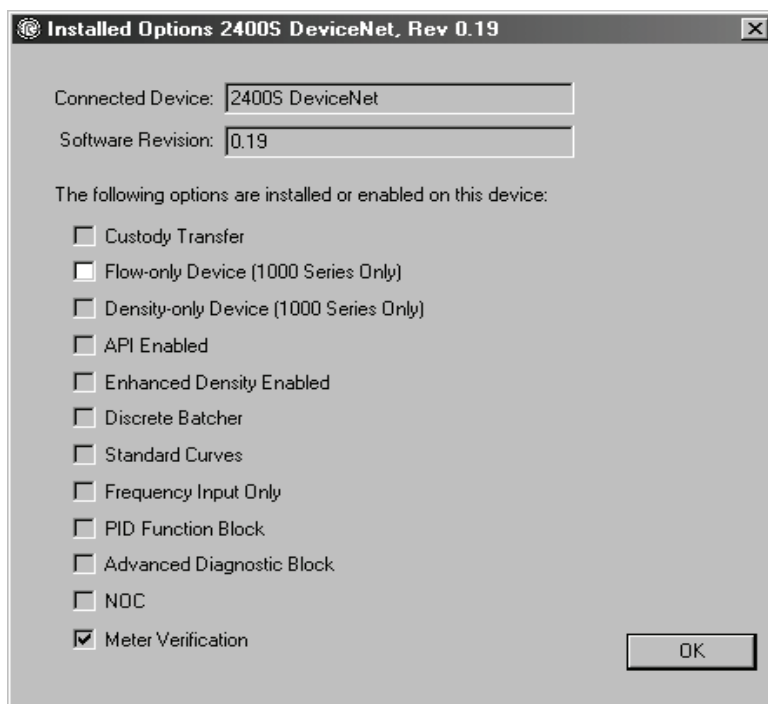

### 3.6 Viewing process data

ProLink II provides the following windows for viewing process data and related information:

- **Process Variables** window
- **Output Levels** window
- **Totalizer Control** window

The following windows are available if the associated option has been installed on the transmitter:

- **API Process Variables** window
- **ED (Enhanced Density) Process Variables** window

All of these windows are opened from the **ProLink** menu. For information on the data displayed in these windows, see the transmitter manual, the application manual, or the ProLink II help system (see Section 3.4).

### 3.7 Viewing and resetting totalizers and inventories

The **Totalizer Control** window is used to:

- View current values of the totalizers and inventories
- Start, stop, and reset totalizers
- Reset inventories
- Reset frequency input total (Series 3000 transmitters only)

If the enhanced density application is available and enabled in the transmitter, the **ED Totalizer Control** window is used to view and control totalizers and inventories related to the enhanced density application.

Inventories can be reset only if this function is enabled in the **Preferences** menu.

To enable inventory reset:

1. Open the **View** menu.
2. Click on **Preferences**.
3. Ensure that **Enable Inventory Totals Reset** is checked.
4. Click the **Apply** button if necessary.

To manage totalizers and inventories:

1. Open the **ProLink** menu.
2. Click on **Totalizer Control** or **ED Totalizer Control** (if the enhanced density application is enabled in the transmitter). A window similar to Figure 3-3 is displayed.
3. Use the buttons in this window to start, stop, or reset the totalizers and/or inventories.

*Note: The **Start**, **Stop**, and **Reset** buttons displayed under All Totals affect the mass totalizer, the volume totalizer, and all API-related totalizers.*

4. The **Reset Inventories** button under All Totals is displayed only if this function is enabled (see above). Use this button to reset all inventories, including API-related inventories.

*Note: ProLink II does not support separate resetting of the API volume totalizer and API volume inventory. To reset these, you must reset all totalizers or all inventories.*

Figure 3-3 Totalizer Control window

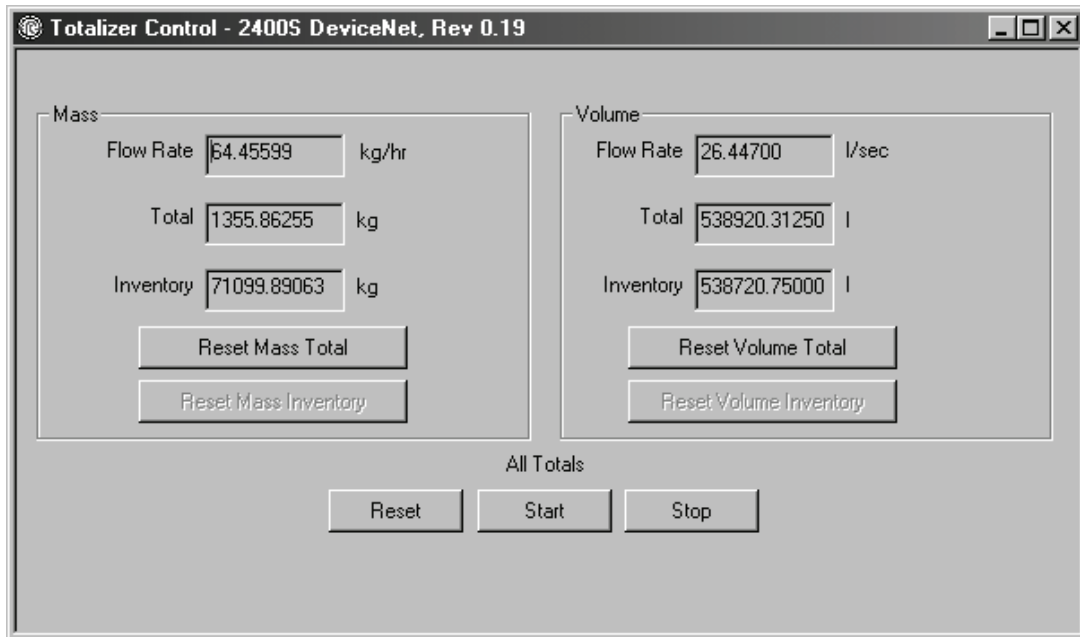

### 3.8 Viewing meter status

ProLink II allows you to view a variety of status information:

- **Connection LED** – located in the lower right corner of the main window (see Figure 3-1). This LED indicates the status of the connection between ProLink II and the transmitter:
  - Green – Good connection
  - Red – Connection fault
  - Gray – No connection
- **Device Fault Status LED** – located in the lower right corner of the main window (see Figure 3-1). This LED indicates whether or not alarms are active:
  - Green – No active alarms
  - Red – One or more active alarms
  - Gray – Unknown

See Section 3.9 for more information about alarms.

- **Diagnostic Information** window – displays sensor diagnostic data
- **Output Levels** window – displays current data for the transmitter’s mA, frequency, and discrete outputs, and also displays discrete event status
- **Status** window – displays alarm status. See Section 3.9 for more information about alarms.
- **Alarm Log** window – displays alarm status and alarm acknowledgment status. See Section 3.9 for more information about alarms.

- **Core Processor Diagnostics** window – displays detailed diagnostic data for the core processor component

*Note: The Core Processor Diagnostics window is always available for viewing. However, the Secure option is required on the ProLink II license in order to make changes and update the device from this window.*

- **FingerPrint** window – displays detailed information for both process variable data and sensor diagnostic data

### 3.9 Viewing and acknowledging alarms

The transmitter sets alarms whenever a process variable exceeds its defined limits or when the transmitter detects a fault condition.

#### 3.9.1 Viewing alarms

There are two ways to view alarms:

- Using the **Status** window (see Figure 3-4). In this window, alarms are organized into three panels: **Critical**, **Informational**, and **Operational**. If an alarm is active, the associated tab is highlighted. In each panel, active alarms are indicated with red lights; inactive alarms are indicated with green lights. This window displays only current alarm data and does not display alarm history.
- Using the **Alarm Log** window (see Figure 3-5). In this window, alarms are organized into two panels: **High Priority** and **Low Priority**. These panels list all active alarms and all alarms that are no longer active but have not been acknowledged:
  - A red light indicates a currently active alarm.
  - A green light indicates an alarm that is no longer active but has not been acknowledged.

*Note: The organization of alarms in the Status and Alarm Log windows is predefined and is not configurable. It is not affected by configured alarm severity.*

*Note: For information about a specific alarm condition, see your transmitter manual.*

Figure 3-4 Status window

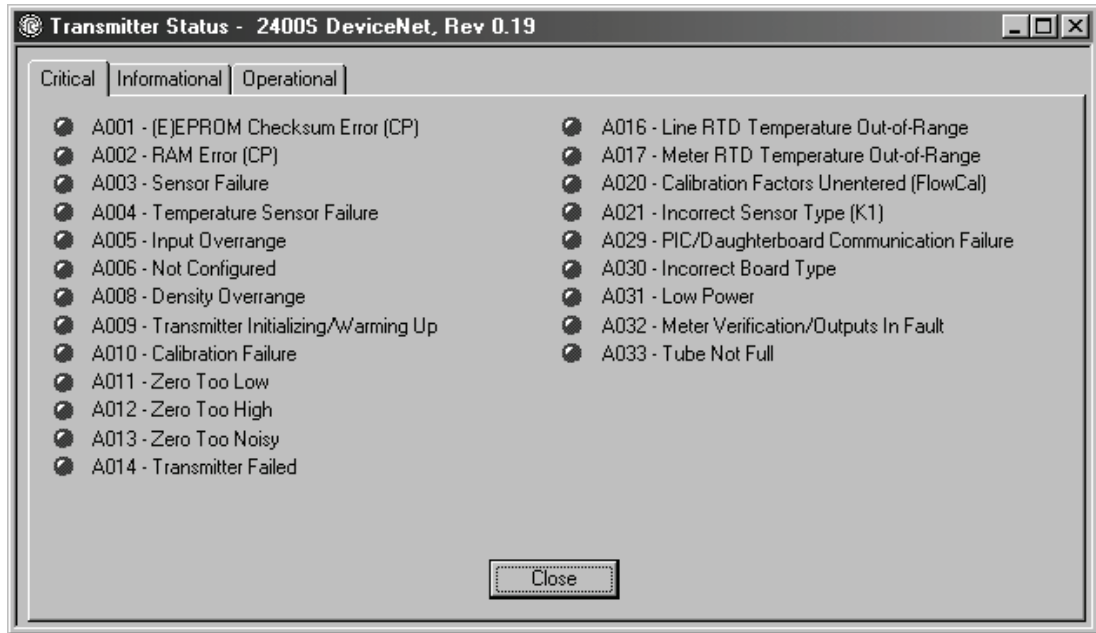
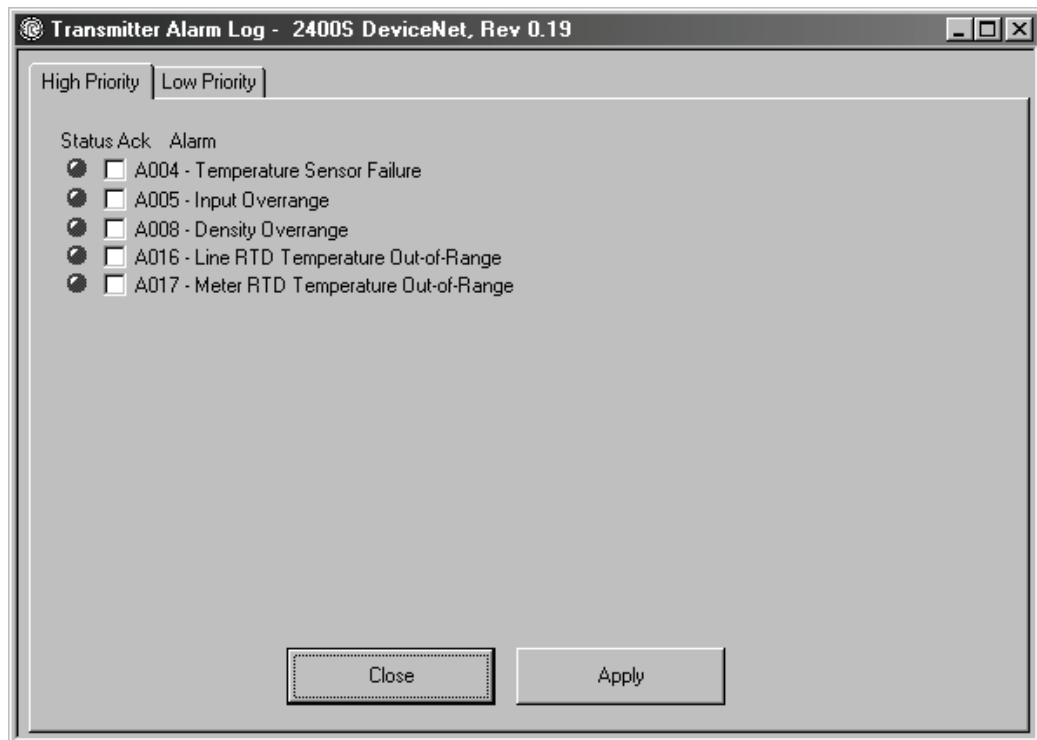

Figure 3-5 Alarm Log window



### 3.9.2 Acknowledging alarms

To acknowledge an alarm using ProLink II, you must use the **Alarm Log** window. You cannot acknowledge alarms from the **Status** window.

To acknowledge an alarm:

1. Open the **Alarm Log** window.
2. Check the **Ack** checkbox for each alarm you want to acknowledge.
  - If the alarm is no longer active (green light), the alarm will be cleared from the list, and the **Alarm Log** window will be updated as soon as new data is received from the transmitter.
  - If the alarm is still active (red light), the red light will remain, but the name of the alarm will be grayed out. The alarm will be cleared from the list as soon as it is no longer active.

### 3.10 Managing the ProLink II license

Both the ProLink II temporary license and permanent license are keyed to a specific disk and a specific folder or directory on a specific PC. If you want to move the ProLink II installation, you must use the appropriate license transfer function:

- **To Directory** is used to transfer ProLink II to another location on the same PC.
- **Out of Computer** and **Into Computer** are used to transfer ProLink II to another PC.

#### 3.10.1 Transferring to same PC

To transfer ProLink II to another location on the same PC:

1. From the ProLink II **File** menu, open the **License** window.
2. Click **To Directory**.
3. Specify the directory to which ProLink II will be transferred.
4. Install ProLink II in the new directory, following the instructions in Section 2.2.2. As part of this procedure, you will be required to de-install the current installation.

#### 3.10.2 Transferring to different PC

1. At the target PC (the PC to which you are transferring):
  - a. Install ProLink II, following the instructions in Section 2.2.2.
  - b. In the new installation, open the **License** window.
  - c. Click **Into Computer** and supply a diskette when requested. ProLink II will write license transfer data to the diskette.
2. At the source PC (the PC where ProLink II is currently installed):
  - a. Start ProLink II and open the **License** window.
  - b. Click **Out of Computer** and insert the transfer diskette. ProLink II will copy the license to the transfer diskette. At this point, the license is no longer valid on the source PC.
3. At the target PC:
  - a. In the **License** window, click **Into Computer**.
  - b. Insert the transfer diskette. ProLink II will copy the license to the new installation, and you can begin using the program in the new location.





# Chapter 4

## Initial Transmitter Startup Procedures

### 4.1 Overview

The procedures described in this chapter should be performed the first time a transmitter is started. You can use ProLink II, the HART Communicator, AMS software, or the display to perform the procedures: the communications method does not matter.

The following procedures are described:

- Using ProLink II to perform a loop test on transmitter outputs (and inputs, if your transmitter has a discrete input or frequency input)
- Using ProLink II to trim the mA outputs
- Using ProLink II to zero the meter

*Note: The procedures in this chapter provide general methods for using ProLink II with your transmitter. For information on using the HART Communicator or the display, or for information specific to your transmitter such as the number and type of outputs, specific ranges for each output, etc., refer to the appropriate transmitter manual. Transmitter manuals are shipped with the transmitter, and are also available on the Micro Motion web site.*

*Note: Sections 4.2 and 4.3 do not apply to Series 2000 transmitters with Profibus-PA or FOUNDATION fieldbus.*

### 4.2 Loop tests

A *loop test* is a means to:

- Verify that outputs are being sent by the transmitter and received accurately by the receiving devices
- Determine whether or not you need to trim the mA outputs
- Verify that the discrete input or frequency input sent by an external device is being received correctly by the transmitter (if the transmitter has a discrete input or frequency input)

The ProLink II loop test options are shown in Figure 4-1. Different options are available with different transmitters.

## Initial Transmitter Startup Procedures

Figure 4-1 ProLink II loop test options

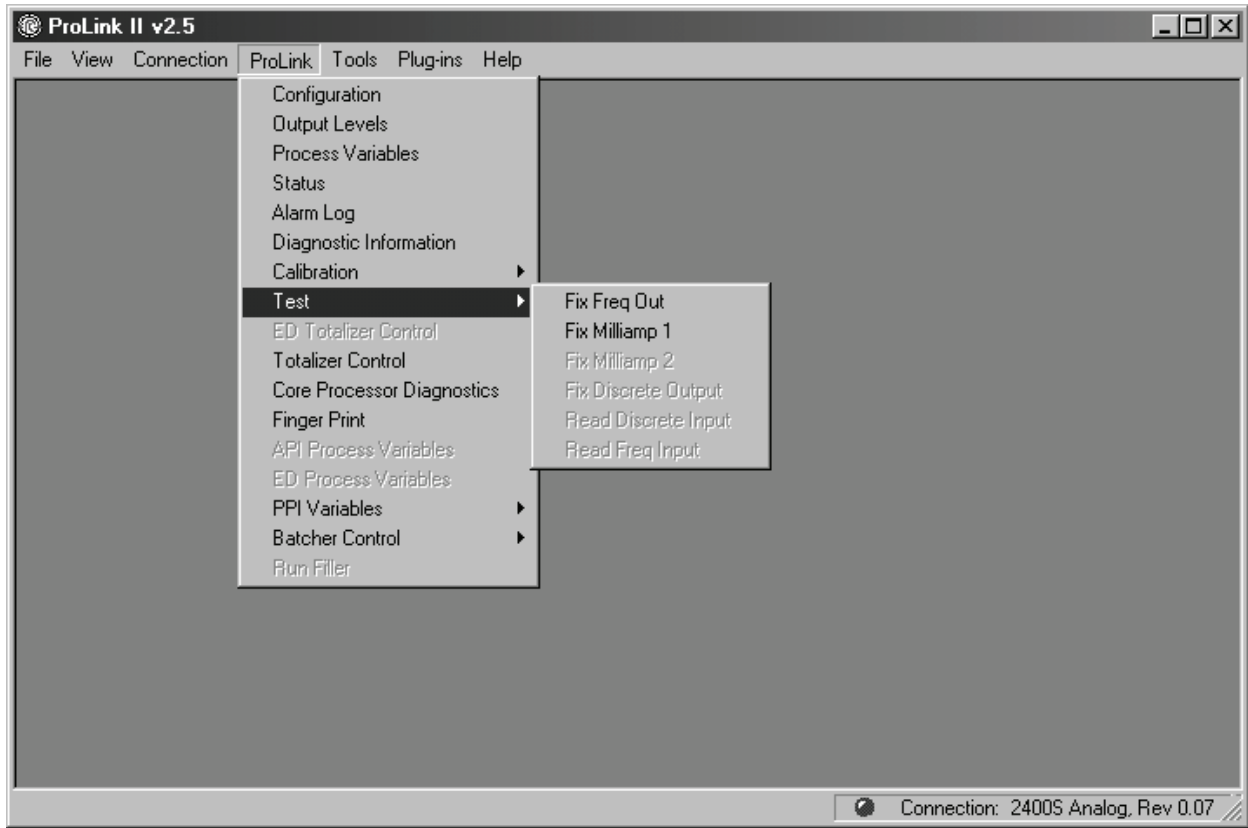

To perform loop tests with ProLink II, see Figure 4-2.

If you are testing an mA output, the mA reading does not need to be exact. You will correct differences when you trim the mA output. See Section 4.3.

Figure 4-2 ProLink II – Loop test procedure

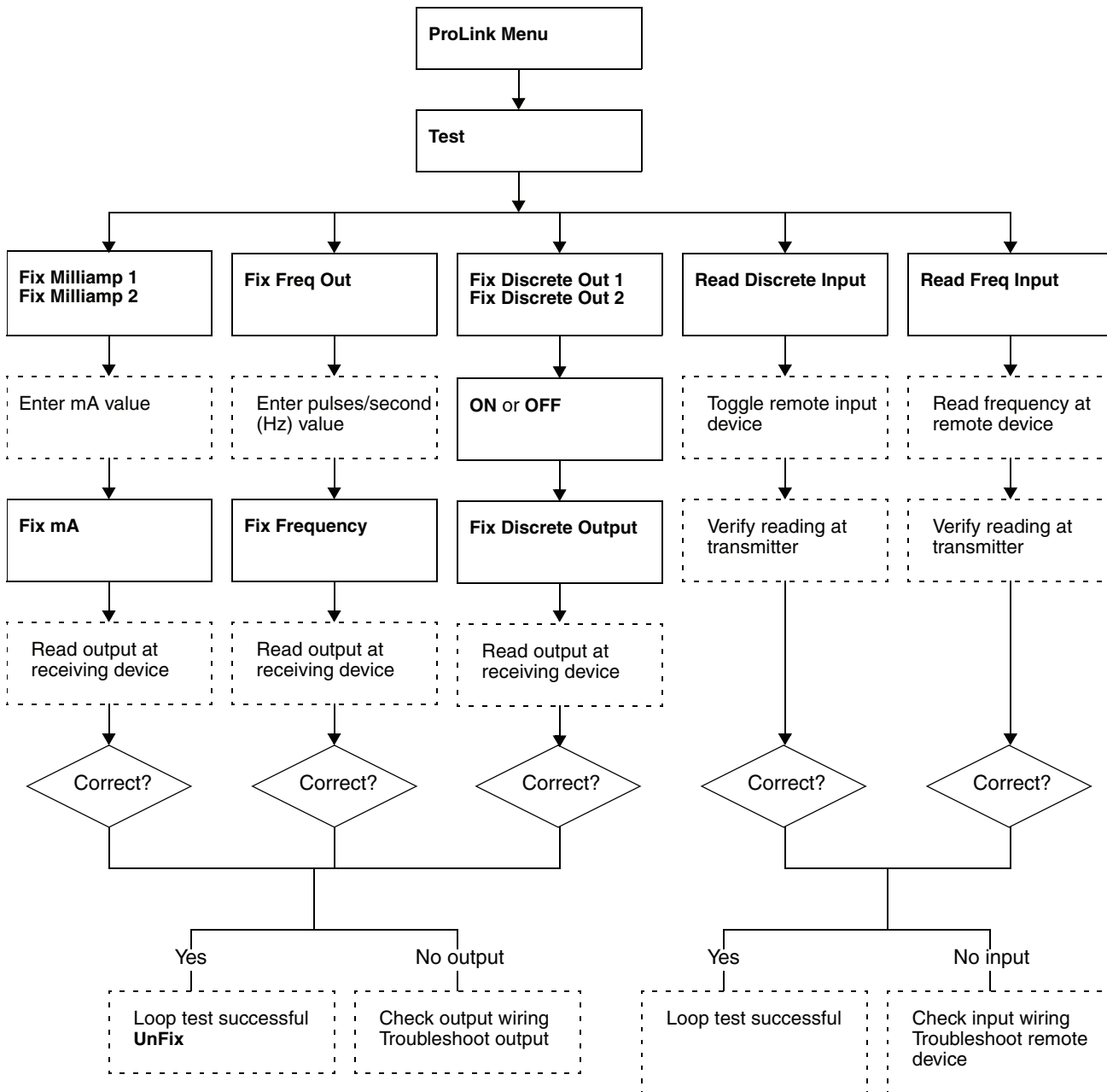

## Initial Transmitter Startup Procedures

### 4.3 Trimming the milliamp (mA) output(s)

*Trimming the mA output* creates a common measurement range between the transmitter and the device that receives the mA output. For example, a transmitter might send a 4 mA signal that the receiving device reports incorrectly as 3.8 mA. If the transmitter output is trimmed correctly, it will send a signal appropriately compensated to ensure that the receiving device actually indicates a 4 mA signal.

Note the following:

- If you have two mA outputs, you should trim both.
- You must trim the output at both the 4 mA and 20 mA points to ensure appropriate compensation across the entire output range.
- If you are trimming the primary mA output, and you are connected to the transmitter via the primary mA output (HART/Bell 202), the communication signal to ProLink II will affect the reading. Disconnect ProLink II before reading the output, then reconnect and resume the trim, after taking the reading. If you are using any other protocol, this is not required.
- Any trimming performed on the output should not exceed  $\pm 200$  microamps. If more trimming is required, contact Micro Motion customer support.

To trim the mA output with ProLink II:

1. Open the **ProLink** menu.
2. Click the **Calibration** option. The calibration options for the currently connected transmitter are displayed.

Figure 4-3 ProLink II calibration options

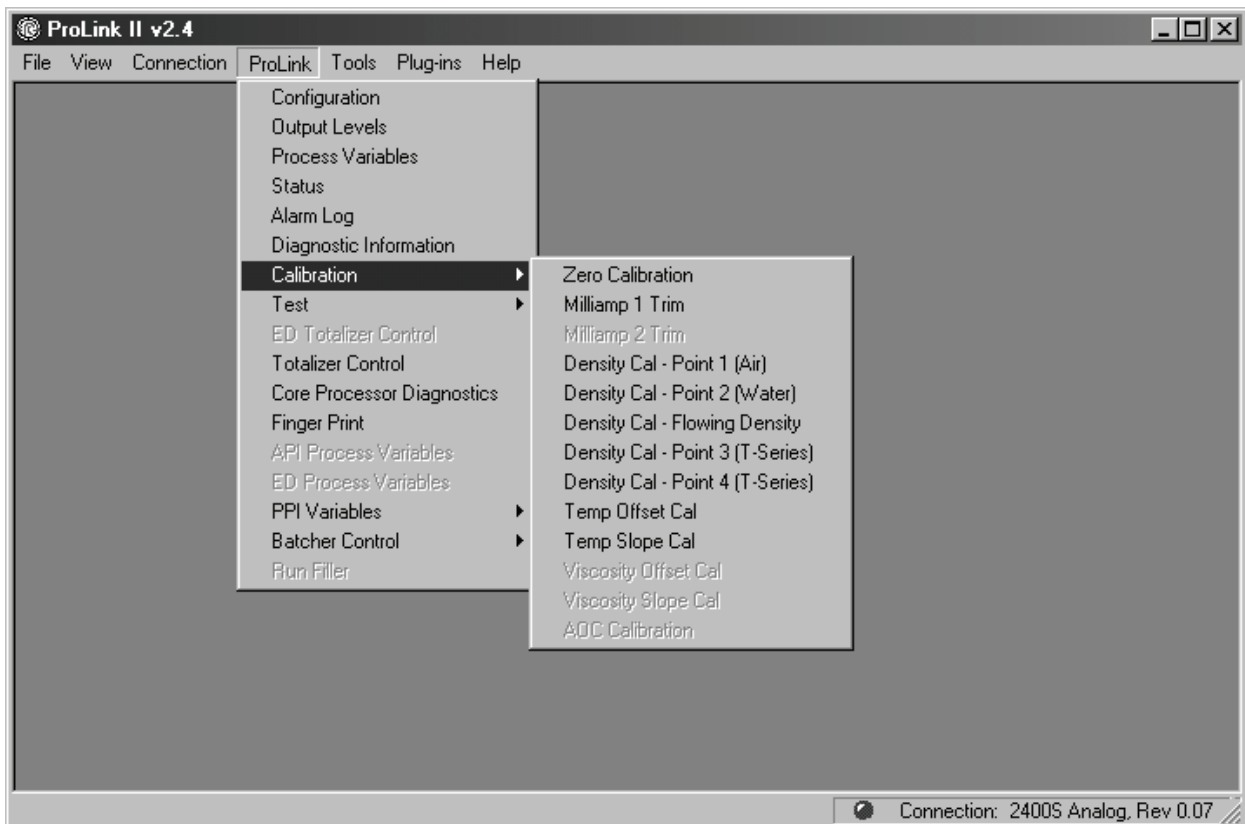

## Initial Transmitter Startup Procedures

3. Select **Milliamp 1 Trim** or **Milliamp 2 Trim**. The following screen is displayed:

Figure 4-4 Milliamp trim wizard – Screen 1

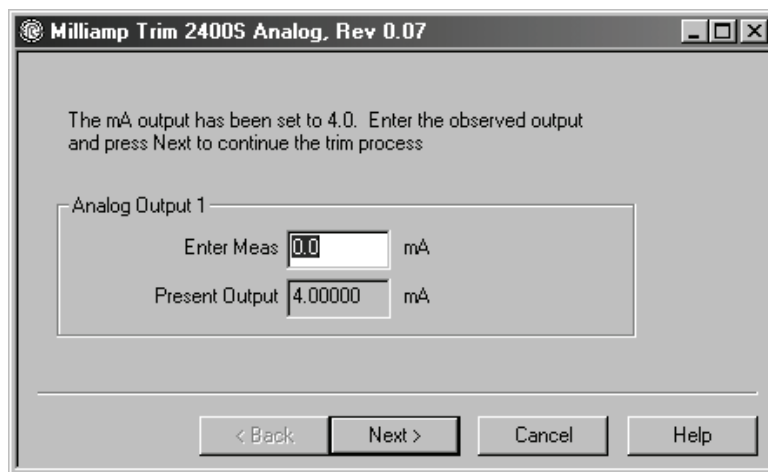

This screen allows you to compare the transmitter output (the **Present Output** value) to the output level being received at an external device.

4. Read the mA output level at the receiving device.
5. Type the value that you read at the receiving device in the **Enter Meas** box.
6. Click **Next**. At this point, the transmitter trims the milliamp output and displays the adjusted output in the following screen:

Figure 4-5 Milliamp trim wizard – Screen 2

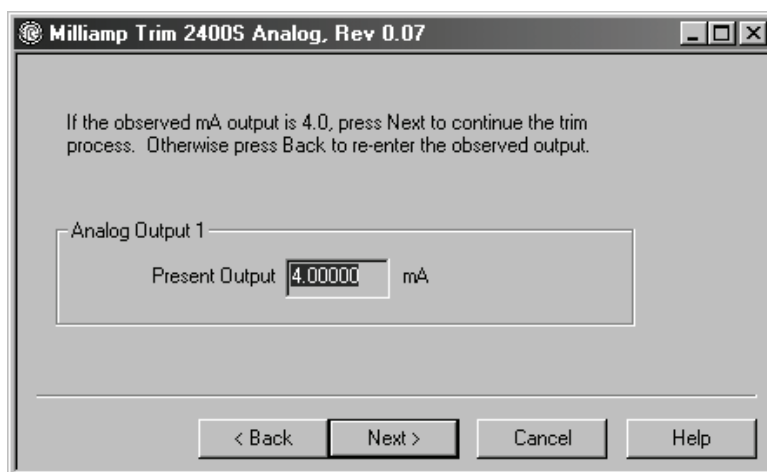

## Initial Transmitter Startup Procedures

If the adjusted output is not 4.0:

- a. Click **Back**.
- b. Read the output level at the receiving device and enter the new value in the **Enter Meas** box.
- c. Click **Next**.
- d. Repeat until the adjusted output is 4.0 (or close enough for your application).

If the adjusted output is 4.0, click **Next**.

7. Click **Next** to repeat this procedure to trim the 20 mA output.

Once you have completed the 20 mA trim, the procedure is complete. Click **Finish**.

### 4.4 Zeroing the meter

Zeroing the meter establishes the meter's point of reference when there is no flow.

*Note: Not all transmitters require startup zeroing. Consult the manual for your transmitter.*

When you zero the meter, you may need to adjust the zero time parameter. *Zero time* is the amount of time the transmitter takes to determine its zero-flow reference point. The default zero time is 20 seconds.

- A *long* zero time may produce a more accurate zero reference but is more likely to result in a zero failure. This is due to the increased possibility of noisy flow, which causes incorrect calibration.
- A *short* zero time is less likely to result in a zero failure but may produce a less accurate zero reference.

For most applications, the default zero time is appropriate.

*Note: In some menus, a convergence limit parameter is displayed. This parameter applies only to the RFT9739 transmitter. Micro Motion recommends that you use the default value for convergence limit.*

Do not zero the meter if a high severity alarm is active. Correct the problem, then zero the meter. You may zero the meter if a low severity alarm is active. See Section 3.8 for information on viewing transmitter status and alarms.

To zero the meter:

1. Prepare the meter for zeroing:
  - a. Apply power to the meter. Wait several minutes to allow the meter to warm up:
    - For IFT or RFT transmitters, wait for approximately 30 minutes.
    - For Series 1000/2000/3000 transmitters and MVD Direct Connect, wait for approximately 20 minutes.
  - b. Run the process fluid through the sensor until the sensor temperature reaches the normal process operating temperature.
  - c. Close the shutoff valve downstream from the sensor.
  - d. Ensure that the sensor is completely filled with fluid.
  - e. Ensure that the process flow has completely stopped.

**⚠ CAUTION**

**If fluid is flowing through the sensor, the sensor zero calibration may be inaccurate, resulting in inaccurate process measurement.**

To improve the sensor zero calibration and measurement accuracy, ensure that process flow through the sensor has completely stopped.

2. Open the **ProLink** menu.
3. Click the **Calibration** option. The calibration options for the currently connected transmitter are displayed (see Figure 4-3).
4. Select **Zero Calibration**. The following screen is displayed:

Figure 4-6 Zero calibration screen

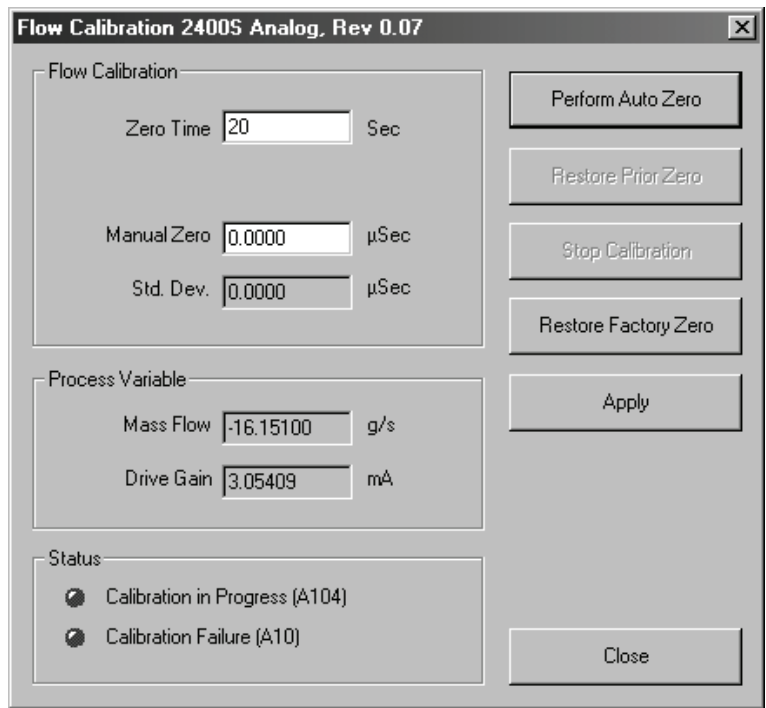

5. Type a new zero time in the **Zero Time** box or accept the default value.
6. If the convergence limit parameter is displayed, type a new convergence limit in the **Converge. Limit** box or accept the default value.
7. Click **Perform Auto Zero**. The meter will begin zeroing. The **Calibration in Progress** status light will turn red.

## Initial Transmitter Startup Procedures

8. Wait until the zero time has expired. At the end of this time:
  - If the **Calibration Failure** status light turns red, the zero procedure failed.
    - See your transmitter manual for troubleshooting procedures.
    - If desired, use the buttons in the dialog box to restore the previous zero value or the zero value established during factory calibration.

*Note: These two functions are not available on all transmitters.*

- If the **Calibration in Progress** status light returns to green and the **Calibration Failure** status light does not turn red, the zero procedure succeeded.
9. Click **Close**.



# Chapter 5

## Transmitter Configuration, Characterization, and Calibration

### 5.1 Overview

This chapter describes:

- Saving and loading transmitter configuration files
- Configuring a transmitter
- Using the Gas Unit Configurator utility
- Characterizing a transmitter
- Calibrating a transmitter for pressure
- Calibrating a transmitter for temperature
- Configuring pressure compensation
- Configuring temperature compensation
- Setting up polling

### 5.2 Using configuration files

ProLink II can read your transmitter's configuration and save it to a file on your PC. This file can then be loaded back to the same transmitter, loaded to another transmitter of the same type, and saved for backup and reference. Micro Motion recommends this step for all transmitters accessible through ProLink II.

#### 5.2.1 Saving a configuration file to a PC

To save a configuration file to a PC:

1. Open the **File** menu.
2. Click **Load from Xmtr to File**.
3. In the dialog box that appears, specify a name and location for the configuration file, and click **Save**. Be sure to specify a unique name.
4. Click **Download Configuration**.
5. When the load is complete, click **Close**.

This file is now available on your PC for copying, saving, sending, and reloading.

### CAUTION

**Editing the configuration file can introduce errors.**

To avoid introducing errors into the transmitter configuration file, save an original version and work on a copy. If you do this, you will always be able to restore the original version.

### 5.2.2 Loading a configuration file to a transmitter

To load a configuration file:

1. Open the **File** menu.
2. Click **Send to Xmtr from File**.
3. Use the dialog box that appears to identify the name and location of the configuration file to be loaded, and click **Open**.
4. Click **Upload Configuration**.
5. When the load is complete, click **Close**.

If problems occur during the load:

1. Open the **View** menu.
2. Click **Preferences**.
3. Enable the **Error Log On** option.
4. Repeat the file load.

ProLink II will now save an error log for the load process, and will display a message telling you where to find the log file.

### 5.3 Configuring a transmitter

The procedures in this section provide a general method for configuring your transmitter using ProLink II. Depending on the transmitter you are connected to, different tabs are displayed, and different options are displayed on each tab.

For specific configuration information for your transmitter, refer to the transmitter manual. Transmitter manuals are shipped with the transmitter, and are also available on the Micro Motion web site.

To configure a transmitter using ProLink II:

1. Open the **ProLink** menu.
2. Click **Configuration**. A window similar to the following is displayed:

*Note: Before making changes to your transmitter's configuration, be sure that you have saved the configuration to a file as described in Section 5.2.*

Figure 5-1 ProLink II configuration window

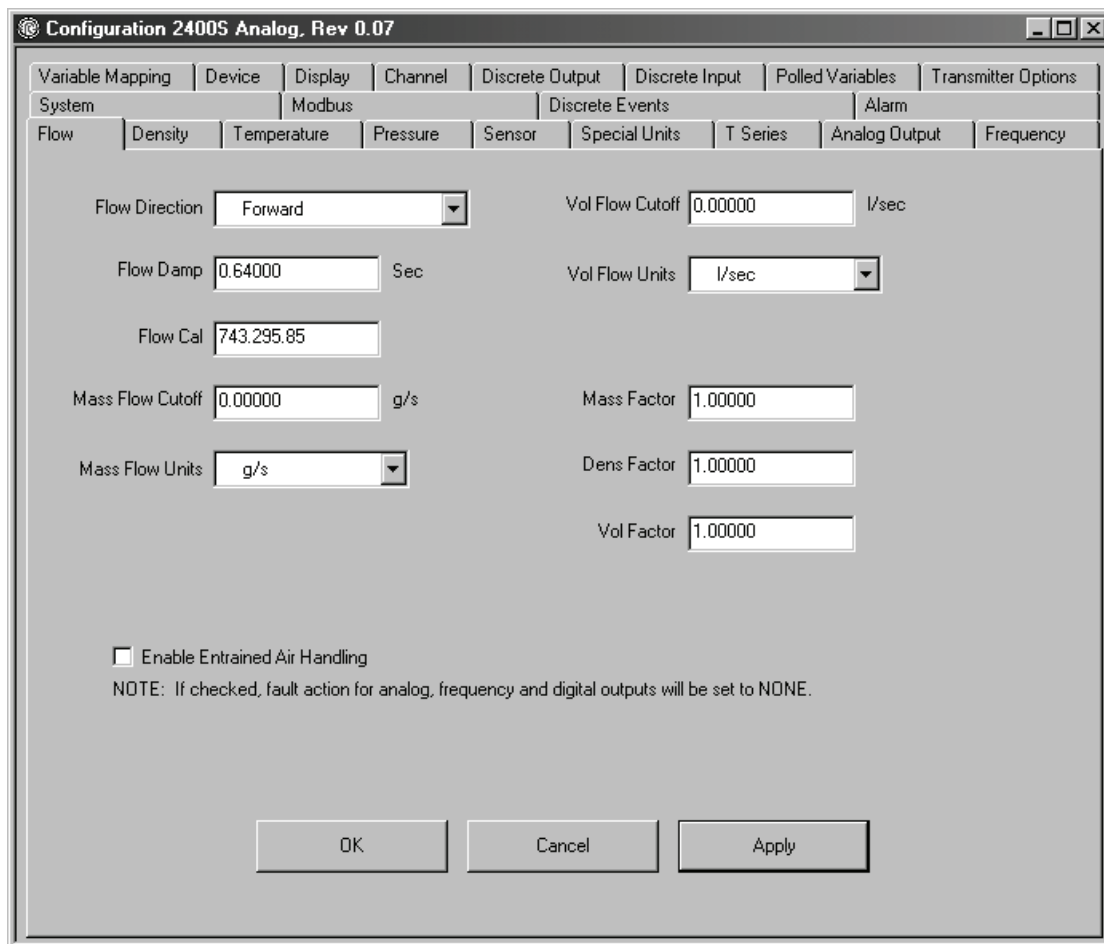

This window is organized into panels. To configure an option:

- a. Display the appropriate panel by clicking on its tab at the top of the window.
- b. Set options using standard Windows methods:
  - Use arrows to display and select from dropdown lists.
  - Type values into textboxes.
  - Click on radio buttons to select from a set of options.
  - Click on checkboxes to enable or disable options.

As you make changes to a panel, the tab display color is changed to yellow.

3. When you are finished with a panel:

- To discard the changes, click **Cancel**. You will be asked to verify the cancellation.
  - If you click **Yes**, your changes will be discarded and the **Configuration** window is closed.
  - If you click **No**, you are returned to the current configuration panel.

## Transmitter Configuration, Characterization, and Calibration

- To apply the changes and continue with configuration, click **Apply**. The following popup is displayed:

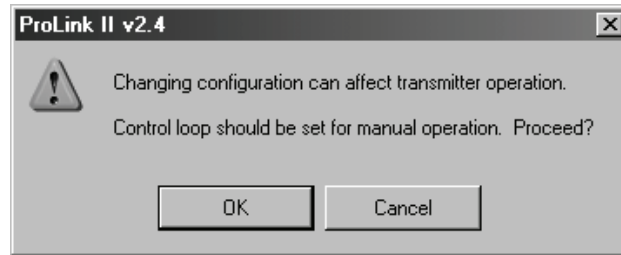

Ensure that your application is in an appropriate state to accept configuration changes, then click **OK**. The new configuration value(s) will be sent to the transmitter, and will take effect immediately. The tab display color is reset to gray.

To avoid immediate reconfiguration, click **Cancel**. The new setting is retained in ProLink II but is not sent to the transmitter.

- To apply the changes and close the **Configuration** window, click **OK**.
4. If you leave a panel without specifying **Apply**, **Cancel**, or **OK**, the tab display color remains yellow. You can return to the panel at any point to apply or discard the changes.
  5. When you have finished configuration, close the **Configuration** window. You can close the window without applying changes.

### 5.3.1 Using the Gas Unit Configurator tool

*Note: With Model 2400S transmitters and Series 1000/2000 transmitters with firmware version 5.0 and above, the Gas Unit Configurator tool is not available because standard and normal units are pre-defined in the transmitter.*

For many gas applications, standard or normal volume flow rate is used as the quasi mass flow rate. Standard or normal volume flow rate is calculated as the mass flow rate divided by the density of the gas at a reference condition.

To configure a mass flow special unit that represents standard or normal volume flow rate, you must calculate the mass flow conversion factor from the density of the gas at a reference temperature, pressure, and composition. ProLink II v1.2 and later offers a Gas Unit Configurator tool to calculate this mass flow conversion factor. The tool will automatically update the mass flow conversion factor in the **Special Units** tab.

*Note: Micro Motion recommends that you do not use the meter to measure actual volume flow of a gas (volumetric flow at line conditions). If you need to measure actual volume flow of a gas, contact Micro Motion customer support.*

#### CAUTION

**The meter should not be used for measuring the actual volume of gases.**

Standard or normal volume is the traditional unit for gas flow. Coriolis meters measure mass. Mass divided by standard or normal density yields standard or normal volume units.

To use the Gas Unit Configurator:

1. Click the **Special Units** tab, and click the **Gas Unit Configurator** button, or open the **Tools** menu and click **Gas Unit Configurator**.
2. Select the **Time Unit** that your special unit will be based on.
3. Click a radio button to specify that your special unit will be defined in terms of **English Units** or **SI Units**.
4. Click **Next**.
5. Define the standard density to be used in calculations.
  - To use a fixed standard density, click the top radio button, enter a value for standard density in the **Standard Density** textbox, and click **Next**.
  - To use a calculated standard density, click the second radio button and click **Next**. Then enter values for **Reference Temperature**, **Reference Pressure**, and **Specific Gravity** on the next panel, and click **Next**.
6. Check the values displayed.
  - If they are appropriate for your application, click **Finish**. The special unit data will be written to the transmitter.
  - If they are not appropriate for your application, click **Back** as many times as necessary to return to the relevant panel, correct the problem, then repeat the above steps.

### 5.4 Characterizing the meter

*Characterizing* the meter adjusts the transmitter to compensate for the unique traits of the sensor it is paired with. The characterization parameters, or calibration parameters, describe the sensor's sensitivity to flow, density, and temperature.

#### 5.4.1 When to characterize

If the transmitter and the sensor were ordered together as a Coriolis meter, then the meter has already been characterized. You need to characterize the meter only if the transmitter and the sensor are being paired together for the first time.

#### 5.4.2 Characterization parameters

The characterization parameters that must be configured depend on your meter's sensor type: "T-Series" or "Other" (also referred to as "Straight Tube" and "Curved Tube," respectively), as listed in Table 5-1. The "Other" category includes all Micro Motion sensors except T-Series. Table 5-1 also shows the location of each parameter within ProLink II.

The characterization parameters are provided on the sensor tag. The format of the sensor tag varies depending on your sensor's date of purchase. See Figures 5-2 and 5-3 for illustrations of newer and older sensor tags.

## Transmitter Configuration, Characterization, and Calibration

**Table 5-1 Sensor calibration parameters**

| Parameter                      | ProLink II Location           | Sensor type      |                  |
|--------------------------------|-------------------------------|------------------|------------------|
|                                |                               | T-Series         | Other            |
| K1                             | Configuration/Density         | ✓                | ✓ <sup>(1)</sup> |
| K2                             | Configuration/Density         | ✓                | ✓ <sup>(1)</sup> |
| FD                             | Configuration/Density         | ✓                | ✓ <sup>(1)</sup> |
| D1                             | Configuration/Density         | ✓                | ✓ <sup>(1)</sup> |
| D2                             | Configuration/Density         | ✓                | ✓ <sup>(1)</sup> |
| Temp coeff (DT) <sup>(2)</sup> | Configuration/Density         | ✓                | ✓ <sup>(1)</sup> |
| Flowcal                        | Configuration/Flow            |                  | ✓ <sup>(3)</sup> |
| FCF and FT                     | Configuration/Flow            | ✓ <sup>(4)</sup> |                  |
| FCF                            | Configuration/Flow            | ✓ <sup>(5)</sup> |                  |
| FTG                            | Configuration/T-Series Config | ✓                |                  |
| FFQ                            | Configuration/T-Series Config | ✓                |                  |
| DTG                            | Configuration/T-Series Config | ✓                |                  |
| DFQ1                           | Configuration/T-Series Config | ✓                |                  |
| DFQ2                           | Configuration/T-Series Config | ✓                |                  |

(1) See the section entitled “Density calibration factors.”

(2) On some sensor tags, shown as TC.

(3) See the section entitled “Flow calibration values.”

(4) Older T-Series sensors. See the section entitled “Flow calibration values.”

(5) Newer T-Series sensors. See the section entitled “Flow calibration values.”

**Figure 5-2 Sample calibration tags – T-Series sensor**

### Newer tag

```

MODEL T100T628SCAZEZZZZ S/N 1234567890
FLOW FCF XXXX.XX.XX
      FTG X.XX      FFQ X.XX
DENS D1 X.XXXXXX K1 XXXXX.XXX
      D2 X.XXXXXX K2 XXXXX.XXX
      DT X.XX      FD XX.XX
      DTG X.XX     DFQ1 XX.XX DFQ2 X.XX
TEMP RANGE -XXX TO XXX C
TUBE* CONN** CASE*
XXXX XXXX XXXX XXXXXX
    
```

\* MAXIMUM PRESSURE RATING AT 25°C, ACCORDING TO ASME B31.3  
 \*\* MAXIMUM PRESSURE RATING AT 25°C, ACCORDING TO ANSI/ASME B16.5, OR MFR'S RATING

### Older tag

```

MODEL T100T628SCAZEZZZZ S/N 1234567890
FLOW FCF X.XXXX FT X.XX
      FTG X.XX      FFQ X.XX
DENS D1 X.XXXXXX K1 XXXXX.XXX
      D2 X.XXXXXX K2 XXXXX.XXX
      DT X.XX      FD XX.XX
      DTG X.XX     DFQ1 XX.XX DFQ2 X.XX
TEMP RANGE -XXX TO XXX C
TUBE* CONN** CASE*
XXXX XXXX XXXX XXXXXX
    
```

\* MAXIMUM PRESSURE RATING AT 25°C, ACCORDING TO ASME B31.3  
 \*\* MAXIMUM PRESSURE RATING AT 25°C, ACCORDING TO ANSI/ASME B16.5, OR MFR'S RATING

Figure 5-3 Sample calibration tags – All sensors except T-Series

Newer tag

```

MODEL
S/N
FLOW CAL* 19.0005.13
DENS CAL* 12500142864.44
  D1 0.0010    K1 12502.000
  D2 0.9980    K2 14282.000
  TC 4.44000  FD 310
TEMP RANGE      TO      C
TUBE**  CONN*** CASE**

* CALIBRATION FACTORS REFERENCE TO 0 °C
** MAXIMUM PRESSURE RATING AT 25 °C, ACCORDING TO ASME B31.3
*** MAXIMUM PRESSURE RATING AT 25°C, ACCORDING TO ANSI/ASME B16.5 OR MFR'S RATING
    
```

Older tag

```

Sensor          S/N
Meter Type
Meter Factor
Flow Cal Factor 19.0005.13
Dens Cal Factor 12500142864.44
Cal Factor Ref to 0°C
TEMP           °C
TUBE*         CONN**

• MAX. PRESSURE RATING AT 25°C, ACCORDING TO ASME B31.3.
• MAX. PRESSURE RATING AT 25°C, ACCORDING TO ANSI/ASME B16.5 OR MFR'S RATING.
    
```

Density calibration factors

If your sensor tag does not show a D1 or D2 value:

- For D1, enter the Dens A or D1 value from the calibration certificate. This value is the line-condition density of the low-density calibration fluid. Micro Motion uses air.
- For D2, enter the Dens B or D2 value from the calibration certificate. This value is the line-condition density of the high-density calibration fluid. Micro Motion uses water.

If your sensor tag does not show a K1 or K2 value:

- For K1, enter the first 5 digits of the density calibration factor. In the sample tag in Figure 5-3, this value is shown as **12500**.
- For K2, enter the second 5 digits of the density calibration factor. In the sample tag in Figure 5-3, this value is shown as **14286**.

If your sensor does not show an FD value, contact Micro Motion customer service.

If your sensor tag does not show a DT or TC value, enter the last 3 digits of the density calibration factor. In the sample tag in Figure 5-3, this value is shown as **4.44**.

Flow calibration values

Two separate values are used to describe flow calibration: a 6-character FCF value and a 4-character FT value. Both values contain decimal points. During characterization, these are entered as a single 10-character string that includes two decimal points. In ProLink II, this value is called the Flowcal parameter. In the Communicator, this value is called the FCF for T-Series sensors and Flowcal for other sensors.

## Transmitter Configuration, Characterization, and Calibration

To obtain the required value:

- For older T-Series sensors, concatenate the FCF value and the FT value from the sensor tag, as shown below.

Flow FCF X.XXXXX      FT X.XX

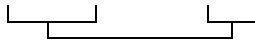

- For newer T-Series sensors, the 10-character string is represented on the sensor tag as the FCF value. The value should be entered exactly as shown, including the decimal points. No concatenation is required.
- For all other sensors, the 10-character string is represented on the sensor tag as the Flow Cal value. The value should be entered exactly as shown, including the decimal points. No concatenation is required.

### 5.4.3 How to characterize

To characterize the meter:

1. In the **ProLink > Configuration > Device** panel, specify your sensor type and click **Apply**.
2. Set each of the required parameters, as listed in Table 5-1, to the appropriate value, as described in the previous sections.

## 5.5 Calibrating the meter

The meter measures process variables based on fixed points of reference. *Calibration* adjusts those points of reference.

This section provides a general method for calibration. For specific calibration information for your transmitter, refer to the transmitter manual. Transmitter manuals are shipped with the transmitter, and are also available on the Micro Motion web site.

The **Calibration** menu, shown in Figure 5-4, is used to begin the calibration procedures.



Figure 5-4 ProLink II calibration options

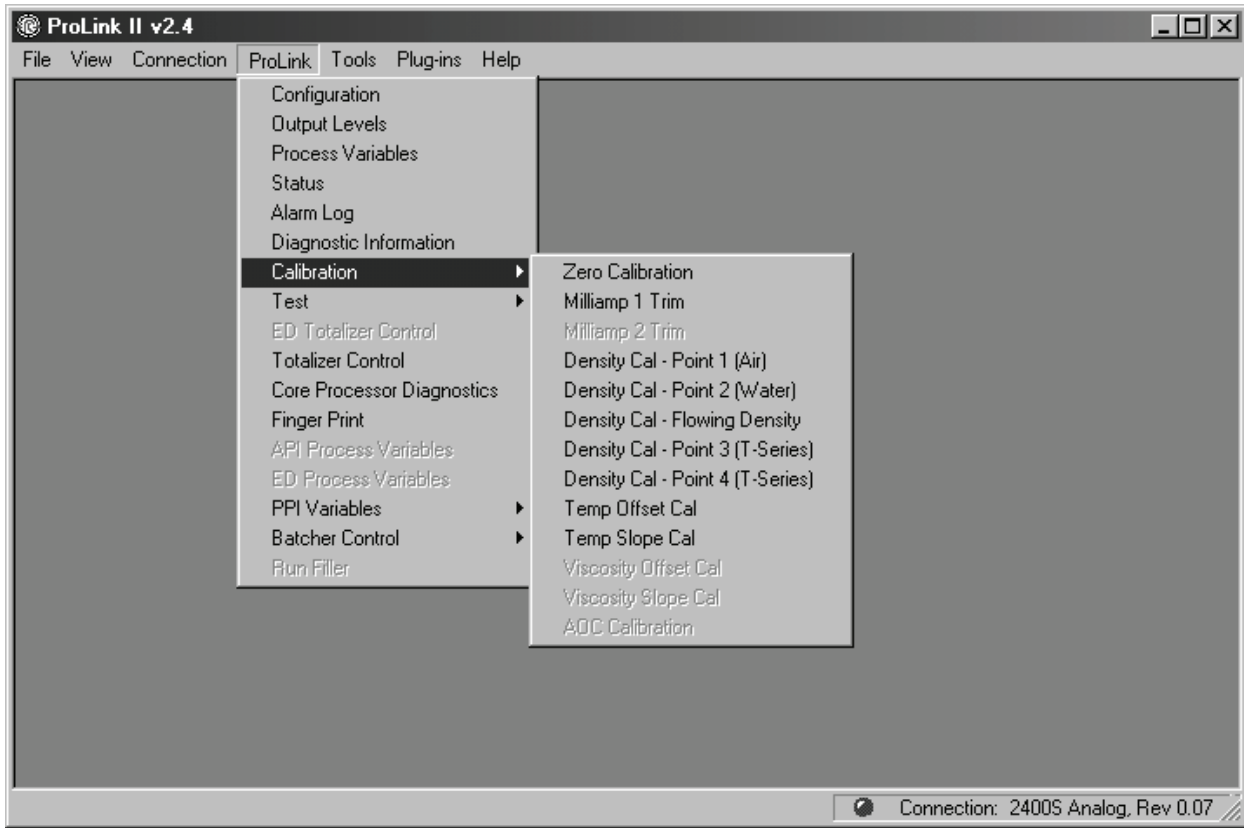

### 5.5.1 When to calibrate

The transmitter is factory calibrated and does not normally need to be calibrated in the field. Calibrate the transmitter only if you must do so to meet regulatory requirements. Micro Motion recommends using meter factors, rather than calibration, to adjust the meter to specific conditions. Before calibrating, contact Micro Motion customer service.

### 5.5.2 Density calibration

*Density calibration* includes the following calibration points:

- All sensors:
  - D1 calibration (low-density)
  - D2 calibration (high-density)
- T-Series sensors only:
  - D3 calibration (optional)
  - D4 calibration (optional)

## Transmitter Configuration, Characterization, and Calibration

For T-Series sensors, the optional D3 and D4 calibrations could improve the accuracy of the density measurement. If you choose to perform the D3 and D4 calibration:

- Do not perform the D1 or D2 calibration.
- Perform D3 calibration if you have one calibrated fluid.
- Perform both D3 and D4 calibrations if you have two calibrated fluids (other than air and water).

Before beginning density calibration, review the following requirements. To perform a D1 and D2 density calibration, see Figure 5-5. To perform a D3 density calibration or a D3 and D4 density calibration, see Figure 5-6.

### Sensor requirements

During density calibration, the sensor must be completely filled with the calibration fluid, and there must be no flow through the sensor. This is usually accomplished by closing the shutoff valve downstream from the sensor, then filling the sensor with the appropriate fluid.

### Density calibration fluid requirements

D1 and D2 density calibration require a D1 (low-density) fluid and a D2 (high-density) fluid. You may use air and water. If you are calibrating a T-Series sensor, the D1 fluid must be air and the D2 fluid must be water.

#### CAUTION

For T-Series sensors, the D1 calibration must be performed on air.

#### CAUTION

For T-Series sensors, the D2 calibration must be performed on water.

For D3 density calibration, the D3 fluid must meet the following requirements:

- Minimum density of  $0.6 \text{ g/cm}^3$
- Minimum difference of  $0.1 \text{ g/cm}^3$  between the density of the D3 fluid and the density of water. The density of the D3 fluid may be either greater or less than the density of water

For D4 density calibration, the D4 fluid must meet the following requirements:

- Minimum density of  $0.6 \text{ g/cm}^3$
- Minimum difference of  $0.1 \text{ g/cm}^3$  between the density of the D4 fluid and the density of the D3 fluid. The density of the D4 fluid must be greater than the density of the D3 fluid
- Minimum difference of  $0.1 \text{ g/cm}^3$  between the density of the D4 fluid and the density of water. The density of the D4 fluid may be either greater or less than the density of water

Figure 5-5 D1 and D2 density calibration

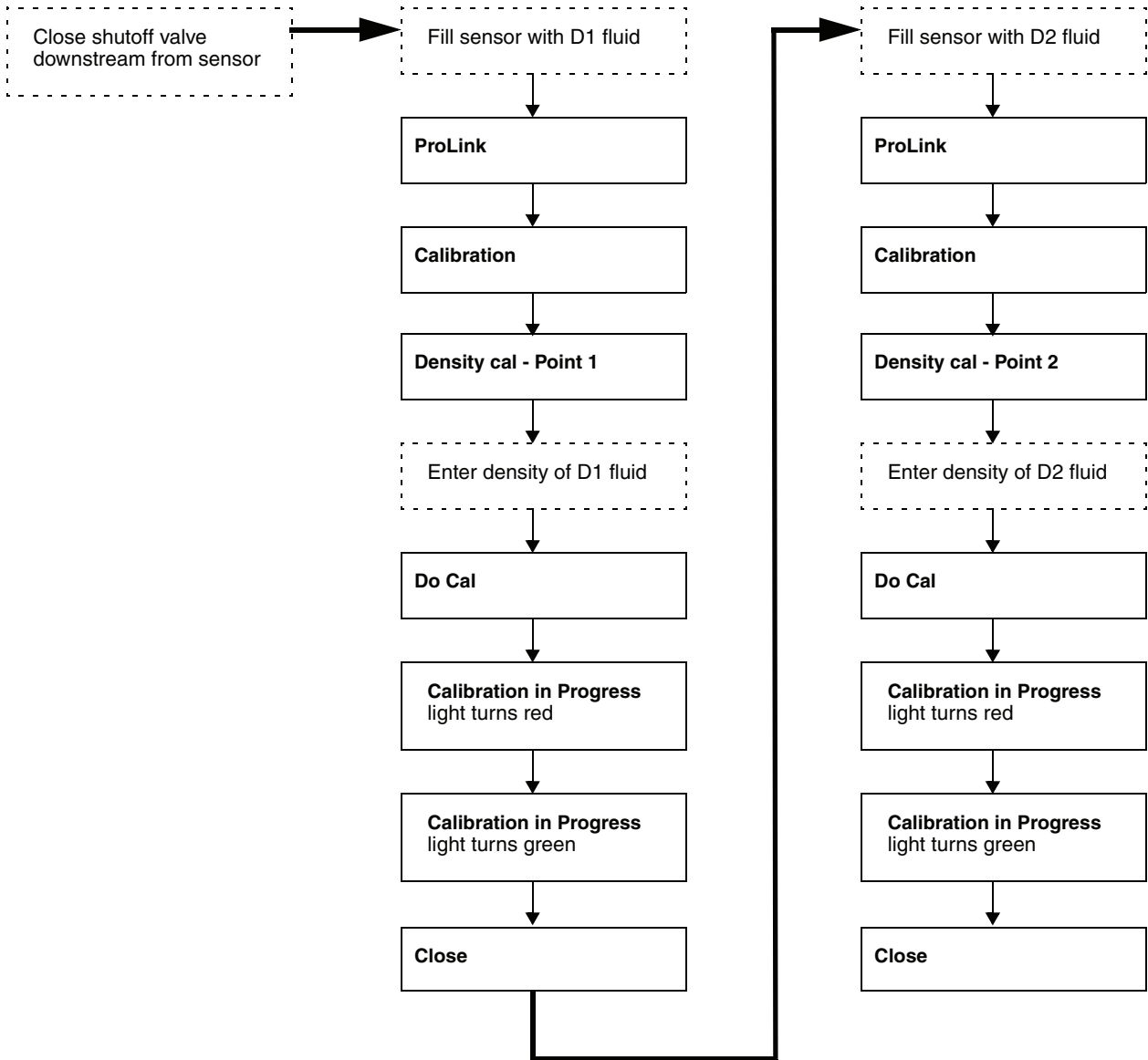
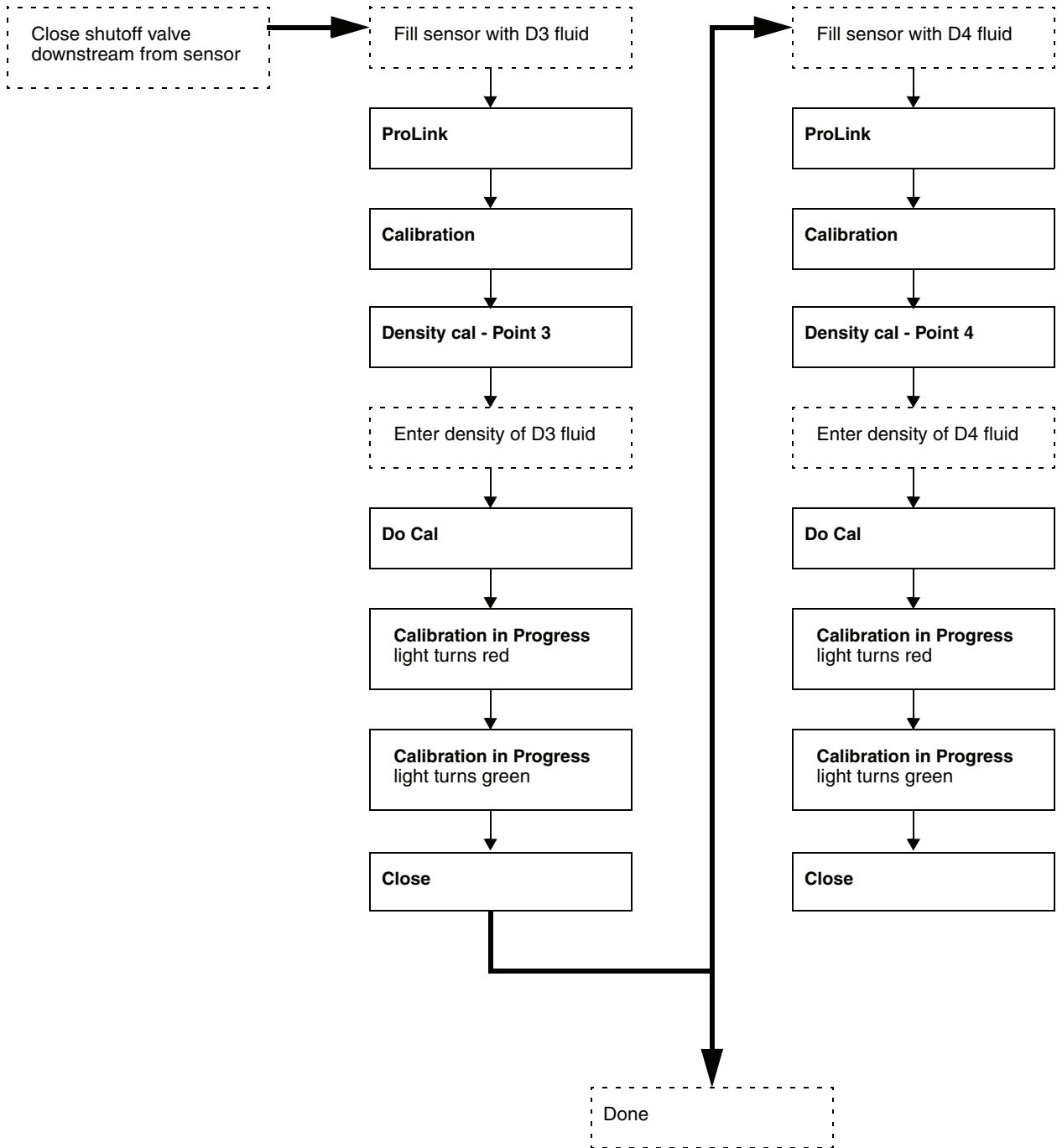

Figure 5-6 D3 or D3 and D4 density calibration



### 5.5.3 Temperature calibration

Temperature calibration is a two-point procedure: temperature offset calibration and temperature slope calibration. The entire procedure must be completed without interruption. To perform a temperature calibration, see Figure 5-7.

Figure 5-7 Temperature calibration

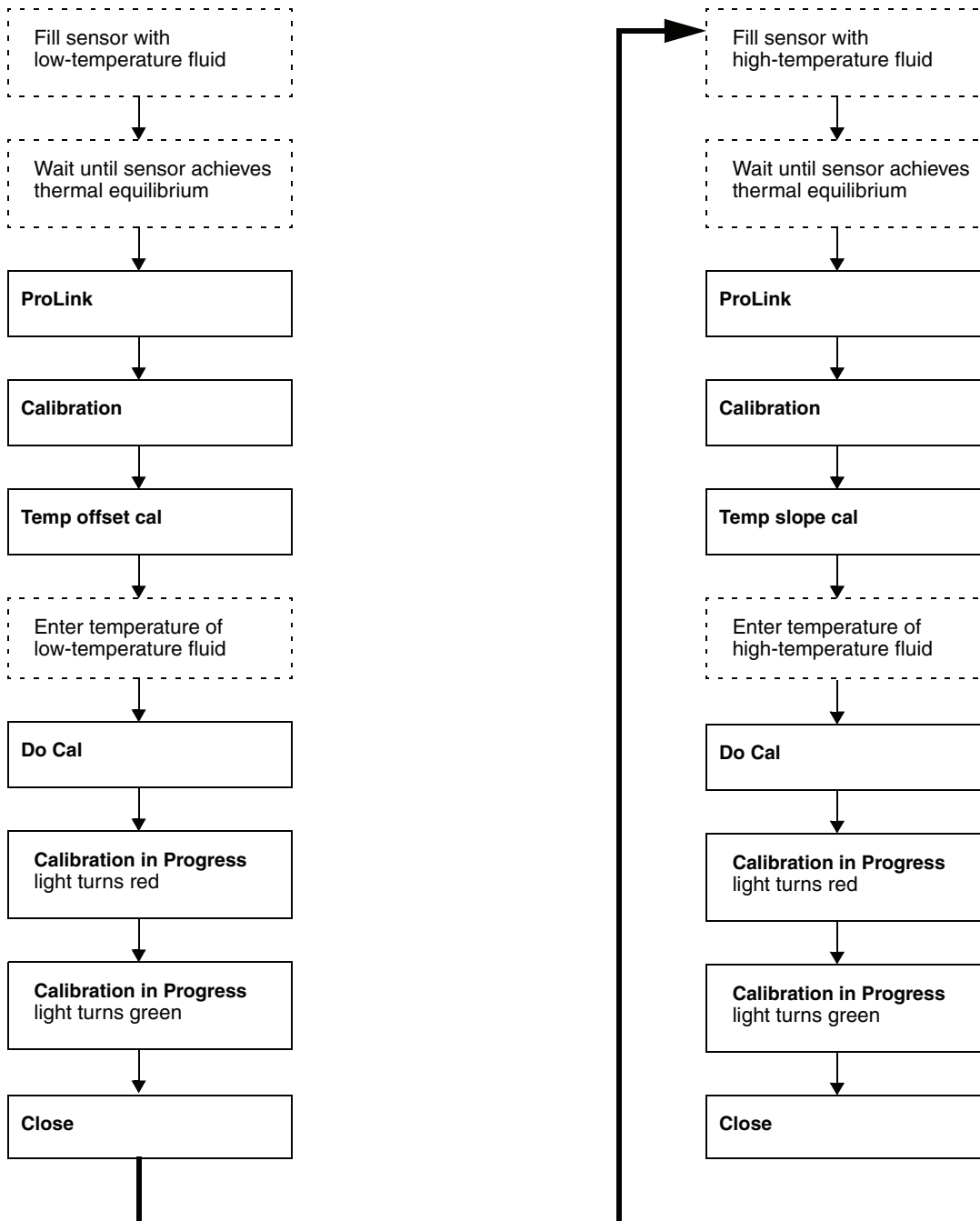

### 5.6 Compensating for pressure

Some Micro Motion transmitters can compensate for the effect of pressure on the sensor flow tubes. *Pressure effect* is defined as the change in sensor flow and density sensitivity due to process pressure change away from calibration pressure.

#### 5.6.1 Options

There are two ways to compensate for pressure:

- If the pressure is a known static value, you may choose to enter the external pressure in the software and not poll a pressure measurement device.
- If the operating pressure varies significantly, you may choose to have the transmitter poll for an updated pressure value from an external pressure measurement device. Polling requires HART protocol.

*Note: If you poll for pressure, ensure that the external pressure measurement device is accurate and reliable.*

#### 5.6.2 Pressure correction factors

When configuring pressure compensation, you must provide the flow calibration pressure – the pressure at which the meter was calibrated (which therefore defines the pressure at which there will be no effect on the calibration factor). Enter 20 PSIG unless the calibration document for your sensor indicates a different calibration pressure.

Two additional pressure correction factors may be configured: one for flow and one for density. These are defined as follows:

- Flow factor – the percent change in the flow rate per psi
- Density factor – the change in fluid density, in  $\text{g/cm}^3/\text{psi}$

Not all sensors or applications require pressure correction factors. For the values to be used, obtain the pressure effect values from the product data sheet for your sensor, then reverse the signs (e.g., if the pressure effect is 0.000004, enter a pressure correction factor of  $-0.000004$ ). For more information, contact Micro Motion customer service.

#### 5.6.3 Configuration

To enable and configure pressure compensation:

1. From the **View** menu, select **Preferences** and ensure that the **Enable External Pressure Compensation** checkbox is checked.
2. Open the **Configuration** panel and click the **Pressure** tab.
3. Enter new values in the **Flow factor**, **Density factor**, and **Cal Pressure** boxes. See the discussion in the previous section.
4. If you will poll an external device for pressure data:
  - a. If your transmitter is a model RFT9739, RFT9712 or IFT9701/03, set **Pressure units** to the unit used by the external pressure measurement device.
  - b. Click **Apply**.
  - c. Follow the polling setup instructions in Section 5.8.

5. If you will use a static pressure value:
  - a. Type the pressure value in the **External Pressure** box.
  - b. Click **Apply**.
  - c. Ensure that neither polled variable is configured to poll for pressure. Polling for temperature is allowed. See Section 5.8.

### 5.7 Compensating for temperature

Temperature data are used in several different calculations. Micro Motion sensors always report temperature data to the transmitter. For greater accuracy, you can configure the transmitter to use a different temperature value:

- If the temperature is a known static value, you may choose to enter the external temperature in the software and not poll a temperature measurement device.
- If the operating temperature varies significantly, you may choose to have the transmitter poll for an updated temperature value from an external temperature measurement device. Polling requires HART protocol.

*Note: If you have core processor v2.1 or earlier, the external temperature data are used for all calculations that require temperature or values. If you have core processor v2.2 or later, the external temperature data are used only for calculation of the derived variable in enhanced density applications or the CTL (Correction for Temperature on volume of Liquids) value in petroleum measurement applications.*

*Note: If you poll for temperature, ensure that the external temperature measurement device is accurate and reliable, and ensure that the transmitter is configured to use the same temperature unit that the external temperature measurement device is using.*

To enable and configure temperature compensation:

1. From the **View** menu, select **Preferences** and ensure that the **Use External Temperature** checkbox is checked.
2. If you will poll an external device for temperature data, follow the polling setup instructions in Section 5.8.
3. If you will use a static temperature value:
  - a. Open the **Configuration** panel and click the **Temperature** tab.
  - b. Type the temperature value in the **External Temperature** box.
  - c. Click **Apply**.
  - d. Ensure that neither polled variable is configured to poll for temperature. Polling for pressure is allowed. See Section 5.8.

### 5.8 Configuring polling

Polling is used to retrieve temperature or pressure data from an external device. These data can then be used for API calculation or other process variable calculations in applications that require pressure or temperature compensation. You may query one or two external devices.

You must also ensure that the primary mA output has been wired for HART protocol. See Chapter 2 or the installation manual for your transmitter.

To configure polling:

1. From the **View** menu, select **Preferences**.
  - a. To use the external pressure data, ensure that the **Enable External Pressure Compensation** check box is checked.
  - b. To use the external temperature data, ensure that the **Use External Temperature** check box is checked.
  - c. Click **Apply**.
2. Ensure that the **External Temperature** box in the **Temperature** tab has not been set. The default value is 32.00 °F (0.0000 °C).
3. Click the **Polled Variables** tab in the **Configuration** panel.
4. For Polled Variable 1:
  - a. Click the arrow in the **Polling Control** box, and select a HART polling method from the list. Choose **Poll DP HART Primary** if the external device might be accessed by another device acting as a secondary master (e.g., a HART Communicator). Choose **Poll DP HART Secondary** if the external device might be accessed by another device acting as a primary master.
  - b. Click **Apply**. Polling parameters are now displayed for configuration.
  - c. In the **External Tag** box, type the HART tag of the external device that you will poll.
  - d. Click the arrow in the **Variable Type** box, and select a process variable.
  - e. Click **Apply**.
  - f. The value displayed in the **Current Value** textbox is the value received from the external device. Verify the value.
5. Repeat these steps for Polled Variable 2, if required.

*Note: For some transmitters, the Polling Control selection for Polled Variable 1 is automatically used for Polled Variable 2. No configuration is required.*



# Chapter 6

## Meter Verification

### 6.1 Overview

This chapter describes how to use the Structural Integrity meter verification tool. This tool evaluates the structural integrity of the sensor tubes by comparing current tube stiffness to the stiffness measured at the factory. Stiffness is defined as the load per unit deflection, or force divided by displacement. Because a change in structural integrity changes the sensor's response to mass and density, this value can be used as an indicator of measurement performance. Changes in tube stiffness are typically caused by erosion, corrosion, or tube damage.

Micro Motion recommends that you perform meter verification on a regular basis.

*Notes: To use meter verification, the transmitter must be paired with an enhanced core processor, and the meter verification option must be installed on your transmitter. To verify that it is installed, use the Installed Options command on the ProLink II View menu.*

*This chapter describes meter verification using the Structural Integrity method. The Tools menu contains a second meter verification method called Known Density Method, which is available only to authorized service personnel.*

### 6.2 Running the meter verification test

To initiate a meter verification test, click on the Tools menu and select **Meter Verification > Structural Integrity Method**. This command opens a multi-panel, wizard-style dialog box which will guide you through the meter verification process.

#### 6.2.1 First panel: Sensor and Transmitter Configuration

The Sensor and Transmitter Configuration panel is shown in Figure 6-1.

This panel displays read-only information about the sensor and transmitter pair you are about to test. Review this information and make sure it is accurate.

## Meter Verification

Figure 6-1 Meter Verification - Sensor and Transmitter Configuration panel

The screenshot shows a software window titled "Structural Integrity Meter Verification - Sensor and Transmitter Configuration". The window contains the following sections and fields:

- Transmitter Identification:**
  - Transmitter Tag: M. RESET
  - Transmitter ID: 0
  - Transmitter Model: 2400S DeviceNet
  - Transmitter Serial Number: 0
- Sensor Identification:**
  - Sensor Serial Number: 0
  - Sensor Model: T075
  - Buttons: "Click Next to begin a new test, or" and "View Previous Test Results for this Sensor..."
- Flow Configuration:**
  - Flow Damp: 0.00000 Sec
  - Flow Cal: 743.295.85
  - Mass Factor: 1.00000
  - Dens Factor: 1.00000
  - Vol Factor: 1.00000
- Density Configuration:**
  - Dens Damping: 0.00000 Sec
  - K1: 1606.43005 μSec
  - K2: 1785.47400 μSec
  - D1: 0.00000 g/cm3
  - D2: 1.00000 g/cm3
- Zero Information:**
  - Current Zero: 0.00000 μSec
  - Previous Test Zero: 0.00000 μSec
  - Factory Zero: 0.00000 μSec

At the bottom of the window are four buttons: "< Back", "Next >", "Cancel", and "Help".

ProLink II records the results of previous tests in a meter verification test database stored on the computer on which ProLink II is installed. If you have already run one or more tests on this meter, you can review those previous test results before starting a new test by clicking **View Previous Test Results for this Sensor ...**. This will open the Test Results panel shown in Figure 6-4.

*Notes: Test records are identified in the meter verification test database by transmitter/sensor pair. For the transmitter, the identifier is the HART Unique ID, which is entered in the transmitter memory at the factory. For the sensor, the identifier is the sensor serial number stored in the transmitter memory. Previous test results for the meter will be available only if the pairing of these two identifiers is identical. Therefore, before you run the first test on a meter, make sure that the sensor serial number displayed in the Sensor Identification box matches the sensor serial number on the sensor calibration tag. If necessary, enter the sensor serial number in the Sensor panel of the Configuration window.*

*Previous test results are stored on the computer on which ProLink II is installed. If you performed meter verification tests on the same meter from a different computer or from the meter display, the results of these tests will not be visible.*

The Structural Integrity meter verification method is not directly affected by any of the parameters displayed in the Flow Configuration, Density Configuration and Zero Information boxes. However, because any modification of these parameters can have an impact on the meter accuracy, this information can be useful when reviewing meter verification test results to decide if the meter's accuracy meets factory specifications.

Once you have reviewed the meter information, click **Next**.

### 6.2.2 Second panel: Test Definition

The Test Definition panel is shown in Figure 6-2.

Figure 6-2 Meter Verification - Test Definition panel

This panel allows you to enter metadata about each test for auditing purposes. This metadata will be saved with the test results and will also appear on the test report which will be generated at the end of the test.

*Notes: The metadata fields are optional. You will be able to run the meter verification test even if these fields are left blank.*

*If you save the test results at the end of the meter verification procedure, the information entered here will be automatically entered in this panel the next time you run a test on the same meter.*

If you want to specify the test fluid, you can select one of the fluids listed in the Test Fluid drop-down menu, or you can type the name of the test fluid. If you enter a new name, it will be saved in the ProLink II meter verification database with the test results, and it will be available for selection in the drop-down list the next time you run a test.

*Note: The meter verification procedure can be performed on any process fluid. It is not necessary to use the same test fluid for each test.*

## Meter Verification

### Specification Uncertainty Limit

The result of the meter verification test will be a percent uncertainty of normalized tube stiffness. The default limit for this uncertainty is  $\pm 4.0\%$ . This limit is stored in the transmitter, and can be changed with ProLink II if necessary by clicking the arrow in the **Specification Uncertainty Limit** box and selecting a value between 0.1 and 5 %. For most installations, it is advisable to leave the test limits at the default value.

During meter commissioning, Micro Motion recommends performing meter verification several times over a range of process conditions. This will establish a baseline for how widely the verification measurement varies under normal circumstances. The range of process conditions should include expected temperature, pressure, density, and flow rate variations. The default stiffness specification uncertainty limit of  $\pm 4.0\%$  should avoid false Fail results over the entire range of specified process conditions. If the process variation observed during your meter commissioning is much different than 4%, you may adjust the specification limit to match your process variation. In general, to avoid false Fail results, make sure that the specification limits are set to a value around twice the variation due to the range of normal process conditions.

Once you have entered the necessary information and checked the uncertainty limit, click on **Next**.

### 6.2.3 Third panel: Start

The Start panel, shown in Figure 6-3, allows you to initiate and monitor the meter verification process.

Figure 6-3 Meter Verification - Start panel

**Structural Integrity Meter Verification - Start**

Test Conditions

Test Name

Test Fluid

Sensor Operating Conditions

Mass Flow  kg/hr

Volume Flow  l/sec

Density  g/cm3

Temperature  °F

External Pressure  PSI

Configuration Details

Configuration Unchanged

Zero Unchanged

NOTE: Device configuration changes have no impact on test results obtained using the Structural Integrity method of meter verification. These indicators appear here and are recorded in the database to verify the transmitter setup.

Meter Verification

Meter Verification Inactive Meter Verification Counter

Meter Verification Inactive.

< Back Next > Cancel Help

### Sensor Operating Conditions

Meter verification is not affected by current process values. However, during the test, process conditions must be stable. To maximize stability:

- Maintain a constant temperature and pressure.
- Avoid changes to fluid composition (e.g., two-phase flow, settling, etc.).
- Maintain a constant flow. For higher test certainty, reduce or stop flow.

If stability varies outside test limits, the meter verification procedure will be aborted. If this happens, verify the stability of the process and retry the test.

*Notes: If you want the external pressure value displayed in this panel to reflect actual line pressure, you will need to set up polling of an external pressure measurement device for updated pressure values. To set up pressure polling, see Section 5.8. Note that if a static pressure value is specified in the Pressure panel of the Configuration window, it will be displayed here.*

*Once the test is started, the mass flow, volume flow and density values displayed on this panel will be fixed and will not be updated for the duration of the test. The temperature and external pressure values will continue to be updated throughout the test.*

### Configuration Details

The result of the Structural Integrity meter verification method is not directly affected by changes in meter configuration or zero value. However, meter accuracy can be affected by changes of certain configuration parameters or a by a change of the zero value. These indicators show whether the transmitter's configuration and zero have changed since the last meter verification test. They are green if configuration and zero are unchanged, and red otherwise. If an indicator is red, you can find out more information about the changes by clicking the **Details...** button next to the indicator. This information can be useful when reviewing meter verification test results to decide if the meter's accuracy meets factory specifications.

*Note: The status of these two indicators has no impact on the meter verification procedure. You will be able to run the test even if these indicators are red.*

### Meter Verification

When you are ready to start the test, click **Start Meter Verification**. ProLink II displays the following dialog box, which asks you to fix the outputs at either the configured fault levels or the last measured value. Output levels, as well as mass flow, volume flow and density values reported via digital communication, will remain fixed for the duration of the test.

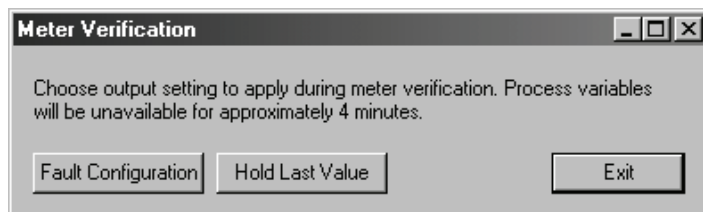

To start meter verification:

- with outputs fixed at their configured fault levels, click **Fault Configuration**.
- with outputs fixed at the last measured value, click **Hold Last Value**.

A dialog box will appear to warn you that process measurement will be interrupted for the duration of the test and to ask you if you wish to continue. Ensure that the process will be able to handle the measurement interruption, then click **OK** to start the test.

## Meter Verification

### CAUTION

**Transmitter outputs and process values reported through digital communication will remain fixed at either the configured fault levels or the last measured value for the duration of the test.**

To ensure the safety of your process:

- Disable all control loops for the duration of the procedure.
- Ensure that any data reported during this period is handled appropriately.

The test takes approximately four minutes to complete. During the test:

- The indicator at the bottom of the panel turns yellow and the monitor bar shows the progress of the meter verification procedure.
- If a problem occurs during the test, the test will be aborted. The indicator will turn red and a popup window will indicate why the test could not be completed. Correct the problem before restarting the test.
- If you need to stop the procedure before the end of the test, click **Abort Meter Verification**. The test will stop immediately, and all the data collected for this test will be discarded.

At the end of the test, a dialog box describing the result of the test will appear:

- *Meter passed verification*—The test result is within the range defined by the current Specification Uncertainty Limit parameter. If transmitter zero and configuration match factory values, the sensor will meet factory specifications for flow and density measurement. It is expected that the meter will pass meter verification every time the test is run. Click **OK** to close the popup window, then click **Next** to go to the next panel.
- *Meter failed verification*—The test result is not within the range defined by the current Specification Uncertainty Limit parameter.
  - Micro Motion recommends that you immediately re-run the meter verification test. To do so, click **Yes** to close the dialog box and automatically start a new test. If the meter passes the second test, the first Fail result can be ignored. If the meter fails the second test, the flow tubes may be damaged. Use the knowledge of your process to consider the type of damage and determine the appropriate action. These actions might include removing the meter from service and physically inspecting the tubes. At minimum, you should perform a flow validation and a density calibration. For more information on these procedures, refer to the transmitter manual.
  - If you don't want to re-run the test, click **No** to close the dialog box, then click **Next** to go to the next panel.

The **Meter Verification Counter** displays the total number of meter verification tests that have been performed on this transmitter.

- The counter is incremented each time a meter verification test is completed, whether the test passed or failed.
- The counter will not be incremented if the test is aborted, either automatically or by the user.

*Note: Because this counter resides in the transmitter memory and not in the ProLink II meter verification test database, it will also be incremented when a meter verification test is run from the meter display or from another computer. Therefore, if meter verification tests have been conducted from the display or from another computer, the number of tests displayed here will be different from the number of tests displayed in the graph in the test results panel.*

### 6.2.4 Fourth panel: Test Results

The Test Results panel, shown in Figure 6-4, summarizes the result of the meter verification test.

Figure 6-4 Meter Verification - Test Results panel

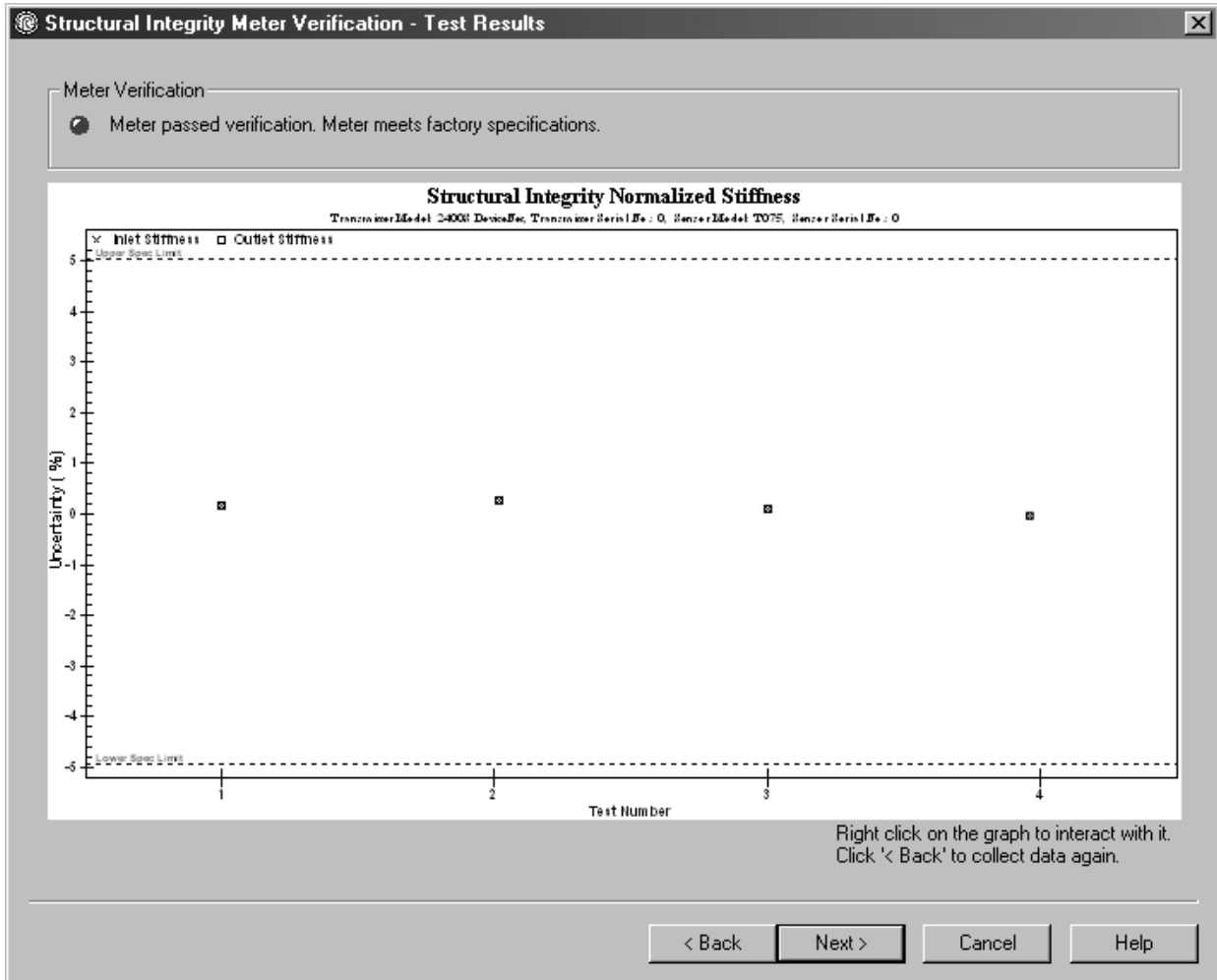

The indicator located at the top of the panel indicates the test result. It is green if the meter passed the test and red if it failed.

In addition to the pass/fail indicator, ProLink II shows the changes in tube stiffness on a graph. This allows you to see not only whether the meter is operating within specification, but also where the results fall within the specified limits. For each test, the results are shown as two data points corresponding to the stiffness at the inlet and at the outlet of the flow tubes.

This graph also shows the results of previous tests performed on this meter. The rightmost data points are the most recent. This history lets you see how your meter is trending over time, which can be a useful way to detect meter problems before they become severe. The trending of both the inlet and the outlet points over several tests can also help determine whether changes to the flow tubes are localized or generalized.

*Note: Historical data are stored on the computer on which ProLink II is installed. If you performed meter verification tests on the same meter from a different computer or from the meter display, the historical data for these tests will not be visible.*

## Meter Verification

You can manipulate the graphed data in various ways by double-clicking the graph to open a configuration dialog or by right-clicking on it to open a contextual menu. From there, you can also export the graph in a number of formats (including “to printer”) by clicking **Export**.

When you have finished reviewing the test results:

- To save the data to the ProLink II database, click **Next**.
- To exit without saving, click **Cancel**. The current test data will be discarded and the meter verification window will close.

### 6.2.5 Fifth panel: Report

The last panel, shown in Figure 6-5, displays a detailed report of the current test results.

Figure 6-5 Meter Verification - Report panel

**Structural Integrity Meter Verification - Report**

**EMERSON**  
Process Management

**Meter Verification -- Structural Integrity Method**

Tuesday, July 11, 2006  
12:56:54

**Instrument Owner:**  
**Company:**

**Contact Name:**  
**Telephone:**

**Transmitter Identification**

Transmitter Tag: M. RESET  
Transmitter Model: 2400S DeviceNet  
Transmitter Serial Number: 0  
Transmitter ID: 0

**Sensor Identification**

Sensor Model: TD75  
Sensor Serial Number: 0

**Flow Configuration**

Flow Damping: 0.00000 Sec

**Density Configuration**

Density Damping: 0.00

NOTE: Reports are sent to the default printer specified in system settings.  
Click Finish to save current test results in the database or Cancel to discard.

Save Report Print Report

< Back Finish Cancel Help



## Meter Verification

This report contains all the information supplied in the Test Definition panel, as well as information about the meter's configuration and operating conditions during the test. It indicates:

- If the meter has passed or failed the meter verification test
- If the Configuration Changed indicator was activated
- If the Zero Changed indicator was activated
- The number of meter verifications that have been performed on this meter

In addition, the graph showing the current and previous test results is included.

From this panel, you can:

- Print the report
- Save the report to a file
- Save test results to the meter verification test database
- Discard test results

To print the report, click **Print Report**. The report is sent to the default printer defined in your computer's system settings.

To save the report, click **Save Report**. It will be saved to disk as an HTML file, using the file name and location that you specify.

*Note: The Save Report button allows you to save the displayed report, but it does not save the test data. To save the test data, you must click Finish as described below.*

To save test results to the meter verification test database and close the Meter Verification dialog, click **Finish**. The test results will be saved in a database on the computer on which ProLink II is installed.

To discard current test results and close the Meter Verification dialog, click **Cancel**. The results of the current test will be discarded and will not appear on the graph in subsequent meter verification tests.



# Chapter 7

## Data Logger

### 7.1 Overview

The Data Logger tool allows periodic logging of user-selected meter data, including process variables, diagnostic variables, and output levels. Data logged via Data Logger can be viewed or imported into external programs such as spreadsheets for further analysis.

### 7.2 Using Data Logger

The Data Logger screen is shown in Figure 7-1.

To set up data logging, you must define the log file, specify the type of data to be logged and the frequency of data points, and start the logging process.

#### 7.2.1 Defining the log file

To define the log file:

1. Click the **File Type** radio button to specify the log file format. Options include:
  - **.txt** – standard text file
  - **.csv** – comma separated values, for import into standard spreadsheets
  - **.dif** – data interchange format, for import into standard spreadsheets
2. Enter the name for the log in the **Filename** textbox.
3. Click the ... button to bring up a file browser and specify the location where the log will be saved.
4. Specify **Update Rate** and unit to control the frequency of data points in the log.

*Note: If you are using HART protocol, be careful not to set Update Rate too high. On HART/Bell 202, Micro Motion suggests logging as few variables as possible, and setting the update rate to 5–10 seconds (50000–10000 msec). The same restrictions apply to HART/RS485 at lower baud rates, especially 1200 baud.*

5. Use the **Status Error Logging** checkbox to specify whether status errors will be written to the log.
6. Use the **Log On** radio buttons to specify how the data will be logged:
  - To log only when variable values change, select **Device Data Change**. An initial value will be logged for each variable as soon as the logging is started, but subsequent data points will be logged only if the values change. If process variables are stable, no data will be recorded.
  - To log data continuously irrespective of whether process data change or not, select **Time Interval**. Data will be logged continuously according to the time interval set in the **Update Rate** textbox.

## Data Logger

*Note: The log file can become very large if you choose Time Interval and log for a long period of time. Be sure to set the Update Rate accordingly.*

Figure 7-1 Data Logger

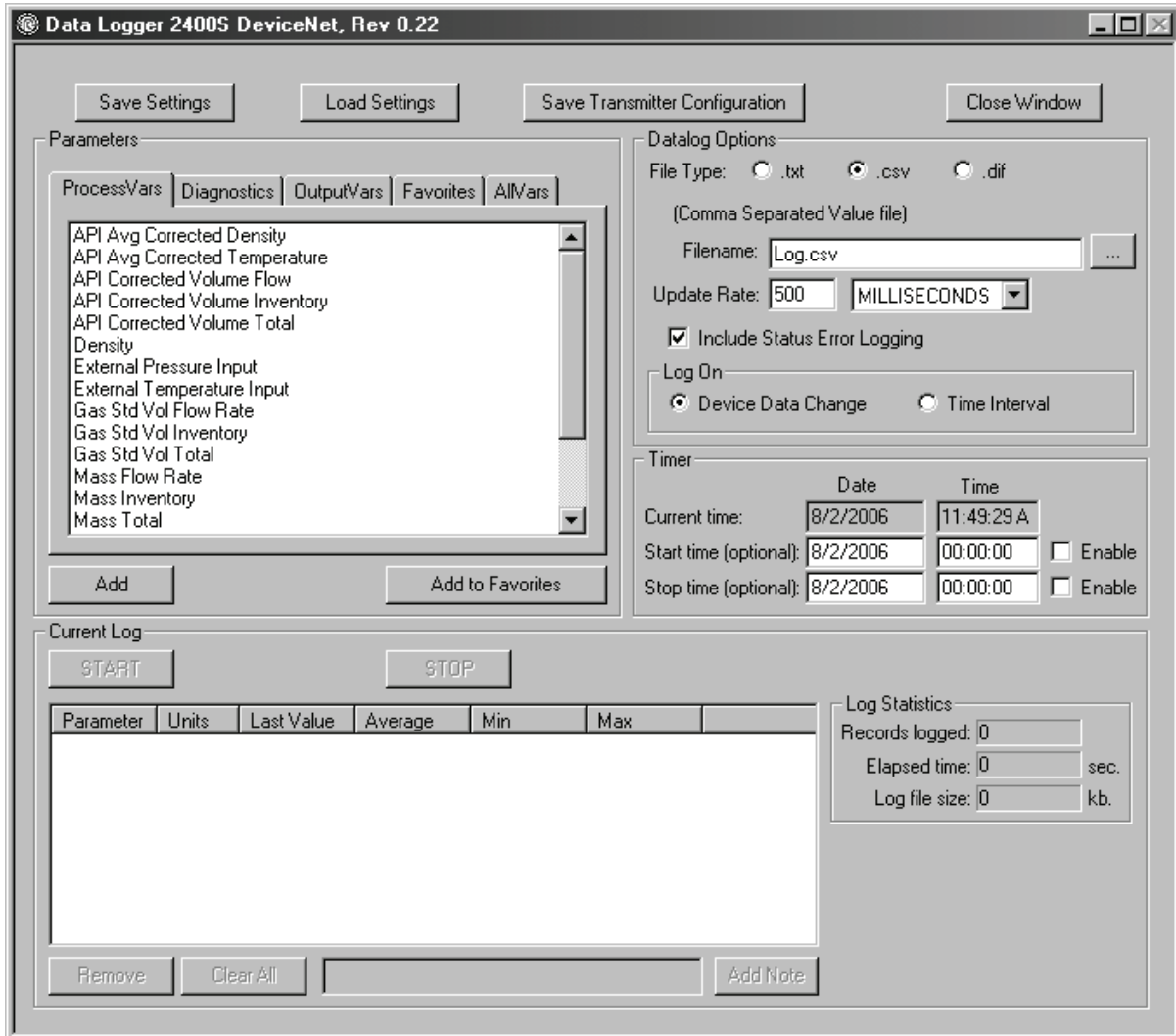

### 7.2.2 Specifying log contents

To specify the types of data to be included in the log:

1. Click on the **Process Vars**, **Diagnostics**, **Output Vars**, or **All Vars** tab.
2. Double-click on the desired variable in the list, or highlight the variable and click **Add**.
3. To remove a variable from the **Current Log** list, highlight its name and click **Remove**.
4. To remove all variables from the **Current Log** list, click the **Clear All** button.
5. While **Data Logger** is running, you can add a note to the log by entering the note in the textbox, then pressing **Add Note**. The note is added to the current end of the log; subsequent data points will be added after the note.

### 7.2.3 Starting and stopping the logging function

You can start and stop **Data Logger** either manually or automatically.

- To start and stop **Data Logger** manually, use the **Start** and **Stop** buttons in the **Current Log** area of the **Data Logger** window.
- To start **Data Logger** automatically, enter the date and time in the **Start time** fields, then check the **Enable** checkbox.
- To stop **Data Logger** automatically, enter the date and time in the **Stop time** fields, then check the **Enable** checkbox.

You can combine these methods; e.g., you can start the logging function manually and set a stop time to stop it automatically.

While **Data Logger** is running, the **Log Statistics** fields in the **Data Logger** window are continuously updated.

*Note: The **Data Logger** window must be open for logging to occur. If you close the **Data Logger** window, logging is stopped automatically.*

### 7.2.4 Data Logger tools

Data Logger provides several tools for ease of use:

- You can move specific variables to the **Favorites** tab, and work from the **Favorites** tab to add variables to the **Current Log** list. To do this, highlight a variable in the **Process Vars**, **Diagnostics**, **Output Vars**, or **All Vars** tab, then click **Add to Favorites**.
- You can save specific log configurations. To do this, click **Save Settings** and specify a file name and location.
- You can reload specific log configurations. To do this, click **Load Settings** and specify the file name and location of the log configuration file.
- You can save the current transmitter configuration to your PC. To do this, click **Save Transmitter Configuration** and specify a file name and location.

*Note: The format of this configuration file matches the format of the configuration file saved via the **File** menu. They can be used interchangeably.*



# Appendix A

## Transmitter Terminal Reference

### A.1 Overview

This appendix provides diagrams of the transmitter terminals that can be used for a ProLink II connection. The following transmitters are shown:

- RFT9739, RFT9712, and IFT9701/9703 transmitters (see Figure A-1)
- Model 1500/2500 transmitters (see Figure A-2)
- Model 1700/2700 transmitters (see Figure A-3)
- Model 2400S transmitters with analog outputs (see Figure A-4)
- Model 2400S transmitters with DeviceNet I/O (see Figure A-5)
- Model 2400S transmitters with PROFIBUS-DP I/O (see Figure A-6)
- Series 3000 transmitters (see Figure A-7)
- Core processor and Enhanced core processor (see Figure A-8)
- MVD Direct Connect I.S. barrier (see Figure A-9)

For detailed instructions on connecting ProLink II to your transmitter, see Chapter 2.

Transmitter Terminal Reference

A.2 Transmitter terminal diagrams

Figure A-1 RFT9739, RFT9712, and IFT9701/9793 transmitters

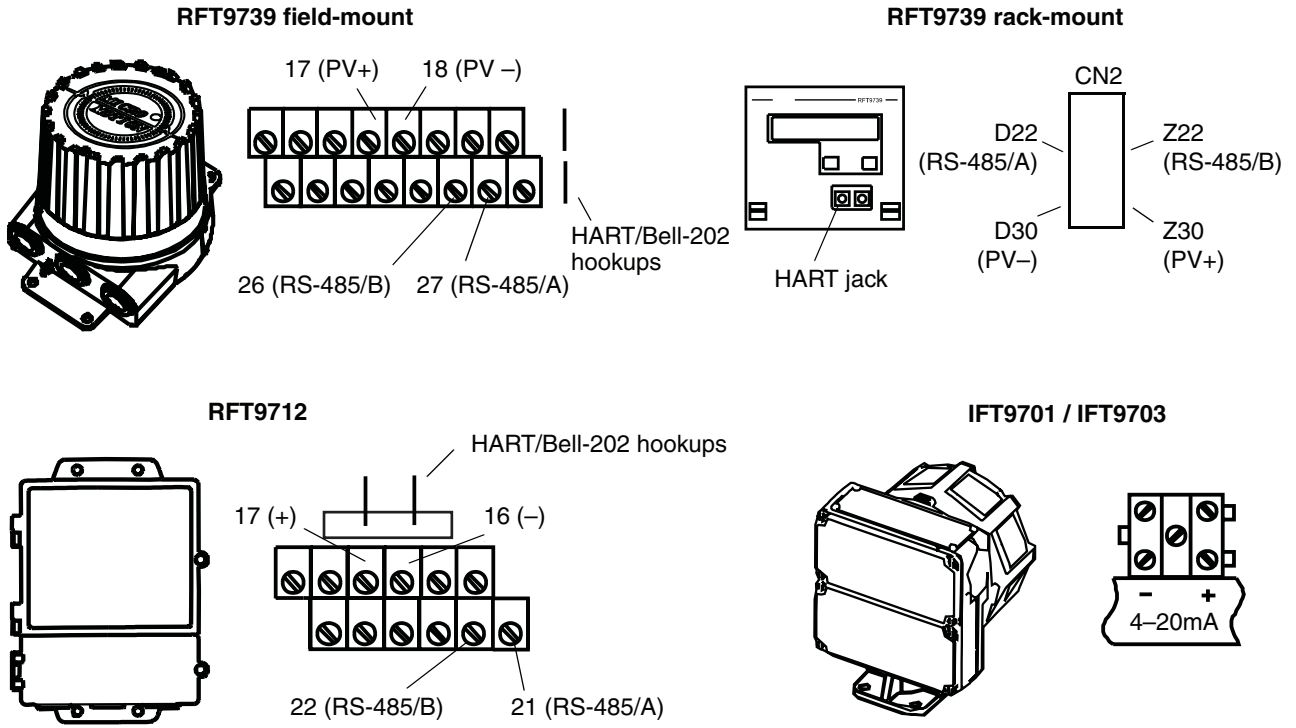

Figure A-2 Model 1500/2500 transmitters

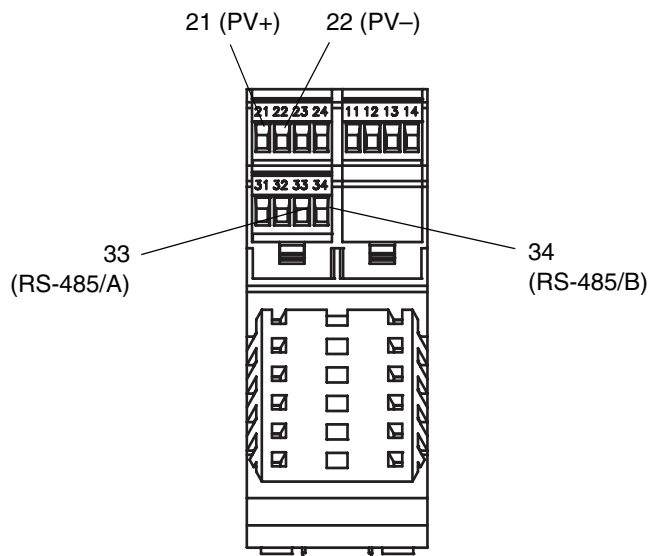
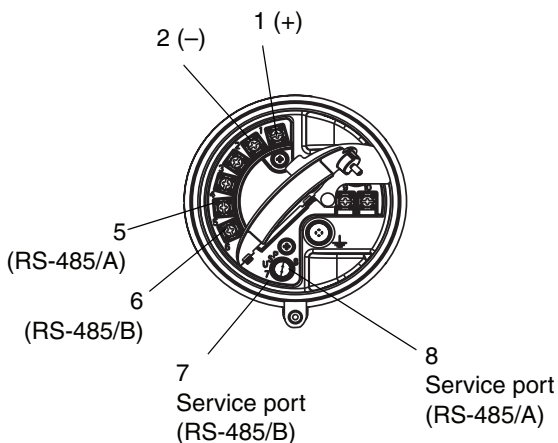

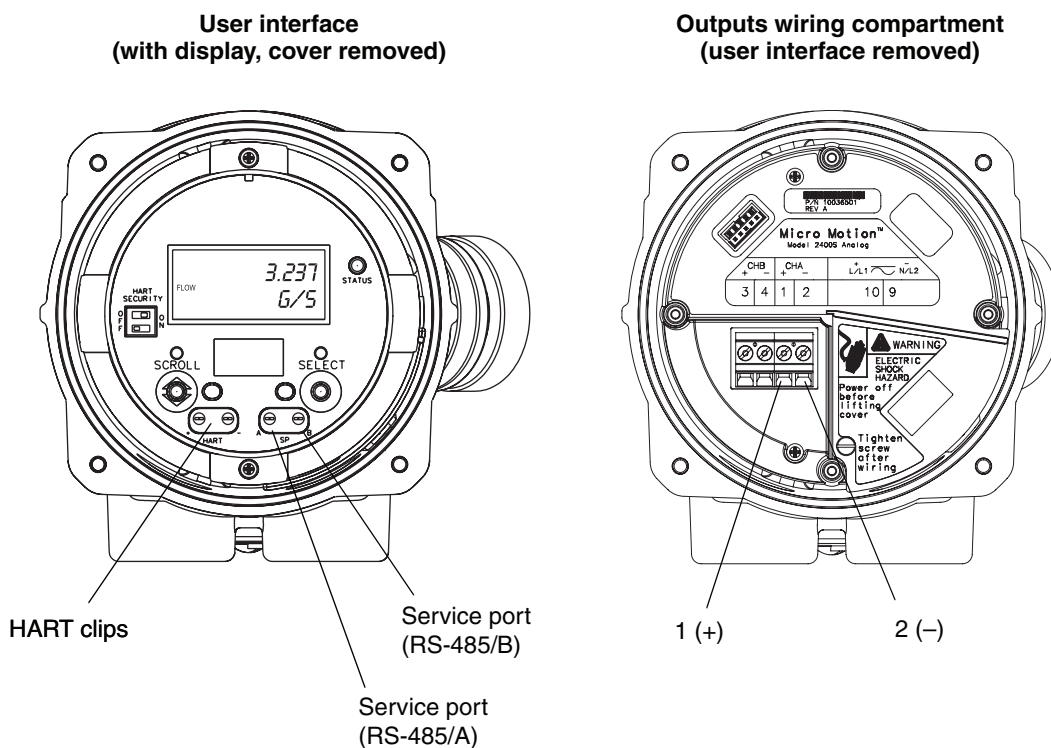

Figure A-3 Model 1700/2700 transmitters



Note: Terminals 5 and 6 used for communications only by transmitters with the analog outputs option board.

Figure A-4 Model 2400S transmitters with analog outputs



Note: The user interface shown here is equipped with a display. On models without a display, the HART clips and service port clips are located in the same position on the user interface.

## Transmitter Terminal Reference

Figure A-5 Model 2400S transmitters with DeviceNet I/O

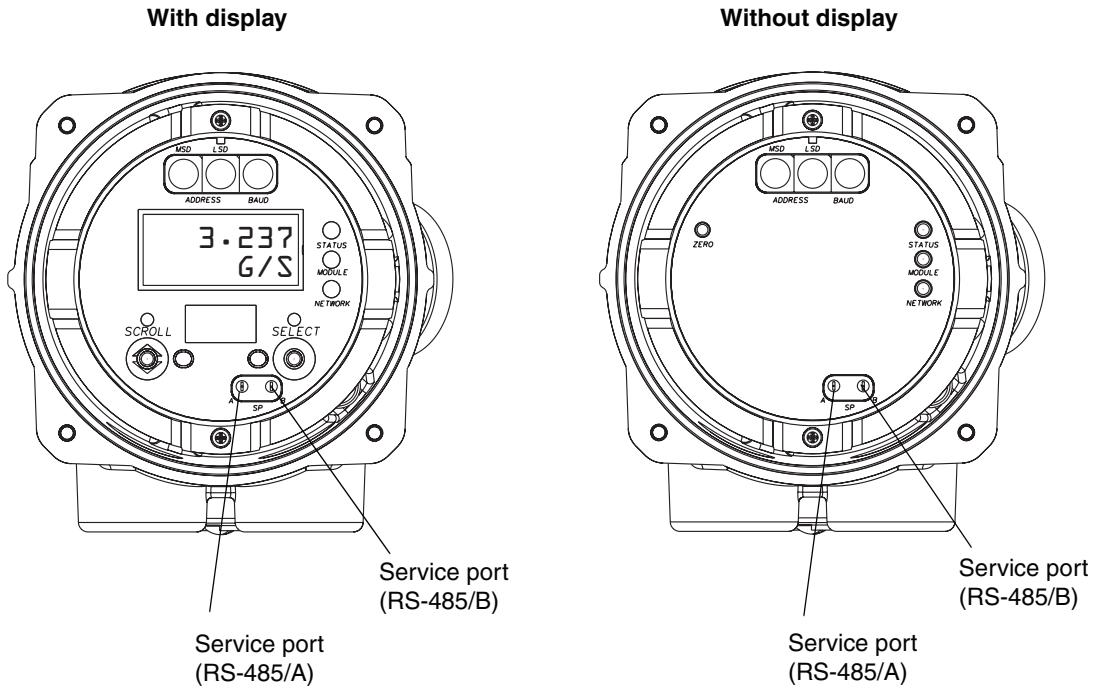
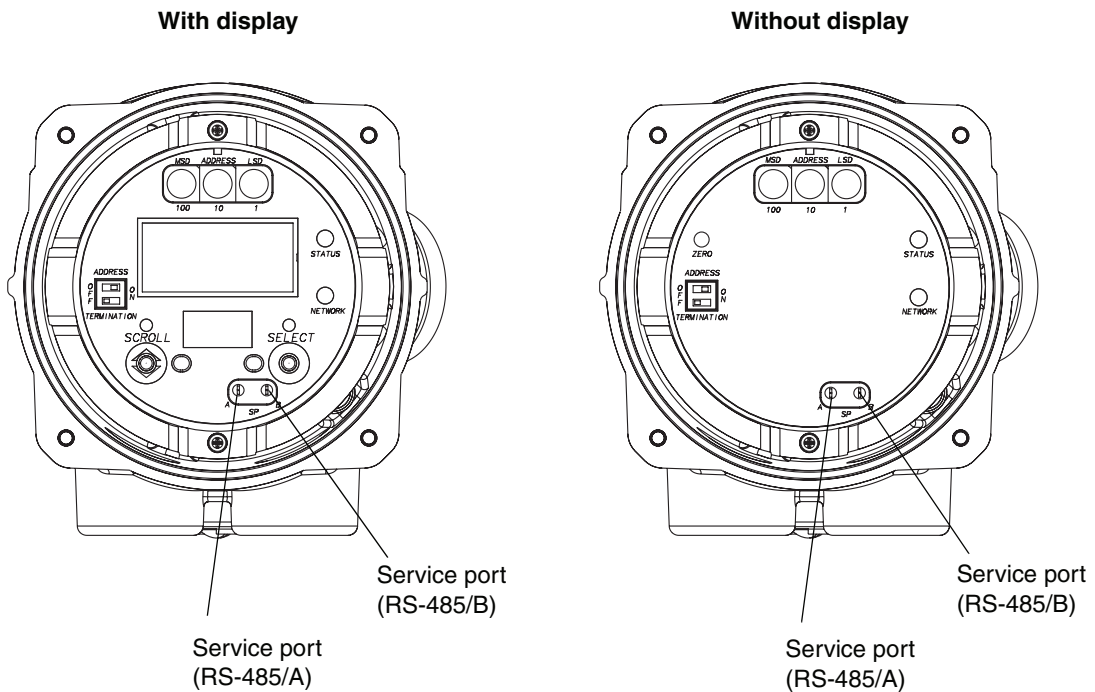

Figure A-6 Model 2400S transmitters with PROFIBUS-DP I/O



# Transmitter Terminal Reference

Figure A-7 Series 3000 transmitters

Series 3000 panel-mount

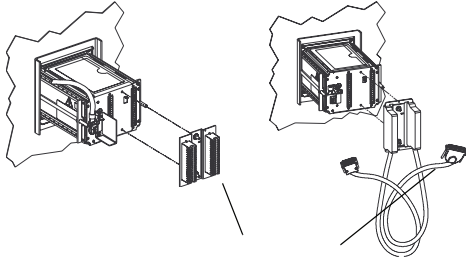

Input/output wiring terminals

Series 3000 rack-mount

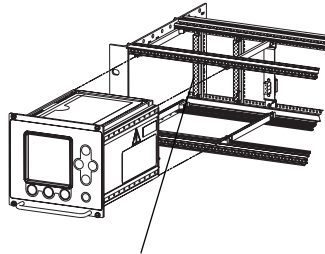

Input/output wiring terminals

Series 3000 field-mount

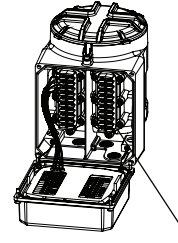

Input/output wiring terminals

Card for Model 3300 or 3500 with screw-type or solder-tail terminals

|    | c | a |              |
|----|---|---|--------------|
| 2  | + | - | 4-20 mA HART |
| 4  | + | - | 4-20 mA      |
| 6  | + | - |              |
| 8  | + | - | Discrete 1   |
| 10 | + | - | Discrete 2   |
| 12 | + | - |              |
| 14 | + | - | Discrete 1   |
| 16 | + | - | Discrete 2   |
| 18 | + | - | Discrete 3   |
| 20 |   |   |              |
| 22 |   |   |              |
| 24 |   |   |              |
| 26 | ● |   | Comm 1       |
|    | ● |   | Comm 2       |
| 28 | ● |   | Comm 3       |
| 30 |   |   |              |
| 32 | B | A | RS 485       |

Label for Model 3300 or 3500 with I/O cables

|    |   |            |  |
|----|---|------------|--|
| 1  | + | 4-20 mA    |  |
| 2  | - | mA         |  |
| 3  | + |            |  |
| 4  | - | Discrete 1 |  |
| 5  | + | 1          |  |
| 6  | - | Discrete 2 |  |
| 7  | + | 2          |  |
| 8  | - | Discrete 3 |  |
| 9  | + | Discrete 1 |  |
| 10 | - | Discrete 2 |  |
| 11 | + | Discrete 3 |  |
| 12 | - | COMM 1     |  |
| 13 | + | COMM 2     |  |
| 14 | - | COMM 3     |  |
| 15 | + | RS485      |  |
| 16 | - | B          |  |
| 17 | + | A          |  |
| 18 | - | PN         |  |
| 19 | + |            |  |
| 20 | - |            |  |
| 21 | + |            |  |
| 22 | - |            |  |
| 23 | + |            |  |
| 24 | - |            |  |
| 25 | + |            |  |
| 26 | - |            |  |

Label for Model 3350 or 3700

|     |   |       |       |                |        |
|-----|---|-------|-------|----------------|--------|
| 1   | - | (1)   | (11)  | (B)            | RS 485 |
| 2   | + | (2)   | (12)  | (A)            |        |
| 3   | - | (3)   | (13)  |                |        |
| 4   | + | (4)   | (14)  |                |        |
| 5   | - | (5)   | (15)  |                |        |
| 6   | + | (6)   | (16)  |                |        |
| 7   | - | (7)   | (17)  | [+] Discrete 3 |        |
| 8   | + | (8)   | (18)  | [+] Discrete 2 |        |
| 9   | - | (9)   | (19)  | [+] Discrete 1 |        |
| 10  | + | (10)  | (20)  | [+] Discrete 1 |        |
| 11  | - | (11)  | (21)  | [+] Discrete 1 |        |
| 12  | + | (12)  | (22)  | [+] Discrete 1 |        |
| 13  | - | (13)  | (23)  | [+] Discrete 1 |        |
| 14  | + | (14)  | (24)  | [+] Discrete 1 |        |
| 15  | - | (15)  | (25)  | [+] Discrete 1 |        |
| 16  | + | (16)  | (26)  | [+] Discrete 1 |        |
| 17  | - | (17)  | (27)  | [+] Discrete 1 |        |
| 18  | + | (18)  | (28)  | [+] Discrete 1 |        |
| 19  | - | (19)  | (29)  | [+] Discrete 1 |        |
| 20  | + | (20)  | (30)  | [+] Discrete 1 |        |
| 21  | - | (21)  | (31)  | [+] Discrete 1 |        |
| 22  | + | (22)  | (32)  | [+] Discrete 1 |        |
| 23  | - | (23)  | (33)  | [+] Discrete 1 |        |
| 24  | + | (24)  | (34)  | [+] Discrete 1 |        |
| 25  | - | (25)  | (35)  | [+] Discrete 1 |        |
| 26  | + | (26)  | (36)  | [+] Discrete 1 |        |
| 27  | - | (27)  | (37)  | [+] Discrete 1 |        |
| 28  | + | (28)  | (38)  | [+] Discrete 1 |        |
| 29  | - | (29)  | (39)  | [+] Discrete 1 |        |
| 30  | + | (30)  | (40)  | [+] Discrete 1 |        |
| 31  | - | (31)  | (41)  | [+] Discrete 1 |        |
| 32  | + | (32)  | (42)  | [+] Discrete 1 |        |
| 33  | - | (33)  | (43)  | [+] Discrete 1 |        |
| 34  | + | (34)  | (44)  | [+] Discrete 1 |        |
| 35  | - | (35)  | (45)  | [+] Discrete 1 |        |
| 36  | + | (36)  | (46)  | [+] Discrete 1 |        |
| 37  | - | (37)  | (47)  | [+] Discrete 1 |        |
| 38  | + | (38)  | (48)  | [+] Discrete 1 |        |
| 39  | - | (39)  | (49)  | [+] Discrete 1 |        |
| 40  | + | (40)  | (50)  | [+] Discrete 1 |        |
| 41  | - | (41)  | (51)  | [+] Discrete 1 |        |
| 42  | + | (42)  | (52)  | [+] Discrete 1 |        |
| 43  | - | (43)  | (53)  | [+] Discrete 1 |        |
| 44  | + | (44)  | (54)  | [+] Discrete 1 |        |
| 45  | - | (45)  | (55)  | [+] Discrete 1 |        |
| 46  | + | (46)  | (56)  | [+] Discrete 1 |        |
| 47  | - | (47)  | (57)  | [+] Discrete 1 |        |
| 48  | + | (48)  | (58)  | [+] Discrete 1 |        |
| 49  | - | (49)  | (59)  | [+] Discrete 1 |        |
| 50  | + | (50)  | (60)  | [+] Discrete 1 |        |
| 51  | - | (51)  | (61)  | [+] Discrete 1 |        |
| 52  | + | (52)  | (62)  | [+] Discrete 1 |        |
| 53  | - | (53)  | (63)  | [+] Discrete 1 |        |
| 54  | + | (54)  | (64)  | [+] Discrete 1 |        |
| 55  | - | (55)  | (65)  | [+] Discrete 1 |        |
| 56  | + | (56)  | (66)  | [+] Discrete 1 |        |
| 57  | - | (57)  | (67)  | [+] Discrete 1 |        |
| 58  | + | (58)  | (68)  | [+] Discrete 1 |        |
| 59  | - | (59)  | (69)  | [+] Discrete 1 |        |
| 60  | + | (60)  | (70)  | [+] Discrete 1 |        |
| 61  | - | (61)  | (71)  | [+] Discrete 1 |        |
| 62  | + | (62)  | (72)  | [+] Discrete 1 |        |
| 63  | - | (63)  | (73)  | [+] Discrete 1 |        |
| 64  | + | (64)  | (74)  | [+] Discrete 1 |        |
| 65  | - | (65)  | (75)  | [+] Discrete 1 |        |
| 66  | + | (66)  | (76)  | [+] Discrete 1 |        |
| 67  | - | (67)  | (77)  | [+] Discrete 1 |        |
| 68  | + | (68)  | (78)  | [+] Discrete 1 |        |
| 69  | - | (69)  | (79)  | [+] Discrete 1 |        |
| 70  | + | (70)  | (80)  | [+] Discrete 1 |        |
| 71  | - | (71)  | (81)  | [+] Discrete 1 |        |
| 72  | + | (72)  | (82)  | [+] Discrete 1 |        |
| 73  | - | (73)  | (83)  | [+] Discrete 1 |        |
| 74  | + | (74)  | (84)  | [+] Discrete 1 |        |
| 75  | - | (75)  | (85)  | [+] Discrete 1 |        |
| 76  | + | (76)  | (86)  | [+] Discrete 1 |        |
| 77  | - | (77)  | (87)  | [+] Discrete 1 |        |
| 78  | + | (78)  | (88)  | [+] Discrete 1 |        |
| 79  | - | (79)  | (89)  | [+] Discrete 1 |        |
| 80  | + | (80)  | (90)  | [+] Discrete 1 |        |
| 81  | - | (81)  | (91)  | [+] Discrete 1 |        |
| 82  | + | (82)  | (92)  | [+] Discrete 1 |        |
| 83  | - | (83)  | (93)  | [+] Discrete 1 |        |
| 84  | + | (84)  | (94)  | [+] Discrete 1 |        |
| 85  | - | (85)  | (95)  | [+] Discrete 1 |        |
| 86  | + | (86)  | (96)  | [+] Discrete 1 |        |
| 87  | - | (87)  | (97)  | [+] Discrete 1 |        |
| 88  | + | (88)  | (98)  | [+] Discrete 1 |        |
| 89  | - | (89)  | (99)  | [+] Discrete 1 |        |
| 90  | + | (90)  | (100) | [+] Discrete 1 |        |
| 91  | - | (91)  | (101) | [+] Discrete 1 |        |
| 92  | + | (92)  | (102) | [+] Discrete 1 |        |
| 93  | - | (93)  | (103) | [+] Discrete 1 |        |
| 94  | + | (94)  | (104) | [+] Discrete 1 |        |
| 95  | - | (95)  | (105) | [+] Discrete 1 |        |
| 96  | + | (96)  | (106) | [+] Discrete 1 |        |
| 97  | - | (97)  | (107) | [+] Discrete 1 |        |
| 98  | + | (98)  | (108) | [+] Discrete 1 |        |
| 99  | - | (99)  | (109) | [+] Discrete 1 |        |
| 100 | + | (100) | (110) | [+] Discrete 1 |        |

**Transmitter Terminal Reference**

**Figure A-8 Core processor**

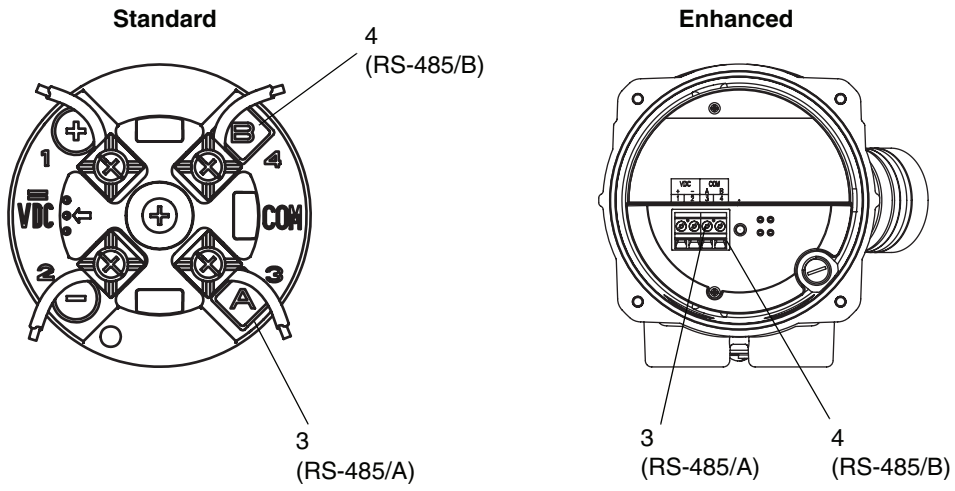

**Figure A-9 MVD Direct Connect I.S. barrier**

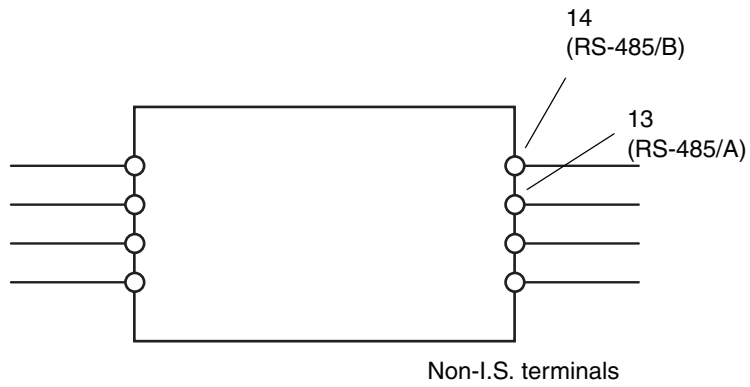

# Appendix B

## Configuring the Discrete Batch Application

### B.1 About this appendix

This appendix explains how to configure the discrete batch application, and provides basic information on batch operation.

*Note: For more detailed information on operating the discrete batch application, see the Series 3000 MVD transmitter manual.*

*Note: The discrete batch application is an optional feature, and may not be installed on your transmitter. To verify that it is installed, use the Installed Options item on the ProLink II View menu.*

*Note: For full ProLink II functionality for the discrete batch application, you must connect to the transmitter using a Modbus connection. If you are using a HART connection, only limited functionality is available.*

#### CAUTION

**Changing configuration can affect transmitter operation, including batching.**

Changes made to discrete batch configuration while a batch is running do not take effect until the batch is ended. Changes made to other configuration parameters may affect batching. To ensure correct batching, do not make any configuration changes while a batch is in progress.

### B.2 About discrete batching

Discrete batching is used to start flow, then stop flow automatically when the target amount of process fluid has flowed through the sensor. During a batch, flow may be stopped and resumed. A batch may also be ended before the target is reached.

### B.3 Discrete batch configuration

To configure batching:

1. Open the ProLink II **Configuration** window.
2. Click on the **Discrete Batch** tab. The panel shown in Figure B-1 is displayed. In this panel:
  - a. Configure flow source (see Section B.3.1) and click **Apply**.
  - b. Configure control options (see Section B.3.2) and click **Apply**.
  - c. Configure one or more presets, if desired (see Section B.3.3) and click **Apply**.

## Configuring the Discrete Batch Application

Figure B-1 Discrete batch configuration panel

Configuration 3500, Rev 5.98

Flow | Density | Temperature | Pressure | Sensor | Special Units | T Series Config | Events | Analog Output | Frequency  
Frequency Input | Variable Mapping | Device | RS-485 | Display Config | Discrete Output | Discrete Input  
Polled Variables | Transmitter Options | ED Setup | ED Curve Config | Printer | System | Modbus | Discrete Batch

Flow Source: Mass Flow Rate

**Control Options**

- Enable Batch
- Count Up
- Enable ADC
- Lockout Target
- Auto Print at Batch End
- Reset on Start
- Enable End Warning
- Enable Overrun
- Ignore Source Alarms

No-Flow Timeout: 10.00000 Sec

Number of Stages: 1 Stage

Number of Decimals: 1

Maximum Target: 100.00000 g

Alarm Timeout: 1.00000 Min

Configure Presets By: % Target

**Configure Presets**

Preset Number: Preset 1

Preset Name: Preset 1

Enable Preset

Open Primary: 0.00000 %

Open Secondary: 0.00000 %

Close Primary: 80.00000 %

End Warning: 80.00000 %

Density Curve: None

Overrun: 0.00000 g

Preset Target: 0.00000 g

OK Cancel Apply

3. Click on the **Discrete IO** or **Discrete Output** tab. A panel similar to Figure B-2 is displayed. In this panel:

a. Configure the required discrete outputs.

- For 1-stage operation, you must configure one discrete output. This output must control either the pump or the primary valve, as appropriate to your application. This discrete output is required.
- For 2-stage operation, you must configure either two or three discrete outputs: one to control the primary valve (required), one to control the secondary valve (required), and one to control the pump (optional; only if required by your installation).

You must configure the discrete outputs that are listed as required, whether or not your installation uses them (for example, you may start and stop the pump manually). You will not be able to start a batch until the required discrete outputs have been configured.

b. Click **Apply**.

## Configuring the Discrete Batch Application

Figure B-2 Discrete IO panel

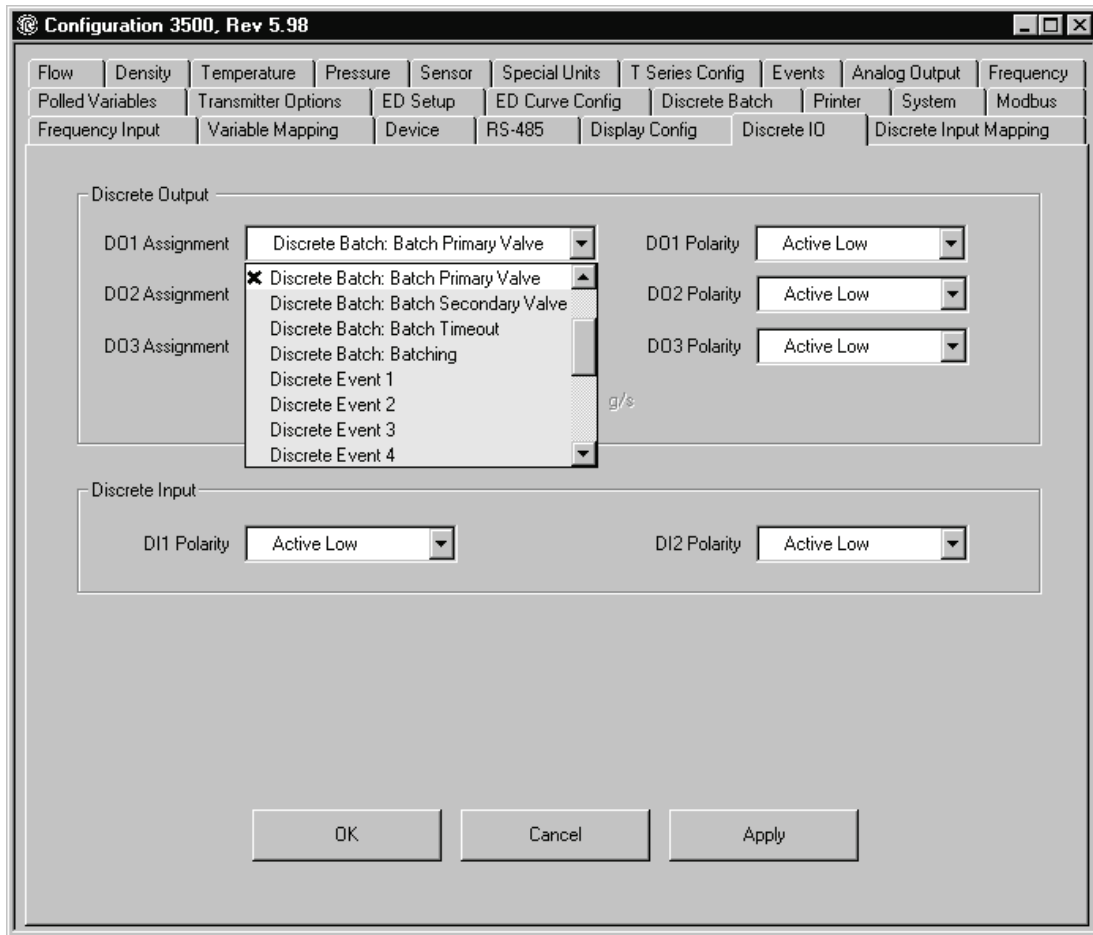

4. If desired, you can assign a batch control function to a discrete input or discrete event. See Section B.3.4.
5. If you enabled the Batch AOC control option, you should perform batch AOC (automatic overshoot compensation) calibration. Batch AOC is used to minimize the amount of overshoot per batch. See Section B.5.
6. You may optionally configure the batch ticket and ticket printing. Printer and ticket options are displayed on the **Printer** panel of the **Configuration** window. For more information on printer and ticket setup, see the Series 3000 transmitter manual.

### B.3.1 Flow source

The flow source specifies the flow variable that will be used for batch measurement. Select one of the flow sources defined in Table B-1.

## Configuring the Discrete Batch Application

**Table B-1 Flow sources**

| Flow source                           | Default | Description   |
|---------------------------------------|---------|---|
| None                                  | None    | <ul style="list-style-type: none"> <li>Batch controller is disabled.</li> <li>START button will not appear on display.</li> </ul>   |
| Frequency input                       |         | <ul style="list-style-type: none"> <li>Frequency input from a Micro Motion IFT9701 or RFT9739 transmitter</li> <li>Frequency input from a pulse output device</li> </ul>  |
| Mass flow rate                        |         | Mass flow rate from Series 3000 transmitter   |
| Volume flow rate                      |         | Volume flow rate from Series 3000 transmitter   |
| ED std vol flow rate                  |         | <ul style="list-style-type: none"> <li>Standard volume flow rate at reference temperature</li> <li>Standard volume flow is available only if the enhanced density application software is installed and configured to indicate standard volume flow.</li> </ul> |
| ED mass flow rate                     |         | <ul style="list-style-type: none"> <li>Net mass flow rate</li> <li>Net mass flow is available only if the enhanced density application software is installed and configured to indicate net mass flow.</li> </ul>   |
| ED vol flow rate                      |         | <ul style="list-style-type: none"> <li>Net volume flow rate at reference temperature</li> <li>Net volume flow is available only if the enhanced density application software is installed and configured to indicate net volume flow.</li> </ul>                |
| API temperature-corrected volume flow |         | <ul style="list-style-type: none"> <li>Volume flow adjusted by the calculated volume correction factor</li> <li>Available only if the petroleum measurement application is installed and enabled.</li> </ul>  |

### B.3.2 Control options

The batch control options are used to manage the batch process. Control options are listed and defined in Table B-2.

*Note: Control options apply to all batch presets.*

**Table B-2 Control options**

| Setting        | Default | Description   |
|----------------|---------|---|
| Enable batch   | Yes     | <ul style="list-style-type: none"> <li>Select Yes to enable the discrete batch application.</li> <li>Select No to disable the discrete batch application. The operation mode will default to the process monitor.</li> </ul>  |
| Count up       | Yes     | <ul style="list-style-type: none"> <li>If set to Yes, the total displayed on screen increases from zero to the target value.</li> <li>If set to No, the total displayed on screen decreases from the target value to zero</li> <li>The setting of the Count up control option affects only the quantity displayed on screen. It does not affect configuration of presets.</li> <li>If the custody transfer application is installed, Count up is set to Yes and cannot be changed.</li> </ul> |
| Enable AOC     | Yes     | <ul style="list-style-type: none"> <li>Select Yes to enable Automatic Overshoot Compensation (AOC).</li> <li>When batch AOC is enabled and batch AOC calibration has been performed, the batch controller compensates for the time required to close the valve.</li> <li>If Enable AOC is set to Yes, batch AOC calibration is required to provide data for the compensation process. To perform batch AOC calibration, see Section B.5.</li> </ul>   |
| Lockout target | No      | <ul style="list-style-type: none"> <li>If set to Yes, the operator cannot change the current target from the batch operation screen or the ProLink II Batcher Control panel.</li> <li>If set to No, the operator can change the batch target when a batch is not running.</li> </ul>  |



## Configuring the Discrete Batch Application

**Table B-2 Control options** *continued*

| Setting              | Default      | Description   |
|----------------------|--------------|---|
| Reset on start       | No           | <ul style="list-style-type: none"> <li>• If set to Yes, the batch totalizer resets when the operator starts the batch.</li> <li>• If set to No, the operator must reset the batch before starting a new batch. Several methods are available for resetting the batch. See Section B.3.4.</li> <li>• If the custody transfer application is installed, Reset on start is set to No and cannot be changed.</li> </ul>   |
| Enable end warning   | No           | <ul style="list-style-type: none"> <li>• Select Yes to enable the end warning.</li> <li>• When end warning is enabled and an end warning value has been entered for the selected preset, a discrete output can be configured to indicate the end warning.</li> <li>• End warning is a status indicator only, and does not affect valve operation.</li> <li>• End warning will remain active until batch completion.</li> </ul>  |
| Enable overrun       | No           | <ul style="list-style-type: none"> <li>• Select Yes to enable overrun indication.</li> <li>• When overrun is enabled and an overrun value has been entered for the selected preset, the batch controller produces an overrun alarm when the batch total exceeds the target by more than the programmed overrun amount.</li> <li>• Overrun can be assigned to a discrete output, using the Discrete IO panel in the ProLink II Configuration window.</li> </ul>                        |
| Ignore source alarms | No           | <p>A source alarm is any fault-level alarm. If Ignore source alarms:</p> <ul style="list-style-type: none"> <li>• Is set to Yes, the batch will not stop for the duration of the alarm timeout.</li> <li>• Is set to No, the batch is stopped as soon as the alarm condition occurs.</li> </ul> <p>If the custody transfer application is installed, Ignore source alarms is set to No and cannot be changed.</p>   |
| No-flow timeout      | 10.00000 Sec | <ul style="list-style-type: none"> <li>• The time out period specifies how long the batch controller will wait before posting an alarm if flow stops or the batch totalizer is inhibited while a batch is running.</li> <li>• Enter a value of 0.0 to 300.0.</li> <li>• Time out is disabled if set to 0.0 seconds.</li> <li>• Time out can be assigned to a discrete output, using the Discrete IO panel in the ProLink II Configuration window.</li> </ul>                          |
| Number of stages     | 1 Stage      | Specify 1 Stage or 2 Stage. See the discussion in Section .   |
| Number of decimals   | 1            | <ul style="list-style-type: none"> <li>• Enter a value of 0 to 5.</li> <li>• This value specifies the number of digits to the right of the decimal point on the operation screen.</li> </ul>  |
| Maximum target       | 1.0000E9 kg  | If Lockout target is set to No, enter the maximum target that the operator will be allowed to set in the batch operation mode.  |
| Alarm timeout        | 1.00000 Min  | <p>This parameter is applicable only if Ignore source alarms is set to Yes.</p> <ul style="list-style-type: none"> <li>• Enter the number of minutes, from 1 to 20, for which source alarms will be ignored.</li> <li>• If the alarm condition is present when the alarm timeout expires, the current batch is stopped.</li> </ul>  |
| Configure presets by | % Target     | <p>Select % Target or Quantity.</p> <ul style="list-style-type: none"> <li>• If set to % Target, Open primary, Open secondary, Close primary, and End warning values are configured as a percentage of the batch target.</li> <li>• If set to Quantity, Open primary and Open secondary are each configured as a quantity at which the valve should open; Close primary and End warning values are each configured as a quantity that is subtracted from the batch target.</li> </ul> |

## Configuring the Discrete Batch Application

### One-stage versus two-stage batching

If **Number of stages** is set to 1, a single pump or valve is used to control the batch. When the batch is started, the pump starts or the valve opens; at the configured target, the pump stops or the valve closes. **Open primary**, **Open secondary**, and **Close primary** values are not required when configuring the preset (see Section B.3.3).

If **Number of stages** is set to 2, two valves are used to control the batch, and the following requirements apply when configuring the preset:

- Both **Open primary** and **Open secondary** must be configured.
- Either **Open primary** or **Open secondary** must be set to 0. Both may be set to 0 if desired.
- **Close primary** must be configured.

### B.3.3 Configure presets

You can configure up to six batch presets. Preset 1 cannot be disabled, but you can change its configuration.

Table B-3 defines the options for configuring presets. To configure a preset, first select the preset to be configured, then define its parameters.

**Table B-3 Preset parameters**

| Setting                       | Default  | Description   |
|-------------------------------|--|---|
| Name                          | <ul style="list-style-type: none"> <li>• Preset 1</li> <li>• Preset 2</li> <li>• Preset 3</li> <li>• Preset 4</li> <li>• Preset 5</li> <li>• Preset 6</li> </ul> | <ul style="list-style-type: none"> <li>• Enter the name that will appear on operation screens and in preset selection menus.</li> <li>• A maximum of 22 characters can be stored.</li> </ul>  |
| Enable preset                 | <ul style="list-style-type: none"> <li>• Yes for preset 1</li> <li>• No for presets 2-6</li> </ul>   | <ul style="list-style-type: none"> <li>• If set to Yes, the batch preset can be selected for use. See Section B.4.</li> <li>• If set to No, the batch preset is disabled and cannot be selected.</li> <li>• Preset 1 cannot be disabled.</li> </ul>   |
| Open primary <sup>(1)</sup>   | 0.00% of target or 0.0 kg quantity   | <ul style="list-style-type: none"> <li>• Enter the quantity or the percent of the target at which the primary valve will open. See the examples later in this section.</li> <li>• Either Open primary or Open secondary must be set to 0. If one of these parameters is set to a non-zero value, the other is set to 0 automatically</li> <li>• Before a batch can be started, the primary valve must be assigned to a discrete output. See Section B.3, Step 3.</li> </ul>     |
| Open secondary <sup>(1)</sup> | 0.00% of target or 0.0 kg quantity   | <ul style="list-style-type: none"> <li>• Enter the quantity or the percent of the target at which the secondary valve will open. See the examples later in this section.</li> <li>• Either Open primary or Open secondary must be set to 0. If one of these parameters is set to a non-zero value, the other is set to 0 automatically</li> <li>• Before a batch can be started, the secondary valve must be assigned to a discrete output. See Section B.3, Step 3.</li> </ul> |
| Close primary <sup>(1)</sup>  | 80.00% of target or 0.0 kg quantity  | <ul style="list-style-type: none"> <li>• Enter the quantity subtracted from the target, or the percent of the target, at which the primary valve will close. See the examples later in this section.</li> <li>• The secondary valve always closes when the target is achieved.</li> <li>• Before a batch can be started, the primary valve must be assigned to a discrete output. See Section B.3, Step 3.</li> </ul>   |
| End warning <sup>(2)</sup>    | 80.00% of target or 0.0 kg quantity  | <ul style="list-style-type: none"> <li>• If End warning is enabled as a control option, enter the quantity subtracted from the target, or the percent of the target, at which the end warning will occur. See the examples later in this section.</li> <li>• End warning can be assigned to a discrete output, using the Discrete IO panel in the ProLink II Configuration window.</li> </ul>   |

## Configuring the Discrete Batch Application

**Table B-3** Preset parameters *continued*

| Setting                | Default | Description  |
|------------------------|---------|--|
| Density curves         | None    | If an enhanced density variable is selected as the flow source, you must select a density curve that will apply to this preset. The batch total will be based on the density curve for that variable.  |
| Overrun <sup>(3)</sup> | 0.0 kg  | <ul style="list-style-type: none"> <li>If Overrun is enabled as a control option, enter the amount over the target value at which batch overrun will be indicated. For example, if the target is 250 kilograms and overrun should be indicated at 280 kilograms, enter 30.</li> <li>Overrun can be assigned to a discrete output, using the Discrete IO panel in the ProLink II Configuration window.</li> </ul> |
| Target <sup>(4)</sup>  | 0.0 kg  | Enter the total at which the batch will be completed.  |

(1) This parameter is configurable only if Number of stages was set to 2.

(2) This parameter is configurable only if Enable end warning was set to Yes.

(3) This parameter is configurable only if Enable overrun was set to Yes.

(4) A non-zero value must be configured for Target before a batch can be started.

### Batch preset examples

The following examples describe the batch processing sequence for two different batch preset configurations.

*Note: For a detailed presentation of batch processing sequences, including how the **STOP** and **RESUME** functions affect processing, see the Series 3000 MVD transmitter manual.*

#### Example 1

Configure presets by quantity under the following conditions:

- The target is 200 kilograms
- The primary valve opens at the start of the batch and closes when 180 kilograms have been delivered
- The secondary valve opens when 100 kilograms have been delivered
- The end warning occurs when 160 kilograms have been delivered

Close primary = 200 kilograms – 180 kilograms = 20

Open secondary = 100 kilograms

End warning = 200 kilograms – 160 kilograms = 40

## Configuring the Discrete Batch Application

### Example 2

Configure presets by percent of target under the following conditions:

- The target is 200 kilograms
- The primary valve opens at the start of the batch and closes when 180 kilograms have been delivered
- The secondary valve opens when 100 kilograms have been delivered
- The end warning occurs when 160 kilograms have been delivered

$$\text{Close primary} = \frac{180 \text{ kilograms}}{200 \text{ kilograms}} = 0.90$$

Since 0.90 equals 90%, enter a close primary value of 90.

$$\text{Open secondary} = \frac{100 \text{ kilograms}}{200 \text{ kilograms}} = 0.50$$

Since 0.50 equals 50%, enter an open secondary value of 50.

$$\text{End warning} = \frac{160 \text{ kilograms}}{200 \text{ kilograms}} = 0.80$$

Since 0.80 equals 80%, enter an end warning value of 80.

### B.3.4 Batch control methods

Batch control functions can be performed in three ways:

- By using the function buttons on the transmitter display (see the Series 3000 transmitter manual), or in the ProLink II **Batcher Control** window (see Section B.4)
- By assigning a discrete input to a batch control function
- By assigning a discrete event to a batch control function

If a discrete input or discrete event is assigned to a batch control function, the function is triggered when the discrete input or discrete event is in an On state.

Table B-4 lists the batch control functions. To assign a discrete input or discrete event to trigger a batch function:

1. Open the ProLink II **Configuration** window and click on the **Discrete Input Mapping** tab. The panel shown in Figure B-3 is displayed.
2. Select the batch function to be triggered. Batch functions are listed and defined in Table B-4.
3. Specify the method which will be used to trigger the batch function: Discrete Event 1–5 or Discrete Input 1–2.

*Note: You can assign one or more actions to a single discrete input or discrete event. All assigned actions will be performed, as allowed by the configuration and current state of the discrete batch application.*

## Configuring the Discrete Batch Application

Figure B-3 Discrete Input Mapping panel

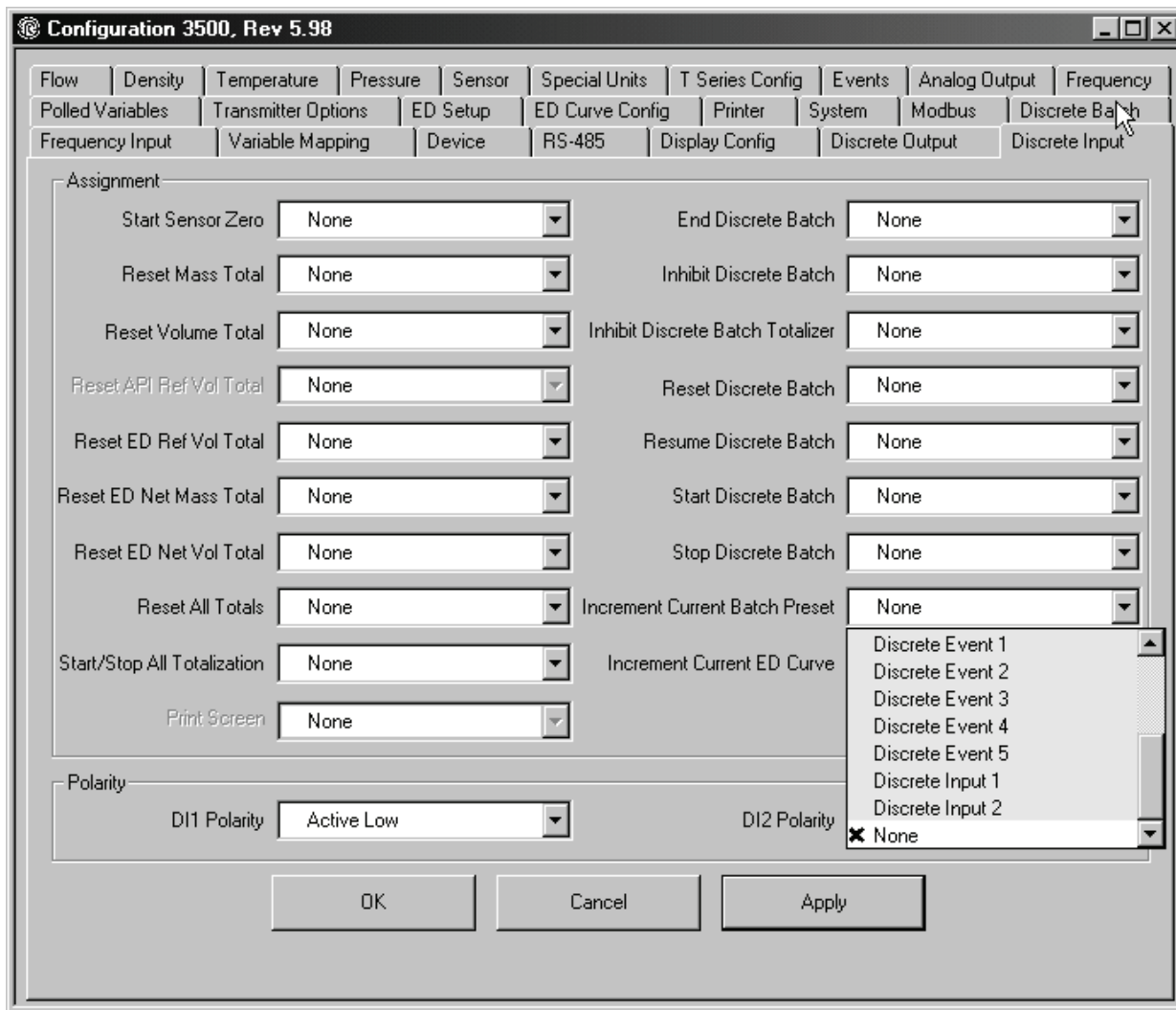

## Configuring the Discrete Batch Application

**Table B-4 Batch control assignments**

| Function                         | Default assignment | Assignment options  | ON state actions  |
|----------------------------------|--------------------|---|---|
| End discrete batch               | None               | Specify the method that will be used to perform the batch control function:<br><ul style="list-style-type: none"> <li>• None</li> <li>• Discrete input 1</li> <li>• Discrete input 2</li> <li>• Discrete event 1</li> <li>• Discrete event 2</li> <li>• Discrete event 3</li> <li>• Discrete event 4</li> <li>• Discrete event 5</li> </ul> | <ul style="list-style-type: none"> <li>• Ends the batch.</li> <li>• The batch cannot be resumed.</li> <li>• The batch totalizer must be reset for the next batch.</li> </ul>  |
| Inhibit discrete batch           |                    |   | <ul style="list-style-type: none"> <li>• Batch cannot be started.</li> <li>• Inhibit totalizer is used for temporary lockout. See Section .</li> </ul>  |
| Inhibit discrete batch totalizer |                    |   | <ul style="list-style-type: none"> <li>• Delivers the batch but does not totalize.</li> <li>• Inhibit totalizer is used when process fluid is recirculated. See Section .</li> </ul>  |
| Reset discrete batch             |                    |   | <ul style="list-style-type: none"> <li>• Resets batch total to zero.</li> <li>• Batch reset cannot be performed while a batch is running or while a batch is stopped. Before a batch can be reset, the batch target must be reached or the batch must be ended.</li> <li>• The batch controller can be configured to reset automatically on start. To configure Reset on start, see Section B.3.2.</li> </ul> |
| Resume discrete batch            |                    |   | <ul style="list-style-type: none"> <li>• Resumes a batch that has been stopped.</li> <li>• Counting resumes from the total at which the batch was stopped.</li> </ul>   |
| Start discrete batch             |                    |   | Starts the batch by opening the flow control valve(s) and/or starting the pump.   |
| Stop discrete batch              |                    |   | <ul style="list-style-type: none"> <li>• Stops the batch.</li> <li>• The batch can be resumed if the batch total is less than the batch target.</li> <li>• If lockout target is disabled as a control option, the operator can change the target before resuming.</li> <li>• To enable or disable lockout target, see Section B.3.2.</li> </ul>   |
| Increment current batch preset   |                    |   | Selects next configured preset (as listed in the preset menus) for use in the next batch.   |

### Inhibit Batch and Inhibit Totalizer processing

If the Inhibit Batch function is mapped to a discrete input:

- When that discrete input is in the active state:
  - A batch cannot be started.
  - A Start Not Okay alarm is posted if starting a batch is attempted.
- If the discrete input then becomes inactive, the batch does not start automatically.
- If a batch is already running when the discrete output becomes active, the batch is not affected.

If the Inhibit Totalizer function is mapped to a discrete input:

- The totalizer will not increment while the discrete input is active.
- The totalizer will resume incrementing automatically when the discrete input becomes inactive.
- If the discrete input is inactive, the totalizer is active, whether or not a batch is running. Even if a batch is not running, the totals will be incremented if flow is detected.

## Configuring the Discrete Batch Application

If the batch totalizer is inhibited while a batch is running:

- And the **No-flow timeout** batch control option (see Section B.3.2) is set to 0, no timeout alarm will be posted.
- And the **No-flow timeout** batch control option is set to a non-zero value, a timeout alarm will be posted if the timeout period expires before batch totalizing resumes.

### B.4 Running a batch

The ProLink II **Batcher Control** window, shown in Figure B-4, can be used for batch operation. It provides the same functionality as the batch process screen on the transmitter display.

Figure B-4 Batcher Control window

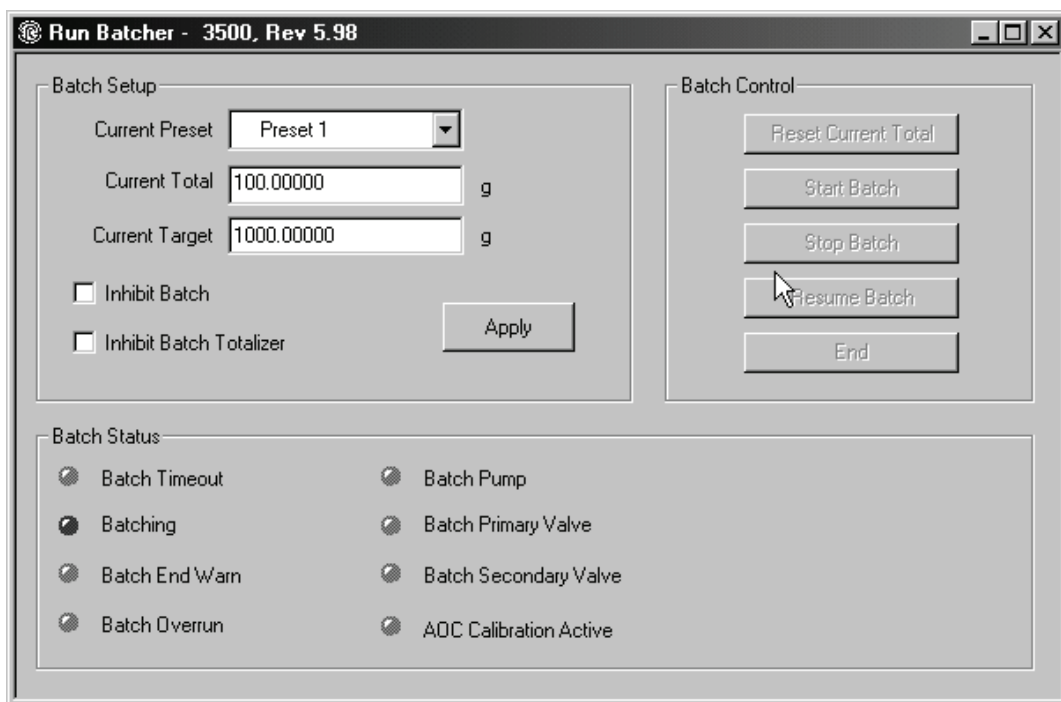

Batch management functions are shown at the top of the window:

- To specify the preset to use for batching, select it from the dropdown list at the top of the Batcher Control window, and click **Apply**.
- The current target is displayed. Depending on the setting of **Lockout target**, you may or may not be able to change the value from this screen. To change it, enter the new target value and click **Apply**.
- To inhibit batch or inhibit batch totalizer, check the checkboxes and click **Apply**. For a discussion of these functions, see the preceding section.
- To reset, start, stop, resume, and end a batch, use the batch control buttons. These functions may also be assigned to a discrete event or discrete input (see Section B.3.4). For a definition of these functions, see Table B-4.

Status of the batch application is shown at the bottom of the window. A red light indicates that the associated condition is active.

## Configuring the Discrete Batch Application

### B.5 Performing Batch AOC calibration

*Batch AOC* (Automatic Overshoot Compensation) keeps the actual quantity delivered as close as possible to the batch target, by minimizing the amount of overshoot.

If batch AOC is enabled (see Section B.3.2), batch AOC calibration is required to provide data for the compensation process. Thereafter, batch AOC calibration is recommended:

- Whenever consistent overshooting or undershooting of the target occurs
- If equipment (valve or pump) is changed

*Note: If batch AOC is not enabled, you cannot perform batch AOC calibration.*

To perform batch AOC calibration using ProLink II:

1. In the **File** menu, click on **Calibration**.
2. Click on **AOC calibration**.
3. Press the **Start Calibration** button. The **AOC Calibration Active** light turns red, and will remain red while batch AOC calibration is in progress.
4. Run 2–10 batches.
5. When overshoot has been adequately minimized, press the **Save Calibration** button.



# Index

## A

- Alarms
  - acknowledging 41
  - types 39
  - viewing 39
- AOC calibration 98
- Autozero 48

## B

- Batch
  - processing 97
  - See* Discrete batch application
- Bell 202
  - installing ProLink II on 9

## C

- Calibrating 58
  - AOC 98
  - how to calibrate for density 59
  - how to calibrate for temperature 63
  - when to calibrate 59
  - zero calibration 48
- Characterizing 55
  - characterization parameters 55
  - density calibration factors 57
  - flow calibration values 57
  - how to characterize 58
  - when to characterize 55
- Communication protocols
  - in installation 9
- Configuration
  - configuration file 51
    - loading to transmitter 52
    - saving to PC 51
  - connection parameters 26
  - discrete batch application
    - batch control methods 94
    - control options 90
    - flow source 89
    - presets 92
  - Gas Unit Configurator tool 54
  - with ProLink II 52

## Connection

- configuring connection parameters 26
- making the connection 34
- service port 26
- troubleshooting 31
- type 9
- Control options 90
- Customer service 3

## D

- Data Logger 77
  - adding notes to log 78
  - defining the log file 77
  - specifying log contents 78
  - starting and stopping 79
  - tools 79
- Density calibration 59
- Diagnostic data
  - logging 77
- Discrete batch application 87
  - AOC calibration 98
  - batch control functions 96
  - configuring 87
  - control options 90
  - flow source 89
  - presets 92
  - running a batch 97
  - stages 92
  - tickets 89
- Discrete events
  - assignment 96
  - in batch control 94
- Discrete inputs
  - assignment 96
  - in batch control 94

## E

- End batch 96

## F

- Flow source 89

## Index

### G

- Gas applications
  - normal volume flow as quasi mass flow rate 54
  - standard volume flow as quasi mass flow rate 54
- Gas Unit Configurator tool 54

### H

- HART
  - installing ProLink II for 9
- Help 36

### I

- Increment preset 96
- Inhibit batch 96
- Inhibit totalizer 96
- Installation
  - configuring connection parameters 26
  - connecting the wires 11
  - connection type 9
  - HART/Bell 202 temporary connection
    - to Model 2400S transmitters 23
    - to RFT9712 transmitters 15
    - to RFT9739 field-mount transmitters 15
    - to RFT9739 rack-mount transmitters 16
  - HART/Bell 202 temporary or hard-wired connection
    - to IFT9701/9703 transmitters 13
    - to Model 1500/2500 transmitters 13
    - to Model 1700/2700 transmitters with the analog outputs option board 13
    - to Model 1700/2700 transmitters with the intrinsically safe outputs option board 17
    - to Model 2400S transmitters 13
    - to Model 2700 transmitters with the configurable input/outputs option board 13
    - to RFT9712 transmitters 13
    - to RFT9739 transmitters 13
    - to Series 3000 transmitters 13
  - HART/RS-485 temporary or hard-wired connection
    - to Model 1700/2700 transmitters with the analog outputs option board 19
    - to RFT9712 transmitters 19
    - to RFT9739 transmitters 19
    - to Series 3000 transmitters 19
  - installation kits 2

- Modbus/RS-485 temporary connection
    - to MVD Direct Connect 24
    - to service port on Model 1500/2500 transmitters 22
    - to service port on Model 1700/2700 transmitters 22
    - to service port on Model 2400S transmitters 22
    - to service port on Series 3000 transmitters 22
  - Modbus/RS-485 temporary or hard-wired connection
    - to Model 1500/2500 transmitters 20
    - to Model 1700/2700 transmitters with the analog outputs option board 20
    - to RFT9739 transmitters 20
    - to Series 3000 transmitters 20
  - permanent license 29
  - privileges 7
  - requirements 2
  - signal converter 11
  - software 8
  - steps 7
  - temporary license 8
  - troubleshooting 30
  - wiring methods 9
- Inventories
    - resetting 37
    - viewing 37

### L

- License
  - permanent 29
  - temporary 8
  - transferring 41
- Logging
  - Data Logger 77
- Loop test 43

### M

- Mass flow special unit for gas applications 54
- Meter
  - calibrating 58
  - characterizing 55
- Meter verification 67
  - meter verification counter 72
  - report 74
  - saving the test results 75
  - specification uncertainty limit 70
  - test database 68

**Index**

Micro Motion customer service 3

Milliamp (mA) output trim 46

Modbus

installing ProLink II for 9

**N**

Normal volume flow

as quasi mass flow rate 54

in gas applications 54

**O**

Outputs

logging 77

testing 43

trimming the milliamp (mA) output 46

**P**

Physical layers

in installation 9

Polling 66

for pressure 66

for temperature 66

Pressure compensation 64

Printing

tickets 89

Privileges

installing ProLink II 7

running ProLink II 7

Process data

logging values 77

viewing 37

ProLink II

configuring a transmitter 52

functions 2

help system 36

installed options 36

installing 7

requirements 2

starting 33

supported transmitters 1

user interface 33

using 33

viewing and resetting inventories 37

viewing process data 37

viewing status 38

viewing, starting, stopping, and resetting  
totalizers 37

**R**

Registry

repairing 30

Reset batch 96

Resume batch 96

RS-485

installing ProLink II on 9

**S**

Sensor, characterizing transmitter for 55

Service port connection 26

Signal converter 2

installing 11

Site key 29

Standard volume flow

as quasi mass flow rate 54

in gas applications 54

Start batch 96

Startup

loop test 43

milliamp (mA) output trim 46

procedures for transmitter startup 43

zeroing 48

Status

viewing 38

Stop batch 96

**T**

Temperature calibration 63

Temperature compensation 65

Terminal diagrams 81

Tickets

discrete batch 89

Totalizers

resetting 37

starting and stopping 37

viewing 37

Transmitter

alarms 39

calibrating 58

characterizing 55

configuring 52

outputs option board 3

startup procedures 43

status 38

supported by ProLink II 1

terminal diagrams 81

type 3

version 3

Trimming the milliamp (mA) output 46

Troubleshooting

connection 31

Data Logger 77

installation 30

USB HART Interface 32

## Index

### U

- USB HART Interface
  - troubleshooting 32
- USB port
  - troubleshooting 32

### W

- Wiring methods 9
  - HART/Bell 202 temporary connection
    - to Model 2400S transmitters 23
    - to RFT9712 transmitters 15
    - to RFT9739 field-mount transmitters 15
    - to RFT9739 rack-mount transmitters 16
  - HART/Bell 202 temporary or hard-wired connection
    - to IFT9701/9703 transmitters network 13
    - to Model 1500/2500 transmitters 13
    - to Model 1700/2700 transmitters with the analog outputs option board 13
    - to Model 1700/2700 transmitters with the intrinsically safe outputs option board 17
    - to Model 2400S transmitters 13
    - to Model 2700 transmitters with the configurable input/outputs option board 13
    - to RFT9712 transmitters network 13
    - to RFT9739 transmitters network 13
    - to Series 3000 transmitters 13
  - HART/RS-485 temporary or hard-wired connection
    - to Model 1700/2700 transmitters with the analog outputs option board 19
    - to RFT9712 transmitters 19
    - to RFT9739 transmitters 19
    - to Series 3000 transmitters 19
  - Modbus/RS-485 temporary connection
    - to MVD Direct Connect 24
    - to service port on Model 1500/2500 transmitters 22
    - to service port on Model 1700/2700 transmitters 22
    - to service port on Model 2400S transmitters 22
    - to service port on Series 3000 transmitters 22
  - Modbus/RS-485 temporary or hard-wired connection
    - to Model 1500/2500 transmitters 20
    - to Model 1700/2700 transmitters with the analog outputs option board 20
    - to RFT9739 transmitters 20
    - to Series 3000 transmitters 20

### Z

- Zero 48



©2006, Micro Motion, Inc. All rights reserved. P/N 20001909, Rev. D



For the latest Micro Motion product specifications, view the  
PRODUCTS section of our web site at [www.micromotion.com](http://www.micromotion.com)

**Micro Motion Inc. USA**  
Worldwide Headquarters

7070 Winchester Circle  
Boulder, Colorado 80301  
T (303) 527-5200  
(800) 522-6277  
F (303) 530-8459

**Micro Motion Europe**

Emerson Process Management  
Wiltonstraat 30  
3905 KW Veenendaal  
The Netherlands  
T +31 (0) 318 495 670  
F +31 (0) 318 495 689

**Micro Motion Asia**

Emerson Process Management  
1 Pandan Crescent  
Singapore 128461  
Republic of Singapore  
T (65) 6777-8211  
F (65) 6770-8003

**Micro Motion United Kingdom**

Emerson Process Management Limited  
Horsfield Way  
Bredbury Industrial Estate  
Stockport SK6 2SU U.K.  
T 0870 240 1978  
F 0800 966 181

**Micro Motion Japan**

Emerson Process Management  
Shinagawa NF Bldg. 5F  
1-2-5, Higashi Shinagawa  
Shinagawa-ku  
Tokyo 140-0002 Japan  
T (81) 3 5769-6803  
F (81) 3 5769-6843

