

READ AND SAVE THESE INSTRUCTIONS



EMERSON™

**Ceiling Fan/Light
Receiver & Reverse Module
Owner's Manual**

**For Use With SR600 Remote Control,
SR650 Remote Control and SW605 Wall Control**

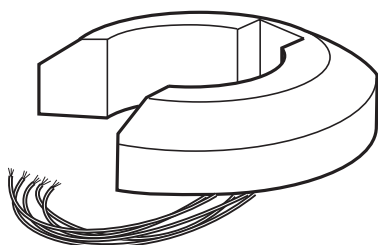

**Receiver Model Numbers:
RC188 &
RC212
6-Speed Receiver**

**RC188 Receiver Supplied with Reverse Module for 188 Motor Fans
with Small Canopies**

**RC212 Receiver Supplied with
Reverse Module for 212 Motor Fans**

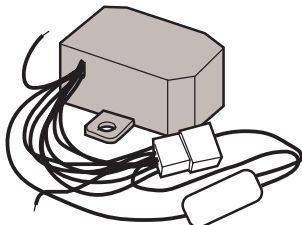

***RC188 Receiver & Module For Use Only with Emerson Ceiling Fan
Models: CF755, CF770, CF775, CF940, CF935, CF670, CF690 & CF695***

***RC212 Receiver and Module for Use Only with Emerson Ceiling Fan
Model CF787***

WARNING

Safety Instructions

WARNING: To avoid fire, shock, and serious personal injury, follow all instructions carefully.

1. Read your Owner's Manual carefully before installing the Receiver. Retain Owner's Manual for future reference.
2. Before servicing or cleaning the ceiling fan, switch power off at service panel and lock service panel to prevent power from being switched on accidentally. When the service disconnecting means cannot be locked, securely fasten a warning device such as a tag, to the service panel.

ADDITIONAL SAFETY INSTRUCTIONS FOR INSTALLATION

1. To avoid possible electrical shock, be sure electricity is turned off at the main fuse or circuit breaker box before wiring.
2. Make certain no bare wires are exposed outside the wire connectors.
3. All wiring must conform to National and Local Electrical Codes.
4. Follow the recommended instructions for the proper method of wiring your new Receiver. If you feel you do not have enough electrical wiring knowledge or experience, have your Receiver installed by a licensed electrician. Any electrical work not described in this manual should be performed by a licensed electrician.

INSTRUCTION TO THE USER (if device contains a digital device)

This equipment has been tested and found to comply with the limits for a class B digital device, pursuant to part 15 of the FCC Rules. These limits are designed to provide reasonable protection against harmful interference in a residential installation. This equipment generates, uses and can radiate radio frequency energy and if not installed and used in accordance with the instructions, may cause harmful interference to radio communications. However, there is no guarantee that interference will not occur in a particular installation. If this equipment does cause harmful interference to radio or television reception, which can be determined by turning the equipment off and on, the user is encouraged to try to correct the interference by one or more of the following measures:

- Reorient or relocate the receiving antenna.
- Increase the separation between the equipment and receiver.
- Connect the equipment into an outlet on a circuit different from that to which the receiver is connected.
- Consult the dealer or an experienced radio/TV technician for help.

This equipment has been certified to comply with the limits for a class B computing device, pursuant to FCC Rules. In order to maintain compliance with FCC regulations, shielded cables must be used with this equipment. Operation with non-approved equipment or unshielded cables is likely to result in interference to radio and TV reception. The user is cautioned that changes and modifications made to the equipment without the approval of manufacturer could void the user's authority to operate this equipment.

This Class B digital apparatus meets all requirements of the Canadian Interference-Causing Equipment Regulations.

DATE CODE: _____

The date code of this fan may be found on the box, stamped in ink on a white label. You should record this data above and keep it in a safe place for future use.

General

Your Emerson Ceiling Fan may be used with a SR600 or SR650 Remote Control, a SW605 Wall Control, and a RC188/RC212 6-speed Receiver. The remote control or wall control is designed to control your ceiling fan speed, airflow direction, and light intensity.

NOTE: The RC188 Receiver is to be used with the following Emerson ceiling fan models: CF940, CF935, CF755, CF770, CF695, CF690 & CF670.

NOTE: The RC212 Receiver is to be used with the CF787 Emerson ceiling fan.

Unpackaging

The carton with the RC188 or RC212 Receiver also contains a reversing module, seven wire connectors, four pull chain switch plugs, and two rectangular switch plugs.

The carton with the SR650 Remote Control contains a storage bracket with two mounting screws.

The carton with the SW605 Wall Control contains three switch covers; ivory, white and almond color.

IMPORTANT

This Owner's Manual is divided into three sections. The first section, SR600/SR650 REMOTE CONTROL PROCEDURES, describes how to install the two AAA alkaline batteries in the SR600 remote control transmitter and two CR2032 Lithium batteries in the SR650 remote control transmitter, and how to set the operating frequency of the transmitter and receiver. The second section describes how to install the SW605 Wall Control. These instructions must be performed prior to installation of the ceiling fan as described in the third section, CEILING FAN PROCEDURES.

SECTION ONE:

SR600 REMOTE CONTROL PROCEDURES

General

Your Emerson Ceiling Fan/Light SR600 Remote Control consists of hand-held transmitter and a receiver which is mounted under the fan ceiling cover. The remote control is designed to separately control your ceiling fan speed and light intensity.

The remote control transmitter is powered by two AAA alkaline batteries (included). To prevent possible damage if the batteries should leak, be sure to remove the batteries when the control is not to be used for an extended period of time.

Code switches in the transmitter and receiver may be set in 32 different positions. If your fan and light go on and off without using your control, you may be getting interference from other remote units such as garage door openers, car alarms or security systems. To remedy this situations, simply change the combination code in your transmitter and receiver.

Preset Memory Feature

Your Emerson receiver is equipped with a preset memory feature. If the AC supply to the receiver is powered through a wall switch, when the switch is turned OFF, the control will remember the light intensity and fan speed. When the switch is turned back ON the light and fan will resume operation as they were prior to the switch being turned OFF.

Installation of Battery

1. Remove the battery cover by pressing firmly below the arrow and sliding the cover off the control (Figure 1).
2. Install two AAA alkaline batteries and reinstall the battery cover.

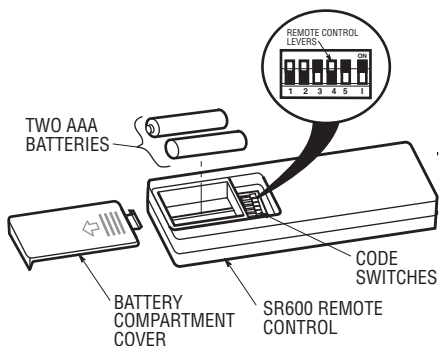

Figure 1

Installation of Storage Bracket for SR600 Remote Control

A storage bracket is provided for holding your remote control when not in use. If you desire to use the bracket, install it on a wall that is away from excess heat or humidity (Figure 2).

TO INSTALL BRACKET TO WALL:

SLIDE THE COVER UP TO EXPOSE THE SCREW HOLES FOR INSTALLATION

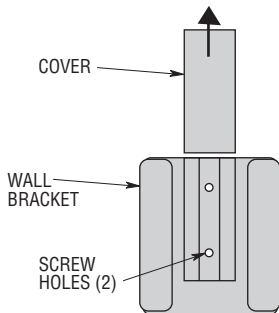

Figure 2

Setting Operating Frequency of SR600 Remote Control

Your remote control has code switches which must be set in one of 32 possible code combinations. The five levers (numbered 1, 2, 3, 4, and 5) on the switches are factory-set in the ON (up) position. Change the switch settings as follows:

1. Slide the five switch levers in the remote control to your choice of ON (up) or down positions. Use a ball-point pen or small screwdriver and slide the levers firmly up or down.
2. When power is restored, push and hold the fan OFF button (⏻) for 3 to 5 seconds to set the code in the receiver.
3. If airflow is desired in the opposite direction, press the (↺) button on the wall control. The fan must be operating at any speed for the reverse button to function. The blades will turn in the opposite direction and reverse the airflow.
4. To set the desired fan speed, press the (⏪) button to decrease the speed and the (⏩) to increase the speed. The LED display will light up to indicate the new speed selected.
5. To set the light intensity, press and release the LIGHT (💡) button to decrease the light intensity and the LIGHT (💡) button to increase the light intensity. The light will turn on at the light intensity previously selected.
6. The sixth switch marked ON and I is for dimming control of lights: Set switch to ON to allow for dimming of the lights. Set switch to I for no dimming of the lights such as for fluorescent bulbs.

SR650 REMOTE CONTROL PROCEDURES

General

Your Emerson Ceiling Fan/Light SR650 Remote Control consists of hand-held transmitter with wall mount and a receiver which is mounted under the fan ceiling cover. The remote control is designed to separately control your ceiling fan speed and light intensity.

The remote control transmitter is powered by two CR2032 Lithium batteries (included). Be sure to remove the batteries when the control is not to be used for an extended period of time.

Code switches in the transmitter and receiver may be set in 32 different positions. If your fan and light go on and off without using your control, you may be getting interference from other remote

units such as garage door openers, car alarms or security systems. To remedy this situations, simply change the combination code in your transmitter and receiver.

Preset Memory Feature

Your Emerson receiver is equipped with a preset memory feature. If the AC supply to the receiver is powered through a wall switch, when the switch is turned OFF, the control will remember the light intensity and fan speed. When the switch is turned back ON the light and fan will resume operation as they were prior to the switch being turned OFF.

Installation of Battery

1. Remove the battery cover by pressing firmly below the arrow and sliding the cover off the control (Figure 3).
2. Install one CR2032 Lithium battery into the battery compartment then stack the other CR2032 Lithium battery on top of the installed battery and reinstall the battery cover.

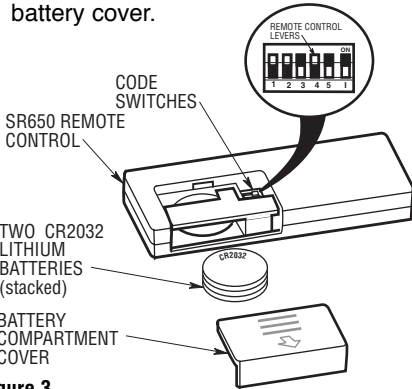

Figure 3

Installation of Storage Bracket for SR650 Remote Control

A storage bracket is provided for holding your remote control when not in use. If you desire to use the bracket, install remote control storage bracket using the two screws provided. Install on a wall that is away from excess heat or humidity

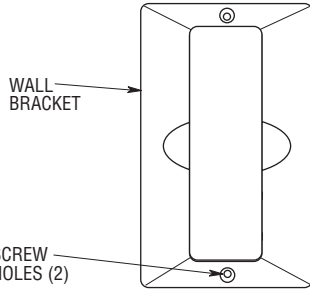

Figure 4

Setting Operating Frequency of SR650 Remote Control

Your remote control has code switches which must be set in one of 32 possible code combinations. The five levers (numbered 1, 2, 3, 4, and 5) on the switches are factory-set in the ON (up) position. Change the switch settings as follows:

1. Slide the five switch levers in the remote control to your choice of ON (up) or down positions. Use a ball-point pen or small screwdriver and slide the levers firmly up or down.
2. When power is restored, push and hold the fan OFF button (⏻) for 3 to 5 seconds to set the code in the receiver.
3. If airflow is desired in the opposite direction, press the (↺) button on the wall control. The fan must be operating at any speed for the reverse button to function. The blades will turn in the opposite direction and reverse the airflow.
4. To set the desired fan speed, press the (⏴) button to decrease the speed and the (⏵) to increase the speed. The LED display will light up to indicate the new speed selected.
5. To set the light intensity, press and release the LIGHT (💡) button to decrease the light intensity and the LIGHT (💡) button to increase the light intensity. The light will turn on at the light intensity previously selected.
6. The sixth switch marked ON and I is for dimming control of lights: Set switch to ON to allow for dimming of the lights. Set switch to I for no dimming of the lights such as for fluorescent bulbs.

SECTION TWO: Setting Operating Frequency of SW605 Wall Control

Your wall control has code switches which must be set in one of 32 possible code combinations (Figure 5). The five levers (numbered 1, 2, 3, 4, and 5) on the switches are factory-set in the ON (up) position. Change the switch settings as follows:

1. Slide the five switch levers in the wall control to your choice of ON (up) or down positions. Use a ball-point pen or small screwdriver and slide the levers firmly up or down.
2. When power is restored after installation of the wall control, push and hold the fan OFF button () for 3 to 5 seconds to set the code in the receiver.
3. The sixth switch marked ON and I is for dimming control of lights: Set switch to ON to allow for dimming of the lights. Set switch to I for no dimming of the lights such as for fluorescent bulbs.

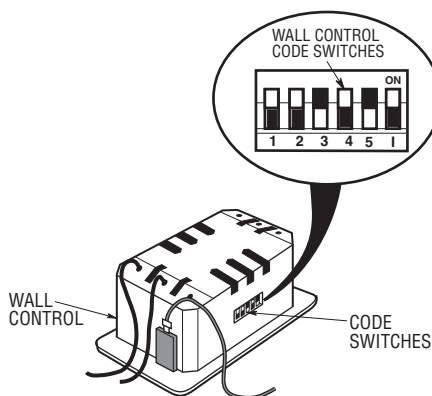

Figure 5

Installation of Wall Control SINGLE-POLE INSTALLATION (Figure 6)

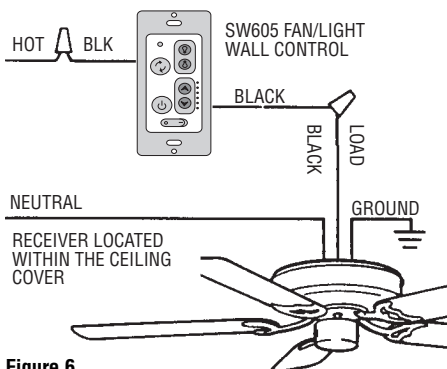

Figure 6

WARNING

Turning off wall switch is not sufficient. To avoid possible electrical shock, be sure electricity is turned off at the main fuse or circuit breaker box before wiring. All wiring must be in accordance with National and Local codes and the ceiling fan must be properly grounded as a precaution against possible electrical shock.

CAUTION: To reduce the risk of electrical shock, disconnect the electrical supply circuit before installing the fan, light kit or receiver.

NOTE: Make all wiring connections using wire connectors (supplied). Make sure that all connections are tight, including ground, and that no bare wire is visible at the wire connectors, except for the ground wire.

1. Disconnect electrical power to the branch circuit at the circuit breaker or fuse box before attempting to install the ceiling fan wall control into the outlet box.
2. Remove faceplate and screws from existing wall control. Pull control out from the wall box. Determine the "hot" wire and the "load" wire and disconnect these wires from control. Do not attempt to disconnect any wires not already connected to existing control.
3. Before installing wall control, place wall control in "OFF" mode by pushing "ON/OFF" switch to the "OFF" position.

⚠ WARNING

Do not connect any neutral (white) wire to this control. Incorrect wiring will damage this control.

- 4. Connect one black wire of wall control to the “hot” wire. Securely connect wires with wire connectors supplied (Figure 7).
- 5. Connect one black wire of wall switch to the “load” (black) wire in wall box. Securely connect wires with wire connector supplied.
- 6. Screw wall control into wall box using the supplied screws. Leave wall control in “OFF” mode until fan installation is completed.

⚠ WARNING

Check to see that all connections are tight and that no bare wires are visible at the wire connectors.

- 7. The wall control is supplied with a white, ivory, and almond color switch covers. Choose the finish that best suits your needs and snap the cover onto the wall control (Figure 7).
- 8. Install decorator wall plate (purchased separately) using the two screws provided with wall plate. Leave wall control in “OFF” mode until fan installation is completed (Figure 7).

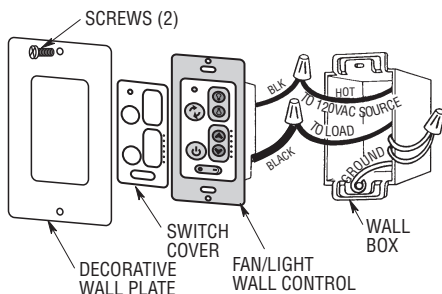

Figure 7

3-WAY INSTALLATION

(On fan controlled by two different wall controls) (See Figures 8 and 9.)

⚠ WARNING

Turning off wall switch is not sufficient. To avoid possible electrical shock, be sure electricity is turned off at the main fuse or circuit breaker box before wiring. All wiring must be in accordance with National and Local codes and the ceiling fan must be properly grounded as a precaution against possible electrical shock.

- 1. Disconnect electrical power to the branch circuit at the circuit breaker or fuse box before attempting to install the ceiling fan wall control into the outlet box.

⚠ WARNING

Do not connect any neutral (white) wire to this control. Incorrect wiring will damage this control.

- 2. At all wall box locations remove faceplates and screws from existing controls. Pull controls out from wall boxes and determine which wall box contains the “hot” lead and which wall box contains the “load” wire. Also, identify traveler wires which are common to both wall boxes. Disconnect wires from existing controls only. Do not attempt to disconnect any wires not already connected to existing controls.
- 3. Before installing wall control, place wall control in “OFF” mode by pushing “ON/OFF” switch to the “OFF” position.
- 4. Install a wall control in the wall box containing the “hot” wire first. Connect the black wire of the wall control to the “hot” wire. Securely connect wires with wire connectors supplied.
- 5. Connect one black wire of the wall control to both remaining traveler wires in the wall box and secure with wire connector supplied.

NOTE: Retrofit 3-way installations are likely to include two traveler wires between the two wall boxes. In new construction, only one traveler wire is required (See Figure 9).

3-WAY WIRING DIAGRAM: NEW CONSTRUCTION

⚠ WARNING

Check to see that all connections are tight and that no bare wires are visible at the wire connectors.

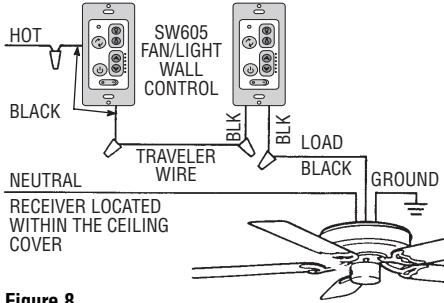
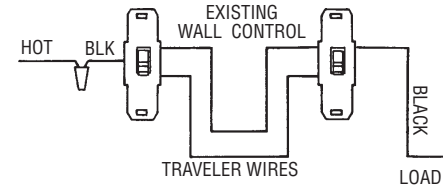

Figure 8

- 6. Screw wall control into wall box using the supplied screws. Leave wall control in “OFF” mode until fan installation is completed.
- 7. The wall control is supplied with a white, ivory, and almond color switch covers. Choose the finish that best suits your needs and snap the cover onto the wall control (Figure 7).
- 8. Next, install the other wall control into the wall box containing the load wire. Connect the black wire of the wall control to the traveler wire(s) already connected to the black wire (in the other wall box). Secure with wire connectors supplied.
- 9. Connect one black wire of the wall control to the “load” (black) wire and secure with wire connector supplied.

STANDARD WIRING FOR EXISTING 3-WAY CONTROLS



3-WAY WIRING DIAGRAM: RETROFIT

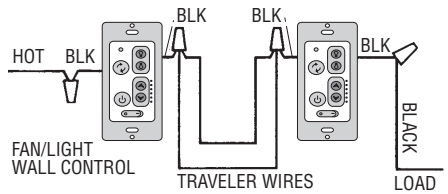

Figure 9

Operation of Your Wall Control (Figure 10)

IMPORTANT

Fan installation must be completed, including the installation of the fan blades, before testing the remote control.

Your wall control has full control of your fan and light.

NOTE: Prior to operation of the fan and light from the wall control, set the fan speed to HIGH (---) and turn the light ON (💡).

1. To set the desired fan speed, press the (▼) button to decrease the speed and the (▲) to increase the speed. The LED display will light up to indicate the new speed selected.
2. To turn the light on and off, press and release the LIGHT (💡) button. To set the light intensity, press and hold the LIGHT (💡) button. The light will turn on at the light intensity previously selected.
3. Your wall control comes complete with your choice of three wall cover plates; ivory, white and light almond.

- 4. If airflow is desired in the opposite direction, press the (↺) button on the wall control. The fan must be operating at any speed for the reverse button to function. The blades will turn in the opposite direction and reverse the airflow.

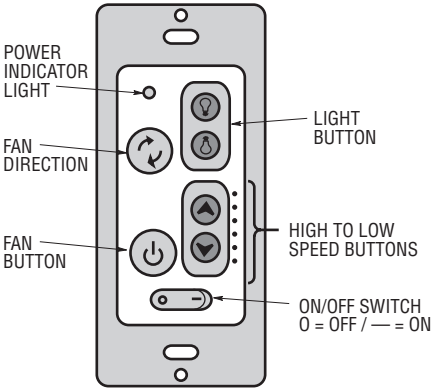

Figure 10

SECTION THREE: CEILING FAN PROCEDURES

Installation to Operate the Ceiling Fan, Downlight and Uplight

IMPORTANT

It is important that you also follow the installation instructions contained in the Owner's Manual supplied with your Ceiling Fan. Pay particular attention to the Safety Instructions and WARNING notes.

- 1. Remove and retain the screws securing the housing cover to the switch housing (Figure 11).
- 2. **All Ceiling Fan Models.** Disconnect the motor connector from the wiring harness connector (Figure 11). Remove the knurled nut securing the speed control switch to the switch housing and place the pull chain plug in the exposed hole.

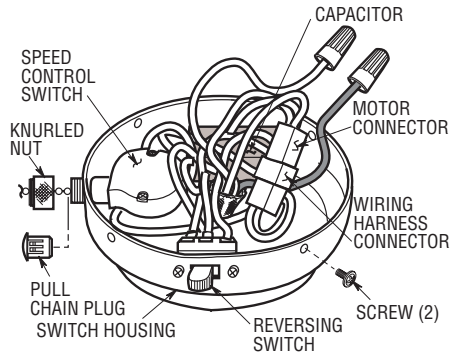

Figure 11

NOTE: Keep the upright switch if you think you may like to return to manual control in the future.

- 3. Remove two screws securing the reversing switch to the switch housing and place the pull chain plug in the exposed hole.(Figure 12).

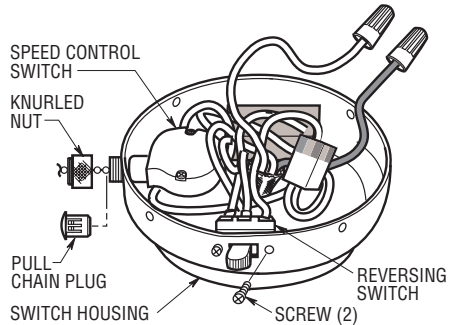

Figure 12

- 4. Remove the speed control switch and reversing switch capacitor. Position the RC188/RC212 module into the switch housing (Figure 13).

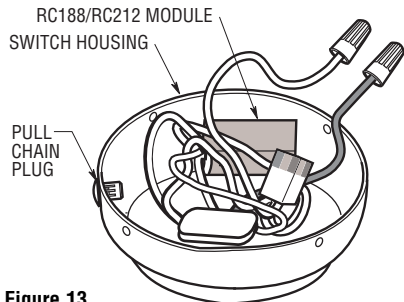

Figure 13

- 5. Connect the 6-pin wiring connector of the module to the ceiling fan motor assembly wiring connector. The connectors are keyed and must be mated correctly before they can be engaged (Figure 14).

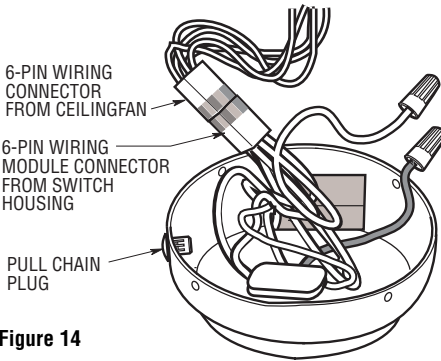
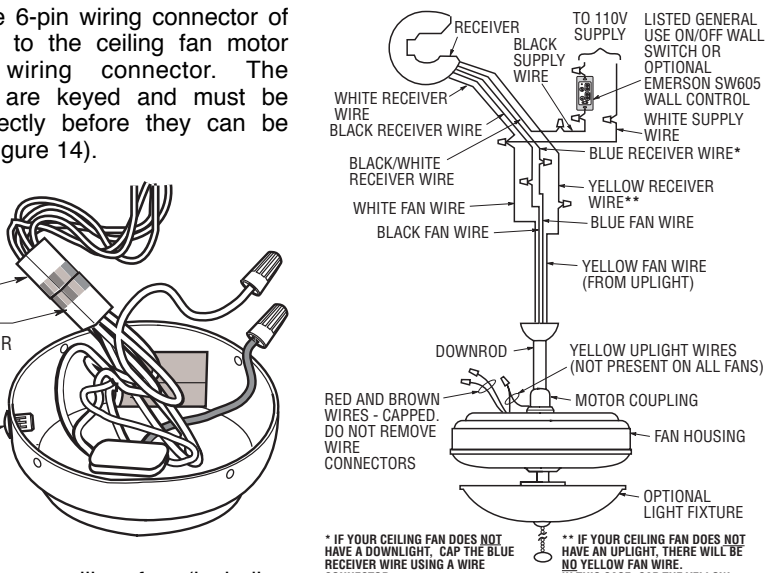

Figure 14

- 6. Assemble your ceiling fan (including the fan blades), install the hanger bracket, and then hang the fan in accordance with the instructions in the Ceiling Fan Owner's Manual. Wire the ceiling fan and receiver and complete the installation in accordance with the following Steps 6 through 12.
- 7. Pull the wire leads, coming from the end of the downrod, and the supply wires through the open side of the hanger bracket. (Figure 15).
- 8. Position the RC188/RC212 Receiver in the ceiling cover so that the flat side of the receiver faces up and the open portion of the receiver is to the right, as shown in Figure 15.



* IF YOUR CEILING FAN DOES NOT HAVE A DOWNLIGHT, CAP THE BLUE RECEIVER WIRE USING A WIRE CONNECTOR.

** IF YOUR CEILING FAN DOES NOT HAVE AN UPLIGHT, THERE WILL BE NO YELLOW FAN WIRE. IN THIS CASE, CAP THE YELLOW RECEIVER WIRE USING A WIRE CONNECTOR.

Figure 16

- 9. Using wire connectors (supplied), make wiring connections as follows (Figure 15 and 16):
 - a. Connect the green ground wires from the hanger bracket and the hanger ball to the supply ground wire (bare or green).
 - b. Connect the white fan wire and the white supply wire to the white receiver wire (AC IN/MOTOR N).
 - c. Connect the black fan wire to the black receiver wire (TO MOTOR L).

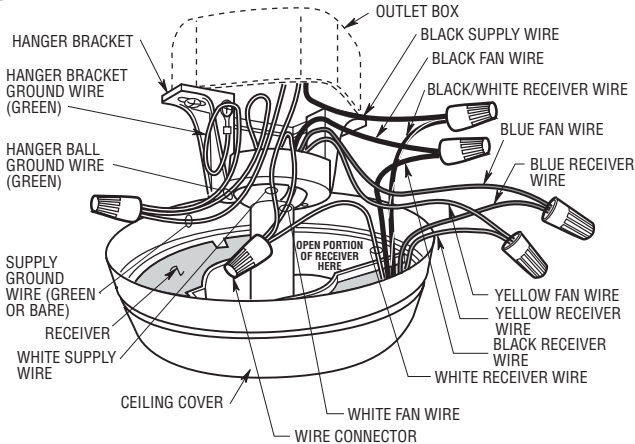

Figure 15

- d. Connect the black supply wire to the black/white receiver wire (AC IN L).
 - e. Cut off the end of the blue and yellow receiver wires and strip back insulation 1/2" from the end of the wires.
 - f. Connect the blue fan wire to the blue receiver wire (BOTTOM LIGHT).
 - g. Connect the yellow fan wire to the yellow receiver wire (UPPER LIGHT).
- 12. Slide the receiver up and over the hanger bracket. Press the receiver against the ceiling, holding it in place while installing the ceiling cover in accordance with the instructions in the Ceiling Fan Owner's Manual.
 - 13. Install the optional Emerson Light Fixture in accordance with the instructions in the Light Fixture Owner's Manual. Use the screws removed in Step 1.

CAUTION: If your ceiling fan does NOT have an uplight, there will be NO yellow fan wire. In this case, cap the yellow receiver wire using a wire connector (supplied). If your ceiling fan does NOT have a downlight, cap the blue receiver wire using a wire connector (supplied).

- 10. Insert the connected ends of the wires up through the open side of the hanger bracket and into the outlet box as shown in Figure 17.

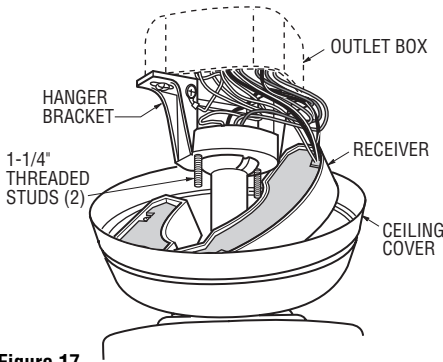

Figure 17

- 11. Screw two 1-1/4" threaded studs (supplied with the ceiling fan) into the tapped holes in the hanger bracket (Figure 15).

NOTE: To prevent damage to the receiver, turn "off" the electricity at the wall switch before installing or removing light bulbs on the ceiling fan or light fixture.

Trouble Shooting

Fan/Light Fails to Operate

- Check that the speed switch on the fan is set to HIGH (....) speed.
- Check that the light switch is on.
- Check that the battery is good (red indicator light should light when any button is pressed).
- Check that the receiver is wired properly.
- Check that code switches in the remote control and receiver are set in the same position.

Short Range

- If the remote control operates the fan when close to it, but does not operate it at a distance of 40 feet, try placing the antenna wire outside of the ceiling cover.

LIMITED WARRANTY

What The Warranty Covers:

All products covered by this Owner's Manual are warranted against all defects in workmanship and materials. You must be the original purchaser or user of the product to be covered.

What The Period Of Coverage Is:

All components are covered by this warranty for one year from the date you purchased your Receiver ANY IMPLIED WARRANTY OF MERCHANTABILITY OR FITNESS FOR A PARTICULAR PURPOSE, MADE WITH RESPECT TO COMPONENTS AND ACCESSORIES IS ALSO LIMITED TO ONE YEAR.

What Will Emerson Electric Co. Do To Correct Problems:

Emerson will replace a defective Emerson Receiver at no charge to you. **We will ship the repaired product or replacement to you at no charge, but you are responsible for all costs or removal, reinstallation and shipping of the product to Emerson.**

How Can You Get Service:

YOU MUST HAVE PROOF OF YOUR PURCHASE OF THE RECEIVER TO OBTAIN LIMITED WARRANTY SERVICE. KEEP YOUR RECEIPT OR OTHER PROOF OF PURCHASE. You can return the product to our factory or to your nearest authorized service center.

- To return the product to the factory, obtain a return authorization and service identification tag by writing to Air Comfort Products, Division of Emerson Electric Co., 8100 W. Florissant Ave., St. Louis, MO 63136. Include all model numbers shown on the product with your request.
- To return the product to an authorized service center, call 1-800-654-3545 for the address of the nearest authorized service center.

You will be responsible for all insurance, freight or other transportation charges to our factory or authorized service center. Your Emerson Receiver should be properly packed to avoid damage in transit since we will not be responsible for any such damage.

What Is Not Covered:

This warranty also does not cover any defects, malfunctions or failures caused by:

- Repairs by persons not authorized by Emerson Electric Co.,
- Use of parts or accessories not authorized by Emerson Electric Co.,
- Mishandling, improper installation, modifications or damage to your receiver while in your possession, or
- Unreasonable use, misuse, abuse, including failing to do reasonable and necessary maintenance, and normal wear and tear.

Additionally, this warranty and any implied warranty of merchantability or fitness for a particular purpose are voided when:

- The original purchaser or user ceases to own the product, or
- The ceiling fan is moved from its original point of installation.

This warranty is only valid within the 50 states of the United States and the District of Columbia. No other written or oral warranties apply, and no employee, agent, dealer or other person is authorized to give any warranties on behalf of Emerson Electric Co.

REPAIR, REPLACEMENT OR A REFUND ARE THE EXCLUSIVE REMEDIES AVAILABLE UNDER THIS WARRANTY AND EMERSON IS NOT RESPONSIBLE FOR DAMAGES OF ANY KIND, INCLUDING INCIDENTAL AND CONSEQUENTIAL DAMAGES. Incidental damages include but are not limited to such damages as loss of time and loss of use. Consequential damages include but are not limited to the cost of repairing or replacing other property which was damaged if this product does not work properly.

How State Law Relates To The Warranty:

Some states do not allow the exclusion or limitation of incidental or consequential damages so the above exclusion or limitation may not apply to you. This warranty gives you specific legal rights, and you may also have other rights which vary from state to state.



EMERSON™

Air Comfort Products

DIVISION OF EMERSON ELECTRIC CO.
8100 W. Florissant • St. Louis, MO 63136