



Emerson[®]

***MICRO AUDIO SYSTEM
with CD PLAYER
and DIGITAL TUNER***



OWNER'S MANUAL

ES27



Visit our web site at www.emersonradio.com





WARNING

TO PREVENT FIRE OR SHOCK HAZARD, DO NOT USE THIS PLUG WITH AN EXTENSION CORD, RECEPTACLE OR OTHER OUTLET UNLESS THE BLADES CAN BE FULLY INSERTED TO PREVENT BLADE EXPOSURE. TO PREVENT FIRE OR SHOCK HAZARD, DO NOT EXPOSE THIS APPLIANCE TO RAIN OR MOISTURE.

 <p>The lightning flash with arrow-head symbol, within an equilateral triangle is intended to alert the user to the presence of uninsulated 'dangerous voltage' within the product's enclosure that may be of sufficient magnitude to constitute a risk of electric shock to persons.</p>	<p>WARNING RISK OF ELECTRIC SHOCK DO NOT OPEN</p> <p>CAUTION: TO REDUCE THE RISK OF ELECTRIC SHOCK DO NOT REMOVE COVER (OR BACK), NO USER SERVICEABLE PARTS INSIDE REFER SERVICING TO QUALIFIED SERVICE PERSONNEL.</p>	 <p>The exclamation point within an equilateral triangle is intended to alert the user to the presence of important operating and maintenance (servicing) instructions in the literature accompanying the appliance.</p>
--	--	---

IMPORTANT SAFETY INSTRUCTIONS

1. Read these instructions.
2. Keep these instructions.
3. Heed all warnings.
4. Follow all instructions.
5. Do not use this apparatus near water.
6. Clean only with dry cloth.
7. Do not block any ventilation openings. Install in accordance with the manufacturer's instructions.
8. Do not install near any heat sources such as radiators, heat registers, stoves, or other apparatus (including amplifiers) that produce heat.
9. Do not defeat the safety purpose of the polarized or grounding-type plug. A polarized plug has two blades with one wider than the other. A grounding type plug has two blades and a third grounding prong. The wide blade or the third prong are provided for your safety. If the provided plug does not fit into your outlet, consult an electrician for replacement of the obsolete outlet.
10. Protect the power cord from being walked on or pinched particularly at plugs, convenience receptacles, and the point where they exit from the apparatus.
11. Only use attachments / accessories specified by the manufacturer.
12. Unplug this apparatus during lightning storms or when unused for long periods of time.
13. Refer all servicing to qualified service personnel. Servicing is required when the apparatus has been damaged in any way, such as power-supply cord or plug is damaged, liquid has been spilled or objects have fallen into the apparatus, the apparatus has been exposed to rain or moisture, does not operate normally, or has been dropped.
14. This appliance shall not be exposed to dripping or splashing water and that no object filled with liquids such as vases shall be placed on the apparatus.



BEFORE WE BEGIN

Thank you.....

for purchasing this Emerson audio product. The Emerson brand is your assurance of quality, performance and value, and has been since 1912.

Our engineers have included many useful and convenient features in this product. Please be sure to read this Owner's Manual completely to make sure you are getting the maximum benefit from each feature.

This product was manufactured using the highest quality components and standards of workmanship. It was tested by Emerson inspectors and found to be in perfect working order before it left our factory. However, there is always the chance that some problem may occur because of rough handling during shipment to the retail store or to the final consumer.

If, after reading this Manual, you experience any problems with the operation of this product, please refer to the instructions for obtaining service at the end of this Manual. Emerson and Emerson retailers are committed to your satisfaction.

Once again, thanks for purchasing this Emerson audio product.

For future reference, record the serial number in the space provided.

Model No: ES27

Serial Number : _____



IMPORTANT NOTES

- Avoid installing this unit in places exposed to direct sunlight or close to heat radiating appliances such as electric heaters, on top of other stereo equipment that radiates heat, places lacking ventilation or dusty areas, places subject to constant vibration and/or humid or moist areas.
- Do not attempt to clean this unit with chemical solvents as this might damage the finish. Use a clean dry cloth.
- Operate controls and switches as described in the manual.
- Before turning on the power, make certain that the connecting cords and power cord are properly installed.
- Store your CDs in a cool area to avoid damage from heat.
- When moving the set, be sure to first disconnect the power cord and remove cords connected to other equipment.

CLASS 1 LASER PRODUCT

CLASS 1 LASER PRODUCT APPAREIL À LASER DE CLASSE 1 PRODUCTO LASER DE CLASE 1	CAUTION INVISIBLE LASER RADIATION WHEN OPEN AND INTERLOCKS DEFEATED. AVOID EXPOSURE TO BEAM	
--	---	--

This product contains a low power Laser Device.

FCC INFORMATION

This equipment has been tested and found to comply with the limits for a Class B digital device, pursuant to Part 15 of the FCC Rules. These limits are designed to provide reasonable protection against harmful interference in a residential installation. This equipment generates, uses, and can radiate radio frequency energy and, if not installed and used in accordance with the instructions, may cause harmful interference to radio communications. However, there is no guarantee that interference will not occur in a particular installation. If this equipment does cause harmful interference to radio or television reception, which can be determined by turning the equipment off and on, the user is encouraged to try to correct the interference by one or more of the following measures:

- Reorient or relocate the receiving antenna.
- Increase the separation between the equipment and receiver.
- Connect the equipment into an outlet on a circuit different from that to which the receiver is connected.
- Consult the dealer or an experienced radio/TV technician for help.

This device complies with Part 15 of the FCC Rules. Operation is subject to the following two conditions:

- (1) This device may not cause harmful interference, and
- (2) This device must accept any interference received, including interference that may cause undesired operation.

PREPARATION FOR USE

UNPACKING AND SET-UP

- Carefully remove the unit from the carton and remove all packing material from the unit.
- Remove any labels or stickers which may be on the front or top of the set, but do not remove any labels from the back or bottom.
- We suggest that you retain the original carton and packing materials in case it ever becomes necessary to return your unit for service. This is the only sure way to protect the unit from damage in transit.
- If you do dispose of the carton and packing materials, please do so properly. Emerson cares about our environment.

POWER SOURCE

This system is designed to operate on 120V 60Hz AC house current . Connecting this system to any other power supply could result in damage to the unit which is not covered by your warranty. You will note that this system is equipped with a polarized AC power plug having one blade wider than the other. This is a safety feature. If this plug does not fit into your existing AC outlet, do not try to defeat this safety feature by filing the wide blade to make it fit into your outlet. If this plug will not fit into your outlet, you probably have an out-dated non-polarized AC outlet. You should have your outlet changed by a qualified licensed electrician.

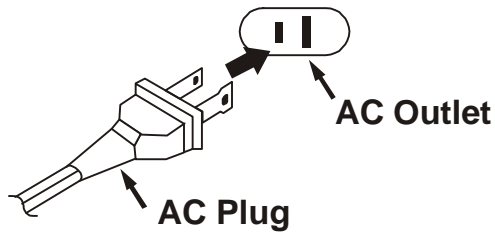

AC OPERATION

1. Unwind the AC Power Cord completely.
2. Insert the plug into any convenient 120V 60Hz AC outlet.

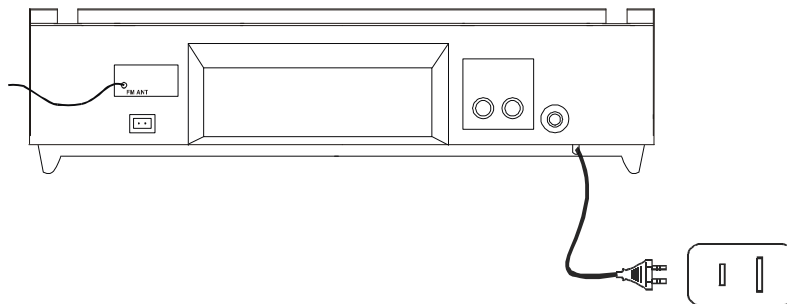

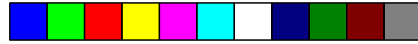

LOCATION OF CONTROLS AND INDICATORS

TOP PANEL

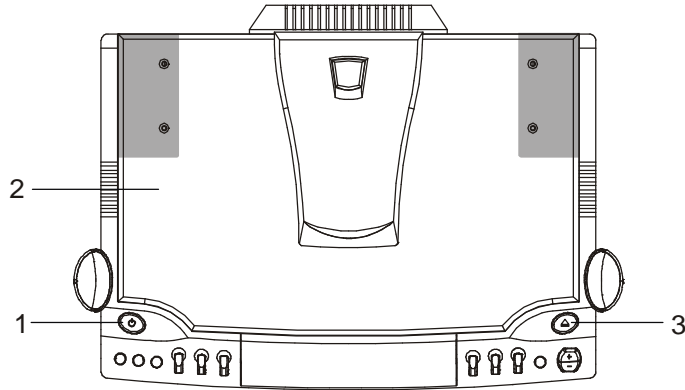



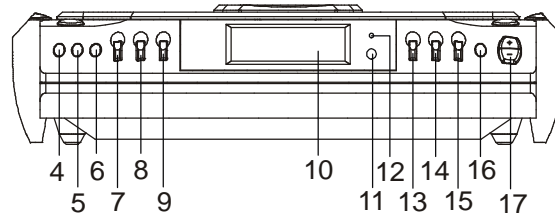

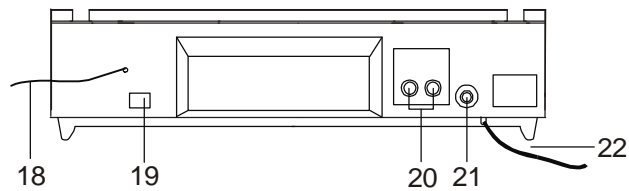

FRONT PANEL



BACK PANEL



- | | |
|---|---|
| 1. POWER  On/Off Button. | 13. Reverse Skip Search / TUNING DOWN  Button. |
| 2. CD Compartment. | 14. Forward Skip Search / TUNING UP  Button. |
| 3. CD Door Open/Close  Button. | 15. Play/Pause  Button. |
| 4. REPEAT / MEMORY UP Button. | 16. STOP  Button. |
| 5. PROG. / MEMORY Button. | 17. VOLUME UP / DOWN Buttons. |
| 6. Preset EQ Button. | 18. FM Wire Antenna. |
| 7. BAND Button. | 19. AM External Loop ANT Jack. |
| 8. TUNER Button. | 20. Speaker Jacks. |
| 9. CD Button. | 21. PHONES Jack. |
| 10. Multi Function Display. | 22. AC Power Cord. |
| 11. Remote Control SENSOR. | |
| 12. MUTE Indicator. | |



REMOTE CONTROL

- 1.) VOLUME ▲UP / ▼ DOWN Buttons.
- 2.) POWER On/Off Button.
- 3.) CD STOP Button.
- 4.) CD PLAY / PAUSE Button.
- 5.) CD Button.
- 6.) TUNER Button.
- 7.) Tuning UP / DOWN /
CD Skip Search ◀◀ / ▶▶ Buttons.
- 8.) MEMORY / PROG.(PROGRAM) Button.
- 9.) M-UP / REPEAT Button.
- 10.) BAND Button.
- 11.) MUTE Button.

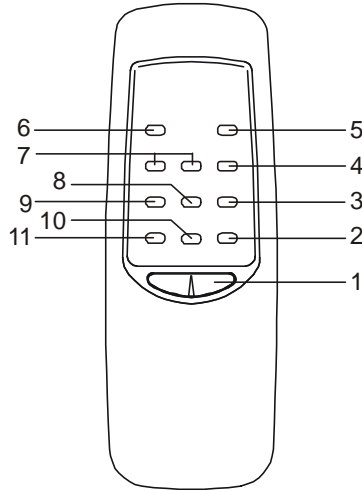

BATTERY INSTALLATION

Insert 2 pcs 'AAA' size (Alkaline) batteries (not included) into the battery compartment of the remote controller.

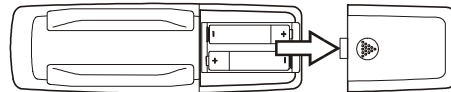

Be sure to observe the polarity markings which are engraved inside the battery compartment, then close the cover.

BATTERY REPLACEMENT

When the batteries become too weak, the operating distance of the remote controller is greatly reduced and you will need to replace the batteries.

NOTES:

- To maintain the accuracy and long life of the transmitter, do not press two or more buttons simultaneously.
- If the remote control is not to be used for a long time, remove the batteries to prevent possible damage through leaking batteries.
- Do not mix different types of batteries, or old batteries with new ones.

USING THE REMOTE CONTROLLER CORRECTLY

- Point the remote controller at the Remote Sensor.
- The functions of the buttons on the remote control are the same as the corresponding controls on the main unit.
- When there is a strong ambient light source, the performance of the infrared Remote Sensor may be degraded, causing unreliable operation.
- The maximum effective distance for remote control operation is about 15 feet.



OPERATING INSTRUCTIONS

SPEAKER CONNECTION

Connect each speaker to the corresponding speaker terminals on the back panel of the main unit. Make sure that the left speaker plug is connected to the left (L) speaker jack and the right speaker plug is connected to the right (R) speaker jack.

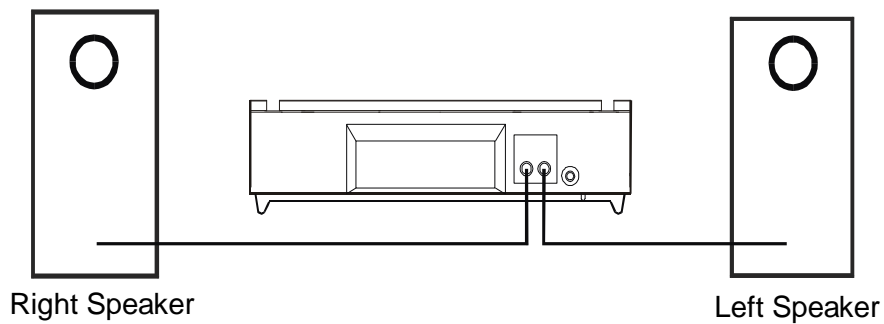

PRESET EQUALIZER (EQ)







- This unit is equipped with a preset equalizer which has been added to enhance your listening pleasure by altering the frequency response of the music.
- Press the Preset EQ button on main unit repeatedly to cycle through the following equalization modes.







LISTENING TO RADIO

OPERATION

- 1.) Press the POWER  button to turn the unit 'On'.
- 2.) Select the Tuner function by pressing the TUNER button.
- 3.) Select the desired band (AM or FM) with the BAND button.
- 4.) Tune to the desired radio station by pressing the TUNING UP  or DOWN  buttons on the unit or on the remote control.
- 5.) If you hold the TUNING UP  or DOWN  button for more than half a second the Tuner will begin to automatically scan until a strong signal is found.
- 6.) To turn off the radio, press the POWER  button to switch the unit into standby mode.

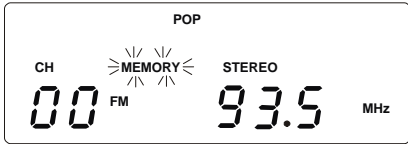
STORING PRESET STATIONS

- 1.) Tune either automatically or manually (as described in steps 4 or 5 above) to the station to be stored.
- 2.) Press the PROG / MEMORY button once. "MEMORY" will flash in the display for 5 seconds. During this time you must select the desired memory location by pressing the REPEAT / MEMORY UP button.

- 3.) Press the PROG / MEMORY Button again to store the station at that location.

- 4.) The unit can store up to 20 FM stations, 20 AM stations.

TUNING TO A PRESET STATION

Select the desired station preset number by pressing the REPEAT / MEMORY UP button.



ANTENNA

FM

For FM reception there is a built-in 3 ft FM antenna wire at the rear of the unit. Unravel the wire and move it around to obtain the best reception.

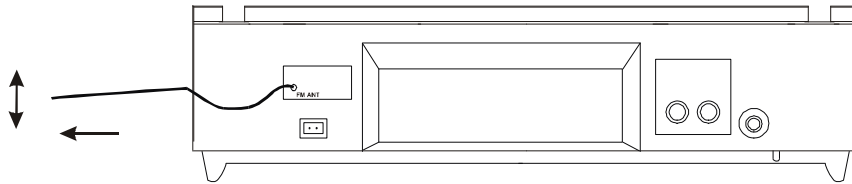

AM

This system includes an external AM Loop antenna. Assemble the AM loop antenna and then connect the wire from the antenna to the AM antenna terminal on the back of the set as shown. You may have to vary the position and direction of this AM Loop antenna until you find the position that provides the clearest reception for each of your favorite AM stations.

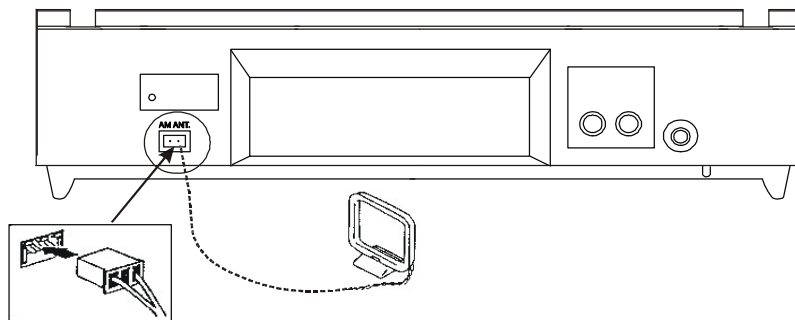

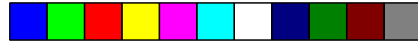



CLOCK SETTING

1.) Switch the unit to Standby mode by pressing the POWER  button.



2.) Press the PROG / MEMORY button. The hour digits will flash in the display.

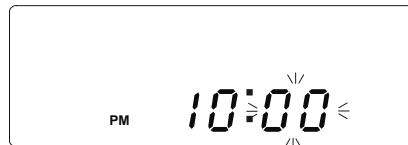

3.) Use the  /  buttons to set the required hour. Be sure to set correctly for AM or PM.

4.) Press the PROG / MEMORY button again. The Hour is now set and the Minute digits start to flash in the display.



5.) Use the  /  buttons to set the required minute.

6.) Press the PROG / MEMORY button again. The Minutes are now set and the clock will start.

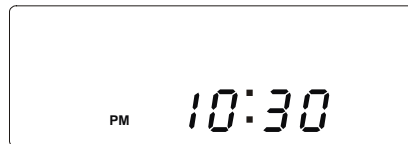





NOTE:

- Clock time is only retained while the unit is plugged into the AC outlet. In the event of a power failure the clock will need to be reset when the power supply resumes.
- Clock time is only shown when unit is in Standby mode.



PLAYING COMPACT DISCS

LOADING AND UNLOADING COMPACT DISCS

- 1.) Press the POWER  button to turn the unit 'On'.
- 2.) Select the CD function by pressing the CD button.
- 3.) Press the the CD Door Open / Close  button to open the CD compartment.
- 4.) When the disc compartment has opened, insert the disc with the label side facing up. Push down in the center until disc is locked in place.
- 5.) Close the disc compartment by pressing the CD Door Open / Close  button. When the compartment is fully closed, the disc will start turning automatically. The total number of tracks and playing time will appear in the display.
- 6.) The disc compartment may be opened at any time by first pressing the STOP  button and then pressing the CD Door Open / Close  button. Remove the CD only after the compartment has fully opened and the disc has stopped spinning.

CAUTION

- Do not put anything except a compact disc into the compartment.
- Foreign objects can damage the mechanism.
- Keep the disc compartment closed when not in use to prevent dirt and dust from entering the mechanism.
- Never place more than one disc into the disc compartment at any time.
- If the disc is correctly loaded, the total number of tracks on the disc will be displayed.

NOTES:

After the disc compartment is fully closed, the disc information may not appear on the display. This means that the disc is improperly loaded (most likely it is upside down). To check, open the disc compartment again and reload the disc.



DISC PLAY

- 1.) Insert a CD as described in the previous section and close the disc compartment.
- 2.) The display will then show the total number of tracks and total play time.
- 3.) Press the PLAY/PAUSE ►|| button. Disc play will begin from the start of the first track of the disc.

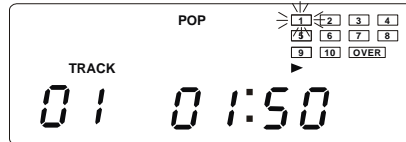

- 4.) As each track on the CD disc is played, the corresponding track number will flash in the Calendar display. The "OVER" indicator will appear if the disc in the player contains more than 10 tracks.

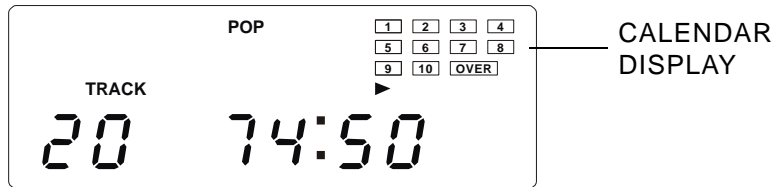

- 5.) A particular track can be selected using either of the CD Skip ◀◀ / ▶▶ buttons. If this is done before pressing the PLAY/PAUSE ►|| button, disc play will start with the selected track when the PLAY/PAUSE ►|| button is pressed.
- 6.) At the end of the disc, the unit will switch to stop mode.

NOTES:

- If the disc is deeply scratched, or too dirty, disc play may not start.
- If the disc is inserted incorrectly, or the disc is damaged the "no disc" indicator will flash on display.

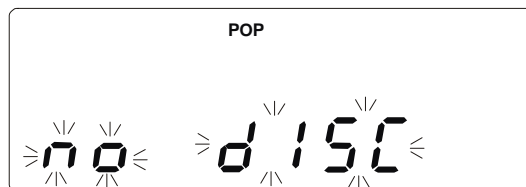



DISC ERRORS

- This compact disc player has built-in error compensation circuits to correct for minor defects in a disc. There are limits, however, to the amount of correction available.
- In some cases, the CD player may skip some tracks, or parts of tracks, on a disc during disc play. This problem may be caused by defects (such as scratches) in the disc being played, which are too large for the error compensation circuits to handle. If you encounter this problem, check the CD player's operation as follows, before having the unit serviced:
Play a new disc. If the CD player operates normally, the skipping problem is probably due to a defective disc.

TO STOP A CD BEFORE THE DISC ENDS

- 1.) Press the STOP ■ button. Disc play will stop, and the display will show the total number of tracks.

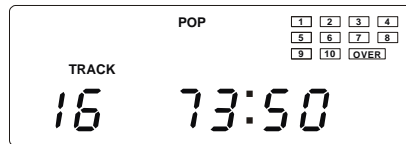

- 2.) To temporarily stop disc play (Pause mode), press the PLAY / PAUSE ►► button. Disc play will stop at the current play position. The display and the track playing time will flash.

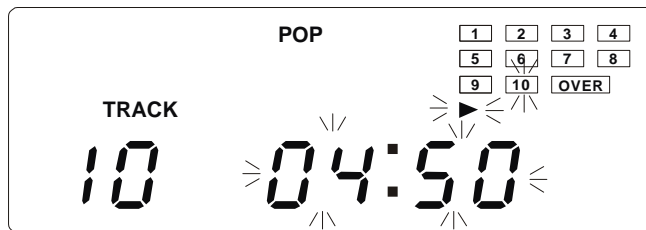

- 3.) To resume disc play, press the PLAY / PAUSE ►► button again.

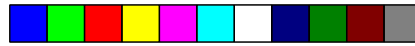

TRACK SKIP

Starting disc play from the beginning of a particular track

Press the Forward **▶▶** or Reverse **◀◀** Skip Track buttons to select the desired track. The number of the selected track will be shown on the CD display.

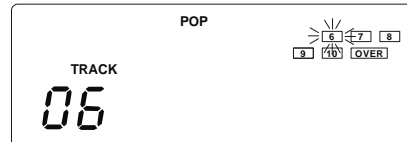

Press the PLAY/PAUSE **▶||** button to start play.

To skip to the next track

For example, to skip ahead to the beginning of track 5 while track 4 is playing.

- 1.) Press the Forward **▶▶** Skip track button once. Disc play will resume at the beginning of track 5.
- 2.) The CD player will skip ahead to the next track each time the Forward **▶▶** Skip track button is pressed. Repeatedly pressing the Forward **▶▶** Skip track button makes the CD player skip ahead through the disc track by track. Once the beginning of the last track is reached the CD player advance to the first track.

To skip to the previous track on a disc

For example to skip back to the beginning of track 3 while track 4 is playing.

- 1.) Press the Reverse **◀◀** Skip track button twice. Disc play will resume at the beginning of track 3.
- 2.) The CD player will skip back one track each time the Reverse **◀◀** Skip track button is pressed. If this button is pressed in the middle of a track, the CD player will skip back to the beginning of that track. To make it skip back to the previous track press the Reverse **◀◀** Skip track button twice.
- 3.) Repeatedly pressing the Reverse **◀◀** Skip track button makes the CD player skip back through the disc track by track. Once the beginning of the first track is reached, the CD player will go to the last track.

NOTES:

The Forward **▶▶** and Reverse **◀◀** Skip track buttons can be used to select a desired track to play before disc play starts. In this case the number of the selected track will be displayed until the PLAY/PAUSE **▶||** button is pressed.



TRACK SEARCH

You can search through the track by holding the Forward ►► or Reverse ◀◀ track skip button down. Normal play will resume when the button is released.

REPEAT DISC PLAY

Use the REPEAT button to play an entire disc or one track continuously.

Repeat play of all tracks

- 1.) Press the REPEAT / MEMORY UP button once. The “REPEAT” indicator appears in the display.

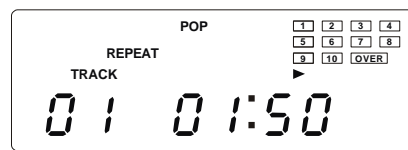

- 2.) Press the PLAY / PAUSE ►► button.

- 3.) The disc will then begin playing through to the end of the last track. At which point it will automatically return to the beginning of the first track. This will continue until the STOP ■ button is pressed.

- 4.) If the REPEAT / MEMORY UP button is pressed twice more, the “REPEAT” indicator will disappear and repeat play will end. Normal disc play will resume from that point.

- 5.) When the last track has finished playing, the CD play will Stop.

Repeat disc play of one of the tracks

- 1.) Select the desired track by pressing the Forward ►► or Reverse ◀◀ Skip track buttons. The track will be shown in the display.

- 2.) Press the REPEAT / MEMORY UP button twice. The “REPEAT” indicator flashes in the display.

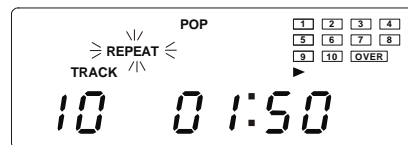

- 3.) Press the PLAY / PAUSE ►► button.

- 4.) The selected track will then begin playing through to its end. At which point it will automatically return to the beginning of that track. This will continue until the STOP ■ button is pressed.



- 5.) If the REPEAT / MEMORY UP button is pressed once more, the "REPEAT" indicator will disappear and, repeat play will end. Normal disc play will resume from that point.
- 6.) When the last track has finished playing, the CD player will then Stop.

PROGRAMMED DISC PLAY

- It is possible to program the tracks you wish to play in a sequence of your choice. It is not possible to enter program a disc during playback. Press the STOP ■ button first, then follow the instructions below.
- It is easier to use the remote control for the following settings, however you may also use the controls on the main unit if desired.

ENTERING A PROGRAM

- 1.) Press the PROG / MEMORY button. "TRACK MEMORY" flashes and "P-01" will be displayed on the display.

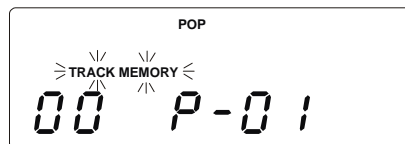

- 2.) Select the first desired track using the Forward ►► and Reverse ◀◀ Skip buttons.

- 3.) Press the PROG / MEMORY button. The first program selection is now stored in the program memory. The display will now show "P-02".

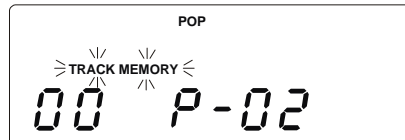

- 4.) Select the next desired track using the Forward ►► and Reverse ◀◀ Skip Buttons.
- 5.) Press the PROG / MEMORY button. Continue entering tracks in this way until all the desired tracks are stored (up to 20 tracks).

NOTES:

- If the PLAY / PAUSE ►|| button is pressed before the PROG / MEMORY button is pressed to store a track, the track will not be programmed, and the disc will start playing from the first selected track.



- Any track can be programmed to play more than once.
- Repeatedly pressing the PROG / MEMORY button will enable you to check the program if required.

LISTENING TO PROGRAMMED TRACKS

1.) Enter all tracks you want to program into memory following the procedures on page 16.

- 2.) Press the PLAY / PAUSE ►|| button.
Disc play will start at the beginning of the first programmed track.
“TRACK MEMORY” indicator appears on the display.

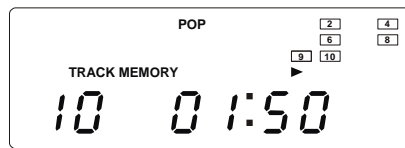

TO CLEAR THE PROGRAM MEMORY

- Press PROG / MEMORY button to enter programming mode, then press the STOP ■ button.
- The program memory will also be cleared if the disc compartment is opened, if the function is changed, or if the power is turned 'Off'.

MUTE

- Press the MUTE button on remote control to switch off the sound, the MUTE indicator will illuminate.
- Press MUTE again to restore the sound to the previous level. MUTE indicator will extinguish.

STEREO HEADPHONE JACK

For private listening without disturbing others connect a set of stereo headphones (not included) to the PHONES Jack on the back panel. The built-in speakers automatically shut off when stereo headphones are connected to the headphone jack. When using stereo headphones always start with the volume control set to a low level and gradually increase until you find the desired level.

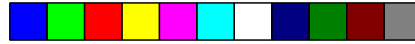

CARE AND MAINTENANCE

COMPACT DISC CARE

- To remove a disc from its storage case, press down on the centre of the case and lift the disc out, holding it carefully by the edges.

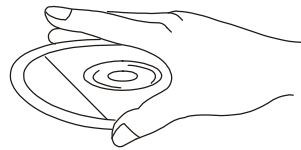
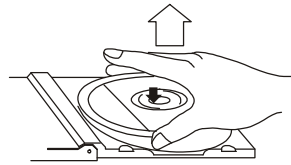

- Fingerprints and dust should be carefully wiped off the disc's recorded surface with a soft cloth. Unlike conventional records, compact discs have no grooves to collect dust and microscopic debris, so gently wiping with a soft cloth should remove most particles. Wipe in a straight line from the inside to the outside of the disc. Small dust particles and light stains will have absolutely no effect on reproduction quality.
- Clean the disc periodically with a soft, lint-free, dry cloth. Never use detergents or abrasive cleaners to clean the disc. If necessary, use a CD cleaning kit.
- Never write on or affix labels to the surface of compact discs.

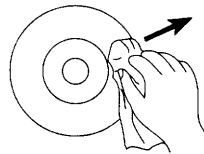
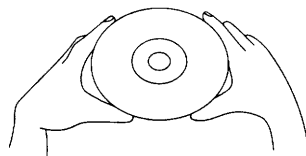

CARE OF THE CABINETS

- If the cabinets become dusty wipe them with a soft dry dust cloth. Do not use any wax or polish sprays on the cabinets.
- If the front panel becomes dirty or smudged with fingerprints it may be cleaned with a soft cloth slightly dampened with a mild soap and water solution. Never use abrasive cloths or polishes as these will mar the finish of your unit.

CAUTION:

Never allow any water or other liquids to get inside the unit while cleaning.



TROUBLESHOOTING GUIDE

Should this unit exhibit a problem, check the following before seeking service.

Symptom	Possible Cause	Solution
Radio		
Noise or sound distorted on AM or FM broadcasts.	Station not tuned properly for AM or FM.	Retune the AM or FM broadcast station.
	FM: Wire antenna is not extended.	Extend FM Wire antenna.
	AM: The Loop antenna is not positioned correctly.	Reposition the Ant. until best reception is obtained.
FM STEREO indicator does not light.	FM station is mono or station signal is weak.	Extend FM Wire antenna. Try other strong stations.
AM or FM, no sound.	Function is not set to Tuner.	Press TUNER button to select Tuner function.
	Volume at minimum.	Increase Volume.
Compact Disc Player		
CD Player will not play.	Function is not set to CD.	Press CD button to select CD function.
	CD is not installed or installed incorrectly.	Insert CD with label side up.
CD skips while playing.	Disc is dirty or scratched.	Wipe disc with cloth or use another disc.



TO FIND THE LOCATION AND PHONE NUMBER OF YOUR NEAREST SERVICE CENTER PERMITTED TO PERFORM WARRANTY...

CALL TOLL FREE: 1-800-695-0098

FOR ADDITIONAL SET-UP OR OPERATING ASSISTANCE PLEASE CALL:
1-800-898-9020

FOR CUSTOMER SERVICE, PLEASE WRITE TO:
Emerson Radio Corp.,
Consumer Affairs Dept.,
1901 Diplomat Drive,
Farmers Branch, TX 75234.

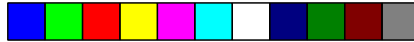

**EMERSON RADIO CORP.
LIMITED WARRANTY**

What does this warranty cover ? Any manufacturing defects in original material, including original parts and workmanship, under normal use and conditions.

For how long? For a period of ninety (90) days from the date of original purchase in the U.S.

What will we do ? If you need service under this Warranty, and you provide us with the dated proof of purchase, we will provide repair service at no charge for labor and parts at an authorized Depot Repair Facility, or replace the product in our discretion.

How do you make your warranty claim ? If it becomes necessary to repair your unit, you can obtain the name and mailing location of a Depot Repair Facility by dialing **1-800-695-0098**. You should pack your unit in a well-padded heavy corrugated box, enclose your check or money order payable to the Depot Repair Facility in the amount of **\$9.00** to cover the return shipping and handling costs, and enclose a copy of your proof of purchase (warranty service will not be provided without a dated proof of purchase). Finally, you should ship the unit prepaid via UPS or parcel post (insured).

What does your warranty not cover ? Your warranty does not cover the following :

- Damage from negligence, misuse, abuse, accident, or failure to follow operating instructions.
- Use of product in a commercial application or rentals.
- Changes or repairs by anyone other than an authorized Depot Repair Facility.
- Damage because your unit is improperly connected to the equipment of other manufacturers.
- Unit on which the serial number has been defaced, modified or removed.
- Damage to equipment not properly connected to the product.
- Cost incurred in shipping your unit to and from an authorized Depot Repair Facility.
- Ordinary adjustments which you can perform as outlined in the owner's manual.
- Signal reception problems caused by external antenna or cable systems.
- Products purchased, used, serviced, or damaged outside of the United States.
- Damage to compact discs or cassettes.

What other limitations apply to your warranty ?

THIS WARRANTY IS NON-TRANSFERABLE AND APPLIES ONLY TO THE ORIGINAL PURCHASER AND DOES NOT EXTEND TO SUBSEQUENT OWNERS OF THE PRODUCT. THIS WARRANTY IS VALID ONLY IN THE UNITED STATES OF AMERICA. ANY APPLICABLE IMPLIED WARRANTIES, INCLUDING THE WARRANTY OF MERCHANTABILITY, ARE LIMITED IN DURATION TO A PERIOD OF THE EXPRESSED WARRANTY AS PROVIDED ABOVE BEGINNING WITH THE DATE OF ORIGINAL PURCHASE AT RETAIL AND NO WARRANTIES, WHETHER EXPRESSED OR IMPLIED, SHALL APPLY TO THE PRODUCT THEREAFTER. WE MAKE NO WARRANTY AS TO THE FITNESS OF THE PRODUCT FOR ANY PARTICULAR PURPOSE OR USE.

THE EXTENT OF OUR LIABILITY UNDER THIS LIMITED WARRANTY IS THE REPAIR OR REPLACEMENT PROVIDED ABOVE AND IN NO EVENT WILL OUR LIABILITY EXCEED THE PURCHASE PRICE PAID BY THE PURCHASER OF THE PRODUCT. UNDER NO CIRCUMSTANCES WILL WE BE LIABLE FOR ANY LOSS, DIRECT, INDIRECT, INCIDENTAL, SPECIAL, OR CONSEQUENTIAL DAMAGE ARISING OUT OF OR IN CONNECTION WITH THE USE OF THIS PRODUCT.

How does state law apply to your warranty ?

THIS WARRANTY GIVES YOU SPECIFIC LEGAL RIGHTS, BUT YOU MAY ALSO HAVE OTHER RIGHTS WHICH VARY FROM STATE TO STATE. SOME STATES DO NOT ALLOW LIMITATIONS ON IMPLIED WARRANTIES OR EXCLUSION OR LIMITATION OF INCIDENTAL OR CONSEQUENTIAL DAMAGE, SO THESE RESTRICTIONS MAY NOT APPLY TO YOU.

AU898F





EMERSON RADIO CORP.



EMERSON
Part No. : 16-2857
204-01

Printed in China

