

***Portable CD Player
with AM/FM Stereo Radio***



OWNER'S MANUAL

PD6810



Visit our web site at www.emersonradio.com

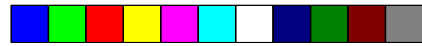



CAUTION

TO PREVENT FIRE OR SHOCK HAZARD, DO NOT USE THIS PLUG WITH AN EXTENSION CORD, RECEPTACLE OR OTHER OUTLET UNLESS THE BLADES CAN BE FULLY INSERTED TO PREVENT BLADE EXPOSURE. TO PREVENT FIRE OR SHOCK HAZARD, DO NOT EXPOSE THIS APPLIANCE TO RAIN OR MOISTURE.

 <p>The lightning flash with arrowhead symbol, within an equilateral triangle is intended to alert the user to the presence of uninsulated 'dangerous voltage' within the product's enclosure that may be of sufficient magnitude to constitute a risk of electric shock to persons.</p>	<p style="text-align: center;">CAUTION RISK OF ELECTRIC SHOCK DO NOT OPEN</p> <p>WARNING: TO REDUCE THE RISK OF ELECTRIC SHOCK DO NOT REMOVE COVER (OR BACK), NO USER SERVICEABLE PARTS INSIDE. REFER SERVICING TO QUALIFIED SERVICE PERSONNEL.</p>	 <p>The exclamation point within an equilateral triangle is intended to alert the user to the presence of important operating and maintenance (servicing) instructions in the literature accompanying the appliance.</p>
---	---	---

The Caution Marking maybe located at the bottom enclosure of the apparatus.

IMPORTANT SAFETY INSTRUCTIONS

- 1.) Read these instructions. Keep these instructions. Follow all instructions. Heed all warnings.
- 2.) Do not use this apparatus near water.
- 3.) Clean only with dry cloth.
- 4.) Do not block any ventilation openings. Install in accordance with the manufacturer's instructions.
- 5.) Do not install near any heat sources such as radiators, heat registers, stoves, or other apparatus (including amplifiers) that produce heat.
- 6.) Do not defeat the safety purpose of the polarized or grounding-type plug. A polarized plug has two blades with one wider than the other. A grounding type plug has two blades and a third grounding prong. The wide blade or the third prong is provided for your safety. If the provided plug does not fit into your outlet, consult an electrician for replacement of the obsolete outlet.
- 7.) Protect the power cord from being walked on or pinched particularly at plugs, convenience receptacles, and the point where they exit from the apparatus.
- 8.) Only use attachments / accessories specified by the manufacturer.
- 9.) Unplug this apparatus during lightning storms or when unused for long periods of time.
- 10.) Refer all servicing to qualified service personnel. Servicing is required when the apparatus has been damaged in any way, such as power-supply cord or plug is damaged, liquid has been spilled or objects have fallen into the apparatus, the apparatus has been exposed to rain or moisture, does not operate normally, or has been dropped.
- 11.) This appliance shall not be exposed to dripping or splashing water and no object filled with liquids such as vases shall be placed on the apparatus.
- 12.) Use only with the cart, stand, tripod, bracket, or table specified by the manufacturer, or sold with the apparatus. When a cart is used, use caution when moving the cart/ apparatus combination to avoid injury from tip-over.
- 13.) Do not overload wall outlet. Use only power source as indicated.
- 14.) Use replacement parts as specified by the manufacturer.
- 15.) The product may be mounted to a wall only if recommended by the manufacturer.
- 16.) Upon completion of any service or repairs to this product, ask the service technician to perform safety checks.





BEFORE WE BEGIN

Thank you for purchasing this Emerson audio product. The Emerson brand is your assurance of quality, performance and value.

Our engineers have included many useful and convenient features in this product. Please be sure to read this Owner's Manual completely to make sure you are getting the maximum benefit from each feature.

This product was manufactured using the highest quality components and standards of workmanship. It was tested by Emerson inspectors and found to be in perfect working order before it left our factory. However, there is always the chance that some problem may occur because of rough handling during shipment to the retail store or to the final consumer.

If, after reading this Manual, you experience any problems with the operation of this product, please refer to the instructions for obtaining service at the end of this Manual. Emerson and Emerson retailers are committed to your satisfaction.

Once again, thanks for purchasing this Emerson audio product.



IMPORTANT NOTES

- Avoid installing this unit in places exposed to direct sunlight or close to heat radiating appliances such as electric heaters, on top of other stereo equipment that radiates too much heat, places lacking ventilation or dusty areas, places subject to constant vibration and/ or humid or moist areas.
- Do not attempt to clean this unit with chemical solvents as this might damage the finish. Use a clean dry cloth.
- Operate controls and switches as described in the manual.
- Before turning 'On' the power, make certain that AC power cord is properly installed.
- Store your CDs, in a cool area to avoid damage from heat.
- When moving the set, be sure to first disconnect the AC power cord.

CLASS 1 LASER PRODUCT

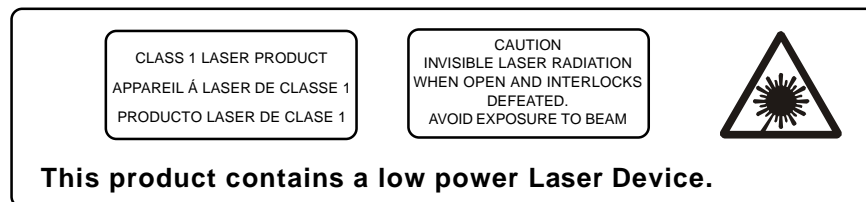

FCC Information

This equipment has been tested and found to comply with the limits for a Class B digital device, pursuant to Part 15 of the FCC Rules. These limits are designed to provide reasonable protection against harmful interference in a residential installation. This equipment generates, uses, and can radiate radio frequency energy and, if not installed and used in accordance with the instructions, may cause harmful interference to radio communications. However, there is no guarantee that interference will not occur in a particular installation. If this equipment does cause harmful interference to radio or television reception, which can be determined by turning the equipment off and on, the user is encouraged to try to correct the interference by one or more of the following measures:

- Reorient or relocate the receiving antenna.
- Increase the separation between the equipment and receiver.
- Connect the equipment into an outlet on a circuit different from that to which the receiver is connected.
- Consult the dealer or an experienced radio/TV technician for help.

This device complies with Part 15 of the FCC Rules. Operation is subject to the following two conditions:

- (1) This device may not cause harmful interference, and
- (2) This device must accept any interference received, including interference that may cause undesired operation.

Changes or modifications not expressly approved by the party responsible for compliance could void the user's authority to operate the equipment.



PREPARATION FOR USE

Unpacking and Set Up

- Carefully remove the unit and the accessories from the carton and remove all the packing material from the unit.
- Carefully remove any small strips of tape which may have been used to keep the CD door closed during shipment.
- Open the CD compartment by pressing the **OPEN** button on top panel. Inside the CD compartment you will see a “dummy CD” transit card which is used to prevent the laser pick-up from moving during shipment. Carefully remove this card and close the CD compartment door.
- **Note the Serial Number on the bottom of your unit and write this number in the space provided on the Warranty page of this manual.**
- Please save the carton and packing materials in the event that your unit ever needs to be returned for service. The original carton and packing materials are the only way to protect the unit from damage during shipment.

Protect Your Furniture

This model is equipped with non-skid rubber ‘feet’ to prevent the product from moving when you operate the controls. These ‘feet’ are made from non-migrating rubber material specially formulated to avoid leaving any marks or stains on your furniture. However certain types of oil based furniture polishes, wood preservatives, or cleaning sprays may cause the rubber ‘feet’ to soften, and leave marks or a rubber residue on the furniture. To prevent any damage to your furniture we strongly recommend that you purchase small self-adhesive felt pads, available at hardware stores and home improvement centers everywhere, and apply these pads to the bottom of the rubber ‘feet’ before you place the product on fine wooden furniture.



Power Sources

This unit is designed to operate on 8 “C” batteries, not included, or on normal 120V 60Hz AC house current. Operating this unit from any other power source may cause damage to the unit, and such damage is not covered by your warranty.

AC Operation

Connect the small end of the AC Power Cord to the AC socket on the back cabinet, then insert the plug in any convenient household 120V 60Hz AC outlet.

NOTE: *This unit has a polarized AC plug with one wide blade and one narrow blade. This plug will only fit into a matching polarized AC outlet. This is a safety feature to reduce the possibility of electric shock.*

If this plug will not fit in your AC outlet, you probably have an outdated non-polarized outlet. You should have your outdated outlet changed by a qualified, licensed electrician. Do not file the wide blade on the plug, or use an adapter to make the plug fit into your outlet. This defeats the safety feature and could expose you to electric shock.

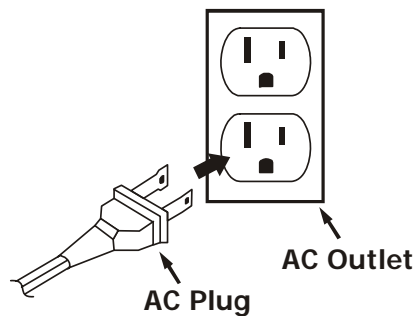

Battery Precautions

- Replacement of batteries must be done by an adult.
- Do not mix old and new batteries.
- Do not mix alkaline, standard (carbon-zinc) or rechargeable (nickel-cadmium) batteries.
- The supply terminals are not to be short-circuited.
- Non-rechargeable batteries are not to be recharged.
- Exhausted batteries are to be removed.
- Only batteries of the equivalent type are to be used.
- Batteries are to be inserted with the correct polarity.
- Dispose of batteries properly. Do not dispose of batteries in fire. The batteries may explode or leak.



LOCATION OF CONTROLS AND INDICATORS

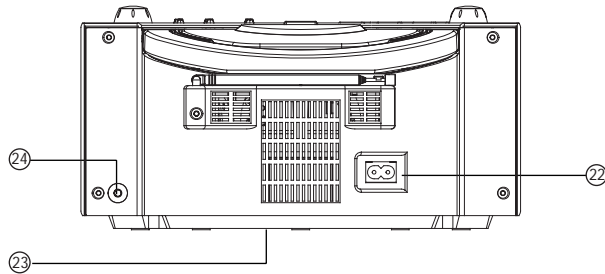
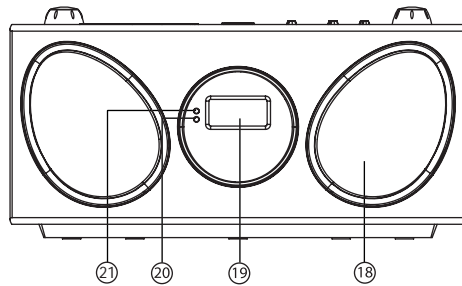
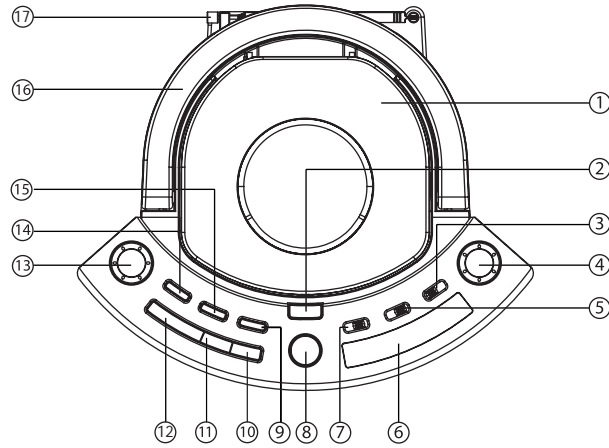



- 1.) CD door.
- 2.) CD door **OPEN** Button.
- 3.) Band (**AM / FM / FM ST.**) Selector Switch.
- 4.) **TUNING** Knob: To tune your radio station.
- 5.) Function selector: **CD - OFF - RADIO**.
- 6.) Dial Scale and Pointer.
- 7.) **X.BASS ON/OFF** Selector Switch.
- 8.) **▶|| PLAY/PAUSE** Button.
- 9.) **REPEAT** Button.
- 10.) **FWD.SKIP/SEARCH ▶▶** Button.
- 11.) **REV.SKIP/SEARCH ◀◀** Button.
- 12.) **■ STOP** Button.
- 13.) **VOLUME** Control.
- 14.) **RANDOM** Button.
- 15.) **PROGRAM** Button.
- 16.) Carrying Handle.
- 17.) FM Telescopic Antenna.
- 18.) Speakers.
- 19.) CD Display.
- 20.) **FM STEREO** Indicator.
- 21.) **POWER 'On'** Indicator.
- 22.) AC Socket (at back Cabinet).
- 23.) Battery Compartment (at Bottom).
- 24.) **AUX IN** Jack.

POWER SUPPLY

You can use the AC power or batteries as a power source.

AC OPERATION

Insert one end of the supplied AC cord into the socket located at the rear of the set, and the other end into the 120V 60Hz standard household outlet.

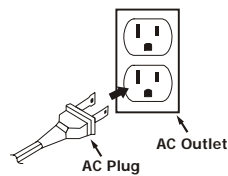
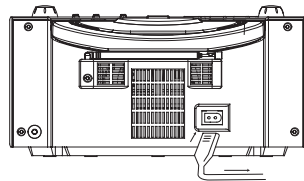

BATTERY OPERATION

Disconnect the AC power cord from the AC socket of the unit. Battery power is cut automatically while the cord is connected. Insert 8 size "C" batteries. (not supplied with the unit). When the volume decreases, or the sound distorts, replace all the batteries with new ones.

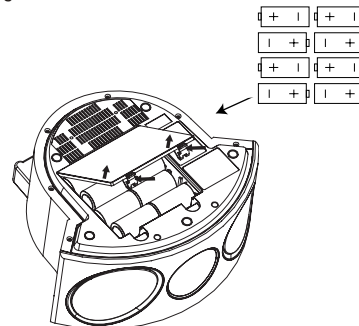

Note : We recommend alkaline batteries for longer life.





ADJUSTING THE SOUND

Turn the knob to adjust the volume.

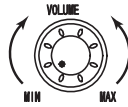

Bass Booster

Slide X-BASS switch to the "ON" position for extra bass.



Note : To establish a safe level :

- Start your volume control at a low setting.
- Slowly increase the sound until you can hear it comfortably and clearly, and without distortion.

LISTENING TO THE RADIO

1.) Slide the FUNCTION switch to the RADIO position, the POWER LED will turn on.



2.) Slide the BAND switch to the desired band position (AM, FM or FM ST.) that you want.



3.) Tune into the desired station using the TUNING control.

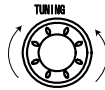

4.) This indicator will light up when you select FM ST. band and the FM station is broadcasting in Stereo.



5.) After listening, set the FUNCTION switch to OFF position.

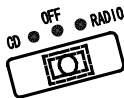

FOR BETTER RECEPTION

FM

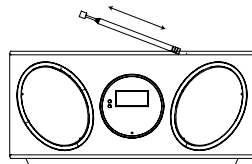

Extend the telescopic antenna.

AM

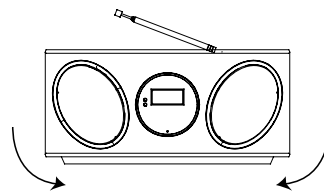

Rotate the unit for best reception.





COMPACT DISC PLAYBACK

IMPORTANT ! The unit should not be carried around during CD playback. If the unit is bumped and shocked during playback, the disc may skip or stop.

- 1.) Slide the FUNCTION switch to CD position, the POWER LED will turn on. The display will show the symbol “- -”.

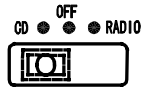

- 2.) Press the CD OPEN button to open the CD door.



- 3.) Insert a disc with the label side facing up. Press down near the center hole to make sure the disc is firmly seated on the spindle.



- 4.) Close the CD DOOR by pushing it down. The display will show the total tracks of the CD.

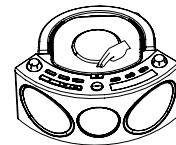

- 5.) Press the PLAY/PAUSE button. Playback will begin on track 1 “PLAY ▶” and ‘track no’ will appear on the display.

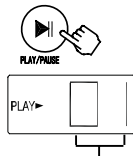

Track number

TO INTERRUPT PLAYBACK

Press the PLAY/PAUSE button once during playback. Playback pauses and the “PLAY ▶” indicator flashes. Press the PLAY/PAUSE button again to cancel pause and resume playback at the same point in the track. “PLAY ▶” indicator stops flashing.

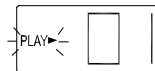

TO SKIP TO THE BEGINNING OF THE TRACK

- 1.) Press either one of the ◀◀ REV / ▶▶ FWD skip buttons according to the desired skip direction.
- 2.) Playback resumes from the selected track.
- 3.) When the ▶▶ button is pressed once during playback, the player advances to the beginning of the next track.
- 4.) When the ◀◀ button is pressed once during playback, the player returns to the beginning of the track being played. To back up to the beginning of the previous track press the button twice.



SEARCHING FOR A PASSAGE WITHIN A TRACK

Keep the ▶▶/◀◀ button pressed during playback, and release the button as soon as you recognize the desired passage. Normal CD playback will resume from this point.

TO STOP PLAYBACK

Press the STOP button to stop playback and the display shows the total tracks of the disc.

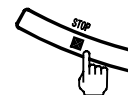

Note : After pressing the STOP button wait a few seconds for the disc to stop completely before opening the CD door.





PROGRAMMED PLAYBACK

Programmed playback enables tracks on a disc to be played in any desired order. Up to 20 tracks can be programmed.

Note : Programming can only be done when the player is in stop mode.

- 1.) Press the PROGRAM button. "PROGRAM" indicator and "00" flash in the display.

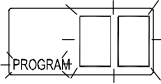

- 2.) Press the >>>/<<< button to select the desired track number.

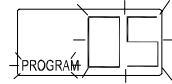

- 3.) Press PROGRAM button again to memorize the track.



- 4.) Repeat steps 2 and 3 until all desired tracks are programmed.

- 5.) Press the PLAY/PAUSE >>|| button to start playback. "PROGRAM" indicator is flashing in the CD display.

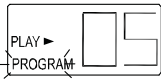

- 6.) Press STOP ■ button to stop programmed playback. The CD playback stops but the program remains in the memory.



- 7.) Press PROGRAM and PLAY/PAUSE >>|| buttons to resume programmed playback.



- 8.) To clear the program memory, open the CD door, change to Radio function or switch the power "OFF".





RANDOM PLAYBACK

This plays the songs on the disc in random order.

Note : Random playback can only be selected while the player is in the stop mode.

- 1.) Press the RANDOM button to play the tracks in random order. "PLAY ►" and "MIX" indicators appear in the display and play all the tracks in random order. When all tracks have been played, the player stops and the display shows the total tracks.

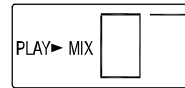

- 2.) To cancel Random playback press "STOP ■" button, the display shows total tracks, "PLAY ►" and "MIX" indicators disappear.

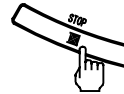



REPEAT PLAYBACK

This function allows a single track or all tracks on disc to be played repeatedly.

TO REPEAT THE SAME TRACK

Press the REPEAT button once during playback. The CD display will indicate "REPEAT".

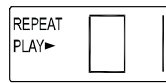

TO REPEAT THE WHOLE DISC

Press the REPEAT button twice until "REPEAT ALL" displays.

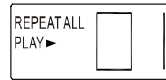

TO CANCEL REPEAT PLAYBACK FUNCTION

Press the REPEAT button again until "REPEAT" or "REPEAT ALL" disappears from the display.

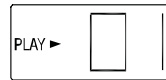



AUXILIARY INPUT JACK (Connection Cable Not Included)

This unit includes an **AUX IN** input jack to allow you to connect external devices, such as an iPod® or portable MP3 player, and listen to the music stored on your external device through the speakers of this radio.

Connect the headphone jack of your external device to the **AUX IN** input jack located on the right side of this unit. The connection cable is not included.

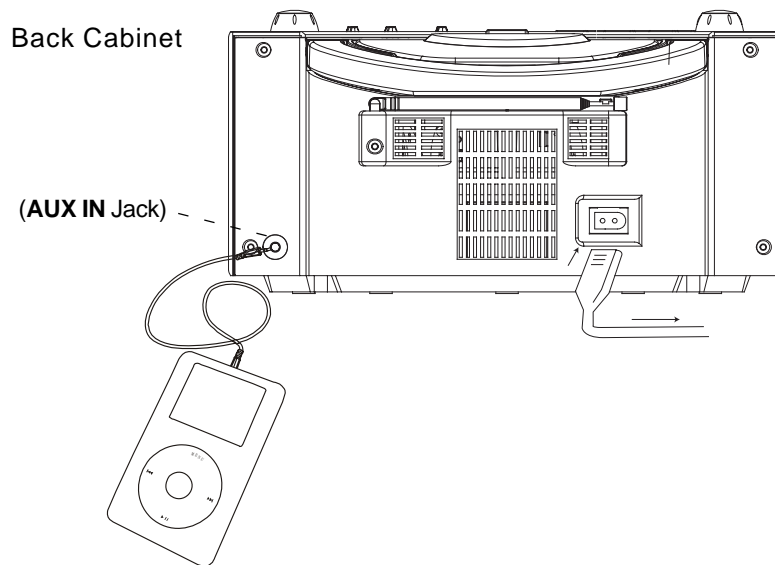

IMPORTANT:

*When you connect a cable to the **AUX IN** input jack of this unit the Function selector automatically switches from Radio or CD to Auxiliary Input.*

*You must disconnect the cable from the **AUX IN** input jack in order to listen to the Radio or CD again.*

*After connecting your external device to the **AUX IN** input jack, slowly adjust both the volume controls on this unit and your external device to find the desired setting. Please note that if the **VOLUME** control on this radio is set to a low level while the **VOLUME** control on your external device is set too high, the sound will be distorted.*

Remember to disconnect the connection cable after use in order to be able to listen to the Radio or CD player again.

iPod® is a trademark of Apple Computer Inc., registered in the U.S. and other countries.





CARE AND MAINTENANCE

Compact Disc Care

- To remove a disc from its storage case, press down on the center of the case and lift the disc out, holding it carefully by the edges.



- Fingerprints and dust should be carefully wiped off the disc's recorded surface with a soft cloth. Unlike conventional records, compact discs have no grooves to collect dust and microscopic debris, so gently wiping with a soft cloth should remove most particles. Wipe in a straight line from the inside to the outside of the disc. Small dust particles and light stains will have absolutely no effect on reproduction quality.

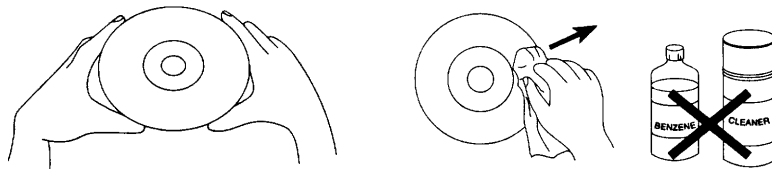

- Clean the disc periodically with a soft, lint-free, dry cloth. Never use detergents or abrasive cleaners to clean the disc. If necessary, use a CD cleaning kit.
- Never write on or affix labels to the surface of compact discs.





Care Of Cabinets

If the cabinet becomes dusty, wipe it with a soft cloth. If the cabinet becomes smudged or dirty, clean it with a soft, slightly dampened cloth.

Never allow water or any liquid to get inside the cabinet.

Never use any abrasive cleaners or cleaning pads as these will damage the finish of your CD Player.

 Emerson [®] SERVICE	TO FIND THE LOCATION AND PHONE NUMBER OF YOUR NEAREST SERVICE CENTER PERMITTED TO PERFORM WARRANTY...
CALL TOLL FREE: 1-800-695-0098	
FOR ADDITIONAL SET-UP OR OPERATING ASSISTANCE PLEASE CALL: 1-800-898-9020	
FOR CUSTOMER SERVICE, PLEASE WRITE TO: Emerson Radio Corp., Consumer Affairs Dept., 5101 Statesman Drive, Irving, TX 75063.	



LIMITED WARRANTY

Emerson Radio Corp. warrants manufacturing defects in original material, including original parts and workmanship, under normal use and conditions, for a period of ninety (90) days from the date of original purchase in the U.S. With your dated proof of purchase, we will provide repair service at no charge for labor and parts at an authorized Depot Repair Facility, or replace the product in our discretion. For repair or replacement, pack your unit in a padded box, enclose your check or money order payable to Emerson Radio Corp. in the amount of \$9.00 (not required by California residents) to cover shipping and handling costs, and enclose a copy of your proof of purchase. Send your unit to:

Emerson Radio Corp.,
5101 Statesman Drive,
Irving, TX 75063.

This warranty does not cover damage from negligence, misuse, abuse, accident, failure to follow operating instructions, commercial use, rental, repairs by an unauthorized facility, or products purchased, used, serviced or damaged outside of the United States.

THIS WARRANTY GIVES YOU SPECIFIC LEGAL RIGHTS, AND YOU MAY ALSO HAVE OTHER RIGHTS WHICH VARY FROM STATE TO STATE.

AU898M

The Serial Number can be found on the bottom cabinet. We suggest that you record the Serial Number of your unit in the space below for future reference.

Model Number: PD6810

Serial Number:



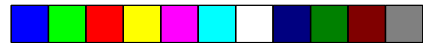

EMERSON
Part No. 16-2919-T
705-01

Printed in China



PD6810_T051807.P65

17



18/5/2007, 15:08

