

WARNING

TO PREVENT FIRE OR SHOCK HAZARD, DO NOT USE THIS PLUG WITH AN EXTENSION CORD, RECEPTACLE OR OTHER OUTLET UNLESS THE BLADES CAN BE FULLY INSERTED TO PREVENT BLADE EXPOSURE. TO PREVENT FIRE OR SHOCK HAZARD, DO NOT EXPOSE THIS APPLIANCE TO RAIN OR MOISTURE.



The lightning flash with arrowhead symbol, within an equilateral triangle is intended to alert the user to the presence of uninsulated 'dangerous voltage' within the product's enclosure that may be of sufficient magnitude to constitute a risk of electric shock to persons.

CAUTION

**RISK OF ELECTRIC SHOCK
DO NOT OPEN**

CAUTION: TO REDUCE THE RISK OF ELECTRIC SHOCK DO NOT REMOVE COVER (OR BACK), NO USER SERVICEABLE PARTS INSIDE. REFER SERVICING TO QUALIFIED SERVICE PERSONNEL.



The exclamation point within an equilateral triangle is intended to alert the user to the presence of important operating and maintenance (servicing) instructions in the literature accompanying the appliance.

IMPORTANT SAFETY INSTRUCTIONS

1. Read these instructions.
2. Keep these instructions.
3. Heed all warnings.
4. Follow all instructions.
5. Do not use this apparatus near water.
6. Clean only with dry cloth.
7. Do not block any ventilation openings. Install in accordance with the manufacturer's instructions.
8. Do not install near any heat sources such as radiators, heat registers, stoves, or other apparatus (including amplifiers) that produce heat.
9. Do not defeat the safety purpose of the polarized or grounding-type plug. A polarized plug has two blades with one wider than the other. A grounding type plug has two blades and a third grounding prong. The wide blade or the third prong are provided for your safety. If the provided plug does not fit into your outlet, consult an electrician for replacement of the obsolete outlet.
10. Protect the power cord from being walked on or pinched particularly at plugs, convenience receptacles, and the point where they exit from the apparatus.
11. Only use attachments / accessories specified by the manufacturer.
12. Unplug this apparatus during lightning storms or when unused for long periods of time.
13. Refer all servicing to qualified service personnel. Servicing is required when the apparatus has been damaged in any way, such as power-supply cord or plug is damaged, liquid has been spilled or objects have fallen into the apparatus, the apparatus has been exposed to rain or moisture, does not operate normally, has changed its performance, or has been dropped.
14. This appliance shall not be exposed to dripping or splashing water and no object filled with liquids such as vases shall be placed on the apparatus.
15. Do not overload wall outlet. Use only power source as indicated.
16. Use replacement parts as specified by the manufacturer.
17. The product may be mounted to a wall only if recommended by the manufacturer.
18. Upon completion of any service or repairs to this product, ask the service technician to perform safety checks.

IMPORTANT SAFETY INSTRUCTIONS (CONTINUED)

FCC INFORMATION

This equipment has been tested and found to comply with the limits for a Class B digital device, pursuant to Part 15 of the FCC Rules. These limits are designed to provide reasonable protection against harmful interference in a residential installation. This equipment generates, uses, and can radiate radio frequency energy and, if not installed and used in accordance with the instructions, may cause harmful interference to radio communications. However, there is no guarantee that interference will not occur in a particular installation. If this equipment does cause harmful interference to radio or television reception, which can be determined by turning the equipment off and on, the user is encouraged to try to correct the interference by one or more of the following measures:

- Reorient or relocate the receiving antenna.
- Increase the separation between the equipment and receiver.
- Connect the equipment into an outlet on a circuit different from that to which the receiver is connected.
- Consult the dealer or an experienced radio/TV technician for help.

LASER SAFETY: This unit employs a laser. Only qualified service personnel should attempt to service this device due to possible eye injury.

CAUTION: USE OF CONTROLS, ADJUSTMENTS OR PERFORMANCE OF PROCEDURES OTHER THAN THOSE SPECIFIED HEREIN MAY RESULT IN HAZARDOUS RADIATION EXPOSURE.

WARNING: DO NOT EXPOSE THIS APPLIANCE TO RAIN OR MOISTURE.

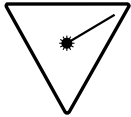

DANGER:

Invisible and hazardous laser radiation when open and interlock failed or defeated. Avoid direct exposure to beam.

FCC WARNING:

This equipment may generate or use radio frequency energy. Changes or modifications to this equipment may cause harmful interference unless the modifications are expressly approved in the instruction manual. The user could lose the authority to operate this equipment if an unauthorized change or modification is made.

Thank you for purchasing the Girlpower Portable CD Player with AM/FM Radio from Emerson. This unique product has been designed to provide you with many years of exceptional performance with a minimum of care and maintenance.

Please review the contents of the instruction manual completely and carefully before operating your unit. All of the functions and operations of the unit are fully explained in the manual to enable you to gain the maximum benefit out of all the great product features.

The serial number of your unit can be found on a label on the rear of the cabinet. For future reference, we suggest that you record the serial number in the space provided below.

Model Number: GP208

Serial Number: _____

PREPARATION FOR USE

Unpacking and Setup

- Carefully remove the unit from the display carton and remove all packing material from the unit itself.
- Remove any descriptive labels that may be found on either the front or top cabinet of the unit. Do not remove any labels located on either the back or bottom cabinet of the unit.
- The detachable AC power cord is packed in the carton separately from the unit. Make sure that the AC power cord is not accidentally discarded with the carton or packing material.
- Press the CD Door OPEN/CLOSE area to open the CD compartment door. There is a white card in the CD compartment which is intended to prevent the CD pickup from moving during shipment of the product. Remove this card from the CD compartment before use.
- When opening the CD compartment door, make sure the carrying handle is folded completely down.

Power Sources

This portable audio system is designed to operate on either 120V AC 60Hz house current or 12V DC, using 8 'C' batteries (UM-2), not included. Attempting to operate this unit from any other power source may cause damage to the unit, which is not covered by your warranty.

AC Operation

Unwind the AC power cord and extend it to its full length. Insert the small end of the AC power cord into the AC socket on the back cabinet of the unit. Insert the other end of the AC power cord into any convenient 120V 60 Hz household outlet.

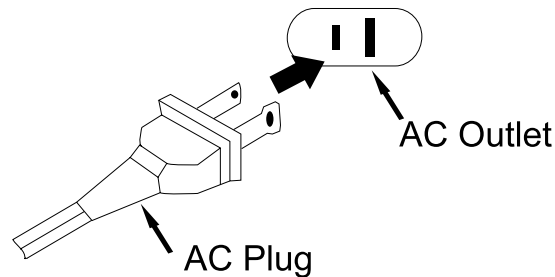

Please note that this unit is equipped with a polarized AC plug which has one blade wider than the other. This is a safety feature to reduce the likelihood of electric shock. This polarized AC plug will only fit in a polarized AC outlet. If you find that you cannot insert this plug into your outlet, you may have an obsolete non-polarized outlet. Please do not try to defeat this safety feature by using a non-polarized adapter or by filing the wider blade to make it fit into your outlet. If this plug does not fit into your outlet, you should contact a qualified licensed electrician to replace your obsolete outlet.

PREPARATION FOR USE (CONTINUED)

Battery Operation

The battery compartment is located on the bottom of the cabinet.

- Remove the battery compartment door by sliding the battery compartment open.
- Insert 8 'C' size (UM-2) batteries into the battery compartment as shown in the figure below. Be sure to observe the polarity markings which are engraved inside the battery compartment. If the batteries are inserted incorrectly, the unit will not operate.
- Replace the battery compartment door.

NOTE: The AC power cord must be disconnected from the AC jack on the back of the unit in order for the unit to operate on battery power.

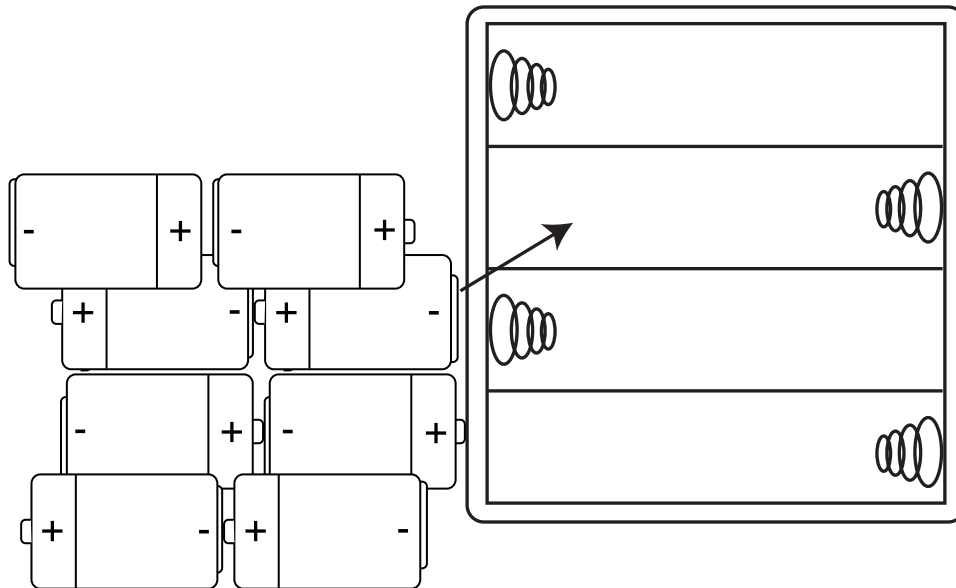

BATTERY PRECAUTIONS

Follow these precautions when using batteries in this device:

1. Use only the size and type of batteries specified.
2. Be sure to follow the correct polarity when installing the batteries as indicated in the battery compartment. Reversed batteries may cause damage to the device.
3. Do not mix different types of batteries together (e.g. Alkaline and Carbon-zinc) or old batteries with fresh ones.
4. If the device is not to be used for a long period of time, remove the batteries to prevent damage or injury from possible battery leakage.
5. Do not try to recharge batteries not intended to be recharged; they can overheat and rupture. (Follow battery manufacturer's directions.)

LOCATION OF CONTROLS AND INDICATORS

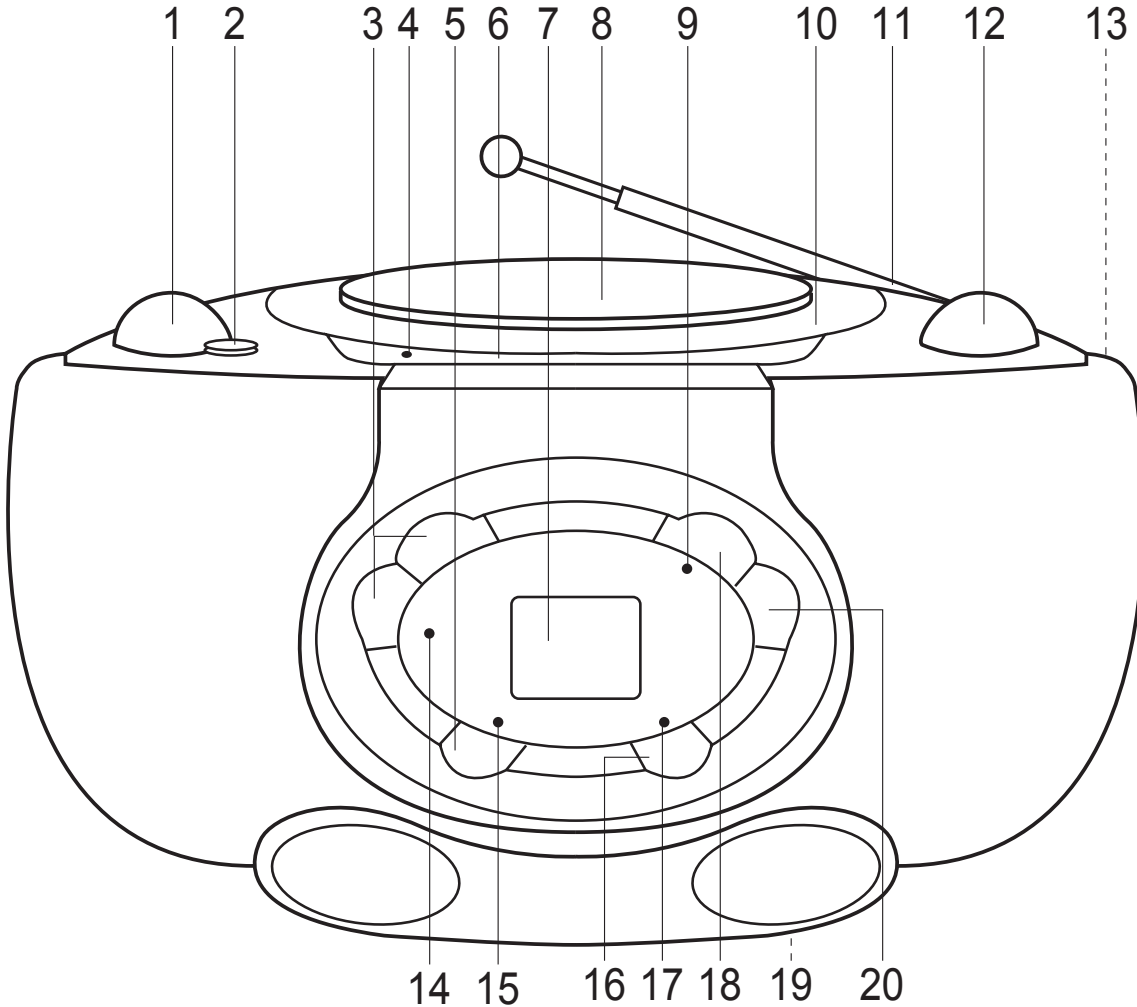

- | | |
|---------------------------------|---|
| 1. VOLUME Control | 12. TUNING Control |
| 2. BASS BOOST Button | 13. FUNCTION (AM/FM ST./POWER OFF/CD) Switch (Side of Unit) |
| 3. SKIP/Search ◀◀/ ▶▶ Buttons | 14. POWER Indicator |
| 4. FM STEREO Indicator | 15. REPEAT Indicator |
| 5. REPEAT Button | 16. PROGRAM Button |
| 6. AM/FM Dial Scale and Pointer | 17. PROGRAM Indicator |
| 7. CD Display | 18. PLAY/PAUSE (▶) Button |
| 8. CD Compartment Door | 19. Battery Compartment (Bottom of Unit) |
| 9. PLAY/PAUSE Indicator | 20. STOP (■) Button |
| 10. CD OPEN/CLOSE Area | |
| 11. FM Rod Antenna | |

OPERATING INSTRUCTIONS

LISTENING TO THE RADIO

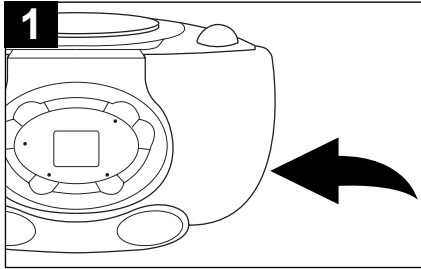

Slide the **FUNCTION** switch to the AM or FM ST position; the **POWER** indicator will light.

NOTE: If you select the FM band, be sure to raise the FM rod antenna and extend it to its full length.

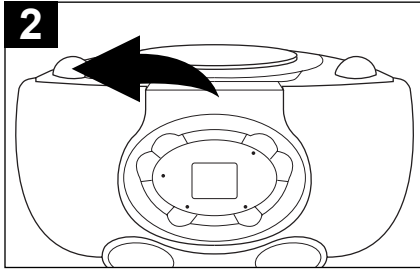

Set the **VOLUME** control to a low setting.

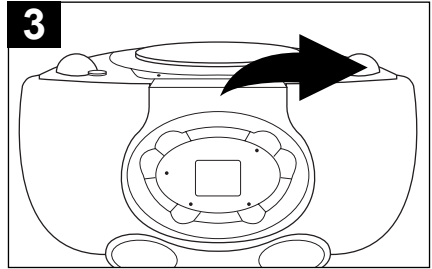

Rotate the **TUNING** control to select a station. The **FM STEREO** indicator will light when a strong FM station is received.

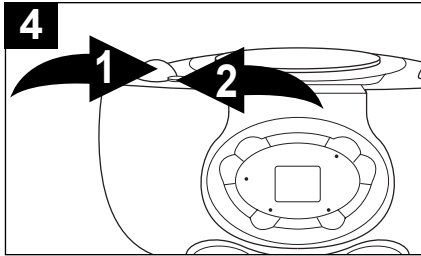

Adjust the **VOLUME** ① and **BASS BOOST** ② as desired.

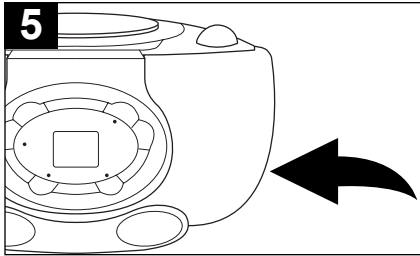

When you have finished listening, slide the **FUNCTION** switch to the **POWER OFF** position.

HINTS FOR BETTER RECEPTION:

FM - Make sure that the telescopic FM rod antenna is raised and extended to its full length. You may have to vary the direction of the antenna to find the strongest signal for each FM station.

AM - The AM ferrite bar antenna is located inside the cabinet. It may be necessary to turn the unit slightly so that the internal antenna is pointing in the direction of the AM transmitter. You may have to experiment to find the position that provides the strongest reception for each of your favorite AM stations.

BASS BOOST:

Press this button to the On (in) position to enhance the overall bass sound. Press to the Off (out) position for normal listening.

OPERATING INSTRUCTIONS (CONTINUED)

PLAYING COMPACT DISCS NORMAL PLAYBACK

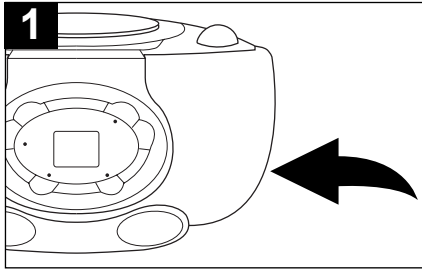

Slide the **FUNCTION** switch to the CD position; the **POWER** indicator will light.

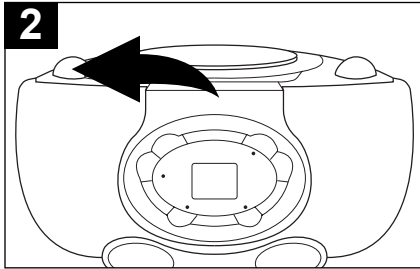

Set the **VOLUME** control to a low setting.

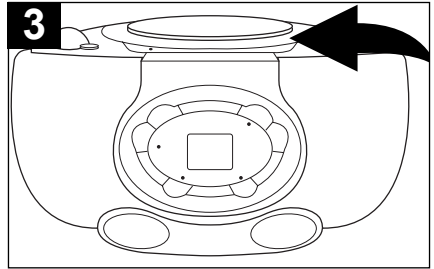

Press the **CD Door OPEN/CLOSE** area to open the **CD Compartment Door**.

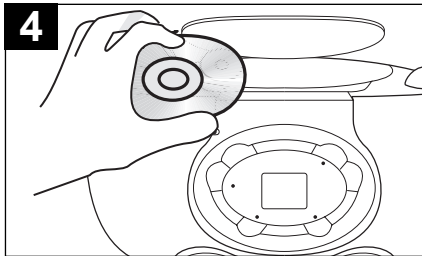

Place a **CD** on the center spindle, with the printed label side facing up. Close the **CD Compartment Door**.

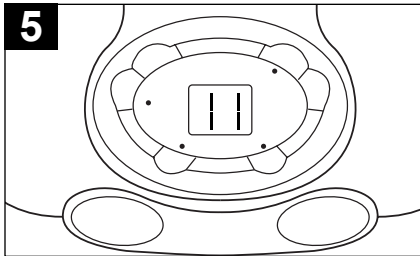

The **CD player** will read the table of contents on the disc and the total number of tracks will appear on the **CD Display**.

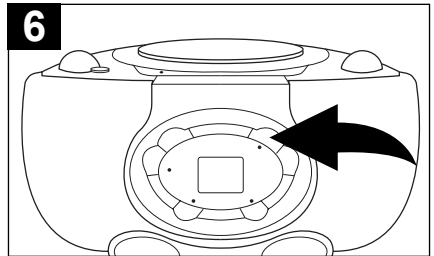

Press the **PLAY/PAUSE** (▶||) button to begin playback on track 1; the **PLAY/PAUSE** indicator will light.

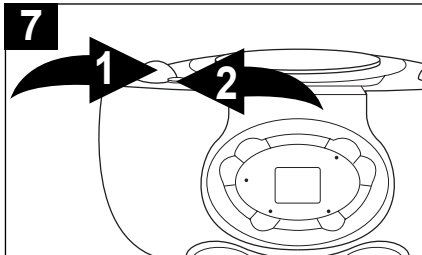

Adjust the **VOLUME** ❶ and **BASS BOOST** ❷ as desired. Playback will continue until all the tracks on the disc have been played.

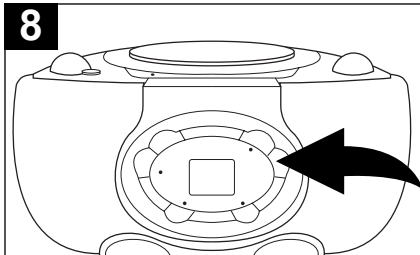

After the last track has been played, the disc stops automatically and the display shows the total number of tracks on the disc. To stop playback before the disc ends, press the **STOP** (■) button.

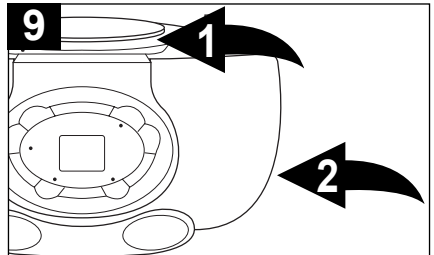

If you are finished listening, press the **CD Door OPEN/CLOSE** area ❶ to open the **CD Compartment Door**. Remove your disc, close the **CD Compartment Door** and slide the **FUNCTION** switch ❷ to the **POWER OFF** position to turn the unit off.

NOTES:

- This unit is capable of playing standard CDs or 3" singles; no adapter is required.
- If a disc is inserted incorrectly, dirty, damaged or not present at all, it will not be recognized.
- To prevent damage to the disc, never open the CD door while the disc is rotating. Wait for the disc to stop before opening the CD door. Never touch the lens when the CD Compartment Door is open.

OPERATING INSTRUCTIONS (CONTINUED)

CD PAUSE CONTROL

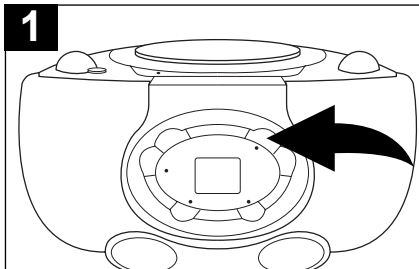

1 During CD playback, if you wish to pause the disc momentarily, press the PLAY/PAUSE (▶||) button again. Playback stops but the disc continues to spin and the PLAY/PAUSE indicator will blink.

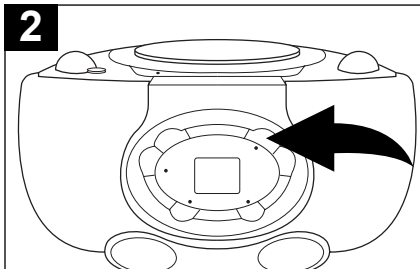

2 Press the PLAY/PAUSE (▶||) button again to release Pause and resume normal CD playback. The sound returns and the PLAY/PAUSE indicator will light solid.

TO BEGIN PLAYBACK FROM A SPECIFIC TRACK

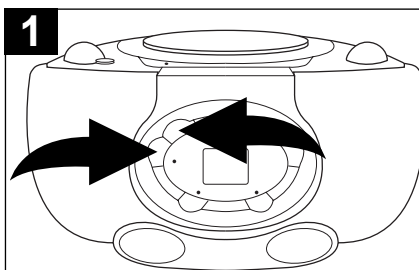

1 After you insert the disc into the CD player and the total number of tracks appear on the display, you may press either the SKIP/Search ▶▶ or ◀◀ button to select a specific track for playback.

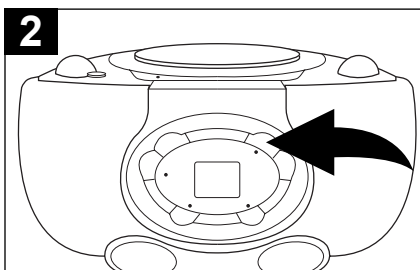

2 When the desired track number appears in the display, press the PLAY/PAUSE (▶||) button. Playback will begin on the track you selected.

FORWARD/REVERSE SKIP TRACK AND HIGH-SPEED MUSIC SEARCH (▶▶/◀◀)

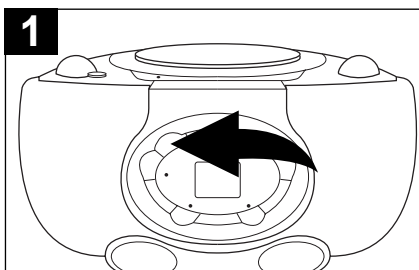

1 During playback, press the SKIP/Search ▶▶ button once to advance the CD to the beginning of the next track. Press the SKIP/Search ▶▶ button repeatedly to advance the CD to higher numbered tracks.

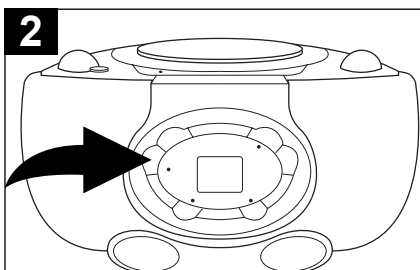

2 During playback, press the SKIP/Search ◀◀ button once to move the CD back to the beginning of the current track. Press the SKIP/Search ◀◀ button repeatedly to move the CD back to lower numbered tracks.

3 During playback, depress and hold either the SKIP/Search ▶▶ or ◀◀ button to move the CD forward or backward within a track to locate a specific musical passage. The CD will move forward or backward at high speed as long as the buttons are depressed. When you release the SKIP/Search ▶▶ or ◀◀ button, normal playback will resume at that point.

OPERATING INSTRUCTIONS (CONTINUED)

REPEAT PLAYBACK

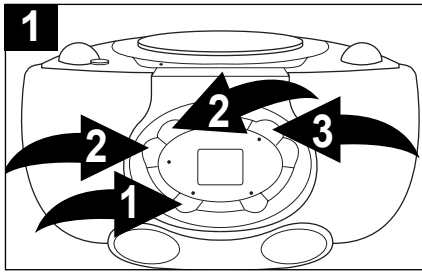

To repeat a single track, press the REPEAT button **1** once; the REPEAT indicator will blink. Press the SKIP/Search **▶▶** or **◀◀** button **2** to select the specific track that you wish to repeat. When the desired track number appears in the display, press the PLAY/PAUSE (**▶||**) button **3** to begin playback. The specific track you selected will be repeated continuously.

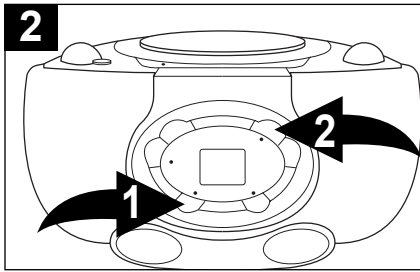

To repeat all of the tracks on a disc continuously, press the REPEAT button **1** twice; the REPEAT indicator will light solid. Press the PLAY/PAUSE (**▶||**) button **2** to begin repeat playback of all tracks.

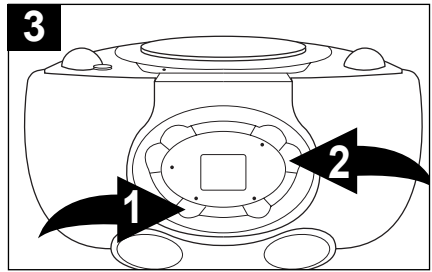

To cancel Repeat Playback, press the REPEAT button **1** until the REPEAT indicator goes out. You can also cancel Repeat Playback by pressing the STOP (**■**) button **2**.

PROGRAMMED PLAYBACK

The CD player in this unit has a 32 track programmable memory that allows you to program up to 32 tracks on any disc for playback in any desired order. You may program 32 different tracks or you may also program certain tracks to play more than once.

To perform programmed playback, proceed as follows:

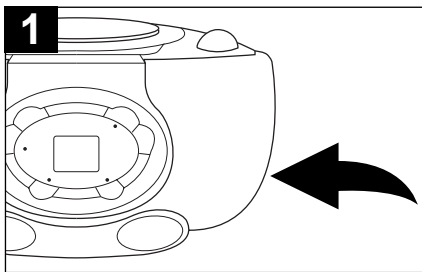

Slide the FUNCTION switch to the CD position; the POWER indicator will light.

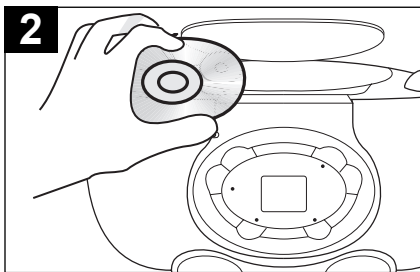

Open the CD Compartment Door and insert your disc in the CD player. Close the CD Compartment Door. Wait for the CD player to read the table of contents and display the total number of tracks on the disc.

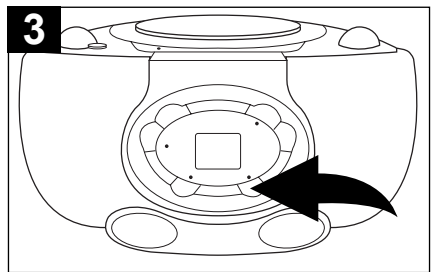

Press the PROGRAM button. "1" will appear and the PROGRAM indicator will blink.

PROGRAMMED PLAYBACK SECTION CONTINUED ON NEXT PAGE.

OPERATING INSTRUCTIONS (CONTINUED)

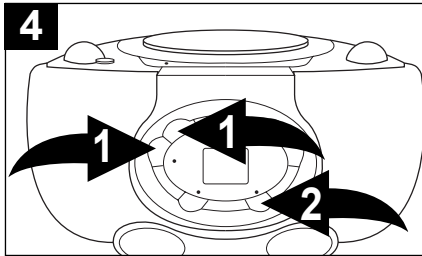

Press the SKIP/Search ►► or ◄◄ button ❶ to select the first track that you wish to program. Example: Track 5. When the desired track number (Track 5) appears in the display, press the PROGRAM button ❷ again, the next program number will then appear in the display.

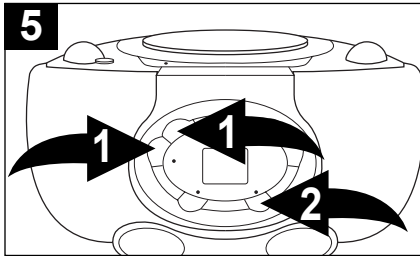

Press either the SKIP/Search ►► or ◄◄ button ❶ to select the next track you wish to program (Example: Track 8). When Track 8 appears in the display, press the PROGRAM button ❷ again.

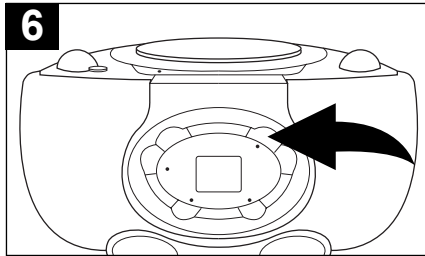

Repeat step 5 until you have programmed up to 32 track numbers into the CD Program Memory. After programming up to 32 tracks in the CD Program Memory, press the PLAY/PAUSE (►||) button ❶ to begin programmed playback. The PROGRAM indicator will light solid and playback will begin on the first track that you programmed.

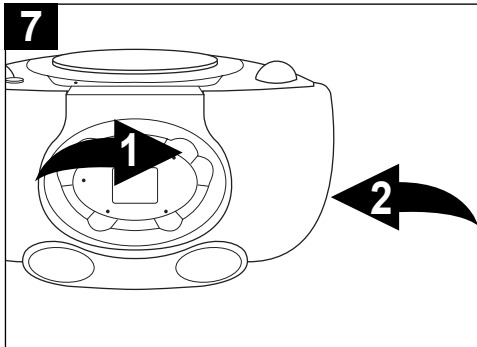

The player will continue to play all of the tracks that you programmed in the order in which you programmed them. When the last programmed track has been played, the player will stop and the display will again show the total number of tracks on the disc. If you wish to play the same programmed tracks again, press the PLAY/PAUSE (►||) button ❶, playback will start on the first track you programmed and will continue until all the programmed tracks have been played.

To cancel the Programmed Playback Memory, open the CD compartment, or change the position of the FUNCTION switch ❷.

PROGRAMMED REPEAT

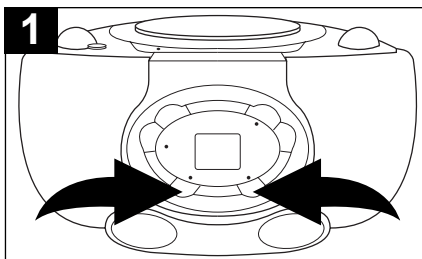

It is also possible to use the Program and Repeat functions together to repeat a specific program indefinitely. First, program the tracks you wish to hear in the order you wish to hear them, as described above. Then, press the REPEAT button twice. Both the PROGRAM and REPEAT indicators will light.

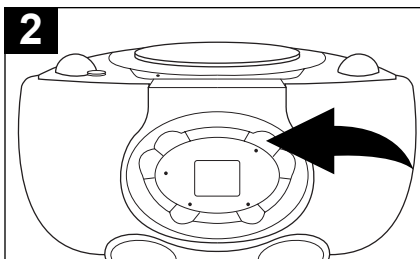

Press the PLAY/PAUSE (►||) button to begin programmed repeat playback. The player will play the tracks you selected in the order in which you programmed them. When the last track in the program has been played, the entire program will begin again.

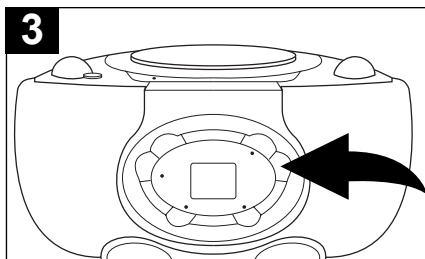

Program Repeat operation will continue indefinitely until you press the STOP (■) button.

CARE AND MAINTENANCE

Caring for Compact Discs

- Treat the disc carefully. Handle the disc only by its edges. Never allow your fingers to come in contact with the shiny, unprinted side of the disc.
- Do not attach adhesive tape, stickers, etc. to the disc label.
- Clean the disc periodically with a soft, lint-free, dry cloth. Never use detergents or abrasive cleaners to clean the disc. If necessary, use a CD cleaning kit.
- If a disc skips or gets stuck on a section of the disc, it is probably dirty or damaged (scratched).
- When cleaning the disc, wipe in straight lines from the center of the disc to the outer edge of the disc. Never wipe in circular motions.

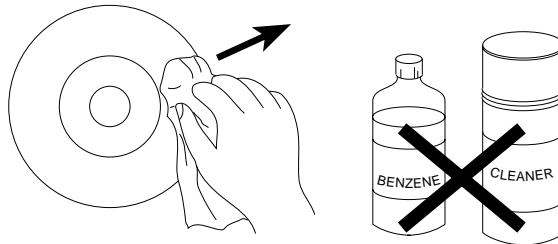
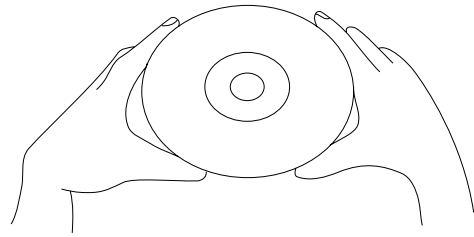

- This unit is designed to play only compact discs bearing the identification logo as shown here.
- Other discs may not conform to the CD standard and may not play properly.
- Compact Discs should be stored in their cases after each use to avoid damage.
- Do not expose compact discs to direct sunlight, high humidity, high temperatures, or dust, etc. Prolonged exposure or extreme temperatures can warp the disc.
- Do not stick or write anything on either side of the disc. Sharp writing instruments, or the ink may damage the surface.



Cleaning the Unit

- To prevent fire or shock hazard, disconnect your unit from the AC power source when cleaning.
- The finish on your unit may be cleaned with a dust cloth and cared for as other furniture. Use caution when cleaning and wiping the plastic parts.
- Mild soap and a damp cloth may be used on the front panel.



TO FIND THE LOCATION AND
PHONE NUMBER OF YOUR
NEAREST AUTHORIZED
SERVICE CENTER...

CALL TOLL FREE: 1-800-695-0098

FOR ADDITIONAL SET-UP OR OPERATING ASSISTANCE
PLEASE CALL:
1-800-898-9020

FOR CUSTOMER SERVICE, PLEASE WRITE TO:
Emerson Radio Corp.
Consumer Affairs Dept.
1901 Diplomat Drive
Farmers Branch, TX 75234

TROUBLESHOOTING GUIDE

Should this unit exhibit a problem, check the following before seeking service:

Symptom	Possible Cause	Solution
Radio		
Noise or sound distorted on radio broadcasts.	Station not tuned properly for AM or FM.	Retune the AM or FM broadcast station.
	FM: Telescopic antenna is not properly adjusted.	Reorient FM telescopic antenna.
	AM: Unit is not positioned correctly.	Rotate unit until best reception is obtained.
STEREO indicator does not light.	Station is not broadcasting in stereo.	Change stations.
AM or FM, no sound.	AM or FM ST. is not selected.	Slide the FUNCTION switch to the AM or FM ST. position.
	Volume at minimum.	Increase volume.
Compact Disc Player		
CD Player will not play.	CD is not selected.	Slide the FUNCTION switch to the CD position.
	CD is not installed or installed upside-down.	Insert CD with label side up.
CD skips while playing.	Disc is dirty or scratched.	Wipe disc with cloth or use another disc.
General		
No sound.	AC cord not connected properly.	Connect AC cord securely.
	Batteries are weak, dead or not inserted properly.	Replace batteries and/or insert properly.

LIMITED WARRANTY

Emerson Radio Corp. warrants manufacturing defects in original material, including original parts and workmanship, under normal use and conditions, for a period of ninety (90) days from the date of original purchase in the U.S. With your dated proof of purchase, we will provide repair service at no charge for labor and parts at an authorized Depot Repair Facility, or replace the product in our discretion. For repair or replacement, pack your unit in a padded box, enclose your check or money order payable to Emerson Radio Corp. in the amount of \$9.00 (not required by California residents) to cover shipping and handling costs, and enclose a copy of your proof of purchase. Send your unit to:

Emerson Radio Corp.
1901 Diplomat Drive
Farmers Branch TX 75234

This warranty does not cover damage from negligence, misuse, abuse, accident, failure to follow operating instructions, commercial use, rental, repairs by an unauthorized facility, or products purchased, used, serviced or damaged outside of the United States.

THIS WARRANTY GIVES YOU SPECIFIC LEGAL RIGHTS, AND YOU MAY ALSO HAVE OTHER RIGHTS WHICH VARY FROM STATE TO STATE.

AU898M

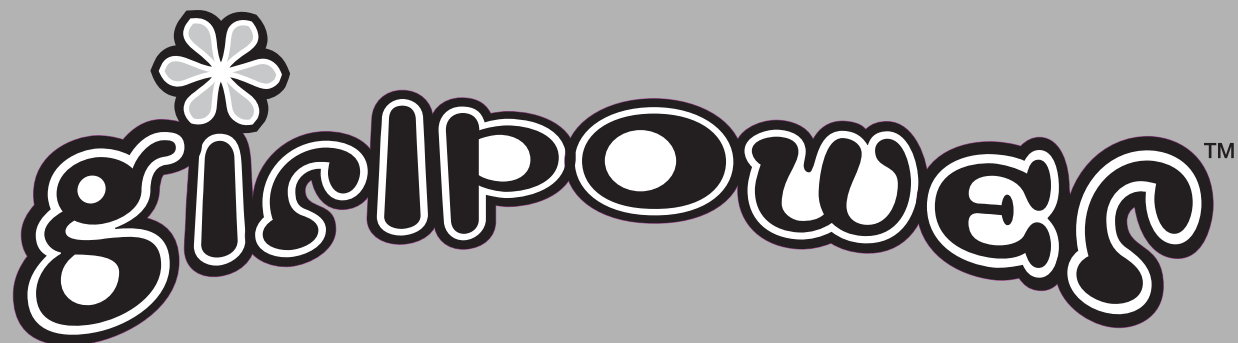

***PORTABLE CD PLAYER WITH
AM/FM RADIO***

OWNER'S MANUAL
GP208

Visit our web site at www.emersonradio.com

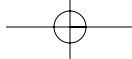

girlPOWER™

BY

 **Emerson®**

EMERSON
PART NO.: 21-2040
208-01

Printed in China

