



Emerson®

700W MICROWAVE OVEN

OWNER'S MANUAL

MW8871W/B

Visit our web site at www.emersonradio.com

PRECAUTIONS TO AVOID POSSIBLE EXPOSURE TO EXCESSIVE MICROWAVE ENERGY

- (a) Do not attempt to operate this oven with the door open since open-door operation can result in harmful exposure to microwave energy.
It is important not to defeat or tamper with the safety interlocks.
- (b) Do not place any object between the oven front face and the door or allow soil or cleaner residue to accumulate on sealing surfaces.
- (c) Do not operate the oven if it is damaged.
It is particularly important that the oven door closes properly and that there is no damage to the following: (1) door (bent), (2) hinges and latches (broken or loosened), (3) door seals and sealing surfaces.
- (d) The oven should not be adjusted or repaired by anyone except properly qualified service personnel.

CONTENTS

Precautions to Avoid Possible Exposure to Excessive Microwave Energy.....	1	To Stop the Oven While it is Operating.....	15
Important Safety Instructions.....	2	Cooking Guide.....	16
Safety Precautions.....	3	The Principles of Microwave Cooking	16
Grounding Instructions	5	Food Characteristics	16
Installation	5	Microwave Techniques.....	16
Care of Your Microwave Oven	6	Hot Snacks and Appetizers	17
How to Use Your Microwave Oven Safely	6	Meats.....	18
Location of Controls	7	Poultry	19
Operation.....	8	Seafood	19
Setting the Clock	8	Eggs & Cheese	20
Defrost By Weight	8	Vegetables and Soup	21
Speed Defrost	9	Sauces	22
Cooking In One Stage	9	Casseroles	22
2 Stage or 3 Stage Time Cooking	9	Sandwiches	23
Cook By Weight.....	10	Pasta and Grains.....	23
Baked Potato Quick Cook Pad.....	11	Cereals	24
Pizza Quick Cook Pad.....	11	Convenience Foods	24
Popcorn Quick Cook Pad	12	Desserts	25
Setting Popcorn Quick Pad to a Different Time	12	Weight & Measure Conversion Chart.....	25
Beverage Quick Cook Pad	13	Specifications	26
Frozen Dinner Quick Cook Pad.....	13	Before You Call for Service	26
Reheat Quick Cook Pad	14	Limited Warranty	27
Child Lock.....	14		
Setting the Timer	15		

IMPORTANT SAFETY INSTRUCTIONS

When using electrical appliances, basic safety precautions should be followed, including the following:

WARNING - To reduce the risk of burns, electric shock, fire, and injury to persons or exposure to excessive microwave energy:

- 1 Read all instructions before using this appliance.
- 2 Read and follow the specific **"PRECAUTIONS TO AVOID POSSIBLE EXPOSURE TO EXCESSIVE MICROWAVE ENERGY"** found on page 1.
- 3 This appliance must be grounded. Connect only to a properly grounded outlet. See **"GROUNDING INSTRUCTIONS"** found on page 5.
- 4 Install or locate this appliance only in accordance with the provided installation instructions.
- 5 Some products such as whole eggs and sealed containers, for example, closed glass jars, may explode and should not be heated in this oven.
- 6 Use this appliance only for its intended use as described in this manual. Do not use corrosive chemicals or vapors in this appliance. This type of oven is specifically designed to heat, cook, or dry food. It is not designed for industrial or laboratory use.
- 7 As with any appliance, close supervision is necessary when used by children.
- 8 Do not operate this appliance if it has a damaged cord or plug, if it is not working properly, or if it has been damaged or dropped.
- 9 This appliance should be serviced only by qualified service personnel. Contact the nearest authorized service facility for examination, repair or adjustment.
- 10 Do not cover or block any openings on this appliance.
- 11 Do not store or use this appliance outdoors. Do not use this product near water, for example, near a kitchen sink, in a wet basement, or near a swimming pool, and the like.
- 12 Do not immerse cord or plug in water.
- 13 Keep cord away from heated surfaces.
- 14 Do not let cord hang over edge of table or counter.
- 15 When cleaning surfaces of door and oven that come together when closing the door, use only mild, non-abrasive soaps or detergents applied with a sponge or soft cloth.
- 16 To reduce the risk of fire in the oven cavity:
 - (a) Do not overcook food. Carefully attend appliance if paper, plastic, or other combustible materials are placed inside the oven to facilitate cooking.
 - (b) Remove wire twist-ties from paper or plastic bags before placing bag in oven.
 - (c) If materials inside the oven should ignite, keep oven door closed, turn oven off, and disconnect the power cord, or shut off power at the fuse or circuit breaker panel.
 - (d) Do not use the cavity for storage purposes. Do not leave paper products, cooking utensils, or food in the cavity when not in use.
- 17 Do not use this microwave oven to heat corrosive chemicals (for example, sulfides and chlorides). Vapors from such corrosive chemicals may interact with the contact and springs of the safety interlock switches thereby rendering them inoperable.
- 18 Keep the waveguide cover clean at all times. Wipe the oven interior with a soft damp cloth after each use. If you leave grease or fat anywhere in the cavity it may lead to overheating and fire.
- 19 Never heat oil or fat for deep frying as you cannot control the temperature and doing so may lead to overheating and fire.
- 20 Liquids, such as water, coffee, or tea are able to be overheated beyond the boiling point without appearing to be boiling due to surface tension of the liquid. Visible bubbling or boiling when container is removed from the over is not always present. **THIS COULD RESULT IN VERY HOT LIQUIDS SUDDENLY BOILING OVER WHEN A SPOON OR OTHER UTENSIL IS INSERTED INTO THE LIQUID.** To reduce the risk of injury to persons:
 1. Do not overheat the liquid.
 2. Stir the liquid both before and halfway through heating it.
 3. Do not use straight-sided containers with narrow necks.
 4. After heating, allow the container to stand in the microwave oven for a short time before removing the container.
 5. Use extreme care when inserting a spoon or other utensil into the container.

SAVE THESE INSTRUCTIONS

SAFETY PRECAUTIONS

General Use

- 1 Do NOT attempt to tamper with or make any adjustments or repairs to door, control panel or any other part of the oven. Do NOT remove outer panel from oven. Repairs should only be done by qualified service personnel.
- 2 Do NOT operate the oven empty. The microwave energy will reflect continuously throughout the oven if no food or water is present to absorb energy.
- 3 If a fire occurs in the oven, touch the Start/Stop pad and LEAVE THE DOOR CLOSED. Disconnect the power cord, or shut off power at the fuse or circuit breaker panel.
- 4 Do NOT attempt to dry clothes, newspapers or other materials in the oven. They may catch on fire.
- 5 Do NOT use recycled paper products. Recycled paper towels, napkins and waxed paper can contain metal flecks which may cause arcing or ignite. Paper products containing nylon or nylon filaments should be avoided, as they may ignite.
- 6 Some styrofoam trays (like those that meat is packaged on) have a thin strip of metal embedded on the bottom. When microwaved, the metal can burn the floor of the oven or ignite a paper towel.
- 7 Avoid inserting nails, wire, etc. through any holes in the unit during operation. Never insert a wire, nail or any other metal objects through the holes on the cavity or any other holes or gaps, because such objects may cause electric shock and microwave leakage.

Utensils

- 1 METAL CONTAINERS or dishes with metallic rims should not be used. Arcing may occur.
- 2 METAL TWIST-TIES may not be used in the microwave oven.
- 3 Do NOT use SEALED JARS or NARROW NECK bottles for cooking or reheating. They may shatter.
- 4 Do NOT use CONVENTIONAL THERMO-METERS in the microwave oven. They may cause arcing.

- 5 Remove PLASTIC STORE WRAPS before cooking or defrosting foods in the oven.
- 6 For FURTHER INFORMATION on proper cooking utensils, refer to the COOKING GUIDE on page 16.

Food

- 1 Never use your microwave oven for HOME CANNING. The oven is not designed to permit proper canning. Improperly canned food may spoil and be dangerous to consume.
- 2 COOKING TIMES given in the cooking guide are approximate. Factors that may affect cooking are starting temperature, altitude, volume, size and shape of food and utensils used. As you become familiar with the oven, you will be able to adjust for these factors.
- 3 It is better to UNDERCOOK RATHER THAN OVERCOOK foods. If food is undercooked, it can always be returned to the oven for further cooking. If food is overcooked, nothing can be done. Always start with minimum cooking times.
- 4 SMALL QUANTITIES of food or foods with LOW MOISTURE content can burn, dry out or catch on fire if cooked too long.
- 5 Do NOT boil eggs in their shell. Pressure may build up and the eggs may explode.
- 6 Potatoes, apples, egg yolks, whole acorn squash and sausage are some examples of food with NONPOROUS SKINS. These must be pierced before cooking to prevent bursting.
- 7 POPCORN must be popped in a microwave corn popper. Microwave popped corn produces a lower yield than conventional popping. Do not use oven for popcorn unless popped in a microwave approved popcorn utensil or unless it's commercially packaged and recommended especially for microwave ovens. Do not use oil unless specified by the manufacturer.
- 8 Do NOT attempt to deep fat fry in your oven.
- 9 HEATED LIQUIDS can ERUPT if not mixed with air. Do not heat liquids in your microwave oven without first stirring.

SAFETY PRECAUTIONS

FEDERAL COMMUNICATIONS COMMISSION RADIO FREQUENCY INTERFERENCE STATEMENT

WARNING:

This equipment generates and uses ISM frequency energy and if not installed and used properly, that is in strict accordance with the manufacturer's instructions, may cause interference to radio and television reception.

It has been type-tested and found to comply with limits for an ISM Equipment pursuant to part 18 of FCC Rules, which are designed to provide reasonable protection against such interference in a residential installation.

However, there is no guarantee that interference will not occur in a particular installation. If this equipment does cause interference to radio or television reception, which can be determined by turning the equipment off and on, the user is encouraged to try to correct the interference by one or more of the following.

- Reorient the receiving antenna of radio or television.
- Relocate the Microwave oven with respect to the receiver.
- Move the microwave oven away from the receiver.
- Plug the microwave oven into a different outlet so that microwave oven and receiver are on different branch circuits.

THE MANUFACTURER is not responsible for any radio or TV interference caused by UNAUTHORIZED MODIFICATION to this microwave oven. It is the responsibility of the user to correct such interference.

ARCING

If you see arcing, press **START/STOP** button and correct the problem.

Arcing is the microwave term for sparks in the oven.

Arcing is caused by:

- Metal or foil touching the side of the oven.
- Foil not molded to food (upturned edges act like antennas).
- Metal, such as twist-ties, poultry pins, or gold rimmed dishes, in the microwave.
- Recycled paper towels containing small metal pieces being used in the microwave.

DO NOT LEAVE OVEN UNATTENDED WHILE COOKING!

SAVE THESE INSTRUCTIONS

GROUNDING INSTRUCTIONS

This appliance must be grounded. In the event of an electrical short circuit, grounding reduces the risk of electric shock by providing an escape wire for the electric current. This appliance is equipped with a cord having a grounding wire with a grounding plug. The plug must be inserted into an outlet that is properly installed and grounded.

WARNING:

Improper use of the grounding plug can result in a risk of electric shock. Consult a qualified electrician or service person if the grounding instructions are not completely understood, or if doubt exists as to whether the appliance is properly grounded.

If it is necessary to use an extension cord, use only a three wire extension cord that has a three blade grounding plug, and a three slot receptacle that will accept the plug on the appliance. The marked rating of the extension cord should be equal to or greater than the electrical rating of the appliance.

INSTALLATION

- 1. Steady, flat location:** When positioning the microwave oven, it should be set on a steady, flat surface.
- 2. Ventilation:** Do not block air vents. If they are blocked during operation, the oven may overheat and eventually cause oven failure. For proper ventilation, keep three inches of space between the oven's top, sides, rear and the area where the unit is to be installed.
- 3. Radio and TV reception:** Poor television reception and radio interference may result if the oven is located close to a TV, radio, antenna, or antenna wire. Position the oven as far from them as possible.
- 4. Temperature and moisture:** Keep the oven away from hot air, steam or splashing liquids when choosing a place to locate it, otherwise, the unit's operation may be adversely affected, causing it to break down.
- 5. Power supply:**
 - Check your local power source. This microwave oven requires a 120V, 60Hz power supply.
 - Use a receptacle that will accept the ground prong.
 - A. A short power supply cord is provided to reduce the risks resulting from becoming entangled in or tripping over a longer cord.
 - B. Longer cord sets or extension cords are available and may be used if care is exercised in their use.
 - C. If a long cord or extension cord is used, (1) the marked electrical rating of the cord set or extension cord should be at least as great as the electrical rating of the appliance, (2) the extension cord must be a grounding-type 3-wire cord, and (3) the longer cord should be arranged so that it will not drape over the counter top or tabletop where it can be pulled on by children or tripped over unintentionally.
- 6. Examine the oven for any damage such as:** Dents, a misaligned door, broken door or a dent in the cavity. If any of the above are visible, DO NOT INSTALL THE UNIT. Notify the dealer immediately.

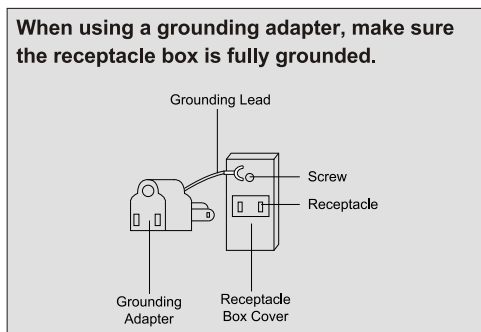
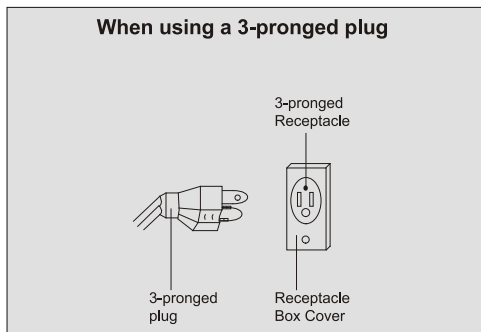

CARE OF YOUR MICROWAVE OVEN

- 1 Disconnect the AC plug from the outlet before cleaning.
- 2 Keep the inside of the oven clean. When food spatters or spilled liquids adhere to oven walls, wipe with a damp cloth. Mild detergent may be used if the oven gets very dirty. The use of harsh detergent or abrasives is not recommended.
- 3 The outside oven surface should be cleaned with soap and water, rinsed and dried with a soft cloth. To prevent damage to the operating parts inside the oven, water should not be allowed to seep into the ventilation slots.
- 4 If the Control Panel becomes dirty or wet, clean with a soft, dry cloth. Do not use harsh detergents or abrasive on Control Panel.
- 5 If steam accumulates on both sides of the oven door, wipe with a soft cloth. This may occur when the microwave oven is operated under high humidity conditions and this is not an indication of a malfunction in the unit.

- 6 It is occasionally necessary to remove the glass tray for cleaning. Wash the tray in warm, sudsy water or in a dishwasher.

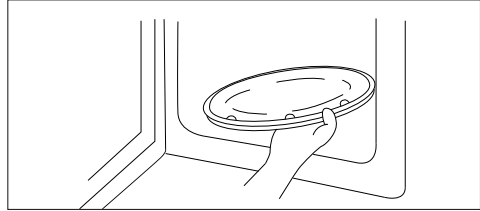

- 7 The roller guide and oven cavity floor should be cleaned regularly to avoid excessive noise. Simply wipe the bottom surface of the oven with mild detergent water or window cleaner and dry. The roller guide may be washed in mild, sudsy water or the dishwasher.

TURNTABLE ROLLER

- 1 The TURNTABLE ROLLER and oven floor should be cleaned frequently to prevent excessive noise.
- 2 The TURNTABLE ROLLER MUST ALWAYS be used for cooking together with the Glass Tray.

Glass Tray

- 1 Do NOT operate the oven without the Glass Tray in place.
- 2 Do NOT use any other Glass Tray with this oven.
- 3 If the Glass Tray is hot, ALLOW IT TO COOL before cleaning it or placing it in water.
- 4 Do NOT cook directly on the Glass Tray.

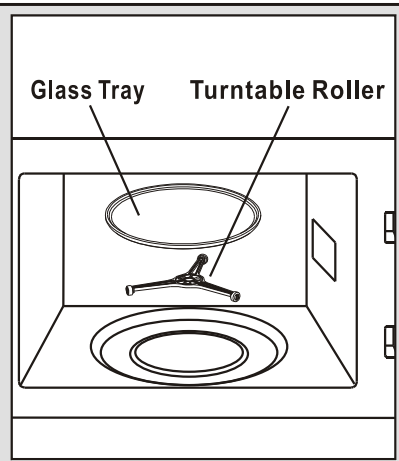

HOW TO USE YOUR MICROWAVE OVEN SAFELY

Although your oven is provided with safety features, it is important to observe the following:

- a) It is important not to defeat or tamper with safety interlocks.
- b) Do not place any object between the oven face and the door or allow residue to accumulate on sealing surfaces. Wipe the sealing area frequently with a mild detergent, rinse and wipe dry. Never use abrasive powders or pads.
- c) When opened, the door must not be subjected to strain, for example, a child hanging on an open door or any load which could cause the oven to fall forward and cause injury and damage to the door. Do not operate the oven if it is damaged, until it has been repaired by a qualified person. It is particularly important that the oven door close properly and that there is no damage to the following:
 - i) Door (bent), ii) Hinges and Latches (broken or loosened), iii) Door seals and sealing surfaces.
- d) The oven should not be adjusted or repaired by anyone except properly qualified service personnel.

LOCATION OF CONTROLS

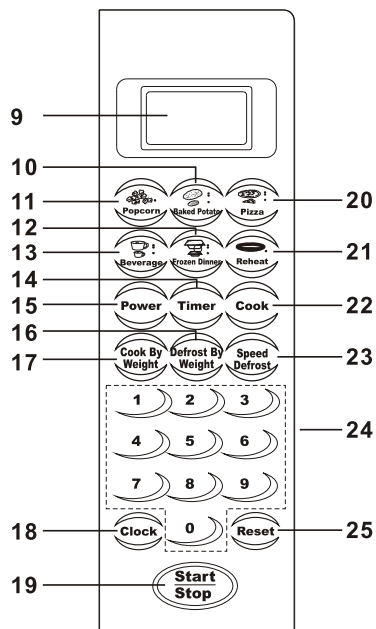
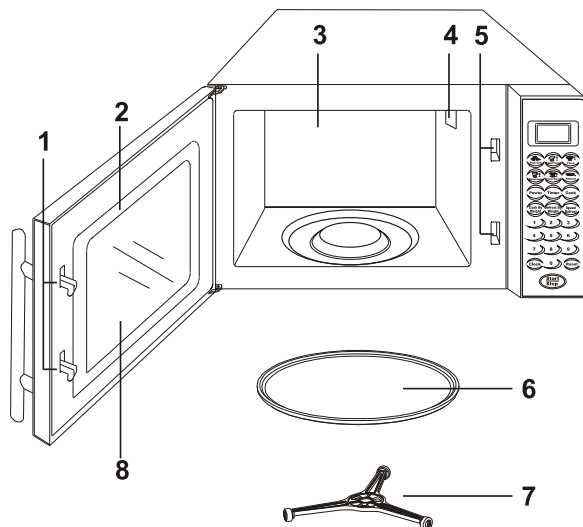

1. Door latch - When the door is closed, it will automatically lock shut. If the door is opened while the oven is operating, the magnetron will automatically shut off.
2. Door seal - The door seal maintains the microwaves within the oven cavity and prevents microwave leakage.
3. Oven cavity
4. Spatter shield - Protects the microwave outlet from splashes of cooking foods.
5. Safety interlock system - Prevents the oven from operating while the door is opened.
6. Glass cooking tray - Made of special heat resistant glass. The tray must always be in proper position before operating the oven. Do not cook food directly on the tray.
7. Turntable roller - Supports the glass cooking tray. Must always be in proper position before operating the oven.
8. Door screen - Allows viewing of food. The screen is designed so that light can pass through, but not the microwaves.
9. Display - Cooking time, power level, function indicators and the present time are displayed.
10. Baked Potato pad - Touch to cook potatoes.
11. Popcorn pad - Touch to cook popcorn.
12. Frozen Dinner pad - Used to cook frozen dinners.
13. Beverage pad - Used to heat beverages.
14. Timer pad - Used to allow the display to operate as a kitchen timer.
15. Power pad - Used to set the desired cooking power level.
16. Defrost By Weight pad - Used to estimate the defrosting time by weight entered.
17. Cook By Weight pad - Used to set the oven to estimate the cooking time by weight entered.
18. Clock pad - Touch to set the present time.
19. Start/Stop pad - Used to start or stop a selected operation.
20. Pizza pad - Touch to reheat precooked or cook frozen pizza.
21. Reheat pad - Used to reheat plated foods.
22. Cook pad - Touch to set any desired cook setting.
23. Speed Defrost pad - Automatically divides the defrosting times into periods of alternating defrost and standing times for even defrosting.
24. 10 key pads - Used to select the desired power level, cooking time, etc.
25. Reset pad - Used to reset the cooking data if pressed before cooking starts.

OPERATION

SETTING THE CLOCK

1. Touch the **CLOCK** pad.

The display will show "ENTER CLOCK TIME".

NOTE: When the unit is first plugged in, it will temporarily be in the clock set mode.

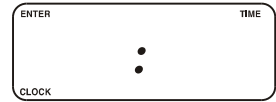
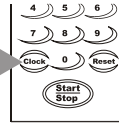

2. Enter the correct time of day.

EXAMPLE: To set the time to "10:02", touch "1", "0", "0", "2" in sequence.

The display will show the numbers pressed in the order in which you pressed them.

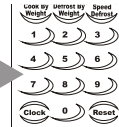

3. Touch the **CLOCK** pad.

The display will show the present time and the colon will stop blinking. After the clock has been set, the time will appear unless the oven is cooking or defrosting.

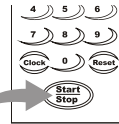

NOTES:

- To reset present time in the display window when the oven is off, touch the **CLOCK** pad and reset.
- A pad must be touched within 15 seconds when setting the clock, or entering cooking information.
- If you make a mistake when setting the time, touch the **RESET** pad.
- To recall the actual time while the oven is cooking or defrosting, simply touch the **CLOCK** pad and the display will show the actual time for three seconds.

DEFROST BY WEIGHT

DEFROST BY WEIGHT lets you easily defrost foods by eliminating guesswork in determining defrosting time. The minimum weight for Auto Weight Defrost is 1oz. The maximum weight is 6.0 lbs (entered as 5lbs, 16oz). Follow the steps below for easy defrosting.

IMPORTANT NOTE: The oven beeps during the defrosting cycle to signal that the food needs to be turned or rearranged. when the defrosting time ends, you will hear 4 beeps.

1. Touch the **DEFROST BY WEIGHT** pad.

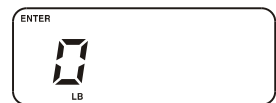
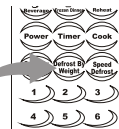

2. Using the keypads, enter the pounds, and then enter the ounces.

For example, for 1 pound 5 ounces, touch "1", "0", "5".
(Maximum weight that can be entered is 5lbs, 16oz.)

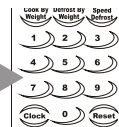

3. Touch the **START/STOP** pad. The display will show "CODE" and "DEF" and count down the remaining defrosting time in minutes and seconds. It will beep four times and show "End" when defrosting is completed (refer to **Important Note** above). Touch the **RESET** pad or open the door to clear before starting another operation.

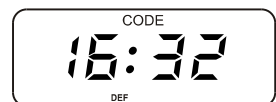
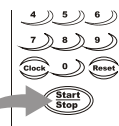

OPERATION (CONTINUED)

SPEED DEFROST

SPEED DEFROST will automatically set the oven to defrost at a time set by the user. This method provides the quickest thawing of small to medium size foods.

1. Touch the **SPEED DEFROST** pad.

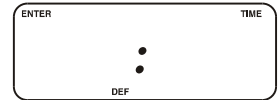
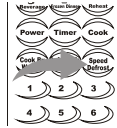

2. Using the key pads, enter the desired defrosting time (up to 99 minutes, 99 seconds).

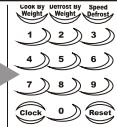

3. Touch the **START/STOP** pad. The display will show "DEF" and count down the remaining defrosting time in minutes and seconds. It will beep four times and show "End" when defrosting is completed. Touch the **RESET** pad or open the door to clear before starting another operation.

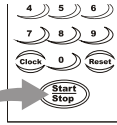

COOKING IN ONE STAGE

Set a cooking or other operational time/power as follows:

1. Using the key pads, enter the desired cooking time (up to 99 minutes, 99 seconds).

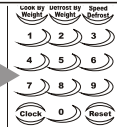

2. Touch the **POWER** pad followed by a key pad to enter the power level (skip if cooking at 100%); see below. The display will show the percentage you chose.

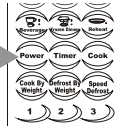

3. Touch the **START/STOP** pad. The display will show "COOK" and count down the remaining cooking time in minutes and seconds. It will beep four times and show "End" when cooking is completed. Touch the **RESET** pad or open the door to clear before starting another operation.

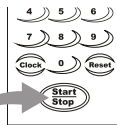

2 STAGE OR 3 STAGE TIME COOKING (WITH SPEED DEFROST)

For two stage cooking, instead of performing step 3, press the **COOK** pad and repeat steps 1 and 2 and then press the **START/STOP** pad; "MEM" will appear in the display.

If desired, after setting two-stage cooking, press the **SPEED DEFROST** pad and enter the desired defrosting time, then press the **START/STOP** pad.

When all stages have completed, four beeps will sound.

WATTAGE OUTPUT CHART

Number Pad	% of Power
9	90
8	80
7	70
6	60
5	50
4	40
3	30
2	20
1	10

OPERATION (CONTINUED)

COOK BY WEIGHT

COOK BY WEIGHT lets you easily roast meats in the oven as it will automatically set the times and power levels to give better results than one power only cooking. Meat must be defrosted and at refrigerated temperature. Meat Roasts approximately three to five pounds work best.

1. Touch the **COOK BY WEIGHT** pad.
The display will show "ENTER CODE".

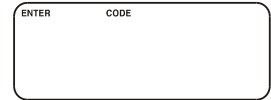
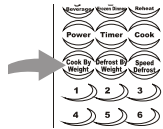

2. Using the key pads, select the desired code that corresponds to the type of food you are cooking according to the chart at the right.

Code	Roast Type	Int. Temp after Standing	Recommended Max Weight
1	Roast Beef	Rare 140°	5lb, 16oz
2	Beef or Lamb	Medium 160°	5lb, 16oz
3	Pork	Well Done 170°	5lb, 4oz

3. Using the key pads, enter the pounds, then enter the ounces. For example, cook roast beef for 1 pound 5 ounces, touch "1" and touch "1", "0", "5". (Maximum ounces that can be entered is 16.) The cooking time will appear.

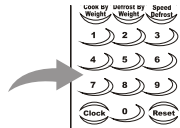

4. Touch the **START/STOP** pad.
The display will show "CODE" and "COOK" and will count down the remaining cooking time in minutes and seconds and will beep four times when cooking is completed. Touch the RESET pad or open the door to clear before starting another operation.

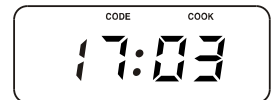
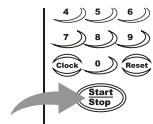

NOTES:

- After partial cooking, the oven will stop cooking and beep two times, but the time will remain on the display. This pause is to allow you to turn and rearrange the food for even cooking. After the food is turned and rearranged, press the **START/STOP** pad again.
- Let the roast stand a few minutes to finish cooking before serving

OPERATION (CONTINUED)

BAKED POTATO QUICK COOK PAD

Use this feature and the oven will automatically set the cooking time based on the quantity of potatoes. A built-in standing time will help equalize the temperature. Cook potatoes as follows:

- For 3.5 to 5 ounce potatoes, touch the **BAKED POTATO** pad once. For a 6 to 8 ounce potato, touch the **BAKED POTATO** pad twice.

The display will show "ENTER AMT".

* Pierce skins before cooking.

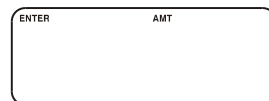
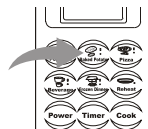

- Enter the amount of four to six ounce potatoes (up to four) and the cooking time will appear. Touch the **START/STOP** pad. The display will show "CODE" and "COOK" and will count down the remaining cooking time in minutes and seconds and will beep four times when cooking is completed.

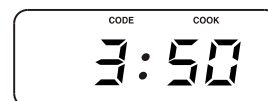
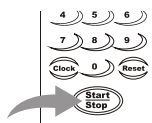

NOTE: Up to four baked potatoes can be cooked as follows:

Qty	3.5 - 5 Oz	6 - 8 Oz
1 Potato	3 minutes,50 seconds	5 minutes, 00 seconds
2 Potatoes	5 minutes,30 seconds	7 minutes, 00 seconds
3 Potatoes	8 minutes,00 seconds	11 minutes,00 seconds
4 Potatoes	10 minutes,00 seconds	14 minutes,00 seconds

PIZZA QUICK COOK PAD

Use this feature and the oven will automatically set the cooking time based on the the type of pizza (reheated or frozen). Cook pizza as follows:

- To reheat a thick slice or two smaller slices, touch the **PIZZA** pad once (total cooking time is 1 minute 40 seconds). For a whole frozen pizza, touch the **PIZZA** pad twice (total cooking time is 2 minutes 30 seconds). The display will show "CODE".

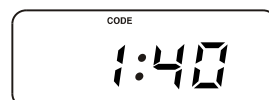
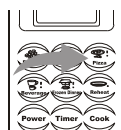

- Touch the **START/STOP** pad. The display will show "CODE" and "COOK" and will count down the remaining cooking time in minutes and seconds and will beep four times when cooking is completed.

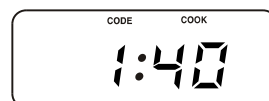
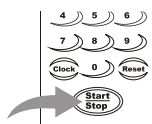

OPERATION (CONTINUED)

POPCORN QUICK COOK PAD

Use this feature and the oven will automatically set the cooking time. Cook popcorn as follows:

1. To cook a standard 3 to 3-1/2 oz bag, touch the **POPCORN** pad (total cooking time is 2 minutes, 50 seconds). The display will show “CODE”.

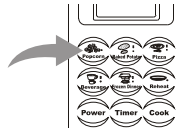

2. Touch the **START/STOP** pad. The display will show “CODE” and “COOK” and will count down the remaining cooking time in minutes and seconds and will beep four times when cooking is completed.

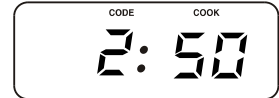
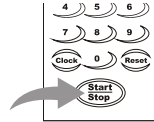

SETTING POPCORN QUICK COOK PAD TO A DIFFERENT TIME

If using a smaller or larger popcorn package, you can automatically set this oven to a different preset popcorn time. If you do change the popcorn time, the oven will continue using the new time each time the **POPCORN** pad is touched. Change the popcorn cooking time as follows:

1. Touch the **POPCORN** pad twice. The display will show “ENTER TIME”.

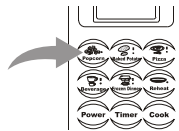

2. Enter a new popcorn time using the Key pads. Touch the **START/STOP** pad to cook the popcorn using the new time.

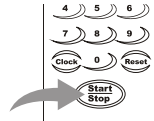

- NOTES:**
1. To avoid discoloration of the glass tray, set the popcorn packages on a microwaveable plate.
 2. Use only a microwaveable popcorn package in the microwave oven.
 3. Do not try to pop unpopped kernels.
 4. Do not leave the oven unattended while popping popcorn. If the popcorn does not pop sufficiently, do not press the **POPCORN** pad again as the popcorn may burn. Check the popcorn bag for cooking instructions.
 5. When opening the package, face it away from you to avoid contact with any steam released.

OPERATION (CONTINUED)

BEVERAGE QUICK COOK PAD

Use this feature and the oven will automatically set the cooking time based on the the size and quantity of the beverage. Cook beverage as follows:

1. To heat 4 to 6 ounce beverage(s), touch the **BEVERAGE** pad once. To heat 7 to 9 ounce beverage(s), touch the **BEVERAGE** pad twice. The display will show "ENTER AMT".

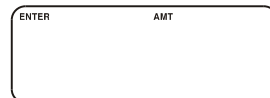
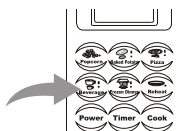

2. Enter the amount of cups (up to four) and the cooking time will appear. Touch the **START/STOP** pad. The display will show "CODE" AND "COOK" and will count down the remaining cooking time in minutes and seconds and will beep four times when cooking is completed.

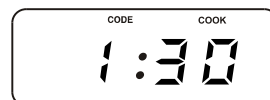
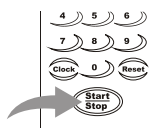

NOTE: Up to four cups can be reheated as follows:

Qty	4-6 Oz	7-9 Oz
1 Cup	1 minute, 30 seconds	2 minutes, 40 seconds
2 Cups	2 minutes, 50 seconds	4 minutes, 50 seconds
3 Cups	4 minutes, 10 seconds	7 minutes, 20 seconds
4 Cups	5 minutes, 30 seconds	9 minutes, 50 seconds

FROZEN DINNER QUICK COOK PAD

Use this feature and the oven will automatically set the cooking time based on the size and quantity of the frozen dinners. A built-in standing time will help equalize the temperature. Cook frozen dinners as follows:

1. To heat 5 to 7 ounce frozen dinner(s), touch the **FROZEN DINNER** pad once. To heat 8 to 10 ounce frozen dinner(s), touch the **FROZEN DINNER** pad twice. The display will show "ENTER AMT".

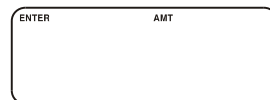
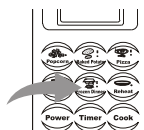

2. Enter the amount of frozen dinners (up to two) and the cooking time will appear. Touch the **START/STOP** pad. The display will show "CODE" and "COOK" and will count down the remaining cooking time in minutes and seconds and will beep four times when cooking is completed.

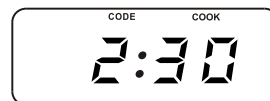
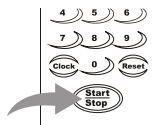

NOTE: Up to two dinners can be reheated as follows:

Qty	5 - 7 Oz	8 - 10 Oz
1 Entree	2 minutes, 30 seconds	3 minutes, 00 seconds
2 Entrees	3 minutes, 30 seconds	4 minutes, 30 seconds