

## Installation

This section describes how to connect the system to a TV monitor with audio/video input jacks. You cannot connect this system to a TV monitor which does not have a video input connector. Be sure to turn off the power of each component before making the connections.

## Unpacking

Check that you have the following items:

- Main unit (1).
- Remote control (1).
- Audio/Video cable (4 feet x 1).
- Owner's Manual (1).

## Protect Your Furniture

This model is equipped with non-skid rubber 'feet' to prevent the product from moving when you operate the controls. These 'feet' are made from non-migrating rubber material specially formulated to avoid leaving any marks or stains on your furniture. However certain types of oil based furniture polishes, wood preservatives, or cleaning sprays may cause the rubber 'feet' to soften, and leave marks or a rubber residue on the furniture. To prevent any damage to your furniture we strongly recommend that you purchase small self-adhesive felt pads, available at hardware stores and home improvement centers everywhere, and apply these pads to the bottom of the rubber 'feet' before you place the product on fine wooden furniture.

## Battery installation (Remote Control)

The remote control requires one "button-type" 3-volt lithium battery, included. To extend the life of the original battery we have inserted a small clear plastic spacer tab between the lithium battery and the battery terminal.

You must remove this battery spacer tab before you can use the remote control.

To remove the tab, pull it in the direction of the arrow in the illustration as shown.

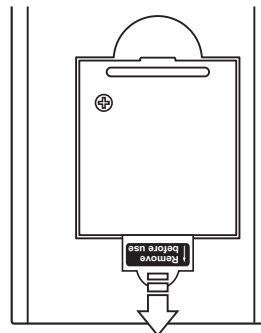

When the operation of the remote control becomes intermittent or unsatisfactory, replace the original battery with a new 3-volt lithium battery.

The battery number is (CR2025) or equivalent.

To replace the battery, remove the screw at the back of the remote control with an appropriate screwdriver and open the battery cover.

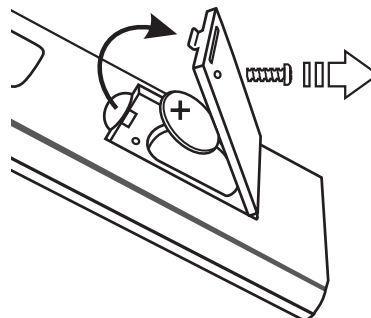

Remove the original battery from the battery compartment and install a new (CR2025) battery with the " + " side facing up as shown in the illustration. Then put the battery cover and screw back to its original place.

**CAUTION: Danger of explosion if battery is incorrectly replaced. Replace only with the same or equivalent type.**

**Dispose of the original battery properly. It should not be thrown into a fire as the battery may explode if incinerated. It should not be left around where small children or pets might play with, or swallow it. If the battery is accidentally swallowed, contact a physician immediately.**

**California Use Only:**

**The Perchlorate warning applies only to primary CR(Manganese Dioxide) Lithium coin cells sold or distributed ONLY in California,USA. "Perchlorate Material-special handling may apply." See**

[www.dtsc.ca.gov/hazardouswaste/perchlorate](http://www.dtsc.ca.gov/hazardouswaste/perchlorate)

## TV and Optional Component Connections

### Required cords

- Video cord for connecting a TV set (included).

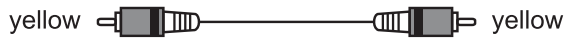

- Audio cords (included).  
When connecting a cord, be sure to match the color-coded pins to the appropriate jacks on the components.

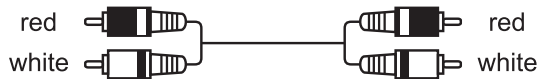

### Notes:

- **TV Connection-Normal (Connection Cable Included):**

To view the video from DVD discs on your TV set connect the Video Out jack of this system to the Video In jack of your TV set. The Video jacks are usually colored yellow. Use the included video cable with yellow plugs on each end.

- **TV Connection-Audio (Connection Cables Included):**

Connect the Left/Right audio output jacks of your system to the Left/Right audio input jacks of the TV set.

- **External Decoder Connection-Not Required:**

The Coaxial Digital Audio output jack allows digital audio signals to be fed to an external Dolby Digital decoder if desired. The Coaxial digital audio connection cable is not included.

## Connecting the AC Power Cord

### Notes:

- The Power Requirement is: AC 120V, 60Hz.
- Connecting to power other than the one listed above may damage the system or cause abnormal operation.
- Before connecting the AC power cord of this system to a wall outlet, connect the speakers and other component cables to the system.
- Connect the AC power cords of your TV and any optional connect to a wall outlet.

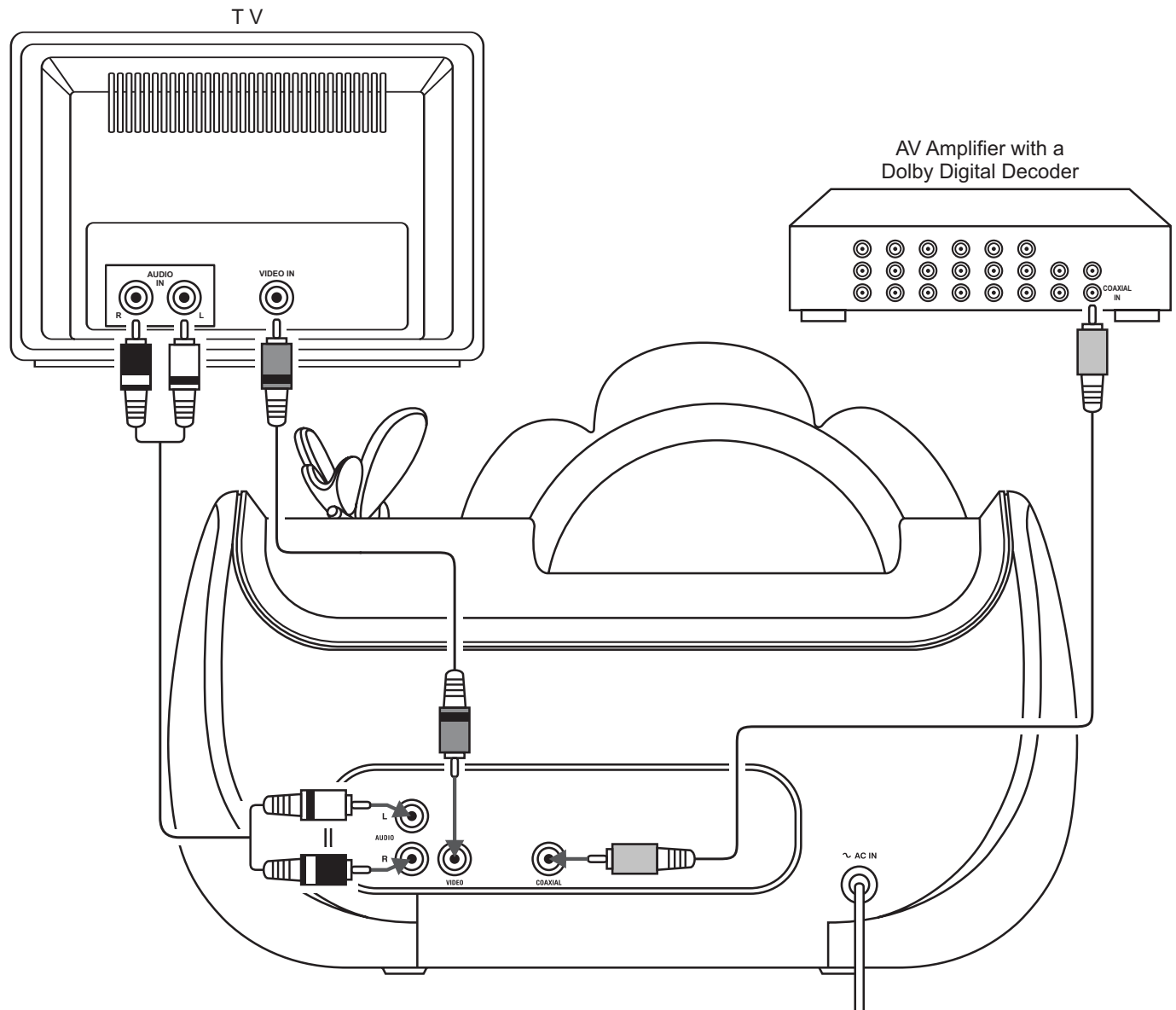

## DVD Playback

### Preparations

- Switch on the TV set power and select "Video" as the TV input.
- Switch on the stereo system's power if the player has been connected to a stereo system.

## Basic Play

1. Pull open the vertical disc compartment.
2. Place a disc into the disc compartment.  
Hold the disc without touching either of its surfaces and with the printed title side facing up. Align it with the guides and place it in its proper position.
3. Push close the vertical disc compartment.
4. Press the **PLAY** ► button if the movie has not started automatically.
  - If the disc has one or more titles recorded on it, a menu screen will appear on the TV screen after a few moments.
5. Select the preferred title by using the (◀, ▶, ▲, ▼) Navigation buttons, followed by the **ENTER** button, or press the number button corresponding to the menu.
  - Play of the selected title now commences.

### When the menu continues onto another screen

After step 3 on previous page, press **SKIP** ►►.

- To return to the previous menu screen, press **SKIP** ◄◄.
- For further details, refer also to the disc jacket.

### Stopping play and returning to the menu screen

Press the **DVD MENU** button.

- Play is suspended and the menu screen is displayed.

### When the unit is not in use

When the unit is not in use, remove the disc and press the Standby ⏻ button to turn off the power. The **STANDBY** indicator will illuminate.

#### Notes:

- The disc continues to rotate while the menu is displayed even after the player has finished playing a particular item. When no further selections are to be played, be sure to press the **STOP** ■ button to clear the menu display.
- If the disc is placed in upside down, the On Screen Display will indicate "NO DISC".

### For your reference

- When "⊘" appears on the TV screen while a button is being operated, it means that the corresponding operation is prohibited by the player.

### Stopping play

- Press the **STOP** ■ button.

### For your convenience

- When play is stopped, the unit records the point when **STOP** ■ was pressed (RESUME function). Press **PLAY** ► again and play will resume from this point. When the tray is opened or **STOP** ■ is pressed again, the RESUME function will be cleared. The RESUME function works only with discs for which the elapsed playing time appears during playback.

### Still picture

Press the **PAUSE/STEP** ⏸ button during play.

### To return to normal play

Press **PLAY** ►.

### Frame advance

- Press the **PAUSE/STEP** ⏸ button to advance to still picture mode.
- Press the **PAUSE/STEP** ⏸ button repeatedly until the desired frame is displayed. The disc is advanced one frame each time the **PAUSE/STEP** ⏸ button is pressed.

## Skipping Chapters or Tracks

### Skipping ahead

Press **SKIP** ►► during play.

- A chapter is skipped each time the button is pressed.

### Skipping back

Press **SKIP** ◄◄ during play.

## Slow-motion Play by Remote Control Only

While a disc is playing, press **PAUSE/STEP** ⏸ followed by **FWD**.. Each time you press **FWD** ►►, the slow motion will get even slower until you reach the slowest speed.

### To return to normal play

- Press **PLAY** ► button.

### Search: rapid advance-rapid reverse

Press the **SEARCH** ◄◄ or ►► button(s). Each time you press the button, the speed change from: x2, x4, x8, x16.

BACKWARD x2 ◄◄ = Fast Reverse 1

BACKWARD x4 ◄◄ = Fast Reverse 2

BACKWARD x8 ◄◄ = Fast Reverse 3

BACKWARD x16 ◄◄ = Fast Reverse 4

FORWARD x2 ►► = Fast Forward 1

FORWARD x4 ►► = Fast Forward 2

FORWARD x8 ►► = Fast Forward 3

FORWARD x16 ►► = Fast Forward 4

### To return to normal play

- Press the **PLAY** ► button.

## Selecting Scenes by Chapter Number

**Example:** Starting play from Chapter 03.

1. Press the **SEARCH** button during play.

TT 01/03 CH 03/06

2. Press the Number button(s) to select the preferred chapter.

**Example:** Press '0', '3'.

TT 01/03 CH 03/06

3. Play now commences from Chapter 03.

**Note:** Depending on the disc used, it may not be possible to perform these operations during DVD menu play.

### For your reference

"⊘ INPUT INVALID" appears on the TV monitor if the number selected does not exist on the disc.

## Selecting a Start Point using the Title Time Code

**Example:** Viewing after 1 hour 3 minutes have elapsed from the title start.

1. Press the **SEARCH** button twice during play.

TT 01/03 T : :

2. Press the Number button(s) to specify the starting position.

**Example:** To specify "1 hour 3 min.00sec.", press '1', '0', '0', '3', '0', and '0'.

TT 01/03 T 1:03:00

3. Play now commences from the specified position.

### Notes:

- This operation works only with discs for which the elapsed playing time appears during playback.
- For some discs, play may not start from the specified position even when the steps above have been performed correctly.
- Depending on the disc used, it may not be possible to perform these operations during DVD menu play.

## Selecting a Start Point using the Chapter Time Code

**Example:** Viewing after 1 hour 3 minutes have elapsed from the chapter start.

1. Press the **SEARCH** button thirdly during play.

CH 01/06 T : :

2. Press the Number button(s) to select the preferred chapter.

**Example:** To specify 1 hour 3 min 00 sec, press '1', '0', '3', '0', '0'.

CH 01/06 T 1:03:00

3. Play now commences from Title 2.

**Note:** Depending on the disc used, it may not be possible to perform these operations during DVD menu play.

### For your reference

"⊘ INPUT INVALID" appears on the TV screen if the number selected does not exist on the disc.

## Repeat Playback (CD)

1. Press the **REPEAT/A-B** button once and "↺ Track" indicator will appear on the TV screen. The selected track will be repeated indefinitely unless the **STOP** ■ button is pressed.
2. Press the **REPEAT/A-B** button twice and "↺ ALL" indicator will appear on the TV screen. The entire disc will be repeated indefinitely unless the **STOP** ■ button is pressed.
3. Press the **REPEAT/A-B** button again to resume normal playback.

## Repeat Playback (DVD)

1. Press the **REPEAT/A-B** button during play as follow:

↺ Chapter

REPEAT x1 = Repeat Chapter

↺ Title

REPEAT x2 = Repeat Title

↺ Off

REPEAT x3 = Repeat Off

**Note:** Repeat play may not work correctly with some DVDs.

## Repeat sections between two specific points (Repeat/A - B)

1. Press the **REPEAT/A-B** button during play at the point where repeat play is to commence (A).



2. Press the **REPEAT/A-B** button again at the point where repeat play is to be concluded (B).



Repeat play of the selection between points A and B starts automatically. The section from point A to point B will play repeatedly.

### To return to normal play

- Press the **REPEAT/A-B** button again.

**Note:** Some subtitles recorded around point A or B may fail to appear.

## CD-R/RW Playback

### Important Information

The DVD player in this system can play normal audio CDs, recordable CDs (CD-Rs), re-writable CD's (CD-RWs). However, because of the non-compatibility of certain ripping/burning software used to record CDs, and the quality of the blank discs used for recording, 100% playability of CD-RW cannot be guaranteed. This is not an indication of any problem with your system.

## Picture CD Operation

1. After loading a picture CD disc into the disc tray, the picture CD menu will appear on the TV screen.

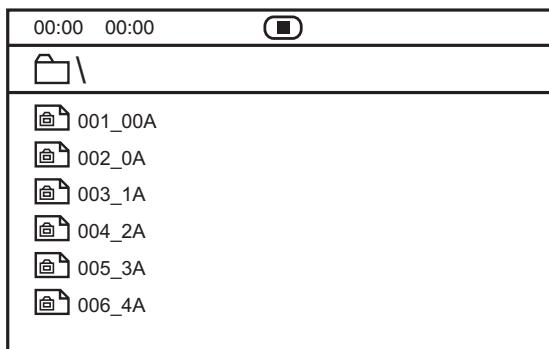

2. Press the (▲, ▼) Navigation buttons to select your desired folder.
3. Press the **ENTER** button to confirm your selection and start the playback of picture CD disc.

## Convenient Functions

### Changing Audio Soundtrack Language

It is possible to change the audio soundtrack language from English to a different language, if available. (This operation works only with discs on which multiple audio soundtrack languages are recorded.)

1. Press the **AUDIO** button during play.
2. Press the **AUDIO** button repeatedly to select the preferred language.

### For your reference

- The choice of languages is limited to those that are available on the disc being played. All discs do not have all languages available.
- When the power is turned on or the disc is removed, the language heard is the one selected initially. If this language is not recorded on the disc, only the language available on the disc will be heard.
- The unit is factory preset to ENGLISH.

### Viewing from another Angle

Some DVD discs may contain scenes which have been shot simultaneously from a number of different angles. For these discs, the same scene can be viewed from each of these different angles using the **ANGLE** button. (The recorded angles differ depending on the disc used.)

1. Press the **ANGLE** button during play.
2. Press the **ANGLE** button to select the preferred angle.

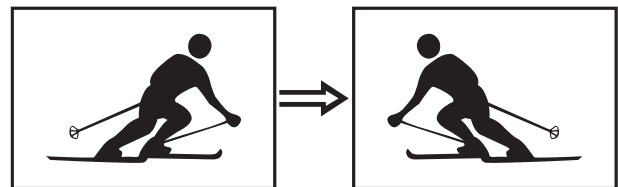

**Note:** This function will only work on discs where different angles have been recorded.

### Clearing & Displaying of Subtitles

If a disc has subtitles recorded on it, they can either be displayed or cleared on the TV screen. (This operation works only with discs on which the subtitle language is recorded.)

- Press the **SUBTITLE** button during play.

## Changing Subtitle Language

It is possible to change the subtitle language from English to a different language, if available. (This operation works only with discs on which multiple subtitle languages are recorded.)

1. Press the **SUBTITLE** button during play.
2. Press the **SUBTITLE** button repeatedly to select the preferred language.

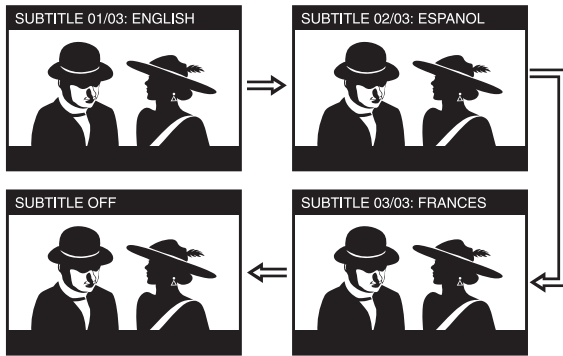

### Notes:

- In some cases, the subtitle language is not changed immediately to the selected one.
- When the power is turned off or the disc is removed, subtitles appear in the language selected at the initial settings. If this language is not recorded on the disc, they will appear in the disc's priority language.

## Selection of Titles

Some DVDs may have more than 1 movie (Title) on them. If the disc has a title menu recorded on it, the **TITLE** button can be used to select the desired title. (The details of operation differ depending on the disc used.)

1. Press the **TITLE** button during play. A list of titles on the disc is now displayed.
2. Press the (◀, ▶, ▲, ▼) Navigation buttons to select the preferred title.
3. Press the **ENTER** button. The selected title now starts playing.

## Using a DVD Menu

Some DVD discs have unique menu structures called DVD menus. For example, DVDs programmed with complex contents provide guide menus and those recorded with various languages provide menus for audio and subtitle language. Although the DVD menu's contents and operation differ from disc to disc, the following explains the basic operation when this feature is used.

1. Press the **DVD MENU** button during play. The DVD menu available on the disc is now displayed.
2. Press the (◀, ▶, ▲, ▼) Navigation buttons to select the preferred menu.
3. Press the **ENTER** button. The selected item is now executed.

### When the menu continues onto another screen

Repeat step 2 and 3.

## Audio CD Playback

### Preparation

- Switch on the TV set power and select "Video" as the TV input.
- Switch on the stereo system's power if the player has been connected to a stereo system.

## Basic Play

1. Pull open the vertical disc compartment.
2. Place a disc into the disc compartment. Hold the disc without touching either of its surfaces and position it with the printed title side facing up. Align it with the guides and place it in its proper position.
3. Push close the vertical disc compartment.
4. Press the **PLAY** ▶ button.

**Note:** Make sure the TV type is set to NTSC (factory default).

## When the unit is not in use

When the unit is not in use, remove the disc and press the Standby ⏻ button to turn off the power. The **STANDBY** indicator will illuminate.

### Notes:

- The disc continues to rotate while the menu is displayed even after the player has finished playing a particular item. When no further selections are to be played, be sure to press the **STOP** ■ button to clear the menu display.
- If the disc is placed in upside down, the On Screen Display will indicate "NO DISC".

### For your reference

- When "⊘" appears while a button is being operated, it means that the corresponding operation is prohibited by the player.

### For your convenience

When play is stopped, the unit records the point where **STOP** ■ was pressed. Press **PLAY** ▶ again, and play will resume from this point. When the tray is opened, the **RESUME** function will be cleared. The **RESUME** function works only with discs for which the elapsed playing time appears during playback.

### Still Picture (PAUSE/STILL)

- Press the **PAUSE/STEP** II button during play.

### Audio CD

- The player will be placed in the pause mode.

### To return to normal play

- Press **PLAY** ▶ button.

## Settings and Adjustments

Once the initial setup has been completed, the player can always be operated under the same conditions. The settings will be retained in the memory, until the settings are changed.

### TV Display

1. Press the **SETUP** button to enter the Setup Menu.
2. Use the (◀, ▶) Navigation buttons to select General.
3. Use the (▲, ▼) Navigation buttons to move the cursor to the TV Display item.
4. Use the (▶) Navigation button followed by the (▲, ▼) Navigation buttons to select between Normal/PS (Pan & Scan), Normal/LB (Letterbox), and Wide formats.

#### Normal/PS (Pan & Scan):

Video material formatted in the PAN & SCAN style is played in that style (the left and right edges are cut off).

#### Normal/LB (Letterbox):

Video material not formatted in the Letterbox style is played in the Pan & Scan style.

#### Wide:

Select this for a wide screen TV set.

5. Press the **ENTER** button.
6. Using the (◀, ▶, ▲, ▼) Navigation buttons and press **ENTER** to exit and save setting.

General	Audio	Dolby	Preference
-- General Setup Page --			
TV Display	PS	Normal/PS	
TV Type	NTSC	Normal/LB	
Angle Mark	ON	Wide	
OSD Lang	ENG		
Captions	ON		
Screen Saver	ON		
Set TV Display Mode			

### TV Type

1. Press the **SETUP** button to enter the Setup Menu.
2. Use the (◀, ▶) Navigation buttons to select General.
3. Use the (▲, ▼) Navigation buttons to move the cursor to the TV Type item.
4. Use the (▶) Navigation button followed by the (▲, ▼) Navigation buttons to select between NTSC, and PAL modes.

5. Press the **ENTER** button.
6. Using the (◀, ▶, ▲, ▼) Navigation buttons and press **ENTER** to exit and save setting.

General	Audio	Dolby	Preference
-- General Setup Page --			
TV Display	PS		
TV Type	NTSC	NTSC	
Angle Mark	ON	PAL	
OSD Lang	ENG		
Captions	ON		
Screen Saver	ON		
Set TV Standard			

### Angle Mark

1. Press the **SETUP** button to enter the Setup Menu.
2. Use the (◀, ▶) Navigation buttons to select General.
3. Use the (▲, ▼) Navigation buttons to move the cursor to the Angle Mark item.
4. Use the (▶) Navigation button followed by the (▲, ▼) Navigation buttons to select between On and Off modes. This only works when there is an angle mark on the disc.

**Note:** Select "On" the screen shows the angle mark when playing a DVD.  
Select "Off" the angle mark is not shown.

5. Press the **ENTER** button.
6. Using the (◀, ▶, ▲, ▼) Navigation buttons and press **ENTER** to exit and save setting.

General	Audio	Dolby	Preference
-- General Setup Page --			
TV Display	PS		
TV Type	NTSC		
Angle Mark	ON	On	
OSD Lang	ENG	Off	
Captions	ON		
Screen Saver	ON		
Set Angle Mark			

## On Screen Display Language

1. Press the **SETUP** button to enter the Setup Menu.
2. Use the (◀, ▶) Navigation buttons to select General.
3. Use the (▲, ▼) Navigation buttons to move the cursor to the OSD Lang item.
4. Use the (▶) Navigation button followed by the (▲, ▼) Navigation buttons to select between English, German, Spanish and French on screen display languages.
5. Press the **ENTER** button.
6. Using the (◀, ▶, ▲, ▼) Navigation buttons and press **ENTER** to exit and save setting.

General	Audio	Dolby	Preference
-- General Setup Page --			
TV Display	PS		
TV Type	NTSC		
Angle Mark	ON		
OSD Lang	ENG	English	
Captions	ON	Spanish	
Screen Saver	ON	German	
		French	
Set OSD Language			

## Captions

1. Press the **SETUP** button to enter the Setup Menu.
  2. Use the (◀, ▶) Navigation buttons to select General.
  3. Use the (▲, ▼) Navigation buttons to move the cursor to the Captions item.
  4. Use the (▶) Navigation button followed by the (▲, ▼) Navigation buttons to select between On and Off modes.
    - Select this option when some newer DVD movies include closed captioning for hearing impaired viewers.
- Note:** Select "On" to switch on the captioning feature that describes other sounds being heard together with the dialog.  
Select "Off" the closed captions will not appear.
5. Press the **ENTER** button.
  6. Using the (◀, ▶, ▲, ▼) Navigation buttons and press **ENTER** to exit and save setting.

General	Audio	Dolby	Preference
-- General Setup Page --			
TV Display	PS		
TV Type	NTSC		
Angle Mark	ON		
OSD Lang	ENG		
Captions	ON	On	
Screen Saver	ON	Off	
Closed Caption			

## Screen Saver

1. Press the **SETUP** button to enter the Setup Menu.
  2. Use the (◀, ▶) Navigation buttons to select General.
  3. Use the (▲, ▼) Navigation buttons to move the cursor to the Screen Saver item.
  4. Use the (▶) Navigation button followed by the (▲, ▼) Navigation buttons to select between ON and OFF modes.
- Note:** If you turn the screen saver on, the screen saver image appears when you leave the system in pause or stop mode for more than 1 minute. The screen saver is useful to prevent your display from becoming damaged.
5. Press the **ENTER** button.
  6. Using the (◀, ▶, ▲, ▼) Navigation buttons and press **ENTER** to exit and save setting.

General	Audio	Dolby	Preference
-- General Setup Page --			
TV Display	PS		
TV Type	NTSC		
Angle Mark	ON		
OSD Lang	ENG		
Captions	ON		
Screen Saver	ON	On	
		Off	
Screen Saver			

## Downmix

1. Press the **SETUP** button to enter the Setup Menu.
  2. Use the (◀, ▶) Navigation buttons to select Audio.
  3. Use the (▲, ▼) Navigation buttons to move the cursor to the Downmix item.
  4. Use the (▶) Navigation button followed by the (▲, ▼) Navigation buttons to select between LT/RT, Stereo modes.
- LT/RT:** The front speakers are in theatrical LT/RT downmix mode.
- Stereo:** The front speakers are in Stereo Downmix mode.
5. Press the **ENTER** button.
  6. Using the (◀, ▶, ▲, ▼) Navigation buttons and press **ENTER** to exit and save setting.

General	Audio	Dolby	Preference
-- Speaker Setup Page --			
Downmix		LT/RT	
		Stereo	
Set Downmix Mode			



## Dynamic

1. Press the **SETUP** button to enter the Setup Menu.
  2. Use the (◀, ▶) Navigation buttons to select Dolby.
  3. Use the (▲, ▼) Navigation buttons to move the cursor to the Dynamic item.
  4. Use the (▶) Navigation button followed by the (▲, ▼) Navigation buttons to select between Full and off levels and 3/4 to 1/4 in between..
- Note:** Select your desired Dynamic Range Compression Rate (DRC) to adjust linear compression rate to obtain the different compression results of the signals.
5. Press the **ENTER** button.
  6. Using the (◀, ▶, ▲, ▼) Navigation buttons and press **ENTER** to exit and save setting.

General	Audio	Dolby	Preference
-- Dolby Digital Setup --			
Dynamic			
Dynamic Range Compression			

## Audio

1. Press the **SETUP** button to enter the Setup Menu.
2. Use the (◀, ▶) Navigation buttons to select Preference.
3. Use the (▲, ▼) Navigation buttons to move the cursor to the Audio item.
4. Use the (▶) Navigation button followed by the (▲, ▼) Navigation buttons to select between English, French, Spanish, German, and Japanese audio soundtrack languages\*.
5. Press the **ENTER** button.
6. Using the (◀, ▶, ▲, ▼) Navigation buttons and press **ENTER** to exit and save setting.

General	Audio	Dolby	Preference
-- Preference Page --			
Audio	ENG	English	
Subtitle	ENG	French	
Disc Menu	ENG	Spanish	
		German	
		Japanese	
Preferred Audio Language			

\* Actual available audio languages depend on the disc used.

## Subtitle

1. Press the **SETUP** button to enter the Setup Menu.
2. Use the (◀, ▶) Navigation buttons to select Preference.
3. Use the (▲, ▼) Navigation buttons to move the cursor to the Subtitle item.
4. Use the (▶) Navigation button followed by the (▲, ▼) Navigation buttons to select between English, French, Spanish, German, or Japanese subtitles\*. or turn subtitles Off.
5. Press the **ENTER** button.
6. Using the (◀, ▶, ▲, ▼) Navigation buttons and press **ENTER** to exit and save setting.

General	Audio	Dolby	Preference
-- Preference Page --			
Audio	ENG		
Subtitle	ENG	English	
Disc Menu	ENG	French	
		Spanish	
		German	
		Japanese	
		Off	
Preferred Subtitle Language			

\* Actual available subtitle languages depend on the disc used.

## Disc Menu

1. Press the **SETUP** button to enter the Setup Menu.
2. Use the (◀, ▶) Navigation buttons to select Preference.
3. Use the (▲, ▼) Navigation buttons to move the cursor to the Disc Menu item.
4. Use the (▶) Navigation button followed by the (▲, ▼) Navigation buttons to select between English, French, Spanish, German, and Japanese Menu languages\*.
5. Press the **ENTER** button.
6. Using the (◀, ▶, ▲, ▼) Navigation buttons and press **ENTER** to exit and save setting.

General	Audio	Dolby	Preference
-- Preference Page --			
Audio	ENG		
Subtitle	ENG		
Disc Menu	ENG	English	
		French	
		Spanish	
		German	
		Japanese	
Preferred Menu Language			

\* Actual available menu languages depend on the disc used.

## Other Functions

This chapter describes how to use some functions contained in system.

### ZOOM



1. Press the **ZOOM** button to change the size of the screen between 2x, 3x, 4x, and off zoom.

### Common Procedure

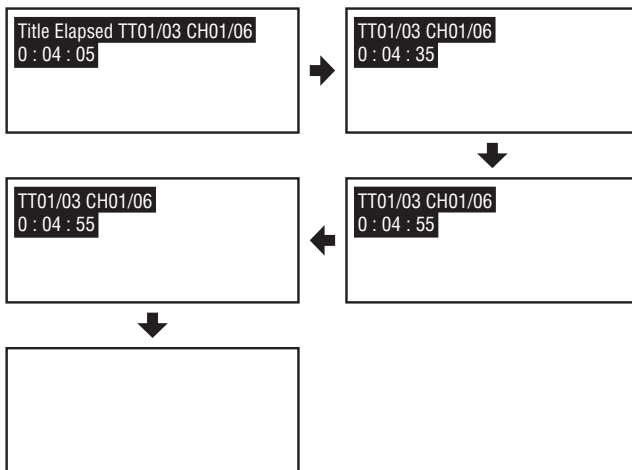
1. Press the **DISPLAY** button repeatedly during play to display elapsed time of title, chapter, track, etc.



### KEY LOCK

This feature allows you to lock all the controls on the front panel of the main unit to prevent others, especially children, from operating the unit without the remote handset. To activate the Key Lock feature press the **KEY LOCK**  button on the remote control. The "Key Lock On" statement will appear on the TV screen and all front panel controls, including the Power button will be locked. To unlock the front panel controls press the **KEY LOCK**  button on the remote control again. The "Key Lock Off" statement will appear on the TV screen to indicate the unlock action.

# Additional Information

## Troubleshooting

If you experience any of the following difficulties while using the system, use this troubleshooting guide to help you remedy the problem. Should any problem persist, consult your nearest service center by calling 1-800-898-9020.

### No power.

- Is the power cord firmly plugged into the power outlet?
- One of the safety mechanisms may be operating. In this event, unplug the player from the power outlet briefly and then plug it in again.

### No picture.

- Check that the system is connected securely.
- The video connecting cord is damaged. Replace it with a new one.
- Make sure you connect the system to the video input connector on the TV. (see page 14)
- Make sure you turn on the TV.
- Make sure you select the video input on the TV so that you can view the pictures from this system.

### Noise (interference) appears in the picture.

- Clean the disc.
- If video from this system has to go through your VCR to get to your TV, the copy-protection applied to some DVD programs could affect picture quality.

### The aspect ratio of the screen cannot be changed even though you set "TV SYSTEM" in the SETUP menu when you play a wide picture.

- The aspect rate is fixed on your DVD disc.
- Depending on the TV, you may not be able to change the aspect ratio.

### There is no sound or only a very low-level sound is heard.

- The audio connecting cord is damaged. Replace it with a new one.
- The system is in pause mode or in slow-motion play mode, or fast forward or fast reverse is performed
- Press **PLAY** ▶ to return to normal play mode.

### Severe hum or noise is heard.

- Move your TV away from the audio components.
- The plugs and jacks are dirty. Wipe them with a cloth slightly moistened with alcohol.
- Clean the disc.

### The remote does not function.

- Remove any obstacles between the remote control and the system.
- Move the remote control closer to the system.
- Point the remote control at the remote sensor on the front panel.
- Replace all the batteries in the remote control with new ones if they are weak.
- Check that the batteries are loaded correctly.

### The disc does not play.

- Insert a disc.
- Insert the disc correctly with the playback side facing down on the disc tray.
- Clean the disc. (see page 12)
- The system cannot play CD-ROMs, etc. (see page 11) Insert a DVD or a CD disc.
- Check the region code of the DVD disc. (see page 11)
- Moisture has condensed inside the system. Remove the disc and leave the system turned on for about an hour. (see page 9)

### The system starts playing the DVD automatically.

- The DVD features the auto playback function.

### Playback stops automatically.

- Depending on the disc, the auto pause signal is recorded. While playing such a disc, the system stops playback at the signal.

### Stopping playback, Search, Slow-motion play, repeat play or Program play, etc., cannot be done.

- Depending on the disc, some of the above operations may not be available.

### Messages do not appear on the TV screen in the language you want.

- Select the language for OSD in SETUP menu. (see page 20) The disc must have the language you selected, if not, other language will be selected.

### The language for the sound cannot be changed when you play a DVD.

- Multilingual sound is not recorded on the DVD.
- Changing the language for the sound is prohibited on the DVD.

### The language for the subtitles cannot be changed when you play a DVD.

- Multilingual subtitles are not recorded on the DVD.
- Changing the language for the subtitles is prohibited on the DVD.

### The subtitles cannot be turned off when you play a DVD.

- Depending on the DVD, you may not be able to turn the subtitles off.

### The angles cannot be changed when you play a DVD.

- Multi-angles are not recorded on some DVDs.
- Change the angles when the angle marks appears on the TV screen. (see page 17)
- Changing the angles is prohibited on some DVDs.

### The system does not operate properly.

- Static electricity, etc., may affect the system's operation. Disconnect the AC power cord once, then connect it again.



TO FIND THE LOCATION AND PHONE NUMBER OF YOUR NEAREST SERVICE CENTER PERMITTED TO PERFORM WARRANTY...

CALL TOLL FREE 1-800-695-0098

FOR ADDITIONAL SET-UP OR OPERATING ASSISTANCE  
PLEASE CALL:  
1-800-898-9020

FOR CUSTOMER SERVICE, PLEASE WRITE TO:  
Emerson Radio Corp.  
Consumer Affairs Dept.  
5101 Statesman Drive,  
Irving, TX 75063

The serial number of your system can be found on a label on the back panel of the main unit, and also on the display carton. Please record the serial number in the space below. You may need to refer to this number if your system ever needs to be serviced.

Model No.: BAR330

Serial No.: \_\_\_\_\_

## EMERSON RADIO CORP. LIMITED WARRANTY

**What does this warranty cover?** Any manufacturing defects in original material, including original parts and workmanship, under normal use and conditions.

**For how long?** For a period of ninety (90) days for labor and for a period of one (1) year for parts, from the date of original purchase in the U.S.

**What will we do?** If you need service under this warranty, and you provide us with the dated proof of purchase, we will provide repair service at no charge for labor and parts, for the time periods set forth above, at an authorized Depot Repair Facility, or replace the product in our discretion.

**How do you make your warranty claim?** If it becomes necessary to repair your unit, you can obtain the name and mailing location of a Depot Repair Facility by dialing 1-800-695-0098. You should pack your unit in a well-padded heavy corrugated box, enclose your check or money order payable to the Depot Repair Facility in the amount of \$9.00 to cover the return shipping and handling costs, and enclose a copy of your proof of purchase (warranty service will not be provided without a dated proof of purchase). Finally, you should ship the unit prepaid via UPS or parcel post (insured).

**What does your warranty not cover?** Your warranty does not cover the following:

- Damage from negligence, misuse, abuse, accident, or failure to follow operating instructions.
- Use of product in a commercial application or rentals.
- Changes or repairs by anyone other than an authorized Depot Repair Facility.
- Damage because your unit is improperly connected to the equipment of other manufacturers.
- Unit on which the serial number has been defaced, modified or removed.
- Damage to equipment not properly connected to the product.
- Cost incurred in shipping your unit to and from an authorized Depot Repair Facility.
- Ordinary adjustments which you can perform as outlined in the owner's manual.
- Signal reception problems caused by external antenna or cable systems.
- Products purchased, used, serviced, or damaged outside of the United States.
- Damage to compact discs or cassettes.

**What other limitations apply to your warranty?**

THIS WARRANTY IS NOT-TRANSFERABLE AND APPLIES ONLY TO THE ORIGINAL PURCHASER AND DOES NOT EXTEND TO SUBSEQUENT OWNERS OF THE PRODUCT. THIS WARRANTY IS VALID ONLY IN THE UNITED STATES OF AMERICA. ANY APPLICABLE IMPLIED WARRANTIES, INCLUDING THE WARRANTY OF MERCHANTABILITY, ARE LIMITED IN DURATION TO A PERIOD OF THE EXPRESSED WARRANTY AS PROVIDED ABOVE BEGINNING WITH THE DATE OF ORIGINAL PURCHASE AT RETAIL AND NO WARRANTIES, WHETHER EXPRESSED OR IMPLIED, SHALL APPLY TO THE PRODUCT THERE AFTER. WE MAKE NO WARRANTY AS TO THE FITNESS OF THE PRODUCT FOR ANY PARTICULAR PURPOSE OR USE.

THE EXTENT OF OUR LIABILITY UNDER THIS LIMITED WARRANTY IS THE REPAIR OR REPLACEMENT PROVIDED ABOVE AND IN NO EVENT WILL OUR LIABILITY EXCEED THE PURCHASE PRICE PAID BY THE PURCHASER OF THE PRODUCT. UNDER NO CIRCUMSTANCES WILL WE BE LIABLE FOR ANY LOSS, DIRECT, INDIRECT, INCIDENTAL, SPECIAL, OR CONSEQUENTIAL DAMAGE ARISING OUT OF OR IN CONNECTION WITH THE USE OF THIS PRODUCT.

**How does state law apply to your warranty?**

THIS WARRANTY GIVES YOU SPECIFIC LEGAL RIGHTS, BUT YOU MAY ALSO HAVE OTHER RIGHTS WHICH VARY FROM STATE TO STATE. SOME STATES DO NOT ALLOW LIMITATIONS ON IMPLIED WARRANTIES OR EXCLUSION OR LIMITATION OF INCIDENTAL OR CONSEQUENTIAL DAMAGE, SO THESE RESTRICTIONS MAY NOT APPLY TO YOU.

DVD399



BAR330-020207-01

Printed in China

