



Emerson[®]

***HOME AUDIO SYSTEM
with 5 CD CHANGER,
3 SPEED TURNTABLE,
DUAL CASSETTE DECK
and REMOTE CONTROL***

OWNER'S MANUAL



MS9923TT

Visit our web site at www.emersonradio.com



CAUTION

TO PREVENT FIRE OR SHOCK HAZARD, DO NOT USE THIS PLUG WITH AN EXTENSION CORD, RECEPTACLE OR OTHER OUTLET UNLESS THE BLADES CAN BE FULLY INSERTED TO PREVENT BLADE EXPOSURE. TO PREVENT FIRE OR SHOCK HAZARD, DO NOT EXPOSE THIS APPLIANCE TO RAIN OR MOISTURE.

 <p>The lightning flash with arrow-head symbol, within an equilateral triangle is intended to alert the user to the presence of uninsulated 'dangerous voltage' within the product's enclosure that may be of sufficient magnitude to constitute a risk of electric shock to persons.</p>	<p style="text-align: center;">CAUTION</p> <p style="text-align: center;">RISK OF ELECTRIC SHOCK DO NOT OPEN</p> <p>WARNING: TO REDUCE THE RISK OF ELECTRIC SHOCK DO NOT REMOVE COVER (OR BACK), NO USER SERVICEABLE PARTS INSIDE REFER SERVICING TO QUALIFIED SERVICE PERSONNEL.</p>	 <p>The exclamation point within an equilateral triangle is intended to alert the user to the presence of important operating and maintenance (servicing) instructions in the literature accompanying the appliance.</p>
--	---	---

The Caution Marking maybe located at the bottom enclosure of the apparatus.

IMPORTANT SAFETY INSTRUCTIONS

- 1.) Read these instructions. Keep these instructions. Follow all instructions. Heed all warnings.
- 2.) Do not use this apparatus near water.
- 3.) Clean only with dry cloth.
- 4.) Do not block any ventilation openings. Install in accordance with the manufacturer's instructions.
- 5.) Do not install near any heat sources such as radiators, heat registers, stoves, or other apparatus (including amplifiers) that produce heat.
- 6.) Do not defeat the safety purpose of the polarized or grounding-type plug. A polarized plug has two blades with one wider than the other. A grounding type plug has two blades and a third grounding prong. The wide blade or the third prong is provided for your safety. If the provided plug does not fit into your outlet, consult an electrician for replacement of the obsolete outlet.
- 7.) Protect the power cord from being walked on or pinched particularly at plugs, convenience receptacles, and the point where they exit from the apparatus.
- 8.) Only use attachments / accessories specified by the manufacturer.
- 9.) Unplug this apparatus during lightning storms or when unused for long periods of time.
- 10.) Refer all servicing to qualified service personnel. Servicing is required when the apparatus has been damaged in any way, such as power-supply cord or plug is damaged, liquid has been spilled or objects have fallen into the apparatus, the apparatus has been exposed to rain or moisture, does not operate normally, or has been dropped.
- 11.) This appliance shall not be exposed to dripping or splashing water and no object filled with liquids such as vases shall be placed on the apparatus.
- 12.) Use only with the cart, stand, tripod, bracket, or table specified by the manufacturer, or sold with the apparatus. When a cart is used, use caution when moving the cart/apparatus combination to avoid injury from tip-over.
- 13.) Do not overload wall outlet. Use only power source as indicated.
- 14.) Use replacement parts as specified by the manufacturer.
- 15.) The product may be mounted to a wall only if recommended by the manufacturer.
- 16.) Upon completion of any service or repairs to this product, ask the service technician to perform safety checks.





Thank you.....

For purchasing this Emerson complete home audio system including a stereo radio, 5 disc changer, dual cassette deck, stereo phonograph, matching speakers, and remote control.

Please read this Owner's Manual carefully and completely to make sure that you get the maximum benefit out of all the outstanding features we've included in this compact system. It's designed to give you many years of trouble free operation with an absolute minimum of care and maintenance.

Every component in this system was in perfect working order when it left our factory. If you experience any problems with the set up or operation of this system please do not return it to the retail store. Please call the Emerson Customer Service Hotline toll free at 1-800-898-9020 and one of our service technicians will attempt to diagnose and correct the problem for you.

Once again, thanks for purchasing this Emerson audio product.





IMPORTANT NOTES

- Avoid installing this unit in places exposed to direct sunlight or close to heat radiating appliances such as electric heaters, on top of other stereo equipment that radiates too much heat, places lacking ventilation or dusty areas, places subject to constant vibration and/ or humid or moist areas.
- Do not attempt to clean this unit with chemical solvents as this might damage the finish. Use a clean dry cloth.
- Operate controls and switches as described in the manual.
- Before turning 'On' the power, make certain that power cord is properly installed.
- Store your CDs in a cool area to avoid damage from heat.
- When moving the set, be sure to first disconnect the power cord.

CLASS 1 LASER PRODUCT

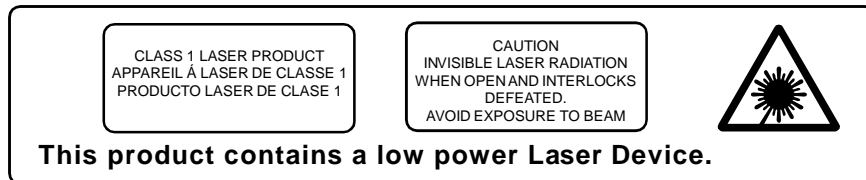

NOTE: This product complies with DHSS Rule 21 Subchapter J at date of manufacture.

FCC Information

This equipment has been tested and found to comply with the limits for a Class B digital device, pursuant to Part 15 of the FCC Rules. These limits are designed to provide reasonable protection against harmful interference in a residential installation. This equipment generates, uses, and can radiate radio frequency energy and, if not installed and used in accordance with the instructions, may cause harmful interference to radio communications. However, there is no guarantee that interference will not occur in a particular installation. If this equipment does cause harmful interference to radio or television reception, which can be determined by turning the equipment off and on, the user is encouraged to try to correct the interference by one or more of the following measures:

- Reorient or relocate the receiving antenna.
- Increase the separation between the equipment and receiver.
- Connect the equipment into an outlet on a circuit different from that to which the receiver is connected.
- Consult the dealer or an experienced radio/TV technician for help.

This device complies with Part 15 of the FCC Rules. Operation is subject to the following two conditions:

- (1) This device may not cause harmful interference, and
- (2) This device must accept any interference received, including interference that may cause undesired operation.

Changes or modifications not expressly approved by the party responsible for compliance could void the user's authority to operate the equipment.



PREPARATION FOR USE

SPEAKER CONNECTION

Connect each speaker to the corresponding speaker terminals on the back panel of the main unit.

Make sure that the left speaker is connected to the left pair of speaker terminals and the right speaker to the right pair of speaker terminals.

Also make sure that the speaker wires are correctly connected:

The red wires are connected to the red (+) terminals.

The black wires are connected to the black (-) terminals.

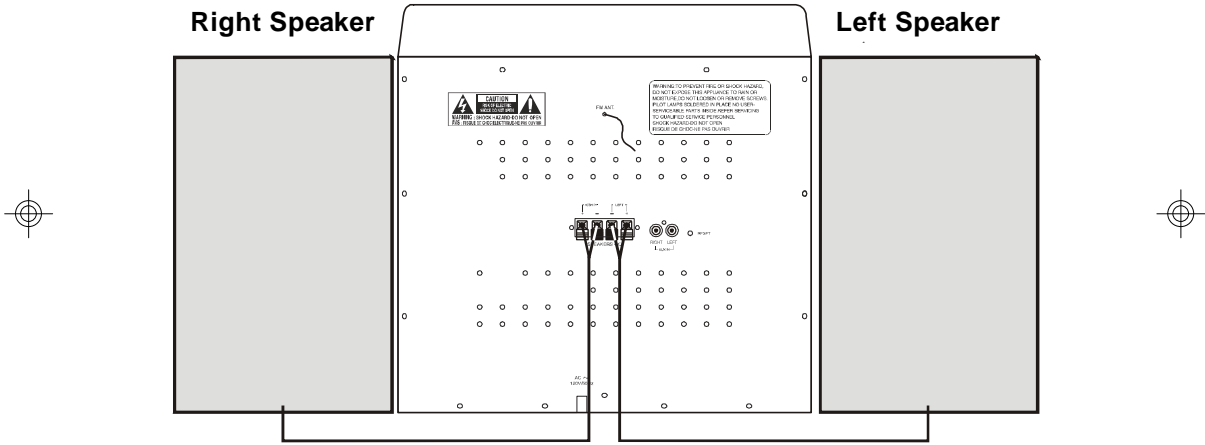

Depress the plastic lever to open the terminal, insert the bare end of the speaker wire into the opening and release.

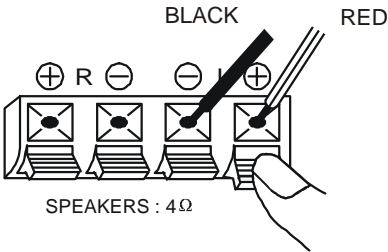



CONNECTING THE AC POWER CORD

After connecting the speakers unwind the AC power cord fully and connect it to any convenient household AC outlet.

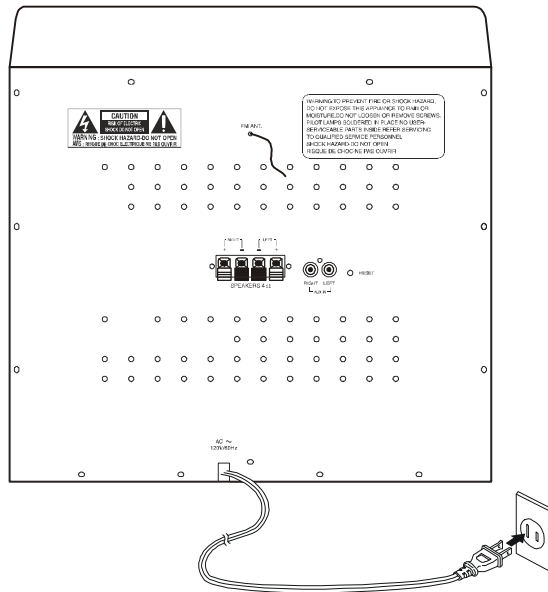

NOTE: This product is designed to operate on normal 120V 60Hz AC only. Connecting this system to any other power supply could result in damage to the unit which is not covered by your warranty.

You will note that this system is equipped with a polarized AC power plug having one blade wider than the other. This is a safety feature. If this plug does not fit into your existing AC outlet, do not try to defeat this safety feature by filing the wide blade to make it fit into your outlet. If this plug will not fit into your outlet, you probably have an out-dated non-polarized AC outlet. You should have your outlet changed by a qualified licensed electrician.

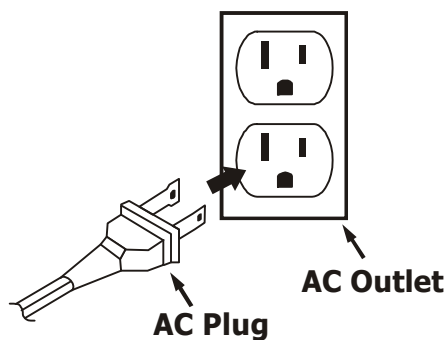



PROTECT YOUR FURNITURE

This model is equipped with non-skid rubber 'feet' to prevent the product from moving when you operate the controls. These 'feet' are made from non-migrating rubber material specially formulated to avoid leaving any marks or stains on your furniture. However certain types of oil based furniture polishes, wood preservatives, or cleaning sprays may cause the rubber 'feet' to soften, and leave marks or a rubber residue on the furniture. To prevent any damage to your furniture we strongly recommend that you purchase small self-adhesive felt pads, available at hardware stores and home improvement centers everywhere, and apply these pads to the bottom of the rubber 'feet' before you place the product on fine wooden furniture.





LOCATION OF CONTROLS AND INDICATORS

FRONT PANEL

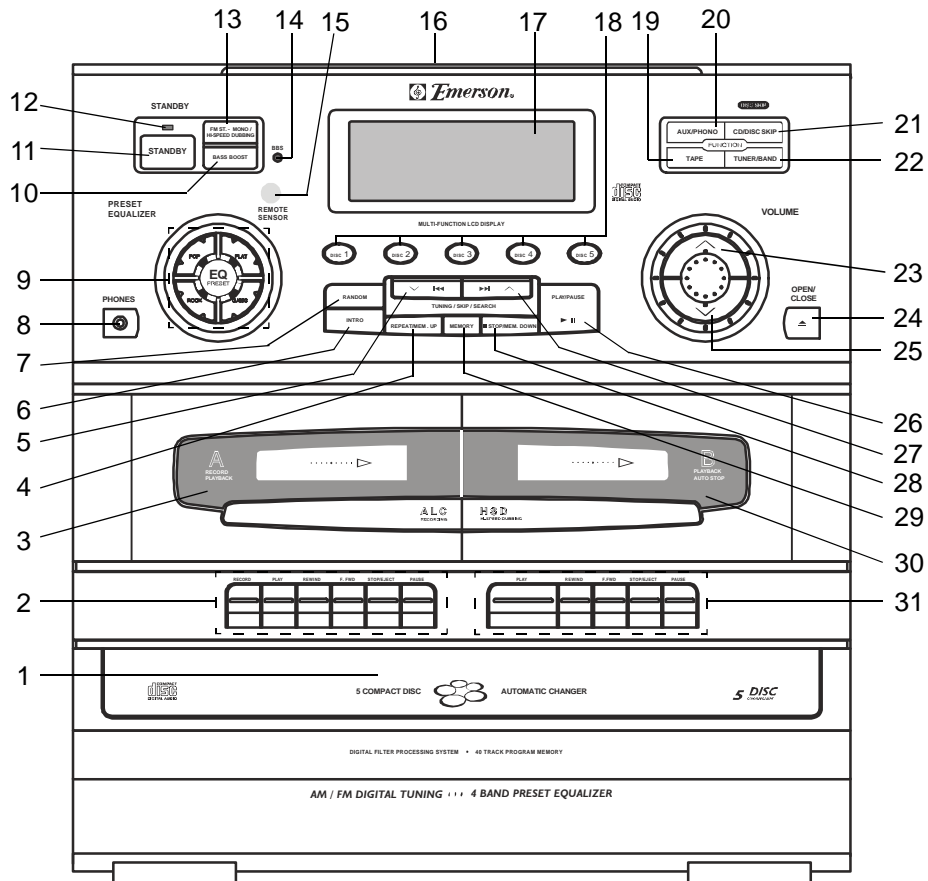



- 1.) **5 CD CHANGER** Tray.
- 2.) Cassette DECK **A** Control Keys:
RECORD / PLAY / REWIND / F. FWD (Fast Forward) / **STOP-EJECT / PAUSE**.
- 3.) Cassette DECK **A** Compartment.
- 4.) **REPEAT / MEM. UP** Button.
- 5.) **TUNING** ∇ / **SKIP SEARCH** ◀◀ Button.
- 6.) **INTRO** Button.
- 7.) **RANDOM** Button.
- 8.) **PHONES** Jack.
- 9.) **PRESET EQUALIZER (FLAT / CLASSIC / ROCK / POP)** Buttons & Indicators.
- 10.) **BASS BOOST** Button.
- 11.) **STANDBY** Button.
- 12.) **STANDBY** Indicator.
- 13.) **FM ST. – MONO / HI-SPEED DUBBING** Button.
- 14.) **BBS** (Bass Boost) 'On' Indicator.
- 15.) **REMOTE SENSOR**.
- 16.) Turntable Dust Cover.
- 17.) **MULTI-FUNCTION LCD DISPLAY**.
- 18.) CD **DISC 1, 2, 3, 4, 5** Select Buttons.
- 19.) **TAPE** Button.
- 20.) **AUX / PHONO** Button.
- 21.) **CD / DISC SKIP** Button.
- 22.) **TUNER / BAND** Button.
- 23.) **VOLUME** Up ▲ Button.
- 24.) CD Tray **OPEN / CLOSE** ▲ Button.
- 25.) **VOLUME** Down ▼ Button.
- 26.) CD **PLAY / PAUSE** ▶|| Button.
- 27.) **TUNING** ▲ / **SKIP SEARCH** ▶▶ Button.
- 28.) **STOP** ■ / **MEM. DOWN** Button.
- 29.) **MEMORY** Button.
- 30.) Cassette DECK **B** Compartment.
- 31.) Cassette DECK **B** Control Keys:
PLAY / REWIND / F. FWD (Fast Forward) / **STOP-EJECT / PAUSE**.



BACK PANEL

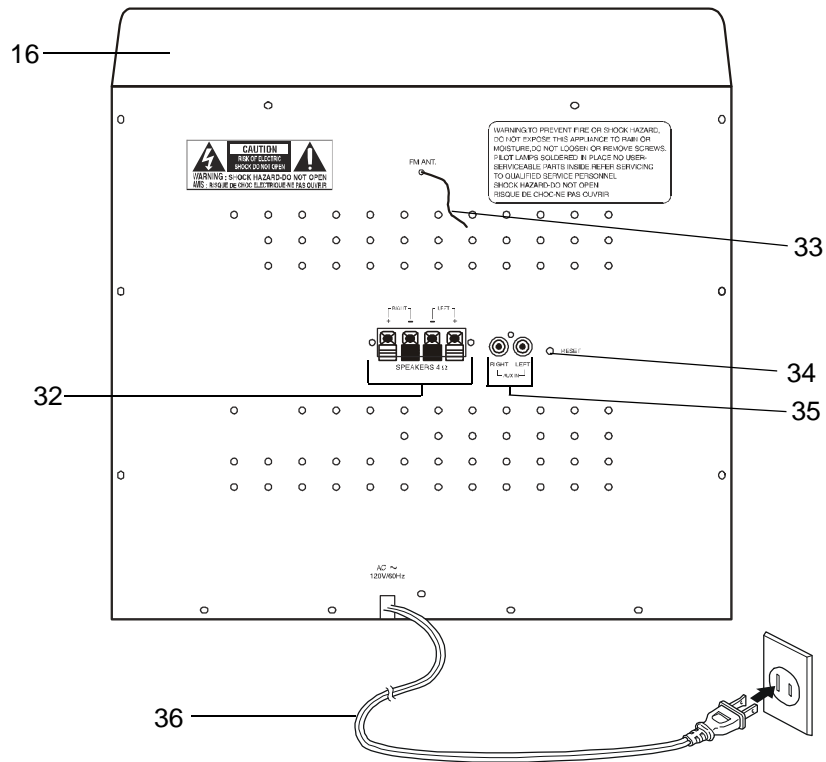

- 32.) **SPEAKER** Terminals.
- 33.) **FM** Lead Wire Antenna.
- 34.) **RESET** Button (Inside pin hole).
- 35.) **AUX IN (RIGHT/LEFT)** Jacks.
- 36.) **AC** Power Cord.

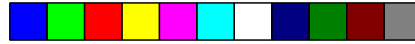

REMOTE CONTROL

- 1.) **TUNING** Up/CD Skip Fwd ►► Button.
- 2.) CD Play/Pause ►► Button.
- 3.) **TUNING** Down/CD Skip Rev ◄◄ Button.
- 4.) CD Stop ■/**MEMORY DOWN** Button.
- 5.) CD **INTRO** Button.
- 6.) **MEMORY UP/REPEAT** Button.
- 7.) **MEMORY** Button.
- 8.) **OPEN/CLOSE** Button.
- 9.) **TUNER/BAND** Button.
- 10.) **TAPE** Button.
- 11.) **AUX/PHONO** Button.
- 12.) **POWER** ⏻ Button.
- 13.) **MUTE** Button.
- 14.) **CD/DISC SKIP** Button.
- 15.) **RANDOM** Button.
- 16.) **REMAIN** Button.
- 17.) **VOLUME +** Button.
- 18.) **VOLUME -** Button.
- 19.) Battery Compartment (Back Cabinet).

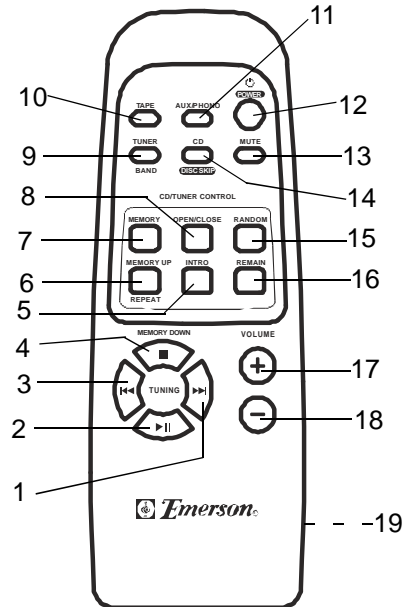

BATTERY INSTALLATION

- 1.) Open the battery compartment cover.
- 2.) Insert two "AA" (UM3) batteries (not included) to match the polarities as indicated inside the battery compartment.
- 3.) Close the cover.

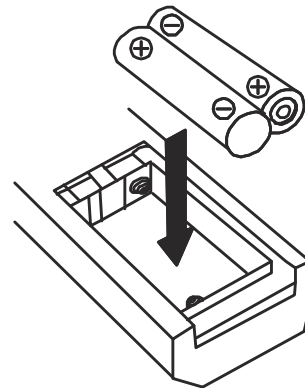

Battery Precautions

- Replacement of batteries must be done by an adult.
- Do not mix old and new batteries.
- Do not mix alkaline, standard (carbon-zinc) or rechargeable (nickel-cadmium) batteries.
- The supply terminals are not to be short-circuited.
- Non-rechargeable batteries are not to be recharged.
- Exhausted batteries are to be removed.
- Only batteries of the equivalent type are to be used.
- Batteries are to be inserted with the correct polarity.
- Dispose of batteries properly. Do not dispose of batteries in fire. The batteries may explode or leak.





OPERATING INSTRUCTIONS

GENERAL CONTROLS

PRESET Electronic EQUALIZER

When the unit is switched 'On' for the first time, the Equalizer will be in the "Flat" setting. Press the appropriate PRESET EQUALIZER button to select "**ROCK**", "**POP**", "**CLASSIC**" or "**FLAT**" sound effect to suit your taste. The appropriate EQ Indicator lights to confirm your selection.

BASS BOOST System

The Bass Boost feature intensifies low frequency sound for richer bass reproduction.

- 1.) Press the **BASS BOOST** button once to activate Bass Boost. The **BBS** indicator will light up.
- 2.) To turn 'Off' the Bass Boost system, press the **BASS BOOST** button again. The **BBS** indicator will go 'Off'.

NOTE: If you are listening to music with heavy bass at high volume, with EQ set to "**ROCK**" and **BASS BOOST** 'On', you may experience some distortion. If this occurs, set the EQ to "**FLAT**", switch the **BASS BOOST** 'Off', or reduce the volume.

MUTE Button (On Remote Control Only)

To temporarily shut off the sound from the speakers press the **MUTE** button on the remote control.

The **MUTE** indicator will appear on the LCD display. Press the **MUTE** button again to cancel Mute and restore the sound. The **MUTE** indicator goes "Off".

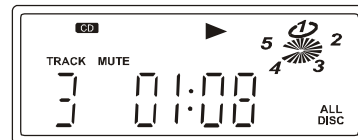

FM ST.-MONO / HI-SPEED DUBBING Button

This button is used to select between the FM STEREO and FM MONO operation modes. It is also used to select either Normal Speed or High Speed tape dubbing.

To receive FM Stereo broadcasts this switch must be set to the **FM ST.** position. However if you are listening to a distant or weak FM Stereo station and reception is unsatisfactory, press the button to the **MONO** position may provide some improvement.





LISTENING TO THE RADIO

Radio Operation



- 1.) Press the **STANDBY (POWER)** button to turn the system 'On'. The **STANDBY** indicator goes 'Off'. The LCD display and the EQ indicator light up.
- 2.) Press the **TUNER/BAND** button to select the Radio mode.
- 3.) To switch between **AM** and **FM** bands, press the **TUNER/BAND** button again.

If you tune in a FM stereo station, and the the **FM ST.– MONO** button is set at **FM ST.**  position, the **STEREO** indicator will appear on the LCD display.





- 4.) Press the **TUNING**  or **TUNING**  buttons to tune to the desired station as follows.

Manual Tuning

Press the **TUNING**  or **TUNING**  buttons as many times as required until the frequency of the desired station appears on the display.

Automatic Tuning

Press and hold the **TUNING**  or **TUNING**  buttons for approximately 2 seconds. The Tuner will begin scanning up or down automatically and will lock onto the next strong signal.

- 5.) Adjust the **VOLUME**, **BASS BOOST** and **EQ** controls as desired.



Memorizing Preset Stations

You can store up to **40** of your favorite **FM** and **AM** stations randomly. Once a station is preset in the memory, you will have quick and easy access to that station.

- 1.) Press the **TUNER/BAND** button to select the Radio mode.
- 2.) To switch between **AM** and **FM** bands, press the **TUNER/BAND** button again.

- 3.) Select the desired station by pressing the **TUNING** \wedge or **TUNING** \vee buttons.

Example: FM 103.5 MHz.



- 4.) Press the **MEMORY** button. The **MEMORY**, **CH**, and channel number '00' indicators will flash in the display.



- 5.) Press the **MEM. UP** or **MEM. DOWN** button to select any one of the 40 available preset station memories. Example: CH 01.



- 6.) Press the **MEMORY** button again to enter the selected radio station into the selected memory location.



- 7.) Repeat the above steps 2 – 6 to enter all your desired stations into the preset station memories.

After you have entered up to **40** stations in the preset memories, you can select any one of the memorized stations quickly and easily by simply pressing the **REPEAT/MEM. UP** or **STOP/MEM. DOWN** buttons until the desired memory number and station frequency appear in the display.



Antenna Information

For best FM reception, the FM lead wire antenna, located on the back of the set, should fully unwound and extended.

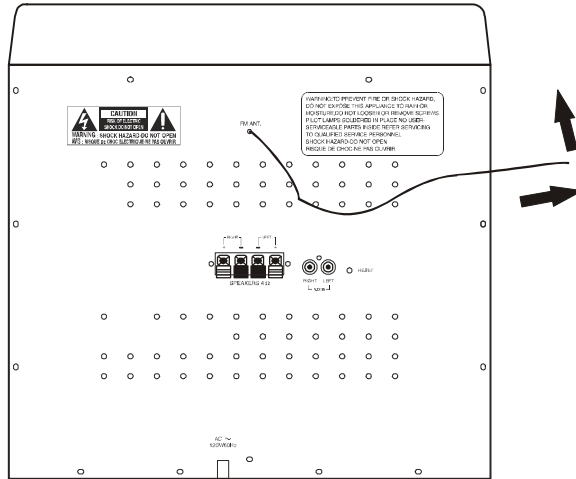

The AM bar antenna is inside the cabinet. To improve AM reception, you may have to move or slightly rotate the main unit until you obtain the best reception.

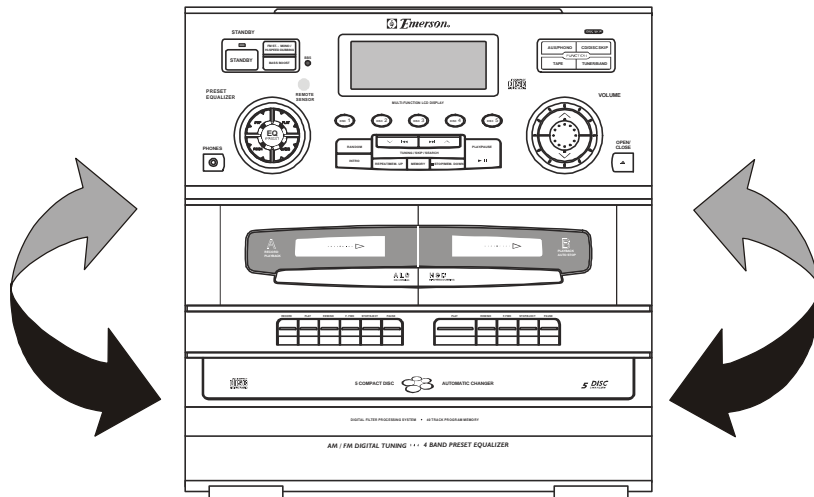



COMPACT DISC PLAYBACK

This system features a carousel type **5 CD CHANGER** which can provide you with up to 5 hours of uninterrupted music playback. You may load up to 5 CDs in the changer for continuous playback, or you may program up to 40 tracks among all 5 discs to be played back in the specific order you select.

Loading the Discs

- 1.) Press the **STANDBY (POWER)** button to turn the system 'On'.
- 2.) Press the **CD/DISC SKIP** button to select the CD mode.

- 3.) Press the **OPEN/CLOSE** button to open the CD tray. When the tray opens two of the five CD pockets will be accessible to you.

Load up to **2 CDs** in the pockets making sure that the label side of the discs face up and that the discs are correctly centered in the pockets.



- 4.) Press the **CD/DISC SKIP** button to rotate the CD tray and expose the **3rd**, **4th**, and **5th** CD pocket.
Insert additional discs in the open pockets if desired.
- 5.) Press the **OPEN/CLOSE** button to close the CD tray. The CD player will search for the first disc and the display will show the number of tracks and total playing time of that disc.

NOTES:

- *Keep the CD disc tray closed when the system is not in use to prevent dirt and dust from entering the CD mechanism.*
- *Never place more than one CD in the same pocket of the CD tray. If two discs are loaded in the same pocket, the CD mechanism may jam and/or the discs themselves may be damaged.*



To Begin CD Playback

After you have loaded up the 5 CDs in the changer:

- 1.) Press the **PLAY/PAUSE** ►|| button to begin playback. The changer will search for the first available disc in the tray and will begin playback from Track 1 on the first disc. The number of the disc being played flashes on the display. It will continue playing until it has played all of the discs in the tray and then stops automatically.



NOTE: To begin playback from a specific disc, press the **CD/DISC SKIP** button to select the desired disc, and then press the **PLAY/PAUSE** ►|| button.

Or, press the appropriate disc button (**DISC 1**, **DISC 2**, **DISC 3**, **DISC 4**, **DISC 5**) for the disc you wish to start. Playback will begin on Track 1 of the selected disc. It stops automatically after finished playing all discs.

- 2.) Adjust the **VOLUME**, **BASS BOOST**, or **EQ** controls as desired.
- 3.) To temporarily stop playback, press the **PLAY/PAUSE** ►|| button again. The "||" indicator appears in the display, and the play time flashes.

The disc continues to spin, but no sound is heard. Press the **PLAY/PAUSE** ►|| button once more to cancel pause and resume playback.

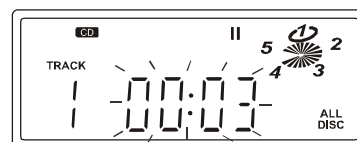

- 4.) To stop playback before the end of a disc, press the **STOP** ■ button.

IMPORTANT

If the disc is smudged or scratched it may skip or stop completely. This does not indicate a problem with the player. If this occurs, try playing another disc. If that disc plays properly, you may assume that the first disc is damaged and unplayable.



Forward And Backward SKIP/SEARCH Buttons

To skip forward or backward to the beginning of a particular track during playback, press the ►► or ◀◀ **SKIP/SEARCH** buttons repeatedly until the desired track number appears on the display. Playback will begin on the desired track.

To search for a particular passage on a track during playback, press and hold the ►► or ◀◀ **SKIP/SEARCH** buttons. The player will search rapidly forward or back. Release the button when you reach the desired point on the track and normal speed playback will resume at that point.

Remaining Time Indication

While the CD is playing, each time you press the **REMAIN** button on the Remote Control, the Display changes as shown below:

1.) Elapsed Time Of The Track.



2.) Remaining Time Of The Track.



3.) Total Remaining Time Of The Disc.



4.) Total Elapsed Play Time.





PROGRAMMED CD PLAYBACK

You can program the CD changer to play up to a total of **40** tracks on all 5 discs in any desired order.

NOTE: You can not program the CD changer during playback. If a disc is playing press the **STOP** ■ button first and then follow the instructions.

Entering A Program

- 1.) Press the **MEMORY** button once. The **MEMORY**, the track number indicators will flash in the display. Program number **P-01** appears.

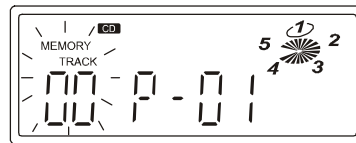

- 2.) Press the **CD/DISC SKIP** button or one of the five disc buttons to select the disc which contains the first track you wish to program.

Example: **Disc 2.**

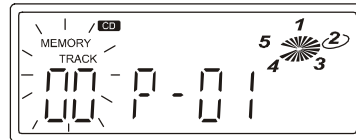

- 3.) Press the **SKIP** buttons to select the first track you wish to program.

Example: **Track 08.**

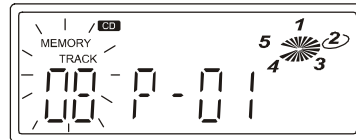

- 4.) Press the **MEMORY** button again to store the desired disc and track number into memory location Number 1. The display will change from Program Number P-01 to Program Number **P-02**.

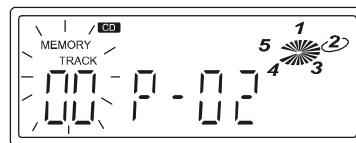

- 5.) Use the **CD/DISC SKIP** button or one of the five disc buttons to select the disc containing the next track you wish to program.

Example: **Disc 3.**

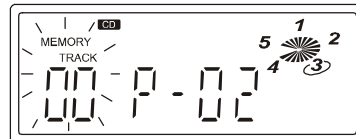



6.) Press the **▶▶** or **◀◀ SKIP** buttons to select the next track you wish to program.

Example: Track **18**.

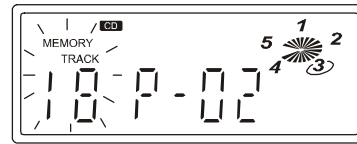

7.) Press the **MEMORY** button again to store the desired disc and track into memory location Number 02.

Repeat the above procedure until you have stored up to **40** tracks in the program memory and **FULL** flashes in Display.

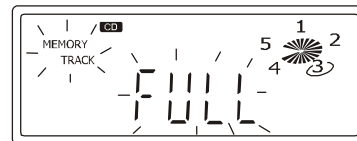

After all your desired tracks are programmed you may press the **MEMORY** button to reconfirm that the information has been stored correctly. The display will show you which disc and track number you have entered into program memory Number 1.

Each time you press the **MEMORY** button the display will show you which disc number and track number is stored in each successive memory location.

Programmed Playback

After you have stored and confirmed the program information, press the **PLAY/PAUSE ▶||** button to begin programmed playback.

Playback will start at the first disc and track which you have programmed and will continue until all programmed discs and tracks.



Up to a total of **40** tracks have been played.

NOTE: If you press the **▶▶** or **◀◀ SKIP** buttons during programmed playback, the player will skip forward or back to the next track and disc which you have programmed, not the next track on the disc which is being played.

To Clear The Program Memory

If the disc is playing, press the **STOP ■** button to stop the discs. Then press the **STOP ■** button again to clear the program memory.



REPEAT FUNCTION

This system has a four-way repeat function which allows you to continuously repeat one track, one disc, all discs, or all of the tracks which you have programmed.

One Track Repeat

- 1.) Press the **REPEAT** button until the **REPEAT ONE** indicator appears in the LCD display.



- 2.) Use the **▶▶** or **◀◀** **SKIP** buttons (and the **CD/DISC SKIP** button, if necessary) to select the exact track that you wish to repeat.

Example: Disc **2**, Track **8**.

- 3.) Press the **PLAY/PAUSE ▶||** button to begin one track repeat. The selected track will begin playing. It will repeat continuously until **REPEAT ONE** function is cancelled.

One Disc Repeat

- 1.) Press the **REPEAT** button until the **REPEAT ONE DISC** indicator appears on the LCD display. Press the **CD/DISC SKIP** button to select the disc you wish to play.



Example: Disc **5**.

- 2.) Press the **PLAY/PAUSE ▶||** button. The selected disc will begin to play starting with Track 1. When the final track on the disc has been played, it will automatically begin playing again starting with Track 1.

- 3.) To cancel One Disc Repeat playback, press the **REPEAT** button until the **REPEAT ONE DISC** indicator no longer appears in the Display.



All Discs Repeat

- 1.) Press the **REPEAT** button until the **REPEAT ALL DISC** indicator appears in the Display.



- 2.) Press the **PLAY/PAUSE** button, the changer will begin playing the first track of the disc which is in the play position. It will continue until it has played all tracks on all discs in the changer. When it has played the last track on the last disc it will begin playing again with the first track on the first disc. This All Discs Repeat will continue indefinitely.

- 3.) To cancel All Discs Repeat playback, press the **REPEAT** button until the **REPEAT ALL DISC** indicator no longer appears in the Display.

Repeat Off

Press the **REPEAT** button until the indicator disappears and the display shows **ALL DISC**.



Programmed Repeat

- 1.) Load up to 5 CDs in the changer and program up to 40 tracks into the CD Program Memory.

Refer to the instructions for **PROGRAMMED CD PLAYBACK** on Page 18.

- 2.) Press the **REPEAT** button until the **REPEAT** indicator appears in the LCD Display.



- 3.) Press the **PLAY/PAUSE** button. Playback will begin with the first programmed track and continue until the last programmed track (up to a maximum of 40 tracks). When the last track has been played, playback will begin again with the first programmed track. This sequence will continue indefinitely until Programmed Repeat Playback is cancelled.



- 4.) To cancel the Programmed Repeat Playback, press the **STOP** ■ button twice. You may also cancel the Programmed Repeat Playback by pressing the **REPEAT** button until the **REPEAT** Indicator no longer appears in the LCD Display.

INTRO SCAN

The Intro Scan feature lets you hear a 10 second introduction of each track on a disc. This feature is useful if you are trying to find a particular song but you do not know the title.

- 1.) Press the **INTRO** button once. The **INTRO** indicator appears in the display. The CD player will begin playing Track 1 of the disc in the play position. After 10 seconds it will advance to Track 2, and so on, until it has played the first 10 seconds of every track, every disc.



- 2.) To cancel Intro Scan and resume normal playback, press the **INTRO** button again. The **INTRO** Indicator disappears.

RANDOM PLAYBACK

The Random Playback feature is useful when you want to 'mix up the music' instead of playing all the tracks in numerical order.

- 1.) Press the **RANDOM** button once. The **RANDOM** Indicator appears in the display.



- 2.) Press the **PLAY/PAUSE** ►|| button. The changer will randomly select the first disc and track to be played. It will continue randomly selecting discs and tracks until all tracks on all discs have played, and then stop.
- 3.) To cancel Random Playback, press the **RANDOM** button again. The **RANDOM** indicator disappears and normal playback resumes.

NOTE: If you press the **RANDOM** button while a disc is playing, the Random selection will begin at the end of the track being played.

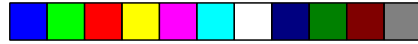

CASSETTE OPERATION

This Emerson Audio System features a dual cassette mechanism which allows you to play pre-recorded cassette tapes in either DECK A or DECK B. You may also load tapes in both decks for continuous automatic playback of two cassettes.

You may make tape recordings directly from the stereo receiver, the CD changer, the Turntable, or external source connected to the **AUX INPUT** jacks, or even from Tape to Tape (Dubbing) at either normal or high speed. The built in ALC (Automatic Level Control) system adjusts the volume for distortion-free recordings. You can change the playback volume control settings during recordings without effecting the volume of the final recording.

For best results always use good quality blank tapes for recording. Although blank tapes are available with various recording times we recommend that you do not use tapes longer than C-90 which contain 90 minutes of recording time (45 minutes per side). Longer tapes such as C-120's (60 minutes per side) use thinner material which may eventually stretch and can become tangled in the mechanism.

Keep the critical parts of the tape mechanisms clean to insure trouble free operation.

Refer to the cleaning instructions in the **CARE AND MAINTENANCE** section of this manual.

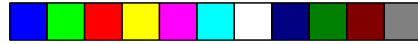

Cassette Playback

1.) Press the **STANDBY (POWER)** button to turn the system 'On'.

2.) Press the **TAPE** button to select the 'Tape' function. The **TAPE** indicator appears in the display.

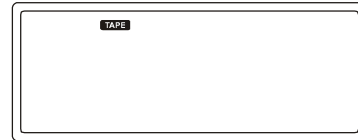

3.) Press the **STOP/EJECT** key on either Deck **A** or Deck **B** to open the cassette door.

4.) Insert the pre-recorded cassette(s) into the slots on the door with the exposed tape facing down and the full reel on the left.

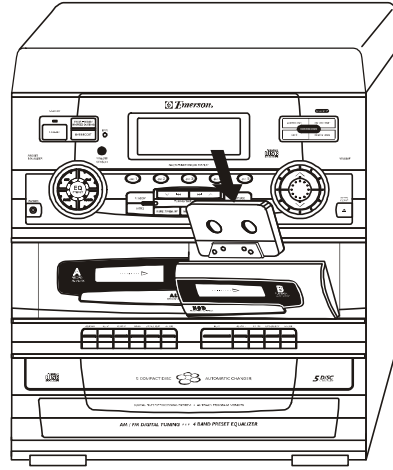
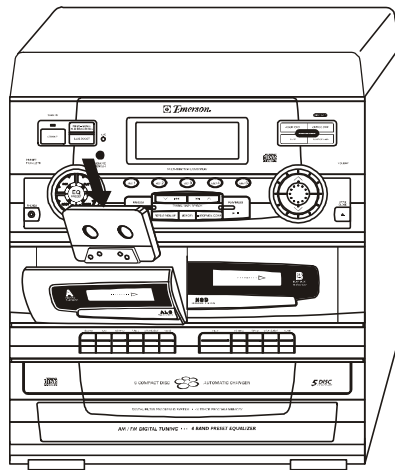

5.) Close the cassette door. Press the **PLAY** key to begin playback of your tape.

6.) Adjust the **VOLUME** and **BASS BOOST** or **EQ** controls as desired.

7.) Press the **STOP/EJECT** key to stop playback at any time. When the tape ends the Automatic Stop System will release the **PLAY** key and shut off the tape motor.

8.) Press the **STOP/EJECT** key again to open the cassette door and remove your tape.



F.FWD (Fast Forward) and REWIND Keys

Press either **F.FWD** or **REWIND** key at any time to move the tape rapidly forward or back to any specific point. When you reach the desired point press the **PLAY** key again to resume normal playback at that point.

***Note:** The Automatic Stop System does not function in the Fast Forward or Rewind modes. If you fast forward or rewind to the end or beginning of the tape, the **F.FWD** or **REWIND** keys will remain engaged and the tape motor continues to run. Be sure to press the **STOP/EJECT** key to cancel Fast Forward or Rewind and shut off the tape motor.*

PAUSE Key

Press the **PAUSE** key to momentarily stop the tape movement in Playback or Recording modes. The tape movement stops but the tape motor continues to run. Press the **PAUSE** key again to cancel Pause and resume normal playback.

***Note:** The **PAUSE** key has no effect in the Fast Forward or Rewind modes.*

Continuous Playback Of Two Cassettes

- 1.) Insert pre-recorded cassettes in both decks with the tape you wish to hear first in Deck **B**.
- 2.) Press **PLAY** key of Deck **B** to start playback from Deck **B**. Then press the **PAUSE** key and **PLAY** key of Deck **A**.
- 3.) When the tape in Deck **B** ends, it automatically stops. The **PAUSE** key of Deck **A** will release automatically and the tape in Deck **A** begins to play.
- 4.) When the tape in Deck **A** ends both mechanisms stop.
- 5.) To play the other sides, turn both tapes over and repeat Steps 1 and 2 above.



PLAYING PHONO RECORDS

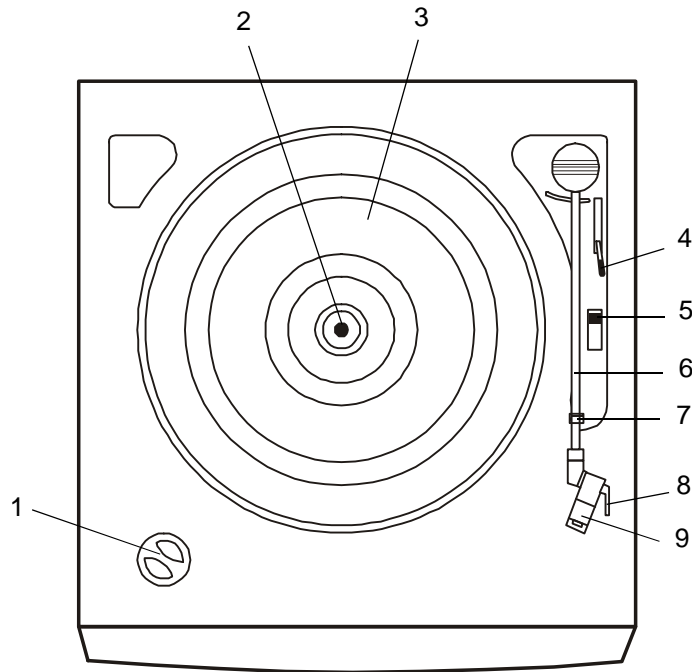

- 1.) 45 rmp LP Record Adapter.
- 2.) Center Spindle.
- 3.) Platter.
- 4.) Tone Arm Lever (Cue Control).
- 5.) 33/45/78 rmp Speed Slide Switch.
- 6.) Tone Arm.
- 7.) Tone Arm Rest and Clamp.
- 8.) Stylus lifter.
- 9.) Stylus and Protective Cover.

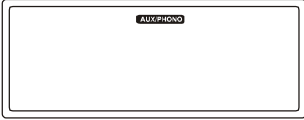

Stereo Phonograph Operation

- 1.) Raise the turntable dust cover.
- 2.) Release the tone arm clamp, and remove the stylus protector.
- 3.) Press the **AUX/PHONO** button to select the Phono mode. **AUX/PHONO** indicator appears in the display 
- 4.) Place a record on the turntable, over the center spindle.
- 5.) Place the 45 rpm adapter over the center spindle when playing 45 rpm records. Set the Speed Selector Switch to 33, 45 or 78 rpm according to the record you are playing.
- 6.) Raise the Cue Lever to lift the tone arm off the tone arm rest and move the tone arm to the beginning of the record or to any desired track. This will cause the turntable to start automatically.
- 7.) Gently lower the tone arm by the Cue Control Lever onto the record to start playing. Adjust the **VOLUME**, **BASS BOOST**, and **EQ** setting as desired.
- 8.) The Turntable will stop automatically when the record finishes. To stop the record before it ends, lift and replace the tone arm carefully onto the tone arm rest.

Note: Do not turn or stop the turntable manually. Moving or jarring the Turntable without securing the Tonearm clamp could result in damage to the Tonearm.

AUXILIARY INPUT CONNECTION

Sound from other Audio or Video equipment can be reproduced by connecting the audio output of the equipment to the **AUX IN** jacks of this audio system.

Connect the left/right Auxiliary output, Line output, or Record output jacks of the external equipment to the **LEFT/RIGHT AUX IN** jacks on the back panel of this system.

Press the **AUX/PHONO** button of the audio system to select Auxiliary input sound.

Note: The "AUX" input signal will automatically mute when the Record Player (Turntable) is operating.



CASSETTE RECORDING

To record from the radio or CD changer:

- 1.) Press the **STANDBY (POWER)** button to turn the system 'On'.
- 2.) Press the **TUNER/BAND** or **CD/DISC SKIP** button to select the appropriate function. The **TUNER** or **CD** indicators will appear in the display.

- 3.) Press the **STOP/EJECT** key of Deck **A** to open the cassette door. Insert a blank tape into the slots on the door with the exposed tape facing down and the full reel on the left side. Close the cassette door.

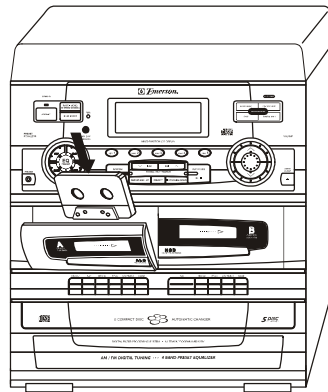

- 4.) Operate the Tuner or CD changer to select the material you wish to record.

Follow the instructions for **LISTENING TO THE RADIO** or **COMPACT DISC PLAYBACK** if necessary.

- 5.) When you are ready to begin recording, depress the **RECORD** key on Deck **A**. (The **PLAY** key will also engage.) The music from the radio or CD will be recorded directly on to the tape.

- Use the **PAUSE** key to stop the tape momentarily to avoid recording unwanted material such as radio commercials.
- You can adjust the **VOLUME** and **BASS BOOST** and preset **EQ** controls during the recording. These controls have no effect on the material being recorded on the tape.

- 6.) When you have finished recording, press the **STOP/EJECT** key to stop the tape.

Press again to open the door and remove the tape. When the tape ends, the **PLAY** and **RECORD** keys are released automatically and the tape motor stops.

- 7.) To record on the other side of the tape, turn the cassette over so that the full reel is again on the left side, and press the **RECORD** key again.



To record from the Turntable:

- 1.) Press the **AUX/PHONO** button to the 'AUX/PHONO' mode.
- 2.) Select the part of the record for recording.
- 3.) Press the **RECORD** Key on Tape Deck **A** to start recording.
- 4.) Press the **STOP/EJECT** Key and place the tone arm on the rest when finished.

IMPORTANT NOTES: *Never try to force the **RECORD** key. If it will not stay down, this means that one of the erase prevention tabs on the cassette is missing.*

Refer to **ABOUT CASSETTE TAPES** on Page 31.

Tape To Tape Recording (Dubbing)

To copy a previously recorded tape:

- 1.) Press **STANDBY (POWER)** button to turn system 'On'.
- 2.) Press **TAPE** button. The **TAPE** Indicator appears in the display.
- 3.) Press the **STOP/EJECT** key on both Decks to open the doors.

Insert the pre-recorded tape in Deck **B** and the blank tape in Deck **A** with exposed tape facing down and full reels on the left. Close the cassette doors.

- 4.) Press the **PAUSE** key and then the **RECORD** key on Deck **A**.

Then press the **PLAY** key on Deck **B**. The **PAUSE** key of Deck **A** will release automatically and both tapes will start simultaneously. All the material on the pre-recorded tape in Deck **B** will be copied onto the blank tape in Deck **A**.

Recording Hint: *Try to use a blank tape that is the same length or just slightly longer than your pre-recorded tape. This will enable you to fit all the material on the copy without excessive 'blank space'.*

High Speed Dubbing

When copying from tape to tape, you can reduce the recording time by pressing the **HI-SPEED DUBBING** button to the '— On' position. Both tapes will move at approximately 2 times the normal speed to cut the recording time in half.

Note: *Turn volume down to avoid unpleasant high speed sound.*



RESET Button

If the unit does not respond to commands from the remote control or from the front panel controls, the internal processor may be “locked” and must be reset. Use a paper clip or similar object to press the **RESET** button which is located inside a pin-hole behind the back panel.

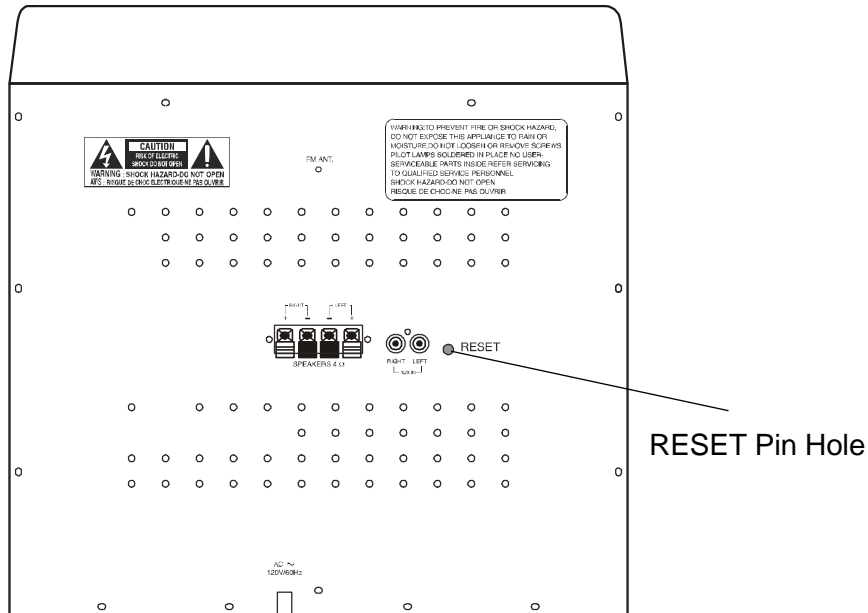

Depress the **RESET** button for a few seconds to clear the memory and restore normal operation.

Notes:

- 1.) *The system must be connected to an AC outlet in order to reset the internal processor.*
- 2.) *After clearing the memory you must re-enter all of your favorite stations in the Tuner Preset Memories.*

PHONES Jack

The Stereo Headphone Jack is located on the left front panel. Connect a set of stereo headphones (not included) to this jack for private listening without disturbing others. The speakers are automatically disconnected when headphones are connected to the headphone jack.

IMPORTANT: *When using headphones always set the volume control to a low level before you put the headphones on. Then put the headphones on and gradually increase the volume to a comfortable listening level.*



CARE AND MAINTENANCE

ABOUT CASSETTE TAPES

Whenever you record on a cassette any previously recorded material is erased as the new material is recorded. To prevent you from accidentally erasing material which you wish to save, blank cassettes are equipped with erase prevention tabs for each side of the tape. If the erase prevention tab for side A is removed, you cannot accidentally record on side A. The record key cannot be depressed if the erase prevention tab on the cassette has been removed.

To prevent accidental erasing on side A of a cassette use a small screw driver or similar tool to break off the erase prevention tab for side A. This prevents the record key from locking.

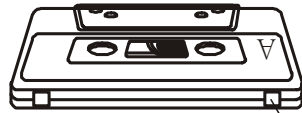

TAB FOR SIDE A.

BREAK OFF TO PREVENT RECORDING

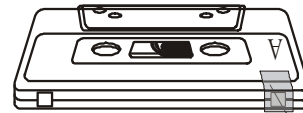

COVER OPENING WITH TAPE
IN ORDER TO RECORD AGAIN.

If later you do wish to record on side A of the cassette, cover the tab opening with a piece of cellophane tape. This will allow the record key to function again.

CASSETTE CARE

Two common causes of trouble experienced when using cassettes are:

- 1.) Tape jamming — Leading to uneven speed in playback, and
- 2.) Tape tangling — Where the tape wraps itself around vital parts of the mechanism.

To reduce the likelihood of these problems occurring, the following precautions should be observed:

- Check that there are no loose layers of tape visible through the cassette center window (see Fig. 1). Take up any loose layers, using a pencil or hexagonal barrelled ballpoint pen, before inserting the cassette into the machine (see Fig. 2).

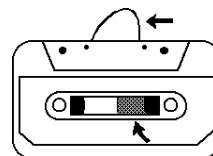

Fig.1



- If the cassette feels “tight” while performing operation shown (see Fig. 2), the tape may be jamming due to “ridges” formed in the winding of the tape (visible through the center window). These may be removed, in most cases, by fast winding of the cassette from one end to the other and back again.

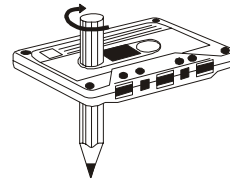

Fig. 2

- Use only well-known brands of tape. Avoid use of C-120 cassettes.

Furthermore, do not expose cassettes to direct sunlight, dust or oil, and do not touch the tape surfaces.

HEAD CLEANING

The tape heads, pinch roller and capstan require periodic cleaning. This removes particles of the metal oxide coating that wear off the tape and accumulate on these parts and impair performance. Switch off the power, press the **STOP/EJECT** key to open the cassette door, and press the **PLAY** key. Clean the tape heads, pinch roller and capstan with a soft cloth or cotton pad dampened in isopropyl alcohol or special tape head cleaner.

DECK A

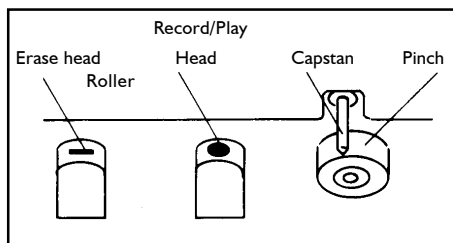

DECK B

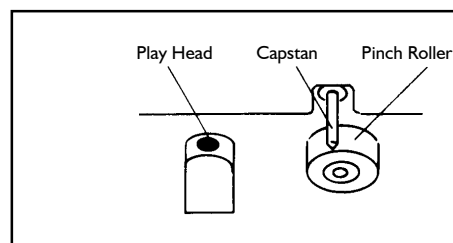

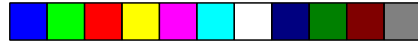

COMPACT DISC CARE

- To remove a disc from its storage case, press down on the center of the case and lift the disc out, holding it carefully by the edges.

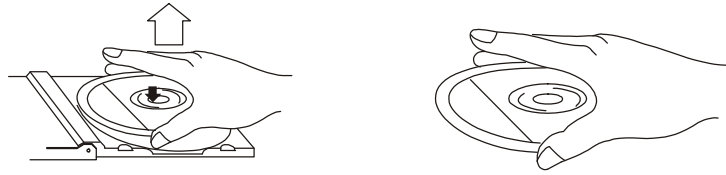

- Fingerprints and dust should be carefully wiped off the disc's recorded surface with a soft cloth. Unlike conventional records, compact discs have no grooves to collect dust and microscopic debris, so gently wiping with a soft cloth should remove most particles. Wipe in a straight line from the inside to the outside of the disc. Small dust particles and light stains will have absolutely no effect on reproduction quality.

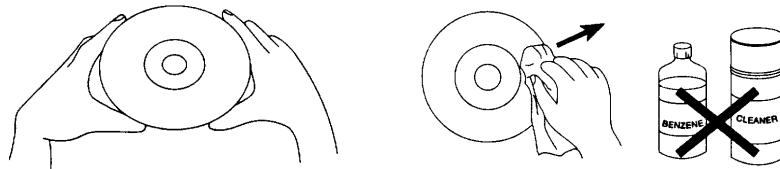

- Clean the disc periodically with a soft, lint-free, dry cloth. Never use detergents or abrasive cleaners to clean the disc. If necessary, use a CD cleaning kit.
- Never write on or affix labels to the surface of compact discs.



CARE OF THE CABINETS

- If the cabinets become dusty wipe them with a soft dry dust cloth. Do not use any wax or polish sprays on the cabinets.
- If the front panel becomes dirty or smudged with fingerprints it may be cleaned with a soft cloth slightly dampened with a mild soap and water solution. Never use abrasive cloths or polishes as these will mar the finish of your unit.

Caution: *Never allow any water or other liquids to get inside the unit while cleaning.*

	TO FIND THE LOCATION AND PHONE NUMBER OF YOUR NEAREST SERVICE CENTER PERMITTED TO PERFORM WARRANTY...
CALL TOLL FREE: 1-800-695-0098	
FOR ADDITIONAL SET-UP OR OPERATING ASSISTANCE PLEASE CALL: 1-800-898-9020	
FOR CUSTOMER SERVICE, PLEASE WRITE TO: Emerson Radio Corp., Consumer Affairs Dept., 5101 Statesman Drive, Irving, TX 75063.	



LIMITED WARRANTY

Emerson Radio Corp. warrants manufacturing defects in original material, including original parts and workmanship, under normal use and conditions, for a period of ninety (90) days from the date of original purchase in the U.S. With your dated proof of purchase, we will provide repair service at no charge for labor and parts at an authorized Depot Repair Facility, or replace the product in our discretion. For repair or replacement, pack your unit in a padded box, enclose your check or money order payable to Emerson Radio Corp. in the amount of \$9.00 (not required by California residents) to cover shipping and handling costs, and enclose a copy of your proof of purchase. Send your unit to:

Emerson Radio Corp.,
5101 Statesman Drive,
Irving, TX 75063.

This warranty does not cover damage from negligence, misuse, abuse, accident, failure to follow operating instructions, commercial use, rental, repairs by an unauthorized facility, or products purchased, used, serviced or damaged outside of the United States.

THIS WARRANTY GIVES YOU SPECIFIC LEGAL RIGHTS, AND YOU MAY ALSO HAVE OTHER RIGHTS WHICH VARY FROM STATE TO STATE.

AU898M

The serial number of your system is located on a label on the back panel. Please take a moment to locate the serial number and write the number in the space provided below. You may need this number for insurance purposes in the event your set is damaged or lost. You may also be asked to provide this number when requesting service.

Model Number: MS9923TT

Serial Number: _____



EMERSON
Part No. 16-2862B
602-01

Printed in China