



1100W MICROWAVE OVEN AND GRILL

OWNER'S MANUAL **MWG9115SL**

Visit our web site at "www.emersonradio.com"

UNAUTHORIZED MODIFICATIONS TO THIS DEVICE COULD VOID MANUFACTURER'S WARRANTY.

PRECAUTIONS TO AVOID POSSIBLE EXPOSURE TO EXCESSIVE MICROWAVE ENERGY

- (a) Do not attempt to operate this oven with the door open since open-door operation can result in harmful exposure to microwave energy.
It is important not to defeat or tamper with the safety interlocks.
- (b) Do not place any object between the oven front face and the door or allow soil or cleaner residue to accumulate on sealing surfaces.
- (c) Do not operate the oven if it is damaged.
It is particularly important that the oven door close properly and that there is no damage to the :
(1) door (bent), (2) hinges and latches (broken or loosened), (3) door seals and sealing surfaces.
- (d) The oven should not be adjusted or repaired by anyone except properly qualified service personnel.
- (e) For more safety tips, visit following FDA web site:
<http://www.fda.gov/cdrh/radhealth/products/microwave.html>

CONTENTS

Precautions to Avoid Possible Exposure to Excessive Microwave Energy.....	1	Auto Cook Menu Chart	16
Important Safety Instructions	2	Memory	17
Safety Precautions	3	Child Lock	18
Federal Communications Commission Radio Frequency Interference Statement.....	4	Inquiry.....	18
Grounding Instructions	5	Cooking Guide	19
Installation	5	The Principles of Microwave Cooking ...	19
Care of Your Microwave Oven.....	6	Food Characteristics	19
How to Use Your Microwave Oven Safely	6	Microwave Techniques.....	19
Location of Controls	7	Hot Snacks and Appetizers.....	20
Operation.....	8	Seafood.....	20
Setting the Clock.....	8	Meats	21
Weight Defrost	9	Poultry	21
Time Defrost.....	9	Eggs & Cheese.....	22
Cooking In One Stage.....	10	Soups.....	22
Kitchen Timer.....	10	Vegetables	23
Cooking in Two Stages.....	11	Casseroles.....	23
Defrosting/Cooking in Two Stages.....	12	Sauces.....	24
Quick Cook.....	12	Sandwiches.....	24
Grilling Cooking.....	13	Pasta and Grains.....	25
Combination Cooking.....	13	Cereals.....	25
Auto Cook.....	14	Convenience Foods.....	25
Meat Function.....	14	Desserts.....	26
Chicken Menu.....	14	Specifications	27
Beef Menu	15	Before You Call for Service	27
Pork Menu	15	Limited Warranty.....	28

IMPORTANT SAFETY INSTRUCTIONS

When using electrical appliances, basic safety precautions should be followed, including the following:

WARNING – To reduce the risk of burns, electric shock, fire, injury to persons, or exposure to excessive microwave energy:

1 Read all instructions before using this appliance.

2 Read and follow the specific
“PRECAUTIONS TO AVOID POSSIBLE EXPOSURE TO EXCESSIVE MICROWAVE ENERGY” found on page 1.

3 This appliance must be grounded. Connect only to a properly grounded outlet. See

“GROUNDING INSTRUCTIONS”

found on page 5.

4 Install or locate this appliance only in accordance with the provided installation instructions.

5 Some products such as whole eggs and sealed containers (for example, closed glass jars) may explode and should not be heated in this oven.

6 Use this appliance only for its intended use as described in this manual. Do not use corrosive chemicals or vapors in this appliance. This type of oven is specifically designed to heat, cook, or dry food. It is not designed for industrial or laboratory use.

7 As with any appliance, close supervision is necessary when used by children.

8 Do not operate this appliance if it has a damaged cord or plug, if it is not working properly, or if it has been damaged or dropped.

9 This appliance should be serviced only by qualified service personnel. Contact the nearest authorized service facility for examination, repair or adjustment.

10 Do not cover or block any openings on this appliance.

11 Do not store or use this appliance outdoors. Do not use this product near water, for example, near a kitchen sink, in a wet basement, or near a swimming pool, or similar location.

12 Do not immerse cord or plug in water.

13 Keep cord away from heated surfaces.

14 Do not let cord hang over edge of table or counter.

15 When cleaning surfaces of door and oven that come together when closing the door, use only mild, non-abrasive soaps or detergents applied with a sponge or soft cloth.

16 To reduce the risk of fire in the oven cavity:

- (a) Do not overcook food. Carefully attend appliance if paper, plastic, or other combustible materials are placed inside the oven to facilitate cooking.
- (b) Remove wire twist-ties from paper or plastic bags before placing bag in oven.
- (c) If materials inside the oven should ignite, keep oven door closed, turn oven off, and disconnect the power cord, or shut off power at the fuse or circuit breaker panel.
- (d) Do not use the cavity for storage purposes. Do not leave paper products, cooking utensils, or food in the cavity when not in use.

17 Do not use this microwave oven to heat corrosive chemicals (for example, sulfides and chlorides). Vapors from such corrosive chemicals may interact with the contact and

SAVE THESE INSTRUCTIONS

IMPORTANT SAFETY INSTRUCTIONS

springs of the safety interlock switches, thereby rendering them inoperable.

- 18 Keep the waveguide cover clean at all times. Wipe the oven interior with a soft damp cloth after each use. If you leave grease or fat anywhere in the cavity it may overheat, smoke or even catch fire when next using the oven.
- 19 Never heat oil or fat for deep frying as you cannot control the temperature and doing so may lead to overheating and fire.
- 20 Liquids, such as water, coffee, or tea are able to be overheated beyond the boiling point without appearing to be boiling due to surface tension of the liquid. Visible bubbling or boiling when container is removed from

the microwave oven is not always present. THIS COULD RESULT IN VERY HOT LIQUIDS SUDDENLY BOILING OVER WHEN A SPOON OR OTHER UTENSIL IS INSERTED INTO THE LIQUID. To reduce the risk of injury to persons:

1. Do not overheat the liquid.
2. Stir the liquid both before and halfway through heating it.
3. Do not use straight-sided containers with narrow necks.
4. After heating, allow the container to stand in the microwave oven for a short time before removing the container.
5. Use extreme care when inserting a spoon or other utensil into the container.

SAFETY PRECAUTIONS

General Use

- 1 Do NOT attempt to tamper with or make any adjustments or repairs to door, control panel or any other part of the oven. Do NOT remove outer panel from oven. Repairs should only be done by qualified service personnel.
- 2 Do NOT operate the oven empty. The microwave energy will reflect continuously throughout the oven if no food or water is present to absorb energy.
- 3 If a fire occurs in the oven, touch the Stop/Clear button and LEAVE THE DOOR CLOSED. Disconnect the power cord, or shut off power at the fuse or circuit breaker panel.
- 4 Do NOT attempt to dry clothes, newspapers or other materials in the oven. They may catch on fire.
- 5 Do NOT use recycled paper products. Recycled paper towels, napkins and waxed paper can contain metal flecks which may cause arcing or ignite. Paper products containing nylon or nylon filaments should be avoided, as they may ignite.
- 6 Some styrofoam trays (like those that meat is packaged on) have a thin strip of metal embedded on the bottom. When microwaved, the metal can burn the floor of the oven or ignite a paper towel.
- 7 Avoid inserting nails, wire, etc. through any holes in the unit during operation. Never insert a wire, nail or any other metal objects through the holes on the cavity or any other holes or

gaps, because such objects may cause electric shock and microwave leakage.

Utensils

- 1 METAL CONTAINERS or dishes with metallic rims should not be used. Arcing may occur.
- 2 METAL TWIST-TIES may not be used in the microwave oven.
- 3 Do NOT use SEALED JARS or NARROW NECK bottles for cooking or reheating. They may shatter.
- 4 Do NOT use CONVENTIONAL THERMOMETERS in the microwave oven. They may cause arcing.
- 5 Remove PLASTIC STORE WRAPS before cooking or defrosting foods in the oven.
- 6 For FURTHER INFORMATION on proper cooking utensils, refer to the **COOKING GUIDE** on page 19.

Food

- 1 Never use your microwave oven for HOME CANNING. The oven is not designed to permit proper canning. Improperly canned food may spoil and be dangerous to consume.
- 2 COOKING TIMES given in the cooking guide are approximate. Factors that may affect cooking are starting temperature, altitude, volume, size and shape of food and utensils used. As you become familiar with the oven, you will be able to adjust for these factors.

SAFETY PRECAUTIONS

- 3 It is better to UNDERCOOK RATHER THAN OVERCOOK foods. If food is undercooked, it can always be returned to the oven for further cooking. If food is overcooked, nothing can be done. Always start with minimum cooking times.
- 4 SMALL QUANTITIES of food or foods with LOW MOISTURE content can burn, dry out or catch on fire if cooked too long.
- 5 Do NOT boil eggs in their shell. Pressure may build up and the eggs may explode.
- 6 Potatoes, apples, egg yolks, whole acorn squash and sausage are some examples of foods with NONPOROUS SKINS. These must be pierced before cooking to prevent bursting.
- 7 POPCORN must be popped in a microwave corn popper. Microwave popped corn produces a lower yield than conventional popping. Do not use oven for popcorn unless popped in a microwave approved popcorn utensil or unless it's commercially packaged and recommended especially for microwave ovens. Do not use oil unless specified by the manufacturer.
- 8 Do NOT attempt to deep fat fry in your oven.
- 9 HEATED LIQUIDS can ERUPT if not mixed with air. Do not heat liquids in your microwave oven without first stirring.
- 10 Do NOT use paper towels to cover food as they can ignite.

FEDERAL COMMUNICATIONS COMMISSION RADIO FREQUENCY INTERFERENCE STATEMENT

WARNING: This equipment generates and uses ISM frequency energy and if not installed and used properly, in strict accordance with the manufacturer's instructions, may cause interference to radio and television reception.

It has been type-tested and found to comply with limits for an ISM Equipment pursuant to part 18 of FCC Rules, which are designed to provide reasonable protection against such interference in a residential installation.

However, there is no guarantee that interference will not occur in a particular installation. If this equipment does cause interference to radio or television reception, which can be determined by turning the equipment off and on, the user is encouraged to try to correct the interference by one or more of the following:

- * Reorient the receiving antenna of radio or television.
- * Relocate the Microwave oven with respect to the receiver.
- * Move the microwave oven away from the receiver.
- * Plug the microwave oven into a different outlet so that microwave oven and receiver are on different branch circuits.

THE MANUFACTURER is not responsible for any radio or TV interference caused by UNAUTHORIZED MODIFICATION to this microwave oven. It is the responsibility of the user to correct such interference.

ARCING

If you see arcing, press **STOP/CLEAR** button and correct the problem.

Arcing is the microwave term for sparks in the oven.

Arcing is caused by:

- * Metal or foil touching the side of the oven.
- * Foil not molded to food (upturned edges act like antennas).
- * Metal, such as twist-ties, poultry pins, or gold rimmed dishes, in the microwave.
- * **Recycled paper towels containing small metal pieces being used in the microwave.**
- * **Burnt (carbonated) food residue or grease spattered inside of cabinet.**

DO NOT LEAVE OVEN UNATTENDED WHILE COOKING!

SAVE THESE INSTRUCTIONS

GROUNDING INSTRUCTIONS

This appliance must be grounded. In the event of an electrical short circuit, grounding reduces the risk of electric shock by providing an escape wire for the electric current. This appliance is equipped with a cord having a grounding wire with a grounding plug. The plug must be inserted into an outlet that is properly installed and grounded.

WARNING: Improper use of the grounding plug can result in a risk of electric shock. Consult a qualified electrician or service personnel if the grounding instructions are not completely understood, or if doubt exists as to whether the appliance is properly grounded. If it is necessary to use an extension cord, use only a three wire extension cord that has a three blade grounding plug, and a three slot receptacle that will accept the plug on the appliance. The marked rating of the extension cord should be equal to or greater than the electrical rating of the appliance.

INSTALLATION

- 1. Steady, flat location:** When positioning the microwave oven, it should be set on a steady, flat surface.
- 2. Ventilation:** Do not block air vents. If they are blocked during operation, the oven may overheat and eventually cause oven failure. For proper ventilation, keep three inches of space between the oven's top, sides, rear and the area where the unit is to be installed.
- 3. Radio and TV reception:** Poor television reception and radio interference may result if the oven is located close to a TV, radio, antenna, or antenna wire. Position the oven as far from them as possible.
- 4. Temperature and moisture:** Keep the oven away from hot air, steam or splashing liquids when choosing a place to locate it, otherwise, the unit's operation may be adversely affected, causing it to break down.
- 5. Power supply:**
 - Check your local power source. This microwave oven requires a 120V, 60Hz, 15Amp power supply.
 - Use a receptacle that will accept the ground prong.
 - (a) A short power supply cord is provided to reduce the risks resulting from becoming entangled in or tripping over a longer cord.
 - (b) Longer cord sets or extension cords are available and may be used if care is exercised in their use.
 - (c) If a long cord or extension cord is used, (1) the marked electrical rating of the cord set or extension cord should be at least as great as the electrical rating of the appliance, (2) the extension cord must be a grounding-type 3-wire cord, and (3) the longer cord should be arranged so that it will not drape over the counter top or tabletop where it can be pulled on by children or tripped over unintentionally.
- 6. Examine the oven for any damage such as:** Dents, a misaligned door, broken door or a dent in the cavity. If any of the above are visible, DO NOT INSTALL THE UNIT. Notify the dealer immediately.

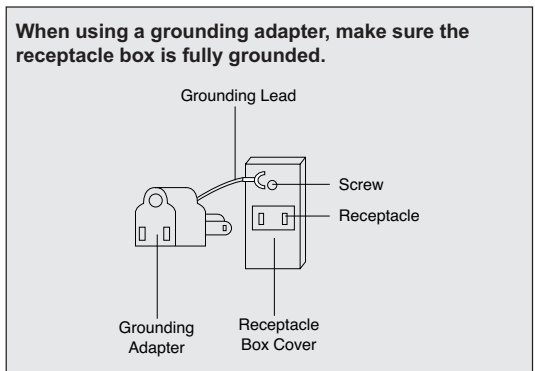
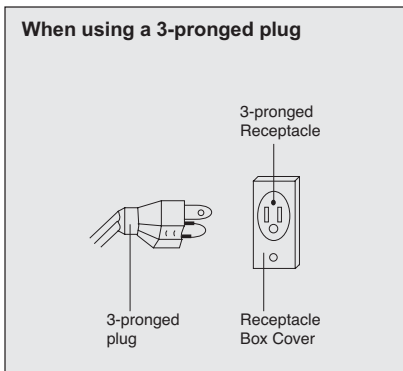

CARE OF YOUR MICROWAVE OVEN

- 1 Disconnect the AC plug from the outlet before cleaning.
- 2 Keep the inside of the oven clean. When food spatters or spilled liquids adhere to oven walls, wipe with a damp cloth. Mild detergent may be used if the oven gets very dirty. The use of harsh detergent or abrasives is not recommended.
- 3 The outside oven surface should be cleaned with soap and water, rinsed and dried with a soft cloth. To prevent damage to the operating parts inside the oven, water should not be allowed to seep into the ventilation slots.
- 4 If the Control Panel becomes dirty or wet, clean with a soft, dry cloth. Do not use harsh detergents or abrasives on Control Panel.
- 5 If steam accumulates on both sides of the oven door, wipe with a soft cloth. This may occur when the microwave oven is operated under high humidity conditions and this is not an indication of a malfunction in the unit.
- 6 It is occasionally necessary to remove the glass tray for cleaning. Wash the tray in warm, sudsy water or in a dishwasher.

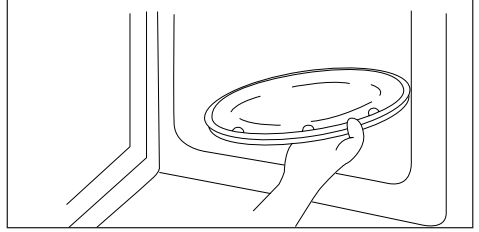

Roller Guide

- 1 The ROLLER GUIDE and oven floor should be cleaned frequently to prevent excessive noise.
- 2 The ROLLER GUIDE MUST ALWAYS be used for cooking together with the Glass Tray.

Glass Tray

- 1 Do NOT operate the oven without the Glass Tray in place.
- 2 Do NOT use any other Glass Tray with this oven.
- 3 If the Glass Tray is hot, ALLOW IT TO COOL before cleaning it or placing it in water.
- 4 Do NOT cook directly on the Glass Tray.

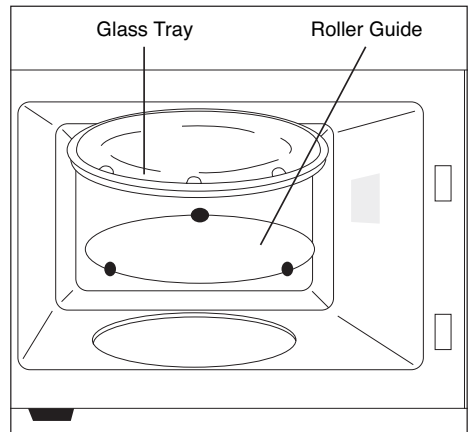

HOW TO USE YOUR MICROWAVE OVEN SAFELY

Although your oven is provided with safety features, it is important to observe the following:

- a) It is important not to defeat or tamper with safety interlocks.
- b) Do not place any object between the oven face and the door or allow residue to accumulate on sealing surfaces. Wipe the sealing area frequently with a mild detergent, rinse and wipe dry. Never use abrasive powders or pads.
- c) When opened, the door must not be subjected to strain, for example, a child hanging on an open door or any load which could cause the oven to fall forward and cause injury and damage to the door. Do not operate the oven if it is damaged, until it has been repaired by a qualified person. It is particularly important that the oven door close properly and that there is no damage to the following:
 - (1) Door (bent), (2) Hinges and Latches (broken or loosened), (3) Door seals and sealing surfaces.
- d) The oven should not be adjusted or repaired by anyone except properly qualified service personnel.

LOCATION OF CONTROLS

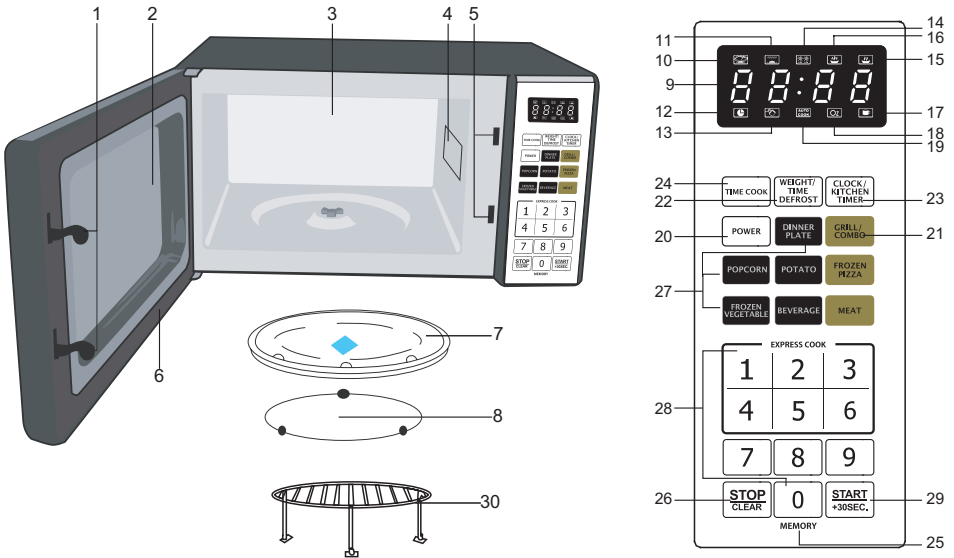

1. **Door Latches** - When the door is closed, they will automatically lock shut. If the door is opened while the oven is operating, the magnetron will automatically shut off.
2. **Door Screen**-Allows viewing of food. The screen is designed so that light can pass through, but not the microwaves.
3. **Oven Cavity**
4. **Spatter Shield**-Protects the microwave outlet from splashes of cooking foods.
5. **Safety Interlock System**-Prevents the oven from operating while the door is opened.
6. **Door Seal**- The door seal maintains the microwaves within the oven cavity and prevents microwave leakage.
7. **Glass Cooking Tray**- Made of special heat resistant glass. The tray must always be in proper position before operating the oven. Do not cook food directly on the tray.
8. **Roller Guide**- Supports the glass cooking tray. Must always be in proper position before operating the oven.
9. **Display**
10. **Microwave Indicator**
11. **Grill Indicator**
12. **Clock Indicator**
13. **Child Lock Indicator**
14. **Defrost Indicator**
15. **Low Cook Indicator**
16. **High Cook Indicator**
17. **Cup Indicator**
18. **Ounce Indicator**
19. **Auto Cook Indicator**
20. **Power Button**-Used to set a power level.
21. **Grill/Combo Button**-Used to set grilling or combination cooking.
22. **Weight/Time Defrost Button**-Used to set the oven to estimate the defrosting time or by weight entered.
23. **Clock/Kitchen Timer Button**- Used to set the kitchen timer function.
24. **Time Cook Button** - Used to set the cooking according to the desired power and time.
25. **Memory Button**- Used to set the memory function.
26. **Stop/Clear Button** -Use to stop and/or clear a cooking program.
27. **Auto Cook Menu**- Used to select an Auto Cook program.
28. **Number Button** - Used to enter the cooking time, kitchen timer, etc. Number keys 1-6 are also used for Express Cook Function.
29. **Start/+30Sec. Button** - Press to start a cooking program.
30. **Grill Rack**

The accessible surface may be hot during operation.



Alert: Please clean microwave oven often. Failure to do so may create a fire hazard and void the warranty.

OPERATION

SETTING THE CLOCK

When first plugged in, the oven will display “0:00”. Set the time as follows:

1

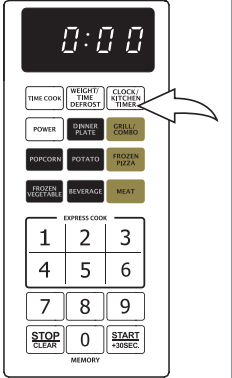

With the oven **NOT** cooking, press the **CLOCK / KITCHEN TIMER** button; the first hour digit will blink.

2

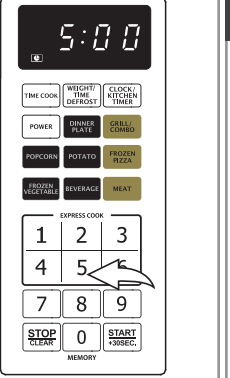

Press two Number buttons to set the current hour. Then press two Number buttons to set the current minute. Two buttons must be pressed, i.e. "0" , "5" for 5.

3

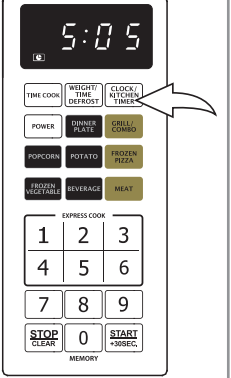

Press the **CLOCK / KITCHEN TIMER** button; the display will show the present time. After the clock has been set, the time will appear with blinking colon, unless the oven is cooking or defrosting.

NOTES:

- To reset the present time in the display window, press the **CLOCK/KITCHEN TIMER** button and reset.
- If you make a mistake when setting the time, press the **STOP/CLEAR** button.
- To recall the actual time while the oven is cooking or defrosting, simply press the **CLOCK / KITCHEN TIMER** button and the display will show the actual time for three seconds.

POWER

This microwave has eleven power levels to choose from. To change, press **POWER** button repeatedly.

Level	10	9	8	7	6	5	4	3	2	1	0
Power	100%	90%	80%	70%	60%	50%	40%	30%	20%	10%	0%

OPERATION (CONTINUED)

WEIGHT DEFROST

Weight Defrost lets you easily defrost foods by eliminating guesswork in determining defrosting time. The minimum weight for Auto Weight Defrost is 4 oz. and maximum weight is 100 oz.

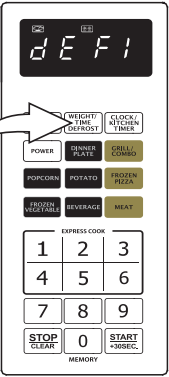
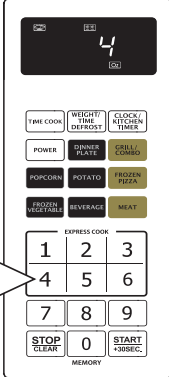
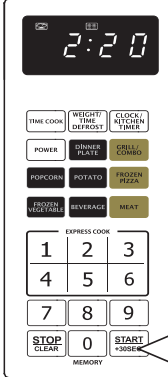
1  <p>Press the WEIGHT/TIME DEFROST button once.</p>	2  <p>Press the Number button to set the desired weight, in ounces.</p>	3  <p>Press the START/+30SEC. button to start defrosting; the unit start counting down the remaining defrosting time and beep five times when completed.</p>
--	--	--

TIME DEFROST

Time Defrost will automatically set the oven to defrost at a time set by the user.

The minimum time for Time Defrost is one second. The maximum time is 99 minutes, 99 seconds.

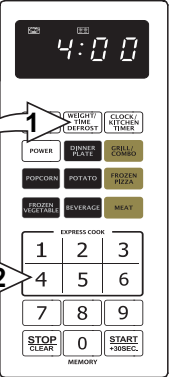
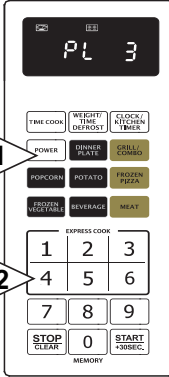
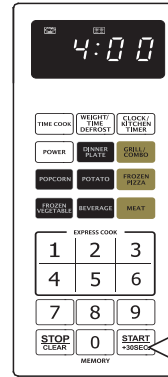
1  <p>Press WEIGHT/TIME DEFROST button ① twice. Then press the Number buttons ② to set the desired time.</p>	2  <p>The default microwave power is power 3. To change, press the POWER button ① once followed by the Number buttons ② of the desired power level.</p>	3  <p>Press the START/+30SEC. button to start defrosting; the unit start counting down the remaining defrosting time and beep five times when completed.</p>
---	--	---

OPERATION (CONTINUED)

COOKING IN ONE STAGE

The maximum cooking time is 99 minutes, 99 seconds.

1

Press the **TIME COOK** button **1**
Press the Number buttons **2** to set the desired cooking time.

2

Press the **POWER** button **1**
"PL 10" will light in the display to indicate power level 10. Press the Number buttons **2** to select a different power level.

3

Press the **START/+30SEC.** button to start cooking; the unit will start counting down the remaining cooking time and beep five times when completed.

KITCHEN TIMER

Allows the timer to be set, but no microwaves produced.

1

Press **CLOCK / KITCHEN TIMER** button twice.

2

Press two Number buttons to set the Timer minutes, and then two Number buttons to set the Timer seconds.

3

Press the **START/+30SEC.** button to start counting down the remaining Timer time. The unit will beep five times when completed.

OPERATION (CONTINUED)

COOKING IN TWO STAGES

The maximum cooking time is 99 minutes, 99 seconds.

1

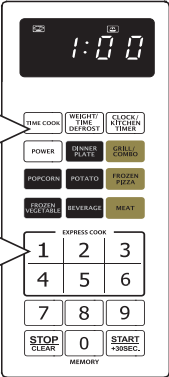

Press the **TIME COOK** button ①
Then press the Number buttons ② to set the desired cooking time.

2

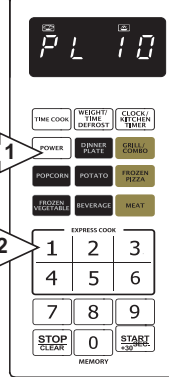

Press the **POWER** button ①
“PL 10” will light in the display to indicate power level 10. Then press the Number buttons ② to select a different power level for the first stage.

3

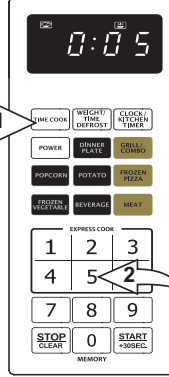

Press the **TIME COOK** button ①
Then press the Number buttons ② to set the desired cooking time.

4

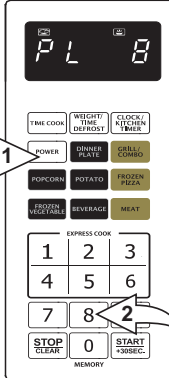

Press the **POWER** button ①
“PL 10” will light in the display to indicate power level 10. Then press the Number buttons ② to select a different power level for the second stage.

5

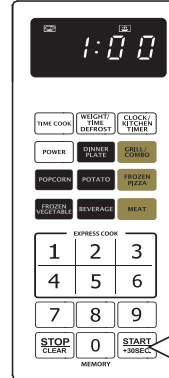

Press the **START +30SEC.** button to start cooking for the first stage; the unit will start counting down the remaining cooking time and beep once between stages, and then perform the second stage cooking.

OPERATION (CONTINUED)

DEFROSTING/COOKING IN TWO STAGES

The minimum weight for Auto Weight Defrost is 4 oz. and maximum weight is 100 oz.

1

Press the **WEIGHT/TIME DEFROST** button once.

2

Press the Number buttons to set the desired weight, in ounces. Set the next stage by following steps 3 and 4 on the previous page.

3

Press the **START/+30SEC.** button to start defrosting (the first stage); the unit will start counting down the remaining steps 3 and 4 on the previous page, and then perform the second stage cooking.

QUICK COOK

1

Press the Number buttons 1-6 and the microwave will immediately start cooking at high power for the selected time. For example, press "2" to cook for two minutes.

2

Press the **START/+30SEC.** button and the microwave will immediately start cooking at high power for 30 seconds. Each additional press will increase the cooking time by 30 seconds.

STOP/CLEAR BUTTON

- To stop cooking or clear a cooking program, simply press the **STOP/CLEAR** button once to stop cooking, or twice to cancel a cooking program.
- Always press the **STOP/CLEAR** button before opening the door.

OPERATION (CONTINUED)

GRILLING COOKING

The maximum cooking time is 99 minutes, 99 seconds.

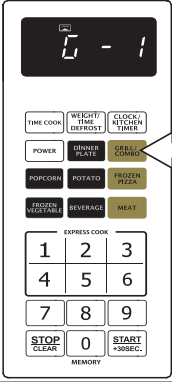
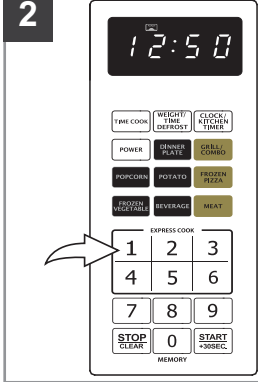
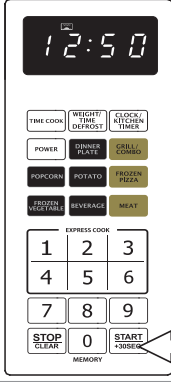
1  <p>Press the GRILL/COMBO button once.</p>	2  <p>Press the Number buttons to set the desired cooking time.</p>	3  <p>Press the START/+30SEC. button to start cooking; the unit will start counting down the remaining cooking time and beep five times when completed.</p>
--	--	---

COMBINATION COOKING (MICROWAVE + GRILLING)

The maximum cooking time is 99 minutes, 99 seconds.

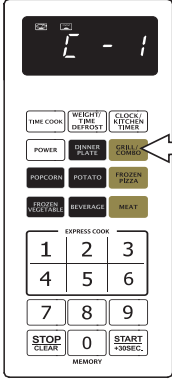
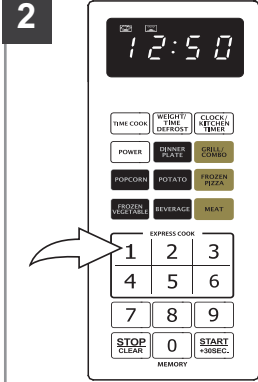
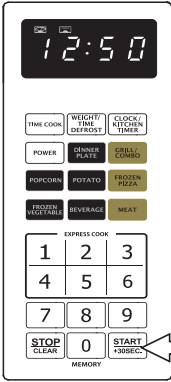
1  <p>Press the GRILL/COMBO button two or three times to choose "Combination 1" (55% Microwave + 45% Grill) or "Combination 2" (36% Microwave + 64% Grill).</p>	2  <p>Press the Number buttons to set the desired cooking time.</p>	3  <p>Press the START/+30SEC. button to start cooking; the unit will start counting down the remaining cooking time and beep five times when completed.</p>
--	---	--

OPERATION (CONTINUED)

AUTO COOK

Auto cook lets you easily cook items in the oven, as it will automatically set the times and power levels to give better results than one power only cooking.

1

Press the desired **AUTO COOK** button (POPCORN, POTATO, FROZEN PIZZA, BEVERAGE, DINNER PLATE , FROZEN VEGETABLE OR MEAT).

2

Repeatedly press the desired **AUTO COOK** button to select the desired weight/portion (see chart on page 16).

3

Press the **START/+30SEC.** button to start cooking; The unit will start counting down the remaining cooking time and beep five times when completed.

MEAT FUNCTION

Chicken Menu

1

Press **MEAT** button ① once. Then press **START/+30SEC.** button ② to confirm.

2

Press **MEAT** button repeatedly to select a different weight, in ounces.

3

Press the **START/+30SEC.** button to start cooking; The unit will start counting down the remaining cooking time and beep five times when completed.

OPERATION (CONTINUED)

Beef Menu

1	2	3
<p>Press MEAT button ① twice. Then press START/+30SEC. button ② to confirm.</p>	<p>Press MEAT button repeatedly to select a different weight, in ounces.</p>	<p>Press the START/+30SEC. button to start cooking; The unit will start counting down the remaining cooking time and beep five times when completed.</p>

Pork Menu

1	2	3
<p>Press MEAT button ① three times. Then press START/+30SEC. button ② to confirm.</p>	<p>Press MEAT button repeatedly to select a different weight, in ounces.</p>	<p>Press the START/+30SEC. button to start cooking; The unit will start counting down the remaining cooking time and beep five times when completed.</p>

NOTE: MEAT (Chicken/Beef/Pork) only

After around 2/3 of the selected cooking time, the oven will beep twice, indicating to the user to turn food over for even cooking.

OPERATION (CONTINUED)

AUTO COOK MENU CHART

Button		Press	Weight/Portion	Cooking Time
Dinner Plate		Once	9.0 Oz	2 min.
		Twice	12.0 Oz	2 min.30 sec.
		Three Times	18.0 Oz	3 min.30 sec.
Popcorn		Once	1.75 Oz	1 min.15 sec.
		Twice	3.0 Oz	1 min.50 sec.
		Three Times	3.5 Oz	2 min.
Potato (8 oz/piece)		Once	1 PCS	4 min.30 sec.
		Twice	2 PCS	7 min.
		Three Times	3 PCS	9 min.30 sec.
Frozen Pizza		Once	4.0 Oz	6 min.
		Twice	8.0 Oz	8 min.
		Three Times	14 Oz	11 min.
Frozen Vegetable		Once	4.0 Oz	2 min.40 sec.
		Twice	8.0 Oz	4 min.40 sec.
		Three Times	16.0 Oz	7 min.40 sec.
Beverage (120 ml/cup)		Once	1 Cup	55 sec.
		Twice	2 Cups	1 min.50 sec.
		Three Times	3 Cups	2 min.45 sec.
Meat	Chicken	Once	14.0 Oz	20 min.
		Twice	22.0 Oz	25 min.
		Three Times	30.0 Oz	30 min.
		Four Times	38.0 Oz	35 min.
		Five Times	46.0 Oz	40 min.
	Beef	Once	12.0 Oz	10 min.
		Twice	19.0 Oz	14 min.
		Three Times	26.0 Oz	18 min.
		Four Times	33.0 Oz	21 min.
		Five Times	40.0 Oz	24 min.
	Pork	Once	6.0 Oz	10 min.
		Twice	11.0 Oz	14 min.
		Three Times	16.0 Oz	18 min.
		Four Times	21.0 Oz	21 min.
		Five Times	26.0 Oz	24 min.

OPERATION (CONTINUED)

MEMORY

Memory is used to preset a cooking function in memory location 1-3.

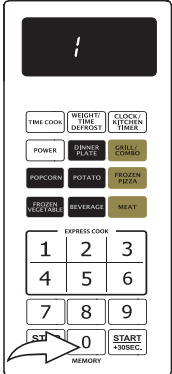
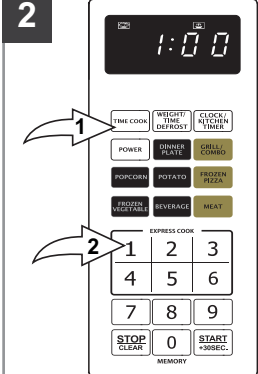
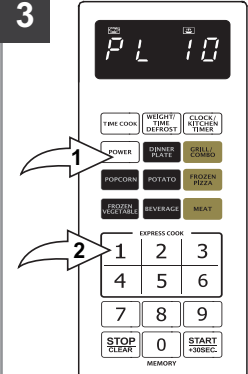
1 	2 	3 
Repeatedly press the MEMORY button to select a memory location (1 to 3).	Press the TIME COOK button 1 Then press the Number buttons 2 to set the desired cooking time.	Press the POWER button 1 "PL 10" will light in the display to indicate power level 10. Then press the Number buttons 2 to select a different power level. Repeat step 2 and 3 to perform a second stage, if desired.

MEMORY RECALL

Used to select a memory preset.

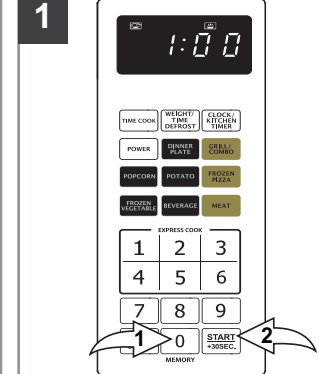
4 	1 
Press the START/+30SEC. button once to save your settings into the chip. To save in memory press STOP/CLEAR button or press START/+30SEC. button once again and cooking will start.	Repeatedly press the MEMORY button 1 to select a preset (1-3). Then press the START/+30SEC. button 2 to start the cooking operation.

OPERATION (CONTINUED)

CHILD LOCK

The Child Lock prevents unwanted oven operation by small children. The oven can be set so that the control panel is deactivated or locked.

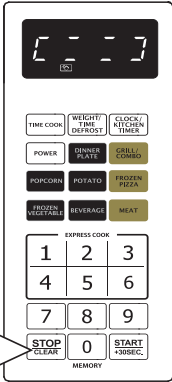
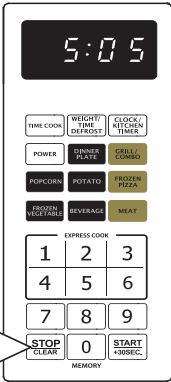
1		2	
<p>TO ACTIVE: Press and hold the STOP/CLEAR button for three seconds (when the time appears in the display); the unit beeps once and the display will appear as shown above and no buttons can be pressed.</p>		<p>TO DEACTIVATE: Press and hold the STOP/CLEAR button for three seconds; the unit beeps once and the current time will appear in the display.</p>	

INQUIRY

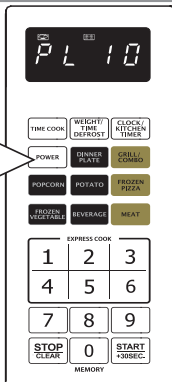
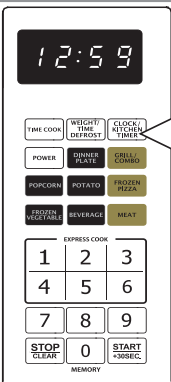
1		2	
<p>During cooking, press the POWER button to display the current power level for three seconds.</p>		<p>During cooking, press the CLOCK/KITCHEN TIMER button to display the current time for three seconds.</p>	

COOKING GUIDE

THE PRINCIPLES OF MICROWAVE COOKING

Microwaves are a form of high frequency radio waves similar to those used by a radio including AM, FM and CB. Electricity is converted into microwave energy by the magnetron tube. From the magnetron tube, microwave energy is transmitted to the oven where it is reflected, transmitted and absorbed by the food.

Reflection: Microwaves are reflected by metal just as a ball is bounced off of a wall. For this reason, metal utensils are not suitable for use in the microwave. A combination of stationary interior walls and a rotating metal turntable or stirrer fan helps assure that the microwaves are well distributed within the oven cavity to produce even cooking.

Transmission: Microwaves pass through some materials such as paper, glass and plastic much like sunlight shining through a window. Because these substances do not absorb or reflect the microwave energy, they are ideal materials for microwave oven cooking containers.

Absorption: During cooking, microwaves will be absorbed by food. They penetrate to a depth of about 3/4 to 1 1/2 inches. Microwave energy activates the molecules in the food (especially water, fat and sugar), and heat is produced. If you vigorously rub your hands together, you will feel heat produced by friction. The internal cooking of larger foods is done by conduction as the heat which is produced by friction is conducted to the middle of the food. Foods also continue to cook by conduction during standing time.

FOOD CHARACTERISTICS

Quantity: The amount of food placed in a microwave oven has a direct effect on the cooking time. Small amounts of food or liquid require less cooking time than larger amounts of the same substance. As quantity increases, concentration decreases.

Size: Small pieces cook faster than large ones. To speed cooking, cut pieces smaller than two inches (5 cm), so microwaves can penetrate to the middle from all sides. Pieces which are similar in size and shape cook more evenly.

Shape: Many foods are uneven, like a chicken, ribs or broccoli. The thin parts will cook faster than the thick parts, while uniformly thick foods cook evenly. To compensate for irregular shapes, place thin pieces toward the center of the dish and thicker pieces toward the edge of the dish.

Starting Temperature: Frozen or refrigerated foods take longer to cook than foods at room temperature.

Bone and Fat: Because bones conduct heat, the side of the meat the bone is on will cook first, while boneless cuts cook slower but more evenly. Fat attracts microwaves. The middle of these foods is cooked by heat conduction.

Moisture Content: Microwaves are attracted by moisture. Naturally moist foods absorb microwaves better than dry ones. Add a minimum of liquid to moist foods, as excess water slows cooking.

Density: The density of food determines how easily the microwaves can penetrate and how quickly it will cook. Porous foods, like chopped beef or mashed potatoes, microwave faster than dense ones like steak or whole potatoes.

Piercing: Steam builds up pressure in foods which are tightly covered by a skin or membrane. Pierce potatoes, egg yolks and chicken livers to prevent bursting.

MICROWAVE TECHNIQUES

Stirring: Stir foods from outside to center of dish once or twice during cooking to equalize heat and speed microwaving. Foods will not burn or stick, so there's no need to stir constantly as you do in conventional cooking.

Arrangement: Arrange foods with thin or delicate ends, like drumsticks or asparagus spears, with the thick or tougher portions to the outside of the dish. The parts which need more cooking will receive more energy, so food will microwave evenly.

Spacing: Individual foods, such as baked potatoes and cupcakes will cook more evenly if placed in the oven an equal distance apart. When possible, arrange foods in a circular pattern. Similarly, when placing foods in a baking dish, arrange around the outside of the dish, not lined up next to each other. Food should not be stacked on top of each other.

Rearrangement: Rearrange overlapping areas, like tails of long fish filets, from top to bottom, and closely packed pieces, like meatballs, from the outside to the center of the dish.

Standing Time: Standing time is especially important in microwave cooking. Microwave energy creates heat in the outer layers of the food. As a result of normal conduction, the food continues to cook for a few minutes after removal from the oven. Letting roasts, large whole vegetables, casseroles and cakes stand to finish cooking allows the middles to cook completely without overcooking, drying or toughening the outsides.

Covering: Covering speeds cooking time, retains moisture, tenderizes, insures even cooking and prevents spattering. Casserole lids or plastic wrap are used for a tighter seal. Vent plastic by turning back one edge at the side of dish to form a narrow slot where excess steam can escape. Various degrees of moisture retention are also obtained by using wax paper or microwave-safe paper towels.

Browning: Microwave energy cooks some foods so quickly that the fats and sugars within the food do not have time to caramelize and give a "browned" appearance. Browning agents do not affect the quality of microwaved foods, but can add color and flavor. For meats and poultry, use bouquet sauce diluted with water or melted butter, soy, Worcestershire, barbecue or steak sauce, a sprinkling of paprika or dry gravy mix; jelly glaze or crumb coating. Frosting and topping finish cakes and breads. Top casseroles at the end of microwaving with grated cheese or crumbs.

COOKING GUIDE (CONTINUED)

Some Foods Do Not Microwave Well

Eggs in Shells and hard boiled eggs can burst.

Pancakes do not crust, but they reheat well. Fully-prepared, frozen pancakes are available for microwaving.

Deep Fat Frying can cause burns.

Bottles with narrow necks may shatter if heated.

Pop Popcorn only in special microwave poppers. Do not use oil unless specified by the manufacturer, or heat longer than recommended. Never pop popcorn in paper bags or glass utensils or directly on the glass tray.

HOT SNACKS AND APPETIZERS

Hot appetizers can be prepared very quickly in the microwave oven.

Many appetizers may be cooked on the serving platter, provided the platter does not have metal trim. A time saving tip – prepare these foods ahead of time, refrigerate or freeze, and refresh in the oven at serving time. A plate of appetizers will take only seconds to refresh.

Cheese melts very rapidly and will toughen if overcooked, so watch foods combined with cheese closely so that overcooking will not occur. As soon as cheese starts to bubble, cooking is completed.

Appetizers that have a crisp pastry exterior are best prepared in a conventional oven.

To prepare appetizers wrapped in bacon, it will be necessary to precook the bacon and then wrap around the foods. Oysters wrapped in bacon are easier to prepare in the broiler of your conventional oven.

Seafood mixtures can be prepared in serving shells as microwave energy will pass through the seafood shells without heating. Aluminum foil should not be used for shells.

If spreads are placed on crackers, care should be taken not to overcook as moisture from the food will cause crackers to become soggy. Crackers used for spreads should be very dry and crisp. This helps avoid sogginess. Heat only until spread is at serving temperature.

The time required to heat all appetizers will depend on the amount of food, and the number and the type of dish selected. Remember the food will become very hot even if the dish is cool. Cheese mixtures retain heat longer when heated with microwave energy.

SEAFOOD

Guide for Cooking Seafood

Microwaving is one of the easiest and most efficient ways of preparing fish and seafood, which stay delicate and tender with quick, moist cooking. Overcooking dries out and toughens seafood, so you should check it after the minimum time. If thick pieces like fish steaks or lobster tails are done on the outside, but still slightly translucent in the middle, let them stand for a few minutes; internal heat will complete the cooking.

Food	Power Level	Cooking Time	Standing Time	Special Notes
Whole Fish (1 lb. to 1 1/2 lbs.)	100	6 - 7 min.	5 min.	Turn over after half the time.
Fish Fillet (1 lb.)	100	5 - 6 min.	4 - 5 min.	Turn over after half the time.
Fish Steak 1 inch thick (1 lb.)	100	4 - 5 min.	5 - 6 min.	Turn over after half the time. Cover with microwaveable cover.
Shrimp (1 lb.)	100	3 - 4 min.	5 min.	Rearrange once during cooking. Cover with microwaveable cover.
Sea Scallops (1 lb.)	80	6 - 7 min.	5 min.	Rearrange once during cooking. Cover with microwaveable cover.

COOKING GUIDE (CONTINUED)

MEATS

Guide for Cooking Meats

Roasts, chops, hamburgers and small cuts of tender meat cook beautifully in the microwave oven. Most roasts can be cooked rare, medium rare or even well done in less than one hour. Less tender cuts of meat such as pot roast can be simmered fork-tender in a sauce or gravy. Tough cuts that require slow cooking will do better in a conventional oven. A large piece of meat, especially if the shape is uneven, should be turned over occasionally for uniform roasting.

Meat	Power Level	Cooking Time (per lb)	Standing Time	Special Notes
Beef Roast				
Rare	80	6 - 8 min.	5 - 7 min.	
Medium	80	8 - 10 min.	10 - 15 min.	Turn over after half the time.
Well	80	10 - 12 min.	10 - 15 min.	
Pork Roast				
Bone-in	80	12 - 15 min.	10 min.	Cover with microwaveable cover.
Boneless	80	16 - 18 min.	10 - 15 min.	Turn over after half the time.
Lamb Roast				
Bone-in	Medium	80	7 - 9 min.	10 - 12 min.
	Well	80	9 1/2 - 11 1/2 min.	10 - 15 min.
Boneless	Medium	80	9 - 11 min.	10 - 12 min.
	Well	80	11 - 13 1/2 min.	10 - 15 min.
Beef Patties (3 1/2 oz) each				
2 patties	100	2 1/2 - 3 min.	5 - 7 min.	Turn over and rearrange after half the time.
4 patties	100	3 1/2 - 4 1/2 min.	5 - 7 min.	
Meat Loaf (2 lbs.)				
	100	15 - 17 min.	10 - 12 min.	Cover with microwaveable cover.
Bacon				
Slices (4 strips) (1 slice; weight: 1 oz., length: 11 in.)	100	4 - 5 min.	—	Cover with microwaveable cover.
Ham				
Slices (1 in. thick) 4 slices	50	7 1/2 - 8 1/2 min.	5 - 7 min.	Cover with microwaveable cover.

POULTRY

Guide for Cooking Poultry

Chicken is one of the most popular foods and microwaving chicken is one of the best uses of your microwave oven. Chicken stays juicy and tender in the microwave oven. However, juiciness prevents browning because chicken crisps and browns only when the skin dries out enough to change color. Standing time is important, because it allows the interior to finish cooking without toughening the delicate breast meat.

Food	Power Level	Cooking Time Level	Standing (per lb.)	Special Notes Time
Roast				
Chicken whole	100	6 - 8 min.	10 - 15 min.	Place breast side up on roasting rack. Let stand, covered, before serving.
Chicken cut up	100	6 - 7 min.	7 - 10 min.	
Turkey	80	6 1/2 - 8 min.	10 - 15 min.	
Cornish Hens	100	7 - 8 min.	7 - 10 min.	
Turkey Breast	50	10 - 11 min.	5 - 7 min.	Rearrange once during cooking. Cover with microwaveable cover.

COOKING GUIDE (CONTINUED)

EGGS & CHEESE

Guide for Cooking Eggs & Cheese

- CHEESE**

Cheese melts quickly and smoothly. When serving cheese as an appetizer, flavor is at peak when served at room temperature. Use a low power level for melting. Cheese melts best when shredded and heated with milk or other liquids. Stir cheese mixtures several times for even heating.

- EGGS**

Eggs cook differently by microwave. The high fat content of egg yolks absorbs energy, so yolks cook faster than whites. It's easy to poach eggs in a microwave oven, but if you want soft yolks, remove eggs from the oven before whites are completely cooked. A brief standing time allows whites to set without overcooking yolks. Check eggs for completion of cooking early, they toughen when overcooked.

When eggs and yolks are mixed together for omelets, scrambled eggs or custards, they cook more evenly and need less stirring than during conventional cooking methods.

Do not try to cook eggs in the shell. Steam can build up inside the shells, causing them to burst.

Scrambled Eggs

Eggs	Butter	Milk or Water	Cook on Power 100	Procedure
2	1 Tbsp.	2 Tbsp.	1 - 2 min.	Place butter in small casserole and melt. Add eggs and milk, scrambling with fork. Cook as directed in chart, breaking up and stirring eggs twice. Let stand, covered, before serving.
4	1 Tbsp.	2 Tbsp.	2 - 3 min.	
6	2 Tbsp.	4 Tbsp.	3 - 4 min.	

Poached Eggs

Eggs	Water	Cook Water on Power 100	Cook Eggs on Power 80	Standing Time	Procedure
1	1 1/2 cups	4 - 6 min.	1 min.	2 min.	Place water into medium casserole. Cook at High until boiling. Break eggs, one at a time, into separate dish, pierce yolk once with wooden pick and slip egg carefully into hot water, cook as directed in chart.
2	1 1/2 cups	4 - 6 min.	1 1/2 - 2 min.	2 min.	
4	2 cups	6 - 7 min.	2 1/2 - 3 min.	2 min.	

SOUPS

Guide for Cooking Soups

Satisfy appetites with savory soups prepared in your microwave oven. Adapt your favorites by using similar cooking times and techniques.

Food	Power Level	Cooking Time	Standing Time	Special Notes
Canned Condensed Cream style, Bean, Pea or Mushroom (10 1/2 - 11 1/2 oz)				
With Water	100	4 1/2 - 5 1/2 min.	2 - 3 min.	Stir halfway through cooking time. Cover with microwaveable cover.
With Milk	80	5 1/2 - 6 1/2 min.	2 - 3 min.	
Dry Soup Mix	100 then	5 1/2 - 7 min.	2 - 3 min.	Add water. Cover with microwaveable cover. Stir twice.
1 envelope (10 1/2 oz.)	50	3 - 4 min.		
Broth (10 1/2 oz.)	100	4 - 5 min.	2 - 3 min.	Stir twice. Cover with microwaveable cover.

COOKING GUIDE (CONTINUED)

VEGETABLES

Guide for Cooking Fresh Vegetables

Nutrition research indicates that many microwaved vegetables and fruits lose less water soluble vitamin C than when cooked conventionally. This is due to shorter cooking time and to the fact that less cooking water is needed when microwaving fruits and vegetables. Best of all, vegetables keep their fresh color, texture and flavor. Vegetables should be microwaved covered with vented plastic wrap or a casserole lid. Vegetables cooked in their skins, such as potatoes, are already so tightly covered that they should be pricked with a fork before cooking in order to release excess steam. To assure even cooking, vegetables should be cut in uniform pieces and stirred during the cooking time. Always add salt to water before adding vegetables. Reduce time a minute or two for crisp-tender texture. Increase time for very soft texture. Remember to allow standing time of two to five minutes after cooking because, as most foods do, vegetables will continue to cook after they are removed from the microwave oven.

Food	Water Amount	Cook on Power 100	Standing Time	Special Notes
Asparagus				
Spears (1 lb.)	1/4 cup	5 - 6 min.	2 min.	Medium Casserole. Rearrange once.
Cuts (1 lb.)	1/2 cup	5 - 6 min.	2 min.	
Fresh green beans (1/2 lb.)	1/4 cup	4 - 5 min.	2 min.	Stir twice.
Frozen green beans (1/2 lb.)	2 Tbsp.	5 1/2 - 6 1/2 min.	2 min.	Stir twice.
Green Peas (2 cups)	1/4 cup	4 - 5 min.	2 min.	Small casserole. Stir twice.
Broccoli (2 cups)	1/4 cup	4 - 5 min.	2 min.	Medium casserole. Rearrange once during cooking.
Brussels Sprouts (1 lb.)	1/4 cup	6 - 7 1/2 min.	2 - 3 min.	Medium casserole. Stir once.
Cabbage (1 lb.)	1/4 cup	5 - 6 min.	2 - 5 min.	Rearrange once during cooking.
Cauliflower pieces (1 head)	1/4 cup	6 - 7 min.	2 - 5 min.	Cover with microwaveable cover. Stir once.
Mushroom slices (1/2 lb.)	2 Tbsp.	3 - 4 min.	2 - 3 min.	Small casserole. Stir once.

CASSEROLES

Casseroles may require occasional stirring to distribute heat. They cook more evenly when made with ingredients of similar size and shape. Because of their shorter cooking time, casseroles cooked in the microwave oven generally need less liquid. Casseroles with cream and cheese sauces, or meats which need slower cooking to tenderize, cook best on power level 40.

When cooking a favorite casserole, make two and freeze the second for future use. Line a casserole or baking dish with plastic wrap. Transfer the cooked food to the lined container and freeze. As soon as the food is frozen in the shape of the dish, remove it and wrap with freezer paper. Later it can be unwrapped and returned to the container for defrosting and heating.

Dry Casserole Mixtures

Many prepared box type casseroles are available on the grocery shelves. Many have freeze dried foods or evaporated foods included. Cooking periods are so short there may not be time for the foods to absorb the moisture sufficiently and reconstitute the foods. To prepare this type, boil the amount of water recommended on the package. Add the noodles (when included), cover and cook for approximately 10 minutes. Allow noodles to stand covered for an additional 10 minutes, rinse with warm water and drain. Then follow package directions for preparing the mix. Reheat four to six minutes before serving.

COOKING GUIDE (CONTINUED)

SAUCES

Guide for Cooking Sauces

Sauces boil over rapidly, especially those that contain milk. As soon as the door is opened, cooking stops. If ingredients are not taken directly from the refrigerator, cooking time will be less than given in the recipe. Stir sauce quickly, about every 30 seconds to eliminate lumps. Be sure to use a container twice the size of the amount of liquid to prevent boiling over.

A wooden spoon may be left in the dish while sauce is cooking for easy stirring. If sauce is stirred slowly, cooking time may require about 15 seconds longer. If desired, a one-quart glass measure may be used to prepare some sauces.

White Sauce

Amount	Butter	Flour	Milk	Cook Butter	Cook Sauce	Special Notes
1 cup, thin	1 Tbsp	1 Tbsp	1 cup	30 sec.	2 1/2 - 3 1/2 min.	Cook on Full power as directed or until thickened, stirring once. Let stand, covered, before serving.
med.	2 Tbsp	2 Tbsp	1 cup	1 min.	2 1/2 - 3 1/2 min.	
thick	3 Tbsp	3 Tbsp	1 cup	1 min.	3 - 4 min.	

Brown Gravy

Amount	Fat from Drippings	Flour	Liquid or Drippings	Cook on Power 100	Special Notes
1 cup, thin	1 Tbsp	1 Tbsp	1 cup	2 1/2 - 3 1/2 min.	Cook on Full power as directed or until thickened, stirring once. Let stand, covered, before serving.
med.	1 Tbsp	1 Tbsp	1 cup	3 - 4 min.	
thick	1 Tbsp	1 Tbsp	1 cup	3 - 4 min.	

SANDWICHES, INCLUDING HAMBURGERS AND HOT DOGS

Guide for Heating Sandwiches

Sandwiches heat very quickly because, being porous, they have a low density. Since the filling is usually more dense than the bread or rolls, the filling determines the heating time. Surprisingly, the filling will always be hotter than the bread feels. Care must be taken not to overcook as the bread will become tough. Use several thin slices of meat. Thin slices heat more quickly and are better than one thick slice. The slow heating thick slice often causes the bread to overcook before the meat is hot. Sandwiches may be placed on a paper plate, napkin or paper towel to be warmed. The sandwich should be covered with a microwave-safe paper towel. Remove wrapping immediately after warming. Already-baked frozen breads and rolls may be used for sandwiches. The filling, however, should be thawed first. Toasted bread is fine for sandwiches and provides a firm base. The toast is warmed only; no further browning occurs.

Food	Amount	Cook on Power 100	Special Notes
Sandwich (6 oz.)	1	1 min.	Place on microwaveable plate.
	2	1 1/2 - 2 min.	
	4	3 - 4 min.	
Hamburger (4 oz.)	1	1 min.	Cover with microwaveable cover.
	4	3 - 4 min.	
Hot Dog (2 oz.)	4	1 1/2 - 2 min.	Cover with microwave-safe paper towel.
Sloppy Joe	4	4 min.	Place on microwaveable plate.

COOKING GUIDE (CONTINUED)

PASTA & GRAINS

Guide for Cooking Pasta and Grains

Raw long grain rice takes time to rehydrate. Microwaving time is a little shorter than conventional, but the greatest advantage is the ease with which you can prepare fluffy rice without sticking or burning. Cooked rice and pasta reheat easily in the microwave oven without loss of flavor or texture. No extra water is needed to prevent sticking or drying, so there's no danger of overcooking rice and pasta or thinning sauces.

Food	Hot Water	Salt	Oil or Butter	Power Level	Cooking Time	Standing Time
Pasta (8 oz)						
Egg Noodles	4 cups	1 tsp.	1 Tbsp.	100	6 1/2 - 7 1/2 min.	2 - 5 min.
Macaroni	4 cups	1 tsp.	1 Tbsp.	100	8 - 10 min.	2 - 5 min.
Spaghetti	4 cups	1 tsp.	1 Tbsp.	100	8 - 10 min.	2 - 5 min.
Lasagna Noodles	4 cups	1 tsp.	1 Tbsp.	100	12 - 14 min.	2 - 5 min.
Rice, Long Grain						
White Rice (1 cup)	2 cups	1 tsp.	1 tsp.	100 then 80	5 - 6 min. 9 1/2 - 12 min.	5 - 7 min.
Brown Rice (1 cup)	2 cups	1/2 tsp.	1 tsp.	100 then 80	5 - 6 min. 22 - 27 min.	5 - 7 min.

CEREALS

Microwavable hot cereals can be cooked directly in the cereal bowl and make cleaning up easy.

CONVENIENCE FOODS

Frozen Foods

A large variety of frozen foods, special dishes and dinners are available and the selections continue to increase. The market is changing rapidly, therefore it is impossible to list the foods and types available and recommend cooking procedures. In this book we can only give general directions to assist you.

T.V. Dinners

To prepare a T.V. dinner, follow the maker's instructions for use with microwave ovens. To cook a T.V. dinner will require approximately five to seven minutes for the food to thaw and heat to serving temperature (depending on the types of food). Allow plastic wrap to remain over the dish for two minutes to allow heat to equalize. Dinners that contain mashed potatoes have presented a bit of a problem due to the large compact mass of this particular food. You may want to remove about half the mashed potatoes after defrosting is started, then spread the remaining potatoes over the individual section of the tray. Heat the removed mashed potatoes in an individual dish. For foods that should be crisp when cooking is completed, remove the plastic wrap and use the broiler of a conventional oven to crisp the food.

Individual Frozen Foods

These may be commercially prepared or frozen at home. Place the container of frozen food in the oven and heat only until the food starts to defrost and can be removed easily. Empty contents into a casserole or serving dish and continue to defrost and heat. Do not heat foods in deep foil containers. To crisp and brown special toppings, use the broiler of a conventional oven. If allowed to heat to serving temperature in a plastic container, the container will warp or melt from the high heat of food.

Frozen Foods in Cooking Pouches or Boilable Bags

To prepare these foods, slit the plastic bag. An X-type cut will help remove the food at the end of cooking time. Place the cut side down on a serving dish (with no metal trim). Heat foods other than vegetables for about three minutes. Frozen vegetables require about eight to nine and a half minutes of cooking time. Allow the pouch bag to remain over the food for about two minutes to allow time for the heat to equalize. Foods prepared in cheese or white sauce should be removed from the pouch and placed in a glass casserole dish and stirred to prevent overcooking of the sauce around the edges of the dish.

COOKING GUIDE (CONTINUED)

Complete Meals from Table Leftovers

Complete meals from leftovers can be prepared in advance. Foods can be frozen and ready for quick heating in the oven at any time. Choose foods suitable for freezing and put serving portions on paper, glass or china (no metal trim) plates. Wrap with recommended freezer paper and freeze quickly. When apportioning the servings of food on the plate, use approximately the same amount of each kind of food for more even heating. Mashed potatoes will heat quicker if spread slightly and hollowed, with a pat of butter in the center. To prevent small pieces of vegetables, corn, peas, etc., from dehydrating during heating, mound well near the center of the plate.

DESSERTS

There's always time to make dessert with a microwave oven. Fruit desserts have a remarkably fresh flavor and texture. Microwaved cakes are higher and more tender than conventionally baked; since cakes are usually frosted, browning is unimportant. Microwaved pie crusts are exceptionally tender and flaky, while delicate custards and puddings are easy to prepare.

Guide for Cooking Cakes

Food	Power	Cooking Time Level	Standing	Special Notes Time
Cake, round (Mixed 9 inch)	100 80	3 1/2 - 5 min. 4 1/2 - 6 min.	2 - 5 min.	Pour into greased and wax paper lined cake dish.
Ring or Angel Food Cake	80	5 1/2 - 6 1/2 min.	2 - 5 min.	Cover with wax paper.
Muffin (6 muffins)	50	4 1/2 - 6 1/2 min.	2 - 5 min.	Rearrange once.
Custard (6 servings)	50	10 - 12 min.	5 - 7 min.	Rearrange once.

Baking

- Bar cookies work best. Greasing or lining of the microwaveable baking dish is optional.
- If insufficient browning disturbs you, frost, glaze or add food coloring to white or yellow batters.
- A microwaveable cookie sheet can be made by covering cardboard with waxed paper.
- Round glass baking dishes, and fluted or smooth microwaveable ring molds work best for cakes. You can make a microwaveable ring mold of your own by placing a medium-size glass in the center of a round glass baking dish.
- Because your cakes will rise higher in microwave cooking, never fill microwaveable cake pans more than half full.
- Reduce baking powder and soda by approximately one-fourth when converting a conventional recipe.
- Fill paper-lined muffin cups to only half full which allows for muffins to rise more than normal.
- You can prepare your own "brown 'n serve" breads and rolls by baking them ahead of time in the microwave oven. Then, place them in a conventional oven to brown prior to serving.
- Breads and rolls should be reheated to the point where they are warm to the touch. Overheating or overcooking makes bread tough and rubbery.
- When making yeast bread in a microwave oven, choose a recipe with cornmeal, whole wheat flour, or rye flour to achieve a richer color.

SPECIFICATIONS

Item	Rating Specification
Power Supply	120V~ 60Hz
Microwave/Grill Output Power	1100W(Microwave)/1100W(Grill)
Microwave Frequency	2450MHz
Oven Capacity	1.2 cubic feet
Outside Dimensions	20.6 (W) x 17.3 (D) x 12.8 (H) inches (523mm x 440mm x 325mm)
Weight	36.3 Lbs (16.5 kg) Approx.

BEFORE YOU CALL FOR SERVICE

Refer to the following checklist before you call for service.

If the oven does not work:

1. Check that the power cord is securely plugged in.
2. Check that the door is firmly closed.
3. Check that the cooking time is set.
4. Check for a blown circuit fuse or tripped main circuit breaker in your house.
5. Check that the Child Lock feature is not engaged.

If there is sparking in the cavity:

1. Check the containers, dishes or utensils in the oven and make sure they are not metal or have metal trim.



◆◆◆◆◆ SERVICE ◆◆◆◆◆

FOR ADDITIONAL SET-UP OR OPERATING ASSISTANCE
PLEASE CALL:

1-800-898-9020 OR 1-800-695-0098

FOR CUSTOMER SERVICE, PLEASE E-MAIL TO:
internet@emersonradio.com

OR WRITE TO:
Emerson Radio Corp.,
Consumer Affairs Dept.,
9 Entin Road, P.O. Box 430,
Parsippany, New Jersey 07054-0430

LIMITED WARRANTY MICROWAVE OVENS

Emerson Radio Corp. warrants this product to be free from manufacturing defects in original material, including original parts, and workmanship under normal use and conditions ("manufacturing defect") for a period of one (1) year from date of original purchase in, and if used in, the United States ("warranty"). Should service be necessary under this warranty, Emerson will provide the following at an Independent Service Center or Regional Repair Facility permitted by Emerson to perform repairs, provided the manufacturing defect is verified along with the date of purchase:

- * Repair service for one (1) year from date of original purchase at no charge for labor and parts.
- * Replacement of a defective magnetron for seven (7) years from date of original purchase (labor not included after initial twelve (12) months).

There are Independent Service Center and Regional Repair Facilities located throughout the country. For the one nearest you, DIAL TOLL FREE: 1-800-695-0098. In the event the product must be mailed to a Regional Repair Facility which is permitted by Emerson to perform repairs:

- * Pack the unit in a well-padded heavy corrugated box.
- * Enclose your check or money order payable to the REGIONAL REPAIR FACILITY in the amount of \$15.00 to cover return shipping and handling costs.
- * Enclose a copy of your proof of purchase (warranty service will not be provided without dated proof of purchase).
- * Ship the unit prepaid via UPS or parcel post (insured).

NOTE: This warranty does not cover:

- (a) Damage to equipment not properly connected to the product.
- (b) Cost incurred in the shipping of the product to and from a Regional Repair Facility permitted by Emerson to perform warranty repairs.
- (c) Damage or improper operation of unit caused by customer abuse, misuse, negligence or failure to follow operating instructions provided with the product.
- (d) Ordinary adjustments to the product which can be performed by customer as outlined in the owner's manual.
- (e) Signal reception problems caused by external antenna or cable systems.
- (f) Products not purchased in the United States.
- (g) Damage to product if used outside the United States.

THIS WARRANTY IS NON-TRANSFERABLE AND APPLIES ONLY TO THE ORIGINAL PURCHASER AND DOES NOT EXTEND TO SUBSEQUENT OWNERS OF THE PRODUCT. ANY APPLICABLE IMPLIED WARRANTIES, INCLUDING THE WARRANTY OF MERCHANTABILITY, ARE LIMITED IN DURATION TO A PERIOD OF THE EXPRESSED WARRANTY AS PROVIDED HEREIN BEGINNING WITH THE DATE OF ORIGINAL PURCHASE AT RETAIL AND NO WARRANTIES, WHETHER EXPRESSED OR IMPLIED, SHALL APPLY TO THE PRODUCT THEREAFTER. EMERSON MAKES NO WARRANTY AS TO THE FITNESS OF THE PRODUCT FOR ANY PARTICULAR PURPOSE OR USE.

THE EXTENT OF EMERSON RADIO CORP'S LIABILITY UNDER THIS LIMITED WARRANTY IS THE REPAIR OR REPLACEMENT PROVIDED ABOVE AND, IN NO EVENT, SHALL EMERSON RADIO CORP'S LIABILITY EXCEED THE PURCHASE PRICE PAID BY THE PURCHASER OF THE PRODUCT. UNDER NO CIRCUMSTANCES SHALL EMERSON RADIO CORP. BE LIABLE FOR ANY LOSS, DIRECT, INDIRECT, INCIDENTAL, SPECIAL, OR CONSEQUENTIAL DAMAGE ARISING OUT OF OR IN CONNECTION WITH THE USE OF THIS PRODUCT. THIS WARRANTY IS VALID ONLY IN THE UNITED STATES OF AMERICA.

THIS WARRANTY GIVES YOU SPECIFIC LEGAL RIGHTS. HOWEVER, YOU MAY HAVE OTHER RIGHTS WHICH MAY VARY FROM STATE TO STATE. SOME STATES DO NOT ALLOW LIMITATIONS ON IMPLIED WARRANTIES OR EXCLUSION OF CONSEQUENTIAL DAMAGE, THEREFORE THESE RESTRICTIONS MAY NOT APPLY TO YOU.

The serial number can be found on the back cabinet. We suggest that you record the serial number of your unit in the space below for future reference.

Model Number: _____

Serial Number: _____

MV1094F



EMERSON
PART NO.: MWG9115-03162009-02

Printed in China