



**Emerson®**

**0.9 Cubic Foot  
Microwave Oven**

**FILE COPY**

*With Computerized Touchpad Control*

**IMPORTANT**

Call toll free 1-800-210-2281 for exciting information and special discounts on Extended Service Plans.

**OWNER'S MANUAL  
AND  
COOKING GUIDE**

**MW8987W/S/D**

**FILE COPY  
MASTER  
FILE**

# PRECAUTIONS TO AVOID POSSIBLE EXPOSURE TO EXCESSIVE MICROWAVE ENERGY

- (a) Do not attempt to operate this oven with the door open since open-door operation can result in harmful exposure to microwave energy. It is important not to defeat or tamper with the safety interlocks.
- (b) Do not place any object between the oven front face and the door or allow soil or cleaner residue to accumulate on sealing surfaces.
- (c) Do not operate the oven if it is damaged. It is particularly important that the oven door close properly and that there is no damage to the: (1) door (bent), (2) hinges and latches (broken or loosened), (3) door seals and sealing surfaces.
- (d) The oven should not be adjusted or repaired by anyone except properly qualified service personnel.

## CONTENTS

Precautions to avoid possible exposure to excessive microwave energy.....	1	Cooking guide.....	18
Important safety instructions.....	2	The principles of microwave cooking.....	18
Safety precautions.....	3	Microwave utensils.....	18
Federal Communications Commission radio frequency interference statement (U.S.A. only).....	4	Food characteristics.....	20
Grounding instructions.....	4	Microwave techniques.....	21
Installation.....	5	Auto defrosting.....	22
Care of your microwave oven.....	6	General Information.....	23
How to use your microwave oven safely.....	7	Fish.....	23
Features diagram.....	9	Pork.....	24
Operation procedure.....	10	Beef.....	25
How to set the oven controls.....	11	Lamb.....	26
Setting the clock.....	11	Poultry.....	27
Time defrosting.....	11	Eggs and cheese.....	28
Auto defrosting.....	12	Vegetables.....	29
Cooking in one stage.....	13	Cooking fresh vegetables.....	32
Kitchen timer mode.....	14	Fish and Seafood.....	36
Quick cook.....	15	Poultry.....	38
One touch cooking (6 menu).....	15	Meats.....	40
Popcorn.....	15	Soups.....	44
Frozen pizza.....	15	Sauces and gravies.....	45
Beverage.....	16	Desserts.....	47
Dinner plate.....	16	Weight & measure conversion chart.....	49
Fresh vegetable.....	16	Specifications.....	50
Frozen vegetable.....	16	Before you call for service.....	50
More/Less.....	17	Emerson limited warranty.....	52
Child safety lock.....	17		
To stop the oven while the oven is operating.....	17		

# IMPORTANT SAFETY INSTRUCTIONS

When using electrical appliances, basic safety precautions should be followed, including the following:

**WARNING-**To reduce the risk of burns, electric shock, fire, injury to persons or exposure to excessive microwave energy:

- 1 Read all instructions before using the appliance.
- 2 Read and follow the specific **"PRECAUTIONS TO AVOID POSSIBLE EXPOSURE TO EXCESSIVE MICROWAVE ENERGY"** found on page 1.
- 3 This appliance must be grounded. Connect only to properly grounded outlet. See **"GROUNDING INSTRUCTIONS"** found on page 4.
- 4 Install or locate this appliance only in accordance with the provided installation instructions.
- 5 Some products such as whole eggs and sealed containers - for example, closed glass jars - may explode and should not be heated in this oven.
- 6 Use this appliance only for its intended use as described in this manual.
- 7 As with any appliance, close supervision is necessary when used by children.
- 8 Do not operate this appliance if it has a damaged cord or plug, if it is not working properly, or if it has been damaged or dropped.
- 9 This appliance should be serviced only by qualified service personnel. Contact nearest authorized service facility for examination, repair or adjustment.
- 10 Do not cover or block any openings on the appliance.
- 11 Do not use outdoors.
- 12 Do not immerse cord or plug in water.
- 13 Keep cord away from heated surfaces.
- 14 Do not let cord hang over edge of table or counter.
- 15 When cleaning surfaces of door and oven that come together when closing the door, use only mild, non-abrasive soap or detergents applied with a sponge or soft cloth.
- 16 To reduce the risk of fire in the oven cavity:
  - a) Do not overcook food. Carefully attend appliance if paper, plastic, or other combustible materials are placed inside the oven to facilitate cooking.
  - b) Remove wire twist-ties from paper or plastic bags before placing bag in oven.
  - c) If materials inside the oven should ignite, keep oven door closed, turn oven off, and disconnect the power cord, or shut off power at the fuse or circuit breaker panel.
  - d) Do not use the cavity for storage purposes. Do not leave paper products, cooking utensils, or food in the cavity when not in use.
- 17 Do not use this microwave oven to heat corrosive chemicals (for example, sulfides and chlorides). Vapours from such corrosive chemicals may interact with the contacts and springs of the safety interlock switches thereby rendering them inoperable.
- 18 Keep the waveguide cover clean at all times. Wipe the oven interior with a soft damp cloth after each use. If you leave grease or fat anywhere in the cavity it may overheat, smoke or even catch fire when next using the oven.
- 19 Never heat oil or fat for deep frying as you cannot control the temperature and doing so may lead to overheating and fire.

**SAVE THESE INSTRUCTIONS**

# SAFETY PRECAUTIONS

## GENERAL USE

- 1 DO NOT attempt to tamper with or make any adjustments or repairs to door, control panel or any other part of the oven. DO NOT remove outer case from oven. Repairs should only be done by a qualified service person.
- 2 DO NOT operate the oven empty. The microwave energy will reflect continuously throughout the oven if no food or water is present to absorb energy.
- 3 If a fire occurs in the oven, touch the STOP/CLEAR pad and LEAVE THE DOOR CLOSED. Disconnect the power cord, or shut off power at the fuse or circuit breaker panel.
- 4 DO NOT attempt to dry clothes, newspaper or other materials in oven. They may catch on fire.
- 5 DO NOT use recycled paper products as they may contain impurities which may cause sparks and/or fires when used.
- 6 DO NOT hit or strike control panel, damage to controls may occur.
- 7 AVOID inserting nails, wire, etc. through any holes in the unit while operating the oven. Never insert a wire, nail or any other metal object through the holes on the cavity or any other holes or gaps because such objects may cause electric shock and microwave leakage.

## UTENSILS

- 1 METAL CONTAINERS or dishes with metallic rims should not be used. Arcing may occur.
- 2 METAL TWIST-TIES must not be used in the microwave oven.
- 3 DO NOT use SEALED JARS or NARROW NECK bottles for cooking or reheating. They may shatter.
- 4 DO NOT use CONVENTIONAL THERMOMETERS in the microwave oven. They may cause arcing.
- 5 Remove PLASTIC STORE WRAPS before cooking or defrosting in the oven.
- 6 For FURTHER INFORMATION on proper cooking utensils, refer to the Introduction in the Microwave cooking guide.

## FOOD

- 1 Never use your microwave oven for HOME CANNING. The oven is not designed to permit proper canning. Improperly canned food may spoil and be dangerous to consume.
- 2 COOKING TIMES given in the cooking guide are APPROXIMATE. Factors that may affect cooking are: starting temperature, altitude, volume, size and shape of foods and utensils used. As you become familiar with the oven, you will be able to adjust for these factors.
- 3 It is better to UNDERCOOK RATHER THAN OVERCOOK foods. If food is undercooked, it can always be returned to the oven for further cooking. If food is overcooked, nothing can be done. Always start with minimum cooking times.
- 4 SMALL QUANTITIES of food or foods with LOW MOISTURE content can burn, dry out or catch on fire if cooked too long.
- 5 DO NOT boil eggs in their shell. Pressure may build up and the eggs will explode.
- 6 Potatoes, apples, egg yolks, whole acorn squash and sausage are examples of food with NONPOROUS SKINS. These must be pierced before cooking to prevent bursting.
- 7 POPCORN must be popped in a microwave corn popper. Microwave popped corn produces a lower yield than conventional popping. Do not pop popcorn unless popped in a microwave approved popcorn utensil or unless it's commercially packaged and recommended especially for microwave ovens. Do not use oil unless specified by the manufacturer.
- 8 DO NOT attempt to deep fat fry in your oven.
- 9 HEATED LIQUIDS can ERUPT if not mixed with air. Do not heat liquids in your microwave oven without first stirring.

# FEDERAL COMMUNICATIONS COMMISSION RADIO FREQUENCY INTERFERENCE STATEMENT(U.S.A. ONLY)

## **WARNING:**

This equipment generates and uses ISM frequency energy and if not installed and used properly, that is in strict accordance with the manufacturer's instructions, may cause interference to radio and television reception.

It has been type-tested and found to comply with limits for an ISM Equipment pursuant to part 18 of FCC Rules, which are designed to provide reasonable protection against such interference in a residential installation.

However, there is no guarantee that interference will not occur in a particular installation.

If this equipment does cause interference to radio or television reception, which can be determined by turning the equipment off and on, the user is encouraged to try to correct the interference by one or more of the followings.

- Reorient the receiving antenna of radio or television.
- Relocate the Microwave oven with respect to the receiver.
- Move the microwave oven away from the receiver.
- Plug the microwave oven into a different outlet so that microwave oven and receiver are on different branch circuits.

THE MANUFACTURER is not responsible for any radio or TV interference caused by UNAUTHORIZED MODIFICATION to this microwave oven. It is the responsibility of the user to correct such interference.

## GROUNDING INSTRUCTIONS

This appliance must be grounded. In the event of an electrical short circuit, the grounding plug reduces the risk of electric shock by providing an escape wire for electric current. This appliance is equipped with a cord having a grounding wire with a grounding plug. The plug must be plugged into an outlet that is properly installed and grounded.

**WARNING:** Improper use of the grounding plug can result in a risk of electric shock.

Consult a qualified electrician or serviceman if the grounding instructions are not completely understood, or if doubt exists as to whether the appliance is properly grounded.

- (1) If it is necessary to use an extension cord, use only a 3-wire extension cord that has a 3-blade grounding plug, and a 3-slot receptacle that will accept the plug on the appliance. The marked rating of the extension cord shall be equal to or greater than the electrical rating of the appliance.
- (2) Do not use an extension cord, if the power supply cord is too short, have a qualified electrician or serviceman install an outlet near the appliance.

# INSTALLATION

## 1 Steady, flat location

This microwave oven should be set on a steady, flat surface.

## 2 Ventilation

Do not block air vents. If they are blocked during operation, the oven may overheat and eventually cause oven failure. For proper ventilation, keep 3 inches of space between oven's top, sides, rear and area where the unit is to be installed.

## 3 Away from radio and TV sets

Poor television reception and radio interference may result if the oven is located close to a TV, Radio, antenna, feed, etc. Place the oven as far from them as possible.

## 4 Away from heating appliances and water taps

Keep the oven away from hot air, steam or splashing liquids when choosing a place to position it, otherwise the insulation might be adversely affected and breakdowns may occur.

## 5 Power supply

- Check your local power source.  
This microwave oven requires a current of approximately 15 amperes, 120 Volts, 60Hz grounded outlet.
- Power supply cord is about 1.0 meters long.
  1. A short power-supply cord is provided to reduce the risks resulting from becoming entangled in or tripping over a longer cord.
  2. Longer cord sets or extension cords are available and may be used if care is exercised in their use.
  3. If a long cord or extension cord is used, (1) the marked electrical rating of the cord set or extension cord should be at least as great as the electrical rating of the appliance, (2) the extension cord must be a grounding-type 3-wire cord, and (3) the longer cord should be arranged so that will not drape over the countertop or tabletop where it can be pulled on by children or tripped over unintentionally.

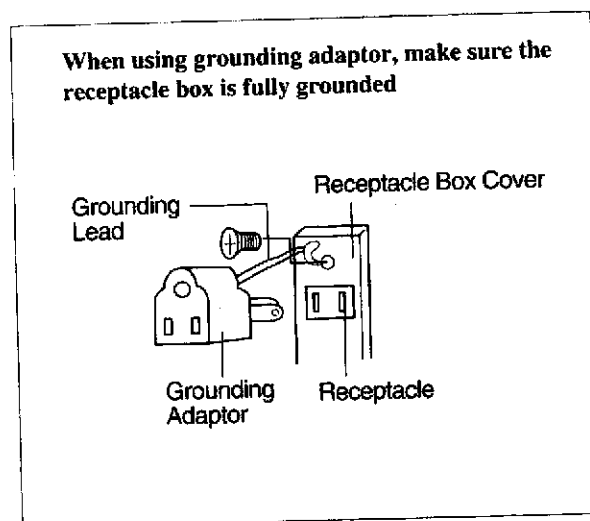
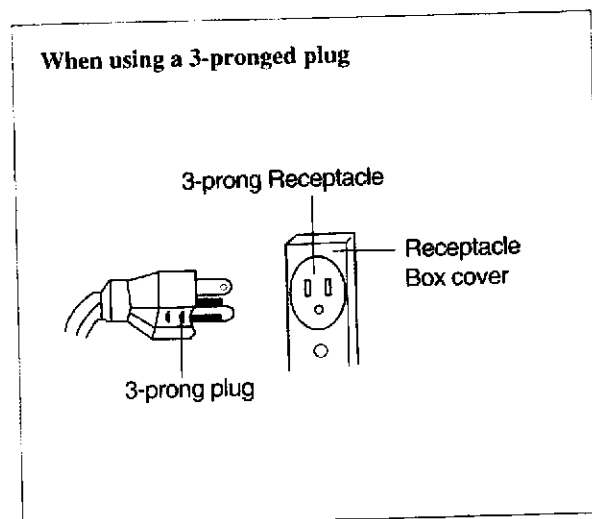

## 6 Examine the oven after unpacking for any damage such as:

Dents, a misaligned door, broken door, a dent in the cavity.  
If any or the above are visible, DO NOT INSTALL and notify dealer immediately.

# CARE OF YOUR MICROWAVE OVEN

- 1 Turn the oven off before cleaning.
- 2 Keep the inside of the oven clean. When food spatters or spilled liquids adhere to oven walls, wipe with a damp cloth. Mild detergent may be used if the oven gets very dirty. The use of harsh detergent or abrasives is not recommended.
- 3 The outside oven surface should be cleaned with soap and water, rinsed and dried with a soft cloth. To prevent damage to the operating parts inside the oven, water should not be allowed to seep into the ventilation openings.
- 4 If the Control Panel becomes wet, clean with a soft, dry cloth. Do not use harsh detergents or abrasives on Control Panel.
- 5 If steam accumulates inside or around the outside of the oven door, wipe with a soft cloth. This may occur when the microwave oven is operated under high humidity conditions and in no way indicates malfunction of the unit.

- 6 It is occasionally necessary to remove the glass tray for cleaning. Wash the tray in warm sudsy water or in a dishwasher.

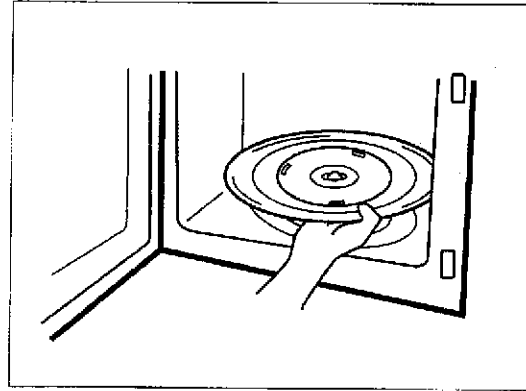

- 7 The roller guide and oven cavity floor should be cleaned regularly to avoid excessive noise. Simply wipe the bottom surface of the oven with mild detergent water or window cleaner and dry. The roller guide may be washed in mild sudsy water.

## ROLLER GUIDE

- 1 The ROLLER GUIDE and oven floor should be cleaned frequently to prevent excessive noise.
- 2 The ROLLER GUIDE MUST ALWAYS be used for cooking together with the Glass Tray.

## GLASS TRAY

- 1 DO NOT operate the oven without the Glass Tray in place.
- 2 DO NOT use any other Glass Tray with this oven.
- 3 If Glass Tray is hot, ALLOW IT TO COOL before cleaning or placing it in water.
- 4 DO NOT cook directly on the Glass Tray.

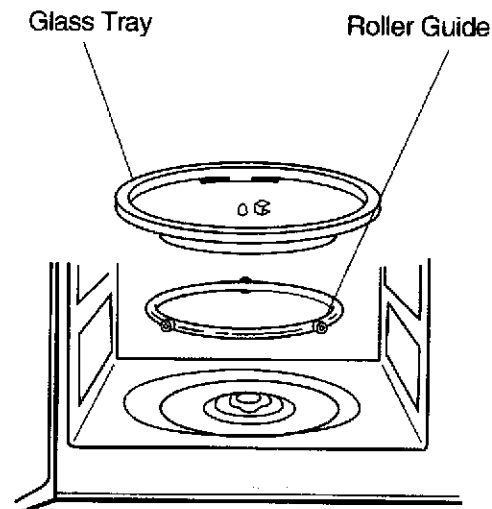

# HOW TO USE YOUR MICROWAVE OVEN SAFELY

Although your oven is provided with safety features, it is important to observe the following:

- a) It is important not to defeat or tamper with safety interlocks.
- b) Do not place any object between the front face and the door or allow residue to accymulate on sealing surfaces. Wipe the sealing area frequently with a mild detergent, rinse and wipe dry. Never use abrasive powders or pads.
- c) When opened, the door must not be subjected to strain, for example, a child hanging on an opened door or any load could cause the oven to fall forward to cause injury and also damage the door. Do not operate the oven if it is damaged, until it has been repaired by a qualified service engineer. It is particularly important that the oven door closes properly and that there is no damage to the:
  - i) Door (bent)
  - ii) Hinges and Latches (broken or loosened)
  - iii) Door seals and Sealing surfaces
- d) The oven should not be adjusted or repaired by anyone except properly qualified service personnel.

**NOTE:** It is quite normal for steam to be emitted around the door during the cooking cycle. The door is not intended to seal the oven cavity completely, but its special design contributes to the complete safety of the appliance.

**CAUTION:**

1. Do not attempt to operate the oven while empty as this will cause damage.
2. As an exhaust is located in the rear of the oven, install the oven so as not to block the outlet.



# FEATURES DIAGRAM

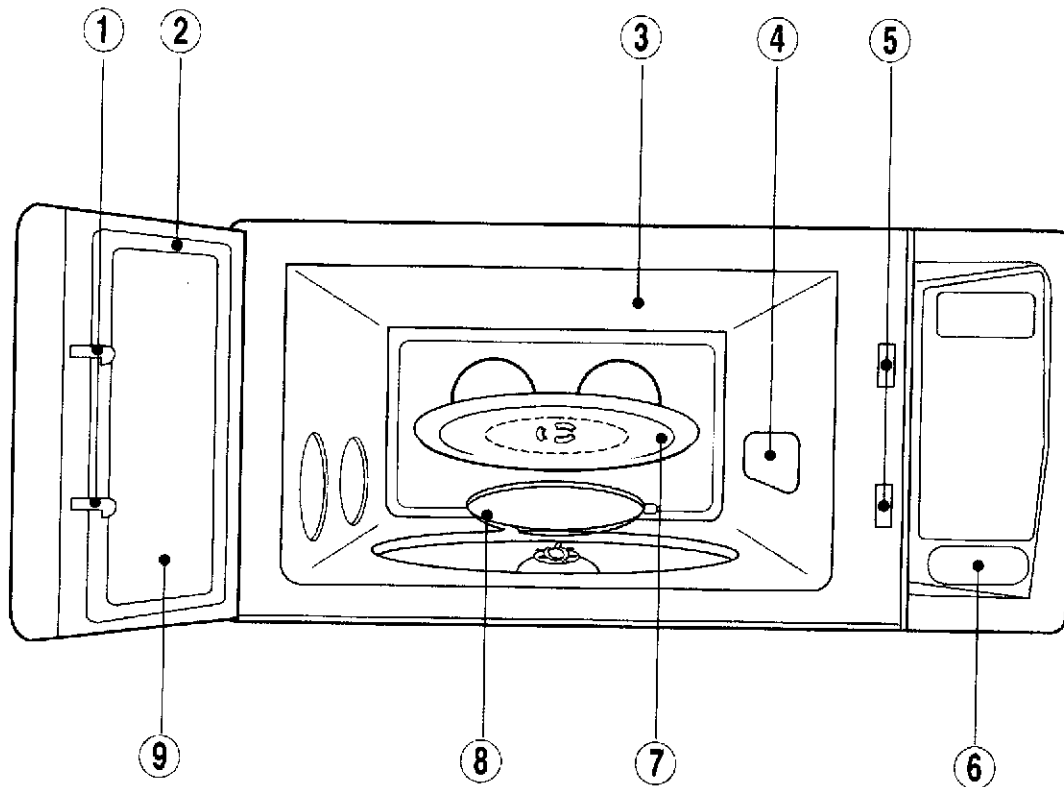

- ① **Door latch**-When the door is closed, it will automatically lock shut. If the door is opened while the oven is operating, the magnetron will automatically shut off.
- ② **Door seal**-The door seal maintains the microwave within the oven cavity and prevents microwave leakage.
- ③ **Oven cavity**
- ④ **Spatter shield**-Protects the microwave outlet from splashes of cooking foods.
- ⑤ **Safety interlock system**-Prevents the oven from operating while the door is opened.
- ⑥ **Door release button**-Pushing this button stops oven operation and opens the door.
- ⑦ **Glass cooking tray**-Made of special heat resistant glass. The tray must always be in proper position before operating. Do not cook food directly on the tray.
- ⑧ **Roller guide**-Supports the glass cooking tray.
- ⑨ **Door screen**-Allows viewing of food. The screen is designed so that light can pass through, but not the microwaves.

# FEATURES DIAGRAM

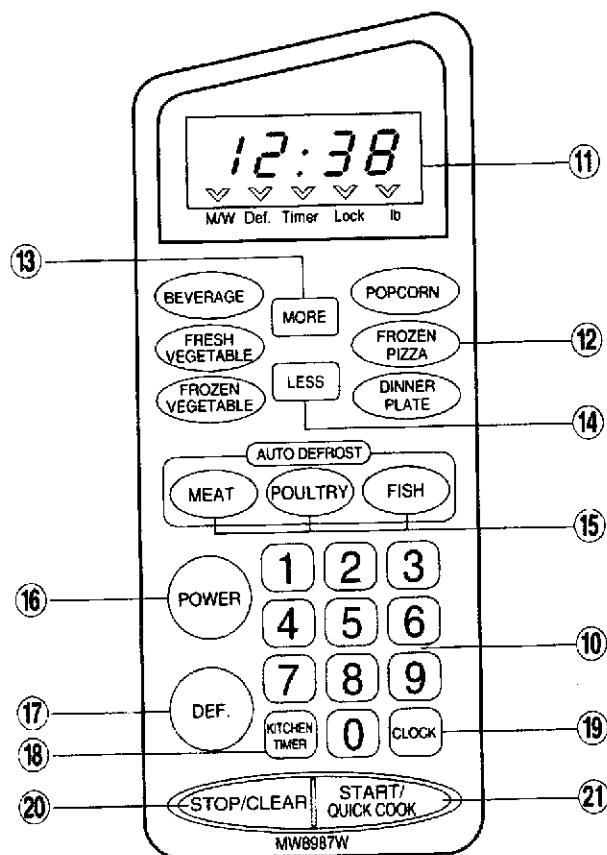

- ⑩ **Number pads**-Used to set the cooking time and the present time.
- ⑪ **Display**-Cooking time, power level indicators and present time are displayed.
- ⑫ **One touch**-Used to cook or reheat specific quantities of food.
- ⑬ **More**-Used to add time to cooking.
- ⑭ **Less**-Used to remove time from cooking.
- ⑮ **Auto Defrost**-Used to defrost foods.(for weight)
- ⑯ **Power**-Used to set power level.

- ⑰ **Def.**-Used to defrost foods.(for time)
- ⑱ **Kitchen Timer**-Used as a minute timer, to delay the start of cooking, or to set a holding time after cooking.
- ⑲ **Clock**-Used to set clock.
- ⑳ **Stop/Clear**-Used to stop the oven operation or to delete the cooking data.
- ㉑ **Start/Quick cook**-Used to start the oven and also used to set a reheat time.

# OPERATION PROCEDURE

This section includes useful information about oven operation.

1. Plug power supply cord into a standard 3-pronged 15 Amp, 120V AC 60Hz power outlet socket.
2. After placing the food in a suitable container, open the oven door and put it on the glass tray.  
The glass tray and roller guide must always be in place during cooking.
3. Shut the door. Make sure that it is firmly closed.
- 1 When the oven door is opened, the light turns off.
- 2 The oven door can be opened at any time during operation by pressing the door release button on the control panel. The oven will automatically shut off. To restart the oven, close the door and then touch START.
- 3 Each time a pad is touched, a BEEP will sound to acknowledge the touch.
- 4 The oven automatically cooks on full power unless set to a lower power level.
- 5 The display will show “: 0” when the oven is plugged in.
- 6 Time clock returns to the present time when the cooking time ends.
- 7 When the STOP/CLEAR pad is touched during the oven operation, the oven stops cooking and all information retained. To erase all information(except the present time), touch the STOP/CLEAR pad once more. If the oven door is opened during the oven operation, all information is retained.
- 8 If the START pad is touched and the oven does not operate, check the area between the door and door seal for obstructions and make sure the door is closed securely. The oven will not start cooking until the door is completely closed or the program has been reset.

Make sure the oven is properly installed and plugged into the electrical outlet.

## WATTAGE OUTPUT CHART

• The power-level is set by pressing the POWER pad. The chart shows the display, the power level and the percentage of power.

Touch POWER pad	Power level (Display)	Approximate Percentage of Power
once	P-HI	100%
twice	P-90	90%
3 times	P-80	80%
4 times	P-70	70%
5 times	P-60	60%
6 times	P-50	50%
7 times	P-40	40%
8 times	P-30	30%
9 times	P-20	20%
10 times	P-10	10%
11 times	P-00	0%

# HOW TO SET THE OVEN CONTROLS

## SETTING THE CLOCK

When the oven is first plugged in, the display will flash " : 0" and a tone will sound. If the AC power ever goes off, the display shows " : 0" when the power comes back on.



1. Touch **CLOCK** pad.  
This is a 12 hour clock system.
2. Touch **CLOCK** pad once more.  
This is a 24 hour clock system.

**NOTE :** This oven has multiple clock systems. If you want 12 hour clock system, omit this step.

3. Enter the correct time of day by touching the numbers in sequence.

4. Touch **CLOCK** pad.



The display stops blinking, and the colon starts blinking. If you selected 12 hour clock system, this digital clock allows you to set from 1:00 to 12:59. If you selected 24 hour clock system, this digital clock allows you to set from 0:00 to 23:59.

**NOTE:** If you attempt to enter an incorrect time, the time will not be set and an error signal tone will sound. Touch the **CLOCK** pad and re-enter the time.

## TIME DEFROSTING

When DEFROST is selected, the automatic cycle divides the defrosting time into periods of alternating defrost and stand times by cycling on and off.

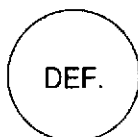

1. Touch **DEF.** pad.
2. Touch number pads for the desired defrosting time.

The Def. indicator lights and " : 0" is displayed.

The display will show what you touched.

**Note :** Your oven can be programmed for 59 minutes 99 seconds. ( 59 : 99 )

3. Touch **START** pad.

When you touch **START** pad, the Def. indicator starts blinking to show the oven is in the DEFROST mode. The display counts down the time to show you how much defrosting time is left in the DEFROST mode. The oven beeps during the defrosting cycle to signal that the food needs to be turned or rearranged. When the defrosting time ends, you will hear 3 beeps.

## AUTO DEFROSTING

AUTO DEFROST lets you easily defrost food by eliminating guesswork in determining defrosting time. The minimum weight for Auto Defrost is 0.5 pounds. The maximum weight for Auto Defrost is 3.0 pounds. Follow the steps below for easy defrosting.

- |   |  |   |
|---|--|---|
| <div style="border: 1px solid black; border-radius: 50%; width: 40px; height: 40px; display: flex; align-items: center; justify-content: center; margin: 0 auto;"> <b>MEAT</b> </div> | <p>1. Touch MEAT pad.</p>  | <p>The lb indicator light and " 1.0 " is displayed.</p> |
|   | <p>2. Select the desired defrosting weight.<br/>(Refer to the auto defrost chart below.)</p> | <p>The display will show what you touched.</p>          |
|   | <p>3. Touch START pad.</p>   | <p>MEAT DEFROSTING begins.</p>                          |

- |  |  |   |
|--|--|---|
| <div style="border: 1px solid black; border-radius: 50%; width: 40px; height: 40px; display: flex; align-items: center; justify-content: center; margin: 0 auto;"> <b>POULTRY</b> </div> | <p>1. Touch POULTRY pad.</p>   | <p>The lb indicator light and " 1.5 " is displayed.</p> |
|  | <p>2. Select the desired defrosting weight.<br/>(Refer to the auto defrost chart below.)</p> | <p>The display will show what you touched.</p>          |
|  | <p>3. Touch START pad.</p>   | <p>POULTRY DEFROSTING begins.</p>                       |

- |   |  |   |
|---|--|---|
| <div style="border: 1px solid black; border-radius: 50%; width: 40px; height: 40px; display: flex; align-items: center; justify-content: center; margin: 0 auto;"> <b>FISH</b> </div> | <p>1. Touch FISH pad.</p>  | <p>The lb indicator light and " 0.5 " is displayed.</p> |
|   | <p>2. Select the desired defrosting weight.<br/>(Refer to the auto defrost chart below.)</p> | <p>The display will show what you touched.</p>          |
|   | <p>3. Touch START pad.</p>   | <p>FISH DEFROSTING begins.</p>                          |

### \* AUTO DEFROST CHART

Touch pad	MEAT	POULTRY	FISH
once	1.0 lb	1.5 lb	0.5 lb
twice	1.5 lb	2.0 lb	1.0 lb
3 times	2.0 lb	2.5 lb	1.5 lb
4 times	2.5 lb	3.0 lb	2.0 lb

The defrosting time is automatically determined by the weight selected. When you touch START pad, the lb indicator goes off and the Def. indicator blinks and the defrosting time counts down in the display window. The oven beeps during the defrosting cycle to signal that the food needs to be turned or rearranged. When the defrosting time ends, you will hear 3 beeps.

## COOKING IN ONE STAGE

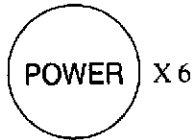

1. Touch POWER pad.  
(Select the desired power level.)

The M/W indicator lights.  
The display will show what you touched.  
This example shows power level 5.

**Note :** If steps 1 is omitted, the oven will cook at full power.

2. Touch number pads for the cooking time.

The display will show what you touched.

**Note :** Your oven can be programmed for 59 minutes 99 seconds. ( 59 : 99 )

3. Touch START pad.

When you touch START pad, the M/W indicator starts blinking to show the oven is cooking. The display counts down the time to show how much cooking time is left. When the cooking time ends, you will hear 3 beeps.

**NOTE:** Using lower power levels increases the cooking time which is recommended for foods such as cheese, milk and slow cooking of meats.

## COOKING IN TWO STAGES

All recipes require the frozen foods to be defrosted fully before cooking.  
This oven can be programmed to automatically defrost foods before cooking.



1. Touch DEF. pad.

The Def. indicator lights and " : 0" is displayed.

2. Touch number pads for the defrosting time you want.

The display will show what you touched.

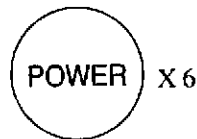

3. Touch POWER pad.  
(Select the desired power level. )

The M/W indicator lights and "P-HI" is displayed.  
The display will show what you touched.  
This example shows power level 5.

4. Touch number pads for the desired cooking time.

The display will show what you touched.

5. Touch START pad.

When you touch START pad, the Def. and M/W indicators come on to confirm the power levels selected. The Def. indicator starts blinking to show you that the oven is in DEFROST mode. The display counts down the time remaining in DEFROST mode. When the oven beeps, turn over, break apart and/or redistribute the food. At the end of DEFROST mode, the oven will beep and start M/W cook. The Def. indicator goes off and the M/W indicator starts blinking. The display counts down the time remaining in M/W mode. When M/W cook ends, you will hear 3 beeps.

## KITCHEN TIMER MODE

KITCHEN TIMER operates as a minute timer, can be set to delay cooking and used to set a holding time after cooking. However delay cooking can not be programmed for defrost. KITCHEN TIMER operates without microwave energy.

### HOW TO USE AS A MINUTE TIMER



1. Touch KITCHEN TIMER pad. The Timer indicator lights and “ : 0 ” is displayed.
2. Press the amount of time you want to count down. The display will show what you touched.
3. Touch START pad.

The Timer indicator starts blinking and the display counts down the time remaining in KITCHEN TIMER mode. When KITCHEN TIMER mode ends, you will hear 3 beeps.

### HOW TO DELAY THE START OF COOKING



1. Touch KITCHEN TIMER pad. The Timer indicator lights and “ : 0 ” is displayed.
2. Press the amount of time you want to delay. The display will show what you touched.
3. Program the desired power level and cooking time for food to be cooked. The M/W indicator lights and the selected power level & cooking time are displayed.
4. Touch START pad.

When you touch START pad, the Timer indicator starts blinking and the display counts down the time remaining in KITCHEN TIMER mode. When KITCHEN TIMER mode ends, the oven will beep. The Timer indicator goes off and M/W indicator starts blinking. The display counts down the time remaining in M/W mode. When M/W cook ends, you will hear 3 beeps.

### HOW TO SET HOLDING TIME

1. Program the desired cooking time. The M/W indicator lights and the selected time is displayed.
2. Touch KITCHEN TIMER pad. The Timer indicator lights and “ : 0 ” is displayed.
3. Press the amount of time you want the oven to hold. The display will show what you touched.
4. Touch START pad.

The M/W indicator starts blinking and the display counts down the time remaining in M/W mode. When the M/W cook ends, the oven will beep. The M/W indicator goes off and Timer indicator starts blinking. The display counts down the time remaining in KITCHEN TIMER mode. When the KITCHEN TIMER mode ends, you will hear 3 beeps.

**Note :** Your oven can be programmed for 59 minutes 99 seconds. ( 59 : 99 )

## QUICK COOK

QUICK COOK allows you to reheat for 30 seconds at 100% (full power) by simply touching the QUICK COOK pad. By repeatedly touching the QUICK COOK pad, you can also extend reheating time to 5 minutes by 30 second increments.



1. Touch QUICK COOK pad.

When you touch QUICK COOK, ": 30" is displayed.

After 1.5 seconds, the oven starts reheating.

## ONE TOUCH COOKING

One touch cooking allows you to cook or reheat many of your favorite foods by touching just one pad. To increase quantity, touch the chosen pad until number in display is same as the desired quantity to cook (except for POPCORN).

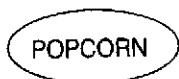

1. Touch POPCORN pad once for 3.5 oz bag.

When you touch POPCORN pad once, "3.5" is displayed.

After 1.5 seconds, the display is changed into cooking time and the oven starts cooking.

- NOTE:**
1. Use prepackaged room-temperature microwave popcorn.
  2. Place bag in oven according to manufacturer's directions.
  3. Pop only one bag at a time.
  4. After popping, open bag carefully: popcorn and steam are extremely hot.
  5. Do not reheat unpopped kernels or reuse bag.
  6. Do not leave oven unattended while popping popcorn.

**CAUTION:** If prepackaged popcorn is of a different weight than the recommended weight, do not use the popcorn pad. Follow the manufacturer instruction.



1. Touch FROZEN PIZZA pad once for 7 oz pizza or twice for 14 oz pizza.

When you touch FROZEN PIZZA pad once, "7" is displayed.

After 1.5 seconds, the display is changed into the cooking time and the oven starts cooking.

### \* FROZEN PIZZA \*

- 7 oz : Touch FROZEN PIZZA once.
- 14 oz : Touch FROZEN PIZZA twice within 1.5 seconds.

- NOTE:**
1. Use only one frozen pizza at a time.
  2. Use only frozen pizza made for microwave ovens.
  3. If the cheese of frozen pizza does not melt sufficiently, cook a few seconds longer.
  4. Some brands of frozen pizza may require more or less cooking time.



## ONE TOUCH COOKING (continued)

### BEVERAGE

1. Touch BEVERAGE pad once for 1 cup, twice for 2 cups or three times for 3 cups.

When you touch BEVERAGE pad once, "1" is displayed.  
After 1.5 seconds, the display is changed into cooking time and the oven starts cooking.

#### \* BEVERAGE \* (200ml/cup)

- 1 cup (mug) : Touch BEVERAGE once.
- 2 cups (mugs) : Touch BEVERAGE twice within 1.5 seconds.
- 3 cups (mugs) : Touch BEVERAGE three times within 1.5 seconds.

### DINNER PLATE

1. Touch DINNER PLATE pad once for 12 oz of dinner plate or twice for 15 oz of dinner plate.

When you touch DINNER PLATE pad once, "12" is displayed.  
After 1.5 seconds, the display is changed into cooking time and the oven starts cooking.

#### \* DINNER PLATE \*

- 12 oz : Touch DINNER PLATE once.
- 15 oz : Touch DINNER PLATE twice within 1.5 seconds.

### FRESH VEGETABLE

1. Touch FRESH VEGETABLE pad once for 7 oz of fresh vegetable or twice for 14 oz of fresh vegetable.

When you touch FRESH VEGETABLE pad once, "7" is displayed.  
After 1.5 seconds, the display is changed into cooking time and the oven starts cooking.

#### \* FRESH VEGETABLE \*

- 7 oz : Touch FRESH VEGETABLE once.
- 14 oz : Touch FRESH VEGETABLE twice within 1.5 seconds.

### FROZEN VEGETABLE

1. Touch FROZEN VEGETABLE pad once for 7 oz of frozen vegetable or twice for 14 oz of frozen vegetable.

When you touch FROZEN VEGETABLE pad once, "7" is displayed.  
After 1.5 seconds, the display is changed into cooking time and the oven starts cooking.

#### \* FROZEN VEGETABLE \*

- 7 oz : Touch FROZEN VEGETABLE once.
- 14 oz : Touch FROZEN VEGETABLE twice within 1.5 seconds.

## **MORE/LESS**

---

To alter one touch cooking or cooking time whilst oven is in operation, use MORE or LESS.(except for defrosting)

Press MORE/LESS to increase/decrease the one touch cooking time in multiples of 10 seconds.

The overall one touch cooking time can be increased to a maximum of 59 minutes 50 seconds.

Press MORE/LESS to increase/decrease the cooking time in multiples of 1 minute.

The overall cooking time can be increased to a maximum of 59 minutes.

---

## **CHILD SAFETY LOCK**

---

The safety lock prevents unwanted oven operation such as by small children.

To set, press and hold STOP/CLEAR for 3 seconds, a beep sounds and Lock indicator lights.

To cancel, press and hold STOP/CLEAR for 3 seconds, a beep sounds and Lock indicator goes off.

---

## **TO STOP THE OVEN WHILE THE OVEN IS OPERATING**

---

1. Press STOP/CLEAR pad.
  - You can restart the oven by touching START pad.
  - Touch STOP/CLEAR once more to erase all instructions.
  - You must enter in new instructions.
2. Open the door.
  - You can restart the oven by closing the door and touching START.

**NOTE:** Oven stops operating when door is opened.

# COOKING GUIDE

---

## THE PRINCIPLES OF MICROWAVE COOKING

---

*Microwaves are a form of high frequency radio waves similar to those used by a radio including AM, FM and CB. They are, however, much shorter than radio waves; approximately four to six inches long with a diameter of about 0.6cm (1/4 inch). Electricity is converted into microwave energy by the magnetron tube. From the magnetron tube, microwave energy is transmitted to the oven cavity where it is reflected, transmitted and absorbed.*

### Reflection

Microwaves are reflected by metal just as a ball is bounced off a wall. A combination of stationary (interior walls) and rotating metal (turntable or stirrer fan) helps assure that the microwaves are well distributed within the oven cavity to produce even cooking.

### Transmission

Microwaves pass through some materials such as paper, glass and plastic much like sunlight shining through a window. Because these substances do not absorb or reflect the microwave energy, they are ideal materials for microwave oven cooking containers.

### Absorption

During cooking, microwaves will be absorbed by food. They penetrate to a depth of about 1.8 to 3.7cm (3/4 to 1 1/2 inches). Microwave energy excites the molecules in the food (especially water, fat and sugar molecules), and causes them to vibrate at a rate of 2,450,000,000 times per second. This vibration causes friction, and heat is produced. If you vigorously rub your hands together, you will feel heat produced by friction. The internal cooking of larger foods is done by conduction. The heat which is produced by friction is conducted to the center of food.

Foods also continue to cook by conduction during standing time.

Because microwaves dissipate, much like sunlight as it reaches the Earth's surface, they cannot be stored in food.

---

## MICROWAVE UTENSILS

---

### Glass, Ceramic and China

**Ovenproof glass or ceramic baking dishes** are the most-used microwave utensils. Many of these items are readily available in most homes: glass measures, custard cups, mixing bowls, covered casserole, oblong baking dishes, pie dishes and round or square cake dishes.

**Tableware** can be used for microwave cooking. If tableware is marked ovenproof, it is frequently safe to use in the microwave oven.

**Jars and bottles** can be used to warm food to serving temperature, if the lid is removed first. Cooking should not be done in these containers since most are not heat resistant and during extended cooking times, heat from the food would cause cracking or breaking.

**Do not use** dishes with silver, gold, platinum or other metal trim. Arcing may occur and/or the dish may break.

**Do not use** delicate glassware. Although the glassware may be transparent to microwave energy, the heat from the food may cause the glassware to crack.

## **Plastics**

**Plastic dishes, picnic ware, thermal cups, mugs and bowls** may be used in the oven for short period of time. But none of these should be used in the oven for prolonged period because distortion and melting may occur. Check manufacturer's recommendations concerning microwave safety.

**Plastic wrap** can be used to cover dishes in most recipes. Use plastic wrap as a tight covering, but pierce it before removing to prevent steam burns.

**Plastic cooking bags** should be slit before cooking so excess steam can escape. Do not wire twist-ties to close bag. They can act as an antenna and cause arcing (blue sparks). Wire twist-ties could damage the oven.

## **Paper**

**Paper cups, wax paper, napkins, paper towels, plates and paper cartons** may be used for cooking. Prolonged time in the oven can cause paper to burn. Wax paper is suitable to use to prevent spatter.

**Do not use** recycled paper products, such as brown paper bags, since they contain impurities, which may cause arcing and damage the oven.

## **Straw, Wicker and Wood**

Straw and wicker baskets may be used in the oven for the very short time it takes to heat rolls. Large wooden utensils, such as bowls or cutting boards should not be used for prolonged cooking as the microwave energy may cause the wood to become dry and brittle. However, wooden spoons or wood-handled rubber spatulas can be left in the oven for short periods of time.

## **Metal**

**Metal utensils** should not be used in the oven. Since microwave energy is reflected by metal, foods in metal containers will not cook evenly with the possibility of "arcing". Arcing may cause damage to the oven walls.

## **Special Microwave Accessories**

**Browning dishes** can be used for searing, browning and frying during microwave cooking. Browning dish has a special coating on the bottom that attracts microwave energy when the dish is preheated in a microwave oven. Do not preheat the browning dish longer than the manufacturer's recommendation.

**Roasting rack** to hold the food away from the liquid which accumulates as meat cooks. It is ideal for bacon and assists in reheating pastry and other dry items.

**Cake dishes**-cupcake, ring molds and cake pans are designed to ensure even results when cooking cakes in a variety of shapes and sizes.

---

## FOOD CHARACTERISTICS

---

*The speed and evenness of microwave cooking is affected by the foods themselves. Microwaves penetrate foods to a depth of 1.8 to 3.7cm (3/4 to 1 1/2 inches) on all surfaces; top, bottom and sides. The interior of foods greater than 5cm(2-inches) in diameter heats by conduction, as it does in conventional cooking. Foods with high water, fat or sugar content respond quickly to microwave energy. Understanding the way food characteristics influence cooking will help you enjoy the benefits of microwave cooking.*

**Quantity:** The amount of food placed in a microwave oven has a direct effect on the cooking time. Small amounts of food or liquid require less cooking time than larger amounts of the same substance. That's because small quantities receive concentrated amounts of microwaves. As the quantity increases, concentration decreases.

**Size:** Small pieces cook faster than large ones. To the speed cooking, cut pieces smaller than 5cm (2-inches), so microwaves can penetrate to the middle from all sides. Pieces which are similar in size and shape will cook more evenly.

**Shape:** Many foods are uneven-like chicken, ribs or broccoli. The thin parts will cook faster than the thick parts while uniformly thick foods cook evenly.

To compensate for irregular shapes, place thin pieces toward the center of the dish and thicker pieces toward the edge of the dish.

Round shaped foods cook faster than square or oblong shapes.

**Starting Temperature:** Frozen or refrigerated food will takes longer to cook than food at room temperature. Room temperatures vary with the time of year, therefore cooking times may be longer on cold winter days.

**Bone and Fat:** Because bones conduct heat, the side of meat with the bone will cook first, while boneless cuts cook slower but more evenly. Fat attracts microwaves.

Large roasts, turkeys and chickens brown during prolonged cooking as their natural fats are drawn to the surface. The centers of these foods are cooked by heat conduction.

**Moisture Content:** Microwave are attracted by moisture. Naturally moist foods microwave better than dry foods.

Add a minimum of liquid to moist foods, as excess water slows cooking. Prick foods with skins like those on potatoes or squash allowing internal steam to escape.

**Density:** The density of food determines how easily the microwaves can penetrate and how quickly it will cook.

Porous foods, like ground beef or mashed potatoes, microwave faster than dense ones like steak or whole potatoes.

**Piercing:** Steam builds up pressure in foods which are tightly covered by a skin or membrane Pierce potatoes, egg yolks and chicken livers to prevent bursting.

---

## MICROWAVE TECHNIQUES

---

*Many of the techniques of microwave cooking are similar to those used in conventional cooking. They help equalize energy in the food to allow even cooking. Some techniques also shorten cooking time, resulting in the full benefit of microwave speed.*

**Stirring:** Stir foods from outside to center of dish once or twice during cooking to equalize heat and speed microwave cooking. Foods will not burn or stick, therefore there is no need to stir continuously as you do in conventional cooking.

**Turning:** This helps food heat evenly and is done once during the cooking time of large, dense foods such as roasts or whole poultry. When cooking hamburgers without a cover, turning is often required.

**Arrangement:** Arrange foods with thin or delicate ends, like drumsticks or asparagus spears, with the thick or tougher portions to the outside of the dish. The parts which need more cooking will receive more energy, therefore food will microwave evenly.

**Spacing:** Individual foods, such as baked potatoes and cupcakes will cook more evenly if placed in the oven an equal distance apart. If possible, arrange foods in a circular pattern. Similarly, when placing foods in a baking dish, arrange around the outside of dish, not lined up next to each other. Food should not be stacked on top of each other.

**Rearrangement:** Rearrange overlapping areas, like tails of long fish fillets, from top to bottom, and closely packed pieces, like meat balls, from outside to the center of the dish.

**Standing Time:** Standing time is especially important in microwave cooking. Microwave energy creates heat in the outer layers of the food. As a result of normal conduction, the food continues to cook for a few minutes after removal from the oven. Letting roasts, large whole vegetables, casseroles and cakes stand to finish cooking allows the centers to cook completely without overcooking, drying or toughening the outsides.

**Covering:** Covering speeds cooking time, retains moisture, tenderizes, insures even cooking and prevents spattering. Casserole lids or plastic wrap are used for a tighter seal. Vent plastic by turning back one edge at the side of dish to form a narrow slot where excess steam can escape. Various degrees of moisture retention are also obtained by using wax paper or paper towels.

**Browning:** Microwave energy cooks some foods so quickly that the fats and sugars within the food do not have time to caramelize and give a "browned" appearance. Browning agents do not affect the quality of microwaved foods, but can add color and flavor. For meats and poultry, use bouquet sauce diluted with water or melted butter; soy, Worcestershire, barbecue or steak sauce ; a sprinkling of paprika or dry gravy mix; jelly glaze or crumb coating. Frostings and toppings finish cakes and breads. Top casseroles at the end of microwaving with grated cheese or crumbs.

# AUTO DEFROSTING

Defrosting in the microwave oven is a great time saver. The AUTO DEFROST pad simplifies the process greatly. Items can be defrosted with appropriate power settings which adjust automatically during the defrosting cycle. Consult charts in this chapter for directions on how to use this helpful feature.

## GENERAL INFORMATION

- ⚡ Put the food in a microwave casserole (small pieces such as cubes or strips).
- ⚡ To determine the weight of the food items, use the weight on the package as purchased or weigh at home on a kitchen scale. Round the number to the nearest tenth of a 'kg' and select that desired defrosting weight.
- ⚡ The shape of food items, especially larger ones, will vary and affect the way they defrost. On the defrosting charts, note that large items require a 2+1 touch for more effective defrosting. Always check the status after the standing time. Fish, seafood and poultry should still be somewhat icy in the center then held under cold running water to finish defrosting. If more time is needed, use DEFROST by time to add time in small increments.
- ⚡ Halfway through the defrosting process, a series of beeps will indicate that it is time to **change** the position of the item being defrosted. This includes turning over the item, rotating the item, separating defrosted pieces or sections or shielding.
  - ⚡ Shielding means to use a 5cm strip of aluminum foil to protect thinner or unevenly shaped parts from beginning to cook. Microwave energy will not penetrate the foil. Some rules apply to the use of foil:
    - Never cover more than one-third of any item.
    - Do not let the foil pieces touch each other or the sides of the microwave oven.
    - Be sure that all ends are tucked under and lie flat to the food. Remember to adjust foil when item is turned over and cover with wax paper.
- ⚡ To prepare food for freezer storage (and later defrosting), wrap tightly in moisture proof packaging. If using freezer plastic bags, be sure to let all the air out to prevent freezer burn on the food. Package so food is as evenly shaped as possible for ease in defrosting.

# FISH-AUTO DEFROSTING

Refer to page 12 of this cookbook for general information on the AUTO DEFROST pad.

**AUTO DEFROST BY WEIGHT :** Press **AUTO DEFROST** to defrost by weight. Enter the weight with each item pad. (MEAT, POULTRY, and FISH); press **START**. When several beeps sound halfway through defrosting, follow the "Special Instructions" in the chart below. Press **START** again to continue defrosting.

**DEFROST by TIME :** Press **DEF.** pad to defrost by time. Check time per pound in chart below and multiply by the weight of the item. Enter time with number pads; press **START**. When several beeps sound halfway through defrosting, follow "Special Instructions" in the chart below. Press **START** again to continue defrosting.

ITEM	SPECIAL INSTRUCTIONS	BY TIME
Fish Fillets frozen in block	Place fillets on a microwave plate. At beeps, turn over block of fish. Separate fillets, if possible. Press <b>START</b> to continue defrosting. Let stand 10 minutes then finish with cold running water (about 5 minutes).	5 minutes per pound
Individual Fish Fillets or Fish Steaks	Place fish on a microwave plate. At beeps, turn fish over. Press <b>START</b> to continue defrosting. Let stand 5 minutes then finish with cold running water (about 5 minutes).	5 minutes per 1 pound
Shrimp	Place shrimp in a glass casserole. At beeps, separate any defrosted shrimp and rearrange. Press <b>START</b> to continue defrosting. Let stand 5 minutes then finish with cold running water (about 5 minutes).	4 minutes per 1 pound
Lobster Tail (0.5 lb. each)	Place lobster on a microwave plate. At beeps, rearrange tails. Shield thinner end with 2-inch strip of foil; tuck all ends under. Press <b>START</b> to continue defrosting. If defrosting more than 1 lobster tail, arrange in circle. Let stand 5 minutes then finish with cold running water (about 5 minutes).	4 minutes per 1 pound



# PORK-AUTO DEFROSTING

Refer to page 12 of this cookbook for general information on the AUTO DEFROST pad.

**DEFROST by TIME :** Press **DEF** pad to defrost by time. Check time per pound in chart below and multiply by the weight of the item. Enter time with number pads; press **START**. When several beeps sound halfway through defrosting, follow the "Special Instructions" in the chart below. Press **START** again to continue defrosting.

ITEM	SPECIAL INSTRUCTIONS	BY TIME
Pork Strips	Place pork strips on a microwave plate. At beeps, separate and turn over. Press <b>START</b> to continue defrosting. Let stand 20 minutes.	8 minutes per pound
Pork Cubes	Place pork cubes in a microwave plate. At beeps, separate and rearrange. Press <b>START</b> to continue defrosting. Let stand 20 minutes.	8 minutes per pound
Pork Loin Roast, boneless	Place roast on a microwave plate. Press <b>MEAT</b> pad of <b>AUTO DEFROST</b> and select the weight. Press <b>START</b> . At beeps, turn over and shield before continuing. After first set <b>DEF</b> pad enter half of the original time. Press <b>START</b> to continue defrosting. Let stand 30 minutes.	10 minutes per pound
Bulk Pork Sausage	Cut metal holders off both ends of sausage. Place on a microwave plate. At beeps, remove defrosted meat. Let stand 10 minutes.	7 minutes per pound
Pork Chops	Place on a microwave plate. At beeps, separate, turn over and shield bone or outer edge if boneless. Let stand 20 minutes.	7 minutes per pound

# BEEF-AUTO DEFROSTING

Refer to page 12 of this cookbook for general information on the AUTO DEF pad.

**AUTO DEFROST BY WEIGHT:** Press **AUTO DEFROST** to defrost by weight. Enter the weight with each item's pads. (MEAT, POULTRY and FISH); press **START**. When several beeps sound halfway through defrosting, follow the "Special Instructions" in the chart below. Press **START** again to continue defrosting.

**DEFROST by TIME :** Press **DEF.** to defrost by time. Check time per pound in chart below and multiply by the weight of the item. Enter time with number pads; press **START**. When several beeps sound halfway through defrosting, follow the "Special Instructions" in the chart below. Press **START** again to continue defrosting.

ITEM	SPECIAL INSTRUCTIONS	BY TIME
Beef Rolled Rump Roast, boneless -- or -- Beef Round Sirloin Tip Roast, boneless -- or -- Beef Eye of Round -- or -- Beef Flank Steak	Place roast (up to 2.5 pounds) on a microwave plate. Press the weight you want with MEAT pad. Press <b>START</b> . At beeps, turn over and shield before continuing. After first cycle, reset DEF. and enter half of the first time. Press <b>START</b> to continue defrosting. Let stand 30 minutes.	10 minutes per pound
Ground Beef	Place beef on a microwave plate; At beeps, remove any defrosted meat. Press <b>START</b> to continue defrosting. Let stand 15 minutes.	8 minutes per pound
Beef Hamburger Patties	Stack hamburgers on a microwave plate. At beeps, turn patties over. Let stand 10 minutes.	8 minutes per pound
Beef Strips, boneless	Place beef strips on a microwave plate. At beeps, separate and turn over. Press <b>START</b> to continue defrosting. Let stand 20 minutes.	7 minutes per pound
Beef Cubes, boneless	Place beef cubes a microwave plate. At beeps, separate and rearrange. Press <b>START</b> to continue. Let stand 20 minutes.	8 minutes per pound
Beef Short Ribs (up to 2.5 pounds)	Arrange ribs on a microwave plate. At beeps, turn over and rearrange. Press <b>START</b> to continue defrosting. Let stand 20 minutes	8 minutes per pound

# LAMB-AUTO DEFROSTING

Refer to page 12 of this book for general information on the AUTO DEFROST pad.

**AUTO DEFROST BY WEIGHT :** Press **AUTO DEFROST** to defrost by weight. Enter the weight with each items pad.(MEAT, POULTRY and FISH); press **START**. When several beeps sound halfway through defrosting, follow the "Special Instructions" in the chart below. Press **START** again to continue defrosting.

**DEFROST by TIME :** Press **DEF.** to defrost by time. Check time per pound in chart below and multiply by the weight of the item. Enter time with number pads; press **START**. When several beeps sound halfway through defrosting, follow the "Special Instructions" in the chart below. Press **START** again to continue defrosting.

ITEM	SPECIAL INSTRUCTIONS	BY TIME
Lamb Chops	Place lamb chops on a microwave plate in a circle. At beeps, turn over and shield bones. Press <b>START</b> to continue defrosting. Let stand 20 minutes.	7 minutes per pound
Lamb Leg, boneless, rolled	Place lamb on a microwave plate. Press <b>MEAT</b> pad and select weight. Press <b>START</b> . At beeps, turn over and shield before continuing. After first cycle, press <b>DEF.</b> pad and enter half of the original time. Press <b>START</b> to continue defrosting. Let stand 30 minutes.	7 minutes per pound
Lamb Cubes	Place lamb cubes on a microwave plate. At beeps, separate and rearrange. Press <b>START</b> to continue defrosting. Let stand 20 minutes.	8 minutes per pound

# POULTRY-AUTO DEFROSTING

Refer to page 12 of this book for general information on the AUTO DEFROST pad.

**AUTO DEFROST BY WEIGHT :** Press **AUTO DEFROST** to defrost by weight. Enter the weight with each item pad (MEAT, POULTRY and FISH); press **START**. When several beeps sound halfway through defrosting, follow the "Special Instructions" in the chart below. Press **START** again to continue defrosting.

**DEFROST by TIME :** Press **DEF.** to defrost by time. Check time per pound in chart below and multiply by the weight of the item. Enter time with number pads; press **START**. When several beeps sound halfway through defrosting, follow the "Special Instructions" in the chart below. Press **START** again to continue defrosting.

ITEM	SPECIAL INSTRUCTIONS	BY TIME
Whole Chicken -- or -- Cornish Hen	Place chicken, breast side down, on a microwave plate. Press <b>POULTRY</b> pad and select weight. Press <b>START</b> . At beeps, turn over and shield before continuing. Let stand 20 minutes. If needed, finish defrosting under cold running water.	10 minutes per pound
Whole Chicken, cut up -- or -- Chicken Pieces, bone-in	Place chicken on a microwave plate. Press <b>POULTRY</b> pad and select weight. Press <b>START</b> . At beeps, turn over, separate and rearrange; shield bones. Let stand 15 minutes. If needed, finish defrosting under cold running water.	10 minutes per pound
Chicken Wings	Place wings on a microwave plate. Press <b>POULTRY</b> pad and select weight. At beeps, separate and turn over. Press <b>START</b> to continue defrosting. Let stand 20 minutes. If needed, finish defrosting under cold running water.	7 minutes per pound
Chicken Breasts, boneless -- or -- Chicken Thighs, boneless	Place them on a microwave plate. Press <b>POULTRY</b> pad and select weight. At beeps, separate and turn over. Press <b>START</b> to continue defrosting. Let stand 15 minutes.	7 minutes per pound

# EGGS AND CHEESE

Eggs and cheese are delicate foods requiring care in microwave cooking. Piercing the yolks of eggs helps to release steam during cooking. Stirring egg mixtures frequently helps distribute the heat evenly. Because the microwave energy cooks so quickly, always check to see if the eggs are done to your satisfaction after the standing time. At this time, stir, rearrange or turn over. If needed, add additional time gradually. To cook only one egg, try a lower Power setting until you get satisfactory results.

Shredded soft cheeses and grated hard cheeses melt well if stirred

into a hot mixture. Cheese may not look melted so always stir before determining if cheese is melted enough. Sprinkle cheese over a hot casserole in a thicker layer at the edges. Microwave energy cooks from the outside in, so the outer edges will melt faster than the center.

For cheese melt sandwiches, heat filling where possible before adding it to the bread. Top each sandwich with a slice of cheese and cook on P-HI for about 15 to 20 seconds for one sandwich, about 30 seconds for two sandwiches and about 1 minute for four sandwiches or until cheese is melted.

## HARD-COOKED EGGS

4 eggs

1. In a 4-cup glass measure, break eggs. Pierce each yolk twice with a fork.
2. Cover with wax paper. Press P-50. Cook for 3 minutes; stir to move cooked eggs from outer edges to the center - do not mix whites and yolks. Press P-50. Continue cooking for 3~4 minutes or until yolks are set; stir once during cooking. Let stand 3 minutes.

4 servings

## CREAMY MACARONI AND CHEESE

- 1 cup (4 oz.) uncooked macaroni
- 1 quart hot water
- 1/2 teaspoon salt
- 2 tablespoons margarine or butter
- 1/4 cup chopped onion
- 2 tablespoons flour
- 1/2 teaspoon dry mustard
- 1/4 teaspoon salt
- 1/8 teaspoon pepper
- 1 1/4 cups milk
- 1 1/2 cups (6 oz.) shredded cheddar cheese

1. In a 2-quart glass casserole, combine macaroni, water and salt. Cook, uncovered, on P-HI for 7 minutes; stir once during cooking. Continue cooking on P-HI for 8 to 10 minutes or until macaroni is tender. Drain; rinse macaroni in a colander with hot water.
2. Heat margarine in same casserole for 30 to 40 seconds or until melted. Add onion. Cook, uncovered, on P-HI for 1 minute or until onion is tender.
3. Add flour, mustard, salt and pepper. Gradually stir in milk. Cook, uncovered, on P-HI for 7 to 8 minutes or until sauce boils and thickens; stir after each minute. Stir in cheese. Continue cooking on P-HI for 1 minute.
4. Add macaroni to cheese sauce; mix well. Cook, uncovered, on P-HI for 5 minutes or until heated thoroughly; stir once during cooking. Let stand 1 minute.

4 servings

## CHEESE SPREAD

- 1 package (8 oz.) cream cheese
- 1/2 cup green onions
- 1 cup shredded carrots
- 2 teaspoons lime juice
- 1 cup (4 oz.) shredded Monterey Jack cheese
- 4 tablespoons toasted sliced almonds

1. In a 2-quart glass casserole put cream cheese, onions, carrots and lime juice.
2. Cook, uncovered, on P-HI for 4~5 minutes or until cream cheese is softened. Add Monterey Jack cheese; stir until well blended.
3. Spread on bread or crackers and top with almonds.

4 servings

# VEGETABLES

Vegetables are favorite foods when cooked in the microwave. Because they cook for a shorter time and require less water than conventional cooking, vegetables cooked by microwave energy retain more vitamins than when cooked by other methods.

To cook better in the microwave, vegetables should be cut into evenly sized pieces. Baked potatoes, squash, or vegetables with skins can be pierced with a fork and arranged in a circle for the best cooking results. Uneven vegetables such as asparagus or broccoli, can be arranged in the dish alternating thick and thin ends. Stirring, rearranging, turning over and rotating are effective techniques to

maximize the way microwave energy cooks vegetables.

Consult the "COOKING FRESH VEGETABLES" chart on page 32-35 of this cookbook for preparation and stand time suggestions and for directions to use the automatic FRESH VEGETABLE pad. See this chart for suggested times for 4 ounce single serving of vegetables.

Use care in removing lid to prevent steam burn. Standing time is an important element in successful cooking because additional cooking will take place then. Make a decision about desired doneness after the standing time then add more time, if needed.

## LIGHT BAKED POTATOES

- 4 baking potatoes, about 8 oz. each salt and pepper
  - 2 cups low fat cottage cheese
  - 1/2 cup sliced green onions
  - 2 tablespoons chopped fresh parsley
- Paprika

1. Scrub potatoes and pierce several times with a fork. Arrange in a circle on a microwave rack.
2. Cook, uncovered, on P-HI for 8 minutes. Turn each potato over. Continue cooking on P-HI for 7-9 minutes, or until potatoes are soft if squeezed lightly. Let stand for 5 minutes. Cut slit on top of potato and press ends to make opening for stuffing. Salt and pepper to taste.
3. Meanwhile in a small bowl, combine cottage cheese, green onions and parsley. Divide mixture evenly among potatoes. Arrange stuffed potatoes in a circle on a serving platter. Sprinkle with paprika

*4 servings*

## SPINACH AND ARTICHOKE DIP

- 2 tablespoons chopped onion
- 1 medium red bell pepper, chopped (about 1 cup)
- 1 clove garlic, minced
- 1 package (10 oz.) frozen chopped spinach, defrosted
- 1 can (14 oz.) artichoke hearts, drained and chopped
- 1 package (8 oz.) cream cheese, softened
- 1 tablespoon lemon juice
- 1 teaspoon seasoned salt
- 1/4 teaspoon hot pepper sauce

1. In a 2-quart casserole, combine onion, bell pepper, and garlic.
2. Cook, uncovered, on P-HI for 3 minutes or until red pepper is crisp-tender; drain spinach and squeeze dry. Add spinach, artichokes hearts, cream cheese, lemon juice, salt and hot pepper sauce to red pepper mixture; stir to mix well. Serve warm.

*3 cups*

## BROCCOLI AND CAULIFLOWER SALAD

- 1 cup broccoli florets
- 1 cup cauliflower florets
- 1/2 cup mayonnaise
- 1 to 2 teaspoons prepared mustard
- 1/2 teaspoon dried basil, crushed
- 1/4 teaspoon salt

1. In a 2-quart glass casserole, combine broccoli and cauliflower
  2. Cover with lid or vented plastic wrap. Cook on P-HI for 3 to 4 minutes or until vegetables are tender-crisp; cool.
  3. In a small bowl, combine mayonnaise, mustard, basil and salt. Pour over vegetables; toss gently to mix.
- 4 servings*

## HOT JALAPENO SALAD

- 1 1/2 cups shredded cabbage
- 1/2 cup shredded carrots
- 1/4 cup medium green bell pepper, cut into 1-inch long thin strips
- 1/2 cup sliced cherry tomatoes
- 1/4 cup sliced green onion
- 2 tablespoons fresh, chopped cilantro
- 1/4 cup Monterey Jack jalapeno cheese, cut into 1 inch cubes
- 3 oz. cream cheese, softened
- 1 tablespoon white wine vinegar

1. In a 1/2-quart glass casserole, combine cabbage, carrots, bell pepper, tomatoes, green onion and cilantro. Set aside.
  2. In a 4-cup glass measure, combine cheese cubes, creamed cheese and vinegar; blend well.
  3. Press P-30, Cook, uncovered, for 4 minutes; stir twice during cooking. Continue cooking on P-HI for 1 minute; stir. Let stand for 2 minutes; stir until smooth. Pour cheese over vegetable mixture; toss gently to mix.
  4. Cover with vented plastic wrap. Cook on P-HI for about 3 minutes or until mixture is heated thoroughly; stir once during cooking. Let stand for 2 minutes.
- 4 servings*

## CHINESE STIR-FRY

- 2 tablespoons vegetable oil
- 1 clove garlic, minced
- 1 teaspoon fresh ginger
- 1/4 cup sliced green onion
- 4 medium (or 12 small) carrots, peeled and sliced
- 1/2 cup green bell pepper, cut into strips
- 1 package (6 oz.) frozen pea pods
- 1 cup fresh bean sprouts
- 2 tablespoons soy sauce
- 1 cup sliced mushrooms

1. In a 2-quart glass casserole, combine oil, garlic, ginger and onion. Cook, uncovered, on P-HI for 1 minute. Add carrots and green pepper.
  2. Cover with lid or vented plastic wrap. Continue cooking on P-HI for 3 minutes.
  3. Add pea pods, bean sprouts and soy sauce, stirring to mix; cover. Continue cooking on P-HI for 3 minutes. Stir in mushrooms. Continue cooking on P-HI for 3 minutes; stir once. Let stand, covered, for 3 minutes.
- 4 servings*

## WILTED SPINACH SALAD

- 6 slices bacon
- 1/4 cup bacon drippings or oil
- 1/2 pound fresh spinach leaves
- 2 tablespoons sugar
- 2 tablespoons vinegar

1. Arrange bacon on microwave rack. Cover with microwave paper towel. Cook on P-HI for 4 to 5 minutes or until bacon is crisp, rearrange once during cooking. Pour 1/4 cup bacon drippings into a 2-cup glass measure; discard any remaining drippings. Drain and crumble bacon.
  2. Wash spinach leaves, pat dry and put in a serving bowl. Add sugar and vinegar to reserved drippings; stir to mix well.
  3. Cook, uncovered, on P-HI for 1 minute or until boiling. Carefully stir, then pour over fresh spinach. Serve immediately.
- 4 servings*

## VEGETARIAN CHILI

- 1/2 cup celery, chopped
- 1 small onion, chopped (about 1/2 cup)
- 1/2 medium green bell pepper, chopped (1/4 cup)
- 1 tablespoon chili powder
- 1 teaspoon salt
- 1/4 teaspoon crushed red pepper flakes
- 1/8 teaspoon freshly ground black pepper
- 1 can (15 1/2 oz.) mild chili beans in sauce, undrained
- 1 can (15 oz.) Great Northern beans, drained
- 1 can (15 oz.) chick peas (garbanzo beans), drained
- 2 cans (about 15 oz. each) diced tomatoes, undrained

1. In a 2-quart glass casserole, combine celery, onion and green pepper.
2. Cover with lid or vented plastic wrap. Cook on P-HI for 3 to 4 minutes or until vegetables are tender. Add chili powder, salt, red pepper and black pepper to vegetables; mix well. Stir in chili beans with sauce, Great Northern beans, chick peas and tomatoes.
3. Continue cooking on P-HI for 18 to 20 minutes or until heated thoroughly; stir once during cooking. Stir before serving.

**4 servings**

## GLAZED BABY CARROTS

- 1 pound peeled baby carrots
- 2 tablespoons butter
- 1 tablespoon brown sugar
- 1/2 teaspoon cinnamon
- dash ground cloves

1. In a 1 1/2-quart glass casserole, combine carrots, butter, brown sugar, cinnamon and cloves.
2. Cover with lid or vented plastic wrap. Cook on P-HI for 11-12 minutes or until carrots are tender; stir every 2 minutes during cooking. Let stand for 3 minutes.

**4 servings**

## CANDIED SWEET POTATOES

- 2 medium sweet potatoes (about 1 1/4 lbs.)
- 2 medium tart baking apples
- 1/4 cup apple cider or juice
- 1/4 cup firmly packed brown sugar
- 1 teaspoon cinnamon
- 2 tablespoons margarine or butter
- 1/4 cup coarsely chopped pecans or walnuts

1. Wash and peel sweet potatoes and apples; slice in 1/4-inch slices. Layer slices in a 1 1/2-quart glass casserole. Pour juice over the top. In a small bowl, combine brown sugar and cinnamon; sprinkle on top; cut margarine into small pieces; place evenly on top. Sprinkle with nuts.
2. Cover with lid or vented plastic wrap. Cook on P-HI for 13-16 minutes or until potatoes are tender.
3. Let stand for 3 minutes.

**4 servings**

## GREEN BEANS IN CREAM SAUCE

- 1 package (10 oz.) frozen French-style green beans
- 1 can (10 3/4 oz.) condensed cream of celery soup, undiluted
- 1/2 cup sliced fresh mushrooms
- 1/4 cup milk
- 1/2 teaspoon soy sauce
- 1 can (2.8 oz.) French fried onions

1. In a 2-quart glass casserole, place green beans. Cover with lid or vented plastic wrap. Cook on P-HI for 4 to 5 minutes or until heated. Let stand, covered, for 5 minutes; drain. Stir in mushrooms, soup, milk and soy sauce.
2. Continue cooking on P-HI for 5 minutes or until heated thoroughly. Add half onions; stir. Continue cooking on P-HI for 5 minutes. Sprinkle with remaining onions. Cook, uncovered, for 1 minute. Let stand, uncovered, for 2 minutes before serving.

**4 servings**



# COOKING FRESH VEGETABLES

Fresh vegetables retain nutrients when cooked in the microwave. Use this chart and the convenient ONE TOUCH COOK pad to prepare vegetables easily according to the chart. After cooking, let stand, covered, for 3 to 5 minutes. If more time is needed to finish cooking, add time slowly to prevent overcooking.

BY WEIGHT	ONE TOUCH COOKING
7oz. of any vegetable (2 servings)	Check preparation instructions in chart below. Press FRESH VEGETABLE pad once.
14oz. of any vegetable (4 servings)	Check preparation instructions in chart below. Press FRESH VEGETABLE pad twice; turn over, stir or rearrange.

ITEM	PREPARATION	BY TIME	STAND
Acorn Squash	See chart on page 35.		
Artichokes	See chart on page 35.		
Asparagus Spears (4 oz.) 1 serving	Wash; arrange in a glass pie plate. Add 2 tablespoons water. Cover with vented plastic wrap.	3 minutes	2 minutes
Beets, small whole (4 oz.) 1 serving	Wash, trim ends and pierce with a fork. Arrange in a glass pie plate; add 1/4 cup water. Cover with vented plastic wrap.	4 minutes	2 minutes
Beef tops (4 oz.) 1 serving	Wash and trim. Put in 1-quart glass casserole; add 2 tablespoons water. Cover with vented plastic wrap.	4 minutes	2 minutes

<b>ITEM</b>	<b>PREPARATION</b>	<b>BY TIME</b>	<b>STAND</b>
Beet stems (4 oz.) 1 serving	Wash and trim. Put in a glass pie plate; add 2 tablespoons water. Cover with vented plastic wrap.	3 minutes	2 minutes
Broccoli (4 oz.) 1 serving	Wash; cut into even pieces. Arrange in a glass pie plate; add 1/4 cup water. Cover with vented plastic wrap.	2 minutes	2 minutes
Brussels sprouts (4 oz.) 1 serving	Wash and trim. Cut an X in the bottom of each piece. Arrange in a glass pie plate; add 1/4 cup water. Cover with vented plastic wrap.	4 minutes	2 minutes
Cabbage (4 oz.) 1 serving	Wash; cut into wedges. Arrange in a glass pie plate; add 1/4 cup water. Cover with vented plastic wrap.	4 minutes	5 minutes
Cauliflower (4 oz.) 1 serving	Wash; cut into bite size pieces. Arrange in a glass pie plate; add 2 tablespoons water. Cover with vented plastic wrap.	2 minutes	2 minutes
Carrots, baby (4 oz.) 1 serving	Wash. Arrange in a 1-quart glass casserole; add 2 tablespoons water. Cover with lid or vented plastic wrap.	3 minutes	2 minutes
Celery (4 oz.) 1 serving	Wash; cut into bite size pieces. Arrange in a glass pie plate; add 2 tablespoons water. Cover with vented plastic wrap.	2 minutes	2 minutes
Eggplant (4 oz.) 1 serving	Wash; cut into 1 inch cubes. Arrange in a glass pie plate; add 2 tablespoons water. Cover with vented plastic wrap.	4 minutes	2 minutes
Green beans (4 oz.) 1 serving	Wash; place in a glass pie plate; add 2 tablespoons water. Cover with vented plastic wrap.	4 minutes	2 minutes

ITEM	PREPARATION	BY TIME	STAND
Green bell pepper strips (4 oz.) 1 serving	Wash; cut into strips. Arrange in a glass pie plate; add 2 tablespoons water. Cover with vented plastic wrap.	4 minutes	2 minutes
Mushrooms (4 oz.) 1 serving	Wash; cut into a bite of pieces. Arrange in a glass pie plate; add 2 tablespoons water. Cover with vented plastic wrap.	4 minutes	2 minutes
Okra (4 oz.) 1 serving	Wash; cut into a bite of pieces. Arrange in a glass pie plate; add 1/4 cup water. Cover with vented plastic wrap.	4 minutes	2 minutes
Onion, chopped (4 oz.) 1 serving	Peel skin and chop onion. Place in a glass pie plate; add 1/4 cup water. Cover with vented plastic wrap.	4 minutes	2 minutes
Parsnips (4 oz.) 1 serving	Wash; cut into a bite of pieces. Arrange in a glass pie plate; add 2 tablespoons water. Cover with vented plastic wrap.	4 minutes	5 minutes
Rutabagas	See chart on page 35		
Spinach leaves (4 oz.) 1 serving	Wash. Place in a 1 1/2-quart casserole; add 2 tablespoons water. Cover with lid or vented plastic wrap.	4 minutes	2 minutes
Squash, butternut (4 oz.) 1 serving	Peel and cut into cubes. Place in a glass casserole; add 1/4 cup water. Cover with lid or vented plastic wrap.	4 minutes	5 minutes
Zucchini, sliced (4 oz.) 1 serving	Wash. Place in a 1 1/2-quart glass casserole; add 2 tablespoons water. Cover with lid or vented plastic wrap.	4 minutes	2 minutes

The vegetables cook differently than those in the previous chart. Follow the methods below for these particular foods.

ITEM	PREPARATION	BY TIME	STAND
<p>Acorn Squash</p> <p>1 (about 1 lb.)</p> <p>2 (about 2 lbs.)</p>	<p>Wash; pierce with a fork. Place it on a glass cooking tray.</p> <p>Turn over halfway through cooking. Cut in half and remove seeds.</p> <p>Turn over halfway through cooking. Cut in half and remove seeds.</p>	<p>7 minutes</p> <p>12 minutes</p>	<p>2 minutes</p> <p>4 minutes</p>
<p>Artichokes</p> <p>1 (8 oz.)</p> <p>2 (about 1 lb.)</p>	<p>Wash and trim edges. Arrange in a circle in a glass pie plate. Add 1 inch of water to dish. Cover with vented plastic wrap.</p> <p>Rotate halfway through cooking.</p> <p>Rotate halfway through cooking.</p>	<p>9 minutes</p> <p>15 minutes</p>	<p>2 minutes</p> <p>3 minutes</p>
<p>Rutabagas</p> <p>1 (12 oz.)</p> <p>2 (1 1/4 lbs.)</p>	<p>Wash; pierce with a fork. Place it on a glass cooking tray.</p> <p>Turn over halfway through cooking. Cut in half and remove seeds.</p> <p>Turn over and press pad twice more. Cut in half and remove seeds.</p>	<p>7 minutes</p> <p>9 minutes</p>	<p>2 minutes</p> <p>4 minutes</p>

# FISH AND SEAFOOD

Delicate, tender fish is the result when cooked in the microwave. Because it is moist cooking, the finished fish and seafood, if cooked for the appropriate time, will be opaque and flake with a fork with no signs of dryness.

Because fish is unevenly shaped, the arrangement is critical to success. To arrange several fillets in a deep glass pie plate, put thicker edges to the outside and thinner edges to the inside. Try to create a circle for best results, even overlap thin ends where necessary to achieve overall even thickness.

Single items may do better if the thin ends are shielded with a foil. Some rules apply to the use of foil never cover

more than one-third of any item; do not let the foil pieces touch each other or the sides of the microwave oven, and be sure that all ends are tucked under and lie flat to the food. Cover with wax paper to prevent spattering.

Seafood cooks very quickly in the microwave-about 3 to 4 minutes per pound. Wait for stand time, then proceed carefully with extra time, to finish cooking without overcooking. Cooked seafood will be opaque and firm, but not tough.

Frozen fish and seafood are convenient to keep on hand. See the "FISH-AUTO DEFROSTING" chart on page 23 of this cookbook for defrosting details.

## CRUMB-COATED BAKED FISH

- 1 cup seasoned bread crumbs
- 1 teaspoon dried parsley
- 1 teaspoon lemon pepper
- 1/2 cup plain yogurt
- 1 pound fresh or thawed frozen fish fillets

1. In a deep glass pie plate, combine bread crumbs, parsley and lemon pepper. Coat fish with yogurt; then coat with crumb mixture.
2. Arrange fish in an 8-inch square glass baking dish with thick edges to the outside. Cover with a wax paper with the vented corner. Cook on P-HI for 8-10 minutes or until fish flakes easily when tested with a fork.

**4 servings**

## FISH ROLL-UPS

- 1 package (10 oz.) frozen chopped spinach
- 1 teaspoon instant minced onion
- 2 teaspoons lemon juice
- 1/4 cup soft cream cheese
- 4 fresh fish fillets, 1/2-inch thick (about 3/4 lb.)
- 1/2 teaspoon paprika

1. Open spinach package. Place package on a paper towel. Cook on P-HI for 8 minutes. Drain spinach and place in a mixing bowl. Stir in onion and lemon juice.
2. Spread cream cheese evenly on fish fillets. Divide spinach evenly; spread over cream cheese. Roll up fish; secure with wooden picks. Place fish in a deep glass pie plate; sprinkle with paprika.
3. Cover with vented plastic wrap. Cook on P-HI for 6 to 8 minutes or until fish flakes easily when tested with a fork. Remove wooden picks.

**4 servings**

## FISH FILLET AMANDINE

- 1/4 cup margarine or butter, divided
- 1/2 cup slivered almonds
- 1 teaspoon almond liqueur, optional
- 1 lbs. fresh or thawed frozen fish fillets
- 1 tablespoon lemon juice

1. In a 2-cup glass measure, heat 2 tablespoons margarine on P-HI for 1 minute or until melted. Add almonds. Cook, uncovered, on P-HI for 2 minutes or until almonds are lightly toasted; stir twice during cooking. Stir in liqueur if desired.
2. In an 8-inch square glass baking dish, heat 2 tablespoons margarine on P-HI for 1 minute. Place fish in baking dish, turning to coat both sides in margarine. Sprinkle with lemon juice. Cover with vented plastic wrap. Cook on P-HI for 7-8 minutes or until fish flakes easily when tested with a fork.
3. Top with toasted almonds.

4 servings

## WINE-POACHED FISH

- 1 cup dry white wine
- 1/4 teaspoon rosemary leaves, crushed
- 1/4 teaspoon salt
- 1/8 teaspoon white pepper
- 1 pound fresh or defrosted fish fillets
- 1/2 lemon, thinly sliced

1. In an 8-inch square glass baking dish, combine wine, rosemary, salt and pepper. Add fish, thick edges to the outside. Top with lemon slices.
2. Cover with vented plastic wrap. Cook on P-HI for 5 to 7 minutes or until fish flakes easily when tested with a fork.

4 servings

## COOKING FISH AND SEAFOOD

1. Arrange fish and seafood on a microwave rack (fillets, steaks, lobster) or in an appropriate glass casserole (scallops).
2. Cover with wax paper and set on glass turntable in a microwave.
3. Calculate cooking time by multiplying weight of the fish or seafood by the time recommended per pound.
4. The microwave will cook on P-HI unless another power level is entered at the time of cooking. To choose another power level, and begin cooking, press Power continuously to program the recommended power level. Press the number pad to program the calculated time. Press START.
5. Check progress about halfway through the cooking time; turn over, rearrange or shield, as needed.
6. Within several minutes before the end of cooking check fish or seafood to determine if time needs adjusting. Wait until the stand time before making the final decision.

ITEM	POWER	COOK	STAND
Fish Fillets--or-- Fish Steaks	P-HI	5-7 minutes per pound	2 minutes
Shrimp--or-- Scallops	P-HI	3-4 minutes per pound	2 minutes
Lobster Tail	P-HI	6-8 minutes per pound	2 minutes

# POULTRY

Juicy and moist describes poultry cooked by microwave energy. It is a superior method for cooking chicken to be used in casseroles, salads, or to have for sandwiches. See Poached Chicken recipe.

Arrangement is very important with poultry and its uneven shapes. Try to arrange pieces in a circular pattern wherever possible for the most even defrosting or cooking. The rounded part of the drumstick should go at the outer edge, for example, while the thinner end goes to the middle of the dish. Continue with other pieces until the overall layer is fairly even. Cover with wax paper to prevent spattering.

Poultry defrosts well with our AUTO DEFROST feature

(see page 12). Be sure that all poultry is completely defrosted before cooking. Check for doneness after stand time is over.

Remember that more cooking will take place during standing time. Poultry must be cooked to an internal temperature of 160°F for boneless pieces, to 170°F for bone-in pieces and to 185°F for whole birds.

Poultry is done when the meat is no longer pink and the juices are the color of chicken broth with no traces of pink. Be sure to check for these signs by cutting into the inner thigh. You may also check for the internal temperature with an instant-read thermometer. Occasionally the bones will show red spots, but this does not affect the doneness.

## POACHED CHICKEN

- 2 bone-in chicken breast halves (about 1 lb.)
- 1 celery stalk, cut up
- 1 medium carrot, cut up
- 1 small onion, chopped (about 1/2 cup)
- 1 cup chicken broth

1. In a 2-quart casserole, place chicken breast halves. Add celery, carrot, onion and chicken broth.
2. Cover with lid or vented plastic wrap. Cook on P-HI for 12 to 15 minutes or until chicken is no longer pink and juices run clear; turn chicken over halfway through cooking. Let stand 5 minutes.

*4 servings*

## BBQ CHICKEN

- 1 broiler-fryer chicken, cut in serving pieces (2 lbs to 3 lbs.)
- 1/2 cup catsup
- 2 tablespoons brown sugar
- 2 tablespoons vinegar
- 1 teaspoon Worcestershire sauce
- 1 teaspoon prepared mustard
- 1/2 teaspoon salt
- 1/4 teaspoon pepper

1. Rinse chicken and pat dry with paper towels. On a microwave plate, arrange chicken pieces skin side down in a single layer with thickest parts to outside.
2. In a 2-cup glass measure, combine catsup, brown sugar, vinegar, Worcestershire, mustard, salt and pepper. Reserve 1/2 cup of sauce.
3. Brush half of remaining barbecue sauce over chicken. Cover with wax paper. Cook on P-HI for 10 minutes. Rearrange and turn over chicken; brush with remaining sauce. Continue cooking on P-HI for 8 to 10 minutes or until chicken is no longer pink and juices run clear. Let stand 3 minutes. Serve with reserved sauce.

*4 servings*

## MEXICAN CHICKEN RICE CASSEROLE

- 2 pounds boneless, skinless chicken breasts, cut into strips
- 1/2 teaspoon cumin
- 1/4 teaspoon salt
- 1 tablespoon margarine or butter
- 1 clove garlic, minced
- 1 cup mild or medium salsa
- 1 cup chicken broth
- 3/4 cup quick cooking rice
- 1 cup corn chips, crushed to 1/2 cup
- 1/2 cup (2 oz.) shredded Monterey Jack or cheddar cheese

1. Season chicken with cumin and salt. In a 1 1/2-quart casserole, heat margarine on P-HI for 50 to 60 seconds or until melted; stir in chicken and garlic.
2. Cook, uncovered, on P-HI for 7-9 minutes or until chicken is no longer pink; stir three times during cooking. Stir in salsa, chicken broth and rice.
3. Cover with lid or vented plastic wrap. Cook on P-HI for 5-6 minutes or until boiling. Let stand, covered, until liquid is absorbed, about 4 minutes. Stir; sprinkle with crushed corn chips and cheese.
4. Cook, uncovered, on P-HI for 2-3 minutes or until cheese is melted.

*4 servings*

# COOKING POULTRY

1. Arrange poultry on a microwave rack (boneless breasts and thighs, whole broilerfryers, cornish hens, wings with crumb coating) or in as appropriate glass casserole baking dish or deep glass pie plate (wings, cut up or bone-in chicken)
2. Cover with wax paper and set on glass turntable in the microwave.
3. Calculate cooking time by multiplying weight of the poultry by the time recommended per pound
4. The microwave will cook on P-HI unless another power level is entered at the time of cooking. To choose another power level, and begin cooking, press Power continuously to program the recommended power level. Press the number pad to program the calculated time. Press START.
5. Check progress about halfway through the cooking time; turn over, rearrange or shield as needed.
6. Within several minutes before the end of cooking check poultry to determine if time needs adjusting. Wait until after the stand time before making the final decision. 4 servings

ITEM	POWER	COOK	STAND
Chicken Breast, boneless --or-- Chicken Thighs, boneless	P-HI	8-10 minutes per pound	3 minutes
Chicken Wings --or-- Chicken Wings, pieces	P-HI	8-9 minutes per pound	2 minutes
Whole Fryer --or-- Bone-in Chicken	P-HI	12-15 minutes per pound	5 minutes
Cornish Hen	P-HI	7-9 minutes per pound	5 minutes



# MEATS

Tender cuts of meat do well in the microwave, especially when cooked at lower power levels. Be sure meat is fully defrosted before cooking. Consult the meat cooking charts (pages 39, 42-44) for details.

The exact time to cook each piece of meat will depend on the shape of the meat, the weight, the starting temperature of the meat and the desired doneness. Our timings assume the meat is taken from the proper storage (refrigerated). The lower number in the time range reflects time suggested for

medium meat; the higher number for well done. It is always possible to add time if needed, so it is best to start with the lower number for calculating the time.

Stand time after cooking is an important aspect of microwave cooking since more cooking will take place then. The residual heat in the food will equalize and finish the cooking process. Always check for doneness after the stand time.

## MEATBALLS

- 1 egg, beaten
- 1/3 cup milk
- 1/4 cup quick cooking oats, uncooked
- 1/4 cup dry bread crumbs
- 1 pound lean ground meat (combination of beef and pork or turkey)
- 1 medium onion, chopped
- 1 tablespoon dried parsley flakes
- 1 teaspoon salt
- 1/4 teaspoon freshly ground black pepper

1. In a small bowl, combine egg, milk, oats and bread crumbs; let stand 2 minutes. In mixing bowl, combine ground meat, onion, parsley, salt and pepper. Add egg mixture; mix well. Form meat mixture into 24 meatballs.
2. In a 2-quart casserole, place meatballs in a single layer. Cover with wax paper. Cook on P-HI for 12 to 14 minutes or until meat is no longer pink; turn meatballs twice during cooking. Drain meatballs; let stand for 3 minutes before serving.

*4 servings*

## PEPPER STEAK

- 1 pound beef steak (flank, round or sirloin)
- 2 tablespoons white wine vinegar
- 1 tablespoon water
- 1/4 cup soy sauce
- 1 teaspoon garlic/salt
- 1/2 teaspoon sugar
- 1/4 teaspoon ground ginger
- 1 large green bell pepper, cut into strips
- 1 medium onion, sliced
- 2 medium tomatoes, peeled and quartered
- 1 cup fresh mushrooms, sliced
- 1 cup brown gravy
- Hot cooked rice

1. Slice beef across the grain into strips. In a 2-quart glass casserole, combine vinegar, water, soy sauce, garlic, salt, sugar and ground ginger. Add meat to mixture; coat each piece. Cover with lid or plastic wrap and marinate in refrigerator for 30 minutes.
2. Remove bowl from refrigerator. Stir in green bell pepper and onion; cover. Press Power pad continuously by P-80. Cook, uncovered, for 5 minutes. Stir in tomatoes and mushrooms.
3. Cover with lid or vented plastic wrap. Press Power pad by P-90. Continue cooking for 10 minutes or until meat is tender; stir once during cooking. Add brown gravy to meat mixture; stir.
4. Continue cooking on P-HI for 4 to 5 minutes or until meat mixture is thoroughly heated. Let stand for 3 minutes.

*4 servings*

### TIP

Thin pieces of meat are no longer pink when fully cooked. Take meat from the microwave while slightly pink to prevent overcooking during standing time.

## PORK SAUSAGE CASSEROLE

- 1 medium red onion
- 3 green apples, seeded and cubed
- 2 tablespoons margarine or butter
- 1 package (12 oz.) bulk pork sausage, cooked, drained and crumbled
- 1 sweet potato (about 8 oz.) cooked, peeled and cubed
- 1 jar (12 oz.) pork gravy

1. Peel onion and cut in half. Slice it thinly. In a 2-quart glass casserole, combine onion, apples and margarine.
2. Cover with lid or vented plastic wrap. Cook on P-HI for 5 minutes, or until onions and apples are tender. Stir in sausage, sweet potato and gravy.
3. Continue cooking on P-HI for 8-10 minutes or until heated thoroughly.

*4 servings*

## SWEET 'N' SOUR PORK

- 1 pound boneless pork cubes
- 3/4 cup apricot preserves
- 2 tablespoons mustard
- 2 tablespoons apple cider vinegar
- 2 tablespoons light soy sauce
- 1 can (8 oz.) sliced water chestnuts, drained
- 1 can (8 oz.) pineapple chunks, drained
- 1 can (11 oz.) mandarin orange segments, drained
- 2 pounds frozen pea pods, cooked and drained
- 2 cups cooked rice
- 1/4 cup sliced almonds

1. In a 2-quart glass casserole, place pork cubes. Cover with wax paper. Cook on P-HI for 8 minutes; stir once during cooking to rearrange cooked cubes. Drain pork.
2. Stir in apricot preserves, mustard, vinegar, soy sauce, water chestnuts, pineapple, oranges and pea pods. Cook, uncovered, on P-HI for 4 minutes or until heated thoroughly. Serve over cooked rice and top with sliced almonds.

*4 servings*

## BEEF, PEPPERS AND PASTA

- 3 cups bell pepper chunks (red, yellow and green)
- 1 cup onion, sliced
- 2 tablespoons margarine or butter
- 1 1/2 cups chopped cooked beef
- 2 cups cooked elbow macaroni, drained
- 1 can (14.5 oz.) seasoned diced tomatoes, undrained
- 1 jar (14 oz.) traditional-style pasta sauce

1. In a 2-quart glass casserole, combine bell peppers, onions and margarine. Cover with lid or vented plastic wrap. Cook on P-HI for 6 to 7 minutes or until vegetables are tender.
2. Stir in beef, macaroni, tomatoes and pasta sauce. Continue cooking on P-HI for 6 to 7 minutes or until heated thoroughly.

*4 servings*

## LAMB SHEPHERD CASSEROLE

- 2 cups sliced celery
- 1 cup sliced carrots
- 2 tablespoons margarine or butter
- 2 cups cubed cooked potatoes
- 2 cups cubed cooked lamb
- 1 can (15 1/4 oz.) whole kernel corn, drained
- 1 can (10 3/4 oz.) cream of celery soup, undiluted
- 1 jar (12 oz.) onion gravy

1. In a 2-quart glass casserole, combine celery, carrots and margarine. Cover with lid or vented plastic wrap. Cook on P-HI for 6 minutes or until vegetables are tender.
2. Stir in potatoes, lamb, corn, soup and gravy. Continue cooking on P-HI for 8 to 10 minutes or until heated thoroughly.

*4 servings*

# COOKING PORK

1. Arrange meat on a microwave rack (roast, chops, bacon) in an appropriate glass casserole (cubes, strips, sausage).
2. Cover with wax paper and set on glass turntable in the microwave.
3. Calculate cooking time by multiplying weight of the meat by the time recommended per pound.
4. The microwave will cook on P-HI unless another power level is entered at the time of cooking. To choose another power level and begin cooking, press Power continuously to program the recommended power level shown below. Press the number pad to program the calculated time. Press START.
5. Check progress about halfway through the cooking time; turn over, rearrange or shield, as needed.
6. Within several minutes before the end of cooking check meat to determine if time needs adjusting. Wait after the stand time before making the final decision.

ITEM	POWER	COOK	STAND
Pork Cubes	P-HI	7-8 minutes per pound	2 minutes
Pork Loin Roast	P-70	15-17 minutes per pound	10 minutes
Bulk Pork Sausage	P-HI	5-6 minutes for 12 oz.; cover with paper towels	2 minutes
Pork Chops, boneless Pork Chops, bone-in	P-70	8-10 minutes per pound	2 minutes
Pork Strips	P-HI	5-6 minutes per pound	2 minutes
Bacon	P-HI	1 minute per slice; cover with paper towel	30 seconds

# COOKING BEEF

1. Arrange meat on a microwave rack (roast, hamburger patties) or in an appropriate glass casserole (cubes, strips, ground beef, meatballs).
2. Cover with wax paper and set on glass turntable in the microwave.
3. Calculate cooking time by multiplying weight of the meat by the time recommended per pound.
4. The microwave will cook on P-HI unless another power level is entered at the time of cooking. To choose another power level and begin cooking, press Power continuously to program the recommended power level shown below. Press the number pad to program the calculated time. Press START.
5. Check progress about halfway through the cooking time; turn over, rearrange or shield, as needed.
6. Within several minutes before the end of cooking check meat to determine if time needs adjusting. Wait until after the standing time before making the final decision.

ITEM	POWER	COOK	STAND
Beef Rolled Rump Roast --or-- Beef Round Sirloin Tip Roast, Boneless --or-- Beef Eye of Round --or-- Beef Flank Steak	P-50	17-20 minutes per pound (recommended for meats up to 3 pounds)	10 minutes
Beef Strips, boneless --or-- Beef Cubes	P-70	8-10 minutes per pound	2 minutes
Ground Beef	P-HI	7 minutes per pound	5 minutes
Beef Hamburger Patties	P-HI	7 minutes per pound	2 minutes
Meatballs	P-HI	8-10 minutes per pound	2 minutes

# COOKING LAMB

1. Arrange meat on a microwave rack (leg, roast, chops) or in an appropriate glass casserole (cubes).
2. Cover with wax paper and set on glass turntable in the microwave.
3. Calculate cooking time by multiplying weight of the meat by the time recommended per pound.
4. The microwave will cook on P-HI unless another power level is entered at the time of cooking. To choose another power level and begin cooking, press Power continuously to program the recommended power level shown below. Press the number pad to program the calculated time. Press START.
5. Check progress about halfway through the cooking time; turn over, rearrange or shield, as needed.
6. Within several minutes before the end of cooking check meat to determine if time needs adjusting. Wait until after the stand time before making the final decision.

ITEM	POWER	COOK	STAND
Lamb Chops, boneless	P-70	8-10 minutes per pound	2 minutes
Lamb Chops, bone-in			
Lamb Cubes	P-HI	7 minutes per pound	2 minutes
Boneless Leg, rolled	P-70	12 minutes per pound	10 minutes, covered

# SOUPS

Making homemade soups is easier than ever in the microwave oven. Use leftover vegetables, chicken and meats to create your own specialty. Freeze small amounts of leftovers until you have enough to try a new soup.

An efficient microwave method of soup making is to cook the vegetables first with just a little oil or butter, then add the stock or broth and heat as desired. If you have no stock or broth, heat 1 cup of water and 1 bouillon cube (or 1 teaspoon bouillon granules) in a 2-cup glass measure on P-HI for 3 minutes. Season as desired.

Canned condensed soups are convenient to add to homemade vegetables for a quick but tasty soup. Our recipes for mushroom and onion sauces can be used as soup bases with additional milk. Watch for package directions to heat purchased soups in the microwave.

Once you have made some soup of your choice, freeze leftovers in 12-ounce portions. Then defrost on Def. and reheat on P-HI for 3 minutes. Always stir several times during the heating cycle and before serving.

## CHICKEN RICE SOUP

- Poached Chicken  
(see recipe on Page 26)
- 3 cups chicken broth
  - 1 cup instant rice, uncooked
  - 2 tablespoons chopped parsley

1. Prepare Poached Chicken according to recipe. Remove chicken, cool about 10 to 15 minutes. Remove bones and cut chicken into bite-size pieces.
2. Meanwhile, add 2 cups chicken broth to poaching liquid in the medium glass casserole.
3. Cover with lid or vented plastic wrap. Cook on P-HI for 8 minutes. Stir in chicken, rice and parsley. Continue cooking, on P-HI for 5 to 6 minutes or until heated thoroughly. Let stand for 5 minutes or until rice has softened. Stir before serving.

*4 servings*

## POTATO SOUP

- 3 cups peeled, diced potatoes
- 1/2 cup chopped onion
- 1/2 cup chopped celery
- 1 can (13 3/4 oz.) chicken broth
- 1 can (5 oz.) evaporated skim milk
- 2 teaspoons dried parsley
- 1/2 teaspoon salt
- 1/2 teaspoon dried thyme
- 1/4 teaspoon pepper

1. In a 2-quart glass casserole, combine potatoes, onion, celery and broth.
2. Cover with lid or vented plastic wrap. Cook on P-HI for 13 to 15 minutes or until potatoes are tender.
3. Stir in evaporated milk, parsley, salt, thyme and pepper. Continue cooking on P-HI for 5 minutes or until heated thoroughly.

*4 servings*

## SAUCES AND GRAVIES

Sauces and gravies are foolproof when made in the microwave oven. Scorching, sticking, overcooking are no longer problems when the sauces are cooked in a glass measure with a handle. The sauce cooks more evenly, but it is pourable. Select a sizable utensil that is double the size of the recipe to allow for bubbling up and prevent spilling over.

It is important to stir frequently to prevent lumps, especially after mixture has boiled. A whisk is helpful to stir cooked areas into those that are not yet thickened. Stir before

serving as well.

Sauces add a nice touch of variety to menus. They can be made ahead and stored covered in the refrigerator until ready to reheat and serve. If you wish to add a sauce or gravy to cooked meats, it is best to heat the sauce fully first, then add the meat and cook for 1 to 2 minutes to heat thoroughly. This method prevents overcooking the meat.

Our versatile collection of sauces will enhance your main dishes and even desserts for creative menu planning.

## BELL PEPPER SAUCE

- 1 1/2 cups chopped green bell pepper
- 1 1/2 cups chopped red bell pepper
- 1/2 cup chopped onion
- 1 teaspoon parsley flakes
- 1/2 teaspoon salt
- 1/2 teaspoon dried basil leaves
- 1/4 teaspoon pepper

1. In a 2-quart glass measure, combine chopped bell peppers, onion, parsley, salt, basil and pepper.
2. Cook, uncovered, on P-HI for 8 to 10 minutes or until vegetables are tender; stir three times during cooking.
3. Puree vegetable mixture in blender.

*1 1/2 cups*

## TOMATO SAUCE

- 1 can (29 oz.) tomato sauce
- 1 teaspoon Italian seasoning
- 1 teaspoon sugar
- 1/4 teaspoon garlic powder
- 1/4 teaspoon black pepper

1. In a 2-quart glass measure, combine tomato sauce, seasoning, sugar, garlic powder and pepper.
  2. Cook, uncovered, on P-HI for 8 to 10 minutes or until mixture just begins to boil; stir frequently during cooking.
  3. Let stand for 2 minutes. Stir before serving.
- 4 cups*

### TIP

Combine sauces with cooked meat or sausage for creative pasta toppings.

## SWEET 'N' SOUR SAUCE

- 3/4 cup apricot preserves
- 1 can (6 oz.) pineapple juice
- 2 tablespoons apple cider vinegar
- 1 tablespoon Dijon mustard
- 1 tablespoon soy sauce
- 2 tablespoons cornstarch

1. In a 4-cup glass measure, combine preserves, pineapple juice, vinegar, mustard, soy sauce and cornstarch; mix well.
  2. Cook, uncovered, on P-HI for 8 to 10 minutes or until thickened; stir twice during cooking.
- 1 1/2 cups*

## WHITE SAUCE

- 2 tablespoons margarine or butter
- 2 tablespoons flour
- 1/2 teaspoon salt
- 1 1/4 cups milk

1. In a 2-cup glass measure, heat margarine on P-HI for 50 to 60 seconds or until melted. Add flour and salt; stir to blend well.
  2. Add milk gradually, stirring constantly. Cook, uncovered, on P-HI for 4 to 4 1/2 minutes or until mixture boils; stir every minute during cooking. Stir before serving.
- 1 1/4 cups*

## HERB WHITE SAUCE

- 2 tablespoons margarine or butter
- 2 tablespoons flour
- 1/2 teaspoon salt
- 1 1/4 cups milk
- 2 teaspoons each chopped fresh basil, oregano and parsley

1. In a 2-cup glass measure, heat margarine on P-HI for 50 to 60 seconds or until melted. Add flour and salt; stir to blend well.
  2. Add milk gradually, stirring constantly. Cook, uncovered on P-HI for 4 to 4 1/2 minutes or until mixture boils; stir every minute during cooking.
  3. Stir in herbs before serving.
- 1 1/2 cups*

## CHEESE SAUCE

- 2 tablespoons margarine or butter
- 2 tablespoons flour
- 1/2 teaspoon salt
- 1/2 teaspoon dry mustard
- 1/8 teaspoon white pepper
- 1 1/4 cups milk
- 1 1/2 cups (6 oz.) shredded cheddar cheese

1. In a 2-cup glass measure, heat margarine on P-HI for 50 to 60 seconds or until melted. Add flour and salt; stir to blend well.
  2. Add milk gradually, stirring constantly. Cook, uncovered, on P-HI for 4 to 4 1/2 minutes or until mixture boils; stir every minute during cooking.
  3. Add cheese; stir well. Cook on P-HI for 30 seconds or until cheese is melted. Stir before serving.
- 2 3/4 cups*

# DESSERTS

A sweet ending to a meal is a lot easier in the microwave oven. Quick to make, delicious to eat, these desserts offer something for everyone. We have selected those that do well in the microwave oven. Candies, for example, are excellent when prepared the microwave way.

To get the most even cooking, plan to make desserts in a deep glass pie plate where possible. Use a paper towel as a cover for bar cookies to equalize the cooking process. It peels off easily when done. Appearances are not what we are accustomed to seeing, but frosting or a dusting of confectioner's sugar helps create eye appeal.

Crumb pie shells do quite well in the microwave, as do most fruit desserts. To get a head start on pie fillings, simply heat in a large glass measure; stir well to distribute the heat, then pour into the prepared pie shell.

High sugar mixtures get very hot in the microwave so use great care (and hot pads) when handling.

## BROWNIES

- 2 squares unsweetened chocolate, 1oz. each
- 6 tablespoons margarine or butter
- 1 cup sugar
- 2 eggs
- 1 teaspoon vanilla
- 1 cup flour
- 1/4 teaspoon salt
- 2 tablespoons confectioner's sugar

1. In a 1 1/2-quart glass measure, put chocolate squares and margarine.
2. Cook, uncovered, on P-HI for 2 minutes; stir to finish melting chocolate.
3. Pour in sugar, eggs and vanilla; mix well. Stir in flour and salt; mix well. Spread evenly into a deep glass pie plate. Cook, uncovered, on P-HI for 5 minutes or until no longer doughy on the bottom.
4. Let brownies stand for 15 minutes. Sift confectioner's sugar over brownies and cut into serving pieces.

*18 pieces*

## CHEESECAKE

- 1/4 cup margarine or butter
- 1 cup gingersnap crumbs
- 2 package (8 oz. each) cream cheese, softened
- 1/2 cup sugar
- 1 tablespoon fresh lemon juice
- 1/2 teaspoon vanilla extract
- 2 eggs, beaten
- Fresh fruit or canned fruit pie filling

1. In a deep glass pie plate, heat margarine on P-HI for 1 minute or until melted. Add crumbs and stir into margarine with a fork to combine. Press evenly into bottom and sides of pie plate. Cook, uncovered, on P-HI for 2 minutes. Let stand.
2. In a 2-quart glass measure, place cream cheese, sugar, lemon juice and vanilla. Add eggs; mix until well blended. Pour mixture into crust. Cook, uncovered, on P-HI for 5 minutes.
3. Shield edges with strips of foil, be certain to tuck all foil edges under. Continue cooking, uncovered, on P-HI for 2 to 3 minutes or until center is almost set. Remove foil; cool and chill thoroughly before serving.
4. Top cheesecake with fruit.

*6 servings*



## RICE PUDDING

- 1 package (3 oz.) regular vanilla pudding and pie filling (not instant)
- 2 cups milk
- 1/2 cup instant rice, uncooked
- 1/3 cup raisins
- 1/2 teaspoon cinnamon Dash of nutmeg

1. In a 2-quart glass casserole, combine all ingredients. Cook, uncovered, on P-HI for 6 minutes or until thickened; stir three times during cooking.
2. Cover and let stand 5 minutes. Serve warm or chilled.

**4 servings**

For a variation, substitute regular banana or coconut cream pudding and pie filling for vanilla.

## TOFFEE FUDGE

- 4 cups confectioner's sugar, sifted
- 2/3 cup unsweetened cocoa powder
- 1/4 cup milk
- 1/2 cup margarine or butter
- 1 teaspoon vanilla
- 1 cup English toffee bits or broken toffee candy

1. In a 1 1/2-quart glass casserole, blend confectioner's sugar and cocoa. Pour in milk and place margarine on top. Cook, uncovered, on P-HI for 3 minutes or until butter is melted.
2. Stir in vanilla; beat with a wooden spoon until smooth. Stir in toffee bits.
3. Pour mixture into buttered 8-inch square pan. Refrigerate at least 1 hour. Cut into squares.

**16 squares**

## CHOCOLATE CLUSTERS

- 2 cups broken pretzels
- 1 cup miniature marshmallows
- 1 cup salted peanuts
- 1/2 cup raisins
- 3/4 cup sugar
- 1/3 cup milk
- 2 tablespoons margarine or butter
- 1 package (12 oz.) milk chocolate chips (about 2 cups)
- 1/2 teaspoon vanilla extract

1. In a large bowl, combine pretzels, marshmallows; peanuts and raisins.
2. In a 4-cup glass measure, combine sugar, milk, and margarine. Cook, uncovered, on P-HI for 3 to 4 minutes or until mixture boils; stir once during heating. Stir in chocolate chips and vanilla until chips are melted and mixture is smooth, about 2 minutes.
3. Pour chocolate mixture over pretzel mixture. Stir until well coated. Drop by tablespoonful onto wax paper-lined cookie sheet. Chill until firm.

**3 dozen clusters**

For a variation, add other types of fruits, nuts or chocolate chips.

# WEIGHT & MEASURE CONVERSION CHART

## ■ POUNDS & OUNCES TO GRAMS

POUNDS(lb.)	GRAMS(g)	OUNCES(oz.)	GRAMS(g)	OUNCES(oz.)	GRAMS(g)
1/4	114	1	28	9	255
1/2	227	2	57	10	284
3/4	341	3	85	11	312
1	454	4	113	12	340
2	907	5	142	13	369
3	1361	6	170	14	397
4	1814	7	198	15	425
5	2268	8	227	16	454
6	2722				
7	3175				
8	3629				
9	4082				
10	4526				
11	4990				

## ■ FLUID MEASUREMENTS

1 Cup	= 8 fluid ounces	= 240 ml.
1 Pint	= 16 fluid ounces	= 480 ml.
1 Quart	= 32 fluid ounces	= 960 ml.
1 Gallon	= 128 fluid ounces	= 3840 ml.

## ■ WEIGHT DEFROST AND COOK CONVERSION CHART

Ounces	Hundredths of a Pound	Tenths of a Pound	Grams
1-2	.06-.15	0.1	50
3-4	.16-.25	0.2	100
5-6	.26-.35	0.3	150
7	.36-.45	0.4	200
8-9	.46-.55	0.5	250
10-11	.56-.65	0.6	300
12-13	.66-.75	0.7	350
14	.76-.85	0.8	400
15-16	.86-.95	0.9	450

# SPECIFICATIONS

Item	Rating Specification
Power Supply	120V, 15A Single phase with grounding 60Hz, AC.
Power Consumption	1350 W
Microwave Output Power	900 W, Full Microwave power
Microwave Frequency	2,450 MHz
Outside Dimensions	W 495 (19.5) X D 390 (15.4) X H 294 (11.6) mm (inch)
Cavity Dimensions	W 320 (12.6) X D 338 (13.3) X H 238 (9.4) mm (inch)
Cavity Volume	0.9 Cu. Ft.
Net Weight	Approx. 33.0 lbs (15 kg)
Timer	Digital, 59 minutes 99 seconds

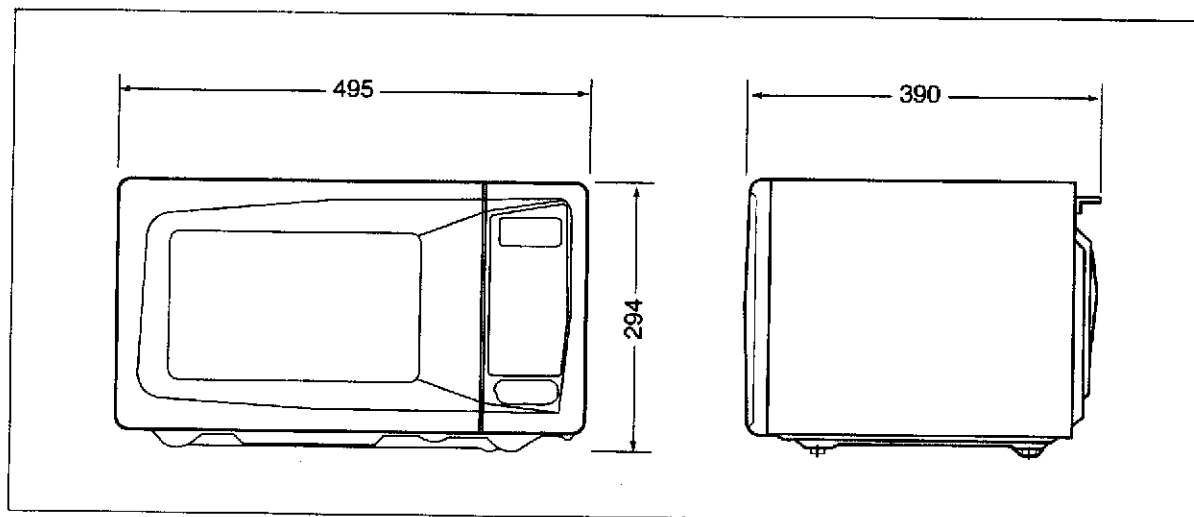

## BEFORE YOU CALL FOR SERVICE

Refer to the following checklist, you may prevent an unnecessary service call.

- The oven doesn't work :
  1. Check that the power cord is securely plugged in.
  2. Check that the door is firmly closed.
  3. Check that the cooking time is set.
  4. Check for a blown circuit fuse or tripped main circuit breaker in your house.
- Sparking in the cavity;
  1. Check utensils. Metal containers or dishes with metal trim should not be used.
  2. Check that metal skewers or foil does not touch the interior walls.

If there is still a problem, contact the service station.

**DO NOT ATTEMPT TO SERVICE THE OVEN YOURSELF !**



**SERVICE**

**TO FIND THE LOCATION AND PHONE  
NUMBER OF YOUR NEAREST  
SERVICE CENTER PERMITTED TO  
PERFORM WARRANTY SERVICE...**

**CALL TOLL FREE: 1-800-695-0098**

**FOR ADDITIONAL SET-UP OR  
OPERATING ASSISTANCE  
PLEASE CALL:  
1-800-898-9020**

**FOR CUSTOMER SERVICE, PLEASE WRITE TO:  
Emerson Radio Corp.  
Consumer Affaires Dept.  
1901 DIPLOMAT DRIVE  
FARMERS BRANCH, TX 75234**

## LIMITED WARRANTY MICROWAVE OVENS

Emerson Radio Corp. warrants this product to be free from manufacturing defects in original material, including original parts, and workmanship under normal use and conditions ("manufacturing defect") for a period of one (1) year from date of original purchase in, and if used in, the United States ("warranty").

Should service be necessary under this warranty, Emerson will provide the following at an Independent Service Center or Regional Repair Facility permitted by Emerson to perform repairs, provided the manufacturing defect is verified along with the date of purchase:

- \* Repair service for one (1) year from date of original purchase at no charge for labor and parts.
- \* Replacement of a defective magnetron for seven (7) years from date of original purchase (labor not included after initial twelve (12) months)

There are Independent Service Centers and Regional Repair Facilities located throughout the country. For one nearest you, DIAL TOLL FREE:

1-800-695-0098. In the event the product must be mailed to a Regional Repair Facility which is permitted by Emerson to perform repairs:

- \* Pack the unit in a well-padded heavy corrugated box.
- \* Enclose your check or money order payable to the REGIONAL REPAIR FACILITY in the amount of \$15.00 to cover return shipping and handling costs.
- \* Enclose a copy of your proof of purchase (warranty service will not be provided without dated proof of purchase)
- \* Ship the unit prepaid via UPS or parcel post (insured).

NOTE: This warranty does not cover.

- (a) Damage to equipment not properly connected to the product.
- (b) Cost incurred in the shipping of the product to and from a Regional Repair Facility permitted by Emerson to perform warranty repairs.
- (c) Damage or improper operation of unit caused by customer abuse, misuse, negligence, or failure to follow operating instructions provided with the product.
- (d) Ordinary adjustments to the product which can be performed by customer as outlined in the owner's manual.
- (e) Signal reception problems caused by external antenna or cable systems.
- (f) Products not purchased in the United States.
- (g) Damage to product if used outside the United States.

THIS WARRANTY IS NON-TRANSFERABLE AND APPLIES ONLY TO THE ORIGINAL PURCHASER AND DOES NOT EXTEND TO SUBSEQUENT OWNERS OF THE PRODUCT. ANY APPLICABLE IMPLIED WARRANTIES, INCLUDING THE WARRANTY OF MERCHANTABILITY, ARE LIMITED IN DURATION TO A PERIOD OF THE EXPRESSED WARRANTY AS PROVIDED HEREIN BEGINNING WITH THE DATE OF ORIGINAL PURCHASE AT RETAIL AND NO WARRANTIES, WHETHER EXPRESSED OR IMPLIED, SHALL APPLY TO THE PRODUCT THEREAFTER. EMERSON MAKES NO WARRANTY AS TO THE FITNESS OF THE PRODUCT FOR ANY PARTICULAR PURPOSE OR USE.

THE EXTENT OF EMERSON RADIO CORP'S LIABILITY UNDER THIS LIMITED WARRANTY IS THE REPAIR OR REPLACEMENT PROVIDED ABOVE AND, IN NO EVENT, SHALL EMERSON RADIO CORP'S LIABILITY EXCEED THE PURCHASE PRICE PAID BY THE PURCHASER OF THE THE PRODUCT. UNDER NO CIRCUMSTANCES SHALL EMERSON RADIO CORP. BE LIABLE FOR ANY LOSS, DIRECT, INDIRECT, INCIDENTAL, SPECIAL, OR CONSEQUENTIAL DAMAGE ARISING OUT OF OR IN CONNECTION WITH THE USE OF THIS PRODUCT.

THIS WARRANTY IS VALID ONLY IN THE UNITED STATES OF AMERICA. THIS WARRANTY GIVES YOU SPECIFIC LEGAL RIGHTS. HOWEVER, YOU MAY HAVE OTHER RIGHTS WHICH MAY VARY FROM STATE TO STATE. SOME STATES DO NOT ALLOW LIMITATION ON IMPLIED WARRANTIES OR EXCLUSION OF CONSEQUENTIAL DAMAGE. THEREFORE THESE RESTRICTIONS MAY NOT APPLY TO YOU.

**FILE COPY**



**EMERSON RADIO CORP.**

EMERSON  
PART NO.: 80-5094  
902-01

**FILE COPY**

PRINTED IN KOREA