



***KARAOKE SYSTEM WITH AM/FM
RADIO AND DUAL CASSETTE
DECK***

***OWNER'S MANUAL
EK215***

Visit our web site at www.emersonradio.com

WARNING

TO PREVENT FIRE OR SHOCK HAZARD, DO NOT USE THIS PLUG WITH AN EXTENSION CORD, RECEPTACLE OR OTHER OUTLET UNLESS THE BLADES CAN BE FULLY INSERTED TO PREVENT BLADE EXPOSURE. TO PREVENT FIRE OR SHOCK HAZARD, DO NOT EXPOSE THIS APPLIANCE TO RAIN OR MOISTURE.



The lightning flash with arrowhead symbol, within an equilateral triangle is intended to alert the user to the presence of uninsulated 'dangerous voltage' within the product's enclosure that may be of sufficient magnitude to constitute a risk of electric shock to persons.

CAUTION

**RISK OF ELECTRIC SHOCK
DO NOT OPEN**

CAUTION: TO REDUCE THE RISK OF ELECTRIC SHOCK DO NOT REMOVE COVER (OR BACK), NO USER SERVICEABLE PARTS INSIDE. REFER SERVICING TO QUALIFIED SERVICE PERSONNEL.



The exclamation point within an equilateral triangle is intended to alert the user to the presence of important operating and maintenance (servicing) instructions in the literature accompanying the appliance.

IMPORTANT SAFETY INSTRUCTIONS

1. Read these instructions.
2. Keep these instructions.
3. Heed all warnings.
4. Follow all instructions.
5. Do not use this apparatus near water.
6. Clean only with dry cloth.
7. Do not block any ventilation openings. Install in accordance with the manufacturer's instructions.
8. Do not install near any heat sources such as radiators, heat registers, stoves, or other apparatus (including amplifiers) that produce heat.
9. Do not defeat the safety purpose of the polarized or grounding-type plug. A polarized plug has two blades with one wider than the other. A grounding type plug has two blades and a third grounding prong. The wide blade or the third prong are provided for your safety. If the provided plug does not fit into your outlet, consult an electrician for replacement of the obsolete outlet.
10. Protect the power cord from being walked on or pinched particularly at plugs, convenience receptacles, and the point where they exit from the apparatus.
11. Only use attachments / accessories specified by the manufacturer.
12. Unplug this apparatus during lightning storms or when unused for long periods of time.
13. Refer all servicing to qualified service personnel. Servicing is required when the apparatus has been damaged in any way, such as power-supply cord or plug is damaged, liquid has been spilled or objects have fallen into the apparatus, the apparatus has been exposed to rain or moisture, does not operate normally, has changed its performance, or has been dropped.
14. This appliance shall not be exposed to dripping or splashing water and no object filled with liquids such as vases shall be placed on the apparatus.
15. Do not overload wall outlet. Use only power source as indicated.
16. Use replacement parts as specified by the manufacturer.
17. The product may be mounted to a wall only if recommended by the manufacturer.
18. Upon completion of any service or repairs to this product, ask the service technician to perform safety checks.

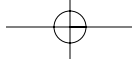

Thank you for purchasing this Emerson Karaoke audio system. This uniquely designed product has an AM/FM radio and a dual cassette player/recorder that will allow you to make direct recordings from radio to cassette, cassette to cassette or live through the dual Karaoke microphones.

We are sure that this unit will provide you with many years of exceptional performance with a minimum of care and maintenance. Please review the contents of this instruction manual completely and carefully before operating your unit, to make sure that you understand all functions and operations and get the maximum benefit out of all the great features included in this product. If you should encounter any problems with the set-up or operation of this product, please contact the Emerson Radio Corporation Customer Service hotline, toll free, at 1-800-898-9020.

The serial number of your unit can be found on a label on the bottom of the cabinet. We suggest that you record the serial number in the space provided below in case this information is ever needed at a future date.

Model Number: EK215

Serial Number: _____

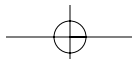
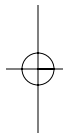
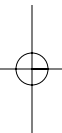

LOCATION OF CONTROLS

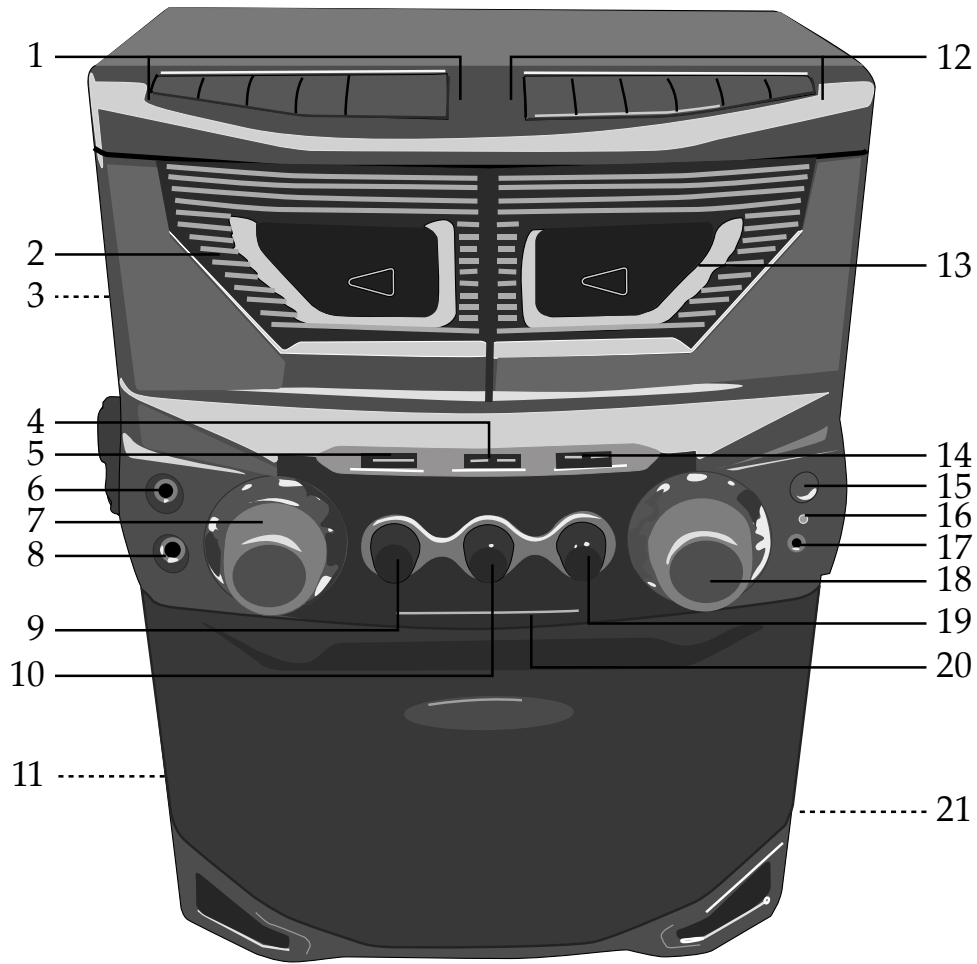

- | | |
|--|---|
| <ol style="list-style-type: none"> 1. Cassette Deck 1 Buttons (left to right):
 PAUSE ()
 STOP/EJECT (■▲)
 F.FWD (◀◀)
 REWIND (▶▶)
 PLAY (◀) 2. Cassette Deck 1 3. AUX OUT Jacks (Rear of Unit) 4. HIGH SPEED DUBBING Switch 5. VOCAL (AUTO/NORMAL/MUSIC) Switch 6. MIC A Jack 7. MASTER VOLUME Control 8. MIC B Jack 9. MIC VOLUME Control 10. ECHO Control 11. Battery Compartment (Rear of Unit) | <ol style="list-style-type: none"> 12. Cassette Deck 2 Buttons (left to right):
 PAUSE ()
 STOP/EJECT (■▲)
 F.FWD (◀◀)
 REWIND (▶▶)
 PLAY (◀)
 RECORD (●) 13. Cassette Deck 2 14. FUNCTION (TAPE/FM/AM) Switch 15. POWER Button 16. POWER ON Indicator 17. PHONES (Headphones) Jack 18. TUNING Control 19. TONE Control 20. AM/FM Dial Scale and Pointer 21. AC Socket (Rear of Unit) |
|--|---|

POWER SOURCES

AC:

Use the AC polarized line cord included with the unit for operation on AC power. Insert the small end of the AC cord into the AC socket on the back cabinet of the unit. Insert the other end of the AC cord into any convenient 120V 60Hz household outlet.

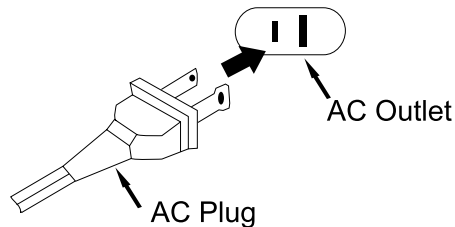

NOTE: The AC plug supplied with the unit is polarized to help minimize the possibility of electric shock. If the AC plug does not fit into a nonpolarized AC outlet, do not file or cut the wide blade. It is the user's responsibility to have an electrician replace the obsolete outlet.

DC:

Remove the battery cover on the rear of the unit and insert eight "D" cell batteries (not included), observing the battery polarity indicated inside the compartment. Replace the Battery Compartment cover.

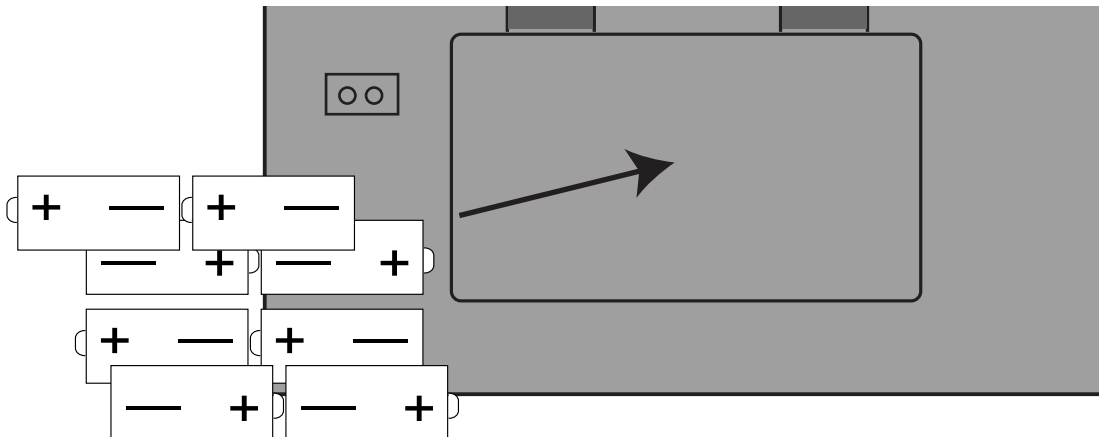

BATTERY PRECAUTIONS

Follow these precautions when using batteries in this device:

1. Use only the size and type of batteries specified.
2. Be sure to follow the correct polarity when installing the batteries as indicated in the battery compartment. Reversed batteries may cause damage to the device.
3. Do not mix different types of batteries together (e.g. Alkaline and Carbon-zinc) or old batteries with fresh ones.
4. If the device is not to be used for a long period of time, remove the batteries to prevent damage or injury from possible battery leakage.
5. Do not try to recharge batteries not intended to be recharged; they can overheat and rupture. (Follow battery manufacturer's directions.)



CONNECTIONS

CONNECTING THE UNIT TO A HOME STEREO

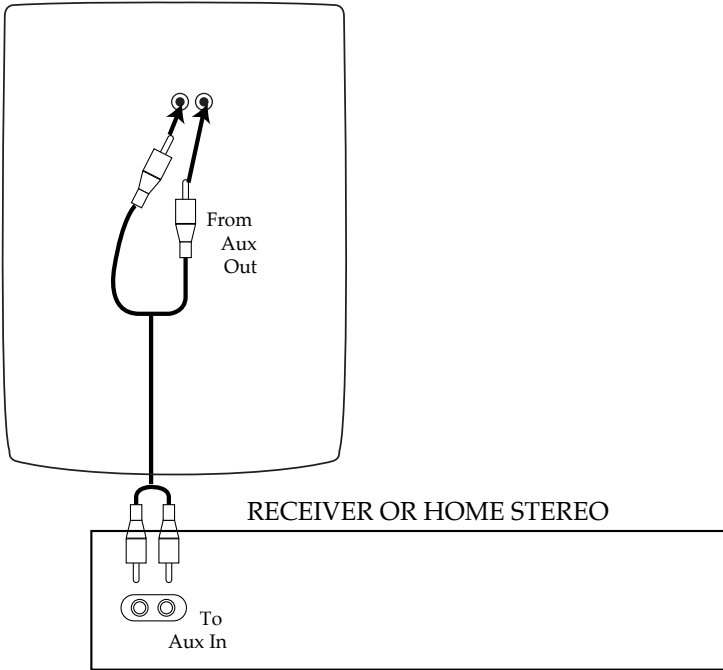

NOTES FOR CONNECTING TO A RECEIVER/HOME STEREO:

- Connecting the unit to a receiver/home stereo will allow you to broadcast the unit's sound through the receiver/home stereo's speakers.
- When connecting the unit, refer to the owner's manual of the receiver/home stereo, as well as this manual.
- When connecting the unit, make sure the power is off and both units are unplugged before making any connections.

CONNECTING THE MICROPHONE(S)

This unit has two microphone jacks, use with the supplied microphones which will allow you to sing along with your favorite songs. Before connecting, make sure the MIC VOLUME control is set to minimum. If only connecting one microphone, connect it to the MIC A jack.

HEADPHONE JACK

For private listening, connect low impedance 3.5mm (32 ohm) stereo headphones (not included) to this jack. The speakers are automatically disconnected when the headphone plug is inserted in the jack.

OPERATION

ECHO CONTROL

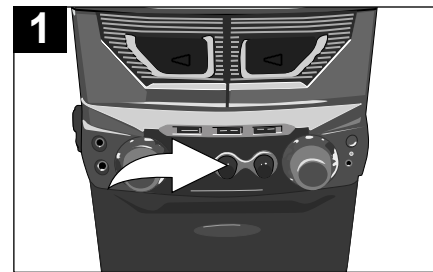

1 Rotate the ECHO control clockwise to increase the echo or counterclockwise to decrease the echo.

TONE CONTROL

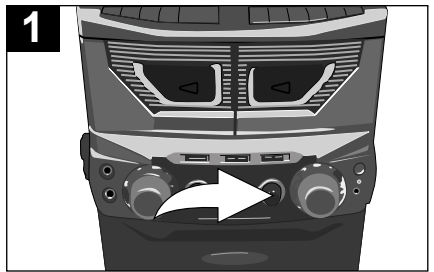

1 Rotate the TONE control clockwise to increase the higher tone response.

MIC ON/OFF SWITCH

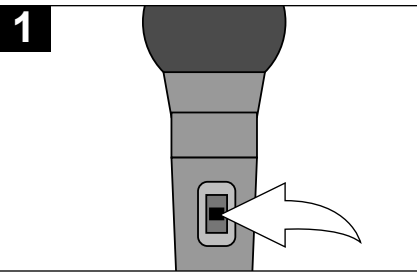

1 To turn the microphone on, slide the ON/OFF switch, located on the side of the microphone, to the ON position. To turn the microphone off, slide the ON/OFF switch to the OFF position.

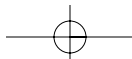

RADIO OPERATION

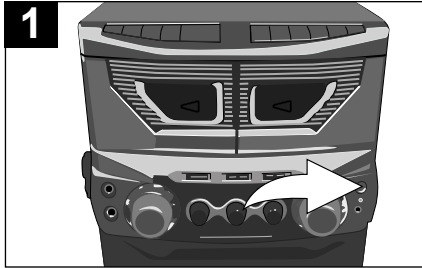

1 Press the POWER button to turn the unit on; the POWER indicator will light.

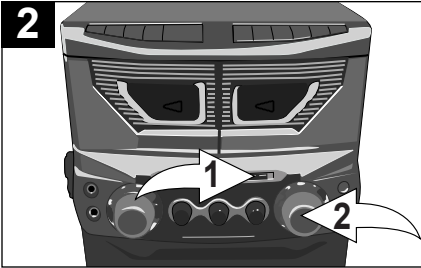

2 Slide the Function switch **1** to the AM or FM position. Rotate the TUNING control **2** to select a station.

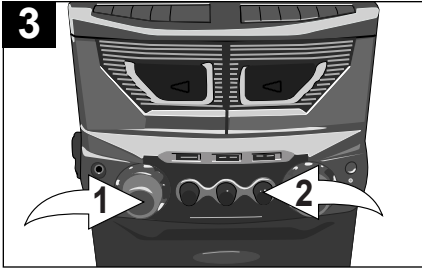

3 Adjust the MASTER VOLUME **1** and TONE **2** controls as desired.

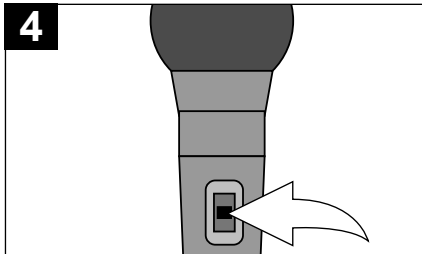

4 If desired, plug in one or two microphones and slide the ON/OFF switch, located on the side of the microphone, to the ON position. Adjust the MIC VOLUME control as desired. Sing or speak with the radio.

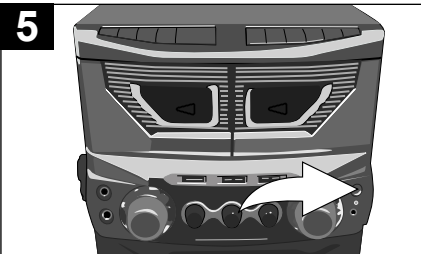

5 Press the POWER button to turn the unit off; the POWER indicator will turn off.

ANTENNAS
AM – This unit has a built-in ferrite rod antenna, which provides adequate reception in most areas. If reception is weak, turn the unit to improve reception.

FM – The FM antenna is built into the AC cord. If reception is weak, adjust the length and the angle of the cord.

CASSETTE TAPE OPERATION

PLAYING CASSETTE TAPES

On Karaoke Tapes, side A is stereo instrumental* (music only) and side B is instrumental on one channel and vocals on the other channel.

* Depending on the song, background vocals may be included on side A.

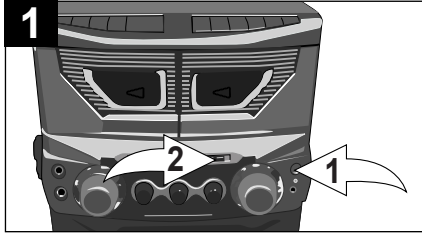

Press the POWER button ❶ to turn the unit on; the POWER indicator will light. Slide the Function switch ❷ to the TAPE position.

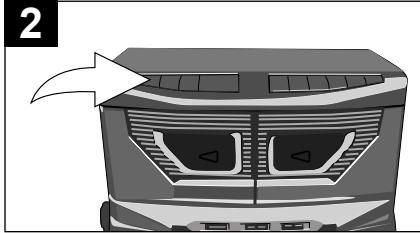

Press the STOP/EJECT (■▲) button on one of the decks to open the Cassette Door and insert a cassette with the open end facing up and full reel on the right.

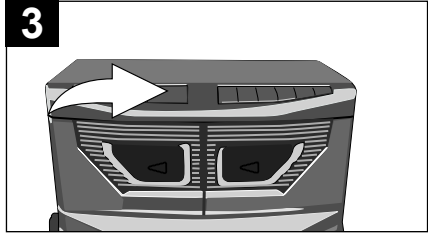

Press the PLAY (◀) button to begin playback.

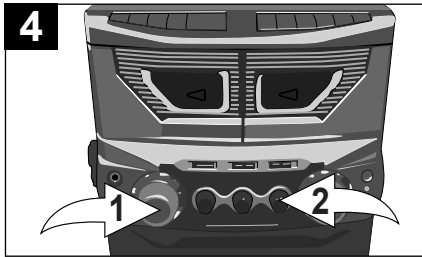

Adjust the MASTER VOLUME ❶ and TONE ❷ controls as desired.

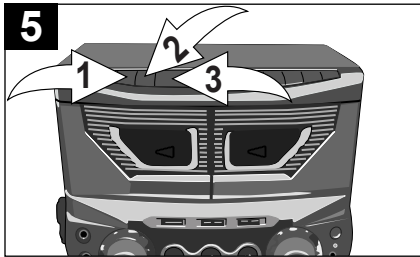

To advance or rewind the tape rapidly, press either the F.FWD (◀◀) ❶ or REWIND (▶▶) ❷ button. When you reach the desired point, press the PLAY (▶) button ❸ to resume normal playback.

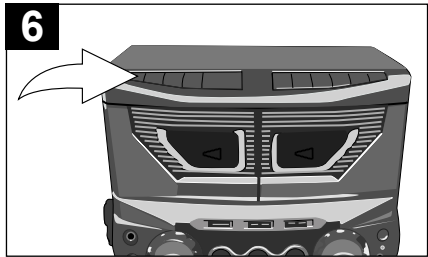

To pause playback momentarily, press the PAUSE (||) button. The tape movement stops but the tape motor is still running. Press the PAUSE (||) button again to release pause and resume normal playback.

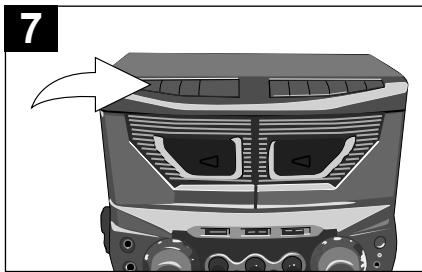

To stop playback before the tape ends, press the STOP/EJECT (■▲) button. The PLAY (▶) button is released and the tape motor shuts off.

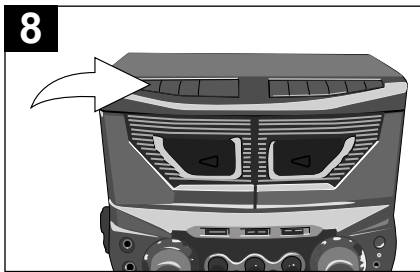

When the tape reaches the end, the auto-stop mechanism activates, the PLAY (▶) button is released and the tape motor shuts off. Press the STOP/EJECT (■▲) button to open the Cassette Door and remove the tape.

TO SING ALONG

If you would like to sing along with a tape, simply play the tape, connect one or two microphones and sing along! If you insert a Karaoke tape, you can set the VOCAL switch to one of the following positions:

MUSIC: Plays instruments, but not vocals.

NORMAL: Plays instruments and vocals.

AUTO: The Auto Vocal control is a special circuit that automatically suppresses the vocal tracks when you sing along through the microphone.

To hear vocals, tape side B must be played.

CASSETTE TAPE OPERATION (CONTINUED)

RECORDING FROM THE RADIO OR MICROPHONE (NON-KARAOKE)

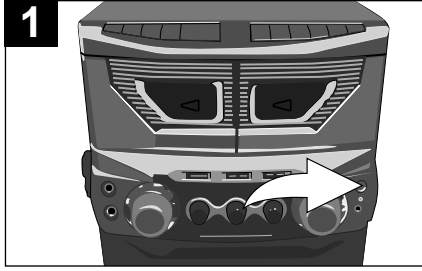

1 Press the POWER button to turn the unit on; the POWER indicator will light.

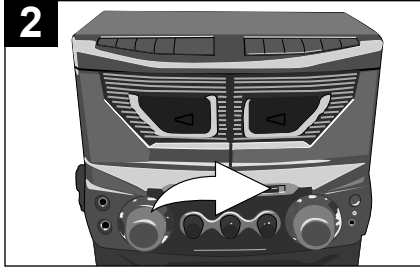

2 Slide the Function switch to the TAPE position if recording from a microphone or the FM/AM position if recording from the radio.

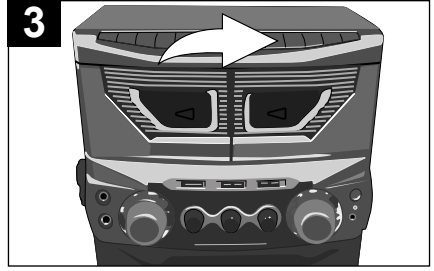

3 Press the STOP/EJECT (■▲) button on Deck 2 to open the Cassette Door and insert a blank cassette with the open end facing up and full reel on the right.

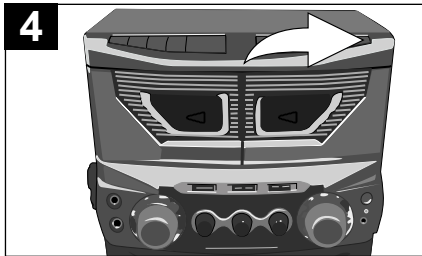

4 When ready to record, press the RECORD (●) button on Deck 2 (the PLAY (◀) button will automatically depress).

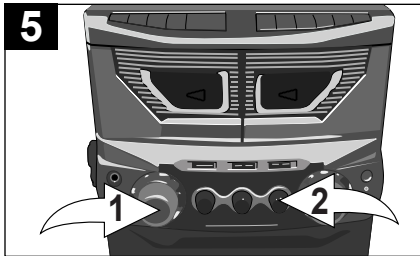

5 Adjust the MASTER VOLUME ① and TONE ② controls as desired. TONE control will not affect the recording.

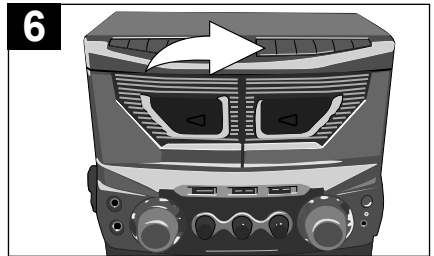

6 To pause recording momentarily, press the PAUSE (||) button. The tape movement stops but the tape motor is still running. Press the PAUSE (||) button again to release pause and resume recording.

KARAOKE RECORDING FROM THE RADIO OR MICROPHONE(S)

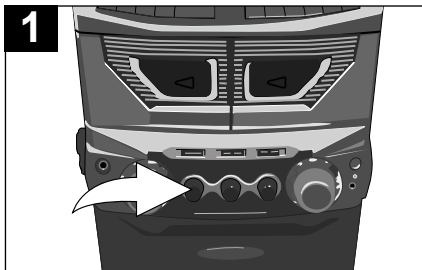

1 Follow steps 1 to 4 above. Insert one or two microphones into the appropriate jack(s). Adjust the MIC VOLUME control as desired. Increasing this control will increase the volume of the respective microphone.

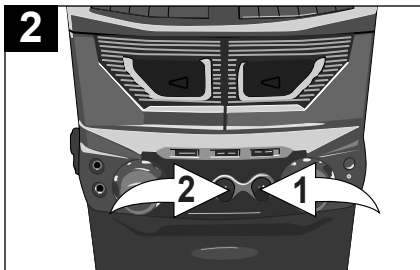

2 Adjust the TONE ① and ECHO ② controls to add an echo effect to your voice. The ECHO control ② is variable so add as much or as little reverb as desired.

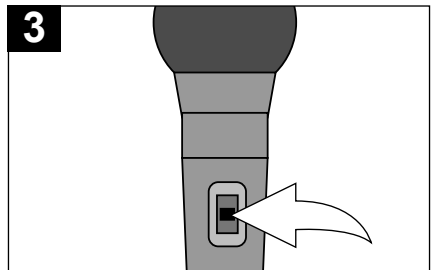

3 Slide the ON/OFF switch, located on the side of the microphone, to the ON position. Sing or talk into the microphone(s) and both the audio and the microphone(s) will be recorded onto the cassette tape in Deck 2.

CASSETTE TAPE OPERATION (CONTINUED)

DUBBING A CASSETTE TAPE AT NORMAL OR HIGH SPEED

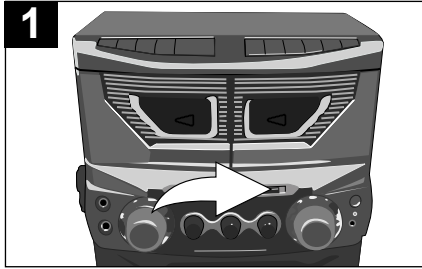

1 Insert a prerecorded tape into Deck 1 and a blank cassette tape into Deck 2. Slide the FUNCTION switch to the TAPE position.

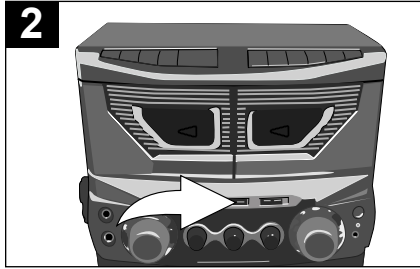

2 For high speed dubbing, slide the HIGH-SPEED DUBBING switch to the ON (High Speed Dubbing) position.

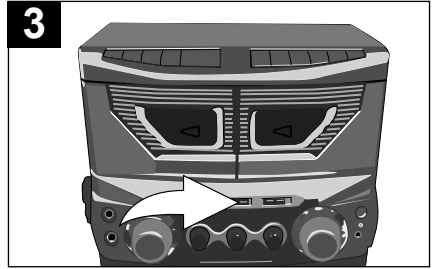

3 For higher quality dubbing, slide the HIGH-SPEED DUBBING switch to the OFF (Normal Speed Dubbing) position.

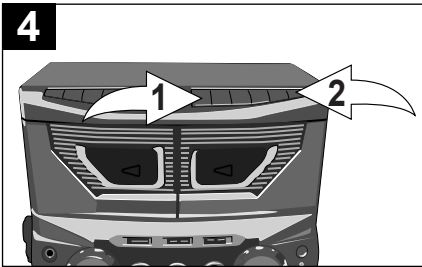

4 Press the PAUSE (||) button ❶ then the RECORD (●) button ❷ on Deck 2; the PLAY (◀) button will automatically depress.

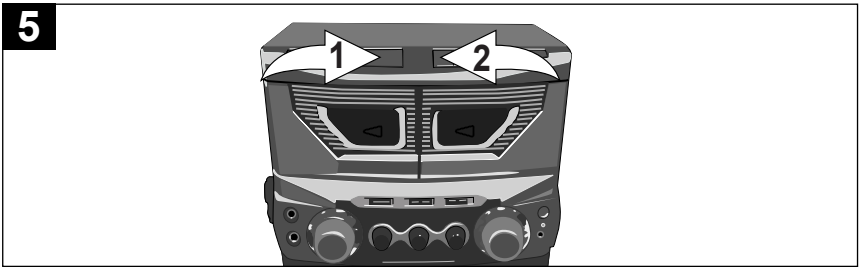

5 Press the PLAY (◀) button ❶ on Deck 1 and the PAUSE (||) button ❷ on Deck 2 will release automatically and the dubbing will begin. When dubbing, the shorter tape will stop first and the other will continue running until it reaches the end or is stopped manually.

NOTES:

- When dubbing at high speed, a chattering sound may be heard. To avoid this, set the MASTER VOLUME control to the minimum position while the tape is dubbing at high speed. DO NOT slide the HIGH SPEED DUBBING switch while dubbing is in progress.
- For best results, use normal bias cassette tapes when recording.

CASSETTE TAPE OPERATION (CONTINUED)

KARAOKE RECORDING FROM A KARAOKE CASSETTE TAPE

You can record onto a cassette tape from a special Karaoke cassette tape as follows:

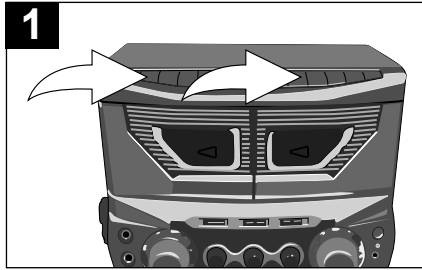

1 Press the STOP/EJECT buttons and insert a karaoke cassette tape into Deck 1 and a blank cassette tape into Deck 2.

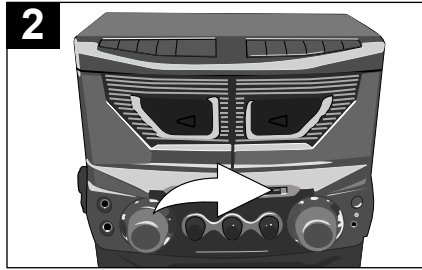

2 Connect one or two microphones to the appropriate jack(s). Slide the FUNCTION switch to the TAPE position.

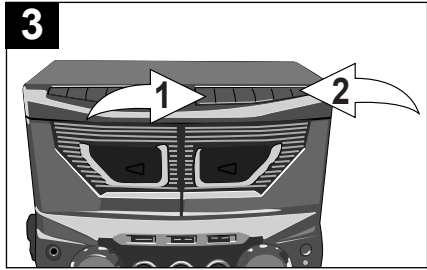

3 Press the PAUSE (||) button ❶, then press the RECORD (●) button ❷ on Deck 2 (the PLAY button will be automatically depressed).

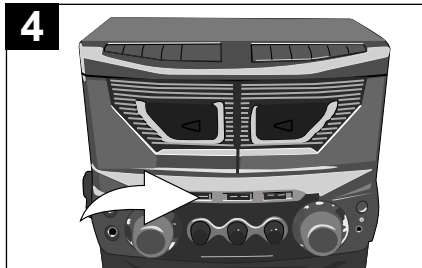

4 Slide the VOCAL switch to select one of the following positions:
MUSIC: Plays instruments, but not vocals.
NORMAL: Plays instruments and vocals.
AUTO: The Auto Vocal control is a special circuit that automatically suppresses the vocal tracks when you sing along through the microphone. To hear vocals, tape side B must be played.

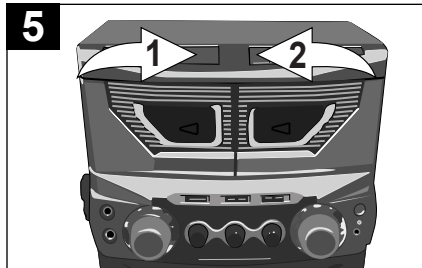

5 Press the PLAY (◀) button ❶ on Deck 1 to start playback and press the PAUSE button ❷ on Deck 2 to release pause.
 (Make sure the HIGH SPEED DUBBING switch is set to OFF.)

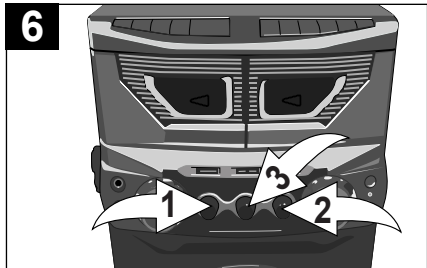

6 Adjust the MIC VOLUME control ❶ as desired. Increasing this control will increase the volume of the respective microphone. Adjust the TONE ❷ and ECHO controls ❸ to add an echo effect to your voice. The ECHO control ❸ is variable so add as much or as little reverb as desired.

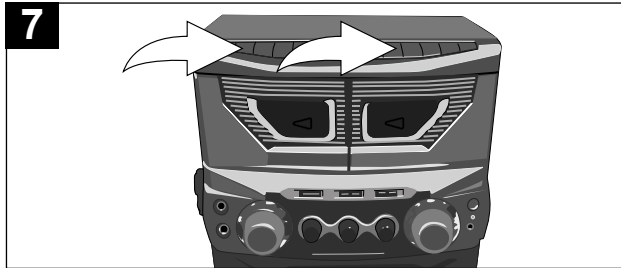

7 Sing or talk into the microphone(s) and both the Karaoke cassette tape and the microphone(s) will be recorded onto the cassette tape in Deck 2. When you are finished recording, press the STOP/EJECT (■▲) buttons to stop the tape.

NOTES:

- Refer to SAFEGUARD AGAINST ACCIDENTAL ERASURE section (page 11) if the RECORD button cannot be pressed.
- **MICROPHONE FEEDBACK:** "Feedback" is a howling or screeching sound that occurs when the microphone comes too close to the speaker(s). To avoid microphone feedback, keep the microphone as far away from the speakers as the microphone cable will allow. If you must bring the microphone close to the speakers, such as when you are changing a tape or adjusting one of the other controls on the front of the unit, set the microphone On/Off switch to the "Off" position.

CARE AND MAINTENANCE

SAFEGUARD AGAINST ACCIDENTAL ERASURE

When a new recording is made, any program material previously recorded is automatically erased and only the new recording remains. To safeguard valuable recordings from being erased accidentally, the cassette and the deck are equipped with a special device.

On the back of the cassette there is an erase prevention tab on each side. To prevent accidental erasing, break out these tabs with a screwdriver. If only one side of the tape is to be protected, break out the tab on the left side with the side desired facing you.

To record on a tape in which the tab has been broken, place a piece of adhesive tape over that area.

NOTE: When a tab is broken out, the record button cannot be depressed.

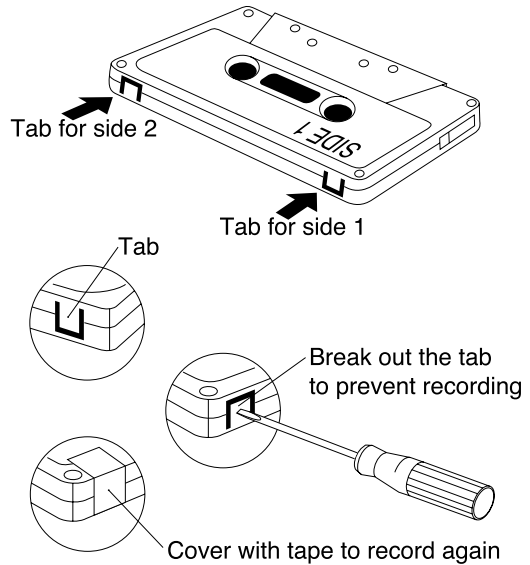

CASSETTE TAPE RECOMMENDATIONS

Standard tape lengths have 15 (C-30), 30 (C-60) and 45 (C-90) minutes of recording time on each side. Longer length tapes of 60 (C-120) minutes of recording time on each side are not recommended. Use only high quality tapes. If a problem develops, check the unit first with another cassette to determine if the problem is with the cassette, and not with the unit.

If there is any slack in the cassette, it should be removed before inserting the cassette. Place a pencil in one of the hubs and rotate it clockwise until all slack is taken up.

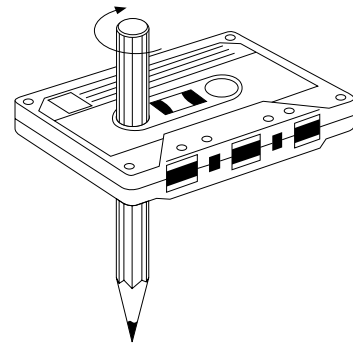

Cleaning the unit

- To prevent fire or shock hazard, disconnect your unit from the AC power source when cleaning.
- The finish on your unit may be cleaned with a dust cloth and cared for as other furniture. Use caution when cleaning and wiping the plastic parts.
- Mild soap and a damp cloth may be used on the front panel.
- Periodic cleaning of the tape heads, capstan and pinch roller is necessary to maintain good sound reproduction. Clean them after every 100 hours of use or less if playback has deteriorated. Use a cotton swab moistened with head cleaning solution or isopropyl alcohol, then wipe dry with another swab.

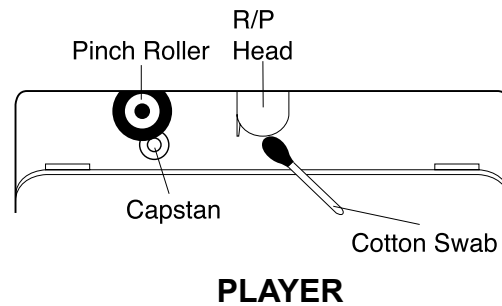
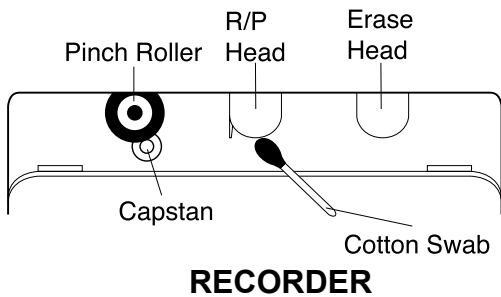

NOTE: Never use metal objects on or near the tape heads. Do not allow any cleaning material to fall into the tape assembly.

TROUBLESHOOTING GUIDE

Should this unit exhibit a problem, check the following before seeking service:

Symptom	Possible Cause	Solution
Radio		
Noise or sound distorted on radio broadcasts.	Station not tuned properly for AM or FM.	Retune the AM or FM broadcast station.
	FM: AC cord is not fully extended or uncoiled.	Extend AC cord.
	AM: Unit is not positioned correctly.	Rotate unit until best reception is obtained.
AM or FM, no sound.	FUNCTION switch not on AM or FM.	Slide to select AM or FM .
	Volume at minimum.	Increase volume.
Cassette Player		
No sound.	FUNCTION switch not set to TAPE.	Slide to the TAPE position.
	Volume at minimum.	Increase volume.
Sound distorted.	Dirty head.	Clean the head.
Speed varies.	Tape old.	Replace the tape.
	Cassette tape worn out.	Replace the tape.
Cassette Recorder		
Will not record.	Erase prevention tab removed.	Cover hole with adhesive tape.
Distorted sound on playback.	Defective tape or dirty tape head.	Replace tape or clean tape head.
Karaoke		
Some vocals are still present when VOCAL switch is set to MUSIC.	Using non-karaoke tape.	Use karaoke tape.
	Backup vocals are present.	This is normal, only the main vocal(s) are to be reduced.
Feedback is heard when singing.	Microphone is too close to unit or MIC VOLUME is too high.	Move microphone away from unit or decrease MIC VOLUME.
General		
No sound.	Power cord disconnected.	Connect power cord.



TO FIND THE LOCATION AND
PHONE NUMBER OF YOUR
NEAREST AUTHORIZED
SERVICE CENTER...

CALL TOLL FREE: 1-800-695-0098

FOR ADDITIONAL SET-UP OR OPERATING ASSISTANCE
PLEASE CALL:
1-800-898-9020

FOR CUSTOMER SERVICE, PLEASE WRITE TO:
Emerson Radio Corp.
Consumer Affairs Dept.
1901 Diplomat Drive
Farmers Branch, TX 75234

EMERSON RADIO CORP. LIMITED WARRANTY

What does this warranty cover?

Any manufacturing defects in original material, including original parts and workmanship, under normal use and conditions.

For how long?

For a period of ninety (90) days from the date of original purchase in the U.S.

What will we do?

If you need service under this Warranty, and you provide us with the dated proof of purchase, we will provide repair service at no charge for labor and parts at an authorized Depot Repair Facility, or replace the product in our discretion.

How do you make your warranty claim?

If it becomes necessary to repair your unit, you can obtain the name and mailing location of a Depot Repair Facility by dialing 1-800-695-0098. You should pack your unit in a well-padded heavy corrugated box, enclose your check or money order payable to the Depot Repair Facility in the amount of \$9.00 to cover the return shipping and handling costs, and enclose a copy of your proof of purchase (warranty service will not be provided without a dated proof of purchase). Finally, you should ship the unit prepaid via UPS or parcel post (insured).

What does your warranty not cover?

Your warranty does not cover the following :

- Damage from negligence, misuse, abuse, accident, or failure to follow operating instructions.
- Use of product in a commercial application or rentals.
- Changes or repairs by anyone other than an authorized Depot Repair Facility.
- Damage because your unit is improperly connected to the equipment of other manufacturers.
- Unit on which the serial number has been defaced, modified or removed.
- Damage to equipment not properly connected to the product.
- Cost incurred in shipping your unit to and from an authorized Depot Repair Facility.
- Ordinary adjustments which you can perform as outlined in the owner's manual.
- Signal reception problems caused by external antenna or cable systems.
- Products purchased, used, serviced, or damaged outside of the United States.
- Damage to compact discs or cassettes.

What other limitations apply to your warranty?

THIS WARRANTY IS NON-TRANSFERABLE AND APPLIES ONLY TO THE ORIGINAL PURCHASER AND DOES NOT EXTEND TO SUBSEQUENT OWNERS OF THE PRODUCT. THIS WARRANTY IS VALID ONLY IN THE UNITED STATES OF AMERICA. ANY APPLICABLE IMPLIED WARRANTIES, INCLUDING THE WARRANTY OF MERCHANTABILITY, ARE LIMITED IN DURATION TO A PERIOD OF THE EXPRESSED WARRANTY AS PROVIDED ABOVE BEGINNING WITH THE DATE OF ORIGINAL PURCHASE AT RETAIL AND NO WARRANTIES, WHETHER EXPRESSED OR IMPLIED, SHALL APPLY TO THE PRODUCT THEREAFTER. WE MAKE NO WARRANTY AS TO THE FITNESS OF THE PRODUCT FOR ANY PARTICULAR PURPOSE OR USE.

THE EXTENT OF OUR LIABILITY UNDER THIS LIMITED WARRANTY IS THE REPAIR OR REPLACEMENT PROVIDED ABOVE AND IN NO EVENT WILL OUR LIABILITY EXCEED THE PURCHASE PRICE PAID BY THE PURCHASER OF THE PRODUCT. UNDER NO CIRCUMSTANCES WILL WE BE LIABLE FOR ANY LOSS, DIRECT, INDIRECT, INCIDENTAL, SPECIAL, OR CONSEQUENTIAL DAMAGE ARISING OUT OF OR IN CONNECTION WITH THE USE OF THIS PRODUCT.

How does state law apply to your warranty?

THIS WARRANTY GIVES YOU SPECIFIC LEGAL RIGHTS, BUT YOU MAY ALSO HAVE OTHER RIGHTS WHICH VARY FROM STATE TO STATE. SOME STATES DO NOT ALLOW LIMITATIONS ON IMPLIED WARRANTIES OR EXCLUSION OR LIMITATION OF INCIDENTAL OR CONSEQUENTIAL DAMAGE, SO THESE RESTRICTIONS MAY NOT APPLY TO YOU.

AU898F



EMERSON
PART NO.:16-2873
208-02

Printed in China

