

Emerson[®]

***Home Audio System
with 3 CD Changer
and Digital AM/FM Receiver***

OWNER'S MANUAL



MS3108

Visit our web site at www.emersonradio.com



CAUTION

TO PREVENT FIRE OR SHOCK HAZARD, DO NOT USE THIS PLUG WITH AN EXTENSION CORD, RECEPTACLE OR OTHER OUTLET UNLESS THE BLADES CAN BE FULLY INSERTED TO PREVENT BLADE EXPOSURE. TO PREVENT FIRE OR SHOCK HAZARD, DO NOT EXPOSE THIS APPLIANCE TO RAIN OR MOISTURE.

 <p>The lightning flash with arrow-head symbol, within an equilateral triangle is intended to alert the user to the presence of uninsulated 'dangerous voltage' within the product's enclosure that may be of sufficient magnitude to constitute a risk of electric shock to persons.</p>	<p style="text-align: center;">CAUTION RISK OF ELECTRIC SHOCK DO NOT OPEN</p> <p>WARNING: TO REDUCE THE RISK OF ELECTRIC SHOCK DO NOT REMOVE COVER (OR BACK), NO USER SERVICEABLE PARTS INSIDE REFER SERVICING TO QUALIFIED SERVICE PERSONNEL.</p>	 <p>The exclamation point within an equilateral triangle is intended to alert the user to the presence of important operating and maintenance (servicing) instructions in the literature accompanying the appliance.</p>
--	--	---

The Caution Marking maybe located at the bottom enclosure of the apparatus.

IMPORTANT SAFETY INSTRUCTIONS

- 1.) Read these instructions. Keep these instructions. Follow all instructions. Heed all warnings.
- 2.) Do not use this apparatus near water.
- 3.) Clean only with dry cloth.
- 4.) Do not block any ventilation openings. Install in accordance with the manufacturer's instructions.
- 5.) Do not install near any heat sources such as radiators, heat registers, stoves, or other apparatus (including amplifiers) that produce heat.
- 6.) Do not defeat the safety purpose of the polarized or grounding-type plug. A polarized plug has two blades with one wider than the other. A grounding type plug has two blades and a third grounding prong. The wide blade or the third prong is provided for your safety. If the provided plug does not fit into your outlet, consult an electrician for replacement of the obsolete outlet.
- 7.) Protect the power cord from being walked on or pinched particularly at plugs, convenience receptacles, and the point where they exit from the apparatus.
- 8.) Only use attachments / accessories specified by the manufacturer.
- 9.) Unplug this apparatus during lightning storms or when unused for long periods of time.
- 10.) Refer all servicing to qualified service personnel. Servicing is required when the apparatus has been damaged in any way, such as power-supply cord or plug is damaged, liquid has been spilled or objects have fallen into the apparatus, the apparatus has been exposed to rain or moisture, does not operate normally, or has been dropped.
- 11.) This appliance shall not be exposed to dripping or splashing water and no object filled with liquids such as vases shall be placed on the apparatus.
- 12.) Use only with the cart, stand, tripod, bracket, or table specified by the manufacturer, or sold with the apparatus. When a cart is used, use caution when moving the cart/apparatus combination to avoid injury from tip-over.
- 13.) Do not overload wall outlet. Use only power source as indicated.
- 14.) Use replacement parts as specified by the manufacturer.
- 15.) The product may be mounted to a wall only if recommended by the manufacturer.
- 16.) Upon completion of any service or repairs to this product, ask the service technician to perform safety checks.



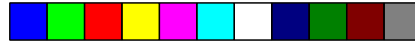

Thank you for purchasing this Home Audio System with 3-CD Changer and programmable CD-R/RW Player from Emerson. This system includes an AM/FM digital tuner with 20 preset station memories, a digital clock, a full-function remote control, and a pair of matching speakers.

Please review this manual completely and carefully to make sure that you are getting the maximum benefit from all features we have included in this system. If after reading this manual you experience any problems with the set-up or operation of this system, please do not return it to the retail store. Please call the Emerson Customer Service Hotline, toll free, at:
1-800-898-9020.

One of our customer service technicians will try to solve your problem for you. If that is not possible you will be advised of the proper procedure to obtain service for your system or to obtain a replacement system. The Customer Service Hotline hours are 9:00 AM to 5:00 PM, Central Time, Monday through Friday.

The serial number of your system can be found on a label on the back panel of the main unit. Please take a moment to locate the serial number and write the number in the space provided on the warranty page of this manual. You may be asked for the serial number when calling to request customer service



IMPORTANT NOTES

CLASS 1 LASER PRODUCT

CLASS 1 LASER PRODUCT
 APPAREIL À LASER DE CLASSE 1
 PRODUCTO LASER DE CLASE 1

CAUTION
 INVISIBLE LASER RADIATION
 WHEN OPEN AND INTERLOCKS
 DEFEATED.
 AVOID EXPOSURE TO BEAM



This product contains a low power Laser Device.

- Avoid installing this unit in places exposed to direct sunlight or close to heat radiating appliances such as electric heaters, on top of other stereo equipment that radiates too much heat, places lacking ventilation or dusty areas, places subject to constant vibration and/or humid or moist areas.
- Operate controls and switches as described in the manual.
- Before turning on the power, make certain that the power cord is properly installed.
- When moving the set, be sure to first disconnect the power cord and remove cords connected to other equipment.

FCC Information

This equipment has been tested and found to comply with the limits for a class B digital Device, pursuant to part 15 of the FCC Rules. These limits are designed to provide reasonable protection against harmful interference in a residential installation. This equipment generates, uses, and can radiate radio frequency energy and, if not installed and used in accordance with the instructions, may cause harmful interference to radio communications. However, there is no guarantee that interference will not occur in a particular installation. If this equipment does cause harmful interference to radio or television reception, which can be determined by turning the equipment off and on, the user is encouraged to try to correct the interference by one or more of the following measures:

- Reorient or relocate the receiving antenna.
- Increase the separation between the equipment and receiver.
- Connect the equipment into an outlet on a circuit different from that to which the receiver is connected.
- Consult the dealer or an experienced radio/TV technician for help.

This device complies with part 15 of the FCC Rules. Operation is subject to the following two conditions:

- (1) This device may not cause harmful interference, and
- (2) This device must accept any interference received, including interference that may cause undesired operation.

Changes or modifications not expressly approved by the party responsible for compliance could void the user's authority to operate the equipment.

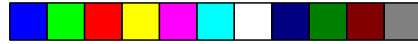

PREPARATION FOR USE

Unpacking and Set Up

- This carton contains the main unit, two speakers, the pedestal stand, and the remote control handset. Carefully remove all the components from the carton and remove all packing materials from the components. Make sure nothing is accidentally discarded with the packing materials.
- Save the carton and packing materials, if possible, in the unlikely event that this unit ever needs to be returned for service. Using the original carton and packing material is the only way to properly protect the unit from shipping damage.
- Remove any descriptive stickers or labels from the front panel of the main unit. Do not remove any labels or stickers that may be affixed to the back panel of the main unit or the speakers.
- Unwind the AC power cord on the back of the main unit and extend it to its full length.
- Unwind the FM lead wire antenna on the back of the main unit and extend it to its full length.
- Unwind the speaker cables on the backs of the speakers and extend them to their full length.



Attaching The Pedestal Stand

- 1.) Place the main unit face down on a flat surface as shown.

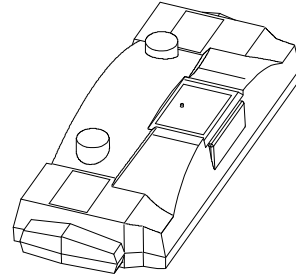

- 2.) Position the pedestal base so that the 4 guide hooks on the base slide into the 4 slots on the back of the main unit.

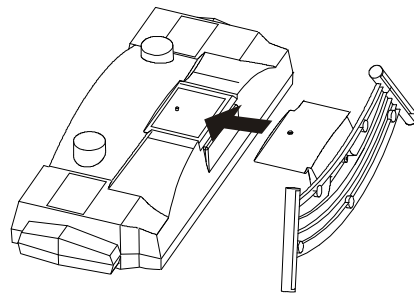

- 3.) Turn the pedestal base locking screw 'clockwise' to secure.

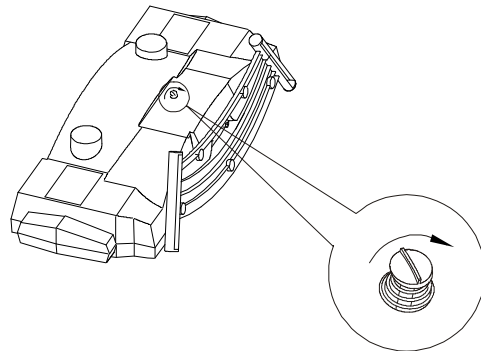

- 4.) Return the main unit and the pedestal base to the upright position.

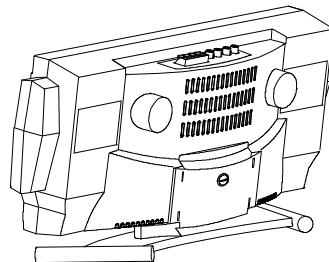



If you ever need to remove the main unit from the pedestal:

1.) Place the entire unit face down on a flat surface.

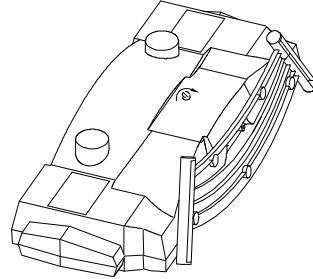

2.) Turn the pedestal base locking screw 'counter-clockwise' to loosen.

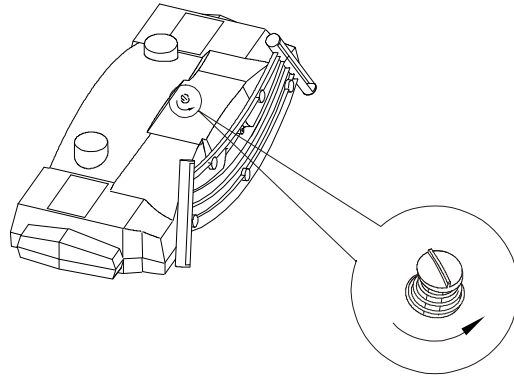

3.) Slide the pedestal outward and lift it up to completely remove it from the main unit.

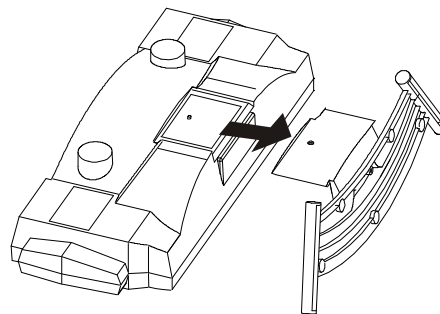



Installing The Remote Control Batteries

The remote control requires two “AAA” batteries, not included. We recommend that you use a well known brand of alkaline batteries for longest life and best performance.

Open the remote control battery compartment by sliding the battery compartment cover in the direction of the ‘arrow’.

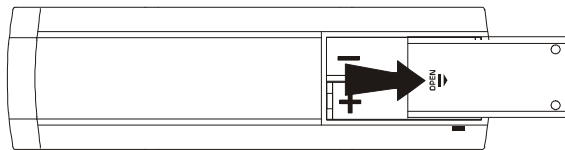

Install two “AAA” batteries in the compartment according to the polarity markings inside the compartment as shown in the illustration. If the batteries are installed incorrectly the remote control will not work. After installing the batteries replace the battery compartment cover.

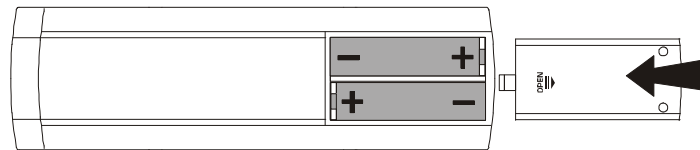

NOTE: When the operation of the remote control becomes intermittent or stops working completely replace the batteries as soon as possible. Never leave weak or exhausted batteries in the remote for an extended period of time. They may eventually leak and cause permanent damage to the remote control.

Battery Precautions

- Replacement of batteries must be done by an adult.
- Do not mix old and new batteries.
- Do not mix alkaline, standard (carbon-zinc) or rechargeable (nickel-cadmium) batteries.
- The supply terminals are not to be short-circuited.
- Non-rechargeable batteries are not to be recharged.
- Exhausted batteries are to be removed.
- Only batteries of the equivalent type are to be used.
- Batteries are to be inserted with the correct polarity.
- Dispose of batteries properly. Do not dispose of batteries in fire. The batteries may explode or leak.



Connecting The Speakers

NOTE: Always connect the speakers before switching the power 'On', and never operate the system without the speakers properly connected.

Make sure:

The left speaker is connected the left-pair (L) terminals.

The right speaker is connected the right-pair (R) terminals.

The speaker cables and the speaker terminals are color-coded.

Connect the Red wires to the Red terminals.

Connect the Black wires to the Black terminals.

If the wires are connected incorrectly the sound will be "muddy" or distorted.

To make the connection, completely depress the plastic levers to open the terminals, insert the bare end of the speaker wire into the terminal openings, and release the plastic levers to lock the wires in place.

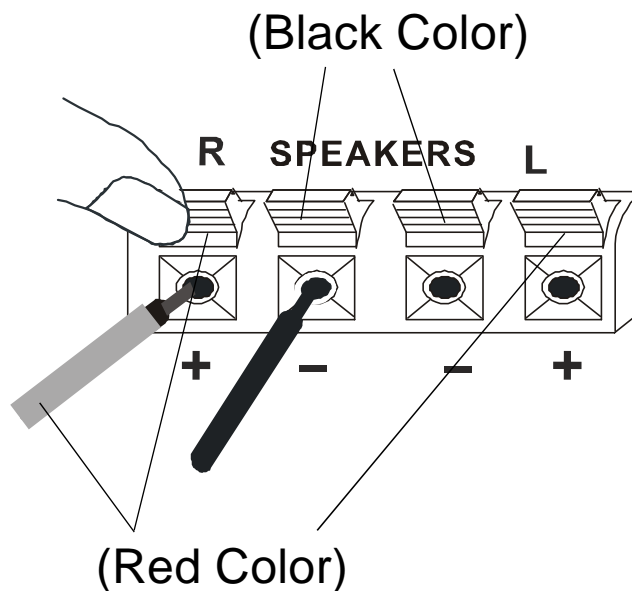



Auxiliary Input Jacks

This system includes **AUX IN R/L** Jacks. These jacks allow you to connect external audio equipment to this system and listen to the sound from the external equipment through the speakers of this system.

Examples of the types of external equipment that may be connected are: a cassette deck; the audio outputs from a VCR or DVD player; a personal cassette player, MP3 player, or a personal hard-disc audio jukebox device such as an iPod®.

Connect the audio output jack(s) or headphone jack of the external audio equipment to the **AUX IN R/L** jacks on the back panel of this system.

CONNECTION CABLES ARE INCLUDED.

You may leave your external device permanently connected to this system if you wish. It is not necessary to disconnect the external device in order to listen to the Tuner or CD player in this system.

iPod nano

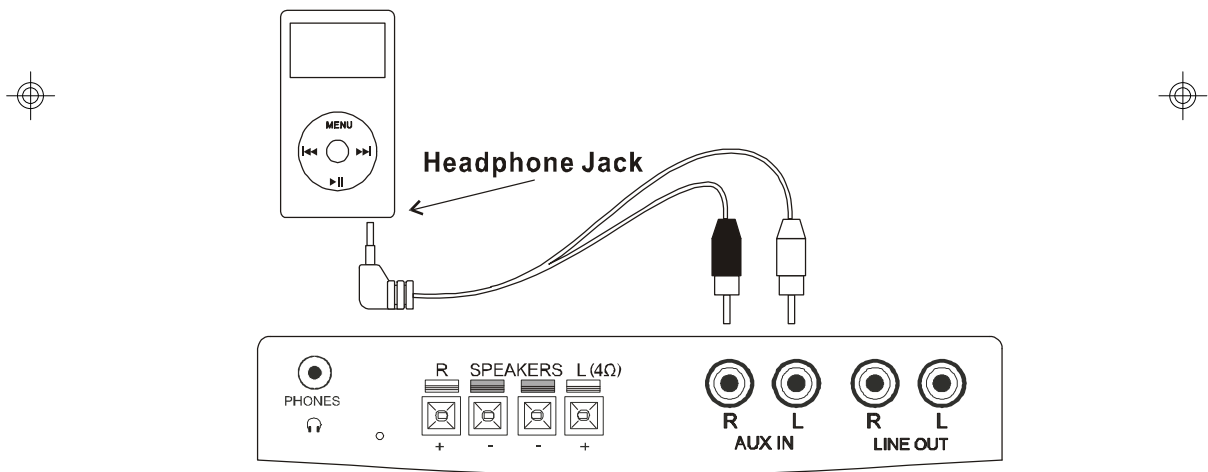

Instructions for listening to your external device will be found at the end of this Owner's Manual.

iPod® is a trademark of Apple Computer Inc., registered in the U.S. and other countries.



LINE OUT L/R Output Jacks

This system includes **L/R LINE OUT** output jacks for the connection to your recording equipment (eg. MiniDisc or Cassette Recorder).

Connect the **L/R LINE OUT** jacks of this system to the L/R Record Input (REC IN) or Line Input (LINE IN) jacks of your external recording device.

CONNECTION CABLES ARE NOT INCLUDED.

NOTE: *the remote controller of this system cannot control the external equipment. You must adjust the volume level of the external equipment as desired.*

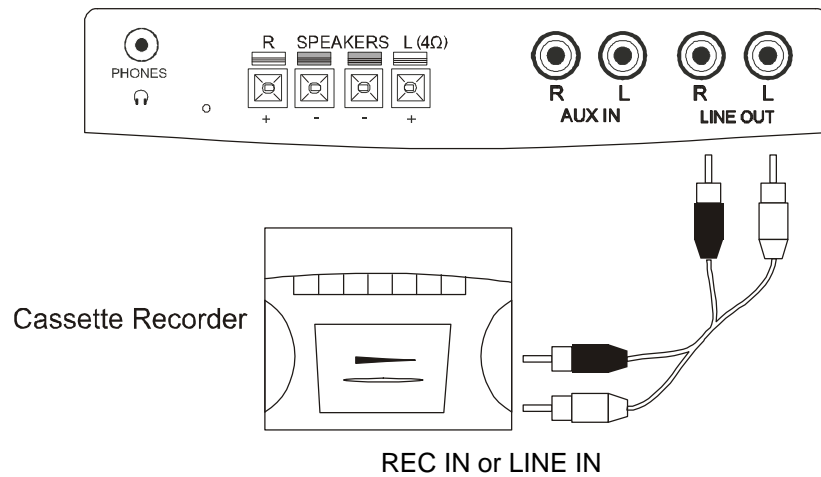

Always refer to the Instructions Manual of the external equipment.

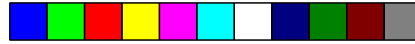

Power Source

This system is designed to operate on 120V AC 60Hz house current only. Connecting this system to any other power source may cause damage to the system and such damage is not covered by your warranty.

NOTE: *The system has polarized AC plug with one wide blade and one narrow blade. The plug will only fit into matching polarized AC outlets.*

This is a safety feature to reduce the possibility of electric shock. If the plug will not fit in your AC outlets, you probably have outdated non-polarized outlet. You should have your outdated outlet changed by a qualified, licensed electrician. Do not file the wide blade on the plug, or use an adapter to make the plug fit into your outlet. This defeats the safety feature and could expose you to electric shock.

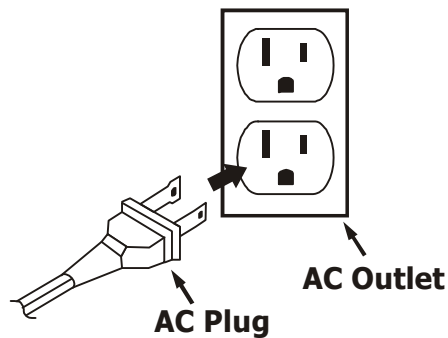

Placement Of The System

The system should be placed on a stable, level surface such as a table, shelf, or stand, convenient to a 120V 60Hz AC outlet, out of direct sunlight, and away from sources of excess heat, dust, moisture, or vibration.

Although the main unit is 9.75" high with the CD door closed, 12" of clearance is required for the CD door to open fully. If you are using this unit on a bookshelf make sure there is a gap of at least 12" between the shelves. If the CD door encounters an obstruction while opening it will close again automatically.

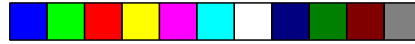

Stereo Headphone Jack

This system includes a stereo  **PHONES** jack on the top panel of the main unit. You may connect a set of stereo headphones, not included, to this jack for private listening without disturbing others.

The main speakers are automatically shut off when headphones are connected to the  **PHONES** jack. Make sure that the plug from your headphones is fully inserted into the headphone jack. If the plug is not fully inserted the sound may be intermittent, or you may only hear sound from one side of the headphones.

IMPORTANT: *To prevent hearing damage always set the volume control to a low level before you connect the headphones. Then connect the headphones, put them on, and very gradually increase the volume to a comfortable listening level. Remember that CDs may contain both very soft and very loud passages. Adjust the volume to a comfortable level using a louder passage, so that you always know what the maximum level will be.*

Protect Your Furniture

This model is equipped with non-skid rubber 'feet' to prevent the product from moving when you operate the controls. These 'feet' are made from non-migrating rubber material specially formulated to avoid leaving any marks or stains on your furniture. However certain types of oil based furniture polishes, wood preservatives, or cleaning sprays may cause the rubber 'feet' to soften, and leave marks or a rubber residue on the furniture. To prevent any damage to your furniture we strongly recommend that you purchase small self-adhesive felt pads, available at hardware stores and home improvement centers everywhere, and apply these pads to the bottom of the rubber 'feet' before you place the product on fine wooden furniture.



LOCATION OF CONTROLS AND INDICATORS

Front Panel

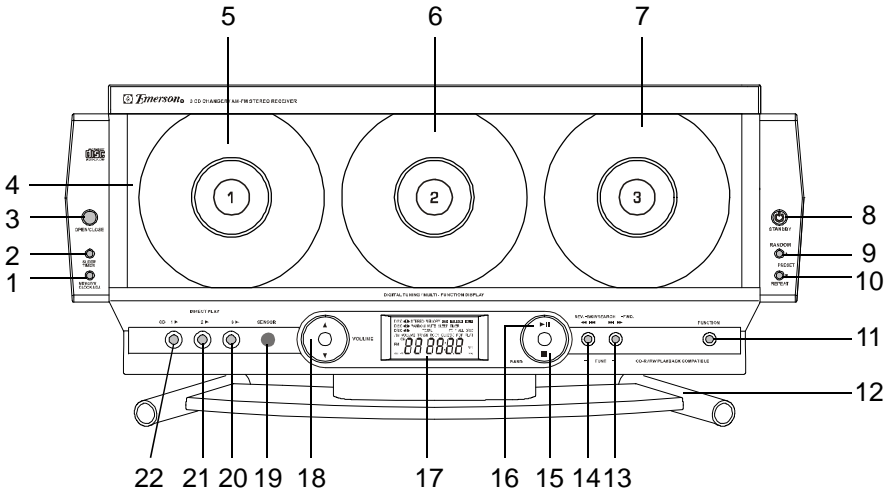

Top Panel

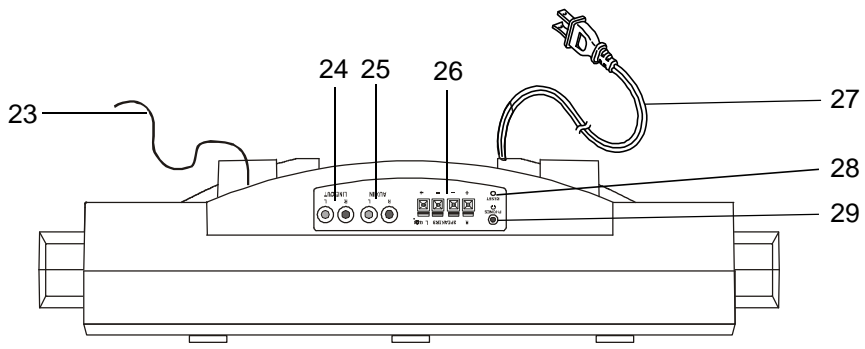

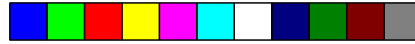

- 1.) **MEMORY/CLOCK ADJ.** Button.
- 2.) **SLEEP/TIMER** Button.
- 3.) CD Door **OPEN/CLOSE** Button.
- 4.) CD Door.
- 5.) Disc **1** Tray.
- 6.) Disc **2** Tray.
- 7.) Disc **3** Tray.
- 8.) **⏻** **STANDBY** Button With Lighting.
- 9.) **RANDOM/PRESET ▲** Button.
- 10.) **REPEAT/PRESET ▼** Button.
- 11.) **FUNCTION** Button.
- 12.) Pedestal Stand.
- 13.) **▶▶ SKIP FWD./SEARCH (TUNE +)** Button.
- 14.) **◀◀ SKIP REV./SEARCH (TUNE -)** Button.
- 15.) **■** Stop Button.
- 16.) **▶||** Play/Pause Button.
- 17.) **MULTI-FUNCTION DISPLAY.**
- 18.) **VOLUME ▲ / ▼** Buttons.
- 19.) Remote **SENSOR.**
- 20.) **CD 1** Play Button.
- 21.) **CD 2** Play Button.
- 22.) **CD 3** Play Button.
- 23.) FM Lead Wire Antenna.
- 24.) **LINE OUT R/L** Jacks.
- 25.) **AUX IN R/L** Jacks.
- 26.) Speaker Terminals.
- 27.) AC Power Cord.
- 28.) **RESET** Button (Inside Pin Hole).
- 29.) **📞 PHONES** Jack.

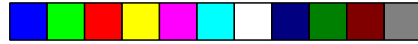

Remote Control

- 1.) **CD3** Button.
- 2.) **CD2** Button.
- 3.) **CD1** Button.
- 4.) Numeric Buttons.
- 5.) **REPEAT/PRESET** ▾ Button.
- 6.) **EQ** Button.
- 7.) **⏮ SKIP REV./Search**
(**TUNE -**) Button.
- 8.) **■ STOP/BAND** Button.
- 9.) **CD/DISC SKIP** Button.
- 10.) **TUNER** Button.
- 11.) CD Door **OPEN/CLOSE** Button.
- 12.) IR (Infrared) Transmitter.
- 13.) **POWER** Button.
- 14.) **AUX** Button.
- 15.) **▶|| PLAY/PAUSE** Button.
- 16.) **VOLUME ▲** Button.
- 17.) **VOLUME ▼** Button.
- 18.) **▶▶ SKIP FWD./Search**
(**TUNE +**) Button.
- 19.) **MUTE** Button.
- 20.) **RANDOM/PRESET ▲** Button.
- 21.) **TIMER/SLEEP** Button.
- 22.) **MEM./CLK.ADJ.** Button.
- 23.) Battery Compartment.
(Back Cabinet)

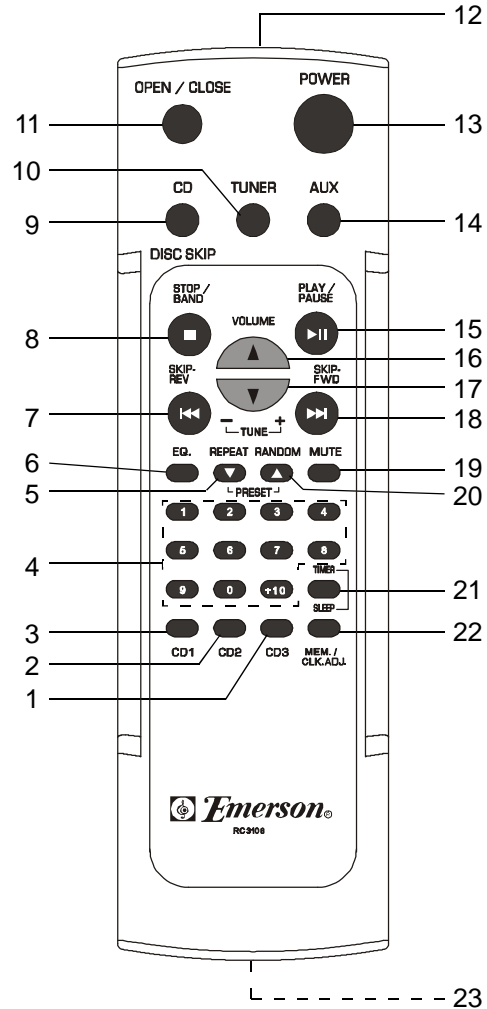

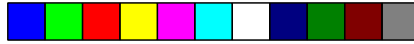

OPERATING INSTRUCTIONS

- **Make sure that you have fully extended the FM antenna wire.**
- **Make sure that you have installed 2 “AAA” batteries in the remote control.**
- **Make sure that the system is connected to an AC outlet that is always “live”. Do not connect the system to an AC outlet controlled by a wall switch.**

Remove The Dummy CD Transit Protection Cards

This system was shipped with a “dummy CD” transit protection card in each of the 3 CD players. These cards were inserted to prevent the CD player mechanisms from moving during shipping and handling. They must be removed and discarded before you can load your own CDs. After connecting the system to your AC outlet, press the **⏻ STANDBY (POWER)** button to turn the system ‘On’. Then press the **OPEN/CLOSE** button to open the CD door. Remove the 3 “dummy CDs” and discard them.

Press the **OPEN/CLOSE** button to close the CD door.

General Controls

Most of the main functions of this system can be operated by the controls on the front panel of the main unit, or by the buttons on the remote control handset. If a specific function can only be operated by the remote handset, or by the front panel controls, this will be clearly indicated in the instructions.

When operating this system with the remote control handset make sure that the Infrared transmitter on the front of the remote handset is pointed at the remote sensor on the front panel of the main unit. The effective operating range of the remote control is approximately 15 feet. Please note that bright sunlight or room lighting may interfere with the remote control operation. If the remote is not operating properly try reducing the brightness of the room or moving closer to the main unit. If this does not solve the problem, it may be time to change the remote control batteries.

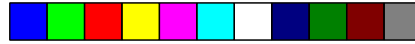

Volume Controls

To increase or decrease the system volume press the **VOLUME ▲** or **▼** buttons on the front panel or the remote control.

The **VOLUME** Level Indicator will appear on the display when you change the volume level. The level indicator ranges from “00” (Minimum) to “30” (Maximum).



The system remembers the volume level when the power is switched ‘Off’ and automatically returns to the same level when the power is switched ‘On’ again.

Electronic Preset Equalizer “EQ” (On Remote Control Only)

The preset equalizer allows you to adjust the sound characteristic for the most popular types of music.

Press the **EQ** button on the the remote control to cycle through the following equalizer settings: **FLAT** (EQ ‘Off’), **POP**, **CLASSIC**, **ROCK**.

The appropriate EQ indicator appears in the display to confirm your selection. The system remembers the EQ setting when the power is switched ‘off’ and returns to the same setting when the power is switched ‘on’ again.

MUTE Button (On Remote Control Only)

Press the **MUTE** button on the remote control to shut off the speakers temporarily, for example, to answer the telephone.

The sound stops and the **MUTE** indicator flashes in the display.



Press the **MUTE** button again to cancel the Mute function and restore the sound. The **MUTE** indicator disappears.

The Mute function will also be canceled automatically by pressing the **VOLUME ▲** or **▼** buttons.



Setting The Clock

When the system is connected to an AC outlet the **⏻ STANDBY** button light comes 'On'.

The time display will show a flashing "AM 12:00".



This is your indication that the time is incorrect and needs to be set.

NOTE: Although it is not necessary to set the clock in order to listen to the radio or CD player, the clock must be set correctly if you intend to use the timer to turn the system 'On' and 'Off' automatically.

Do not press the **⏻ STANDBY (POWER)** button. The system must be in the Standby mode to set the clock.

You have the option of displaying the time in 12-Hour or 24-Hour modes.

12-Hour Mode - The time is displayed in 12-hour cycles with **AM / PM** indicators. This is the factory default setting.

24-Hour Mode - The time is displayed in 24-hour cycles with no AM / PM indicators. This is sometimes referred to as "Military Time". For example, "**PM 6:00**" would be displayed as "**18:00**".

- 1.) Depress the **MEMORY/CLOCK ADJ.** button, "**12Hr**" flashes in the display. Then press either the **▶▶** or **◀◀** buttons to alternatively to switch between the 12-hour and 24-hour display modes.

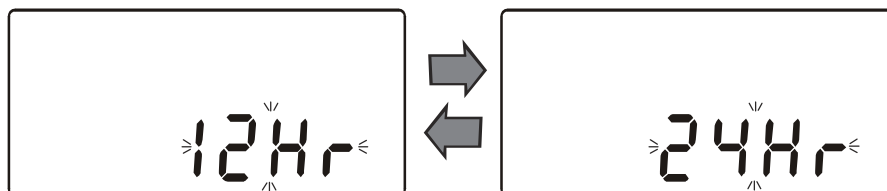



2.) Press the **MEMORY/CLOCK ADJ.** button again. The Hour digits begin flashing.



3.) Press the **▶▶** or **◀◀** buttons to set the display to the correct hour.

Be sure to observe the **AM/PM** indicators to make sure you are setting the Hour correctly.

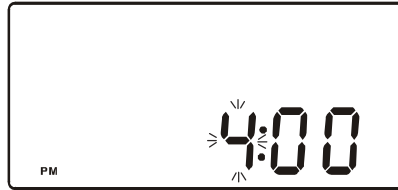

4.) Press the **MEMORY/CLOCK ADJ.** button again. The Minute digits begin flashing.



5.) Press the **▶▶** or **◀◀** buttons to set the display to the correct Minute.



6.) Press the **MEMORY/CLOCK ADJ.** once more.

The display stops flashing and the clock begins to run.

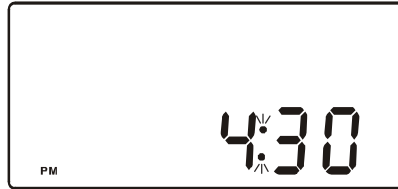

NOTES:

- After pressing the **MEMORY/CLOCK ADJ.** button to begin setting the clock, you must press the **▶▶** or **◀◀** buttons to adjust the display within 10 seconds, otherwise the digits stop flashing and the time cannot be adjusted. If this occurs, press the **MEMORY/CLOCK ADJ.** button again and then press the **▶▶** or **◀◀** buttons within 10 seconds to adjust the display.
- The display will always show the time when the system is in the Standby (Power Off) or **AUX** mode.

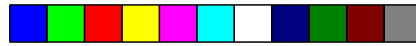

Listening To The Radio

- 1.) Press the **⏻ STANDBY (POWER)** button to turn the system 'On'. The display lighting comes 'On' and the **STANDBY** light goes 'Off'.
- 2.) Press the **FUNCTION** button on front panel or **TUNER** button on remote control to select the Tuner function.

An **AM** or **FM** frequency will appear on the display.



Press the **■ STOP/BAND** button again to switch between the AM and FM bands if necessary.

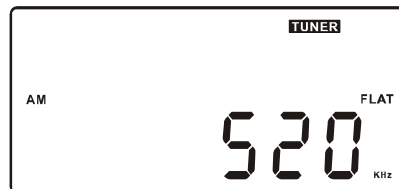

- 3.) Tune to the desired station as follows:

- **Manual Tuning**

Repeatedly press the **▶▶** or **◀◀** buttons until the display shows the exact frequency of the desired station. Use the Manual Tuning method to tune to weak or distant stations that are not strong enough to be recognized by the Automatic Tuning system.

- **Automatic Tuning**

Depress and hold the **▶▶** or **◀◀** buttons until the display begins to move, then release the buttons. The Tuner will search up or down the band for the next strong signal and stop on that station. Repeat this procedure until the tuner stops on your desired station.

- 4.) If you tuned to an FM Stereo station the **STEREO** indicator will appear in the display.



- 5.) Adjust the **VOLUME**, and **EQ** controls to the desired settings.
- 6.) When you are finished listening press the **⏻ STANDBY (POWER)** button to return the system to the Standby (Off) mode. The display lighting goes 'Off' and the **STANDBY** light comes 'On'.

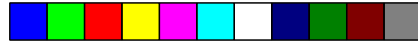

Hints For Better Reception

FM: The FM lead wire antenna on the back panel should be extended to its full length. You may also have to vary the direction of this antenna until you find the position that provides the best reception.

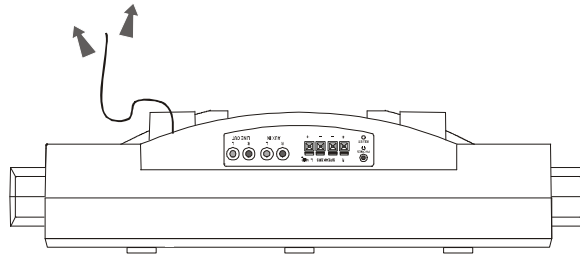

AM: The AM bar antenna is inside the cabinet of the main unit. You may need to change the position of the main unit until you find the position that provides the best reception for your favorite AM stations.

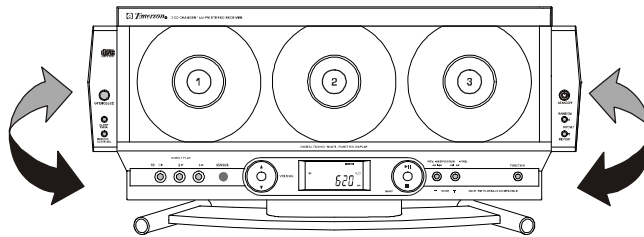



Presetting Stations In The Tuner Memory

You can store up to **20** of your favorite stations (**10 FM / 10 AM**) in the Tuner memory for easy recall at any time.

Using either the manual or automatic tuning method as described on page 20.

- 1.) Tune to the first station you wish to memorize.

Example: **FM 103.5 MHz.**



- 2.) Press the **MEMORY/CLOCK ADJ.** button.

The display Preset Memory "00" and the **MEMORY** indicator will flash.

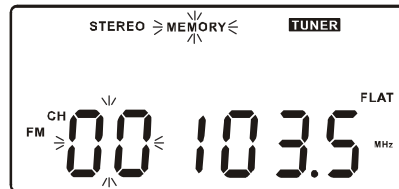

- 3.) Press the **PRESET** ▲ or ▼ button to select any of the 10 available Preset Memory. Example: **CH 1.**

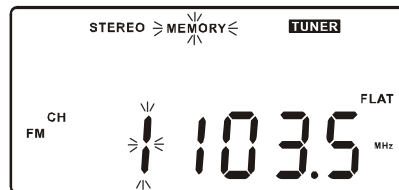

- 4.) Press the **MEMORY/CLOCK ADJ.** button.

The flashing **MEMORY** indicator disappears but the preset memory number "1" remains in the display, confirming that your station has been entered in preset memory **CH 1.**



- 5.) Repeat steps 1-4 selecting a different preset memory number each time until you have stored up to 10 stations in one band.

- 6.) Then press the **STOP/BAND** button to select the **AM** band and repeat steps 1 through 4 to store up to 10 stations on that band.



NOTE: After you press **MEMORY/CLOCK ADJ.** button the first time, you must press **PRESET ▲** or **▼**, and **MEMORY/CLOCK ADJ.** buttons within 10 seconds, while the **MEMORY** indicator is flashing on the display, or your station will not be memorized.

If the **MEMORY** indicator stops flashing press the **MEMORY/CLOCK ADJ.** button once to start the indicator flashing again, then press **PRESET ▲** or **▼**, and **MEMORY/CLOCK ADJ.** buttons again to memorize your station.

Recalling Preset Stations

- 1.) Turn the system 'On', press the **■ STOP/BAND** button to select the Tuner function and the desired band.
- 2.) Press the **PRESET ▲** or **▼** button repeatedly until the desired preset number and frequency appears on the display.
 - You may also use the number buttons on the remote control to directly select the desired preset memory number.
 - Simply press the corresponding number key on the remote handset to select preset memory numbers **1** through **9**.
 - To select preset memory number 10, press the **"+10"** button and then the **"0"** button.

Changing Preset Stations

- 1.) Tune to the new station you want to memorize and press the **MEMORY/CLOCK ADJ.** button to start the **MEMORY** indicator flashing.
- 2.) Repeatedly press the **PRESET ▲** or **▼** button until the display shows the number of the preset memory you wish to change.
- 3.) Press the **MEMORY/CLOCK ADJ.** button again. The new station is entered in the memory and the previous station is deleted.



Playing Compact Discs

IMPORTANT: This CD player can play normal CDs plus CD-R (CD Recordable) and CD-RW (CD ReWritable) discs. However the playability of CD-R/RW discs may be affected by the type of software that was used in 'ripping' the tracks from the original discs and 'burning' the tracks onto the blank media. Playability may also be affected by the quality and condition of the blank media you use for recording. 100% compatibility cannot be guaranteed. This is not an indication of any problems with your player.

Normal Playback

- 1.) Press the **⏻ STANDBY (POWER)** button to turn the system 'On'. Press the **FUNCTION** button on front panel or **CD/DISC SKIP** button on remote control to select the CD function.
- 2.) Press the **OPEN/CLOSE** button to open the CD door. If you have not already done so, remove the 3 "dummy CD" transit protection cards and discard them. You cannot play your own CDs unless these cards are removed.

NOTE: Never open or close the CD door rapidly by hand - doing so will damage the deck mechanism.

In an emergency situation (AC power failure) where you have no option other than to open or close the door by hand, do so very slow and gently.

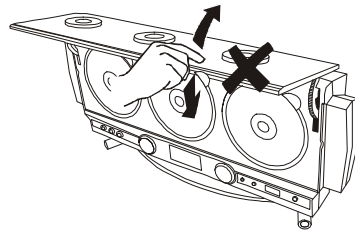

APPLY ONLY LIGHT PRESSURE - NEVER USE FORCE ON THE DOOR.

- 3.) Load 1, 2, or 3 of your own CDs into the player with the printed 'labels' facing you. Gently press downward on each CD near the center hole to insure that the discs are properly 'seated' on the spindles.

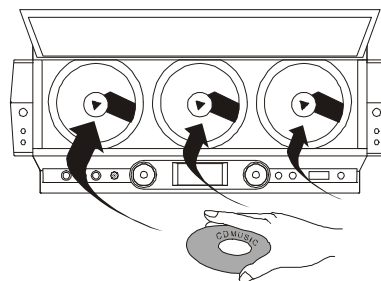

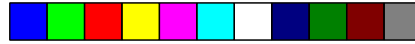

- 4.) Press the **OPEN/CLOSE** button to close the CD door.

The flashing dashes “-----” appear in the display as the player reads the Table Of Contents on each disc.

After reading the last disc the display will show the total tracks and playing time of **DISC 1**.



NOTE: It may take 15 to 20 seconds for the player to read the TOC of all 3 discs. The reading time may be even longer if you are using CD-RW (ReWritable) discs. This is normal and not an indication of any problem with your unit.

- 5.) Press the **▶|| PLAY/PAUSE** button to begin playback **ALL DISC**.

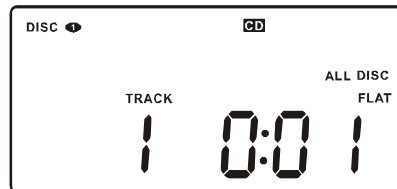

To playback only Disc 1, Disc 2 or Disc 3, press the **CD1**, **CD2** or **CD3** buttons.

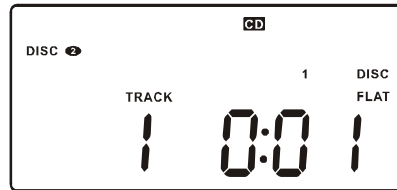

- 6.) When playback begins, adjust the **VOLUME** and **EQ** controls as desired.

- 7.) To skip to higher or lower numbered tracks press the **▶▶** or **◀◀** until the desired track number appears in the display, then release the buttons. Playback will begin on the desired track.

- 8.) To pause temporarily during CD playback press the **▶|| PLAY/PAUSE** button again.

The sound stops and the elapsed time flashes in the display, but the disc continues spinning.

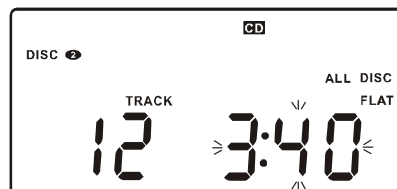

Press the **▶|| PLAY/PAUSE** button once more to cancel Pause mode and resume playback at the same point.



9.) Playback will continue until all tracks on all discs have been played, then the player stops and the display shows the total tracks number and playing time on the last disc played.

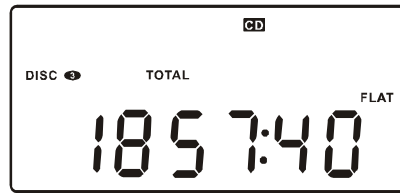

To stop playback at any time, press the ■ **STOP/BAND** button.

10.) If you are finished listening, press the **OPEN/CLOSE** button to open the CD door, remove your discs from the player, re-close the door and press the ⏻ **STANDBY (POWER)** button to return the system to the Standby (Off) mode.





Special Playback Modes

The CD player in this system allows you:

- To automatically repeat a single track, all tracks on a selected disc, or all tracks on all discs;
- To play the tracks on a selected disc in random order, or to play all tracks on all discs in random order;
- To program up to 20 tracks on all discs to play in any desired order.

Repeat Playback

The Repeat function can be activated during playback or while the player is stopped.

One Track Repeat

Select the disc and track to be repeated and begin playback.

Press the **REPEAT** button three times.

The “**◀ 1**” indicator appears in the display. The selected track will be repeated continuously.

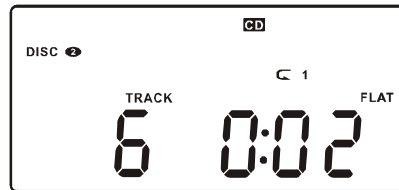

One Disc Repeat

Select the disc to be repeated and begin playback.

Press the **REPEAT** button twice.

The “**◀ 1 DISC**” indicator appears in the display. All the tracks on the selected disc will be repeated continuously.

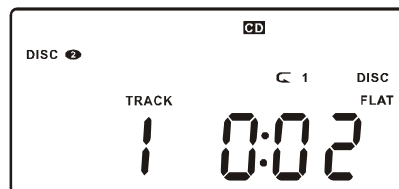

All Discs Repeat

Load 2 or 3 disc in the player and begin playback.

Press the **REPEAT** button once.

The “**◀ ALL DISC**” indicator appears in the display. All tracks on all discs in the player will be repeated continuously.

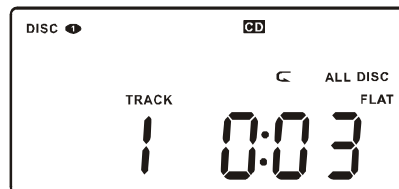



To cancel Repeat playback mode press the **REPEAT** button until all Repeat indicators disappear from the display.

Repeat mode can also be canceled by opening the CD door.

Random Playback

You can select random playback while the discs are playing or when the player is stopped.

One Disc Random Playback

Select the disc and then press the **RANDOM** button twice.

The “**RANDOM**” and “**1 DISC**” indicators appear in the display.

If necessary, press the **▶|| PLAY/PAUSE** button to begin playback.

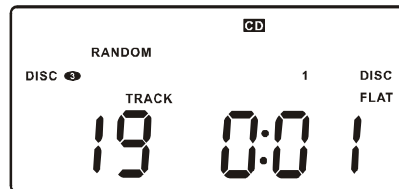

The player will randomly select a track from the disc and begin playback. Random playback will continue until all tracks have played once, then the player stops.

All Discs Random Playback

Load up to 3 CDs in the player as usual and then press the **RANDOM** button once.

The “**RANDOM**” and “**ALL DISC**” indicators appear in the display.

If necessary, press the **▶|| PLAY/PAUSE** button to begin playback.



The player will randomly select a track from among the discs and begin playback. Random playback will continue until all tracks on all discs have played once, then the player stops.

To cancel random playback, press the **RANDOM** button until **RANDOM** indicator disappears and normal playback will resume from that point.

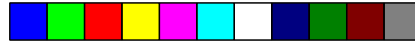

Programmed Playback

The Programmed Playback feature allows you to program a total of up to **20** tracks from among all 3 discs for playback in any desired order. You may program the same track to play several times within a program sequence if desired.

NOTE: You cannot program tracks during playback. If a disc is playing press the **■ STOP/BAND** button first to stop playback before beginning the programming steps below.

- 1.) Load up to 3 discs in the player and wait until the player has read the Table of Contents of all discs.
- 2.) Press the **MEMORY/CLOCK ADJ.** button.

The **MEMORY** indicator and Program Memory **P- 01** will flash and the display will show **DISC 1**, Track **00**.

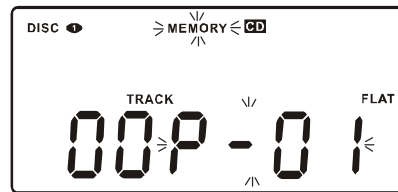

- 3.) Press one of the **CD** buttons to select the disc that contains the first track to be programmed. (Example: **DISC 3**).

Then press the **▶▶** or **◀◀** buttons to select the first track on that disc to be programmed. (Example: Track **7**).

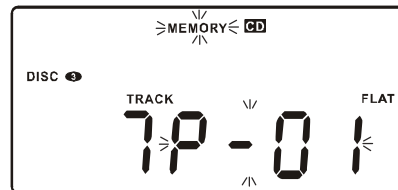

- 4.) Press the **MEMORY/CLOCK ADJ.** button again to enter **DISC 3 / Track 7** in program memory. The program memory number advance to "**P- 02**".

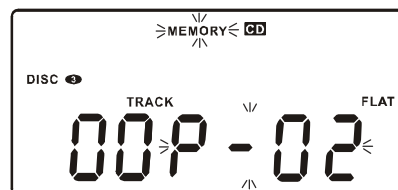



5.) Repeat steps 3 and 4 selecting the desired Disc number and Track number each time until you have entered up to **20** tracks in the CD program memory.

NOTE: You may also select the track numbers directly with the 1-9 number buttons on the remote control.

- For tracks 1 through 9, simply press the corresponding number button.
- For tracks 10 and higher first press the “+10” button and then the corresponding button for the second digit.
- For track 12, press “+10” and then press “2”.
- For track 23 press “+10” twice, then press “3”.

6.) Press the **▶|| PLAY/PAUSE** button to begin programmed playback.

The **MEMORY** indicator stops flashing and remains on. The player will play the track that you programmed in the desired sequence.

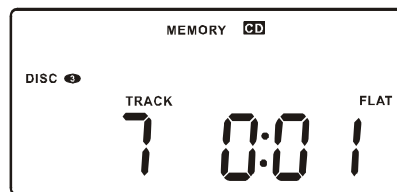

- After the last programmed track has played the player stops, but the display returns to the flashing “**P-01**”.

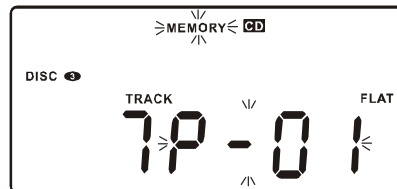

- To play the programmed sequence again, press the **▶|| PLAY/PAUSE** button.
- To cancel the programmed sequence from the memory press the **■ STOP/BAND** button while the display is flashing.
- The Program sequence can also be cleared from the memory by opening the CD door.



Programmed Repeat Playback

You can use the Programmed and Repeat Playback functions together to continuously repeat a programmed sequence.

First program up to 20 tracks as described on page 29, then press the **REPEAT** button once to select **Repeat All** playback.

Press the **▶|| PLAY/PAUSE** button to begin Programmed Repeat Playback.

The **"MEMORY"** and **"⏪ ALL"** indicators appear in the display.

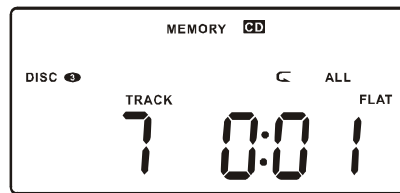

The programmed sequence will be repeated continuously.





Special Functions

Timer Operation

This system includes a programmable Timer function. You can use the timer to wake you up to the Radio or to your favorite CD.

NOTE: The timer can only be programmed while the system is in the Standby (Power Off) mode.

- 1.) Press the **SLEEP/TIMER** button once, the display lighting turns 'On'.

The **TIMER** indicator flashes and "**VOLUME 20**", "**AM 12:00**", "**TUNER**" appear in the display.



- 2.) While the **TIMER** indicator is still flashing, press the **SLEEP/TIMER** button once more, the Hour digits will begin flashing in the display.



- 3.) Press the **◀** or **▶** button to set the display to the desired turn on hour, **AM** or **PM**.



- 4.) Press the **SLEEP/TIMER** button. The Minute digits begin flashing.



- 5.) Press the **◀** or **▶** button to set the display to the desired turn on minute.





- 6.) Press the **SLEEP/TIMER** button. The **TUNER** indicator begins flashing.
 Press the **⏪** or **⏩** button to switch between **TUNER** or **CD** mode.

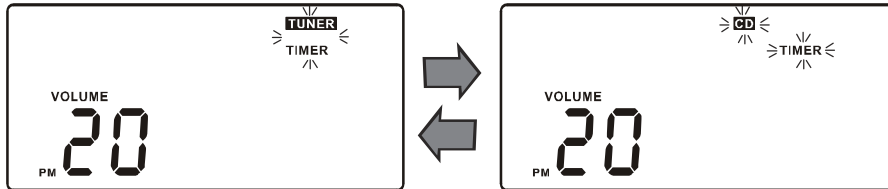

- 7.) Press the **SLEEP/TIMER** button.
 The **VOLUME** "20" digits begin flashing.
 Press the **⏪** or **⏩** button to adjust the turn 'On' volume level as desired.

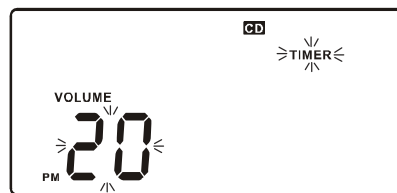

- 8.) Press the **SLEEP/TIMER** button again to return to correct time. The display lighting goes 'Off' and the **STANDY** indicator comes 'On'.
 The **TIMER** indicator remains 'On'.

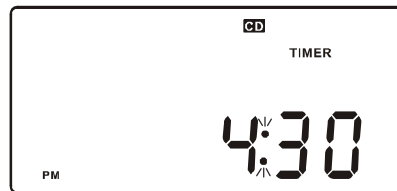

At the selected time the system will turn on automatically. It will continue to operate until you press the **⏻** **STANDBY (POWER)** button to shut the power off. The system will shut off but the Timer remains set for the following day.

To deactivate the Timer, press the **SLEEP/TIMER** button once.

The **TIMER** indicator disappears.



NOTES: After pressing the **SLEEP/TIMER** button to begin setting the Timer, while the **TIMER** indicator is flashing, you must press the **⏩** or **⏪** buttons to adjust the display or press the **SLEEP/TIMER** to skip to next step within 5 seconds, otherwise the digits stop flashing and the Timer cannot be adjusted.



SLEEP Timer

This system includes a programmable Sleep Timer that allows you to fall asleep to between 10 and 90 minutes of music and then shuts the power 'Off' automatically.

To operate the sleep timer:

1.) Turn the system 'On' and operate either the TUNER or CD function as usual.

2.) Press the **SLEEP/TIMER** button.

The display will show "90" indicating that the sleep timer will shut the power off after 90 minutes.



Continue pressing the **SLEEP/TIMER** button to reduce the amount of Sleep Timer operation in 10-minute decrements: 90, 80, 70, 60, 50, 40, 30, 20, 10, Sleep Timer 'Off'.

3.) After a few seconds the Sleep Time display disappears and the normal Tuner or CD display returns.

The **SLEEP** indicator remains in the display.

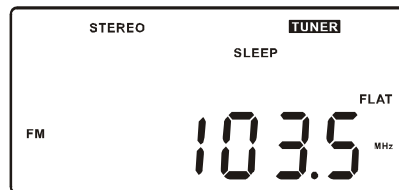

When the Sleep Timer counts down to "00", the power shuts off automatically.

NOTES:

- You can shut the unit off manually before the Sleep Timer counts down to "00" by pressing the **STANDBY (POWER)** button at any time.
- If you are falling asleep to CD the system will only operate until the CD ends. If you set the Sleep Timer for 90 minutes but your CD is only 45 minutes long, the music will stop after 45 minutes.



Auxiliary Operation

To listen to an auxiliary audio source connected to the **AUX IN** jacks on the top panel of this unit (refer to page 9).

Press the **FUNCTION** button on the front panel or **AUX** button on the remote control to select the Aux function.

The **AUX** indicator appears in the display.

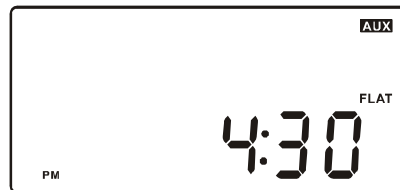

Operate the external device as you would normally. When you hear the music from your external source adjust the **VOLUME** and **EQ** controls of this system as desired.



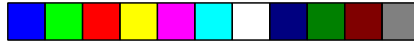

Resetting The System Computer

This system is equipped with a special circuit designed to protect the internal computer from permanent damage due to unexpected power surges.

If you find that the system does not respond to any commands from the front panel controls or the remote handset, the system probably experienced a sudden power surge that activated the protection circuit.

To reset the system after a power surge use the point of a pencil, a toothpick, a straightened paper-clip or similar object to press the **RESET** button which is located in a small opening on the top panel.

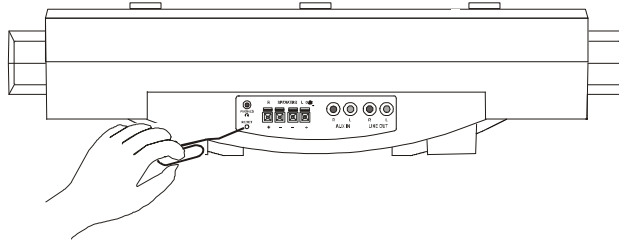

The system will return to the Standby (power 'Off') mode.

NOTE: *Resetting the system computer also clears all of the system memory and returns the system to its original factory default settings. All of the preset tuner memories, the clock and the timer settings will be erased after you press the **RESET** button. It will be necessary to re-enter the stations in the tuner preset memories, reset the clock and the timer settings.*



CARE AND MAINTENANCE

Compact Disc Care

- To remove a disc from its storage case, press down on the center of the case and lift the disc out, holding it carefully by the edges.

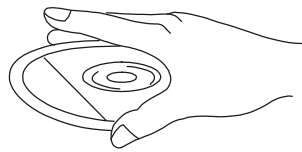
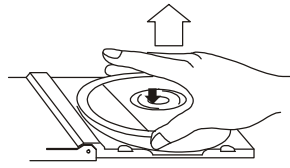

- Fingerprints and dust should be carefully wiped off the disc's recorded surface with a soft cloth. Unlike conventional records, compact discs have no grooves to collect dust and microscopic debris, so gently wiping with a soft cloth should remove most particles. Wipe in a straight line from the inside to the outside of the disc. Small dust particles and light stains will have absolutely no effect on reproduction quality.

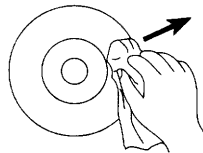
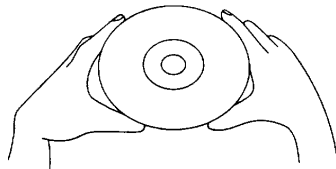

- Clean the disc periodically with a soft, lint-free, dry cloth. Never use detergents or abrasive cleaners to clean the disc. If necessary, use a CD cleaning kit.
- Never write on or affix labels to the surface of compact discs.



Care Of The Cabinet

- If the cabinet becomes dusty wipe it with a soft dry dust cloth. Do not use any wax or polish sprays on the cabinet.
- If the front panel becomes dirty or smudged with fingerprints it may be cleaned with a soft cloth slightly dampened with a mild soap and water solution. Never use abrasive cloths or polishes as these will mar the finish of your unit.

Caution

Never allow any water or other liquids to get inside the unit while cleaning.



Emerson[®]
SERVICE

TO FIND THE LOCATION AND PHONE
NUMBER OF YOUR NEAREST SERVICE
CENTER PERMITTED TO PERFORM
WARRANTY...

CALL TOLL FREE: 1-800-695-0098

FOR ADDITIONAL SET-UP OR OPERATING ASSISTANCE
PLEASE CALL:
1-800-898-9020

FOR CUSTOMER SERVICE, PLEASE WRITE TO:
Emerson Radio Corp.,
Consumer Affairs Dept.,
5101 Statesman Drive,
Irving, TX 75063.

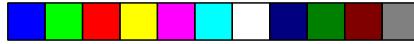

LIMITED WARRANTY

Emerson Radio Corp. warrants manufacturing defects in original material, including original parts and workmanship, under normal use and conditions, for a period of ninety (90) days from the date of original purchase in the U.S. With your dated proof of purchase, we will provide repair service at no charge for labor and parts at an authorized Depot Repair Facility, or replace the product in our discretion. For repair or replacement, pack your unit in a padded box, enclose your check or money order payable to Emerson Radio Corp. in the amount of \$9.00 (not required by California residents) to cover shipping and handling costs, and enclose a copy of your proof of purchase. Send your unit to:

Emerson Radio Corp.,
5101 Statesman Drive,
Irving, TX 75063.

This warranty does not cover damage from negligence, misuse, abuse, accident, failure to follow operating instructions, commercial use, rental, repairs by an unauthorized facility, or products purchased, used, serviced or damaged outside of the United States.

THIS WARRANTY GIVES YOU SPECIFIC LEGAL RIGHTS, AND YOU MAY ALSO HAVE OTHER RIGHTS WHICH VARY FROM STATE TO STATE.

AU898M

The Serial Number of your unit is located on a label on the back cabinet. Please take a moment to locate the Serial Number of your unit and write it in the space provided below. You may be asked to provide this number when calling to request customer service.

Model No: **MS3108**

Serial Number: _____



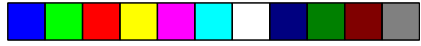

THIS PAGE IS INTENTIONALLY LEFT BLANK





THIS PAGE IS INTENTIONALLY LEFT BLANK



