



**1.0 CUBIC FOOT
MICROWAVE OVEN**

IMPORTANT

Call toll free 1-800-210-2281 for exciting information and special discounts on Extended Service Plans.

**OWNER'S MANUAL
AND
COOKING GUIDE**

MW8109W

PRECAUTIONS TO AVOID POSSIBLE EXPOSURE TO EXCESSIVE MICROWAVE ENERGY

- (a) Do not attempt to operate this oven with the door open since open-door operation can result in harmful exposure to microwave energy. It is important not to defeat or tamper with the safety interlocks.
- (b) Do not place any object between the oven front face and the door or allow soil or cleaner residue to accumulate on sealing surfaces.
- (c) Do not operate the oven if it is damaged. It is particularly important that the oven door close properly and that there is no damage to the: (1) door (bent), (2) hinges and latches (broken or loosened), (3) door seals and sealing surfaces.
- (d) The oven should not be adjusted or repaired by anyone except properly qualified service personnel.

CONTENTS

Precautions to Avoid Possible Exposure to Excessive Microwave Energy	1	The Principles of Microwave Cooking	18
Important Safety Instructions	2	Food Characteristics	18
Safety Precautions	3	Microwave Techniques	19
Grounding Instructions	4	Auto Weight Defrosting	20
Installation	4	Popping Popcorn	21
Care of Your Microwave Oven	5	Reheating	21
How to Use Your Microwave Oven Safely	5	Beverage Reheating	22
Feature Locations	6	Hold Warm	22
Operation Procedure	7	Hot Snacks and Appetizers	22
Controls	8	Meats	22
Setting The Clock	8	Poultry	24
Auto Weight Defrosting	9	Seafood	24
Cooking in One Stage	10	Eggs & Cheese	26
Cooking in Two and Three Stages	11	Vegetables	26
Auto Weight Defrosting and Cooking in Two Stages	12	Soups	27
Popcorn	13	Sauces	28
Beverages	13	Casseroles	28
Potatoes	14	Sandwiches, Including Hamburgers and Hot Dogs	29
Pizza	14	Pastas & Grains	29
Dinner Plate	15	Convenience Foods	30
Hold Warm	16	Beverages	30
Child Lock	17	Desserts	31
To Stop the Oven While it is Operating	17	Weight & Measure Conversion Chart	31
Cooking Guide	18	Specifications	31
		Before You Call for Service	32

IMPORTANT SAFETY INSTRUCTIONS

When using electrical appliances, basic safety precautions should be followed, including the following:

WARNING - To reduce the risk of burns, electric shock, fire, injury to persons or exposure to excessive microwave energy:

- 1 Read all instructions before using this appliance.
- 2 Read and follow the specific "PRECAUTIONS TO AVOID POSSIBLE EXPOSURE TO EXCESSIVE MICROWAVE ENERGY" found on page 1.
- 3 This appliance must be grounded. Connect only to a properly grounded outlet. See "GROUNDING INSTRUCTIONS" found on page 4.
- 4 Install or locate this appliance only in accordance with the provided installation instructions.
- 5 Some products such as whole eggs and sealed containers-for example, closed glass jars-may explode and should not be heated in this oven.
- 6 Use this appliance only for its intended use as described in this manual. Do not use corrosive chemicals or vapors in this appliance. This type of oven is specifically designed to heat, cook, or dry food. It is not designed for industrial or laboratory use.
- 7 As with any appliance, close supervision is necessary when used by children.
- 8 Do not operate this appliance if it has a damaged cord or plug, if it is not working properly, or if it has been damaged or dropped.
- 9 This appliance should be serviced only by qualified service personnel. Contact the nearest authorized service facility for examination, repair or adjustment.
- 10 Do not cover or block any openings on this appliance.
- 11 Do not store this appliance outdoors. Do not use this product near water-for example, near a kitchen sink, in a wet basement, or near a swimming pool, and the like. Do not use outdoors.
- 12 Do not immerse cord or plug in water.
- 13 Keep cord away from heated surfaces.
- 14 Do not let cord hang over edge of table or counter.
- 15 When cleaning surfaces of door and oven that come together when closing the door, use only mild, non-abrasive soaps or detergents applied with a sponge or soft cloth.
- 16 To reduce the risk of fire in the oven cavity:
 - (a) Do not overcook food. Carefully attend appliance if paper, plastic, or other combustible materials are placed inside the oven to facilitate cooking.
 - (b) Remove wire twist - ties from paper or plastic bags before placing bag in oven.
 - (c) If materials inside the oven should ignite, keep oven door closed, turn oven off, and disconnect the power cord, or shut off power at the fuse or circuit breaker panel.
 - (d) Do not use the cavity for storage purposes. Do not leave paper products, cooking utensils, or food in the cavity when not in use.
- 17 Do not use this microwave oven to heat corrosive chemicals (for example, sulfides and chlorides). Vapors from such corrosive chemicals may interact with the contact and springs of the safety interlock switches thereby rendering them inoperable.

SAVE THESE INSTRUCTIONS

SAFETY PRECAUTIONS

General Use

- 1 Do NOT attempt to tamper with or make any adjustments or repairs to door, control panel or any other part of the oven. Do NOT remove outer panel from oven. Repairs should only be done by qualified service personnel.
- 2 Do NOT operate the oven empty. The microwave energy will reflect continuously throughout the oven if no food or water is present to absorb energy.
- 3 If a fire occurs in the oven, touch the CLEAR / PAUSE pad and LEAVE THE DOOR CLOSED. Disconnect the power cord, or shut off power at the fuse or circuit breaker panel.
- 4 Do NOT attempt to dry clothes, newspapers or other materials in the oven. They may catch on fire.
- 5 Do NOT use recycled paper products, as they may contain impurities which may cause sparks and/or fires when used.
- 6 Do NOT hit or strike control panel. Damage to controls may occur.
- 7 Avoid inserting nails, wire, etc. through any holes in the unit during operation. Never insert a wire, nail or any other metal objects through the holes on the cavity or any other holes or gaps, because such objects may cause electric shock and microwave leakage.

Utensils

- 1 METAL CONTAINERS or dishes with metallic rims should not be used. Arcing may occur.
- 2 METAL TWIST-TIES may not be used in the microwave oven.
- 3 Do NOT use SEALED JARS or NARROW NECK bottles for cooking or reheating. They may shatter.
- 4 Do NOT use CONVENTIONAL THERMOMETERS in the microwave oven. They may cause arcing.
- 5 Remove PLASTIC STORE WRAPS before cooking or defrosting food in the oven.

- 6 For FURTHER INFORMATION on proper cooking utensils, refer to the microwave cooking guide.

Food

- 1 Never use your microwave oven for HOME CANNING. The oven is not designed to permit proper canning. Improperly canned food may spoil and be dangerous to consume.
- 2 COOKING TIMES given in the cooking guide are approximate. Factors that may affect cooking are starting temperature, altitude, volume, size and shape of food and utensils used. As you become familiar with the oven, you will be able to adjust for these factors.
- 3 It is better to UNDERCOOK RATHER THAN OVERCOOK foods. If food is undercooked, it can always be returned to the oven for further cooking. If food is overcooked, nothing can be done. Always start with minimum cooking times.
- 4 SMALL QUANTITIES of food or foods with LOW MOISTURE content can burn, dry out or catch on fire if cooked too long.
- 5 Do NOT boil eggs in their shell. Pressure may build up and the eggs will explode.
- 6 Potatoes, apples, egg yolks, whole acorn squash and sausage are examples of food with NONPOROUS SKINS. These must be pierced before cooking to prevent bursting.
- 7 POPCORN must be popped in a microwave corn popper. Microwave popped corn produces a lower yield than conventional popping. Do not use oven for popcorn unless popped in a microwave approved popcorn utensil or unless it's commercially packaged and recommended especially for microwave ovens. Do not use oil unless specified by the manufacturer.
- 8 DO NOT attempt to deep fat fry in your oven.
- 9 HEATED LIQUIDS can ERUPT if not mixed with air. Do not heat liquids in your microwave oven without first stirring.

GROUNDING INSTRUCTIONS

This appliance must be grounded. In the event of an electrical short circuit, grounding reduces the risk of electric shock by providing an escape wire for the electric current. This appliance is equipped with a cord having a grounding wire with a grounding plug. The plug must be inserted into an outlet that is properly installed and grounded.

WARNING: Improper use of the grounding plug can result in a risk of electric shock. Consult a qualified electrician or service person if the grounding instructions are not completely understood, or if doubt exists as to whether the appliance is properly grounded. If it is necessary to use an extension cord, use only a three wire extension cord that has a three blade grounding plug, and a three slot receptacle that will accept the plug on the appliance. The marked rating of the extension cord should be equal to or greater than the electrical rating of the appliance.

INSTALLATION

- Steady, flat location:** When positioning the microwave oven, it should be set on a flat, steady surface.
- Ventilation:** Do not block air vents. If they are blocked during operation, the oven may overheat and eventually cause oven failure. For proper ventilation, keep 3 inches of space between the oven's top, side, rear and the area where the unit is to be installed.
- Radio and TV reception:** Poor television reception and radio interference may result if the oven is located close to a TV, radio, antenna, or antenna wire. Position the oven as far from them as possible.
- Temperature and moisture:** Keep the oven away from hot air, steam or splashing liquids when choosing a place to locate it; otherwise, the unit's operation may be adversely affected, causing it to break down.

5. Power supply:

- Check your local power source. This microwave oven requires a 120V, 60Hz power supply.
 - Use a receptacle that will accept the ground prong.
- A . A short power supply cord is provided to reduce the risks resulting from becoming entangled in or tripping over a longer cord.
- B . Longer cord sets or extension cord are available and may be used if care is exercised in their use.
- C . If a long cord or extension cords is used, (1) the marked electrical rating of the cord set or extension cord should be at least as great as the electrical rating of the appliance, (2) the extension cord must be a grounding-type 3-wire cord, and (3) the longer cord should be arranged so that it will not drape over the counter top or tabletop where it can be pulled on by children or tripped over unintentionally.

- Examine the oven for any damage such as:** Dents, a misaligned door, broken door or a dent in the cavity. If any of the above are visible, **DO NOT INSTALL THE UNIT.** Notify the dealer immediately.

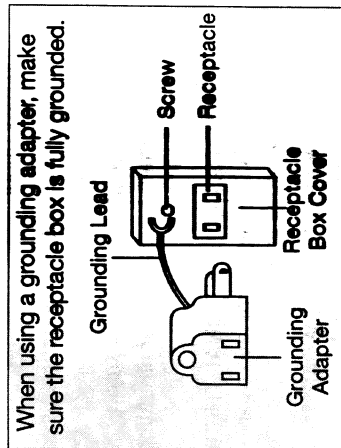
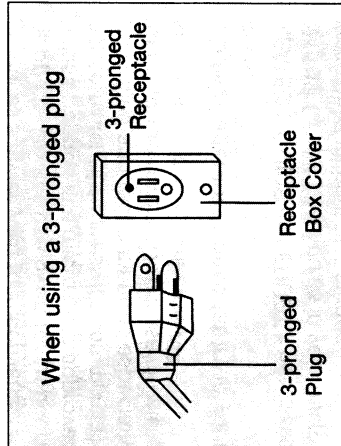

CARE OF YOUR MICROWAVE OVEN

- Disconnect the AC plug from the outlet before cleaning.
- Keep the inside of the oven clean. When food spatters or spilled liquids adhere to oven walls, wipe with a damp cloth. Mild detergent may be used if the oven gets very dirty. The use of harsh detergent or abrasives is not recommended.
- The outside oven surface should be cleaned with soap and water, rinsed and dried with a soft cloth. To prevent damage to the operating parts inside the oven, water should not be allowed to seep into the ventilation slots.
- If the Control Panel becomes wet, clean with a soft, dry cloth. Do not use harsh detergents or abrasives on Control Panel.
- If steam accumulates on both sides of the oven door, wipe with a soft cloth. This may occur when the microwave oven

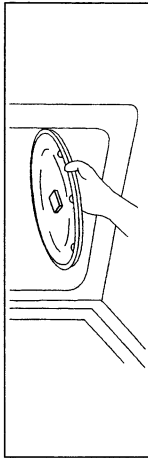

- The roller guide and oven cavity floor should be cleaned regularly to avoid excessive noise. Simply wipe the bottom surface of the oven with mild detergent water or window cleaner and dry. The roller guide may be washed in mild, sudsy water or dishwasher.

- Be sure to replace the turntable coupling and bearing washer.

Roller Guide

- The ROLLER GUIDE and oven floor should be cleaned frequently to prevent excessive noise.
- The ROLLER GUIDE MUST ALWAYS be used for cooking together with the Glass Tray.

Glass Tray

- Do NOT operate the oven without the Glass Tray in place.
- Do NOT use any other Glass Tray with this oven.
- If the Glass Tray is hot, ALLOW IT TO COOL before cleaning it or placing in water.
- Do NOT cook directly on the Glass Tray.

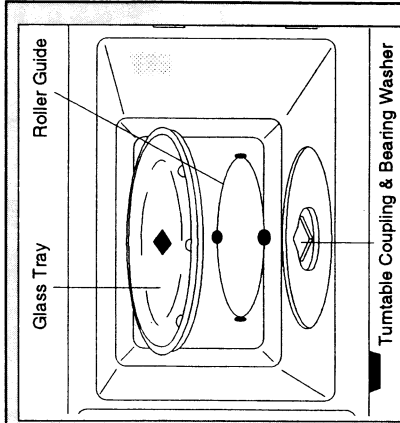

HOW TO USE YOUR MICROWAVE OVEN SAFELY

Although your oven is provided with safety features, it is important to observe the following:

- It is important not to defeat or tamper with safety interlocks.
- Do not place any object between the oven face and the door or allow residue to accumulate on sealing surfaces. Wipe the sealing area frequently with a mild detergent, rinse and wipe dry. Never use abrasive powders or pads.
- When opened, the door must not be subjected to strain, for example, a child hanging on an open door or any load which could cause the oven to fall forward and cause injury and damage the door. Do not operate the oven if it is damaged, until it has been repaired by a qualified person. It is particularly important that the oven door close properly and that there is no damage to the: i) Door (bent), ii) Hinges and Latches (broken or loosened), iii) Door seals and sealing surfaces.
- The oven should not be adjusted or repaired by anyone except properly qualified service personnel.

FEATURE LOCATIONS

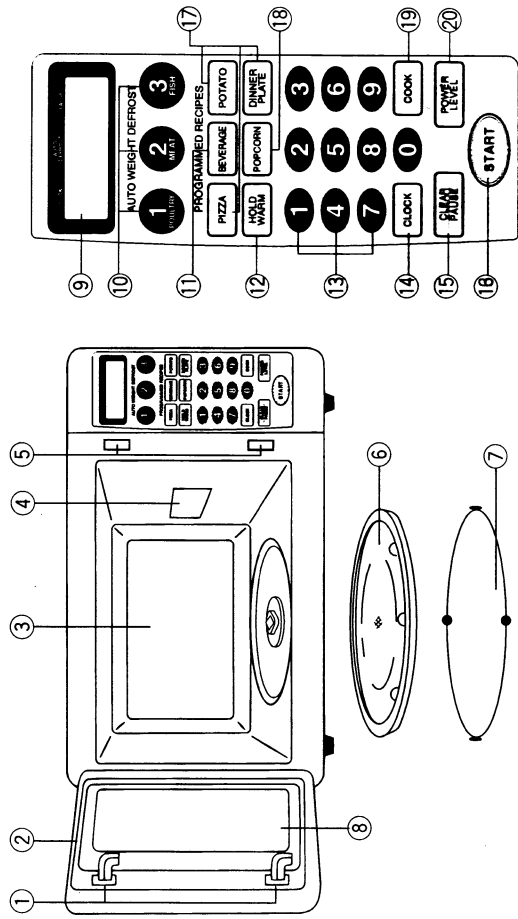

- Door latch** – When the door is closed, it will automatically lock shut. If the door is opened while the oven is operating, the magnetron will automatically shut off.
- Door seal** – The door seal maintains the microwave within the oven cavity and prevents microwave leakage.
- Oven cavity**.
- Spatter shield** – Protects the microwave outlet from splashes of cooking foods.
- Safety interlock system** – Prevents the oven from operating while the door is opened.
- Glass cooking tray** – Made of special heat resistant glass. The tray must always be in proper position on the turntable coupling and bearing washer before operating the oven. Do not cook food directly on the tray.
- Roller guide** – Supports the glass cooking tray. Must always be in proper position before operating the oven.
- Door screen** – Allows viewing of food. The screen is designed so that light can pass through, but not the microwaves.
- LED display** – Cooking time, power level, function indicators and the present time are displayed.
- Auto Weight Defrost pad** – Use to set the desired defrosting category.
- Beverage pad** – Used to heat beverages.
- Hold Warm pad** – Used to keep the food warm after cooking is completed.
- Number pads** – Use these pads to select the numbers for Stage 1, Stage 2 and Stage 3 cooking, Snack & Reheat, present and Auto Weight Defrost times and the cooking power level.
- Clock pads** – Touch to set the present time.
- Clear/Pause pad** – Use to stop the oven operation or to delete the cooking data.
- Start pad** – Use to start a selected operation.
- Pizza pad** – Touch to reheat precooked pizza.
- Potato pad** – Touch to cook potatoes.
- Dinner Plate pad** – Used to reheat plated foods.
- Popcorn pad** – Used to cook popcorn.
- Cook pad** – Used to set the cooking time.
- Power Level pad** – Used to set the desired cooking power level.

OPERATION PROCEDURE

This Section Includes Useful Information About Oven Operation

1. Plug the power supply cord into a standard 3-pronged 20 Amp, 120V AC 60Hz power outlet.
2. After placing the food in a suitable container, open the oven door and put it on the glass tray. The glass tray, roller guide turntable coupling & bearing washer must always be in place during cooking.
3. Shut the door. Make sure that it is firmly closed.

9 CHILD LOCK

- This safety feature prevents unwanted or unauthorized use by small children or other people.
1. To lock the oven, touch the number pad "0" once and then press the START pad five times. The display will show "LOC" and the oven will not operate.
 2. To unlock the oven, repeat the above procedure. The oven display will return to the present time.

10 BEEP TONE

When a correct pad is touched, a beep tone (0.2 seconds long) will be heard (except with Child Lock feature). If a pad is touched and no beep tone is heard, the unit has not, or cannot accept the instruction(s). At the end of the last cook cycle, the oven beeps 5 times, turns off automatically and "End" appears in the display window.

11 DOOR RELEASE

Opening the door during cooking will stop any cooking process without cancelling any program. Cooking resumes as soon as the door is closed and the START pad is touched.

12 TO CORRECT ANY IMPROPER PROGRAM ENTRIES

- A) Touch the CLEAR/PAUSE pad.
- B) Repeat the desired program entry from the beginning.
- C) Any erroneous entries will cause the display to show "Err" (error) when the START pad is touched.

Make sure the oven is properly installed and plugged into the electrical outlet.

1 When the oven door is opened, the light turns off. This is standard procedure for the oven. There are no microwaves being produced when the door is open.

2 The oven door can be opened at any time during operation by pulling the DOOR HANDLE. The oven will automatically shut off. To restart the oven, close the door and then press the START pad.

3 Each time a pad is touched, a beep will sound to acknowledge the touch (except Child Lock feature). One of the function pads must be touched before the number pads. Therefore, no beep will sound if a number pad is touched before the function pad.

4 The oven automatically cooks on high power (PL 10) unless set to a lower level. The display will flash "0:00" when the oven is first plugged in.

5 The display shows "End" when the oven turns off. To return to the time of day, touch the CLEAR/PAUSE pad or open the oven door.

6 When the CLEAR/ PAUSE pad is touched during oven operation, the oven stops operating and all information is retained. To erase all information (except the present time and memory data), touch the CLEAR / PAUSE pad once more. If the oven door is opened during operation, all information is retained.

7 If the START pad is touched and the oven does not operate, check the area between the door and the door seal for obstruction and make sure the door is closed securely. The oven will not start cooking until the door is completely closed or the program has been reset. Make sure the Child Lock feature is not turned on.

ADDITIONAL INFORMATION

- You cannot program more than 99 minutes and 99 seconds in each stage.
- You cannot program for more than 6 lbs of poultry, 4 lbs of meat or 3 lbs of fish in the Auto Weight Defrost stage.
- If you open the oven door during cooking, be sure to touch the START pad to begin cooking again.
- The oven door can be opened at any time while the oven is operating. If the door is opened, the oven will stop and the display will stop counting down the cooking time.
- If a function or program is selected, but not started within one minute, the display reverts to the present time and the program is erased.

CONTROLS SETTING THE CLOCK

When the oven is first plugged in, the display will flash "0:00" and a tone will sound. If the AC power every goes off, the display will flash "0:00" when the power comes back on.

The display will flash "0:00" and a tone will sound.

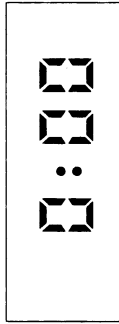

- Touch the Number pads to set the correct present time.

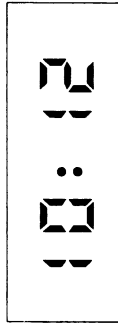

EXAMPLE: To set the time to "10:12", touch "1", "0", "1", "2" in sequence. The display will show the numbers pressed in the order you pressed them.

CLOCK

- Touch the CLOCK pad.

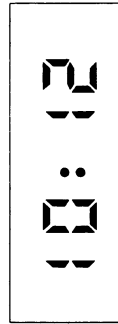

This display will show the present time and the colon will stop blinking. The 12 hour digital clock allows you to set it from "1:00" to "12:59".

NOTE: If the oven is used before the present time is set, the display will show "0" after the cooking is completed and the door is opened. To reset present time in the display window when the oven is off, touch the CLOCK pad. The colon starts blinking. Enter the correct present time by following the above procedures.

AUTO WEIGHT DEFROSTING

AUTO WEIGHT DEFROST lets you easily defrost foods by eliminating guesswork in determining defrosting time. The minimum weight for Auto Weight Defrost is 0.1lb. The maximum weight depends on the food category. Up to 6.0 lbs for poultry, 4.0 lbs for meat and 3.0 lbs. for fish. Follow the steps below for easy defrosting.

1
POULTRY

EXAMPLE: To select POULTRY, touch button; the display will show "dEF 1", and the AUTO DEFROST indicator will light.

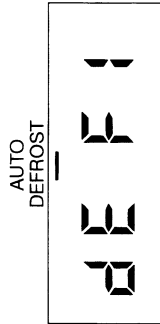

- Enter the desired auto weight category.

Category	Display	Food	Range
1	dEF 1	Poultry	0.1 lb to 6.0 lb.
2	dEF 2	Meat,Ground	0.1 lb to 4.0 lb.
3	dEF 3	Fish	0.1 lb to 3.0 lb.

EXAMPLE: To select 0.8 lbs, touch "8".

- Enter the food weight.

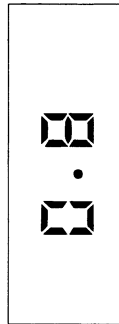

START

- Touch the START pad.

When the **START** pad is touched, the **AUTO DEFROST** indicator will blink, the display will count down the remaining defrosting time in minutes and seconds and will beep 5 times when defrosting is completed.

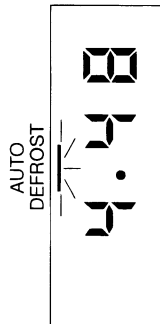

COOKING IN ONE STAGE

Use the 10 key pads (number pads) to select a cooking or other operational time.

COOK

1. Touch the **COOK** pad.

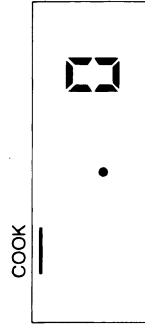

The display will show "0" and a tone will sound; the COOK indicator will light.

EXAMPLE: To set the cooking time to "13:40", touch "1", "3", "4" and "0" in sequence.

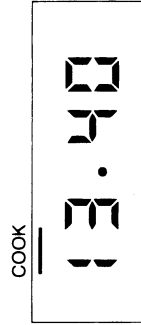

2. Touch the Number pads for the desired cooking time.

POWER LEVEL

3. Touch the **POWER LEVEL** pad and then the Number pad for the power.

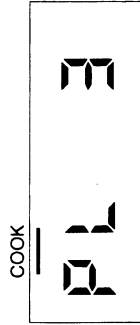

EXAMPLE: To select 30% power, touch the **POWER LEVEL** pad and then "3". The display will show "PL 3".

NOTE: If this step is omitted, the oven will cook at full (100%) power.

When the **START** pad is touched, the COOK indicator will blink, the display will count down the remaining cooking time in minutes and seconds and will beep 5 times when cooking is completed.

START

4. Touch the **START** pad.

WATTAGE OUTPUT CHART

Press	Power Level	Wattage Output
none	10	1100W
9	9	990W
8	8	880W
7	7	770W
6	6	660W
5	5	550W
4	4	440W
3	3	330W
2	2	220W
1	1	110W

COOKING IN TWO AND THREE STAGES

For best results, some recipes call for one power level for a certain length of time and another power level for a different length of time. Your microwave oven can be set to change from one power level to another, or you may Auto Weight Defrost in the first stage and then cook in the second and/or third stages.

COOK

1. Touch the **COOK** pad.

The display will show "0" and a tone will sound; the COOK indicator will light.

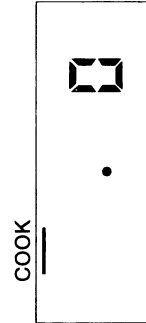

EXAMPLE: To set the Stage 1 cooking time to "11:40", touch "1", "1", "4" and "0" in sequence. The display will show the numbers pressed in the order you pressed them.

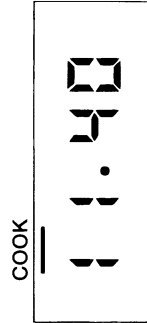

2. Touch the Number pads for the desired cooking time for Stage 1.

POWER LEVEL

3. Touch the **POWER LEVEL** pad and then the Number pad for the power.

EXAMPLE: To select 30% power, touch the **POWER LEVEL** pad and then "3". The display will show "PL 3".

NOTE: If this step is omitted, the oven will cook at full (100%) power.



The display will show "0" and a tone will sound.

COOK

4. Touch the **COOK** pad.

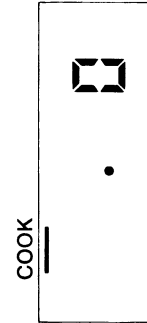

EXAMPLE: To set the Stage 2 cooking time to "11:20", touch "1", "1", "2" and "0" in sequence. The display will show the numbers pressed in the order you pressed them.

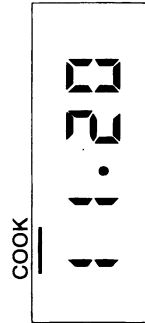

5. Touch the Number pads for the desired cooking time for Stage 2.

POWER
LEVEL

6. Touch the **POWER LEVEL** pad and then the Number pad for the power.

COOK

PL 8

EXAMPLE: To select 80% power, touch the **POWER LEVEL** pad and then "8". The display will show "PL 8".

NOTE: If this step is omitted, the oven will cook at full (100%) power.

START

7. Touch the **START** pad. The oven will begin cooking in Stage 1, then switch to Stage 2.

COOK

11:40

When the **START** pad is touched, the **COOK** indicator will start blinking to show the oven is cooking Stage 1. The display will count down the remaining cooking time in Stage 1, then the oven will beep and start Stage 2.

During stage cooking, check the present cooking stage by touching the **COOK** pad. For example, the display shows "STG 1" at stage 1, "STG 2" at stage 2 and "STG 3" at stage 3. After 2 seconds, the display returns to counting down the cooking time.

AUTO WEIGHT DEFROSTING AND COOKING IN TWO STAGES (COOKING IN THREE STAGES)

Some recipes require frozen foods to be thawed before cooking. This oven can be programmed to automatically defrost foods before cooking.

1. Program the oven to perform the desired Auto Weight Defrost function as described on page 9. This is considered first stage when using the Auto Weight Defrost feature in conjunction with Stage 1 and Stage 2 cooking.
2. Press the **COOK** pad and program the oven to cook in the remaining two stages as described starting on page 11.

NOTE: To Auto Weight Defrost and Cook in one stage only, skip the programming of the first stage.

POPCORN

Place the popcorn package (3.5 oz) onto a microwaveable dish in the oven and close the door.

POPCORN

1. Touch the **POPCORN** pad.

PO P

When the **POPCORN** pad is touched, the display will show "PO P".

START

2. Touch the **START** pad.

1:45

When the **START** pad is touched, the display will count down the cooking time of 1:45 and will beep 5 times when cooking is completed.

NOTE: 1. Use only 1 package (approx. 3.5 oz) at a time.

2. Use only a microwaveable popcorn package in the microwave oven.
3. Do not try to pop unpopped kernels.
4. Do not leave the oven unattended while popping popcorn. If the popcorn does not pop sufficiently, do not press the **POPCORN** pad again as the popcorn may burn. Check the popcorn bag for cooking instructions.
5. When opening the package, face it away from you to avoid contact with any steam released.

BEVERAGES

Use the **Beverage** feature to heat up to 3 mugs (9 oz per mug) of beverage. Place each mug in the oven and close the door.

BEVERAGE

1. Touch the **BEVERAGE** pad repeatedly until the desired number of mugs appear in the display window.

CU P2

EXAMPLE: To select 2 mugs, touch the **BEVERAGE** pad 2 times; "CU P2" will appear in the display.

START

2. Touch the **START** pad; the beverage will be heated.

3:15

When the **START** pad is touched, the oven will start heating. The display will count down remaining heating time and will beep 5 times when cooking is completed.

NOTE: Up to 3 mugs of beverage can be heated. Heating time is as follows:

- 1 MUG CU P1 (1 Min., 45 Sec.)
- 2 MUGS CU P2 (3 Min., 15 Sec.)
- 3 MUGS CU P3 (4 Min., 55 Sec.)

POTATOES

Place 1-3 medium size potatoes in the oven and close the door.

POTATO

When the **POTATO** pad is touched, the display will show "PO 1".

PO 1

1. Touch the **POTATO** pad once for each potato.

START

When the **START** pad is touched, the display will count down the remaining cooking time in minutes and seconds and will beep 5 times when cooking is completed.

3:20

2. Touch the **START** pad.

1 Potato	2 Potatoes	3 Potatoes
"PO 1"	"PO 2"	"PO 3"
3:20	5:40	7:15

PIZZA

Use the **Pizza** feature to reheat refrigerated pizza(1-3 slices).

PIZZA

When the **PIZZA** pad is touched, the display will show "P 1".

P 1

1. Touch the **PIZZA** pad once for each slice.

START

When the **START** pad is touched, the display will count down the remaining cooking time in minutes and seconds and will beep 5 times when cooking is completed.

1:00

2. Touch the **START** pad.

1 Slice	2 Slices	3 Slices
"P 1"	"P 2"	"P 3"
0:30	1:00	2:00

DINNER PLATE

Use the **Dinner Plate** feature to reheat precooked foods from the refrigerator.

DINNER PLATE

EXAMPLE: For regular amount of food, touch the **DINNER PLATE** pad once "rE G" will be displayed.

rE G

1. Touch the **DINNER PLATE** pad once for regular amount, twice for smaller amount and three times for a larger amount of food.

REGULAR: A regular amount of food: Approx. 9 oz (for example, 4oz sliced meat or poultry, 3 oz potato or rice and 2oz vegetables or equivalent.)

SMALL: A smaller amount of food: Approx. 6 oz.

BIG: A larger amount of food: Approx. 12 oz.

START

The oven will start cooking and the display will count down the cooking time. When cooking is completed, the oven will beep 5 times.

3:00

2. Touch the **START** pad.

Regular	Small	Larger
"rE G"	"SAL"	"bI G"
3:00	1:50	3:30

HOLD WARM

The Hold Warm feature can be used to keep food warm after microwave or conventional cooking is completed.

1. Program the desired cooking time and power level as previously instructed.

COOK

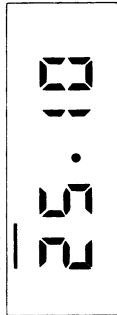

EXAMPLE: Select a cooking time of "25:10".

HOLD WARM

2. Touch the **HOLD WARM** pad for every 10 minutes of Hold Warm time desired (up to 30 minutes).

COOK

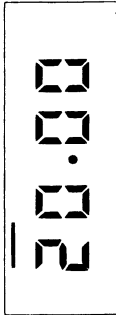

EXAMPLE: To select 20 minutes, touch the **HOLD WARM** pad 2 times.

START

3. Touch the **START** pad; the oven will begin cooking as programmed in step 1.

COOK

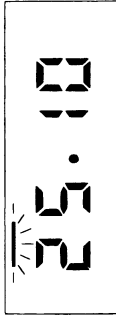

EXAMPLE: The COOK indicator will start blinking to indicate the oven is cooking. The display will count down the remaining time.

When the cooking is completed, the oven will begin the Hold Warm mode as programmed in step 2.

When cooking is completed, the COOK indicator will go off. The display will count down the remaining Hold Warm time. When the Hold Warm time ends, you will hear 5 beeps.

NOTES:

- * The Hold Warm feature operates independently or together with Stage 1 cooking.
- * To keep food warm after conventional cooking, omit step 1.

CHILD LOCK

The Child Lock prevents unwanted oven operation by small children. The oven can be set so that the control panel is deactivated or locked.

TO SET CHILD LOCK

1. Touch the "0" pad once.



2. Touch the **START** pad 5 times.

The display will show "LOC".

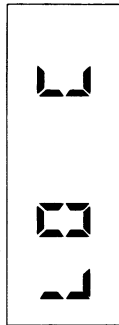

TO CANCEL THE CHILD LOCK

1. Touch the "0" pad once.



2. Touch the **START** pad 5 times.

The display will return to the present time.

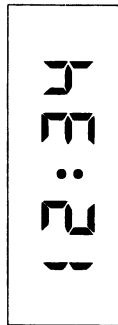

NOTE: A beep sound will be heard when setting or cancelling the Child Lock.

TO STOP THE OVEN WHILE IT IS OPERATING

1. Press the **CLEAR/PAUSE** pad.
 - The **PAUSE** indicator will start blinking.
 - The oven can be restarted by pressing the **START** pad.
 - Touch the **CLEAR/PAUSE** pad one more time to erase all instructions.
 - You must enter new instructions.
2. Open the door.
 - You can restart the oven by closing the door and touching the **START** pad.

COOKING GUIDE THE PRINCIPLES OF MICROWAVE COOKING

Microwaves are a form of high frequency radio waves similar to those used by a radio including AM, FM and CB. Electricity is converted into microwave energy by the magnetron tube. From the magnetron tube, microwave energy is transmitted to the oven where it is reflected, transmitted, and absorbed by the food.

Reflection

Microwaves are reflected by metal just as a ball is bounced off a wall. For this reason, metal utensils are not suitable for use in the microwave. A combination of stationary walls and a rotating metal turntable or stirrer fan helps assure that the microwaves are well distributed within the oven cavity to produce even cooking.

Transmission

Microwaves pass through some materials such as paper, glass and plastic much like sunlight shining through a window.

Because these substances do not absorb or reflect the microwave energy, they are ideal materials for microwave oven cooking containers.

Absorption

During cooking, microwaves will be absorbed by food. They penetrate to a depth of about 3/4 to 1 1/2 inches. Microwave energy activates the molecules in the food (especially water, fat and sugar), and heat is produced. If you vigorously rub your hands together, you will feel heat produced by friction. The internal cooking of larger foods is done by conduction as the heat which is produced by friction is conducted to the middle of the food. Foods also continue to cook by conduction during standing time.

FOOD CHARACTERISTICS

Quantity: The amount of food placed in a microwave oven has a direct effect on the cooking time. Small amounts of food or liquid require less cooking time than larger amounts of the same substance. As quantity increases, concentration decreases.

Size: Small pieces cook faster than large ones. To speed cooking, cut pieces smaller than 2-inches, so microwaves can penetrate to the middle from all sides. Pieces which are similar in size and shape cook more evenly.

Shape: Many foods are uneven, like a chicken, ribs or broccoli. The thin parts will cook faster than the thick parts, while uniformly thick foods cook evenly. To compensate for irregular shapes, place thin pieces toward the center of the dish and thicker pieces toward the edge of the dish.

Starting Temperature: Frozen or refrigerated foods take longer to cook than foods at room temperature.

Bone and Fat: Because bones conduct heat, the side of meat the bone is on will cook first, while boneless cuts cook slower but more evenly. Fat attracts microwaves. The middle of these are cooked by heat conduction.

Moisture Content: Microwaves are attracted by moisture. Naturally moist foods absorb microwaves better than dry ones. Add a minimum of liquid to moist foods, as excess water slows cooking.

Density: The density of food determines how easily the microwaves can penetrate and how quickly it will cook. Porous foods, like chopped beef or potatoes, microwave faster than dense ones like steak or whole potatoes.

Piercing: Steam builds up pressure in foods which are tightly covered by a skin or membrane. Pierce potatoes, egg yolks and chicken livers to prevent bursting.

MICROWAVE TECHNIQUES

Stirring: Stir foods from outside to center of dish once or twice during cooking to equalize heat and speed microwaving. Foods will not burn or stick, so there's no need to stir constantly as you do in convention cooking.

Arrangement: Arrange foods with thin or delicate ends, like drumsticks or asparagus with the thick or tougher portions to the outside of the dish. The parts which need more cooking will receive more energy, so food will microwave evenly.

Spacing: Individual foods, such as baked potatoes and cupcakes will cook more evenly if placed in the oven an equal distance apart. When possible, arrange foods in a circular pattern. Similarly, when placing foods in a baking dish, arrange around the outside of dish, not lined up next to each other. Food should not be stacked on top of each other.

Rearrangement: Rearrange overlapping areas, like tails of long fish filets, from top to bottom, and closely packaged pieces, like meatballs, from the outside to the center of the dish.

Standing Time: Standing time is especially important in microwave cooking. Microwave energy creates heat in the outer layers of the food. As a result of normal conduction, the food continues to cook for a few minutes after removal from the oven. Letting roasts, large whole vegetables, casseroles and cakes stand to finish cooking allows the middles to cook completely without overcooking, drying or toughening the outsides.

Covering: Covering speeds cooking time, retains moisture, tenderizes, insures even cooking and prevents spattering. Casserole lids or plastic wrap are used for a tighter seal. Vent plastic by turning back one edge at the side of dish to form a narrow slot where excess steam can escape. Various degrees of moisture retention are also obtained by using wax paper or paper towels.

Browning: Microwave energy cooks some foods so quickly that the fats and sugars within the food do not have time to caramelize and give a "browned" appearance. Browning agents do not affect the quality of microwaved foods, but can add color and flavor. For meats and poultry, use bouquet sauce diluted with water or melted butter; soy, Worcestershire, barbecue or steak sauce; a sprinkling of paprika or dry gravy mix; jelly glaze or crumb coating. Frosting and topping finish cakes and breads. Top casseroles at the end of microwaving with grated cheese or crumbs.

Some Foods do not Microwave Well

Eggs in Shells and shelled boiled eggs can burst.

Pancakes do not crush, but they reheat well. Fully-prepared, frozen pancakes are available for microwaving.

Deep Fat Frying can cause burns.

Bottles with narrow necks may shatter if heated.

Popcorn only in special microwave poppers. Do not use oil unless specified by the manufacturer, or heat longer than recommended. Never pop popcorn in paper bags or glass utensils.

AUTO WEIGHT DEFROSTING

Defrosting frozen food is one of the benefits of a microwave oven. Microwave defrosting is much faster than refrigerator defrosting and safer than room temperature defrosting, since it does not promote the growth of harmful bacteria. Furthermore, your oven does program defrosting for foods listed below. See page 9 for more information.

AUTO WEIGHT DEFROSTING CHART

You can Auto Weight Defrost foods up to the weight limits shown below.

CATEGORY	DISPLAY	FOOD	RANGE
1	dEF 1	Poultry	0.1 to 6.0 lbs
2	dEF 2	Meat, Ground	0.1 to 4.0 lbs
3	dEF 3	Fish	0.1 to 3.0 lbs

Preparing food for freezing

For best results, select good quality food and freeze immediately. Food should be wrapped as airtight as possible before freezing. Wrapping materials best suited for use in the freezer are odorless, and moisture and vapor proof. Heavy duty plastic wraps and bags, and freezer wrap are suitable. When wrapping for freezing, arrange meat, poultry, fish and seafood in thin, uniform layers. Package minced meat in 1 to 2 inch thick rectangular square or round shapes. Chicken pieces, chops, stew meat and fish filets will defrost more easily if frozen in 1 or 2 piece layers rather than in bulky thick packages. To aid in separating chops, hamburger patties and fish filets during defrosting, place two pieces of wax paper between the layers. Remove giblets from fresh poultry. (The giblets may be frozen separately, if desired.) Clean and dry poultry. Tie legs and wings with string; this helps poultry keep its shape during freezing. Remove excess air from package. Label contents, date and weight.

Conversion Chart

Ounces	Hundredths of a Pound	Tenths of a pound	Grams
1 - 2	.06 - .15	0.1	50
3 - 4	.16 - .25	0.2	100
5 - 6	.26 - .35	0.3	150
7	.36 - .45	0.4	200
8 - 9	.46 - .55	0.5	250
10 - 11	.56 - .65	0.6	300
12 - 13	.66 - .75	0.7	350
14	.76 - .85	0.8	400
15 - 16	.86 - .95	0.9	450

- If a roast weighs 3.95 pounds or 3 pounds, 15 ounces, program 3.9 pounds (1950 grams).
 - If a roast weighs 3.99 pounds or 4 pounds, 0 ounces, program 4 pounds (2000 grams).
- To obtain the best results, follow special techniques for defrosting. Remember when defrosting to allow for a standing time to evenly thaw food. Unwrap food, place in dish, or arrange properly on dish so microwaves can reach all sides. Halfway through defrosting time, stir, turn over or redistribute food. Breaking up the pieces of chicken, fish and meat that are partially thawed will help. Any pieces which are thawed should be removed.

POPPING POPCORN

One of the major features of your microwave oven is popping popcorn. Place the microwave popcorn package (3.5 oz) onto a microwaveable dish, then on the glass tray, following the manufacturer's instructions. Touch the POPCORN pad and the oven will operate for 2 minutes at full power (PL 10), the average popping time. Do not leave the oven unattended while popping popcorn. If popcorn does not pop sufficiently, cook a few seconds longer. Do not press the POPCORN pad again as the popcorn may burn. When opening the package, face it away from you to avoid contact with any steam released.

NOTE: Do not use the POPCORN pad with single serving bags of microwave popcorn as they require less cooking time. Always follow instructions on the popcorn bag.

REHEATING

One of the major bonuses of the microwave cooking method is its efficiency in reheating cooked food. Most food can be reheated in the microwave oven without loss of quality or texture. Leftovers taste as good as when freshly prepared, and it is no longer necessary to keep foods hot until everyone is ready to eat.

Main dishes reheat especially well, some even improve in flavor if they are made in advance. Care must be taken to avoid additional cooking: rare meat should never be heated beyond its original doneness temperature, or it will cook to medium or well done.

To retain moisture during reheating, cover food with a lid. Exceptions are rare or medium meats some sandwiches, griddle foods like pancakes, and baked foods. Wrap breads and sandwiches in paper napkins to absorb moisture and prevent sogginess.

Follow the directions for recommended foods and weights. There are 3 categories for reheating. Use only microwaveable containers.

Reheating Chart (touch the SNACK & REHEAT pad and select the reheat setting)

Food	Amount	Starting Temperature	Suggested Serving Temp	Special Techniques
Meat Slices turkey, beef, ham, pork.	1 to 2 servings (12 oz)	Refrigerated.	150 to 160°F	Cover with wax paper. Do not cover rare or medium meats.
Casseroles	2 to 3 servings (16oz)	Refrigerated.	140 to 170°F	Cover, stir after half the time.
Soups	1 serving (10 oz)	Refrigerated.	140 to 170°F	Cover, stir after half the time.
Breads: cake (coffee cake, doughnuts, sweet rolls), dinner rolls, muffins.	3 pieces (6 oz)	Refrigerated.		Wrap in paper napkin or towel.
Plated Meals: meat plus 2 vegetables.	1 plate (12 oz)	Refrigerated.	150 to 160°F	Cover plate with wax paper or plastic wrap.

REGULAR: A regular amount of food: Approx. 9 oz (for example, 4 oz sliced meat or poultry, 3 oz potato or rice and 2 oz vegetables or equivalent.)

SMALL: A smaller amount of food: Approx. 6 oz.

BIG: A larger amount of food: Approx. 12 oz.

Regular	Small	Larger
"rEG"	"SA L"	"bI G"
3:00	1:50	3:30

BEVERAGE REHEATING

You can reheat leftover beverages easily and quickly in your oven. Reheating can be from one cup to three cups. Place cups (mugs) in the oven and press the BEVERAGE pad once for each mug. When pressing, consult the list below. (Do not use - mugs with metal trim.)

- 1 MUG CUP 1 1 mug (1 min., 45 sec.)
- 2 MUGS CUP 2 2 mugs (3 min., 15 sec)
- 3 MUGS CUP 3 3 mugs (4 min., 55 sec)

Arrange cups in a ring with space between them when reheating more than two cups. Leave the center empty. After reheating, remove cups carefully; they may be quite hot.

HOLD WARM

When not serving food immediately after cooking, it can be kept warm by using the Hold Warm function. It keeps food warm by heating at the lowest power constantly. The Hold Warm mode operates with Stage1 cooking or independently.

Set the cooking times and power level, then press the HOLD WARM pad. Thereafter, foods can be kept warm properly until serving. To keep foods warm after conventional cooking, cook food in conventional oven, then press the HOLD WARM pad. See page 16 for detailed instructions.

HOT SNACKS AND APPETIZERS

Hot hors d'oeuvres and appetizers can be prepared very quickly in the oven by the hostess, or individual servings may be prepared by guests.

Many appetizers may be cooked on the serving platter, provided the platter does not have metal trim. A time saver tip - prepare these foods ahead of time, refrigerate or freeze and refresh in the oven at serving time. A plate of appetizers will take only seconds to prepare or refresh. Cheese melts very rapidly and will toughen if overcooked, so watch foods combined with cheese closely so that overcooking will not occur. As soon as cheese starts to bubble, cooking is completed. Appetizers that have a crisp pastry exterior are best prepared in a conventional oven. To prepare appetizers wrapped in bacon, it will be necessary to precook the bacon and then wrap around the foods. Oysters wrapped in bacon are easier to prepare in the broiler of your conventional range. Seafood mixtures can be prepared in serving shells as microwave energy will pass through the seafood shells without heating. Aluminum foil should not be used for shells. If spreads are placed on crackers, care should be taken not to overcook as moisture from the food will cause crackers to become soggy. Crackers used for spreads should be very dry and crispy. This helps avoid sogginess. Heat only until spread is at serving temperature. The time required to heat all appetizers will depend on the amount of food, and the number and the type of dish selected. Remember the food will become very hot even if the dish is cool. Cheese mixtures retain heat longer when heated with microwave energy.

MEATS

Guide for Auto Weight Defrosting Meats

You may defrost meat within its original plastic wrappings. Remove all metal rings, wire twist-ties and foil wrapping. Place meat in a microwaveable dish. Defrost in microwave oven only as long as necessary, since standing time will complete the thawing process.

Item	Standing Time (minutes per lb)	Special Techniques
BEEF		
Minced	5 - 7 min.	Break apart and remove thawed portions with a fork.
Stew Meat	5 - 7 min.	Separate and remove thawed portions.
Loin Roast	5 - 7 min.	Turn over after half the time.
Patties	5 - 7 min.	Turn over after half the time.
PORK		
Loin Roast	5 - 7 min.	Turn over after half the time.
Spare Ribs	5 - 7 min.	Separate and rearrange once.
Chops	5 - 7 min.	Separate and turn over once.
Minced	5 - 7 min.	Break apart and remove thawed portions with a fork.

Guide for Cooking Meats

Roasts, chops, hamburgers and small cuts of tender meat cook beautifully in the microwave oven. Most roasts can be cooked rare, medium rare or even well done in less than one hour. Less tender cuts of meat such as pot roast can be simmered fork tender in a sauce or gravy. Touch cuts that require slow cooking will do better in the conventional range or oven. A large piece of meat, especially if the shape is uneven, should be turned over occasionally for uniform roasting.

Meat	Power Level	Cooking Time (per lb)	Standing Time	Special Notes
Beef Roast				
Rare	6	6 - 8 min.	5 - 7 min.	
Medium	6	8 - 10 min.	10 - 15 min.	Turn over after half the time.
Well	6	10 - 12 min.	10 - 15 min.	
Pork Roast				
Bone-in	6	12 - 15 min.	10 min.	Cover with plastic wrap.
Boneless	6	16 - 18 min.	10 - 15 min.	Turn over after half the time.
Lamb Roast				
Bone-in	6	7 - 9 min.	10 - 12 min.	
Well	6	9 1/2 - 11 1/2 min.	10 - 15 min.	Turn over after half the time.
Boneless	6	9 - 11 min.	10 - 12 min.	
Well	6	11 - 13 1/2 min.	10 - 15 min.	
Beef Patties (3 1/2 oz) each				
2 patties	8	2 1/2 - 3 min.	5 - 7 min.	Turn over and rearrange
3 patties	8	3 1/2 - 4 1/2 min.	5 - 7 min.	after half the time.
Meat Loaf (2lbs)				
	8	15 - 17 min.	10 - 12 min.	Cover with wax paper.
Bacon				
Slices(4 strips)	10	3 1/2 - 4 1/2 min.	-	Cover with a paper towel.
(1 slice; weight: 1 oz, length: 11in.)				
Ham				
Slices (1 in. thick)	10	6 1/2 - 8 min.	5 - 7 min.	Cover with plastic wrap.
4 slices				

POULTRY

Guide for Auto Weight Defrosting Poultry

Poultry dishes can be defrosted in your microwave oven. Remove giblets and defrost fully before cooking. Use a microwaveable dish and defrost only as long as necessary. Standing time will complete the thawing process.

Item	Standing Time (minutes per lb)	Special Techniques
Whole Chicken	10 – 15 min.	Breast side down. Turn over after half the time.
Pieces	7 – 10 min.	Separate and rearrange once.
Breasts	5 – 7 min.	Separate and rearrange once.
Cornish Hens	5 – 7 min.	Breast side down. Turn over after half the time.
Turkey Breasts	5 – 7 min.	Turn over after half the time.

Guide for Cooking Poultry

Chicken is one of the most popular foods and microwaving chicken is one of the best uses of your microwave oven. Chicken stays juicy and tender in the microwave oven. However, juiciness prevents browning because chicken crisps and browns only when the skin dries out enough to change color. Standing time is important, because it allows the interior to finish cooking without toughening the delicate breast meat.

Food	Power Level	Cooking Time (per lb)	Standing Time	Special Notes
Roast				
Chicken whole	8	6 – 8 min.	10 – 15 min.	Place breast side up on roasting rack. Let stand, covered, before serving.
Cornish Hens	8	6 – 7 min.	7 – 10 min.	
Turkey	8	6 – 7 min.	10 – 15 min.	
Chicken cut up	8	7 – 8 min.	7 – 10 min.	
Turkey Breast	6	8 – 9 1/2 min.	5 – 7 min.	

Rearrange once during cooking. Cover with wax paper.

SEAFOOD

Guide for Auto Weight Defrosting Seafood

Item	Standing Time (minutes per lb)	Special Techniques
Whole Fish	5 – 7 min.	Turn over after half the time.
Fish Fillets	5 – 7 min.	Separate and turn over once.
Shrimp	5 – 7 min.	Separate and turn over once.

Guide for Cooking Seafood

Microwaving is one of the easiest and most efficient ways of preparing fish and seafood, which stay delicate and tender with quick, moist cooking. Overcooking dries out and toughens seafood, so you should check it after the minimum time. If thick pieces like fish steaks or lobster tails are done on the outside, but still slightly translucent in the middle, let them stand for a few minutes; internal heat will complete the cooking.

Food	Power Level	Cooking Time	Standing Time	Special Notes
Whole Fish (1 lb to 1 1/2 lbs)	8	6 – 7 min.	5 min.	Turn over after half the time.
Fish Fillet (1 lb)	8	5 – 6 min.	4 – 5 min.	Turn over after half the time.
Fish Steak 1 inch thick (1 lb)	8	4 – 5 min.	5 – 6 min.	Turn over after half the time. Cover with wax paper.
Shrimp (1 lb)	8	3 – 4 min.	5 min.	Rearrange once during cooking. Cover with plastic wrap.
Sea Scallops (1 lb)	8	5 1/2 – 6 1/2 min.	5 min.	Rearrange once during cooking. Cover with plastic wrap.

EGGS & CHEESE

Guide for Cooking Eggs & Cheese

- CHEESE**
Cheese melts quickly and smoothly. When serving cheese as an appetizer, flavor is at peak when served at room temperature. Use a low power level for melting. Cheese melts best when shredded and heated with milk or other liquids. Stir cheese mixtures several times for even heating.

- EGGS**
Eggs cook differently by microwave. The high fat content of egg yolks absorb energy, so yolks cook faster than whites. It's easy to poach eggs in a microwave oven, but if you want soft yolks, remove eggs from the oven before whites are completely cooked. A brief standing time allows whites to set without overcooking yolks. Check eggs for completion of cooking early, they toughen when overcooked.

When eggs and yolks are mixed together for omelets, scrambled eggs, or custards, they cook evenly and need less stirring than the conventional cooking methods. Do not try to cook eggs in the shell. Steam can build up inside the shells, causing them to burst.

Scrambled Eggs

Eggs	Butter	Milk or Water	Cook on Power 10	Procedure
2	1 Tbsp	2 Tbsp	1 - 2 min.	Place butter in small casserole and melt. Add eggs and milk, scrambling with fork. Cook as directed in chart, breaking up and stirring eggs twice. Let stand, covered, before serving.
4	1 Tbsp	2 Tbsp	2 - 3 min.	
6	2 Tbsp	4 Tbsp	3 - 4 min.	

Poached Eggs

Eggs	Water	Cook Water on Power 10	Cook Eggs on Power 8	Standing Time	Procedure
1	1 1/2 cups	4 - 6 min.	1 min.	2 min.	Place Water into medium casserole.
2	1 1/2 cups	4 - 6 min.	1 - 2 min.	2 min.	Cook at High until boiling. Break eggs, one at a time, into separate dish, pierce yolk once with wooden pick and slip egg carefully into hot water, cook as directed in chart.
4	2 cups	6 - 7 min.	2 - 3 min.	2 min.	

VEGETABLES

Guide for Cooking Fresh Vegetables

Nutrition research indicates that many microwaved vegetables and fruits lose less water soluble vitamin C when cooked conventionally. This is due to shorter cooking time and to the fact that less cooking water is needed when microwaving fruits and vegetables. Best of all, vegetables keep their fresh color, texture and flavor. Vegetables should be microwaved covered with vented plastic wrap or a casserole lid. Vegetables cooked in their skins, such as potatoes, are already so tightly covered that they should be pricked with a fork before cooking in order to release excess steam. To assure even cooking, vegetables should be cut in uniform pieces and stirred during the cooking time. Always add salt to water before adding vegetables. Reduce time a minute or two for crisp-tender texture. Increase time for very soft texture. Remember to allow standing time of 2 to 5 minutes after cooking, because as most foods do, vegetables will continue to cook after they are removed from the microwave oven.

Food	Water Amount	Cook on Power 10	Standing Time	Special Notes
Asparagus				
Spears (1lb)	1/4 cup	4 1/2 - 5 1/2 min.	2 min.	Medium Casserole. Re-arrange once.
Cuts (1lb)	1/2 cup			
Beans				
Fresh green (1/2lb)	1/4 cup	3 1/2 - 4 1/2 min.	2 min.	Stir twice.
Frozen green (1/2lb)	2 Tbsp	5 - 6 min.	2 min.	Stir twice.
Green Peas (2 cups)	1/4 cups	3 1/2 - 4 1/2 min.	2 min.	Small casserole. Stir twice
Broccoli (2 cups)	1/4 cups	3 1/2 - 4 1/2 min.	2 min.	Medium casserole. Re-arrange once during cooking.
Brussels Sprouts (1lb)	1/4 cups	5 1/2 - 7 min.	2 - 3 min.	Medium casserole. Stir once.
Cabbage (1lb)	1/4 cups	4 1/2 - 5 1/2 min.	2 - 5 min.	Rearrange once during cooking.
Cauliflower pieces (1 head)	1/4 cups	5 1/2 - 6 1/2 min.	2 - 5 min.	Wrap in plastic wrap. Stir once.
Mushroom slices (1/2lb)	2 Tbsp	3 - 4 min.	2 - 3 min.	Small casserole. Stir once.

SOUPS

Guide for Cooking Soups

Satisfy appetites with savory soups prepared in your microwave oven. Follow our recipes for homemade soups and stews or adapt your favorites by using similar cooking times and techniques.

Food	Power Level	Cooking Time	Standing Time	Special Notes
Canned Condensed				
Cream style, Bean, Pea or Mushroom (10 1/2-11 1/2 oz) with Water with Milk	10 8	4 - 5 min. 5 - 6 min.	2 - 3 min. 2 - 3 min.	Stir halfway through cooking time. Cover.
Dry Soup Mix (1 envelope (10 1/2 oz))	10 then 6	5 - 7 min. 2 1/2 - 3 1/2 min.	2 - 3 min.	Add water. Cover with lid. Stir twice.
Broth (10 1/2 oz)	10	3 1/2 - 4 1/2 min.	2 - 3 min.	Stir twice. Cover

SAUCES

Guide for Cooking Sauces

Sauces boil over rapidly, especially those that contain milk. As soon as the door is opened, cooking stops. If ingredients are not taken directly from the refrigerator, cooking time will be less than given in the recipe. Stir sauce quickly, about every 30 seconds to eliminate lumps. Be sure to use a container twice the size of the amount of liquid to prevent boiling over. A wooden spoon may be left in the dish while sauce is cooking for easy stirring. If sauce is stirred slowly, cooking time may require about 15 seconds longer. If desired, a 1 quart glass measure may be used to prepare some sauces.

White Sauce

Amount	Butter	Flour	Milk	Cook Butter	Cook Sauce	Special Notes
1 cup, thin	1 Tbsp	1 Tbsp	1 cup	30 sec.	2 - 3 min.	Cook on Full power as directed or until thickened, stirring once. Let stand, covered, before serving.
med.	2 Tbsp	2 Tbsp	1 cup	40 sec.	2 1/2 - 3 1/2 min.	
thick	3 Tbsp	3 Tbsp	1 cup	1 min.	3 - 4 min.	

Brown Gravy

Amount	Fat from Drippings	Flour	Liquid or Drippings	Cook or Power	Special Notes
1 cup, thin	1 Tbsp	1 Tbsp	1 cup	2 - 3 min.	Cook on Full power as directed or until thickened, stirring once. Let stand, covered, before serving.
med.	1 Tbsp	2 Tbsp	1 cup	2 1/2 - 3 1/2 min.	
thick	1 Tbsp	3 Tbsp	1 cup	3 - 4 min.	

CASSEROLES

Casseroles may require occasional stirring to distribute heat. They cook more evenly when made with ingredients of similar size and shape. Because of their shorter cooking time, casseroles cooked in the microwave oven generally need less liquid. Casseroles with cream and cheese sauces, or meats which need slower cooking to tenderize, cook best on power level 4.

When cooking a favorite casserole, make two and freeze the second for future use. Line a casserole or baking dish with plastic wrap. Transfer the cooked food to the lined container and freeze. As soon as the food is frozen in the shape of the dish, remove it and wrap with freezer paper. Later it can be unwrapped and returned to the container for defrosting and heating.

Dry Casserole Mixtures

Many prepared box type casseroles are available on the grocery shelves. Many have freeze dried foods or evaporated foods included. Cooking periods are so short there may not be time for the foods to absorb the moisture sufficiently and reconstitute the foods. To prepare this type, boil the amount of water recommended on the package. Add the noodles (when included), cover and cook for approximately 10 minutes. Allow noodles to stand covered for an additional 10 minutes, rinse with warm water and drain. Then follow package directions for preparing the mix. Reheat 4 to 6 minutes before serving.

SANDWICHES, INCLUDING HAMBURGERS AND HOT DOGS

Guide for Heating Sandwiches

Sandwiches heat very quickly because, being porous, they have a low density. Since the filling is usually more dense than the bread or rolls, the filling determines the heating time. Surprisingly, the filling will always be hotter than the bread feels. Care must be taken not to overcook as the bread will become tough. Use several thin slices of meat. Thin slices heat more quickly and are better than one thick slice. The slow heating thick slices often causes the bread to overcook before the meat is hot. Sandwiches may be placed on a paper plate, napkin or paper towel to be warmed. The sandwich should be covered with a paper towel. Remove wrapping immediately after warming. Already-baked frozen breads and rolls may be used for sandwiches. The filling, however, should be thawed first. Toasted bread is fine for sandwiches and provides a firm base. The toast is warmed only; no further browning occurs.

Food	Amount	Cook on Power 10	Special Notes
Sandwich (6 oz)	1	1 min.	
	2	1 1/2 - 2 min.	Place on paper towels.
	4	3 - 4 min.	
Hamburger (4 oz)	1	1 min.	Cover with paper towel.
	4	3 - 4 min.	
Hot Dogs (2 oz)	4	1 1/2 - 2 min.	Cover with paper towel.
Sloppy Joes	4	3 - 4 min.	Place on microwaveable plate.

PASTA & GRAINS

Guide for Cooking Pasta and Grains

Raw long grain rice takes time to rehydrate. Microwaving time is a little shorter than conventional, but the greatest advantage is the ease with which you can prepare fluffy rice without sticking or burning. Cooked rice and pasta reheat easily in the microwave oven without loss of flavor or texture. No extra water is needed to prevent sticking or drying, so there's no danger of overcooking rice and pasta or thinning sauces.

Food	Hot Water	Salt	Oil or Butter	Power Level	Cooking Time	Standing Time
Pasta (8 oz)						
Egg Noodles	4 cups	1 tsp.	1 Tbsp.	10	6 - 7 min.	2 - 5 min.
Macaroni	4 cups	1 tsp.	1 Tbsp.	10	7 - 9 min.	2 - 5 min.
Spaghetti	4 cups	1 tsp.	1 Tbsp.	10	7 - 9 min.	2 - 5 min.
Lasagna Noodles	4 cups	1 tsp.	1 Tbsp.	10	11 - 13 min.	2 - 5 min.
Rice, Long Grain						
White Rice (1 cup)	2 cups	1 tsp.	1 tsp.	10 then 8	4 1/2 - 5 1/2 min.	5 - 7 min.
Brown Rice (1 cup)	2 cups	1/2 tsp.	1 tsp.	10 then 8	4 1/2 - 5 1/2 min. 20 - 24 min.	5 - 7 min.

CEREALS

Microwaved hot cereals can be cooked directly in the cereal bowl and make washing-up easy.

CONVENIENCE FOODS

Frozen Foods

A large variety of frozen foods, special dishes and dinners are available and the selections continue to increase. The market is changing rapidly, therefore it is impossible to list the foods and types available and recommend cooking procedures. In this book we can only give general directions to assist you.

T.V.Dinners

To prepare a T.V. dinner, follow the maker's instructions for use with microwave ovens. To cook a T.V. dinner will require approximately 5 to 7 minutes for the food to thaw and heat to serving temperature (depending on the types of food). Allow plastic wrap to remain over the dish for 2 minutes to allow heat to equalize. Dinners that contain mashed potatoes have presented a bit of a problem due to the large compact mass of this particular food. You may want to remove about half the mashed potatoes after defrosting is started, then spread the remaining potatoes over the individual section of the tray. Heat the removed mashed potatoes in an individual dish. For foods that should be crisp when cooking is completed, remove the plastic wrap and use the broiler of a conventional range to crisp the food.

Individual Frozen Foods

These may be commercially prepared or frozen at home. Place the container of frozen food in the oven and heat only until the food starts to defrost and can be removed easily. Empty contents into a casserole or serving dish and continue to defrost and heat. Do not heat foods in deep foil containers. To crisp and brown special toppings, use the broiler of a conventional range. If allowed to heat to serving temperature in a plastic container, the container will warp or melt from the high heat of food.

Frozen Foods in Cooking Pouches or Boilable Bags

To prepare these foods, slit the plastic bag. An X-type cut will help remove the food at the end of cooking time. Place the cut side down on a serving dish (with no metal trim). Heat foods other than vegetables for about 3 minutes. Frozen vegetables require about 8 - 9 1/2 minutes of cooking time. Allow the pouch bag to remain over the food for about 2 minutes to allow time for the heat to equalize. Foods prepared in cheese or white sauce should be removed from the pouch and placed in a glass casserole dish and stirred to prevent overcooking of the sauce around the edges of the dish.

Complete Meals from Table Leftovers

Complete meals from leftovers can be prepared in advance. Foods can be frozen and ready for quick heating in the oven at any time. Choose foods suitable for freezing and put serving portions on paper, glass or china (no metal trim) plate. Wrap with recommended freezer paper and freeze quickly. When apportioning the servings of food on the plate, use approximately the same amount of each kind of food for more even heating. Mashed potatoes will heat quicker if spread slightly and hollowed, with a pat of butter in the center. To prevent small pieces of vegetables, corn, peas, etc., from dehydrating during heating, mound well near the center of the plate.

BEVERAGES

Beverages can be quickly heated or reheated in the microwave oven. Individual servings can be heated directly in cups or mugs, so you avoid washing sticky pans. Handles of cups and mugs stay cool, even though the beverage gets hot. Beverages can be quickly reheated. Save leftover coffee in a glass measuring cup or serving cup and refrigerate. Later, reheat it in the microwave oven. The coffee will taste as if it had just been freshly brewed. Remember, however, to always vigorously stir a beverage before it is reheated. Chocolate squares may be melted in their original paper wrapper, in a glass mixing bowl, in custard cups or glass measuring cups. If milk is to be added to melted chocolate squares, add water to the melted chocolate for easier blending.

DESSERTS

There's always time to make dessert with a microwave oven. Fruit desserts have a remarkably fresh flavor and texture. Microwaved cakes are higher and more tender than conventionally baked; since cakes are usually frosted, browning is unimportant. Microwaved pie crusts are exceptionally tender and flaky, while delicate custards and puddings are easy to prepare.

Guide for Cooking Cakes

Food	Power Level	Cooking Time	Standing Time	Special Notes
Cake, round (Mixed 9 inch)	10	3 - 4 1/2 min.	2 - 5 min.	Pour into greased and wax paper lined cake dishes.
Ring or Angel Food Cake	8	5 - 6 min.	2 - 5 min.	Cover with wax paper.
Muffin (6 muffins)	6	5 - 6 min.	2 - 5 min.	Rearrange once.
Custard (6 servings)	6	9 - 11 min.	5 - 7 min.	Rearrange once.

Baking

- Bar cookies work best. Greasing or lining of the microwaveable baking dish is optional.
- If insufficient browning disturbs you, frost, glaze or add food coloring to white or yellow batters. A serviceable microwaveable cookie sheet can be made by covering cardboard with waxed paper.
- Round glass baking dishes, and fluted or smooth microwaveable ring molds work best for cakes. You can make a microwaveable ring mold of your own by placing a medium-size glass in the center of a round glass baking dish.
- Because your cakes will rise higher in microwave cooking, never fill microwaveable cake pans more than half-full.
- Reduce baking powder and soda by approximately one-fourth when converting a conventional recipe.
- Fill paper-lined muffin cups to only half full which allows for muffins to rise more than normal.
- You can prepare your own "brown'n serve" breads and rolls by baking them ahead of time in the microwave oven. Then, place them in a conventional oven to brown prior to serving.
- Breads and rolls should be reheated to the point where they are warm to the touch. Overheating or overcooking makes bread tough and rubbery.
- When making yeast bread in a microwave oven, choose a recipe with cornmeal, whole wheat flour, or rye flour to achieve a richer color.

WEIGHT & MEASURE CONVERSION CHART

POUNDS & OUNCES TO GRAMS

POUNDS (lbs)	GRAMS (g)	OUNCES (oz)	GRAMS (g)	OUNCES (oz)	GRAMS (g)
1/4	114	1	28	9	255
1/2	227	2	57	10	284
3/4	341	3	85	11	312
1	454	4	113	12	340
2	907	5	142	13	369
3	1361	6	170	14	397
4	1814	7	198	15	425
5	2268	8	227	16	454
6	2722				
7	3175				
8	3629				
9	4082				
10	4536				
11	4990				

FLUID MEASUREMENTS

1 Cup =	8 fluid ounces =	240 ml
1 Pint =	16 fluid ounces =	480 ml
1 Quart =	32 fluid ounces =	960 ml
1 Gallon =	128 fluid ounces =	3840 ml

CONVENIENCE FOODS

Frozen Foods

A large variety of frozen foods, special dishes and dinners are available and the selections continue to increase. The market is changing rapidly, therefore it is impossible to list the foods and types available and recommend cooking procedures. In this book we can only give general directions to assist you.

T.V.Dinners

To prepare a T.V. dinner, follow the maker's instructions for use with microwave ovens. To cook a T.V. dinner will require approximately 5 to 7 minutes for the food to thaw and heat to serving temperature (depending on the types of food). Allow plastic wrap to remain over the dish for 2 minutes to allow heat to equalize. Dinners that contain mashed potatoes have presented a bit of a problem due to the large compact mass of this particular food. You may want to remove about half the mashed potatoes after defrosting is started, then spread the remaining potatoes over the individual section of the tray. Heat the removed mashed potatoes in an individual dish. For foods that should be crisp when cooking is completed, remove the plastic wrap and use the broiler of a conventional range to crisp the food.

Individual Frozen Foods

These may be commercially prepared or frozen at home. Place the container of frozen food in the oven and heat only until the food starts to defrost and can be removed easily. Empty contents into a casserole or serving dish and continue to defrost and heat. Do not heat foods in deep foil containers. To crisp and brown special toppings, use the broiler of a conventional range. If allowed to heat to serving temperature in a plastic container, the container will warp or melt from the high heat of food.

Frozen Foods in Cooking Pouches or Boilable Bags

To prepare these foods, slit the plastic bag. An X-type cut will help remove the food at the end of cooking time. Place the cut side down on a serving dish (with no metal trim). Heat foods other than vegetables for about 3 minutes. Frozen vegetables require about 8 - 9 1/2 minutes of cooking time. Allow the pouch bag to remain over the food for about 2 minutes to allow time for the heat to equalize. Foods prepared in cheese or white sauce should be removed from the pouch and placed in a glass casserole dish and stirred to prevent overcooking of the sauce around the edges of the dish.

Complete Meals from Table Leftovers

Complete meals from leftovers can be prepared in advance. Foods can be frozen and ready for quick heating in the oven at any time. Choose foods suitable for freezing and put serving portions on paper, glass or china (no metal trim) plate. Wrap with recommended freezer paper and freeze quickly. When apportioning the servings of food on the plate, use approximately the same amount of each kind of food for more even heating. Mashed potatoes will heat quicker if spread slightly and hollowed, with a pat of butter in the center. To prevent small pieces of vegetables, corn, peas, etc., from dehydrating during heating, mound well near the center of the plate.

BEVERAGES

Beverages can be quickly heated or reheated in the microwave oven. Individual servings can be heated directly in cups or mugs, so you avoid washing sticky pans. Handles of cups and mugs stay cool, even though the beverage gets hot. Beverages can be quickly reheated. Save leftover coffee in a glass measuring cup or serving cup and refrigerate. Later, reheat it in the microwave oven. The coffee will taste as if it had just been freshly brewed. Remember, however, to always vigorously stir a beverage before it is reheated. Chocolate squares may be melted in their original paper wrapper, in a glass mixing bowl, in custard cups or glass measuring cups. If milk is to be added to melted chocolate squares, add water to the melted chocolate for easier blending.

SPECIFICATIONS

Item	Rating Specification
Power Supply	120V 20A single phase with grounding 60Hz AC.
Power Consumption	1550W
Microwave Output Power	1100W
Microwave Frequency	2450MHz
Outside Dimensions	20.5(W) x 15(D) x 11.5(H) inches
Cavity Dimensions	13.5(W) x 13.5(D) x 9.2(H) inches
Weight	41.8 Lbs (Approx)
Cooking Time	Digital 99 minutes, 99 seconds

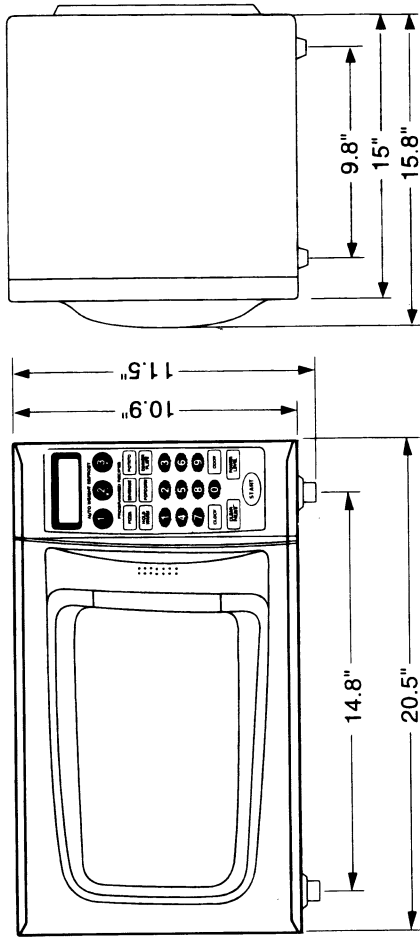

BEFORE YOU CALL FOR SERVICE

Refer to the following checklist before you call for service.

The oven does not work:

1. Check that the power cord is securely plugged in.
2. Check that the door is firmly closed.
3. Check that the cooking time is set.
4. Check for a blown circuit fuse or tripped main circuit breaker in your house.
5. Check that the Child Lock feature is not engaged.

Sparking in the cavity;

1. Check the containers, dishes or utensils in the oven and make sure they are not metal or have metal trim.

If there is still a problem, contact the nearest Emerson Authorized Service Center.



TO FIND THE LOCATION AND
PHONE NUMBER OF YOUR
NEAREST SERVICE CENTER
PERMITTED TO PERFORM
WARRANTY SERVICE...

CALL TOLL FREE: 1-800-695-0098

FOR ADDITIONAL SET-UP OR OPERATING ASSISTANCE
PLEASE CALL:
1-800-898-9020

FOR CUSTOMER SERVICE, PLEASE WRITE TO:
Emerson Radio Corp.
Consumer Affairs Dept.
1901 DIPLOMAT DRIVE
FARMERS BRANCH, TX 75234

WEIGHT & MEASURE CONVERSION CHART

• POUNDS & OUNCES TO GRAMS

POUNDS (lbs)	GRAMS (g)	OUNCES (oz)	GRAMS (g)
1/4	113	1	28
1/2	227	2	57
3/4	340	3	85
1	454	4	113
2	907	5	142
3	1361	6	170
4	1814	7	198
5	2268	8	227
6	2722		
7	3175		
8	3629		
9	4082		
10	4536		
11	4990		

• FLUID MEASUREMENTS

1 Cup =	8 fluid ounces	=	240 ml
1 Pint =	16 fluid ounces	=	480 ml
1 Quart =	32 fluid ounces	=	960 ml

AUTO WEIGHT DEFROST AND COOK CONVERSION CHART

Ounces	Hundredths of a Pound	Tenths of a pound	Grams
1 - 2	.06 - .15	0.1	50
3 - 4	.16 - .25	0.2	100
5 - 6	.26 - .35	0.3	150
7	.36 - .45	0.4	200
8 - 9	.46 - .55	0.5	250
10 - 11	.56 - .65	0.6	300
12 - 13	.66 - .75	0.7	350
14	.76 - .85	0.8	400
15 - 16	.86 - .95	0.9	450

SPECIFICATIONS

ITEM	RATING SPECIFICATION
Power Supply	120V 60Hz AC
Power Consumption	1550W
Microwave Output Power	1100W
Microwave Frequency	2450MHz
Outside Dimensions	20.5 (W) x 11.5 (H) x 15 (D) inches
Cavity Dimensions	13.5 (W) x 9.2 (H) x 13.5 (D) inches
Cavity Volume	1.0 Cu. Ft.
Weight (Approx.)	41.8 Lbs.
Cooking Time	99 minutes, 99 seconds

HOLD WARM (To keep food warm after cooking is completed)

1. Program the desired cooking time and power level (do not perform this step if warming after conventional cooking).
2. Press the HOLD WARM pad once for every 10 minutes of Hold Warm time (up to 30 minutes).
3. Press START pad. The oven will cook and then begin Hold Warm feature.

DINNER PLATE (To reheat plated foods)

1. Press the DINNER PLATE pad once for regular amount, twice for smaller amount or three times for a larger amount of food.
2. Press the START pad; the oven will cook at full (100%) power

Regular	Small	Larger
"REG"	"SAL"	"BIG"
3:00	1:50	3:30

PIZZA (To reheat refrigerated leftover pizza)

1. Press the PIZZA pad once for each slice of pizza to be reheated.
2. Press the START pad; the oven will cook at full (100%) power at the time as shown in the chart.

1 Slice	2 Slices	3 Slices
"P 1"	"P 2"	"P 3"
0:30	1:00	2:00

POTATO (To cook up to 3 potatoes)

1. Press the POTATO pad once for each potato to be cooked.
2. Press the START pad; the oven will cook at full (100%) power at the time as shown in the chart.

1 Potato	2 Potatoes	3 Potatoes
"PO 1"	"PO 2"	"PO 3"
3:20	5:40	7:15

POPCORN (To cook a 3.5 oz microwaveable popcorn package)

1. Press the POPCORN pad.
 2. Press the START pad; the oven will cook for 1 minutes 45 second at full (100%) power.
- NOTE:** Do not leave the oven unattended while popping popcorn.

BEVERAGES

1. Press the BEVERAGES pad repeatedly until the desired number of mugs appear in the display window (up to 3).
2. Press the START pad; the oven will cook at full (100%) power at the time as shown in the chart.

NOTE: Up to 3 mugs of beverage can be heated. Heating time is as follows:

1 MUG	CU P1 (1 Min., 45 Sec.)
2 MUGS	CU P2 (3 Min., 15 Sec.)
3 MUGS	CU P3 (4 Min., 55 Sec.)

TO SET CHILD LOCK FEATURE

The oven can be set so the control panel is deactivated or locked.

1. Press the 0 pad once.
2. Press the START pad 5 times; the display will show "LO C".

TO CANCEL CHILD LOCK FEATURE

1. Press the 0 pad once.
2. Press the START pad 5 times; the display will return to the present time.

NOTE: A beep sound will be heard when setting or cancelling the Child Lock feature.

COOKING IN TWO STAGES

1. Press the COOK pad.
2. Press the number pads to set the cooking time for the first stage.
3. Press the POWER LEVEL pad and then the number pads to set the power level for the first stage. (If cooking at full power, omit this step and the oven will cook at full power for the first stage.)
4. Press the COOK pad first and then press the number pads to set the cooking time for second stage.
5. Press the POWER LEVEL pad and then the number pads to set the power level for the second stage.
6. Press the START pad.

AUTO WEIGHT DEFROSTING

1. Press the desired auto weight category.
2. Press the number pads to enter the food's weight.
3. Press the START pad.

Category	Display	Food	Range
1	dEF 1	Poultry	0.1lb to 6.0lb
2	dEF 2	Meat,Ground	0.1lb to 4.0lb
3	dEF 3	Fish	0.1lb to 3.0lb

AUTO WEIGHT DEFROSTING AND COOKING IN TWO STAGES

1. Press the desired auto weight category (see chart above).
2. Press the number pads to enter the food's weight (this is stage 1).
3. Press the COOK pad.
4. Press the number pads to set the cooking time for the second stage.
5. Press the POWER LEVEL pad and then the number pads to set the power level for the second stage. (If cooking at full power, omit this step and the oven will cook at full power for the second stage.)
6. Press the COOK pad first and then press the number pads to set the cooking time for the third stage.
7. Press the POWER LEVEL pad and then the number pads to set the power level for the third stage. (If cooking at full power, omit this step and the oven will cook at full power for the third stage.)
8. Press the START pad.

TO STOP/CLEAR/RESTART THE OVEN

1. Press the CLEAR/PAUSE pad; the PAUSE indicator will start blinking and the oven stops cooking.
 2. Press the CLEAR/PAUSE pad again to clear programmed instructions, or press the START pad to restart the oven.
- NOTE:** The oven stops operating when the door is opened.

POWER LEVEL AND WATTAGE OUTPUT CHART

The power level is set by pressing the POWER LEVEL pad and then the desired number pad; the display will show the selected power level. If the power level is not set, the oven will automatically cook at full (100%) power. See chart below for the Wattage Output Chart.

Press	Power Level	Wattage Output
none	10	1100
	9	990
	8	880
	7	770
	6	660
	5	550
	4	440
	3	330
	2	220
	1	110

COOK DEFROST PAUSE

PL 3

MICROWAVE OVEN COOKING CHART

THIS CHART PROVIDES A QUICK REFERENCE FOR OPERATING YOUR MICROWAVE OVEN. REFER TO THE OWNER'S MANUAL FOR DETAILED INSTRUCTIONS. BEFORE USING THE MICROWAVE OVEN, READ AND FOLLOW ALL SAFETY INSTRUCTIONS AND PRECAUTIONS OUTLINED IN THE OWNER'S MANUAL.

COOK	PORTION	POWER LEVEL	TIME (MINUTES)	STANDING TIME (MINUTES)
Bacon	3.5 oz. (4 strips)	Power 10	3 1/2 to 4 1/2	-
Canned Soup	11 oz.	Power 10	4 to 5	2
Hamburger	4 patties	Power 8	3 1/2 to 4 1/2	5 to 7
Meatloaf	2 lb.	Power 8	15 to 17	10 to 12
Beef Roast	3.5 to 4 lbs	Power 6	22 to 25	10 to 15
Pork Roast	3 lbs	Power 6	27 to 32	10 to 15
Chicken - whole	2.5 lb.	Power 8	11 to 15	10 to 15
Chicken - parts	2 lb.	Power 8	9 to 13	7 to 10
Fish Fillets	1 lb.	Power 8	5 to 6	4 to 5
Shrimp	1 lb.	Power 8	3 to 4	5
Fresh Vegetables	1 lb.	Power 10	3 1/2 to 4 1/2	2
Frozen Vegetables	1 lb.	Power 10	4 to 6	2
Hot Dogs	4 hot dogs	Power 8	1 to 1 1/2	1
Muffin	6 muffins	Power 6	4 to 6	2 to 5
TV-style Dinner	1 dinner (11 oz.)	Power 8	5 to 7	2

SETTING THE CLOCK (The clock should be set to operate the oven.)

1. Press the CLOCK pad.
2. Press the number pads to set the time.
3. Press the CLOCK pad.

COOKING IN ONE STAGE

1. Press the COOK pad.
2. Press the number pads to set the cooking time.
3. Press the POWER LEVEL pad and then the number pads to set the power level. (If cooking at full power, omit this step and the oven will cook at full (100%) power.
4. Press the START pad.



Emerson

EMERSON RADIO CORP.
MODEL MW8109W

LIMITED WARRANTY MICROWAVE OVENS

Emerson Radio Corp. Warrants this product to be free from manufacturing defects in original material, including original parts, and workmanship under normal use and conditions ("manufacturing defect") for a period of one (1) year from date of original purchase in, and if used in, the United States ("warranty"). Should service be necessary under this warranty, Emerson will provide the following at an Independent Service Center or Regional Repair Facility permitted by Emerson to perform repairs, provided the manufacturing defect is verified along with the date of purchase:

* Repair service for one (1) year from date of original purchase at no charge for labor and parts.
* Replacement of a defective magnetron for seven (7) years from date of original purchase (labor not included after initial twelve (12) months).

There are Independent Service Centers and Regional Repair Facilities located throughout the country. For one nearest you, DIAL TOLL FREE: 1-800-695-0098. In the event the product must be mailed to a Regional Repair Facility which is permitted by Emerson to perform repairs:

- * Pack the unit in a well-padded heavy corrugated box.
- * Enclose your check or money order payable to the REGIONAL REPAIR FACILITY in the amount of \$15.00 to cover return shipping and handling costs.
- * Enclose a copy of your proof of purchase (warranty service will not be provided without dated proof of purchase).
- * Ship the unit prepaid via UPS or parcel post (insured).

NOTE: This warranty does not cover:

- (a) Damage to equipment not properly connected to the product.
- (b) Cost incurred in the shipping of the product to and from a Regional Repair Facility permitted by Emerson to perform warranty repairs.
- (c) Damage or improper operation of unit caused by customer abuse, misuse, negligence, or failure to follow operating instructions provided with the product.
- (d) Ordinary adjustments to the product which can be performed by customer as outlined in the owner's manual.
- (e) Signal reception problems caused by external antenna or cable systems.
- (f) Products not purchased in the United States.
- (g) Damage to product if used outside the United States.

THIS WARRANTY IS NON-TRANSFERABLE AND APPLIES ONLY TO THE ORIGINAL PURCHASER AND DOES NOT EXTEND TO SUBSEQUENT OWNERS OF THE PRODUCT. ANY APPLICABLE IMPLIED WARRANTIES, INCLUDING THE WARRANTY OF MERCHANTABILITY, ARE LIMITED IN DURATION TO A PERIOD OF THE EXPRESSED WARRANTY AS PROVIDED HEREIN BEGINNING WITH THE DATE OF ORIGINAL PURCHASE AT RETAIL AND NO WARRANTIES, WHETHER EXPRESSED OR IMPLIED, SHALL APPLY TO THE PRODUCT THEREAFTER. EMERSON MAKES NO WARRANTY AS TO THE FITNESS OF THE PRODUCT FOR ANY PARTICULAR PURPOSE OR USE.

THE EXTENT OF EMERSON RADIO CORP'S LIABILITY UNDER THIS LIMITED WARRANTY IS THE REPAIR OR REPLACEMENT PROVIDED ABOVE AND, IN NO EVENT, SHALL EMERSON RADIO CORP'S LIABILITY EXCEED THE PURCHASE PRICE PAID BY THE PURCHASER OF THE PRODUCT. UNDER NO CIRCUMSTANCES SHALL EMERSON RADIO CORP. BE LIABLE FOR ANY LOSS, DIRECT, INDIRECT, INCIDENTAL, SPECIAL, OR CONSEQUENTIAL DAMAGE ARISING OUT OF OR IN CONNECTION WITH THE USE OF THIS PRODUCT.

THIS WARRANTY IS VALID ONLY IN THE UNITED STATES OF AMERICA. THIS WARRANTY GIVES YOU SPECIFIC LEGAL RIGHTS. HOWEVER, YOU MAY HAVE OTHER RIGHTS WHICH MAY VARY FROM STATE TO STATE. SOME STATES DO NOT ALLOW LIMITATION ON IMPLIED WARRANTIES OR EXCLUSION OF CONSEQUENTIAL DAMAGE, THEREFORE THESE RESTRICTIONS MAY NOT APPLY TO YOU.

MV1094F