

# OPERATING INSTRUCTIONS

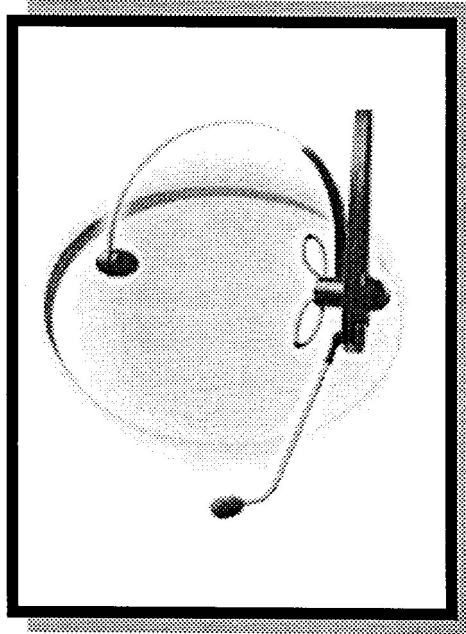

**HIGH PERFORMANCE  
RADIO FREQUENCY WIRELESS HEADSET**



## RADIO FREQUENCY WIRELESS HEADSET

---

### 1. INTRODUCTION

Thank you for taking time to evaluate this unique wireless headset system. The RF-3296 was designed for power users of dictation software. Our goal is to offer a breakthrough in comfort, performance, convenience, and simplicity for users who demand the best. Your experience and comments will help us produce the finest system possible.

#### **Performance Objectives**

We set out to build to create the ideal wireless headset for large vocabulary speech recognition. Our primary design criteria included:

- Accuracy
- Comfort
- Ease of Operation

Accuracy is delivered by the Emkay NR-3160 microphone element. The RF-3296 brings to wireless the unparalleled performance of our best VR series headsets for noise cancellation, sensitivity, and S/N rating.

The earloop design of our premium VR headsets is widely recognized as the most comfortable available. We sought to provide identical comfort in a wireless system without requiring a cumbersome belt pack. Conventional technology did not allow us the freedom to lose the belt pack and limit headset weight to prevent user fatigue.

**Enter unconventional technology...**

Emkay minimizes headset weight with patented TMX magnetic technology from Phonic Ear Inc. The audio from the computer sound card is modulated in the time domain at a high frequency, and demodulated in the headset with very little power consumed. Combined with low power RF design, TMX reduces total headset weight to an astounding two ounces.

**The Result**

A duplex headset you can wear all day for dictation, navigation, and computer telephony. So comfortable, you may forget to take it off for lunch!

---

## **2. GETTING STARTED**

The RF-3296 is a single channel / single user system. We recommend you operate no closer than 40 feet to a second RF-3296 system. The RF-3296 is intended as a computer headset, and may be connected to a voice-capable modem for telephony. By using a switch box, you may use the system with a conventional single line telephone. The system is not compatible with multiline telephones.

**The RF-3296 Wireless Headset System includes:**

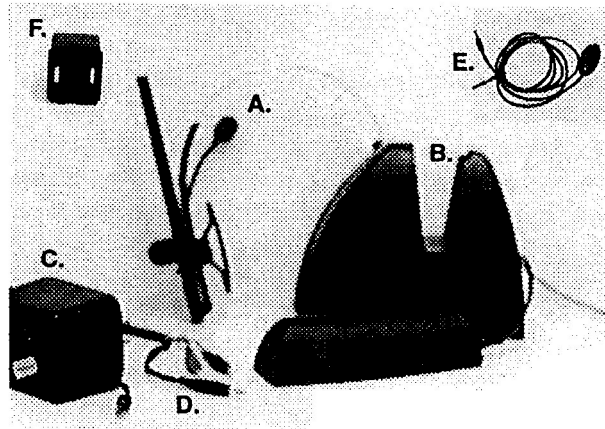

- A. Headset
- B. Base Station Assembly
- C. Wall Transformer
- D. Audio Cable
- E. PLL Cable
- F. Spare Battery

To prepare to use your system you will need to charge your headset battery and make the system connections. Make sure you have all the components listed on the previous page and proceed through the step by step instructions.

**Step 1 - Base Station Location**

Select a location for the Base Station Assembly (B - base station, transmit antenna, and cable). The base station should be accessible for you to charge your headset and spare battery. Suggested location: To the side of your computer with line-of-sight to your headset. Please allow four inches separation between the Base Station and your monitor or CPU if possible.

**Step 2 - Transmit Antenna Location**

Select a location for your transmit antenna. You will want this as far forward on your desk top as possible, to maximize your transmit range. Suggested location: Next to your mouse pad or keyboard, but within 24 inches of the Base Station.

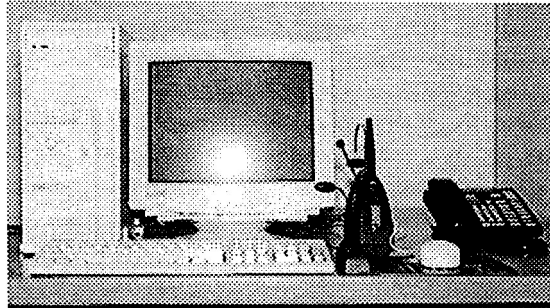

**Steps 1-2**

### Step 3 - Connections

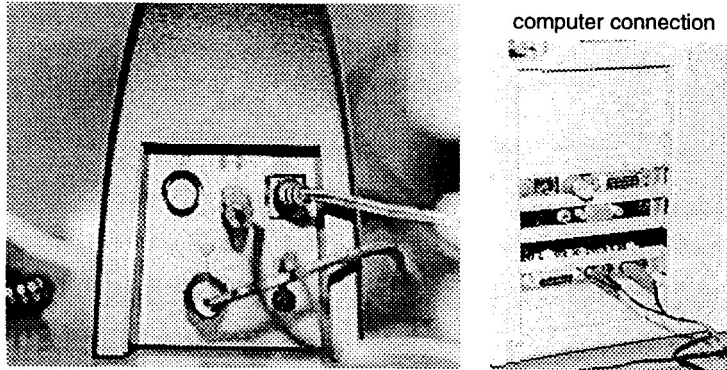

**i. Transformer**

Wall receptacle (110V, 60 cycle) to Base Station patch bay.

**ii. Audio Cable**

Single plug end (black stereo) to Base Station patch bay.

Dual plugs

Red plug to sound card (microphone in)

Black mono plug to sound card (headphone out)

**iii. PLL Cable**

Single ended to Base Station patch bay. Velcro to corner of computer monitor frame.

### Step 4 - Charging

Charge headset battery and spare. The headset battery charges when the headset is placed into the base station. The amber indi-

cator lights when the headset is charging. There is also a slot for charging a spare battery. Please allow eight hours for complete charging. The headset and batteries will not be damaged by indefinite charging.

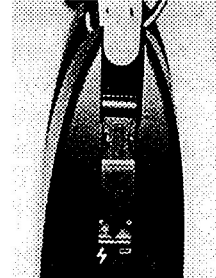

### Step 5 - Test Audio

Test your audio. Open the Sound Recorder (Programs, Accessories, Multimedia, Sound Recorder).

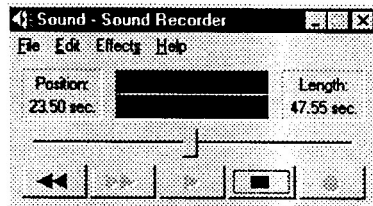

Set your headset switch to position II (duplex). Turn on base station (push button switch in patch bay). Green indicator lights on Base Station when power is on. Press the Record button (red dot) and speak. You should see some signal appear on the Sound Recorder. Press the stop button (black square). Press the Play Button. You should hear your recorded voice at a comfortable level through the headset. Adjust the Record Level and/or Playback Level on your PC if needed.

---

### **3. SYSTEM OVERVIEW**

The following section describes the RF-3296 in greater detail to help you understand the product better:

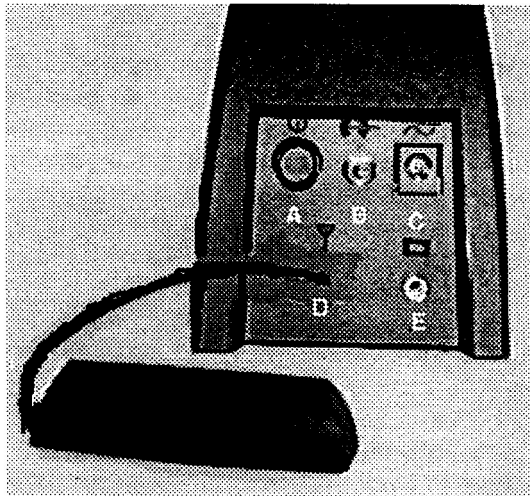

#### **Base Station Assembly**

- A - ON/OFF Switch
- B - Audio Jack
- C - Power Jack
- D - Transmit Antenna
- E - PLL Jack

The Base Station serves as a charging stand for the headset, and will also charge a spare battery pack. All electrical connections



are made to the patch bay of the base station. You will find the ON/OFF button in the patch bay. A green indicator lamp on the opposite side of the Base Station confirms that the power is on. The adjacent amber lamp lights when the headset is charging. The charging circuit stays active with the power off.

You will notice a thumbwheel on the side of the base station. This is a volume control for the headset speaker, and will not normally require adjustment. If you use the RF-3296 for computer telephony, or use your headset with more than one program, the volume control is a convenient alternative to changing software volume settings repeatedly.

volume control

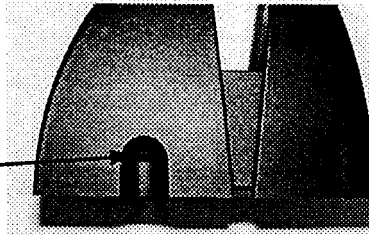

### **Transmit Antenna**

The Transmit Antenna is a magnetic coil in a plastic enclosure which sends audio from your computer to your headset speaker. It should be placed flat on your desktop or computer stand as close to you as possible with the front pointed toward you. The molded in arrow on the bottom of the transmit antenna points to the front. The Transmit Antenna is connected with a cable to the Base Station patch bay.

### **Headset**

Your lightweight headset is designed for extended periods of comfortable wear. The easiest way to put the headset on is to

place your ear through the loop, and slowly release the headband until the temple piece rests on the opposite side of your head. The band adjust for a comfortable fit. If you find the earloop too small for your ear, please let us know, and we will send you a larger replacement.

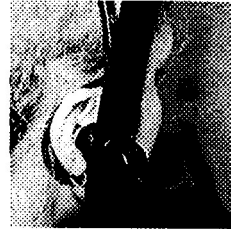

**Earloop fits over the ear**

The headset slide switch has three positions:

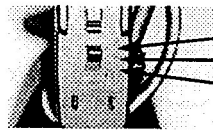

- O - ON/Off charge
- I - Microphone Only
- II - Duplex

The switch automatically moves to the Off/charge position when the headset is placed into the Base Station. Use the Microphone Only position if you need extended range (presentations, etc.). You may transmit up to 20 to 30 feet with this option. With the switch in the Duplex position, the headset range is 4 to 6 feet in front of the magnetic Transmit Antenna. As you move outside this range, you will hear static, and then silence. The static is a warning that you are about to move out of range, the automatic squelch feature saves battery life and silences the speaker, so you do not need to turn the headset off when leaving your desk. The headset operates 8 to 10 hours continuous on a full battery charge.

#### **PLL Cable**

If you plan to use the RF-3296 system near a conventional computer monitor, you may encounter interference with the audio signal to your headset speaker. Older and poorly shielded monitors

radiate magnetic energy at a frequency similar to the Transmit antenna. The PLL Cable detects the magnetic energy, and allows a Phase Lock Loop (PLL) circuit in the base station to eliminate

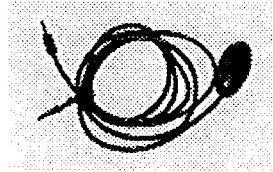

the interference. Place the housing of the PLL cable horizontal by (not on) the lower corner of your monitor using the Velcro patch provided.

If you are using a notebook PC or a well-shielded monitor, you may not

require the PLL cable. The Base Station does not require the PLL cable to function.

---

#### **4. FCC NOTICE**

This wireless microphone complies with Part 90 of *FCC Rules*. There are a total of eight frequencies available for this microphone, and the microphone you plan to use operates on one of these frequencies. You must get a license for the frequency you plan to use before you use the microphone. Whether this license is applicable depends on how you will use the microphone.

Look in your local phone book for the nearest FCC office and contact them to get the necessary application.

**Note:** This device complies with part 15 of the FCC Rules. Operation is subject to the following two conditions: (1) This device may not cause harmful interference, and (2) this device must accept any interference received, including interference that may cause undesired operation.

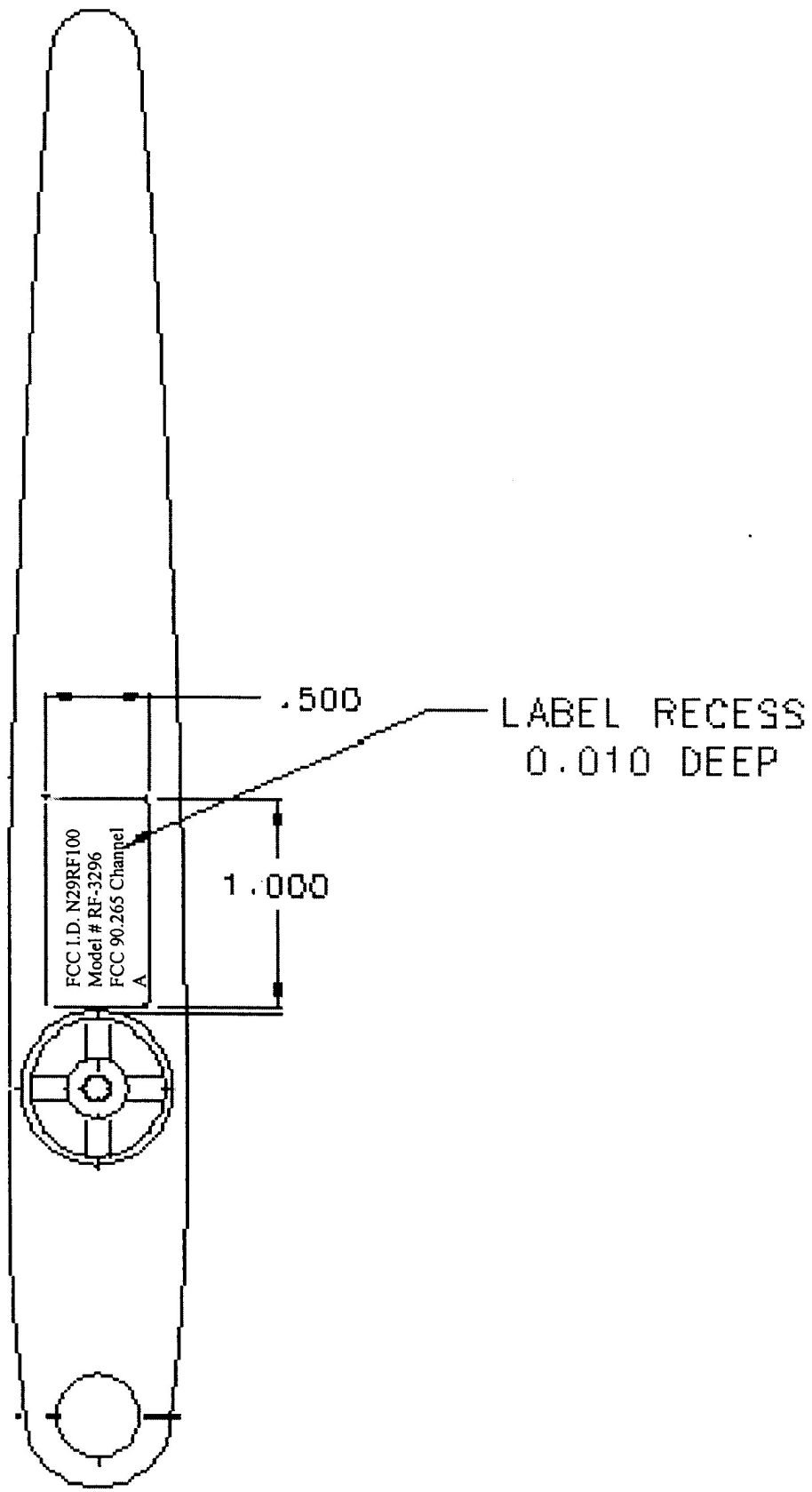

## Base Station Label

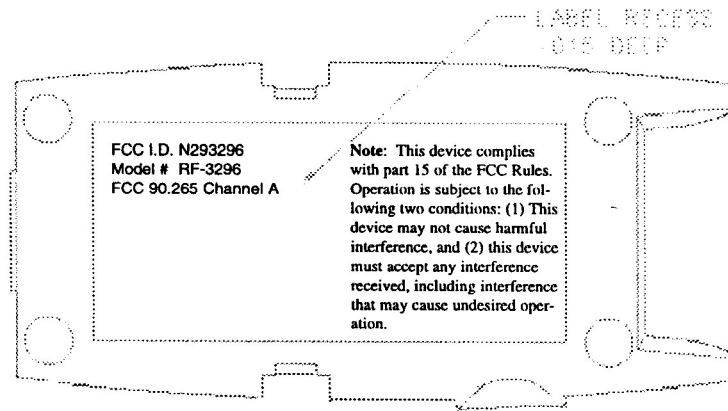

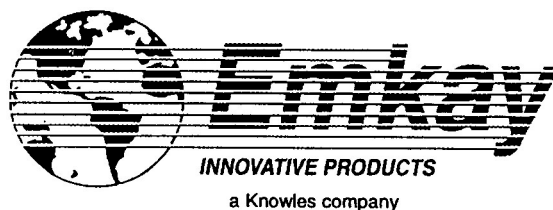

**Located worldwide to serve You!**

**Emkay Innovative Products**  
2800 West Golf Road  
Rolling Meadows, IL 60008  
U.S.A.  
Phone: 800-276-8516  
Fax: 847-952-0712

**Micromax PTY. LTD.**  
P.O. Box 1238  
Wollongong N.S.W.  
2500, Australia  
Phone: 61-2-4226-6777  
Fax: 61-2-4226-6602

**Emkay Innovative Products**  
73 Victoria Road  
Burgess Hill  
West Sussex, RH15 9LP  
England  
Phone: 44-1444-235432  
Fax: 44-1444-248724

**Emkay Innovative Products**  
Kyodo Bloom Building  
19-1 Miyasaka 2-Chome  
Setagaya-Ku, Tokyo 156-0051  
Japan  
Phone: 81-3-3439-1151  
Fax: 81-3-3439-8822

**Emkay Innovative Products**  
53 Pao Hsing Road  
Hsin Tien City, Taipei  
Taiwan  
Republic of China  
Phone: 886-2-2911-4931  
Fax: 886-2-2918-6868

**Emkay Innovative Products**  
Bahnhofstrasse 26 - 28  
D-85635 Hoehenkirchen  
Germany  
Phone: 49-(0)-8102-781-401  
Fax: 49-(0)-8102-781-254

**[www.emkayproducts.com](http://www.emkayproducts.com)**