

emotivo

brain computer interface technology



Emotiv EPOC User Manual

Includes headset
and software setup
information for your Emotiv
EPOC neuroheadset.

Table of Contents

- Quick Start Guide 4
- Introduction to Emotiv EPOC Neuro-technology Neuroheadset 11
 - NEUROHEADSET FEATURES 12
 - SAFETY 13
 - REGULATORY REQUIREMENTS..... 14
- 1.0 Getting Started..... 16
- 2.0 Minimum Hardware and Software requirements 17
- 2.1 Charging the EPOC Neuroheadset Battery 17
- 2.2 Use of Saline Hydration Sensor Pack and Felt Inserts 18
- 2.3 USB Transceiver Installation..... 20
- 2.4 EPOC Control Panel™ 20
- 2.5 Placement of Emotiv EPOC Neuroheadset on the Head..... 21
- 2.6 EmoEngine Status Panel 21
- 2.7 User Status 22
- 2.8 Sensor Contact Quality Display 23
- 2.9 Neuroheadset Set-Up 24
- 3.0 Achieving Good Signal Quality 25

3.1 Expressiv™ Suite	27
3.1.1 UNDERSTANDING THE EXPRESSIV SUITE PANEL DISPLAY.....	27
3.1.2 SENSITIVITY ADJUSTMENT PANEL	28
3.1.3 EMOKEY.....	29
3.2 Affectiv™ Suite	31
3.2.1 AFFECTIV SUITE INTRODUCTION	31
3.2.2 UNDERSTANDING THE AFFECTIV PANEL DISPLAY	32
3.2.3 AFFECTIV SUITE DETECTION DETAILS	32
3.3 Cognitiv™ Suite	33
3.3.1 COGNITIV SUITE INTRODUCTION	33
3.3.2 UNDERSTANDING THE COGNITIV PANEL DISPLAY.....	34
3.3.3 COGNITIV TRAINING	35
3.3.4 TRAINING NEUTRAL.....	37
3.3.5 CLEAR TRAINING BUTTON	38
3.3.6 COGNITIV TIPS.....	38
3.3.7 EMOKEY FOR COGNITIV ACTIONS	39
3.4 Mouse Emulator	41
3.4.1 UNDERSTANDING THE MOUSE EMULATOR TAB	41
3.4.2 MOUSE EMULATOR CONTROLS.....	42
4.0 Trouble Shooting and Help	43

Quick Start Guide

Items in the EPOC Headset Kit

Make sure all items are present in your kit before starting.

- Headset Assembly with Rechargeable Lithium battery already installed
- USB Transceiver Dongle
- Hydration Sensor Pack with 16 Sensor Units
- Saline solution
- 50/60Hz 100-250 VAC Battery Charger (US customers) or USB charger (non-US customers)
- CD Installation Disk for Windows XP or Vista (for EPOC consumer headset. SDKs are delivered electronically)

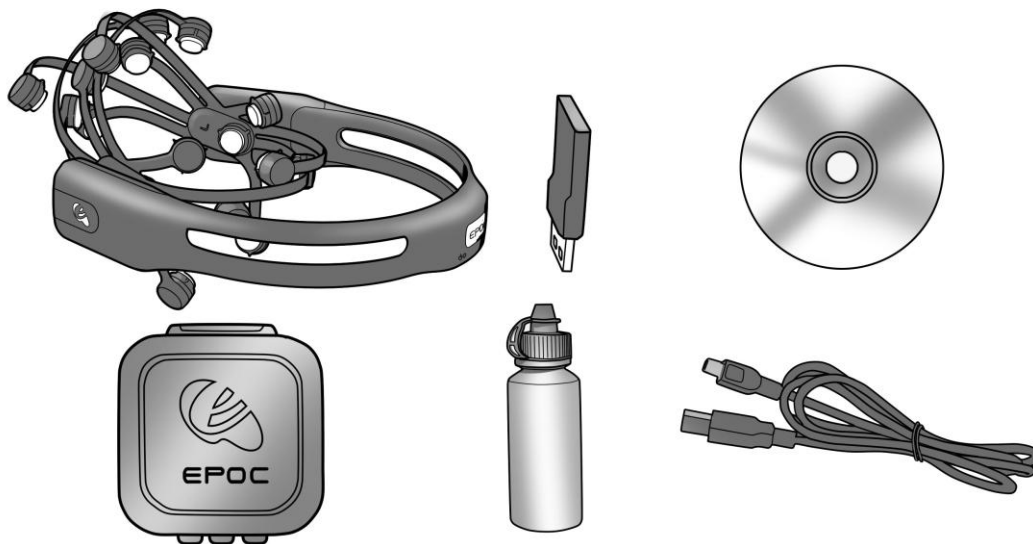

Initial charging of headset

Make sure the small switch on the rear underside of the headset is set to the “Off” position before starting.

Plug the mini USB cable attached to the supplied battery charger into the slot at the top of the headset and to the USB port on your PC or the power cord into a 50 or 60 Hz 100-250 V electrical outlet.

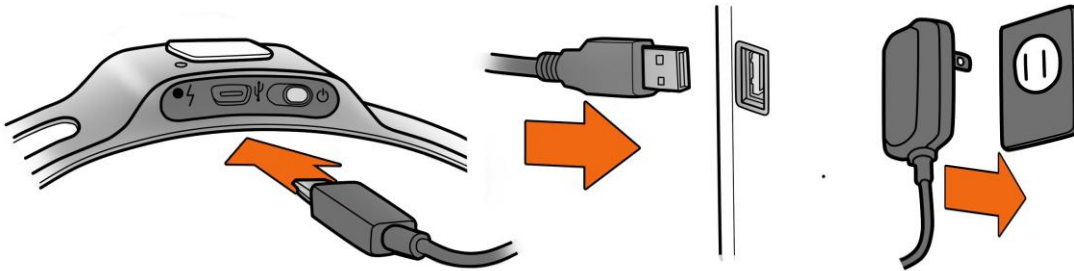

The Lithium battery can be recharged to 100% capacity in approximately 4 hours depending on the initial state of charge. Charging for 30 minutes usually yields about a 10% increase in charge.

The EPOC Headset contains two status LEDs located at the rear and next to the power switch at the back of the headband. When the power switch is set to the “on” position, the rear LED will illuminate and appear blue if there is sufficient charge for correct operation, unless charging is in progress. The charging LED will appear red during battery charging; when the battery is fully-charged, the charging LED will display green.

NOTE: The Headset should not be charged when still on the head.

Software Installation

Insert the supplied EPOC CD setup disk into your computer's CD/DVD drive and follow the step-by-step installation instructions.

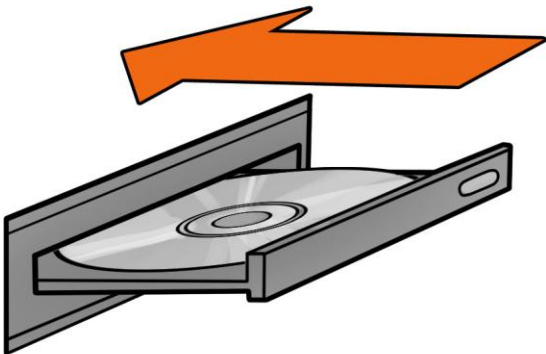

After software installation, start-up the EPOC Control Panel program, loading the Headset Setup screen.

Hydrating the Sensors

Open the Saline Hydration Sensor Pack with the white felt inserts inside. The inserts will eventually be mounted in the headset arms but must be properly wetted with saline solution first. Begin wetting each of the felt inserts with the supplied saline solution. The felts should be wet to the touch, but not soaking wet!

Note: This is standard multipurpose contact lens saline solution and is available from any local drug store in case you run out of solution. However, the bottle supplied with the kit should be sufficient initially. See the User Manual on the EPOC CD setup disk for recommendations.

Add a few drops of saline to saturate the large white hydrator pad attached to the top cover of the hydrator, then close the cover and gently shake the hydrator pack. This will maintain the moisture of the felt pads when they are not in use. Open the pack and check that each of the pads had been wetted. If not fully wetted, then add a drop or two of saline to any pads not sufficiently wet using the dropper bottle. Be careful not to over-wet the pads. If you have connection problems, add more saline to each felt pad.

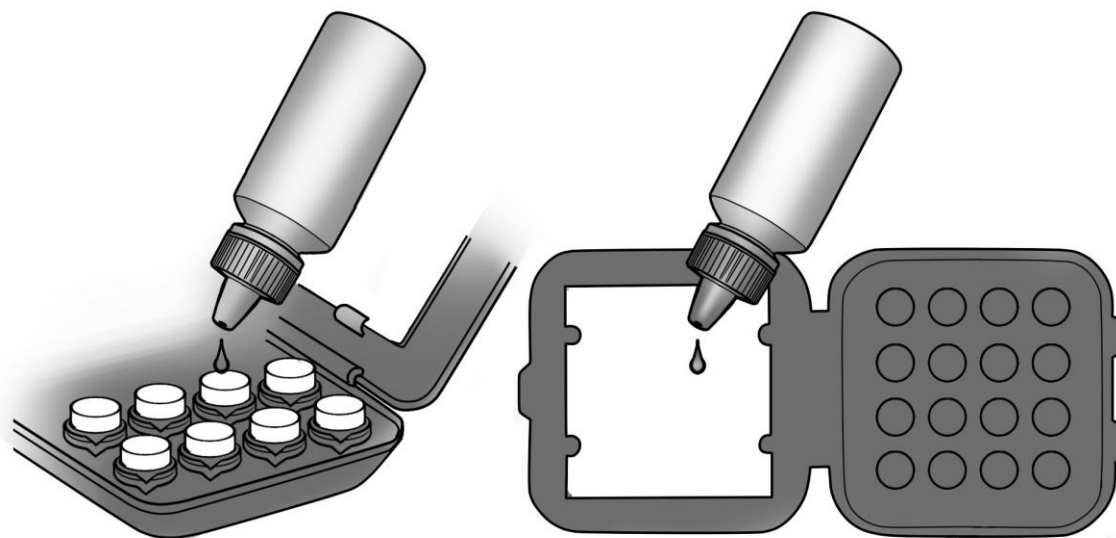

Sensor Assembly

After the wetting process, remove the sensor units with their felt pads from the hydrator pack and insert each one into the black plastic headset arms, turning each one clockwise one-quarter turn until you feel a definite "click". The "click" indicates each sensor is correctly installed in a headset arm. If you have difficulty with this step, apply a little more force until you feel the "click" but be careful not to exert excessive force as damage might occur. Please see the Troubleshooting section if the sensors do not click in place easily.

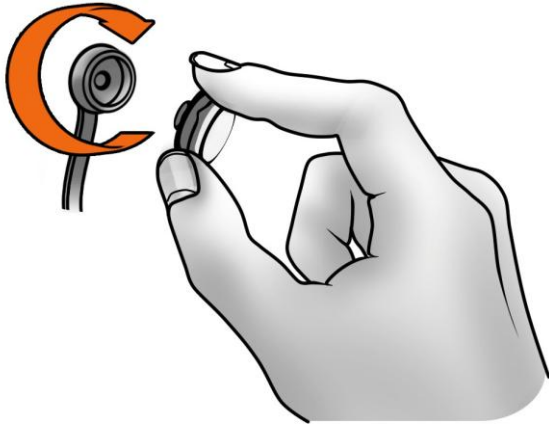

NOTE: When not in use, the sensor units should be removed from the headset arms and stored in the hydrator pack for subsequent use.

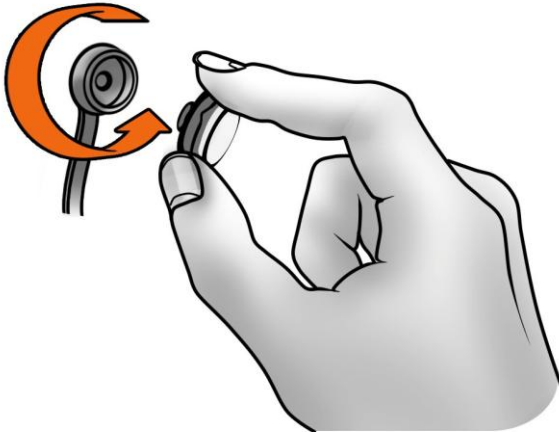

Pairing the Neuroheadset

Insert the supplied USB Transceiver Dongle into one of your computer's USB slots. Use a USB extension cable and position the Transceiver in a prominent location away from your monitor and PC to improve poor reception.

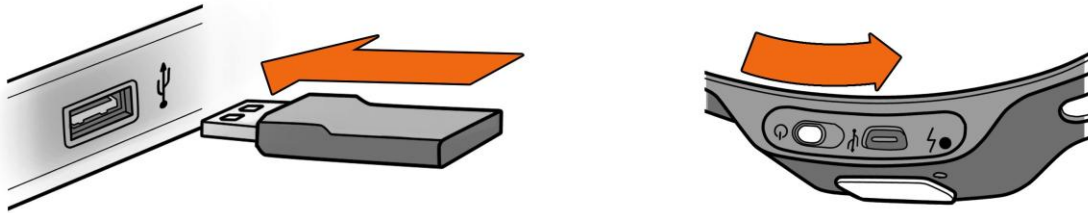

Then turn-on the headset using the switch at the bottom end of the headset, holding it close to the Transceiver.

Headset Placement

You are now ready to put the EPOC headset on your head. Using both hands, slide the headset down from the top of your head. Place the arms approximately as depicted, being careful to place the sensors with the black rubber insert on the bone just behind each ear lobe. Correct placement of the rubber sensor is critical for correct operation.

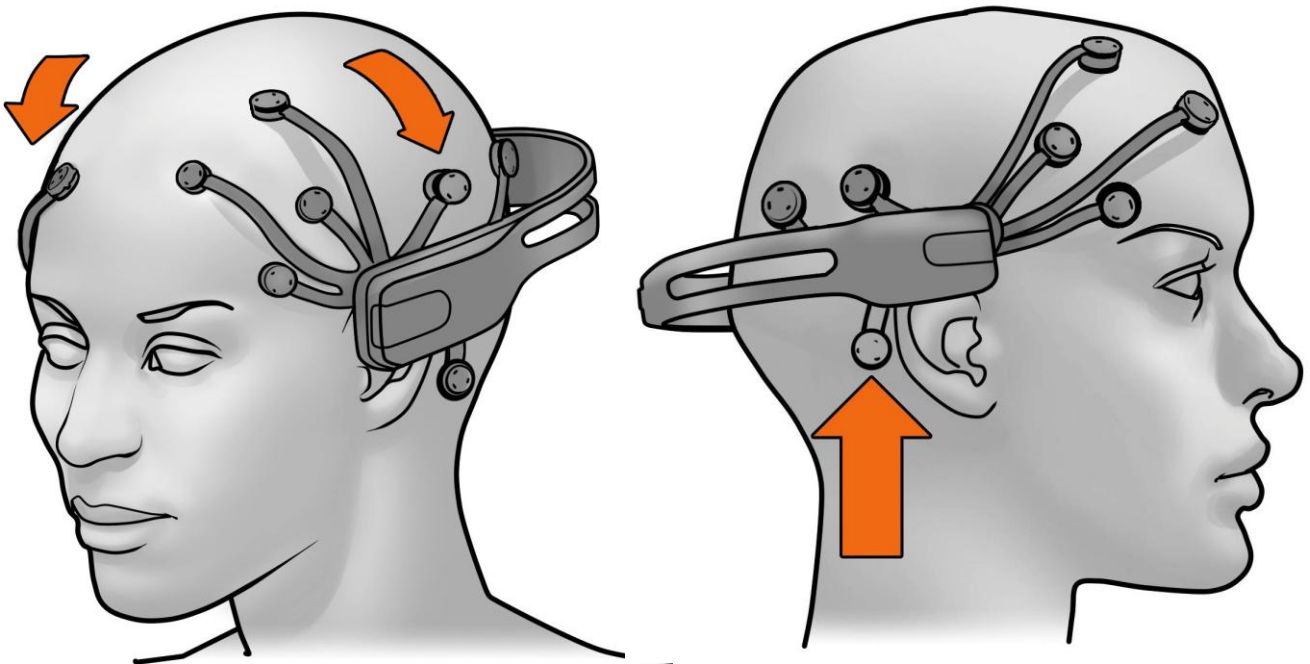

Notice the 2 front sensors should be approximately at the hairline or about the width of 3 fingers above your eyebrows.

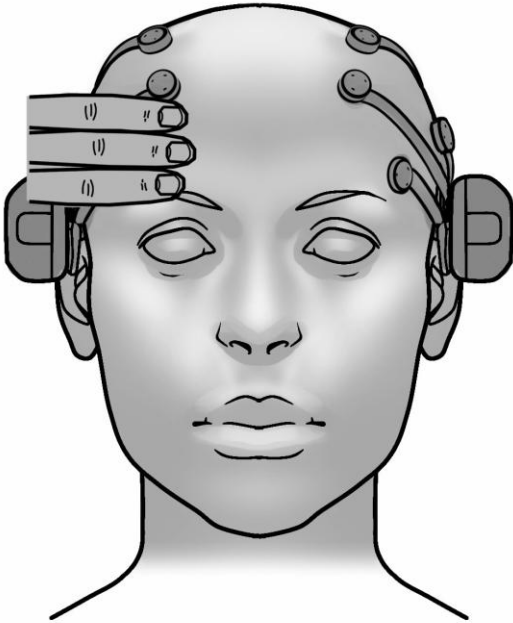

After the headset is in position, press and hold the 2 reference sensors (located just above and behind your ears) for about 5-10 seconds. **Good contact of reference sensors is the key for a good signal.** Check that the lights corresponding to these 2 reference sensors turn from red to green in the EPOC Control Panel Headset Setup screen.

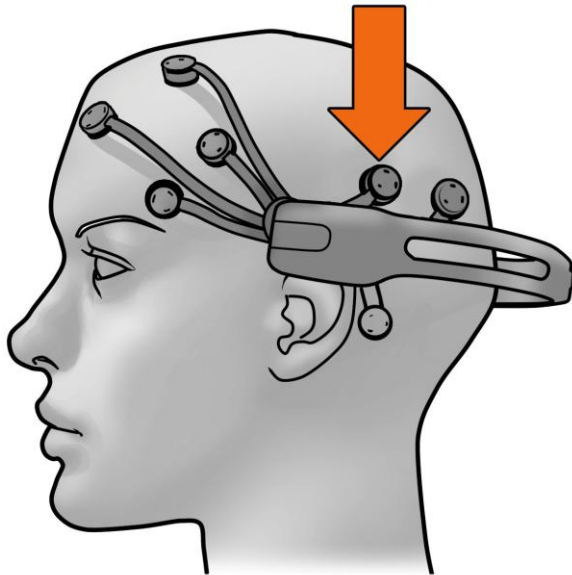

Gently press and hold each remaining sensor against your scalp until all the lights corresponding to those sensors turn to green in the EPOC Control Panel.

If you are unable to get anything except 2 red sensors, add saline to the reference and other sensors, or try the alternate reference locations – swap the reference sensors with the rubber comfort pads located directly behind the ears, making sure the reference sensors contact directly onto the bare skin on the bony bump.

Signal Quality Screen

Your objective is to achieve as many green lights as possible using the EPOC Control Panel and adjusting the position of the various arms accordingly. (See full User Manual Document contained on the CD for detailed instructions) Note that the EPOC will still function with some sensor locations showing yellow or orange, and will even cope with a few red or black however the detections will be less reliable in this state. Often the contact quality will gradually improve after a few minutes use, so don't be too discouraged if setup is not perfect at first.

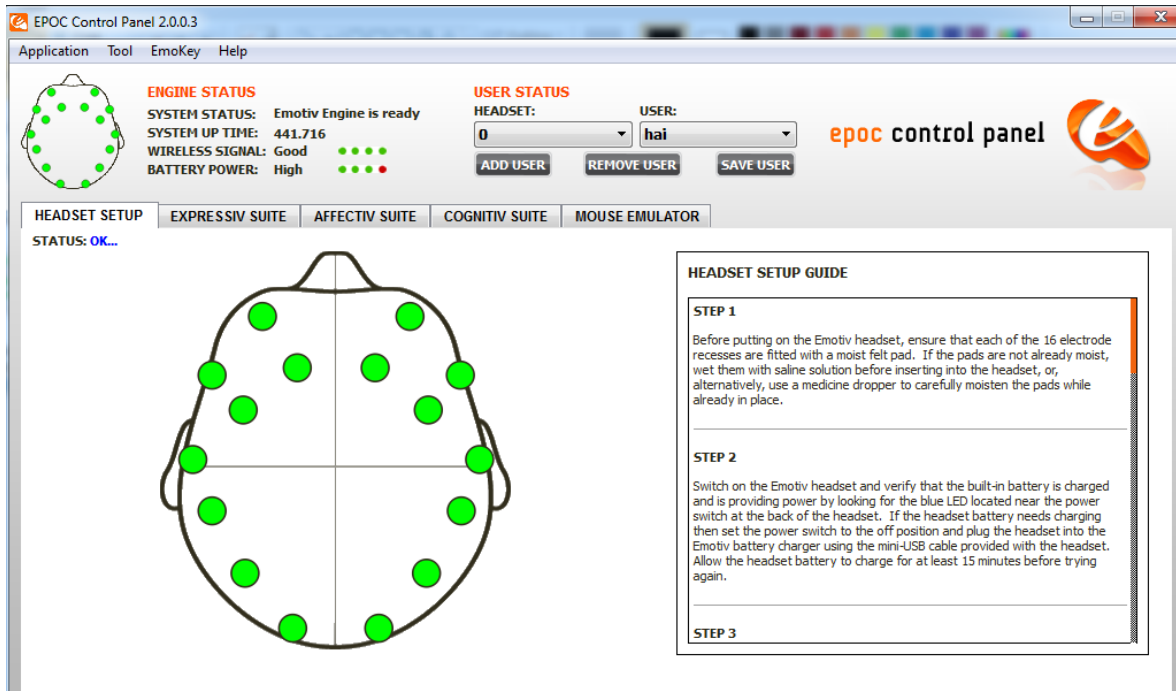

You are now ready to begin using the EPOC headset.

If you experience difficulties with initial headset start-up, fine tuning or operation, you may contact Emotiv EPOC Customer Support by live chat or support tickets at www.emotiv.com

Introduction to Emotiv EPOC Neuro-technology Neuroheadset

Fulfill the fantasy of having supernatural powers and controlling the world with your mind!

For over a millennium, mankind has dreamed of the ability to control objects with the power of thought. Today that dream has become reality! Now you can experience the fantasy of having supernatural powers and controlling the world with your mind.

Based on the latest developments in neuro-technology, Emotiv has developed a revolutionary new personal interface for human computer interaction. The Emotiv EPOC uses a set of sensors to tune into electric signals produced by the brain to detect player thoughts, feelings and expressions and connects wirelessly to most PCs.

Neuroheadset Features:

Limited edition design

14 biopotential sensors with gold-plated connectors offer optimal positioning for accurate spatial resolution

Gyroscope generates optimal positional information for cursor and camera controls

Hi-performance wireless gives users total range of motion

Dongle is USB compatible and requires no custom drivers

Rechargeable Lithium battery provides 12 hours of continuous use

Safety:

Please note the following safety considerations:

CHOKING HAZARD – detachable small parts. Keep away from small children.

DO NOT attach the neuroheadset to the charger or USB connector while in use. ALWAYS remove the neuroheadset during charging and avoid touching the sensors if fitted. Although unlikely, an insulation failure in the charger or USB source may cause the neuroheadset to become live. The neuroheadset will automatically enter sleep mode while attached to the charger, so it is not possible to extend use while charging.

WARNING: Radio emissions may interfere with appliances and medical equipment including heart pacemakers and automated medical dosimetry systems. Use with caution.

WARNING: Discontinue use if the system becomes uncomfortable to wear or if skin irritation occurs. Users are advised not to share sets of sensors to avoid cross-infection risks.

Regulatory Requirements:

FCC Requirements Part 15

This device complies with Part 15 of the FCC Rules. Operation is subject to the following two conditions:

1. This device may not cause harmful interference, and
2. This device must accept any interference received, including interference that may cause undesired operation.

This equipment has been tested and found to comply with the limits for a Class B digital device, pursuant to Part 15 of the FCC Rules. These limits are designed to provide reasonable protection against harmful interference in a residential installation. This equipment generates, uses, and can radiate radio frequency energy and, if not installed and used in accordance with the instructions, may cause harmful interference to radio communications. However, there is no guarantee that interference will not occur in a particular installation. If this equipment does cause harmful interference to radio or television reception which can be determined by turning the radio or television off and on, the user is encouraged to try to correct interference by one or more of the following measures:

1. Reorient or relocate the receiving antenna.
2. Increase the separation between the equipment and receiver.
3. Connect the equipment into an outlet on another circuit.
4. Consult the dealer or an experienced radio/TV technician for help.

NOTE: Modifications not expressly approved by Emotiv could void the user's authority to operate the equipment

Canada

This device complies with RSS-210 of Industry Canada (IC). Operation is subject to the following two conditions:

1. This device may not cause interference, and
2. This device must accept any interference received, including interference that may cause undesired operation of this device.

This Class B digital apparatus complies with Canadian ICES-003. Cet appareil numérique de la Classe B est conforme à la norme NMB-003 du Canada.

Europe, Australia, New Zealand

Product Name and Model: Emotiv EPOC Model 1.0

Product description: EPOC Neuroheadset, USB-01 Transceiver, Hydrator Pack + charger or charge cable

conforms to the following Product Specifications and Regulations:

EMC and Telecom: Class B

ETSI EN 300 440-2 V1.4.1

EN 301 489-1

EN 301 489-3

AS/NZS CISPR22 :2009

AS/NZS 4268 :2008

FCC CFR 47 Part 15C (identifiers XUE-EPOC01, XUE-USBD01)

Safety:

EN 60950-1:2006

IEC 60950-1:2005 (2nd Edition)

AS/NZS 60950.1:2003 including amendments 1, 2 & 3

CB Certificate JPTUV-029914 (TUV Rheinland)

The product herewith complies with the requirements of the Low Voltage Directive 2006/95/EC, the EMC Directive 2004/108/EC, the R&TTE Directive 1999/5/EC, and carries the CE and C-Tick marks accordingly.

1.0 Getting Started

EPOC Neuroheadset Kit Components:

EPOC Neuroheadset Assembly with Rechargeable Lithium battery already installed

USB Transceiver Dongle

Hydration Sensor Pack with 16 Sensor Units

Saline Solution

For US customers, 50/60Hz 100-250 VAC Battery Charger. For non-US customers kit includes USB to USB-MiniB battery charging cable providing 5.0V at 0.1A from a standard USB socket on any computer.

Quick Start Guide

All of the components of the Emotiv EPOC Neuroheadset are delivered in our standard shipping box. Inside the box you will find all of the components neatly stored for shipping and storage.

Note: Never put the Emotiv EPOC, or any of its components, back into the packaging until they have dried completely. Make sure the Hydrator sensor pack is sealed and is not leaking. If wet, wipe the seal clean before closing.

2.0 Minimum Hardware and Software requirements

2.4 GHz Intel Pentium 4 processor (or equivalent)

Microsoft Windows XP with Service Pack 2, Microsoft Windows Vista or Microsoft Windows 7

1GB RAM, minimum

50 MB available disk space.

One or two unused USB 2.0 ports (depending on the number of EPOC Neuroheadsets you wish to use simultaneously)

Insert the Installation Disk into you PC disk drive and install the EPOC software and follow the instructions. For instructions on Windows 7, any other application issues, contact Emotiv Support at support@emotiv.com. Toll Free in USA: 1-800-538-EMOTIV (1800-538-3668). We recommend you download the latest versions of Emotiv software from <http://www.emotiv.com/store/apps/> to obtain the latest features. Up to date versions of all software on the installation disk are available for free download. Many other applications are also available at the same location.

2.1 Charging the EPOC Neuroheadset Battery

The Emotiv EPOC Neuroheadset contains a built-in rechargeable lithium battery which is designed to run for approximately 12 hours when fully charged. To charge the EPOC battery, set the power switch to the “off” position, and plug the EPOC Neuroheadset into the Emotiv battery charger using the mini-USB cable provided with the EPOC Neuroheadset. Using the supplied battery charger, a fully drained battery can be recharged to 100% capacity in approximately 6 hours; charging for 30 minutes usually yields about a 10% increase in charge.

The EPOC Neuroheadset contains a status LED located next to the power switch at the back of the headband. When the power switch is set to the “on” position, the LED will illuminate and appear blue if there is sufficient charge for correct operation. The LED will appear red during battery charging; when the battery is fully-charged, the LED will display green.

NOTE 1: The Neuroheadset should not be charged when still on the head.

NOTE 2: Do not expose battery or neuroheadset to prolonged temperatures above 122°F (50°C). Damage to the battery or neuroheadset may occur.

2.2 Use of Saline Hydration Sensor Pack and Felt Inserts

Open the Saline Hydration Sensor Pack with the white felt inserts inside. The inserts will be mounted in the neuroheadset arms but must be properly wetted with saline solution first. The saline solution is harmless but allows the felt pads to make good contact with the skull when properly positioned on the head. This is a very important step.

Pour a small amount of saline onto each of the sensors (6 or 7 drops if completely dry). Once you have moistened the sensors, pour a small amount of saline onto the large white hydrator pad to evenly moisten the entire pad. Close the hydrator and allow the sensors to absorb some of the saline. You can shake or invert the hydrator unit so that the liquid is evenly distributed and absorbed into the felt pads. Note: For user comfort the sensor pads should be damp but not dripping wet. If the pads do not feel slightly wet, you may also place one or two more drops of the solution directly on the pads from the top to speed the process of absorption.

Following the initial hydration step, each of the inserts must be removed from the pack and securely mounted in the EPOC neuroheadset arms by turning the inserts one quarter turn to the right and listen/feel for the click. If you do not hear or feel the click, try again until you do. A very firm force may be needed the first couple of times but be careful not to exert excessive force or you may damage the headset arms. Practice on the sockets in the hydrator a few times if you are unsure.

Ensure that each sensor is locked in place. Note that the sensor location behind the ears is fitted with a soft rubber comfort pad. This should remain in place unless the normal Reference sensors do not contact properly (see below for alternative Reference Sensor location)

The fully populated neuroheadset should look like this:

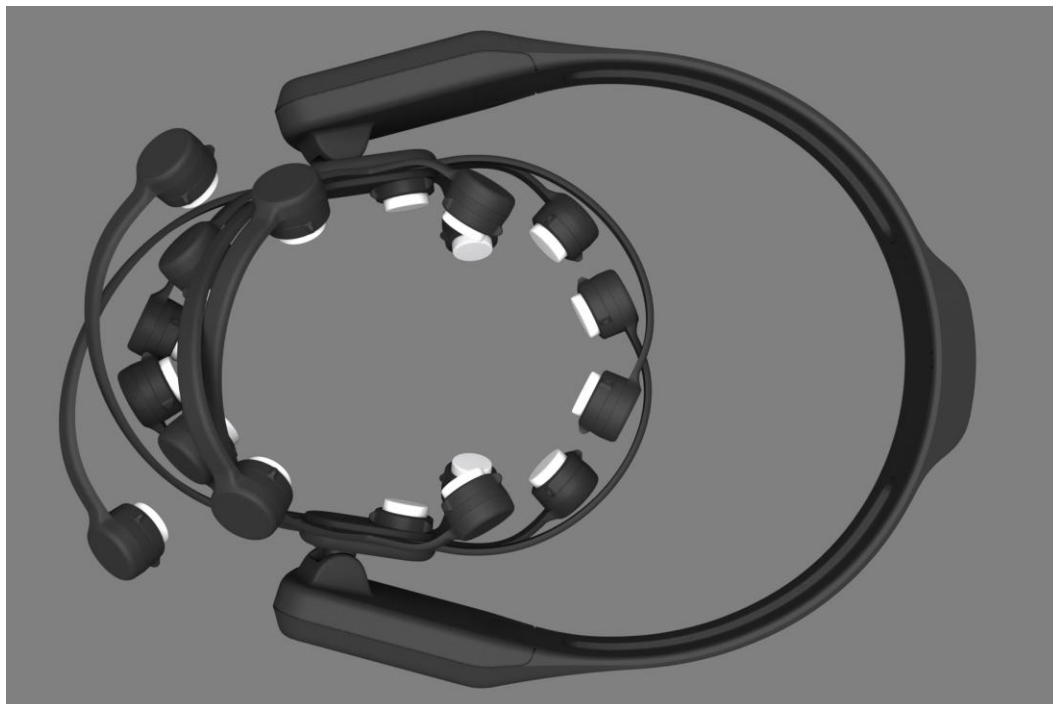

After first use, the pads should be rewet the next time EPOC is used by using a dropper to wet the sensors and hydrator pad again. The sensors should be removed from arms after use and stored in the hydrator unit to keep the sensors moist for subsequent use.

Note on saline solution: When the initially provided saline solution has been exhausted, additional saline should be purchased from a local drug store. We recommend the use of Multi-purpose Contact Lens Solution if possible, but do not use Contact Lens Cleaning or Sterilizing Solutions. Multi-purpose Solution contains non-allergenic anti-microbial agents which help to keep your sensors fresh and prevent transfer of microbes between users. Normal saline between 0.7% and 4% w-w sodium chloride may also be used, but we recommend adding a small quantity (no more than 4% by volume) of a household disinfectant such as 70% iso-propyl alcohol.

2.3 USB Transceiver Installation

Plug the provided Emotiv USB transceiver into an unused USB port on your computer. After one or two seconds you should see a single LED flashing slowly, or a single bright LED and another dim LED if the transceiver has already paired with a nearby neuroheadset. The transceiver should be recognized and installed automatically by your computer as a USB Human Interface Device. Please wait for a moment until Windows indicates that the new hardware is installed and ready to use.

Hold the Emotiv EPOC close to the USB receiver, and turn it on using the switch at the rear of the headband. You should see a new steady LED on the receiver, which indicates that the neuroheadset has properly paired with the USB receiver, and a more dim LED which flashes indicating successful data transfer.

2.4 EPOC Control Panel™

This section explains how to use EPOC Control Panel to explore the Emotiv detection suites.

Launch EPOC Control Panel by selecting Windows Start → Programs → Emotiv→ **EPOC Control Panel**. When the Control Panel is launched for the first time, your firewall software (if installed on your computer) may notify you that the Control Panel is trying to accept connections from the network. For proper operation, you must allow EPOC Control Panel to use this port by selecting “Unblock” (or a similar option, depending on your firewall software).



Figure 1 Windows Firewall warning about EPOC Control Panel – select Unblock

EPOC Control Panel showcases the capabilities of the Emotiv EPOC Neuroheadset to decipher brain signals, facial expressions and even mouse control using the in-built motion sensors.

2.5 Placement of Emotiv EPOC Neuroheadset on the Head

Carefully expand the EPOC neuroheadset to place it on subject's head. Using both hands, slide the neuroheadset down from the top of your head. Place the arms approximately as depicted, being careful to place the sensors with the black rubber insert on the bone just behind each ear lobe. Correct placement of the rubber sensor is critical for correct operation.

If any sensors fall out, replace them and ensure they are locked in place. The EPOC Neuroheadset should be positioned on the head as indicated by the following illustrations.

NOTE: Caution should be exercised never to bend the arms of the neuroheadset backwards out of their natural curvature. Damage may occur.

A view of a properly located Emotiv EPOC. Note that the front sensors are 2 – 2.5 inches (50-60mm or about three finger widths) above the eyebrows.

The “Reference Sensors” shown here must have good contact with the subject to assess the Contact Quality of the remaining sensors. You may need to press these against the subject's scalp for a short period to establish a good conductive path.

In the event that the Reference Sensors do not make proper contact (all or most sensors “black” on Control Panel screen), the behind ear locations can be used as alternative Reference locations.

Swap the Comfort Pads with the Reference Sensors as shown. Also check that all of the sensor pads are damp. Use the Reference Sensors location which gives best overall performance.

2.6 EmoEngine Status Panel

The top pane of EPOC Control Panel is known as the EmoEngine Status Pane. This pane displays indicators that provide real-time information about EmoEngine status and EPOC Neuroheadset sensor contact quality. It also exposes user profile management controls.



Figure 2 EmoEngine Status Pane

Engine Status

By default, the Control Panel will automatically connect to the EmoEngine when launched. In this mode, it will automatically discover attached USB transceivers and Emotiv EPOC Neuroheadsets.

There are four status indicators:

System Status: A summary of the general EmoEngine status.

System Up Time: The timestamp (in seconds) attached to the most recently received EmoState event. Generally, this corresponds to the length of time that the EmoEngine has been running with an EPOC Neuroheadset connected to the USB receiver.

Wireless Signal: This displays the quality of the connection between the EPOC Neuroheadset and the Emotiv wireless USB receiver connected to your machine. If you have not yet connected, the display will show “No Signal”. If the wireless signal strength drops too low (displayed as “Bad” or “No Signal”) then no detection results will be transmitted and the Control Panel will disable its detection suite UI controls.

Battery Power: Displays an approximation of the remaining charge in an EPOC Neuroheadset’s built-in battery.

2.7 User Status

Use the controls in this section to manage user profiles and assign a specific user (via their profile) to a specific attached EPOC Neuroheadset. Although the EmoEngine supports up to two simultaneously connected EPOC Neuroheadsets, EPOC Control Panel only displays status information and detection results for a single EPOC Neuroheadset at a time. The Headset combo box allows you to specify the EPOC Neuroheadset that has the current “focus.” In Figure 3 the User Status controls tell us that the Control Panel is currently displaying information for the user with profile “Emotiv User”, wearing EPOC Neuroheadset “0.” If you wish to use multiple headsets you can switch between them using the “Headset” drop-down box, or you can launch a second instance of EPOC Control Panel and select a different headset for each instance.

Note: neuroheadset numbering begins with 0 and not 1 as you might expect. Other operations that are supported include adding, saving, removing, and switching between user profiles. Note: EPOC Control Panel will automatically save user profile data to disk when it exits so it is generally not necessary to use the Save Profile button.

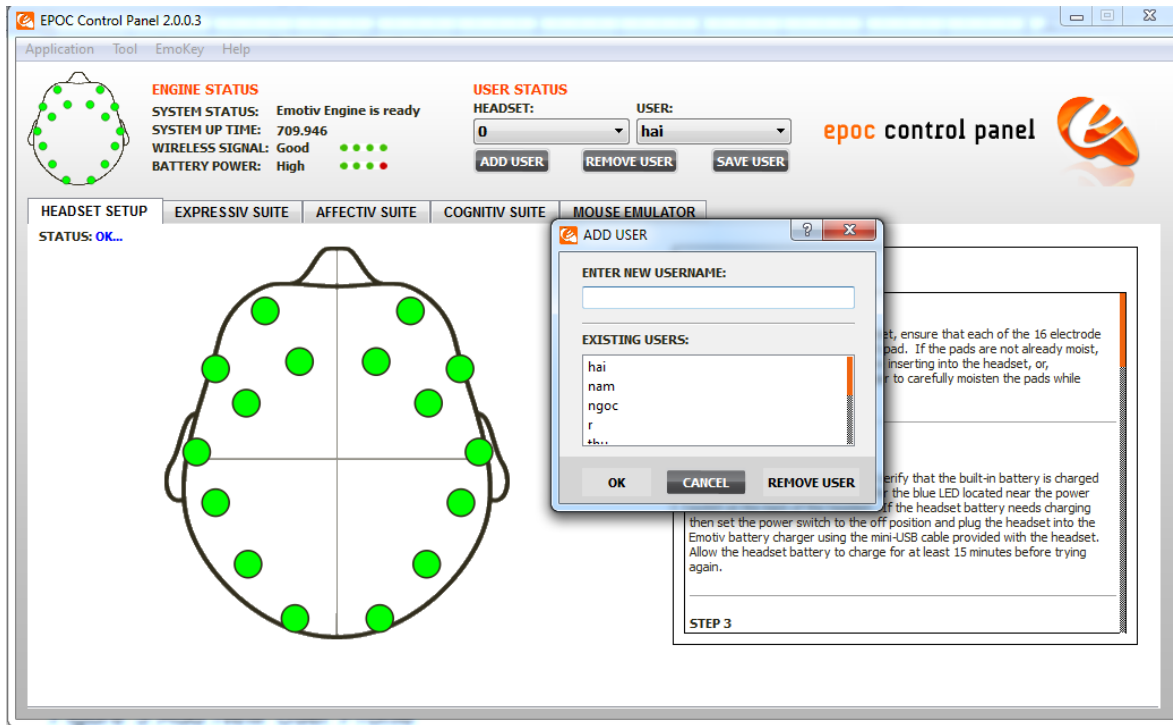

Figure 3 Add New User Profile

2.8 Sensor Contact Quality Display

Accurate detection results depend on good sensor contact and signal quality. This display is a visual representation of the current contact quality of the individual EPOC Neuroheadset sensors. The display is a smaller copy of the contact quality visualization found on the Control Panel's Neuroheadset Setup tab. Please see Section 3.0 for more information about fitting the EPOC Neuroheadset and achieving good signal quality.

2.9 Neuroheadset Set-Up

The Headset Setup panel is displayed by default when starting EPOC Control Panel. The main function of this panel is to display contact quality feedback for the EPOC Neuroheadset's sensors and provide guidance to the user in fitting the EPOC Neuroheadset correctly. It is important for the user to achieve the best possible contact quality before proceeding to the other EPOC Control Panel tabs. Poor contact quality will result in poor Emotiv detection quality, although the EPOC will continue to perform moderately well with a small number of missing or lower quality sensors.

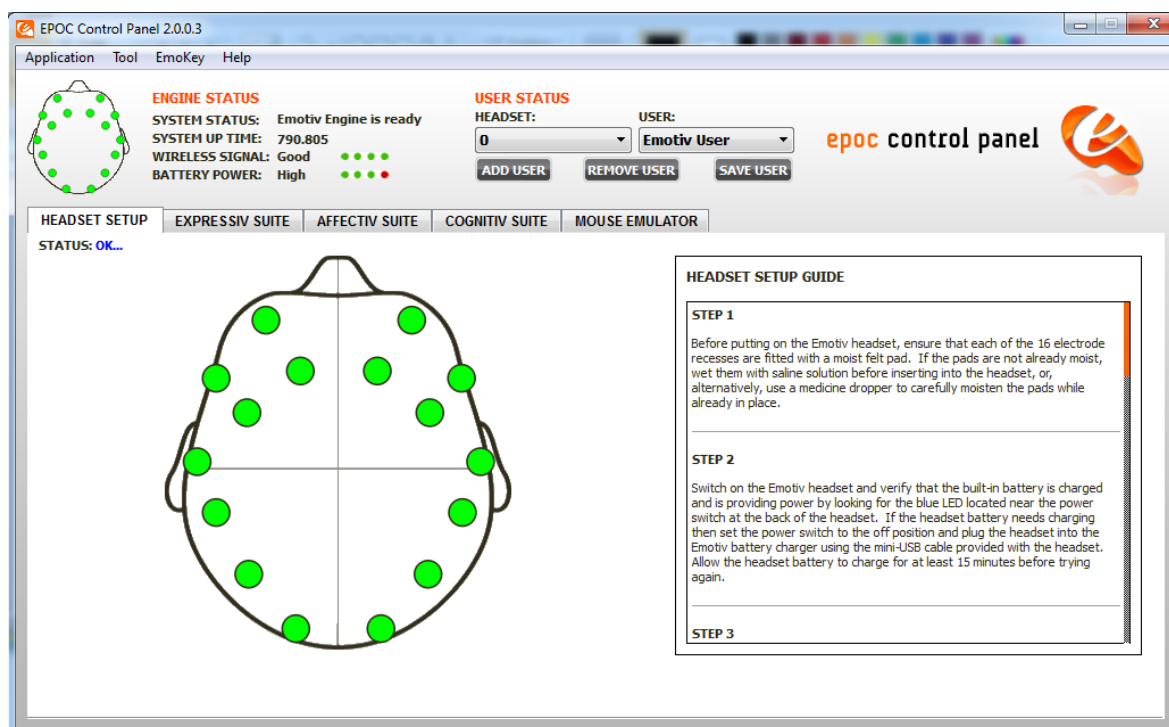

Figure 4 Neuroheadset Setup Panel

The image on the left side of the panel is a representation of the sensor locations when looking down from above onto the user's head. Each circle represents one sensor and its approximate location when wearing the neuroheadset. The color of the sensor circle is a representation of the contact quality. To achieve the best possible contact quality, all of the sensors should show as green.

Other sensor colors indicate:

Black: No signal (Not Acceptable)

Red: Very poor signal (Not Acceptable)

Orange: Poor signal

Yellow: Fair signal

All Green: Ideal signal

Green + Some Yellows: Acceptable

Green + Black and/or Orange/Red: Not Acceptable (EPOC may continue to function with several black or red sensors however many detections will be disabled and others will be less reliable).

The setup procedure used to achieve good contact quality is outlined below. Only after the EPOC Neuroheadset sensor contact quality has been maximised, should you move on to other EPOC Control Panel tabs.

3.0 Achieving Good Signal Quality

STEP 1: Before putting on the EPOC Neuroheadset, ensure that each of the 16 electrode sockets are fitted with a sensor unit with a moist felt pad. If the pads are not already moist, wet them with saline solution before inserting into the neuroheadset using the procedure outlined in Section 2.2, above.

STEP 2: Switch on the EPOC Neuroheadset, and verify that the built-in battery is charged and is providing power by looking for the blue LED located near the power switch at the back of the neuroheadset. If the neuroheadset battery needs charging, set the power switch to the off position, and plug the neuroheadset into the Emotiv battery charger using the mini-USB cable provided with the EPOC Neuroheadset, or alternatively through a spare USB socket on your PC using a USB-MiniB cable. Allow the EPOC Neuroheadset battery to charge for at least 15 minutes before trying again. A fully discharged neuroheadset will take up to 6 hours to reach full charge.

STEP 3: Verify that the *Wireless Signal* reception is reported as “Good” by looking at the *Engine Status* area in the EmoEngine Status Pane (described in Section 2.6). If the *Wireless Signal* status is reported as “Bad” or “No Signal”, then make sure that the Emotiv Wireless USB Receiver is inserted into a USB port on your computer and that the bright LED and dim flickering data transfer LED on the top half of the receiver are visible. If the LED is blinking slowly or is not illuminated, then remove the receiver from the computer, reinsert it, and try again. Remove any metallic or dense physical obstructions located near the receiver or the EPOC Neuroheadset, and move away from any powerful sources of electromagnetic interference, such as microwave ovens, large motors, or high-powered radio transmitters. You may also attach the USB Transceiver to the end of a USB extension cable in order to position the Transceiver prominently in the space, away from potential sources of interference such as monitors and wireless routers.

STEP 4: Put on the EPOC Neuroheadset by gently pulling apart the headband and lowering the sensor arms onto your head from the top down, near the rear of the skull. Next, slide the neuroheadset forward until the sensors closest to the neuroheadset pivot points are located directly

above your ears and as close to your hairline as possible. Adjust the fit so that the rectangular compartments at the front ends of the headband sit comfortably just above and behind your ears. Tilt the neuroheadset so that the two lowest, front-most sensors are symmetric on your forehead and positioned about 2 to 2.5 inches above your eyebrows. Finally, check that all sensors are touching your head and, if not, then fine tune the neuroheadset fit by gently sliding the neuroheadset in small increments until an ideal fit has been achieved.

STEP 5: Starting with the two sensors just above and about an inch (25mm) behind your ears (these are reference sensors for which good contact with your scalp is essential), adjust the sensors so they make proper contact with your scalp (i.e. show green on the contact quality display). If the indicators are:

Black: Check that the sensor has a felt pad fitted. Check that the felt pad is pressing firmly against your scalp. Then try re-moistening the felt pad. If problems persist, this may indicate a problem with the EPOC Neuroheadset.

Yellow, Orange, or Red: The sensor has not established a good conductive path with your scalp. Check that the felt pad is making comfortable, yet firm, contact with your scalp. Try shifting the neuroheadset slightly back and forth on your head, or press gently on the troublesome sensor to improve contact. If the contact is adequate, ensure that the felt pad is moist. If the sensor's indicator color becomes lighter, the signal quality is improving. If the sensor's indicator color is getting darker the signal quality is deteriorating. If problems still persist, try parting the hair in the vicinity of the electrode so the felt pad touches your scalp.

See the **TROUBLESHOOTING GUIDE** at the end of this manual for more details on how to deal with poor contact.

STEP 6: Repeat Step 5 for each of the remaining sensors until all of the sensors have adequate contact quality (i.e. are predominantly showing green).

If at any time the reference sensors (located just above and behind your ears) no longer have a good connection (i.e. they show RED, and most or all of the other sensors turn BLACK), immediately restore these sensors to green before proceeding further. Try the alternative reference locations behind the ears if you continue to have difficulty with the primary locations (Section 2.5).

3.1 Expressiv™ Suite

The Expressive Suite details the facial expressions and non-verbal communication capabilities of the EPOC Neuroheadset. No longer do you need to push a button or type in emoticons into a chat dialog box during game-play. Now, if you want to show facial expressions on your avatar, you need only perform them while wearing the EPOC neuroheadset and you can display these expressions on the face of your avatar.



Figure 5 Expressiv Suite

3.1.1 Understanding the Expressiv Suite Panel Display

On the left-hand side of the *Expressiv Suite* panel is a simple avatar. The avatar will mimic your facial expressions, in camera view (i.e. not mirrored). The facial expressions which are displayed include horizontal eye movements to the left and right, normal eye blinks, left and right sided winks, clenching the teeth and smiling.,

On the right-hand side of the panel is the *Sensitivity* panel. This panel is explained further in the following section.

3.1.2 Sensitivity Adjustment Panel

The Control Panel offers sensitivity adjustments for the Expressiv Suite detections. This is controlled through sliders to the right of avatar.

For each facial expression, check the performance of the detection. If you feel that the Expressiv detection is not responding readily to a particular expression, then increase the sensitivity for that expression. If you feel that it is too easy to trigger a particular expression, or you are seeing “false positive” expressions, then decrease the sensitivity for that expression. Sensitivity can be increased or decreased by moving the sensitivity slider to the right or left, respectively.



Figure 6 Expressiv Suite Sensitivity Adjustment Panel

3.1.3 EmoKey

EmoKey links the Emotiv technology to your applications by easily converting detected events into any combination of keystrokes. EmoKey is a nonintrusive, lightweight, background process that runs behind your existing games or applications. EmoKey lets you create mappings that define how detections are converted to keystroke combinations. Your mappings can then be saved and shared so you can use mappings that your friends have created for your favorite games and software. EmoKey mappings can be as simple as linking the Expressiv smile detection to text characters such as ":", so that chat applications instantly know when you smile.

Configuring EmoKey

To configure a facial expression to EmoKey, select the expression you wish to link and click on the *Key* button next to the Facial Expression description. This will bring up a Configuration Dialogue box as shown in Figure 7. Type into the text box, the specific keystroke(s) you wish to send. You can also make the facial expression send a continuous string of keys by checking the *Hold the key* box.

There are also options to further configure the *Key hold time* and *Key trigger delay time*. Once you are satisfied with the settings, click the *Apply* button.

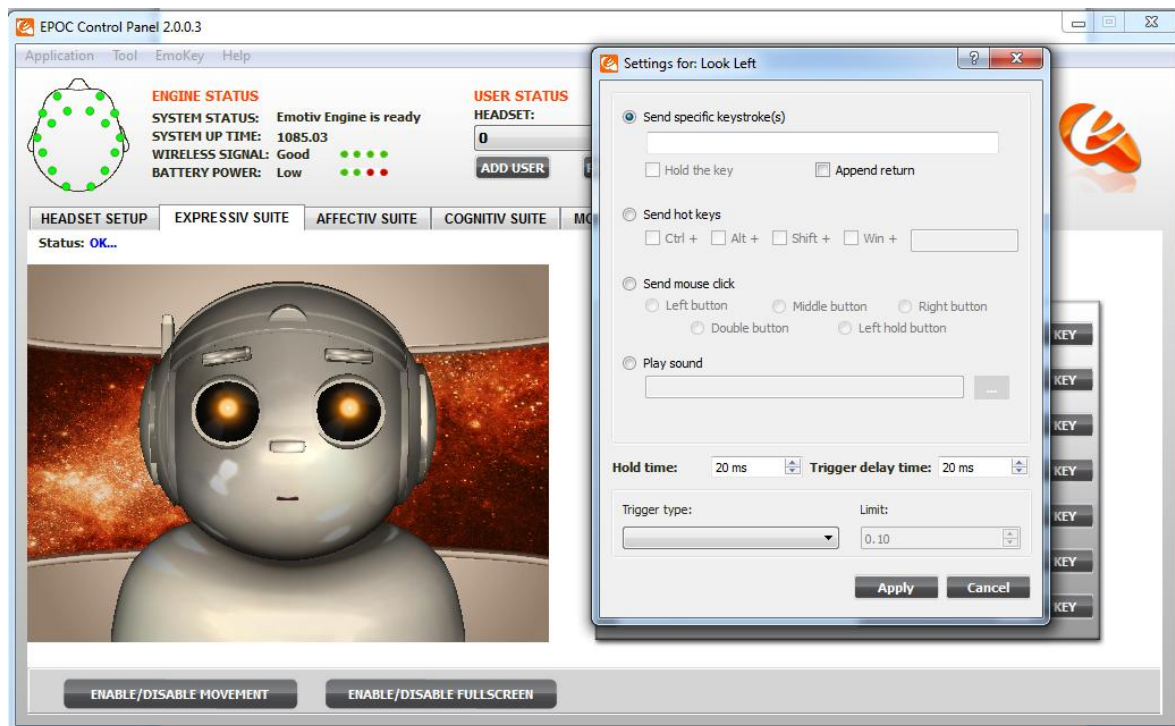

Figure 7 Emokey Configuration Dialogue Box

Once EmoKey is activated, the keystroke(s) allocated to the facial expression will be marked in the corresponding box. An orange highlight will flash in the box to the right of the facial expression description that is being triggered. Only actions that have keystrokes allocated will be sent to an application window that is active. This is shown in Figure 8, where a smile triggers the keystroke “:).” To make this happen, enter the desired keystrokes and carefully choose the trigger condition. Note the some Expressions have the option “occurs” while others have “is equal to”, “is greater than”, “is less than”. Select “is greater than” and type “0.2” into the condition box, which will trigger your smile keystrokes whenever a Smile greater than 20% of full scale is detected.



Figure 8 EmoKey - Smile detection linked to “:).”

You can manage and save Emokey mappings using the EmoKey menu at the top of the Control Panel Window. Mappings can be loaded or saved and you can also temporarily suspend EmoKey activity using the Activate tick selector in the EmoKey menu.

3.2 Affectiv™ Suite

The Affectiv Suite of functions measures and displays a wide range of subjective emotional responses. Levels of interest, excitement, and engagement that you experience in a cyber environment are translated into graphical measurements on the control panel dials, and in some cases, into dynamically changing environments within games you are playing.

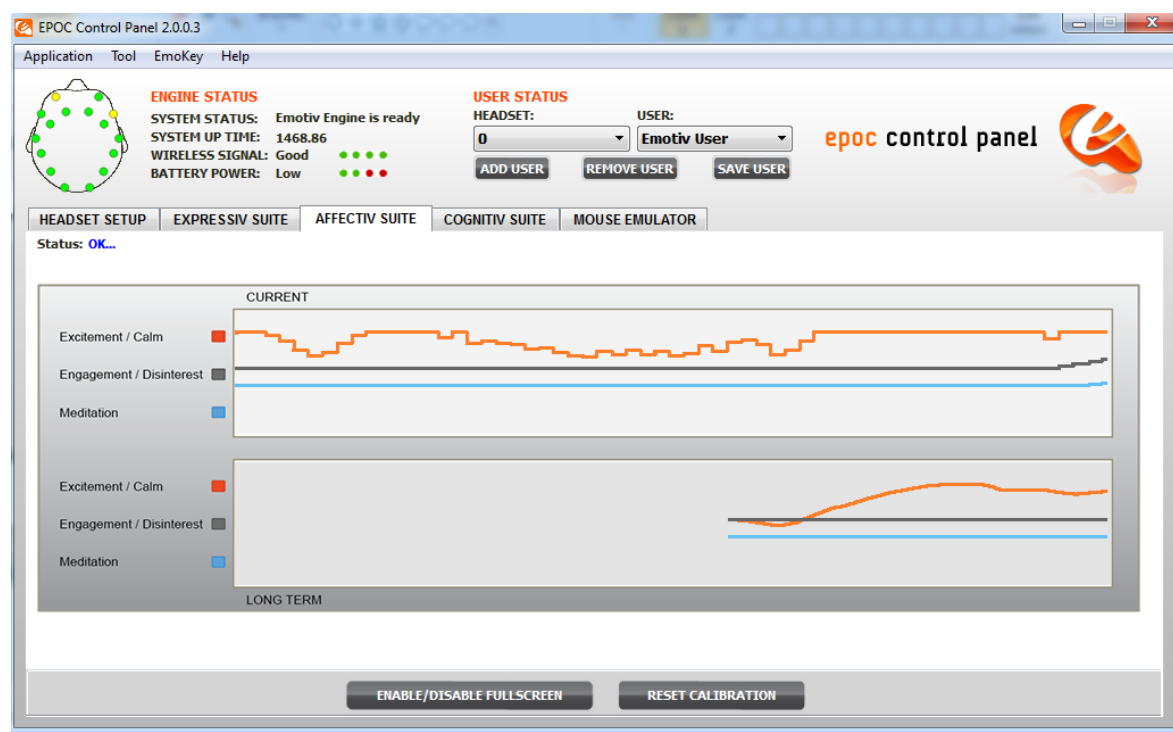

Figure 9 Affectiv Suite Panel

3.2.1 Affectiv Suite Introduction

The Affectiv Suite reports real time changes in the subjective emotions experienced by the user. EPOC Control Panel currently displays three short-term and three long-term Affectiv detections: Meditation, Engagement and Excitement. Emotions related to Engagement are alertness, vigilance, concentration, stimulation, interest.

Examples of engaging video game events that result in a peak in the detection are difficult tasks requiring concentration, discovering something new, and entering a new area. Deaths in a game often result in bell-shaped transient responses. Shooting or sniping targets also produce similar transient responses. Writing something on paper or typing typically increase the engagement score, while closing the eyes almost always rapidly decreases the score.

3.2.2 Understanding the Affectiv Panel Display

The *Affectiv Suite* panel contains two graph panes displaying the three Affectiv detections instantaneous and long-term average time scales. The top chart is configured to plot 30 seconds of data for the *Engagement*, *Meditation* and *Instantaneous Excitement* detections. The bottom chart defaults to display 5 minutes worth of data for the *Long-Term Engagement*, *Meditation* and *Excitement* detections. The values that are plotted on the graphs are the output scores returned by the Affectiv detections.

3.2.3 Affectiv Suite Detection Details

Scoring behavior: In general, the greater the increase in physiological arousal the greater the output score for the detection.

Instantaneous Excitement is experienced as an awareness or feeling of physiological arousal with a positive value. Excitement is characterized by activation in the sympathetic nervous system which results in a range of physiological responses including pupil dilation, eye widening, sweat gland stimulation, heart rate and muscle tension increases, blood diversion, and digestive inhibition. The Instantaneous Excitement detection is tuned to provide output scores that more accurately reflect short-term changes in excitement over time periods as short as several seconds.

Related emotions: titillation, nervousness, agitation

Long-Term Excitement is experienced and defined in the same way as Instantaneous Excitement, but the detection is designed and tuned to be more accurate when measuring changes in excitement over longer time periods, typically measured in minutes.

Engagement is experienced as alertness and the conscious direction of attention towards task-relevant stimuli. It is characterized by increased physiological arousal and beta waves (a well-known type of EEG waveform) along with attenuated alpha waves (another type of EEG waveform). The opposite pole of this detection is referred to as “Boredom” in EPOC Control Panel and the Emotiv API; however, please note that this does not always correspond to a subjective emotional experience that all users describe as boredom.

Related emotions: alertness, vigilance, concentration, stimulation, interest Scoring behavior: The greater the attention, focus and cognitive workload, the greater the output score reported by the detection. Examples of engaging video game events that result in a peak in the detection are difficult tasks requiring concentration, discovering something new, and entering a new area. Deaths in a game often result in bell-shaped transient responses. Shooting or sniping targets also produce similar transient responses. Writing something on paper or typing typically increase the engagement score, while closing the eyes almost always rapidly decreases the score.

3.3 Cognitiv™ Suite

The *Cognitiv Suite* panel uses a virtual 3D cube to display an animated representation of the Cognitiv detection output.

3.3.1 Cognitiv Suite Introduction

The Cognitiv detection suite evaluates a user's real time brainwave activity to discern the user's conscious intent to perform distinct physical actions on a real or virtual object. The detection is designed to work with up to 13 different actions: 6 directional movements (push, pull, left, right, up and down) and 6 rotations (clockwise, counter-clockwise, left, right, forward and backward) plus one additional action that exists only in the realm of the user's imagination: disappear.

Cognitiv allows the user to choose up to 4 actions that can be recognized at any given time. The detection reports a single action or neutral (i.e. no action) at a time, along with an action power which represents the detection's certainty that the user has entered the cognitive state associated with that action.

Increasing the number of concurrent actions increases the difficulty in maintaining conscious control over the Cognitiv detection results. Almost all new users readily gain control over a single action quite quickly. Learning to control multiple actions typically requires practice and becomes progressively harder as additional actions are added. Although EPOC Control Panel allows a user to select up to 4 actions at a time, it is important that each user masters the use of the Cognitiv detection one action at a time, only increasing the number of concurrent actions after he or she has first gained confidence and accuracy with a lower number of actions.

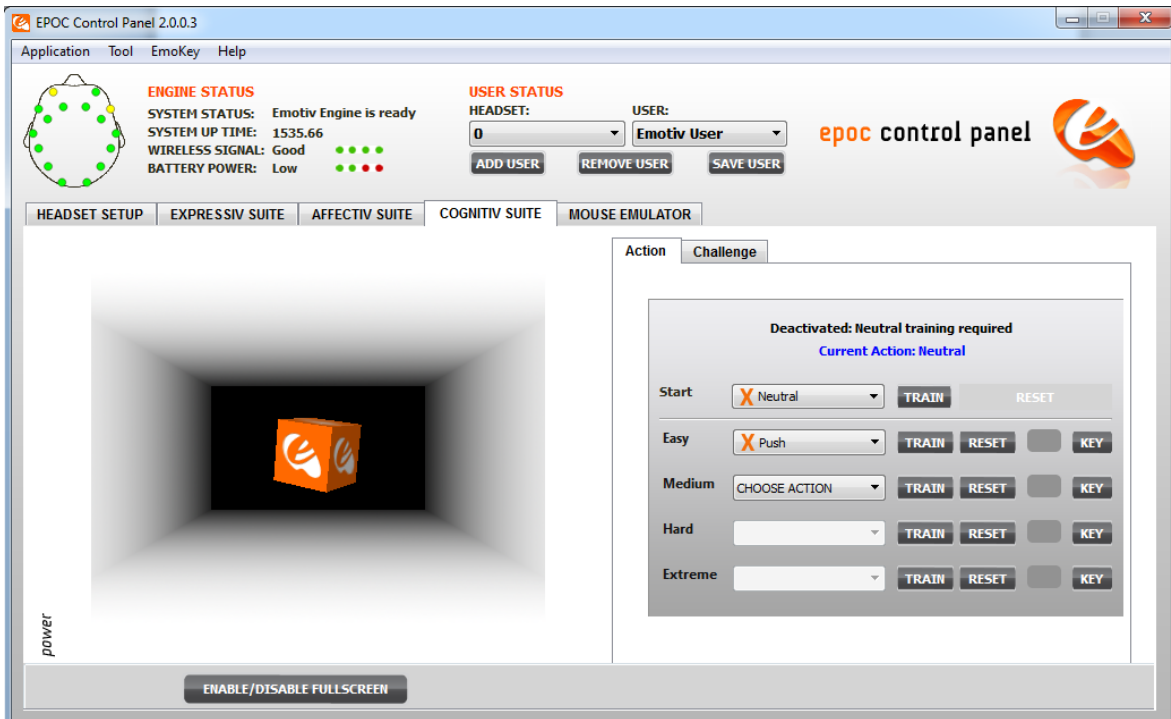

Figure 10 Cognitiv Suite Panel

3.3.2 Understanding the Cognitiv Panel Display

The *Cognitiv Suite* panel uses a virtual 3D cube to display an animated representation of the Cognitiv detection output. This 3D cube is also used to assist the user in visualizing the intended action during the training process. The *Power* gauge to the left of the 3D display is an indicator of the “action power”, or relative certainty that the user is consciously visualizing the current action.

This information to the right displays the current state of the Cognitiv detection and allows the user to define the current set of actions. In order to enable the Cognitiv detection, each chosen action, plus the Neutral action must first be trained. For more information about the training process please refer to Section 3.3.3 below.

A green checkmark is used to indicate that the corresponding action has been trained; an orange X indicates a lack of training data. Remember, in order for the Cognitiv detection to be activated, all actions, plus Neutral (the user’s background mental state) must be trained.

Use the drop down selection menu to modify the number and type of enabled actions.

3.3.3 Cognitiv Training

The Cognitiv training process enables the EmoEngine to analyze your brainwaves and develop a personalized signature which corresponds to each particular action, as well as the background state, or “neutral”. As the EmoEngine learns and refines the signatures for each of the actions, as well as neutral, detections become more precise and easier to perform.

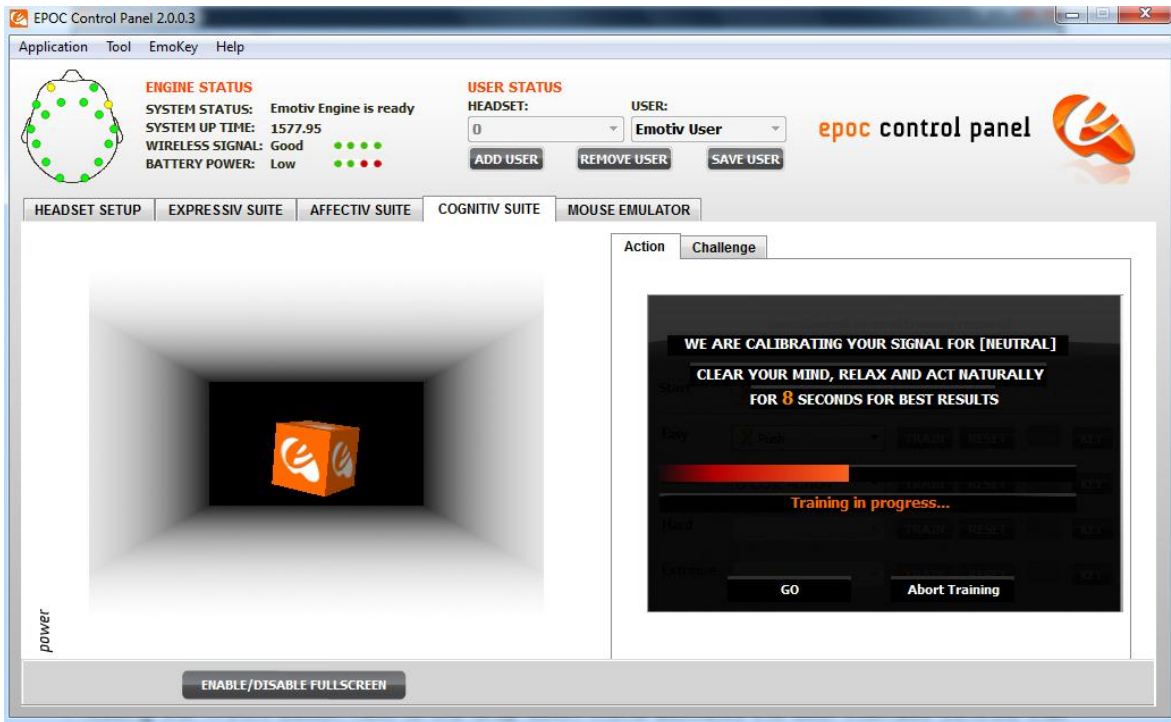

Figure 11 Cognitiv Neutral Training in action

Pressing the *TRAIN* button next to the drop down menu activates the user interface controls that support the Cognitiv training process. The training process consists of three steps:

First, train a neutral state. Neutral training must be completed first before any actions can be trained and activated. To train neutral, there is nothing in particular that you need to do. Simply relax, act natural and clear your mind. Press the *TRAIN* button to bring up the training screen and press *GO* when you are ready. A progress bar will appear as your brainwaves are observed. Once training is complete, you will be asked to accept or reject the training session by pressing *YES* or *NO*. Once you accept, you will be automatically returned to the Cognitiv Panel Display.

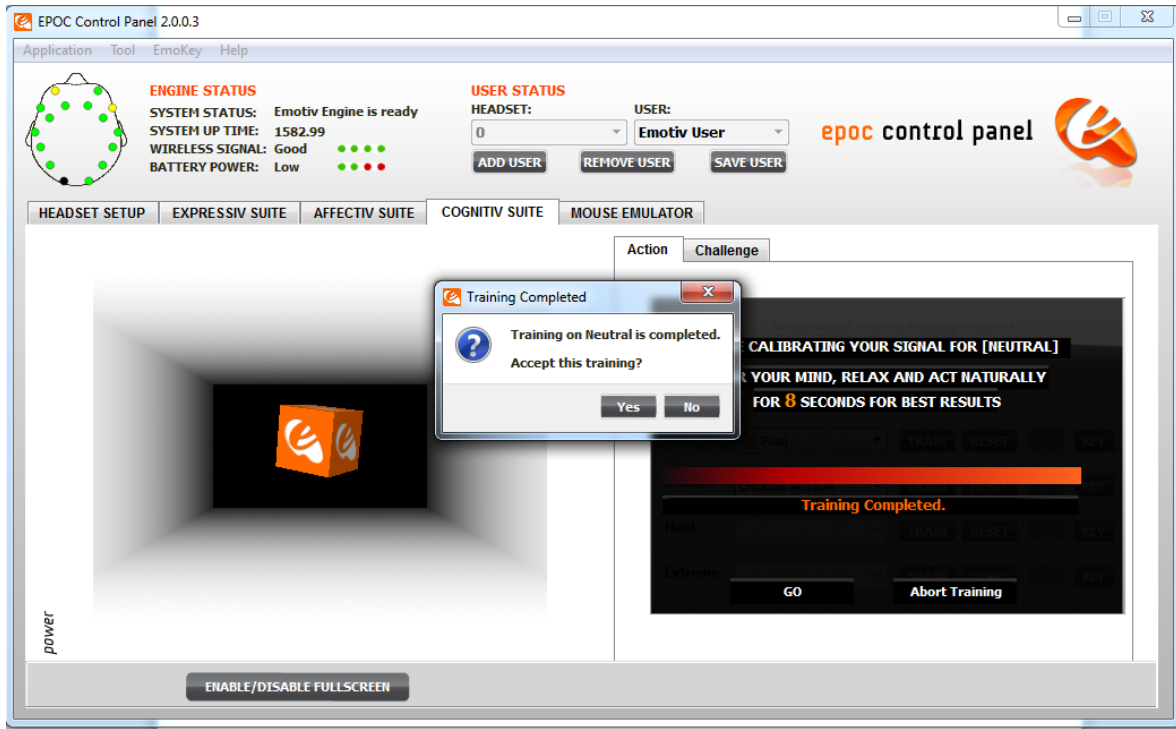

Figure 12 *Accepting a Training Session*

When you are ready to begin imagining or visualizing an action you wish to train, select the action from the dropdown list. Actions that have already been trained are paired with a green checkmark; actions with no training data are paired with an orange X.

During the training process it is very important to maintain your mental focus for the duration of the training period (currently 8 seconds). Physical gestures, such as pushing an imaginary object with one hand, may be used to heighten your focus on the intended action, but are not required. You should also refrain from making substantial head movements or dramatic facial expressions during the training period, as these actions can interfere with the recorded EEG signal.

Initially, the cube on screen will not move, as the system has not yet acquired the training data necessary to construct a personalized signature for the current set of actions. After Neutral and each enabled action have been trained at least once, the Cognitiv detection is activated and the cube will respond to the Cognitiv detection, and your mental control, in real time.

Some users will find it easier to maintain the necessary mental focus if the cube is automatically animated to perform the intended action as a visualization aid during training. If you think you will benefit from this, then you may select the *Animate cube according to training action* checkbox. Otherwise, the cube will remain stationary or, if you have already supplied training data and the detection is active, will be animated by the current detection results for the action being trained, while you supply new training data.

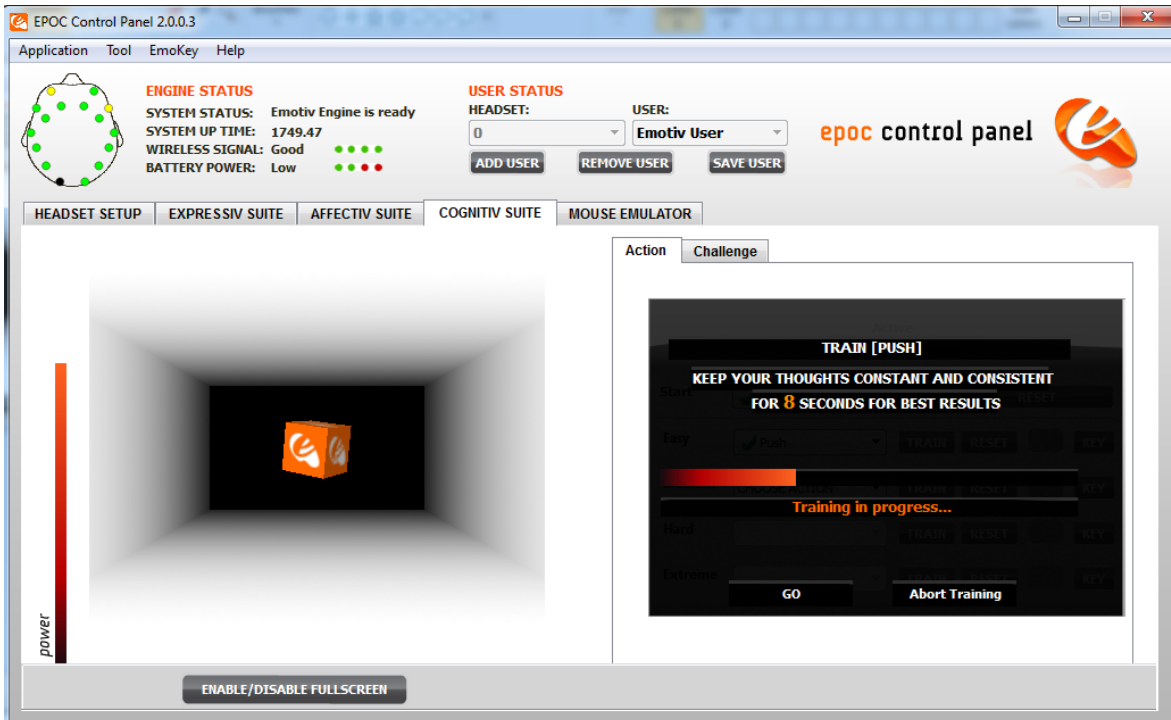

Figure 13 Cognitiv training of push with animate cube according to training action selected

Finally, you are prompted to accept or reject the training recording. Ideal Cognitiv detection performance is typically achieved by supplying consistent training data (i.e. a consistent mental visualization on the part of the user) across several training sessions for each enabled action. The ability to reject the last training recording allows you to decide whether you were able to remain mentally focused on the appropriate action during the last training session. Alternatively, you may press the *Abort Training* button to abort the training recording if you are interrupted, become distracted, or notice problems with the EPOC Neuroheadset contact quality indicators during the recording. A training session is automatically discarded if the wireless signal strength or EEG signal quality is poor for a significant portion of the training period. A notification will be displayed to the user if this has occurred.

3.3.4 Training Neutral

The Neutral “action” refers to the user’s passive mental state; one that isn’t associated with any of the selected Cognitiv actions. While training Neutral, you should enter a mental state that doesn’t involve the other Cognitiv actions. Typically this means engaging in passive mental activities such as reading or just relaxing. However, to minimize “false-positive” Cognitiv action results (i.e. incorrect reporting of unintended actions), it may also be helpful to emulate other mental states and facial expressions that are likely to be encountered in the application context and environment in

which you'll be using Cognitiv. For many users, providing more Neutral training data will result in better overall Cognitiv performance.

Neutral training must be completed first before any actions can be trained and activated.

3.3.5 Clear Training Button

Occasionally, you may find that a particular trained action doesn't work as well as it once did. This may indicate that the training data used to construct your personalized Cognitiv signature was "contaminated" by a more recent, inconsistent training session or that some characteristics of your brainwaves have changed over time. It may also happen that you wish to change the mental imagery or technique that you associate with a particular action. In either situation, you can use the *RESET* button to delete the training data for the selected action. Keep in mind that doing so will disable the Cognitiv detection until new training data has been recorded for this action.

3.3.6 Cognitiv Tips

Mental dexterity with the Cognitiv Suite is a skill that will improve over time. As you learn to train distinct, reproducible mental states for each action, the detection becomes increasingly precise. Most users typically achieve their best results after training each action several times. Overtraining can sometimes produce a decrease in accuracy –although this may also indicate a lack of consistency and mental fatigue. Practice and experience will help determine the ideal amount of training required for each individual user.

If it becomes hard for you to return to neutral (i.e. to stop the cube from moving) you should try refreshing your mental state by momentarily shifting your focus away from the screen and relaxing. It is easy to become immersed in the experience and to have the Cognitiv actions at the "front of your mind" while trying to be neutral.

Successful training relies on consistency and focus. For best results, you must perform the intended action continuously for the full training period. It is common for novice users to become distracted at some point during the training period and then mentally restart an action, but this practice will result in poorer results than training with a mental focus that spans the entire training period.

A common mistake is for users to attempt to "force" a particular action, usually by straining head, jaw, tongue or neck muscles or squinting. These actions will just disguise a poor signature and make the detection difficult to duplicate. Try to relax and use your imagination to visualize the intended action, especially during training. Keep your eyes open if possible so you can see the visual feedback on screen. Actions will occur most reliably if the user relaxes and lets the action happen, in a similar way to moving a limb or remembering a tune.

A short latency, of up to two seconds, in the initiation and cessation of the cube's animated action on screen is typical.

3.3.7 EmoKey for Cognitiv Actions

EmoKey links the Emotiv technology to your applications by easily converting detected events into any combination of keystrokes. EmoKey is a nonintrusive, lightweight, background process that runs behind your existing games or applications. EmoKey lets you create mappings that define how detections are converted to keystroke combinations. Your mappings can then be saved and shared so you can use mappings that your friends have created for your favorite games and software. EmoKey can be as complex as linking a "lift" command to a sequence of keystrokes that trigger a levitation spell in a game.

To configure a Cognitiv action to EmoKey, select the action you wish to link and click on the **KEY** button to the far right of the *Cognitiv Panel Display*. This will bring up a Configuration Dialogue box as shown in Figure 7. Type into the text box, the specific keystroke(s) you wish to send. You can also make the facial expression send a continuous string of keys by checking the *Hold the key* box.

There are also options to further configure the *Key hold time* and *Key trigger delay time*. Once you are satisfied with the settings, click the *Apply* button.

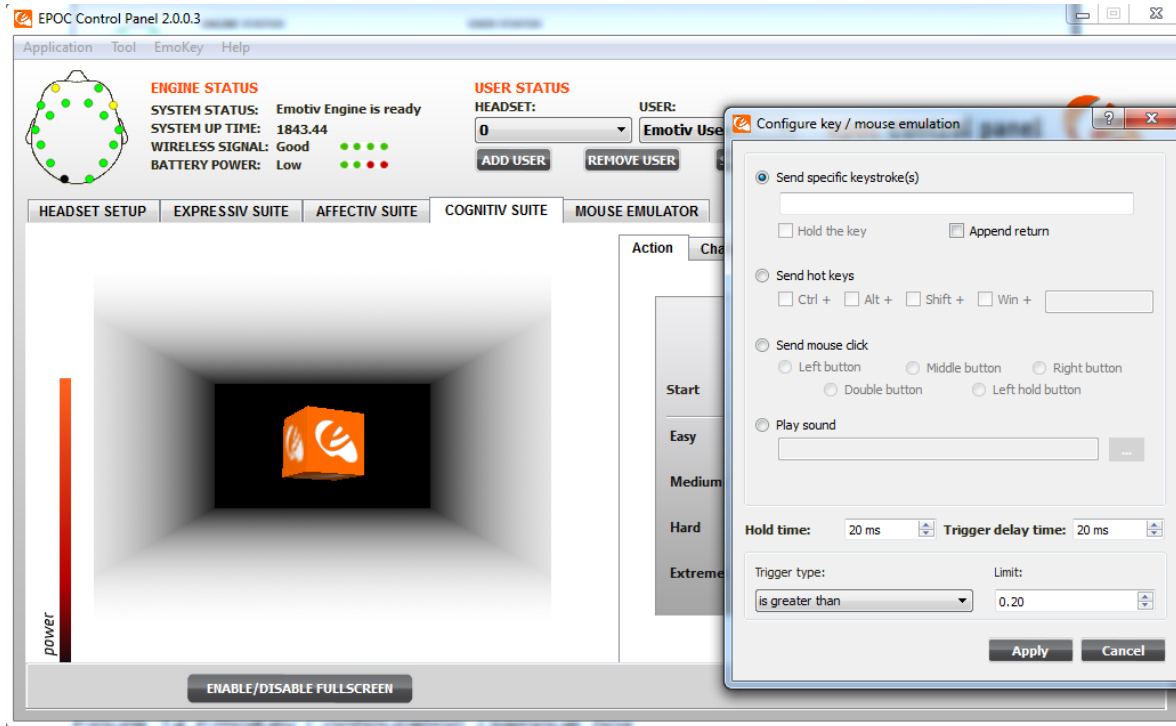

Figure 14 EmoKey Configuration Dialogue box

Once EmoKey is activated, the keystroke(s) allocated to the Cognitiv action will be marked in the corresponding box. An orange highlight will flash in the box to the right of the description of the action being triggered. Only actions that have keystrokes allocated will be sent to an application window that is active. This is shown in Figure 14, where a pull triggers the keystroke "Z". Make

sure you set the condition to “is greater than” and enter 0.2 into the condition box at the lower right to trigger the “Z” key whenever the action strength exceeds 20% of full scale.

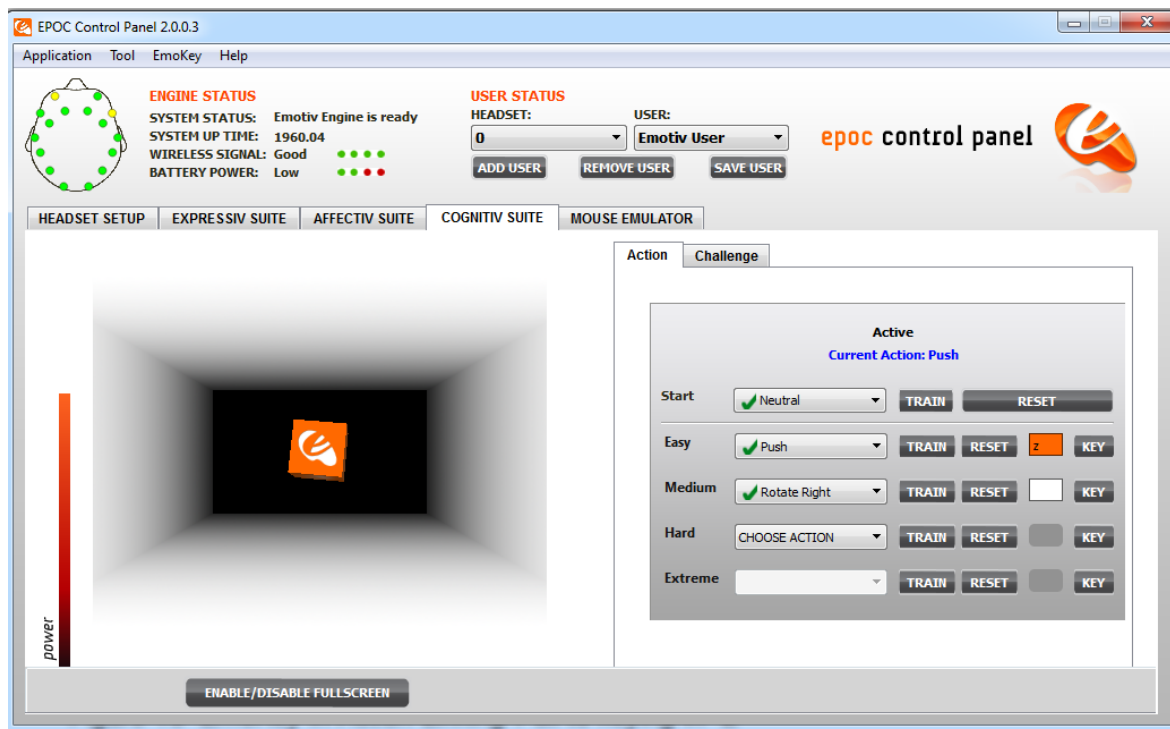

Figure 15 EmoKey in Action Linking Pull to keying in “Z”

3.3.8 Cognitiv Challenge

The Challenge tab allows you to play with cube model and submit your score to emotiv’s website

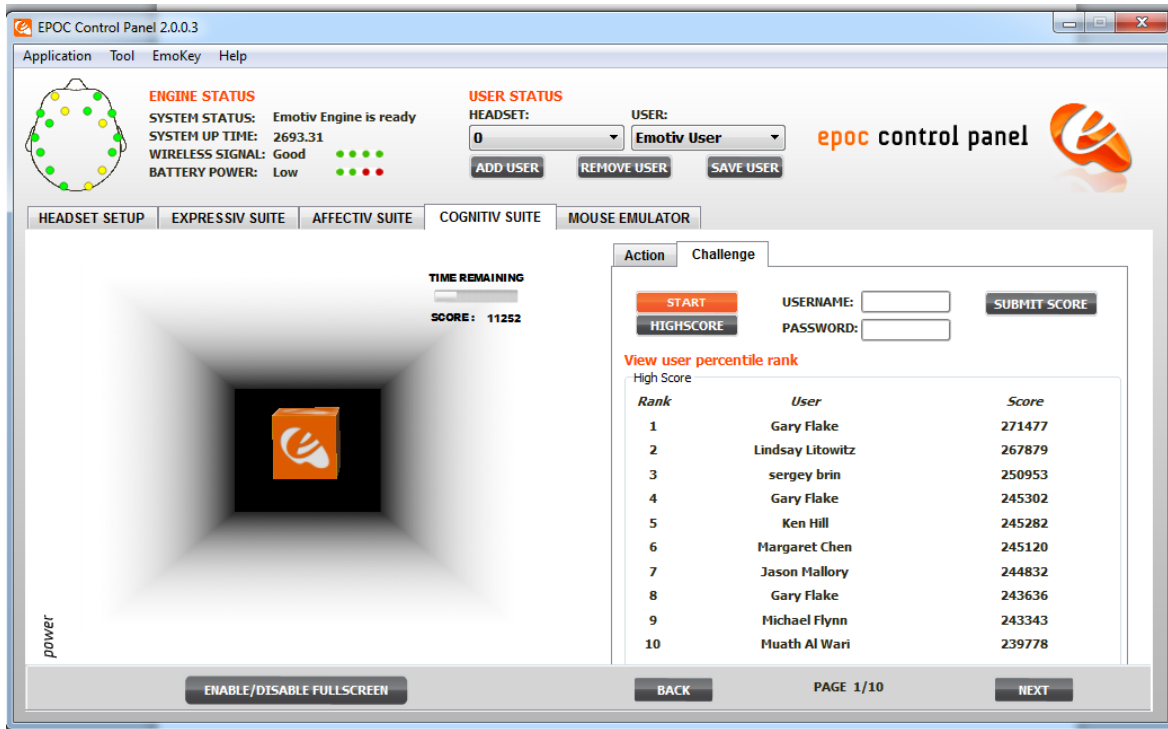

Figure 16 Cognitiv Challenge Tab

You click to START button to begin playing. After you finish playing, you can click to SUBMIT SCORE to submit score to emotiv's website.

The HIGHSCORE button displays the highest score

3.4 Mouse Emulator

The EPOC neuroheadset comes with a built-in 2-axis gyroscope which enables a range of additional functions. One possible use is mouse cursor control.

3.4.1 Understanding the Mouse Emulator Tab

The Mouse Emulator Tab in the EPOC Control Panel allows you to activate the neuroheadset's gyroscope and link it to the control of your computer's mouse cursor.

The left side of the Mouse Emulator Tab provides a visual representation of the gyroscope's relative position. The right side of the Mouse Emulator Tab provides the controls to activate and deactivate this feature along with a slider bar to make sensitivity adjustments.



Figure 17 Mouse Emulator Tab

3.4.2 Mouse Emulator Controls

To enable this feature, click on the *Activate* button. Your mouse will immediately respond based on the movement of your head. Simply turn your head from left to right, up and down. You will also notice the orange indicator dot move in accordance with the movement of your head/gyroscope. The *Mouse Sensitivity* slider allows you to adjust the sensitivity of the gyroscope when controlling your mouse cursor. The *Reset* button allows you to re-centre your position.

To deactivate this feature, use your head movement to move your cursor to the *Deactivate* button and left mouse click, or Press CTRL+SHIFT+M.

4.0 Trouble Shooting and Help

Transceiver Dongle lights don't work (Should see either one slow flashing LED – if unpaired – or one bright and one dim LED – if paired).

- Try different USB port, different computer.
- Check other USB equipment works in same port
- Possible LED failure – carry on regardless

Transceiver Dongle not recognized (USB “ding” on insertion, stream of Hardware Identifier strings observed on first installation)

- Use only on XP, Window Vista and Windows 7 and virtual Windows XP/Vista/7 machines in Mac OS X
- Check Device Manager list as Dongle is inserted and removed.
- Try different USB port, different computer.
- If Control Panel is running it will ask for User Profile selection when the Transceiver Dongle is recognized, whether the neuroheadset is paired or not

Does not pair (Transceiver Dongle switches from single slow flashing LED to one bright & one dim LED if correctly paired)

- Check for blue LED on neuroheadset (recharge neuroheadset if absent).
- Hold neuroheadset very close to USB, switch off and on.
- Unplug and replace Transceiver Dongle in USB port, repeat pairing attempt
- Obtain a USB male - USB female extension cable and plug into the PC. Attach the Transceiver Dongle to the extension cable and position in a prominent location away from your PC, monitor, wireless router and other sources of radio-frequency interference.
- Turn off or disconnect other wireless and Bluetooth devices in the area to isolate possible causes

Weak wireless connection or repeated drop-outs (expected range 3-5 metres within line of sight)

- Move closer to the Transceiver Dongle
- Obtain a USB male - USB female extension cable and plug into the PC. Attach the Transceiver Dongle to the extension cable and position in a prominent location away from your PC, monitor, wireless router and other sources of radio-frequency interference.
- Turn off or disconnect other wireless and Bluetooth devices in the area to isolate possible causes
- Turn off neuroheadset, unplug Transceiver Dongle and repeat the pairing exercise

Sensors do not positively lock in place (sensors should click in place as they are rotated a quarter-turn clockwise after insertion into the socket)

- Sensors are made deliberately tight to start with and the locking tabs are slightly deformed to the correct shape during the first fitting. Sometimes the sensors are very tight and the user feels they will not turn further into the socket.
- Take each sensor in turn and use an empty socket in the Hydrator Pack. Forcibly rotate the sensor fully clockwise in the socket until a definite click is felt (use a cloth or tool to hold the sensor if your fingers are easily damaged). Click and unclick the sensor into the socket a few times to complete the process.
- The sensor can now be fitted to the headset, Make sure you feel a distinct catch as you rotate the sensor into the socket and the finger tabs are aligned along the axis of each arm.

All sensors black except RED references (directly below ears on Contact Quality map)

- Start with RUBBER COMFORT PADS in locations directly behind the ears.
- The primary reference sensor locations are behind the head, elevated at about 30 degrees backwards behind the ears (see diagram in main section of this manual)
- Ensure reference sensors and at least one forehead sensor are sufficiently wet
- Ensure all sensors are properly located in the neuroheadset receptacles. They should not spin or fall out when gently moved.

- Try to minimize the amount of hair trapped underneath the reference sensors. The neuroheadset can be wriggled to allow the sensors to pass through the hair, or you can try to displace some of the hair with a pencil or similar.
- Gently press reference sensors onto the head for at least 5 seconds, then release. It may take another 20 seconds or so for the sensors to respond.
- Gently press wet forehead sensor for 5 seconds then release. It may take another 20 seconds or so for the sensors to respond.
- If still no signals, switch reference sensors to the alternate location as follows: remove the RUBBER COMFORT PADS (including the plastic holders) from their location behind the ears. They should twist out just like any of the sensors. Move the felt pads from the usual reference locations and place them in the sockets recently vacated by the RUBBER COMFORT PADS. You can put the COMFORT PADS into the original reference sockets, or leave them out if you prefer. Make sure you don't lose them if you choose to leave them out.
- Make sure the sensors are sufficiently damp and repeat the above procedure, taking care to locate the new reference sensors onto a patch of bare skin on or near the bony lump located just behind the ear flap. Within a few seconds the sensors should come to life, especially if you press gently on some of the other sensors for a few seconds.

One or both of the sensors immediately adjacent to the ears remains black.

- These sensors are located on the main body of the Arm assembly, closest to the arm pivot point. They detect activity in the temporal lobes and are known as T7 (left side) and T8 (right side). A combination of the shape of the arm assembly and the user's head shape (particularly long, narrow heads with relatively flat sides) can sometimes result in these sensors failing to touch the head, being held off by some of the other sensors.
- Check that the sensors are clean and attached properly as per the general comments in the next section
- Check that the sensors are clean and attached properly as per the general
- Remove the RUBBER COMFORT PAD including the plastic holder, from the side or sides where the contact cannot be achieved. The neuroheadset can be worn comfortably without these pads for people with this head shape, and no harm will come to the connector sockets because they are fully enclosed. The change in balance point is usually sufficient to ensure contact occurs.
- In the unlikely event that contact is still impossible to obtain, you can use a longer felt pad or use a cotton ball soaked in saline to fill the gap or replace the felt piece.

One or more sensors remain black or red for every fitting and user

- Check that the sensor is properly located in the socket. It should click firmly in place, the finger tabs should be aligned along the axis of the arm and it should not freely rotate in the socket.
- Check that the sensor is sufficiently damp for operation
- Check that the sensor is applying gentle but positive pressure to your head in this location. When pressed, it should not move inwards. You may find that slightly relocating the neuroheadset settles the sensors into a better location
- Remove the neuroheadset and gently press the felt pad into the sensor. It should protrude by no more than 2mm. It should also feel damp and be free of obstructions.
- Remove the sensor and inspect it. The sensor should have a felt pad on the front side and a domed gold-plated metal plate which is visible from the rear side. The metal plate should be clean and free of obstructions at least across the central third of the domed section in order to make proper contact when inserted.
- Check the socket. Make sure the gold contact plate is clean and there is nothing trapped in the socket which could affect the contact. The gold contacts inside the socket consist of three spring tabs which bend slightly upwards towards the sensor. Make sure they are not bent away, damaged or dirty.
- Swap a different sensor into that location from somewhere that is known to be working. This will eliminate a faulty sensor
- Please contact Customer Service if you cannot resolve this problem and the location seems to be failing for each fitting and all users.

If you have other problems or your problem is not rectified by the above procedures, please check the updated Troubleshooting information, visit our Live Chat Support, initiate a support ticket at www.emotiv.com or email support@emotiv.com for further assistance.