

# User Manual



**ECB1750**  
version 1.0

Dual-Band, Long Range  
Wireless AC1750 Indoor AP/CB

<b>1</b>	<b>Introduction .....</b>	<b>5</b>
1.1	Features and Benefits .....	6
1.2	Package Contents .....	7
1.3	System Requirements .....	8
1.4	Applications .....	8
<b>2</b>	<b>Before you Begin .....</b>	<b>10</b>
2.1	Considerations for Wireless Installation .....	10
2.2	Computer Settings (in Windows XP/Windows 7/Windows 8).....	11
2.3	Computer Settings in Apple Mac OS X.....	15
2.4	Hardware Installation.....	16
<b>3</b>	<b>Configuring Your ECB1750.....</b>	<b>20</b>
3.1	Default Settings .....	20
3.2	Web Configuration.....	21
<b>4</b>	<b>Building a Wireless Network .....</b>	<b>23</b>
4.1	Access Point Mode .....	23
4.2	Client Bridge Mode .....	24
4.3	WDS AP / WDS Station Mode.....	25
4.4	WDS Bridge Mode.....	26
<b>5</b>	<b>Overview.....</b>	<b>27</b>
5.1	Device Status .....	27
5.2	Connections .....	28
5.3	Realtime.....	29
<b>6</b>	<b>Network.....</b>	<b>32</b>

6.1	Basic .....	32
6.2	Spanning Tree Protocol .....	33
6.3	Wireless .....	34
<b>7</b>	<b>Wireless Setting.....</b>	<b>36</b>
7.1	Wireless Network .....	36
7.2	Wireless Security .....	39
7.3	Fast Roaming.....	48
7.4	Wireless MAC Filtering.....	49
7.5	WDS Link Settings.....	50
<b>8</b>	<b>Management.....</b>	<b>52</b>
8.1	Administration.....	52
8.2	Management VLAN Settings .....	53
8.3	Wireless Traffic Shaping .....	54
8.4	SNMP Settings .....	55
8.5	Backup/Restore.....	57
8.6	Firmware Upgrade .....	59
8.7	Time Settings.....	60
8.8	WiFi Scheduler .....	62
8.9	CLI Setting .....	64
8.10	System Log.....	65
8.11	Tools .....	66
8.12	Device Discovery .....	68
8.13	LED Control .....	69
8.14	Logout.....	70
8.15	Reset .....	71
	<b>Appendix A – FCC Interference Statement .....</b>	<b>72</b>

**Appendix B – IC Interference Statement** ..... 錯誤! 尚未定義書籤。

**Appendix C – CE Interference Statement**..... **73**

# Revision History

Version	Date	Notes
1.0.0	20141024	First Release

## 1 Introduction

The **ECB1750** is a high-powered, long-range dual-band concurrent wireless 802.11ac/a/b/g/n access point with 5 major functional modes. It is designed to operate in numerous environments from large homes, small and medium-sized businesses, multiple-floor offices, hotels and other venues to larger enterprise deployments. Its high-powered, long-range characteristics make it a cost-effective alternative to ordinary access points that don't have the range and reach to connect to a growing number of wireless users who wish to connect to a large home or business network.

The ECB1750 supports IEEE 802.11b/g/n standards in the 2.4GHz frequency band while at the same time supporting IEEE 802.11ac/a/n standards in the less congested 5GHz frequency band ideal for streaming or transferring other large files.

The ECB1750 delivers up to 6x faster wireless speeds and 7x extended coverage than legacy 802.11a/b/g wireless devices. Even though the ECB1750 has been designed and engineered for traffic heavy and demanding business environments it is also quite at home in larger house scenarios because it efficiently extends the wireless range of an existing home router, especially in very architecturally-challenging structures to provide whole home connectivity.

To protect sensitive data during wireless transmissions, the ECB1750 offers different encryption settings for wireless transmissions including industry-standard WPA and WPA2 encryption. The ECB1750 also includes MAC address filtering to allow network administrators to offer network access only to known computers and other devices based on their MAC addresses.

## 1.1 Features and Benefits

Features	Benefits
3x3 MIMO High Speed Data Rate Up to 1,300 Mbps for 5GHz and 450Mbps for 2.4GHz	<b>Capable of handling heavy data payloads such as HD multimedia streaming.</b>
High Transmit Power 24dBm for each 5Ghz and 2.4GHz	<b>Extensive long range connectivity</b>
10/100/1000 Gigabit Ethernet	<b>Supports up to 1000Mbps wired networking speed.</b>
IEEE 802.11ac Compliant and Backwards Compatible with 802.11 n/a/b/g devices	<b>Fully compatible with IEEE 802.11 ac/a/b/g/n devices.</b>
Multiple Operation Modes	<b>Allowing users to select any one of the following modes: Access Point, Client Bridge, WDS AP, WDS Bridge, WDS Station on their specific networking deployment need.</b>
Support Multiple SSIDs in AP mode (up to 8 in each frequency band)	<b>Allows clients to access different networks through a single access point and assign different policies and functions for each SSID through the built-in software.</b>
WPA/WPA2/IEEE 802.1x Support	<b>Supports industry-standard wireless encryption.</b>
MAC Address Filtering in AP Mode	<b>For more secure network connections with known users and devices.</b>
User Isolation Support (AP mode)	<b>Offers an additional layer of protection within the network by isolating specific client users.</b>
Power-over-Ethernet (IEEE802.3at)	<b>Allows installers to deploy the ECB1750 in locations via a PoE connection (Ethernet cable) where a power outlet may not be available.</b>
Save User Settings	<b>Enables network administrators to save their device settings so firmware upgrades do not permanently delete previous device settings.</b>

SNMP Remote Configuration Management	<b>Allows remote connection to configure or manage the ECB1750 easily.</b>
QoS (WMM) support	<b>802.11e Prioritizes bandwidth-intensive and sensitive data traffic.</b>
IPv6 Address support	<b>ECB1750 supports Ipv6, you can use Ipv6 address in ECB1750.</b>
Band Steering	<b>When Band Steering is activated dual-band client devices are associated to the ECB1750 access point on the 5 GHz frequency band.</b>
Traffic Shaping	<b>Download and Upload Bandwidth Control Per SSID</b>
Engenius EZ Controller Management (Optional)	<b>Software-based EZ Controller Can Central Configure, Monitor APs.</b>

## 1.2 Package Contents

The ECB1750 package contains the following items (Resellers and dealers require that all items must be in package to issue a refund):

- ECB1750 Access Point/Client Bridge/WDS
- 12V/2A 100V~240V Power Adapter
- RJ-45 Ethernet LAN Cable
- 2.4 GHz Detachable Antenna x 3
- 5 GHZ Detachable Antenna x 3
- Wall Mount Screw Kit
- CD with User's Manual
- Quick Installation Guide



## 1.3 System Requirements

The following are the Minimum System Requirements in order to configure the device.

- Computer with an Ethernet interface or wireless network capability
- Windows OS (XP, Vista, 7, 8), Mac OS X, or Linux-based operating systems
- Web-Browsing Application (i.e.: Internet Explorer, Firefox, Safari, or other similar browser application)

## 1.4 Applications

Wireless LAN (WLAN) products are easy to install and highly efficient. The following list describes the benefits of deploying a wireless access point:

### a) Difficult-to-Wire Environments

There are many situations where wires cannot be installed, deployed easily or cannot be hidden from view. Many older buildings sites, or areas within a building may make the installation of an Ethernet-based LAN impossible, impractical or expensive.

### b) Temporary Workgroups

A deployed wireless access point or several access points, gives businesses the flexibility to create temporary workgroups/networks in more open areas within a building – auditoriums, amphitheater classrooms, ballrooms, arenas, exhibition centers, and temporary offices.

### c) The Ability to Access Real-Time Information

Doctors/Nurses, Point-of-Sale Employees, and/or Warehouse Workers can access real-time information on their network via the access point while dealing with patients, serving customers, and/or processing information.

**d) Frequently Changing Environments**

Setting up an access point, like the ECB1750, to provide access to a company network or its Internet connection is quick and easy which also makes it ideal for establishing network access in temporary venues like exhibits, special events, or show rooms.

**e) Small Office and Home Office (SOHO) Networks**

A wireless access point, like the EC1750, is ideal for SOHO users who need a cost-effective way to expand their existing network to provide more access for more devices, easy and quick installation of a small network.

**f) Wireless Extensions to Existing Ethernet-based Networks**

Wireless access points, like the ECB1750, enable network administrators, installers and end-users to extend the range and reach of an existing Ethernet-based network.

**g) Training/Educational Facilities**

Training sites at corporations and universities deploy wireless access points to provide connectivity their networks and the Internet connection for their employees and students.

## 2 Before you Begin

This section will guide you through the installation process. Placement of the EnGenius ECB1750 is essential to maximize the access point's performance. Avoid placing the ECB1750 in an enclosed space such as a closet, cabinet, or stairwell.

### 2.1 Considerations for Wireless Installation

Generally, the exact operating distance of a wireless device, like the ECB1750, cannot be pre-determined due to a number of unknown variables or obstacles in the environment in which the device will be deployed. These could be the number, thickness, and location of walls, ceilings, elevator shafts, stairwells, or other objects that the device's wireless signals must pass through. Here are some key guidelines to allow the ECB1750 to have optimal wireless range.

- Keep the number of walls and/or ceilings between the ECB1750 and other network devices to a minimum. Each wall and/or ceiling can reduce the signal strength, resulting in lower signal strength.
- Building materials make a difference. A solid metal door and/or aluminum studs may have a significant negative effect on the signal strength of the ECB1750. Locate your wireless devices carefully so the signal can pass through drywall and/or open doorways. Materials such as glass, steel, metal, concrete, water (example: fish tanks), mirrors, file cabinets and/or brick can also diminish wireless signal strength.
- Interference from other electrical devices and/or appliances that generate RF noise can also diminish the ECB1750's signal strength. The most common types of devices are microwaves or cordless phones.

## 2.2 Computer Settings (in Windows XP/Windows 7/Windows 8)

In order to use the ECB1750, you must first configure the TCP/IPv4 connection of your Windows OS computer system.

- Click **Start** button and open **Control Panel**.



Windows XP

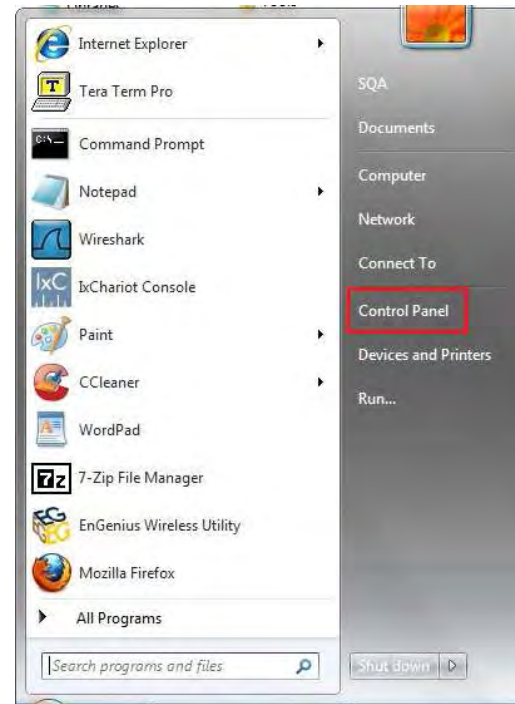

Windows 7

- Move your mouse to the lower right hot corner to display the Charms Bar and select the **Control Panel** in **Windows 8**

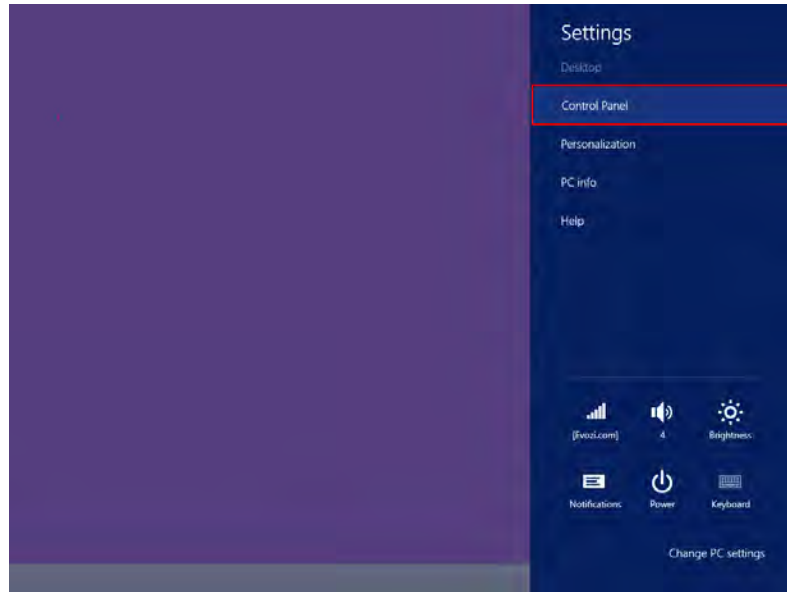

Windows 8

- In **Windows XP**, click **Network Connections**



- In **Windows 7/Windows 8**, click **View Network Status and Tasks** in the **Network and Internet** section, then select **Change adapter settings**

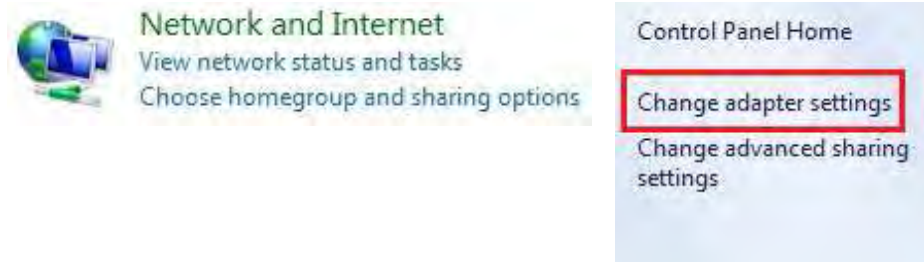

- Right click on **Local Area Connection** and select **Properties**

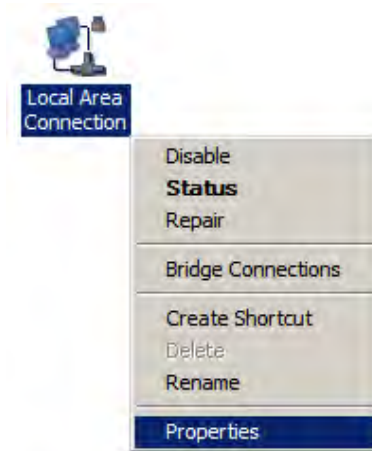

- Select “**Internet Protocol Version 4 (TCP/IPv4)**” and then select **Properties**

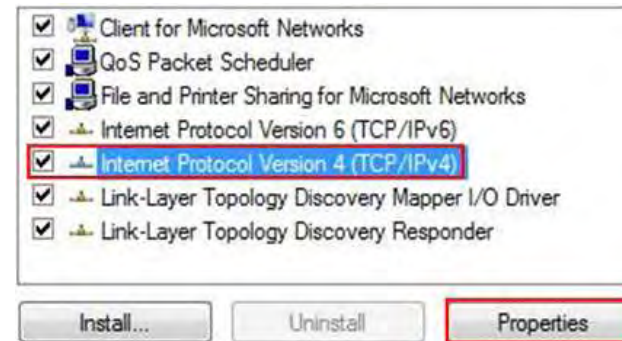

- Select **Use the following IP address** and enter an IP address that is different from the ECB1750 and subnet mask then click **OK**.

**Note:** Ensure that the IP address and subnet mask are on the same subnet as the device.

For example: ECB1750 IP address: 192.168.1.1

PC IP address: 192.168.1.2 – 192.168.1.255

PC subnet mask: 255.255.255.0

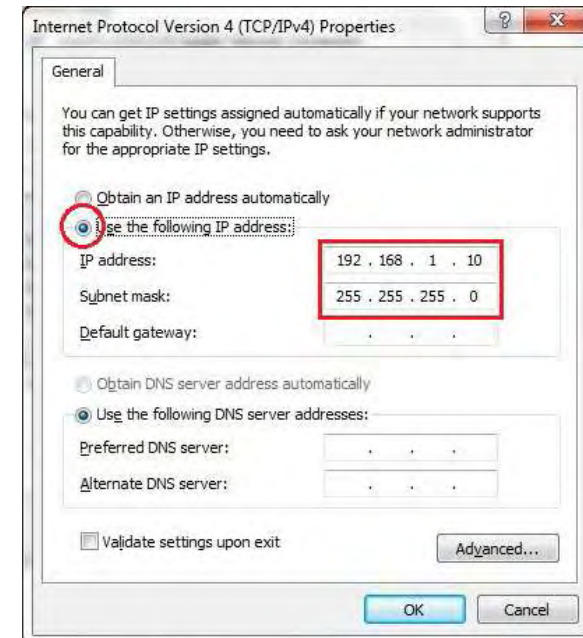

## 2.3 Computer Settings in Apple Mac OS X

- Go to **System Preferences** (can be opened in the **Applications** folder or selecting it in the Apple Menu)
- Select **Network** in the **Internet & Network** section
- Highlight **Ethernet**
- In **Configure IPv4**, select **Manually**
- Enter an IP address that is different from the ECB1750 and subnet mask then press **OK**

**Note:** Ensure that the IP address and subnet mask are on the same subnet as the device.

For example: ECB1750 IP address: 192.168.1.1

PC IP address: 192.168.1.2 – 192.168.1.255

PC subnet mask: 255.255.255.0

- Click **Apply** when done.

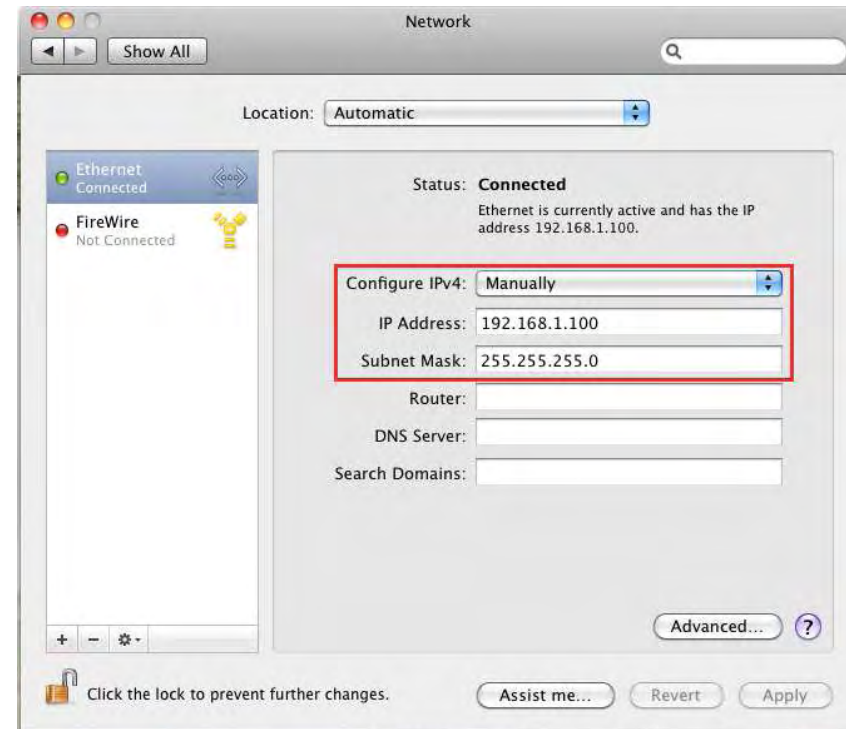



## 2.4 Hardware Installation

1. Ensure that the computer in use has an available Ethernet (RJ-45) Port. For more information, verify with your computer's user manual.
2. Connect one end of the Category 5e Ethernet cable into the RJ-45 port of the ECB1750 and the other end to the RJ-45 port of the computer. Ensure that the cable is securely connected to both the ECB1750 and the computer.
3. Connect the Power Adapter DC connector to the DC-IN port of the ECB1750 and the Power Adapter to an available electrical outlet. Once both connections are secure, verify the following:
  - a) Ensure that the **POWER** light is on (it will be orange).
  - b) Ensure that the **2.4GHz/5GHz WLAN** light is on (both will be blue.).
  - c) Ensure that the **LAN (Computer/ECB1750 Connection)** light is on (it will be blue).
  - d) Once all lights are on, proceed to set up the ECB1750 using the computer.

This diagram depicts the hardware configuration.

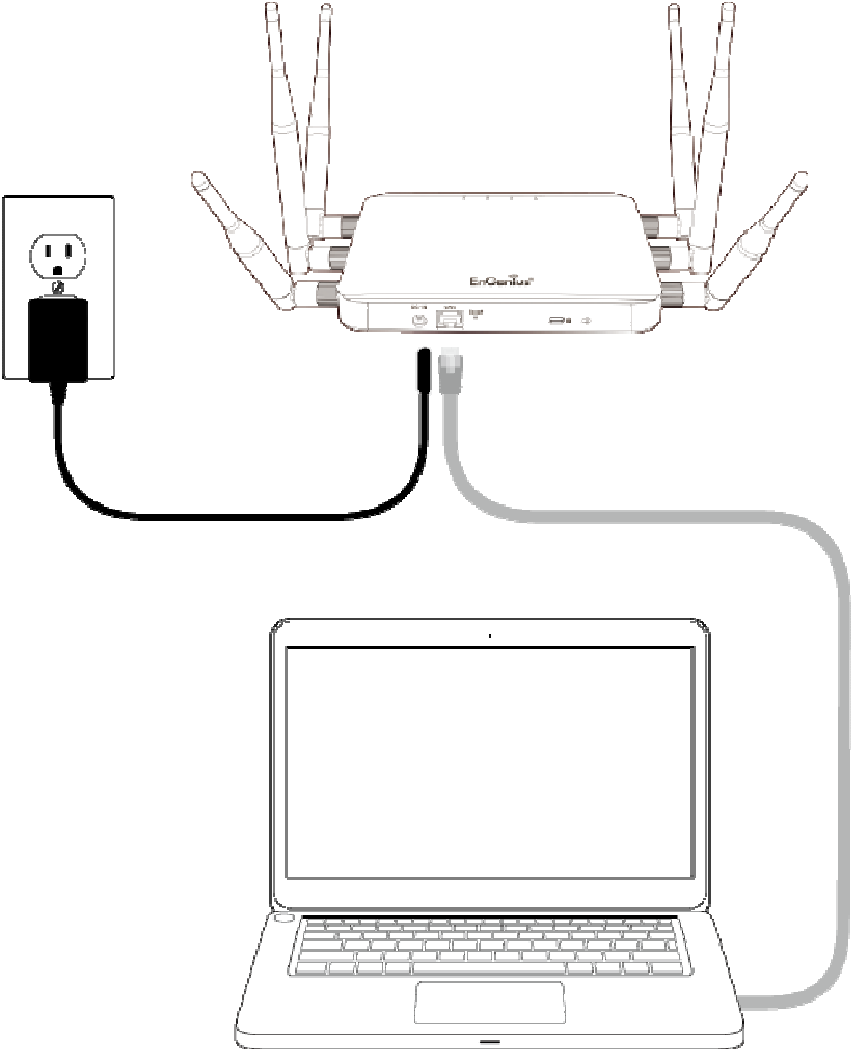

## Mounting the ECB1750

To attach ECB1750 on a wall using included mounting screw kit.

1. Drill the holes to input the mounting screws.(25mm x 8mm)
2. Use the included screws (18mm x 5.5mm) to attach on ECB1750
3. Lock ECB1750 on the mounting screws.

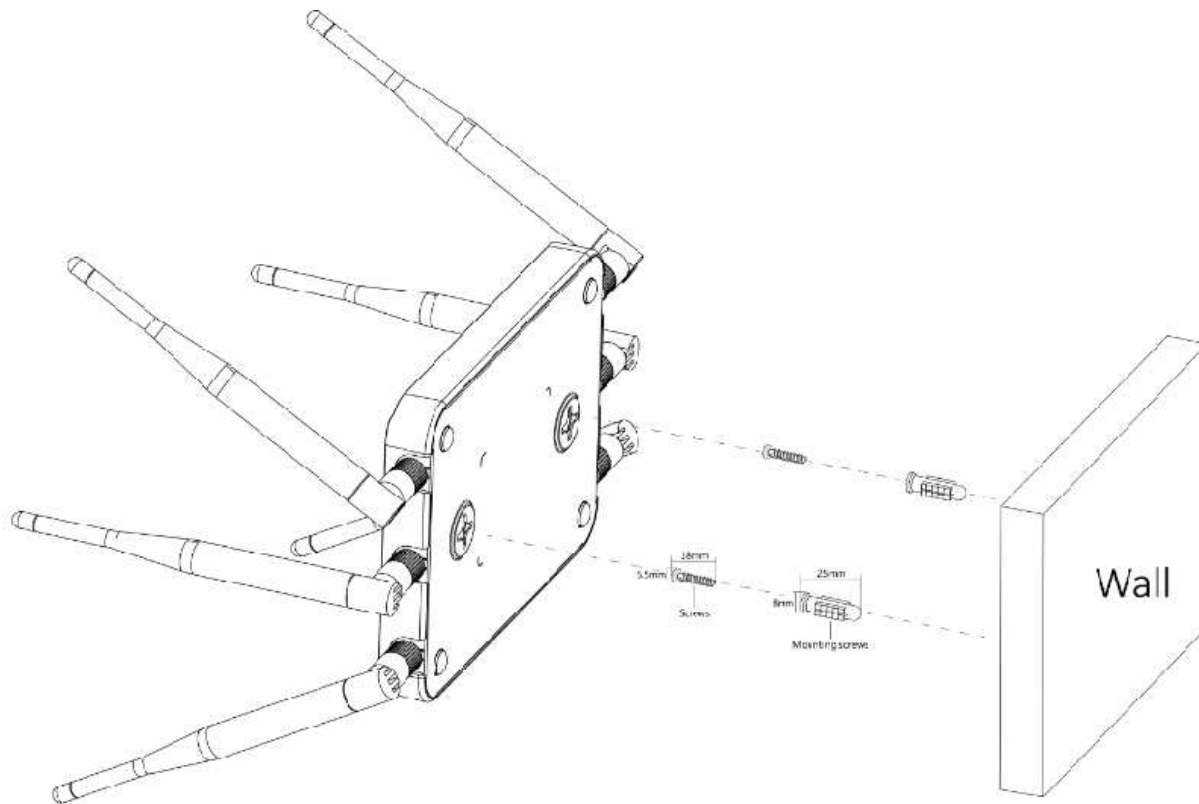



Front Panel	
<b>A. LED Lights</b>	LED lights for Power, Gigabit Ethernet port, WLAN 2.4GHz and WLAN 5GHz
Rear Panel	
<b>B. Power</b>	12V DC IN for Power.
<b>C. Gigabit Ethernet Port</b>	802.3at PoE Gigabit Ethernet port for RJ-45 cable.
<b>D. Reset Button</b>	One click for reset the device. Press over 10 seconds for reset to factory default.
<b>Kingston Security Slot</b>	To protect your ECB1750, attach on a cable lock.

### 3 Configuring Your ECB1750

This section will show you how to configure the device using the web-based configuration interface.

#### 3.1 Default Settings

Please use your Ethernet port or wireless network adapter to connect the ECB1750.

##### Default Settings

IP Address	192.168.1.1
Username / Password	admin / admin
Operation Mode	AP / AP

## 3.2 Web Configuration

- Open a web browser (Internet Explorer/Firefox/Safari) and enter the IP Address **http://192.168.1.1**

**Note:** If you have changed the default LAN IP Address of the Access Point, ensure you enter the correct IP Address.



- The default username and password are **admin**. Once you have entered the correct username and password, click the **Login** button to open the web-base configuration page.

A screenshot of the EnGenius login page. The page title is "EnGenius". Below the title, there are two input fields: "Username:" with the text "admin" entered, and "Password:" with five black dots representing a masked password. Below the input fields are two buttons: "Login" and "Reset".

- If successful, you will be logging in and see the ECB1750 User Menu.

The screenshot displays the EnGenius web management interface for an ECB1750 Dual Radio AP. The top navigation bar includes the EnGenius logo, the device name 'ECB1750 Dual Radio AP, 3T3R, 450Mbps + 1300Mbps', and buttons for 'Changes: 0' and 'Reset'. A 'Logout' button is located below the navigation bar. On the left side, there is a vertical menu with categories: Overview, Network, Management, and System Manager. The main content area is divided into two sections: 'Device Information' and 'Memory Information'.

Device Information	
Device Name	ECB1750
Mac Address	
- LAN	00:AA:BB:CC:DD:10
- Wireless LAN - 2.4GHZ	00:AA:BB:CC:DD:10
- Wireless LAN - 5GHZ	00:AA:BB:CC:DD:11
Country	Default
Current Local Time	Thu Aug 21 12:55:06 2014
Uptime	0h 28m 15s
Firmware Version	1.0.0
Management VLAN ID	Untagged

Memory Information	
Total Available	84568 kB / 126760 kB (66%)
Free	68272 kB / 126760 kB (53%)
Cached	12368 kB / 126760 kB (9%)
Buffered	3928 kB / 126760 kB (3%)

## 4 Building a Wireless Network

The ECB1750 has the ability to operate in various modes. This chapter describes the operating modes of the ECB1750.

### 4.1 Access Point Mode

In Access Point Mode, ECB1750 behaves like a central connection for stations or clients that support IEEE 802.11ac/a/b/g/n networks. The stations and clients must be configured to use the same SSID (Service Set Identifier) and security password to associate with the ECB1750. The ECB1750 supports up to eight SSIDs at the same time for secure access.

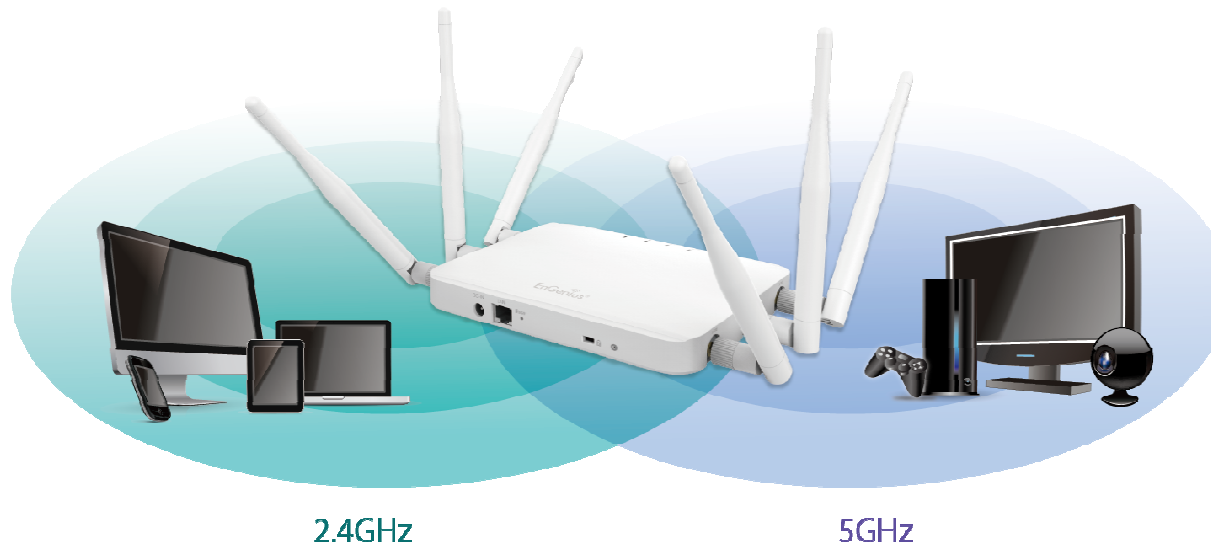



## 4.2 Client Bridge Mode

In Client Bridge Mode, the ECB1750 essentially acts as a wireless adapter that connects to an access point to allow a system wireless access to the network. This mode requires you to connect the Ethernet port on your PC to the ECB1750 LAN port.

If you use the client bridge operating mode, use the ECB1750 AP Detection feature to scan for Access Points within range. When you find an Access Point, configure the ECB1750 to use the same SSID and Security Password as the Access Point to associate with it.

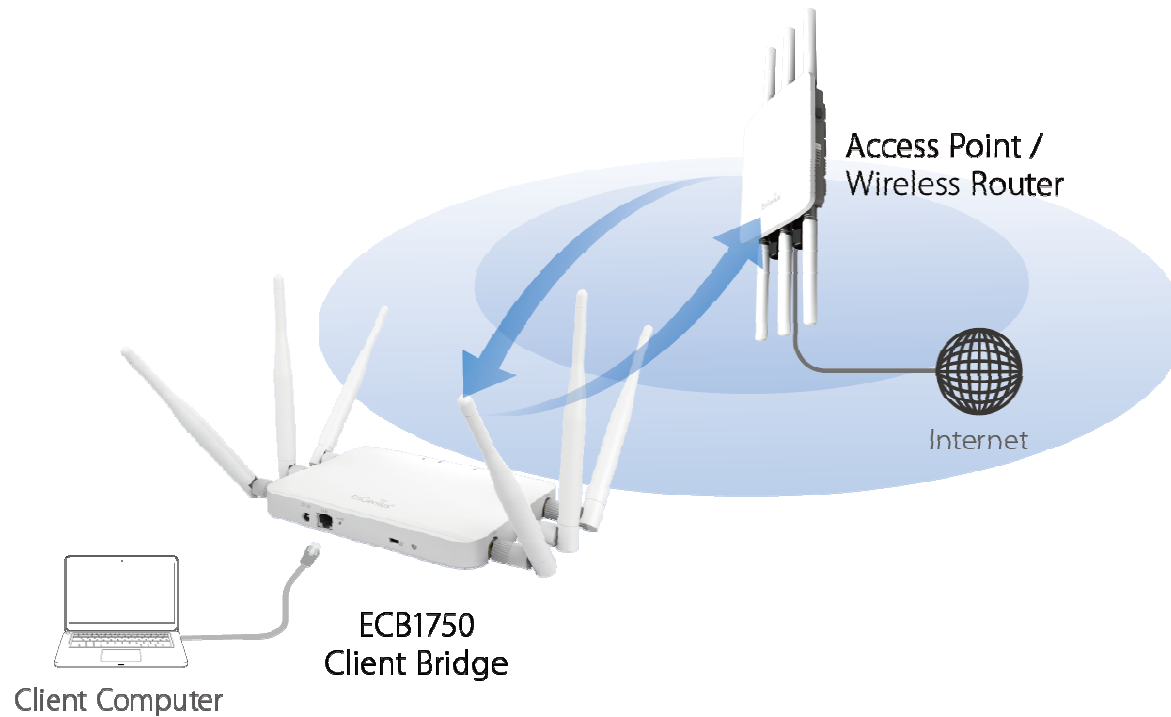

### 4.3 WDS AP / WDS Station Mode

The ECB1750 also supports WDS AP mode. This operating mode allows wireless connections to the ECB1750 using WDS technology. In this mode, configure the MAC addresses in both Access Points to enlarge the wireless area by enabling WDS Link settings. WDS supports four AP MAC addresses.

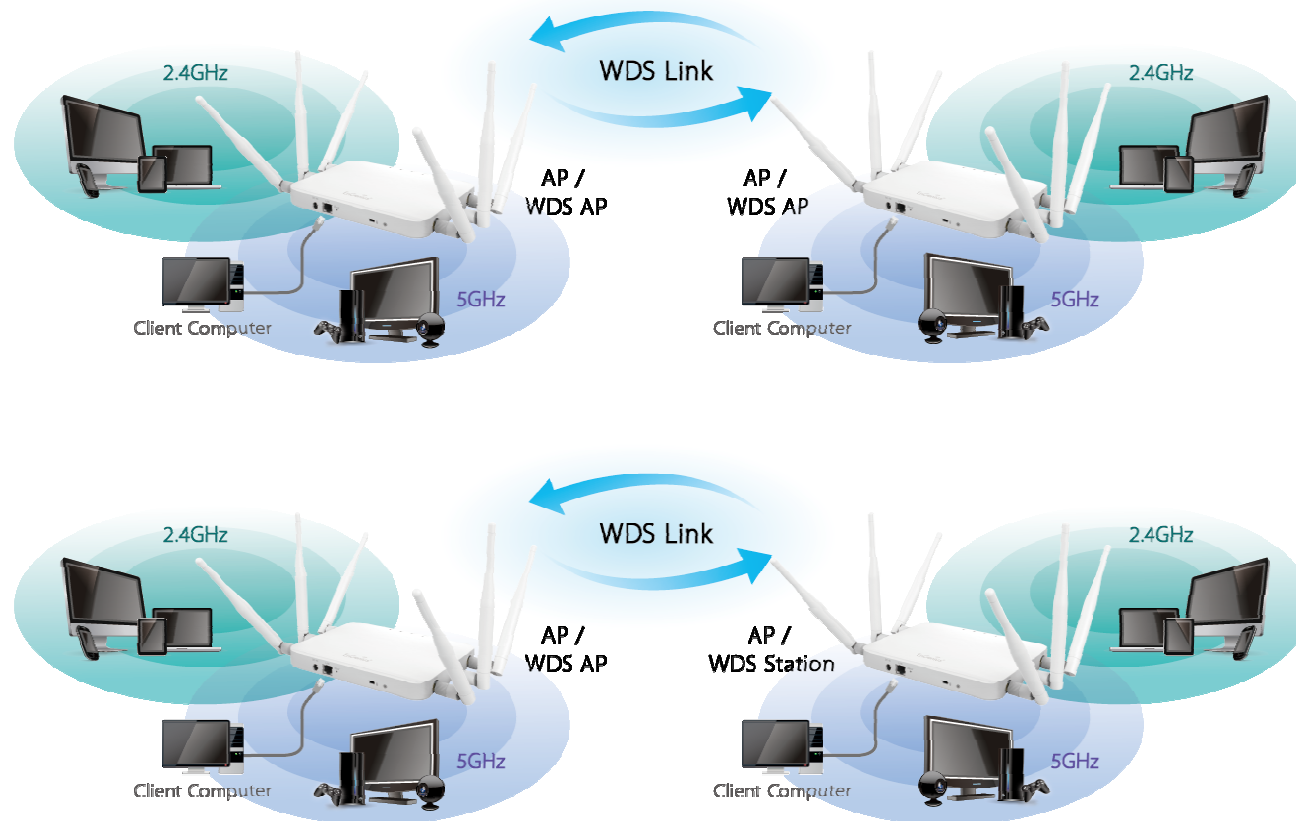

**Note:** WDS Station Mode does not support Access Point feature.

## 4.4 WDS Bridge Mode

In WDS Bridge Mode, the ECB1750 can wirelessly connect different LANs by configuring the MAC address and security settings of each ECB1750 device. Use this mode when two wired LANs located a small distance apart want to communicate with each other. The best solution is to use the ECB1750 to wirelessly connect two wired LANs, as shown in the following figure. WDS Bridge Mode can establish four WDS links, creating a star-like network.

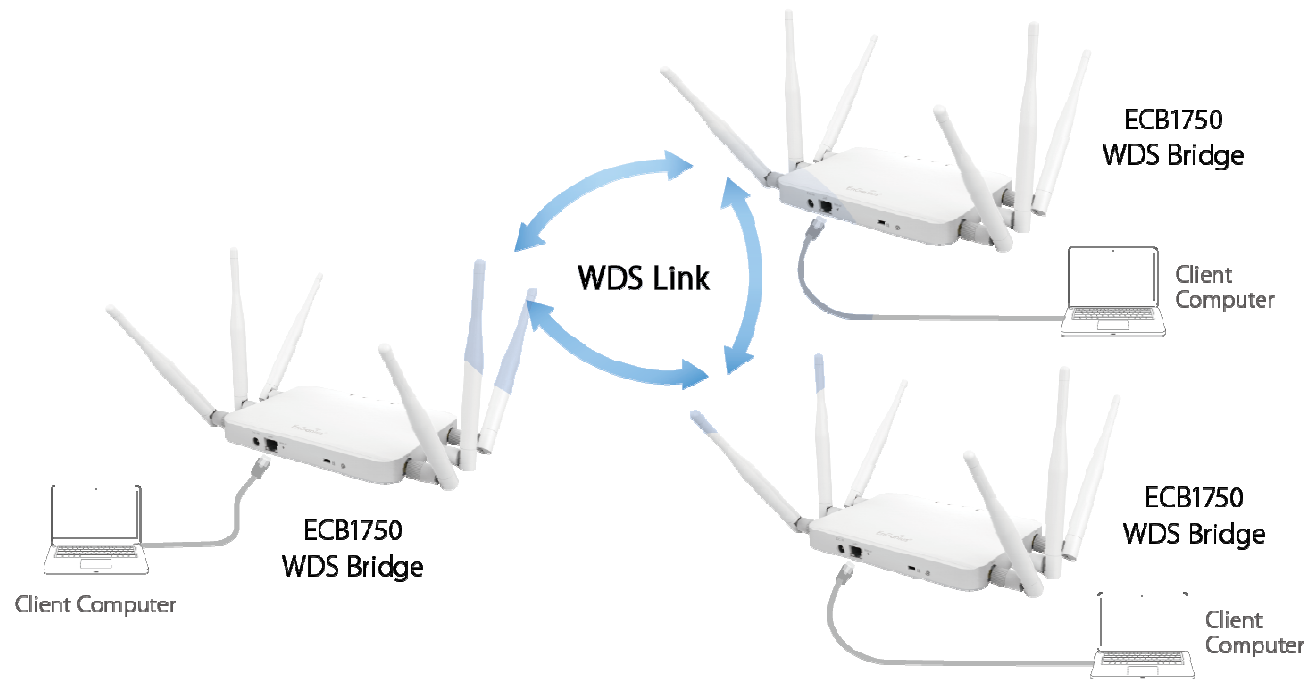

**Note:** WDS Bridge Mode does not act as an Access Point. Access Points linked by WDS are using the same frequency channel. More Access Points connected together may lower throughput. This configuration can be susceptible to generate endless network loops in your network, so it is recommended to enable the Spanning Tree setting (see 6.3 Spanning Tree Setting, below) to prevent this from happening.

## 5 Overview

The overview section contains the following options:

- Device Status
- Connections
- Realtime

### 5.1 Device Status

Click the Device Status link under the Overview menu shows the current status of information about operating mode.

The screenshot shows the EnGenius web interface for device ECB1750. The top navigation bar includes the EnGenius logo, device name 'ECB1750', model 'Dual Radio AP, 3T3R, 450Mbps + 1300Mbps', and buttons for 'Changes: 0' and 'Reset'. A 'Logout' button is also present.

The left sidebar contains a menu with the following items: Overview (selected), Device Status, Connections, Realtime, Network (expanded), Basic, Wireless, Management, Advanced, Time Zone, WiFi Scheduler, Tools, System Manager, Account, Firmware, and Log.

The main content area is titled 'Device Information' and contains the following data:

Device Name	ECB1750
Mac Address	
- LAN	00:AA:BB:CC:DD:10
- Wireless LAN - 2.4GHz	00:AA:BB:CC:DD:10
- Wireless LAN - 5GHz	00:AA:BB:CC:DD:11
Country	Default
Current Local Time	Thu Aug 21 12:55:06 2014
Uptime	0h 28m 15s
Firmware Version	1.0.0
Management VLAN ID	Untagged

Below the device information is the 'Memory Information' section:

Total Available	84568 kB / 126760 kB
Free	68272 kB / 126760 kB (53%)
Cached	12368 kB / 126760 kB (9%)
Buffered	3928 kB / 126760 kB (3%)

System Properties	
<b>Device Information</b>	General system information such as device name, MAC address, current time, firmware version and management VLAN ID.*
<b>Memory Information</b>	Total available memory, includes Free + Cached + Buffered.
<b>LAN Information</b>	the local area network settings such as the LAN IP address, Subnet Mask, Gateway, DNS, DHCP client and Spanning Tree Protocol(STP) status.
<b>Wireless LAN Information</b>	2.4GHz and 5GHz 2 bands operation mode setting, frequency, channel status. Since ECB1750 support 8SSIDs per band, it displays each SSID security setting and VLAN ID assignment.*

**Note 1:** VLAN ID is only applicable in Access Point mode or WDS AP mode.

**Note 2:** Profile setting is only applicable in Access Point mode or WDS AP mode.

## 5.2 Connections

ECB1750 automatically logs(record) event of possible interest in its internal memory. To view the logged information, click Connection under Overview menu, if there is not enough memory to log all events, older events are deleted from the log. When powered down or rebooted, the log will be cleared.

The screenshot shows the EnGenius ECB1750 web interface. At the top, it displays 'EnGenius®' and 'ECB1750 Dual Radio AP, 3T3R, 450Mbps + 1300Mbps'. There are buttons for 'Changes: 0' and 'Reset', and a 'Logout' link. The left navigation menu includes 'Overview', 'Device Status', 'Connections', 'Realtime', 'Network', 'Basic', and 'Wireless'. The main content area shows two connection lists:

Connection List - 2.4GHz

SSID	MAC Address	TX	RX	RSSI	Block

Connection List - 5GHz

SSID	MAC Address	TX	RX	RSSI	Block

## 5.3 Realtime

The Realtime section contains the following options:

### CPU Load:

3 minutes CPU loading percentage information, it displays current loading, average loading and peak loading status. Left bar is loading percentage; button is time tracing. Interval is every 3 seconds.

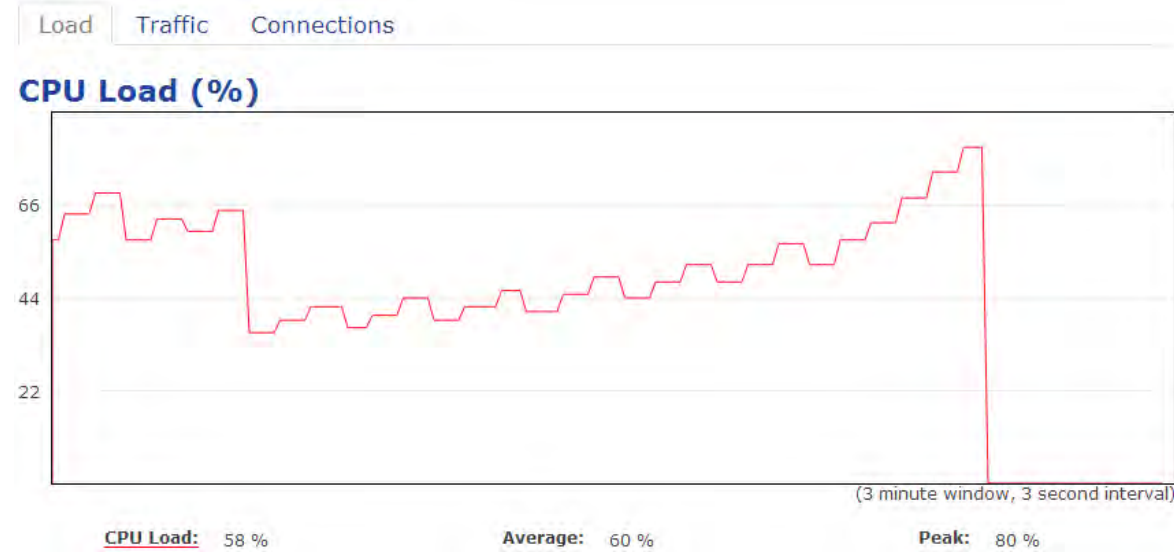

### Realtime Traffic (kb/s):

2.4GHz and 5GHz and Ethernet port inbound and outbound traffic by current, average and peak time.

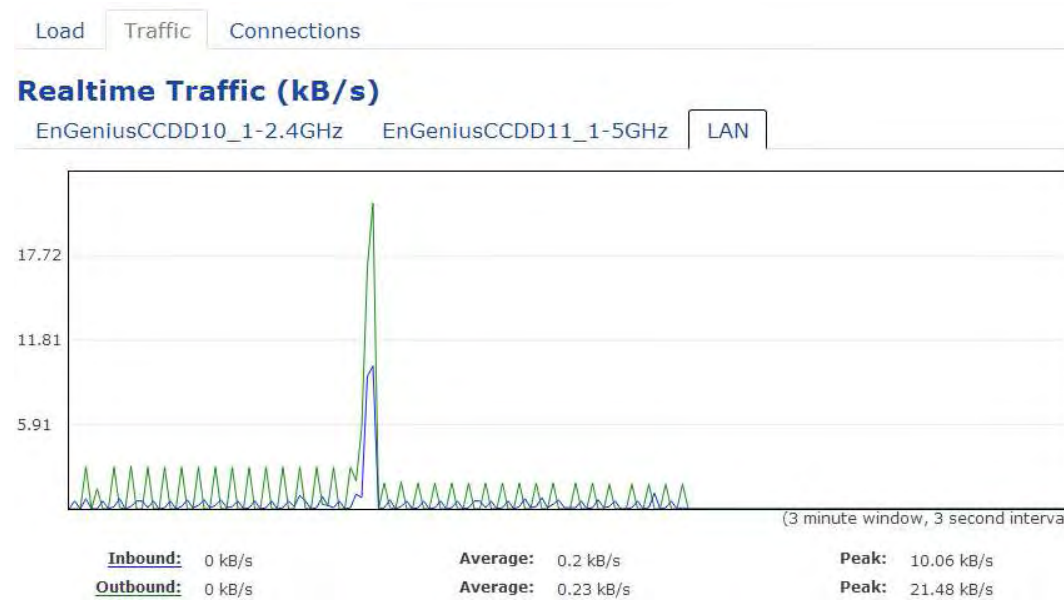

### Realtime Connection (Pkts):

Overview on current active network connections. It displays UDP and TCP packets information and other connection status. UDP connections curve is in blue; TCP connection curve is in green; others curve is in red. Below of chart shows connections source and destination.

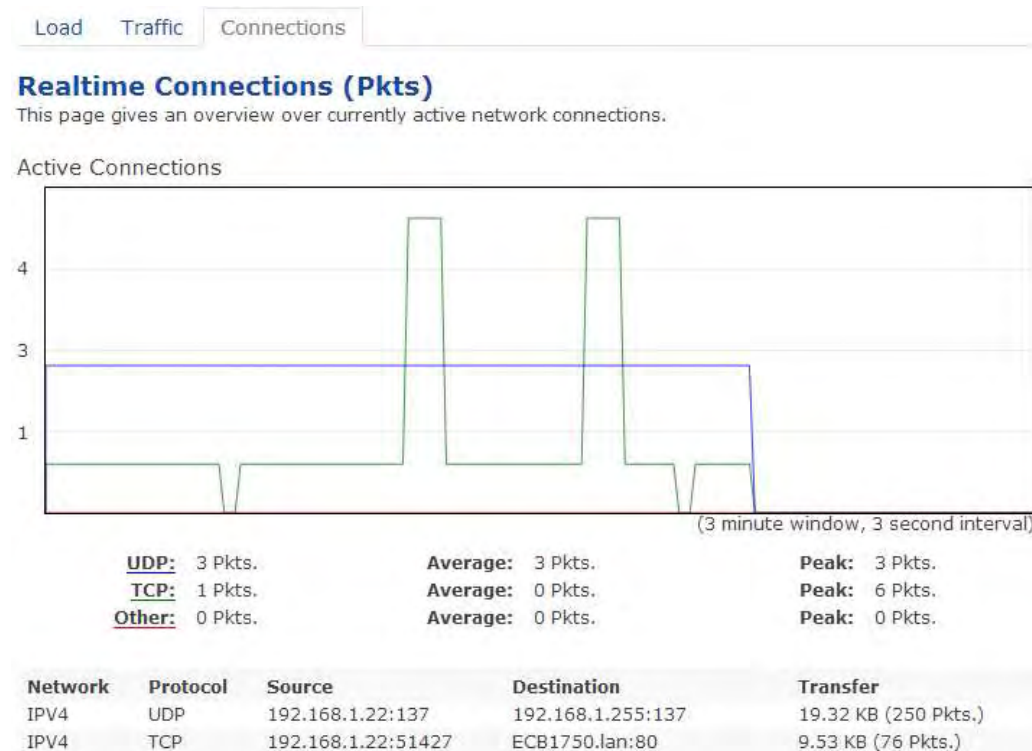



## 6 Network

### 6.1 Basic

This page allows you modify devices' IP settings. ECB1750 supports IPv4 and IPv6.

The screenshot shows the EnGenius web interface for device ECB1750. The top navigation bar includes 'Changes: 0', 'Reset', and 'Logout'. The left sidebar menu has 'Network' selected, with 'Basic' as the active sub-tab. The main content area is titled 'IPv4 Settings' and contains the following fields:

- IP Network Setting:  DHCP  Static IP
- IP Address:
- Subnet Mask:
- Gateway:
- Primary DNS:
- Secondary DNS:

Below the IPv4 settings is the 'IPv6 Settings' section, which includes a checked checkbox for 'Link-local Address' and empty input fields for IP Address, Subnet Prefix Length, Gateway, and Primary DNS.

System Properties	
<b>IP Address</b>	The IP address of this device.
<b>IP Subnet Mask</b>	The IP subnet mask of this device.
<b>Gateway</b>	The default gateway of this device. Leave it blank if you are unsure of setting.
<b>Primary/Secondary DNS</b>	The primary and secondary DNS address for this device.

## 6.2 Spanning Tree Protocol

Spanning Tree Protocol setting under the Network sidebar, this function prevents network loops in your LAN network.

### Spanning Tree Protocol (STP) Settings

Status	<input type="radio"/> Enable <input checked="" type="radio"/> Disable	
Hello Time	<input type="text" value="2"/>	seconds (1-10)
Max Age	<input type="text" value="20"/>	seconds (6-40)
Forward Delay	<input type="text" value="4"/>	seconds (4-30)
Priority	<input type="text" value="32768"/>	(0-65535)

System Properties	
<b>Spanning Tree Status</b>	Enable or disable the Spanning Tree function
<b>Hello Time</b>	Specify bridge Hello Time, in seconds. This value determines how often the device sends handshake packets to communicate information about the topology throughout the entire bridged local area network.
<b>Max Age</b>	Specify bridge Max Age, in seconds. If another bridge in the spanning tree does not send a Hello packet for a long period of time, it is assumed to be inactive.
<b>Forward Delay</b>	Specify bridge Forward Delay, in seconds. Forwarding Delay Time is the time spent in each of the listening and learning status before the forwarding status is entered. This delay is provided so that when a new bridge comes onto a busy network, it analyzes data traffic before participating.
<b>Priority</b>	Specify the Priority number. A smaller number has greater priority.
<b>Save</b>	Click Save to confirm changes.

## 6.3 Wireless

The ECB1750 supports five operating modes: Access Point, Client Bridge, WDS AP, WDS Bridge, WDS Station.

To access operation mode, click Wireless section under Network in the sidebar. You will see Wireless setting customizable options for both 2.4GHz and 5GHz. Under Wireless Setting you will see following items:

System Properties	
<b>Device Name</b>	Enter a name for the device. The name you type appears in SNMP management. This name is not the SSID and is not broadcast to other devices.
<b>Region</b>	Select Region to conform to local regulations.
<b>Band Steering</b>	Send 802.11n client to the 5GHz band, where 802.11b/g clients cannot go and leave 802.11b/g clients in 2.4GHz to operate their slower rate. Band Steering works within the Access Point by directing 5GHz-capable clients to the band.*

<b>Operation Mode</b>	Use the radio button to select an operating mode.
<b>Wireless Settings 2.4GHz</b>	Edit SSID for VLAN ID assignment, encryption setting, MAC allow, deny list and Traffic Shapping per SSID bandwidth control.
<b>Wireless Settings 5GHz</b>	Edit SSID for VLAN ID assignment, encryption setting, MAC allow, deny list and Traffic Shapping per SSID bandwidth control.
<b>Guest Network Settings</b>	Segregate temporary guest WiFi usage with individual SSID, security and bandwidth control.
<b>Save</b>	Click Save to confirm the changes.

**Note:** When enable band steering function, both 2.4GHz and 5GHz SSID and security setting must be the same.

Since ECB1750 is a dual band device, you can use operating modes which marked with ● concurrently.

2.4GHz 5GHz	Access Point	Client Bridge	WDS AP	WDS Bridge	WDS Station
Access Point	●	●	●	●	●
Client Bridge	●	<b>X</b>	●	<b>X</b>	<b>X</b>
WDS AP	●	●	●	●	●
WDS Bridge	●	<b>X</b>	●	<b>X</b>	<b>X</b>
WDS Station	●	<b>X</b>	●	<b>X</b>	<b>X</b>

## 7 Wireless Setting

### 7.1 Wireless Network

This page displays the current status of the Wireless settings of the ECB1750.

#### Access Point / WDS AP mode:

	2.4GHz	5GHz
Operation Mode	Access Point <input type="checkbox"/> Green <a href="#">?</a>	Access Point <input type="checkbox"/> Green <a href="#">?</a>
Wireless Mode	802.11 B/G/N	802.11 AC/N
Channel HT Mode	20MHz/40MHz	80MHz(AC Only)
Channel	Auto	Auto
Transmit Power	Auto	Auto
Data Rate	Auto	Auto
RTS / CTS Threshold (1 - 2346)	2346	2346
Client Limits	127 <input type="radio"/> Enable <input checked="" type="radio"/> Disable	127 <input type="radio"/> Enable <input checked="" type="radio"/> Disable
Aggregation	<input checked="" type="radio"/> Enable <input type="radio"/> Disable	
	32 Frames	
	50000 Bytes(Max)	
AP Detection	Scan	Scan

2.4G/5G Wireless Network (Access Point / WDS AP mode)	
<b>Wireless Mode</b>	Wireless mode supports 802.11b/g/n mixed mode in 2.4G and 802.11ac/a/n mixed mode in 5G.
<b>Channel HT Mode</b>	The default channel bandwidth is 20/40MHz and 80MHz(under 5GHz) The larger the channel, the better the transmission quality and speed.

<b>Channel / Frequency</b>	Select the channel and frequency appropriate.
<b>Auto</b>	Check this option to enable auto-channel selection.
<b>RTS/CTS Threshold</b>	Threshold packet size for RTC/CTS. A small number causes RTS/CTS packet to be sent more often and consumes more bandwidth.
<b>Client Limit</b>	Limit the total number of clients, maximum 127 clients per radio.
<b>Aggregation</b>	Merges data packets into one packet. This option reduces the number of packets, but also increases packet size.
<b>AP Detection</b>	AP Detection can select the best channel to use by scanning nearby areas for Access Points.
<b>Current Profile</b>	Configure up to eight different SSIDs (four in WDS AP mode). If many client devices will be accessing the network, you can arrange the devices into SSID groups. Click Edit to configure the profile and check whether you want to enable extra SSID.
<b>Save</b>	Click Save to confirm the changes.

**Note:** Only support four SSID in WDS AP mode.

## 2.4G/5G SSID Profile

Wireless Settings - 2.4GHz

Enabled	SSID	Edit	Security	Hidden SSID	Client Isolation	VLAN Isolation	VLAN ID
<input checked="" type="checkbox"/>	EnGeniusCCDD10_1-2.4G	Edit	none	<input type="checkbox"/>	<input type="checkbox"/>	<input type="checkbox"/>	1
<input type="checkbox"/>	EnGeniusCCDD10_2-2.4G	Edit	none	<input type="checkbox"/>	<input type="checkbox"/>	<input type="checkbox"/>	2
<input type="checkbox"/>	EnGeniusCCDD10_3-2.4G	Edit	none	<input type="checkbox"/>	<input type="checkbox"/>	<input type="checkbox"/>	3
<input type="checkbox"/>	EnGeniusCCDD10_4-2.4G	Edit	none	<input type="checkbox"/>	<input type="checkbox"/>	<input type="checkbox"/>	4
<input type="checkbox"/>	EnGeniusCCDD10_5-2.4G	Edit	none	<input type="checkbox"/>	<input type="checkbox"/>	<input type="checkbox"/>	5
<input type="checkbox"/>	EnGeniusCCDD10_6-2.4G	Edit	none	<input type="checkbox"/>	<input type="checkbox"/>	<input type="checkbox"/>	6
<input type="checkbox"/>	EnGeniusCCDD10_7-2.4G	Edit	none	<input type="checkbox"/>	<input type="checkbox"/>	<input type="checkbox"/>	7
<input type="checkbox"/>	EnGeniusCCDD10_8-2.4G	Edit	none	<input type="checkbox"/>	<input type="checkbox"/>	<input type="checkbox"/>	8

### Wireless Settings - 5GHz

Enabled	SSID	Edit	Security	Hidden SSID	Client Isolation	VLAN Isolation	VLAN ID
<input checked="" type="checkbox"/>	EnGeniusCCDD11_1-5GHz	Edit	none	<input type="checkbox"/>	<input type="checkbox"/>	<input type="checkbox"/>	51
<input type="checkbox"/>	EnGeniusCCDD11_2-5GHz	Edit	none	<input type="checkbox"/>	<input type="checkbox"/>	<input type="checkbox"/>	52
<input type="checkbox"/>	EnGeniusCCDD11_3-5GHz	Edit	none	<input type="checkbox"/>	<input type="checkbox"/>	<input type="checkbox"/>	53
<input type="checkbox"/>	EnGeniusCCDD11_4-5GHz	Edit	none	<input type="checkbox"/>	<input type="checkbox"/>	<input type="checkbox"/>	54
<input type="checkbox"/>	EnGeniusCCDD11_5-5GHz	Edit	none	<input type="checkbox"/>	<input type="checkbox"/>	<input type="checkbox"/>	55
<input type="checkbox"/>	EnGeniusCCDD11_6-5GHz	Edit	none	<input type="checkbox"/>	<input type="checkbox"/>	<input type="checkbox"/>	56
<input type="checkbox"/>	EnGeniusCCDD11_7-5GHz	Edit	none	<input type="checkbox"/>	<input type="checkbox"/>	<input type="checkbox"/>	57
<input type="checkbox"/>	EnGeniusCCDD11_8-5GHz	Edit	none	<input type="checkbox"/>	<input type="checkbox"/>	<input type="checkbox"/>	58





2.4G/5G SSID Profile	
<b>SSID</b>	Specify the SSID for the current profile.
<b>Suppressed SSID</b>	Check this option to hide the SSID from clients. If checked, the SSID will not appear in the site survey.
<b>Station Separation</b>	Click the appropriate radio button to allow or prevent communication between client devices.
<b>Wireless Security</b>	See the Wireless Security section.
<b>Isolation</b>	Check the box to enable or disable Isolation function.
<b>Save</b>	Click Save to accept the changes.

## 7.2 Wireless Security

The Wireless Security section lets you configure the ECB1750's security modes: WEP, WPA-PSK, WPA2-PSK, WPA-PSK Mixed, WPA-Enterprise, WPA2-Enterprise, and WPA Mixed Enterprise. It is strongly recommend to use WPA2-PSK. Click Edit button under Wireless Setting next to the SSID to change the Security setting.

### WEP Encryption:

Wireless Security - 2.4GHz

Security Mode	WEP	▼
Auth Type	Open System	▼
Input Type	Hex	▼
Key Length	40/64-bit (10 hex digits or !	▼
Default Key	Key #1	▼
Key #1	<input type="text"/>	
Key #2	<input type="text"/>	
Key #3	<input type="text"/>	
Key #4	<input type="text"/>	

WEP Encryption	
<b>Auth Type</b>	Select Open System or Shared Key.
<b>Input type</b>	ASCII: Regular Text (recommended)



	HEX: Hexadecimal Numbers (For advanced users)
<b>Key Length</b>	Select the desired option and ensure the wireless clients use the same setting. Choices are 64, 128, 152-bit password lengths.
<b>Default Key</b>	Select the key you wish to be default. Transmitted data is ALWAYS encrypted using the Default Key; the other Keys are for decryption only. You must enter a Key Value for the Default Key.
<b>Encryption Key #</b>	Enter the key value or values you wish to use. Only the Key selected as Default is required. The others are optional.

### WPA-PSK (WPA Pre-Shared Key) Encryption:

Wireless Security - 2.4GHz

Security Mode	WPA-PSK ▼
Encryption	AES ▼
Passphrase	<input type="text"/> 
Group Key Update Interval	3600

WPA-PSK (WPA Pre-Shared Key) Encryption	
<b>Encryption</b>	Select the WPA encryption type you would like. Please ensure that your wireless clients use the same settings.
<b>Passphrase</b>	Wireless clients must use the same key to associate the device. If using ASCII format, the Key must be from 8 to 63 characters in length. If using HEX format, the Key must be 64 HEX characters in length.
<b>Group Key Update Interval</b>	Specify how often, in seconds, the group key changes.

## WPA2-PSK Encryption: Only in Access Point / WDS AP mode

### Wireless Security - 2.4GHz

Security Mode	<input type="text" value="WPA2-PSK"/>
Encryption	<input type="text" value="AES"/>
Passphrase	<input type="text"/> 
Group Key Update Interval	<input type="text" value="3600"/>

WPA2-PSK Encryption	
<b>Encryption</b>	Select the WPA encryption type you would like. Please ensure that your wireless clients use the same settings.
<b>Passphrase</b>	Wireless clients must use the same key to associate the device. If using ASCII format, the Key must be from 8 to 63 characters in length. If using HEX format, the Key must be 64 HEX characters in length.
<b>Group Key Update Interval</b>	Specify how often, in seconds, the group key changes.

## WPA-PSK Mixed Encryption: Only in Access Point / WDS AP mode



Wireless Security - 2.4GHz

Security Mode	WPA-PSK Mixed ▼
Encryption	AES ▼
Passphrase	<input type="text"/> 

WPA-PSK Mixed Encryption	
<b>Encryption</b>	Select the WPA encryption type you would like. Please ensure that your wireless clients use the same settings.
<b>Passphrase</b>	Wireless clients must use the same key to associate the device. If using ASCII format, the Key must be from 8 to 63 characters in length. If using HEX format, the Key must be 64 HEX characters in length.

## WPA Enterprise Encryption: Only in Access Point / WDS AP mode

Wireless Security - 2.4GHz

Security Mode	WPA-Enterprise ▼
Encryption	AES ▼
Group Key Update Interval	3600
Radius Server	
Radius Port	1812 <input checked="" type="radio"/> Default 1812
Radius Secret	<input type="password"/> 
Radius Accounting	Disable ▼
Radius Accounting Server	<input type="text"/>
Radius Accounting Port	1813 <input checked="" type="radio"/> Default 1813
Radius Accounting Secret	<input type="password"/> 
Interim Accounting Interval	600



WPA Enterprise Encryption	
<b>Encryption</b>	Select the WPA encryption type you would like. Please ensure that your wireless clients use the same settings.
<b>Group Key Update Interval</b>	Specify how often, in seconds, the group key changed.
<b>Radius Server</b>	Enter the IP address of the Radius server.
<b>Radius Port</b>	Enter the port number used for connections to the Radius server.
<b>Radius Secret</b>	Enter the secret required to connect to the Radius server.

<b>Radius Accounting</b>	Enable or disable accounting feature.
<b>Radius Accounting Server</b>	Enter the IP address of the Radius accounting server.
<b>Radius Accounting Port</b>	Enter the port number used for connections to the Radius accounting server.
<b>Radius Accounting Secret</b>	Enter the secret required to connect to the Radius accounting server.
<b>Interim Accounting Interval</b>	Specify how often, in seconds, the accounting data sends.

**Note:** 802.11n does not allow WEP/WPA-PSK TKIP/WPA2-PSK TKIP security mode. The connection mode will automatically change from 802.11n to 802.11a/g.

### WPA2 Enterprise Encryption: Only in Access Point / WDS AP mode

#### Wireless Security - 2.4GHz



Security Mode	WPA2-Enterprise ▼
Encryption	AES ▼
Group Key Update Interval	3600
Radius Server	
Radius Port	1812 ⓘ Default 1812
Radius Secret	<input type="password"/> 
Radius Accounting	Disable ▼
Radius Accounting Server	<input type="text"/>
Radius Accounting Port	1813 ⓘ Default 1813
Radius Accounting Secret	<input type="password"/> 
Interim Accounting Interval	600

<b>WPA2 Enterprise Encryption</b>	
<b>Encryption</b>	Select the WPA encryption type you would like. Please ensure that your wireless clients use the same settings.
<b>Group Key Update Interval</b>	Specify how often, in seconds, the group key changed.
<b>Radius Server</b>	Enter the IP address of the Radius server.
<b>Radius Port</b>	Enter the port number used for connections to the Radius server.
<b>Radius Secret</b>	Enter the secret required to connect to the Radius server.
<b>Radius Accounting</b>	Enable or disable accounting feature.
<b>Radius Accounting Server</b>	Enter the IP address of the Radius accounting server.
<b>Radius Accounting Port</b>	Enter the port number used for connections to the Radius accounting server.
<b>Radius Accounting Secret</b>	Enter the secret required to connect to the Radius accounting server.
<b>Interim Accounting Interval</b>	Specify how often, in seconds, the accounting data sends.

**Note:** 802.11n does not allow WEP/WPA-PSK TKIP/WPA2-PSK TKIP security mode. The connection mode will automatically change from 802.11n to 802.11a/g.

## WPA Mixed Enterprise Encryption: Only in Access Point / WDS AP mode

Wireless Security - 2.4GHz

Security Mode	WPA Mixed-Enterprise ▼
Encryption	AES ▼
Group Key Update Interval	3600
Radius Server	
Radius Port	1812 🔗 Default 1812
Radius Secret	<input type="password"/> 
Radius Accounting	Disable ▼
Radius Accounting Server	
Radius Accounting Port	1813 🔗 Default 1813
Radius Accounting Secret	<input type="password"/> 
Interim Accounting Interval	600

WPA Mixed Enterprise Encryption	
<b>Encryption</b>	Select the WPA encryption type you would like. Please ensure that your wireless clients use the same settings.
<b>Group Key Update Interval</b>	Specify how often, in seconds, the group key changed.
<b>Radius Server</b>	Enter the IP address of the Radius server.
<b>Radius Port</b>	Enter the port number used for connections to the Radius server.
<b>Radius Secret</b>	Enter the secret required to connect to the Radius server.
<b>Radius Accounting</b>	Enable or disable accounting feature.

<b>Radius Accounting Server</b>	Enter the IP address of the Radius accounting server.
<b>Radius Accounting Port</b>	Enter the port number used for connections to the Radius accounting server.
<b>Radius Accounting Secret</b>	Enter the secret required to connect to the Radius accounting server.
<b>Interim Accounting Interval</b>	Specify how often, in seconds, the accounting data sends.

**Note:** 802.11n does not allow WEP/WPA-PSK TKIP/WPA2-PSK TKIP security mode. The connection mode will automatically change from 802.11n to 802.11a/g.



### 7.3 Fast Roaming

Enable the function to serve mobile client devices that roam from access point to access point. Some applications roam on client devices require fast re-association when they roam to a different access point.

Please enter the settings of the SSID and initialize the Security mode to WPA2 enterprise, as well as to set the RADIUS server firstly. User can enable Fast Roaming.

Please also set the same encryption under the same SSID on other access point and enable Fast Roaming. When the configuration is activated on different access point, the mobile client devices can run the voice service and require seamless roaming to prevent delay in conversation from access point to access point.



## 7.4 Wireless MAC Filtering

Wireless MAC Filtering is used to allow or deny network access to wireless clients (computers, tablet PCs, NAS, smartphones, etc.) according to their MAC addresses. You can manually add a MAC address to restrict the permission to access ECB1750. The default setting is Disable Wireless MAC Filter.

### Wireless MAC Filter

ACL Mode

:  :  :  :  :

No.      MAC Address

Wireless MAC Filter (Access Point / WDS AP)	
<b>ACL Mode</b>	Determines whether network access is granted or denied to clients whose MAC addresses appear in the MAC Address table on this page. Choices are: Disabled, Deny MAC in the list, or Allow MAC in the list.
<b>MAC Address</b>	Enter the MAC address of the wireless client.
<b>Add</b>	Click Add to add the MAC address to the MAC Address table.
<b>Delete</b>	Delete the selected entries.
<b>Save</b>	Click Save to apply the changes.

**Note:** Only applicable in Access Point, WDS AP mode.

## 7.5 WDS Link Settings

### WDS Bridge / WDS Station:

Using WDS (Wireless Distribution System) will allow a network administrator or installer to connect to Access Points wirelessly. Doing so will extend the wired infrastructure to locations where cabling is not possible or inefficient to implement.

WDS Link Settings - 2.4GHz

Security	None	
WEP Key		40/64-bit(10 hex digits)
AES Passphrase		(8-63 ASCII characters or 64 hexadecimal digits)
MAC Address	Mode	
: : : : :	Disable	
: : : : :	Disable	
: : : : :	Disable	
: : : : :	Disable	

2.4G/5G WDS Link Settings	
<b>Security</b>	Select None or WEP or AES from drop-down list.
<b>WEP Key</b>	Enter the key values you wish to use if selecting WEP.
<b>AES Passphrase</b>	Enter the key values you wish to use if selecting AES.
<b>MAC Address</b>	Enter the Access Point's MAC address to which you want to extend the wireless area.

<b>Mode</b>	Select Disable or Enable from the drop-down list.
<b>Save</b>	Click Save to confirm the changes.

**Note:** Compatibility between different brands and models of access points is not guaranteed. It is recommended that the WDS network be created using the same models for maximum compatibility.

**Note:** All Access Points in the WDS network needs to use the same Channel and Security settings.

To create a WDS network, please enter the MAC addresses of the Access Points that you want included in the WDS. There can be a maximum of four access points.

**Note:** Only applicable in WDS AP and WDS Bridge mode.

**Note:** Other AP(s) must use the same security and key to establish WDS link.

## 8 Management

### 8.1 Administration

This page allows you to change the ECB1750 username and password. By default, the username is admin and the password is: admin. The password can contain 0 to 12 alphanumeric characters and is case sensitive.

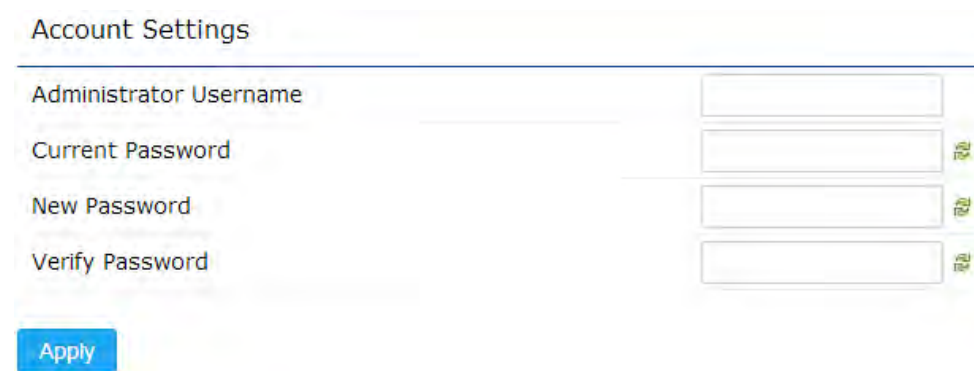

The screenshot shows a web form titled "Account Settings". It contains four input fields: "Administrator Username", "Current Password", "New Password", and "Verify Password". Each password field has a small eye icon to its right, indicating a toggle for password visibility. Below the input fields is a blue "Apply" button.

Login Setting	
<b>New Name</b>	Enter a new username for logging in to the New Name entry box.
<b>Old Password</b>	Enter the old password for logging in to the Old Password entry box.
<b>New Password</b>	Enter the new password for logging in to the New Password entry box.
<b>Confirm Password</b>	Re-enter the new password in the Confirm Password entry box for confirmation.
<b>Apply</b>	Click <b>Apply</b> to apply the changes.

**Note:** It's highly recommend that you change password to something unique for greater security.

## 8.2 Management VLAN Settings

This page allows you to assign a VLAN tag to the packets. A VLAN is a group of computers on a network whose software has been configured so that they behave as if they were on a separate Local Area Network (LAN). Computers on VLAN do not have to be physically located next to one another on the LAN.

### Management VLAN Settings

Status  Enable  Disable 4094

**Caution:** If you encounter disconnection issue during the configuration process, verify that the switch and the DHCP server can support the new VLAN ID and then connect to the new IP address.

Management VLAN (Access Point / WDS mode)	
<b>VLAN ID</b>	Specify the VLAN tag for each profile.
<b>Management VLAN ID</b>	If your network includes VLANs, you can specify a VLAN ID for packets pass through the Access Point with a tag. Otherwise, select No VLAN tag.
<b>Save</b>	Click Save to confirm the changes.

**Note:** Only applicable in Access Point and WDS AP mode.

**Note:** If you reconfigure the Management VLAN ID, you may lose your connection to the ECB1750. Verify that the DHCP server supports the reconfigured VLAN ID and then reconnect to the ECB1750 using the new IP address.

### 8.3 Wireless Traffic Shaping

Traffic shaping regulates the flow of packets leaving an interface to deliver improved Quality of Service. To edit Wireless Traffic Shaping, click Edit for the SSID you would like to configure under Wireless Setting.

#### Wireless Traffic Shaping

Enable Traffic Shaping	<input type="radio"/> Enable <input checked="" type="radio"/> Disable
Download Limit	100 <input type="button" value="Mbps (1-999)"/>
Upload Limit	100 <input type="button" value="Mbps (1-999)"/>

Save current setting(s)

Wireless Traffic Shaping	
<b>Enable Traffic Shaping</b>	Check this option to enable wireless traffic shaping.
<b>Download Limit</b>	Specify the wireless transmission speed used for downloading.
<b>Upload Limit</b>	Specify the wireless transmission speed used for uploading.
<b>Save</b>	Click Save to confirm the changes.

## 8.4 SNMP Settings

This page allows you to assign the Contact Details, Location, Community Name, and Trap Settings for Simple Network Management Protocol (SNMP). This is a networking management protocol used to monitor network attached devices. SNMP allows messages (called protocol data units) to be sent to various parts of the network. Upon receiving these messages, SNMP compatible devices (called agents) return the data stored in their Management Information Bases. To configure SNMP setting, click Advanced under sidebar Management section.

The screenshot shows the EnGenius web interface for an ECB1750 Dual Radio AP. The top navigation bar includes the EnGenius logo, device model, and buttons for 'Changes: 0', 'Reset', and 'Logout'. The left sidebar contains a navigation menu with categories: Overview, Network, Management, and System Manager. The 'Management' section is expanded, showing 'Advanced' as the selected option. The main content area is titled 'SNMP Settings' and contains the following configuration fields:

- Status:  Enable  Disable
- Contact:
- Location:
- Community Name (Read Only):
- Community Name (Read Write):
- Trap Destination:
  - Port:
  - IP Address:
- Community Name:
- SNMPv3 Settings:
  - Status:  Enable  Disable
  - Username:  (1-31 Characters)
  - Authorized Protocol:
  - Authorized Key:  (8-32 Characters)
  - Private Protocol:



<b>SNMP</b>	
<b>Status</b>	Enable or Disable SNMP feature.
<b>Contact</b>	Specify the contact details of the device
<b>Location</b>	Specify the location of the device.
<b>Community Name (Read Only)</b>	Specify the password for the SNMP community for read only access.
<b>Community Name (Read/Write)</b>	Specify the password for the SNMP community with read/write access.
<b>Trap</b>	
<b>Trap Destination Address</b>	Specify the IP address of the computer that will receive the SNMP traps.
<b>Trap Destination Community Name</b>	Specify the password for the SNMP trap community.
<b>SNMPv3</b>	
<b>SNMPv3 Enable/Disable</b>	Enable or Disable SNMPv3 feature.
<b>User Name</b>	Specify the username for SNMPv3.
<b>Auth Protocol</b>	Select the authentication protocol type: MDS or SHA.
<b>Auth Key</b>	Specify the authentication key for authentication.
<b>Priv Protocol</b>	Select the privacy protocol type: DES.
<b>Priv Key</b>	Specify the privacy key for privacy.
<b>Engine ID</b>	Specify the engine ID for SNMPv3.
<b>Apply</b>	Click Apply to apply the changes.

## 8.5 Backup/Restore

This page allows you to save the current device configurations. When you save the configurations, you also can reload the saved configurations into the device through the Restore Saved Settings from A File section. If extreme problems occur, or if you have set up the ECB1750 incorrectly, you can use the Factory Default button in the Revert to Factory Default Settings section to restore all the configurations of the ECB1750 to the original default settings. To configure the Backup/Restore Setting, click Firmware under the System Manager section in left side bar.

### Backup/Restore Settings

#### Factory Setting

- Backup Setting

Export

- Restore New Setting

選擇檔案 未選擇檔案

Import

- Reset to Default

Reset

#### User Setting

- Back Up Setting as Default

Backup

- Restore to User Default

Restore

- **Caution:** Please write down your account number and password before saving. The user settings will now become the new default settings at the next successful login.

Factory Setting	
<b>Backup Setting</b>	To restore settings that have been previously backed up, click Export, select the file and click Restore.
<b>Restore New Setting</b>	Choose the file you wish restore for settings and click Import.
<b>Reset to Default</b>	Click to Reset button to restore the ECB1750 to its factory default settings.

<b>User Settings</b>	
<b>Backup Setting</b>	Click Backup to backup the user settings you would like to the device's memory for the user(WISP)'s default settings.
<b>Restore to User Default</b>	Click Restore to restore user settings to the user(WISP)'s default settings.

## 8.6 Firmware Upgrade

This page allows you to upgrade the firmware of the ECB1750.

### Firmware Upgrade

Current Firmware Version: 1.0.0

Select the new firmware from your hard disk.

Keep settings:

### To perform the Firmware Upgrade:

1. Click the Browse button and navigate the OS File System to the location of the upgrade file.
2. Select the upgrade file. The name of the file will appear in the *Upgrade File* field.
3. Click the Upload button to commence the firmware upgrade.

**Note:** The device is unavailable during the upgrade process and must restart when the upgrade is completed. Any connections to or through the device will be lost.

## 8.7 Time Settings

This page allows you to set the internal clock of the ECB1750. To access the Date and Time settings, click Time Zone under the Management tab in left side bar.

Date and Time Settings

---

Manually Set Date and Time

Date:  /  /

Time:  :  (24-Hour)

Automatically Get Date and Time

NTP Server:

---

Time Zone

Time Zone:

Enable Daylight Saving

Start:

End:

Apply saved settings to take effect

Time	
<b>Manually Set Date and Time</b>	Manually specify the date and time.
<b>Synchronize with PC</b>	Click to Synchronize the ECB1750 with the computer's internal clock.

<b>Automatically Get Date and Time</b>	Select a time zone from the drop-down list and check whether you want to enter the IP address of an NTP server or use the default NTP server to get have the internal clock set automatically.
<b>Time Zone</b>	Choose the Time Zone you would like to use from the drop-down list.
<b>Enable Daylight Saving</b>	Check the box to enable or disable daylight saving time for the ECB1750. Next, enter the dates that correspond to the present year's daylight savings time.
<b>Apply</b>	Click Apply to apply the changes.

## 8.8 WiFi Scheduler

Use the schedule function to control the wireless on/off or reboot ECB1750 on a routine basis. The Schedule function relies on the GMT time setting acquired from a network time protocol (NTP) server. For details on how to connect the ECB1750 to an NTP server, see *Time Settings*.

The screenshot shows the EnGenius ECB1750 web interface. The top navigation bar includes the EnGenius logo, device information (ECB1750 Dual Radio AP, 3T3R, 450Mbps + 1300Mbps), and buttons for 'Changes: 0', 'Reset', and 'Logout'. The left sidebar contains a navigation menu with categories: Overview, Network, Management, and System Manager. The 'Management' category is expanded, showing 'WiFi Scheduler' as the selected option. The main content area is titled 'WiFi Scheduler' and is divided into two sections: 'Auto Reboot Setting' and 'Wifi - Schedule'. The 'Auto Reboot Setting' section has a 'Status' field with 'Enable' selected and 'Disable' as an option. Below it is a 'Timer' section with radio buttons for each day of the week (Sunday through Saturday) and a time input field showing '0 : 0'. The 'Wifi - Schedule' section has a 'Status' field with 'Enable' selected and 'Disable' as an option. A red note below the status field reads: 'NOTE: Please assure that the Time Zone Settings is synced with your local time when enabling the Wi-Fi Scheduler.' Below the note are three dropdown menus: 'Wireless Radio' (set to 2.4GHz), 'SSID Selection' (set to EnGeniusCCDD10\_1-2), and 'Schedule Templates' (set to Choose a template). At the bottom of the 'Wifi - Schedule' section is a table with three columns: 'Day', 'Available', and 'Duration'. The table contains two rows: 'Sunday' with 'available' in the 'Available' column and '00 : 00 ~ 24 : 00' in the 'Duration' column, and 'Monday' with 'available' in the 'Available' column and '00 : 00 ~ 24 : 00' in the 'Duration' column.

Auto Reboot Setting	
<b>Wifi Schedule</b>	Select to <b>Enable</b> or <b>Disable</b> schedule function.
<b>Timer</b>	Specify the time in regularly rebooting ECB1750 by weekly time.

<b>WiFi Schedule</b>	
<b>Status</b>	Select to Enable or Disable schedule function.
<b>Wireless Radio</b>	Select to 2.4GHz or 5GHz frequency.
<b>SSID Selection</b>	Select SSID which has been set in Wireless Settings.
<b>Schedule Templates</b>	Select the ECB1750 wireless service schedule Always Available or 8-5 daily or 8-5 daily except weekend or you can custom the desired schedule.
<b>Save</b>	Click Save to save changes, and it will be applied after apply it in Changes on UI top right tab.
<b>Accept</b>	Click Accept to save the settings directly.



## 8.9 CLI Setting

Most users will configure the ECB1750 through the graphical user interface (GUI). However, for those who prefer an alternative method there is the command line interface (CLI). The CLI can be access through a command console, modem or Telnet connection.

### CLI Setting

Status  Enable  Disable

CLI Setting	
<b>CLI</b>	Select enable or disable the ability to modify the ECB1750 via a command line interface (CLI).
<b>Apply</b>	Click Apply to apply the changes.

## 8.10 System Log

This page allows you to set up the System log and local log functions of the ECB1750. Click Log under the System Manager tab to open the System log page.

System Log

---

Status  Enable  Disable

Log type

Refresh  
Clear

```

Aug 21 12:28:46 ECB1750 kern.warn kernel: [ 114.080000] cac_timeout cac expired, chan 5500 curr tin
Aug 21 12:28:46 ECB1750 kern.warn kernel: [ 114.080000] Setting vdev param = 3, value = 100
Aug 21 12:27:57 ECB1750 kern.info kernel: [ 65.080000] br-lan: port 3(ath1) entered forwarding state
Aug 21 12:27:52 ECB1750 daemon.info locator[1793]: daemonize: Unable to read pid file [/var/run/locator
Aug 21 12:27:51 ECB1750 cron.info crond[1767]: crond: crond (busybox 1.19.4) started, log level 5
Aug 21 12:27:48 ECB1750 user.notice dnsmasq: DNS rebinding protection is active, will discard upstream
Aug 21 12:27:48 ECB1750 user.notice dnsmasq: Allowing 127.0.0.0/8 responses
Aug 21 12:27:48 ECB1750 daemon.info dnsmasq[1571]: using local addresses only for domain lan
Aug 21 12:27:48 ECB1750 daemon.info dnsmasq[1571]: using local addresses only for domain lan
Aug 21 12:27:48 ECB1750 daemon.info dnsmasq[1571]: started, version 2.66 cachesize 150
    
```

Remote Log  Enable  Disable

Log Server IP Address

**Apply** Apply saved settings to take effect

Log	
<b>Syslog</b>	Enable or disable the syslog function.
<b>Log Type</b>	Select the Log type mode you would like to use.
<b>Remote Log</b>	Enable or disable the Remote Log feature. If Enabled, enter the IP address of the Log.
<b>Apply</b>	Click Apply to apply the changes.

## 8.11 Tools

This page allows you to analyze the connection quality of the ECB1750 and trace the routing table to a target in the network. Click Tools under Management section in left bar.

Ping   Traceroute   Nslookup   Speed Test   LED   Device Discovery

Ping Test Parameters

Target IP / Domain Name	<input type="text"/>
Ping Packet Size	<input type="text" value="64"/> Bytes
Number of Pings	<input type="text" value="4"/>

Tools	
<b>Target IP</b>	Enter the IP address you would like to search.
<b>Ping Packet Size</b>	Enter the packet size of each ping.
<b>Number of Pings</b>	Enter the number of times you want to ping.
<b>Start Ping</b>	Click Start Ping to begin pinging target device (via IP).
Traceroute	
<b>Traceroute Target</b>	Enter an IP address or domain name you want to trace.
<b>Start</b>	Click Start Traceroute to begin the trace route operation.
Nslookup	

<b>Target IP</b>	Enter the IP address of the target PC.
<b>Start</b>	Click Start to begin the DNS look up operation.
<b>Nslookup</b>	
<b>Target IP</b>	Enter the IP address of the target PC.
<b>Time period</b>	Enter time period for the speed test.
<b>Check Interval</b>	Enter the interval for the speed test.
<b>Start Speed Test</b>	Click Start Speed Test to begin the speed test operation.
<b>IPv4 / IPv6 Port</b>	ECB1750 use IPv4 port 5001 and IPv6 port 5002 for the speed test.

## 8.12 Device Discovery

This page shows the EnGenius device(s) connected with ECB1750 same network. Click Tools under Management section in left bar.

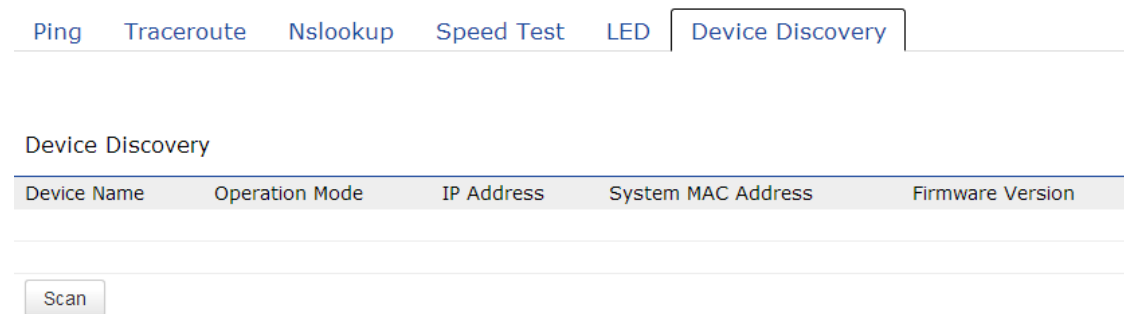

Device Discovery	
<b>Device Name</b>	Displays the name of the devices connected to the network.
<b>Operation Mode</b>	Displays the operation mode of the devices connected to the network.
<b>IP Address</b>	Displays the IP address of the devices connected to the network.
<b>System MAC Address</b>	Displays the system MAC address of the devices connected to the network.
<b>Firmware Version</b>	Displays the firmware version of the devices connected to the network.

### 8.13 LED Control

This page allows you to control LED on/off for Power, LAN interface and 2.4G/5G WLAN interface. Click Tools under Management section in left bar.

Ping Traceroute Nslookup Speed Test **LED** Device Discovery

---

LED Control

Power	<input checked="" type="radio"/> Enable <input type="radio"/> Disable
LAN	<input checked="" type="radio"/> Enable <input type="radio"/> Disable
WLAN-2.4GHz	<input checked="" type="radio"/> Enable <input type="radio"/> Disable
WLAN-5GHz	<input checked="" type="radio"/> Enable <input type="radio"/> Disable

**Apply** Apply saved settings to take effect

# 8.14 Logout

Click Logout on the top right bar.

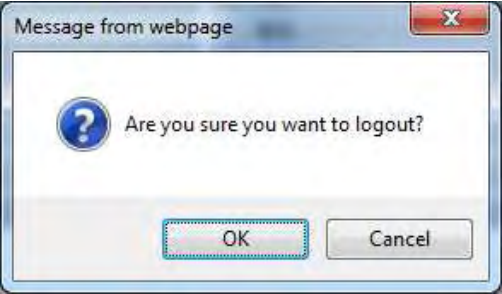
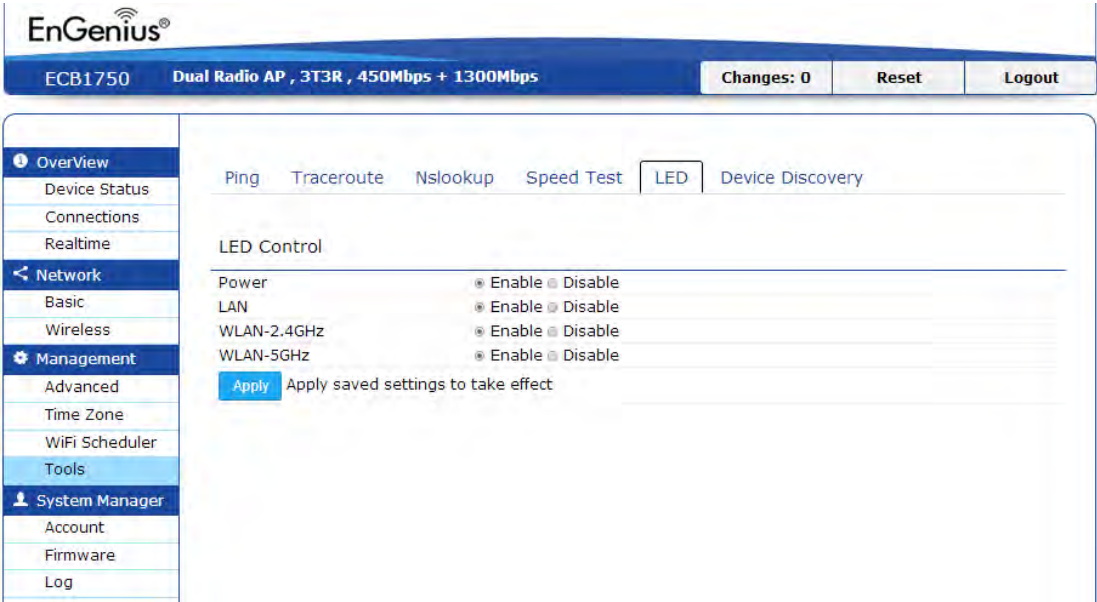

# 8.15 Reset

In some circumstances, it may be required to force the device to reboot. Click on Reboot the Device on the top right bar to reboot the ECB1750.

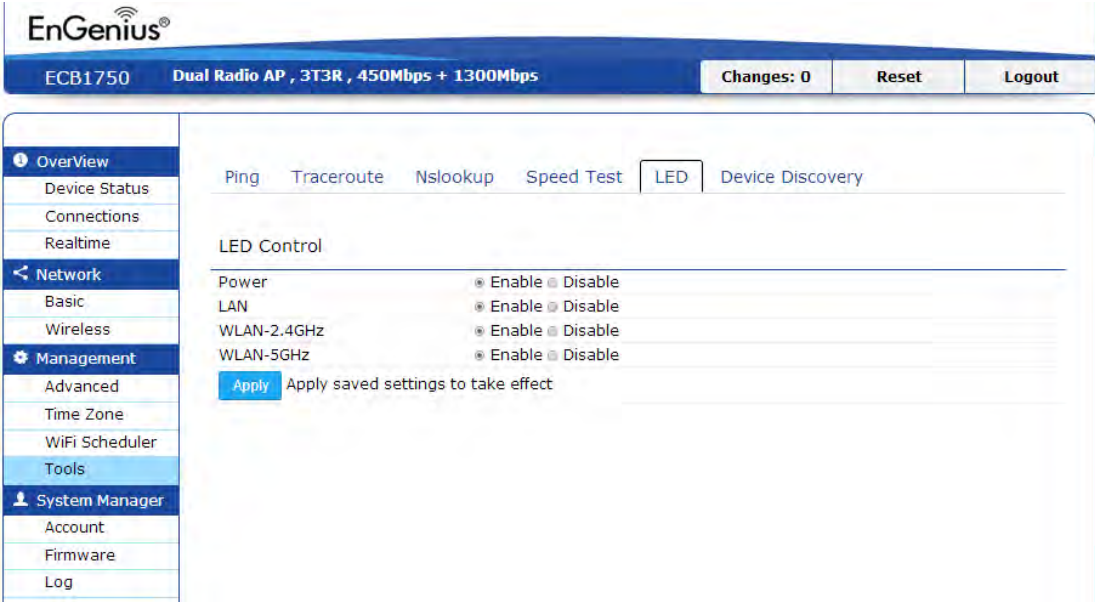



# Appendix A – FCC Interference Statement

---

## **Federal Communication Commission Interference Statement**

This equipment has been tested and found to comply with the limits for a Class B digital device, pursuant to Part 15 of the FCC Rules. These limits are designed to provide reasonable protection against harmful interference in a residential installation. This equipment generates, uses and can radiate radio frequency energy and, if not installed and used in accordance with the instructions, may cause harmful interference to radio communications. However, there is no guarantee that interference will not occur in a particular installation. If this equipment does cause harmful interference to radio or television reception, which can be determined by turning the equipment off and on, the user is encouraged to try to correct the interference by one of the following measures:

- Reorient or relocate the receiving antenna.
- Increase the separation between the equipment and receiver.
- Connect the equipment into an outlet on a circuit different from that to which the receiver is connected.
- Consult the dealer or an experienced radio/TV technician for help.

FCC Caution: Any changes or modifications not expressly approved by the party responsible for compliance could void the user's authority to operate this equipment.

This device complies with Part 15 of the FCC Rules. Operation is subject to the following two conditions: (1) This device may not cause harmful interference, and (2) this device must accept any interference received, including interference that may cause undesired operation.

This transmitter must not be co-located or operating in conjunction with any other antenna or transmitter. Operations in the 5.15-5.25GHz band are restricted to indoor usage only.

### **IMPORTANT NOTE:**

#### **FCC Radiation Exposure Statement:**

This equipment complies with FCC radiation exposure limits set forth for an uncontrolled environment. This equipment should be installed and operated with minimum distance 33cm between the radiator & your body.

# Appendix B – CE Interference Statement

---

## 1.1. Europe – EU Declaration of Conformity

This device complies with the essential requirements of the R&TTE Directive 1999/5/EC. The following test methods have been applied in order to prove presumption of conformity with the essential requirements of the R&TTE Directive 1999/5/EC:

- EN60950-1
- Safety of Information Technology Equipment
  
- EN50385
- Generic standard to demonstrate the compliance of electronic and electrical apparatus with the basic restrictions related to human exposure to electromagnetic fields (0 Hz - 300 GHz)
  
- EN 300 328
- Electromagnetic compatibility and Radio spectrum Matters (ERM); Wideband Transmission systems; Data transmission equipment operating in the 2,4 GHz ISM band and using spread spectrum modulation techniques; Harmonized EN covering essential requirements under article 3.2 of the R&TTE Directive

EN 301 893

Broadband Radio Access Networks (BRAN); 5 GHz high performance RLAN; Harmonized EN covering essential requirements of article 3.2 of the R&TTE Directive

EN 301 489-1

Electromagnetic compatibility and Radio Spectrum Matters (ERM); ElectroMagnetic Compatibility (EMC) standard for radio equipment and services; Part 1: Common technical requirements

- EN 301 489-17
- Electromagnetic compatibility and Radio spectrum Matters (ERM); ElectroMagnetic Compatibility (EMC) standard for radio equipment and services; Part 17: Specific conditions for 2,4 GHz wideband transmission systems and 5 GHz high performance RLAN equipment
-

This device is a 5GHz wideband transmission system (transceiver), intended for use in all EU member states and EFTA countries, except in France and Italy where restrictive use applies.

In Italy the end-user should apply for a license at the national spectrum authorities in order to obtain authorization to use the device for setting up outdoor radio links and/or for supplying public access to telecommunications and/or network services. This device may not be used for setting up outdoor radio links in France and in some areas the RF output power may be limited to 10 mW EIRP in the frequency range of 2454 – 2483.5 MHz. For detailed information the end-user should contact the national spectrum authority in France.

# CE 0560!

[cs]Česky [Czech]	[ <i>Jméno výrobce</i> ] tímto prohlašuje, že tento [ <i>typ zařízení</i> ] je ve shodě se základními požadavky a dalšími příslušnými ustanoveními směrnice 1999/5/ES.
[da]Dansk [Danish]	Undertegnede [ <i>fabrikantens navn</i> ] erklærer herved, at følgende udstyr [ <i>udstyrets typebetegnelse</i> ] overholder de væsentlige krav og øvrige relevante krav i direktiv 1999/5/EF.
[de]Deutsch [German]	Hiermit erkläre [ <i>Name des Herstellers</i> ], dass sich das Gerät [ <i>Gerätetyp</i> ] in Übereinstimmung mit den grundlegenden Anforderungen und den übrigen einschlägigen Bestimmungen der Richtlinie 1999/5/EG befindet.
[et]Eesti [Estonian]	Käesolevaga kinnitab [ <i>tootja nimi = name of manufacturer</i> ] seadme [ <i>seadme tüüp = type of equipment</i> ] vastavust direktiivi 1999/5/EÜ põhinõuetele ja nimetatud direktiivist tulenevatele teistele asjakohastele sätetele.
[en]English	Hereby, [ <i>name of manufacturer</i> ], declares that this [ <i>type of equipment</i> ] is in compliance with the essential requirements and other relevant provisions of Directive 1999/5/EC.
[es]Español [Spanish]	Por medio de la presente [ <i>nombre del fabricante</i> ] declara que el [ <i>clase de equipo</i> ] cumple con los requisitos esenciales y cualesquiera otras disposiciones aplicables o exigibles de la Directiva 1999/5/CE.
[el]Ελληνική [Greek]	ΜΕ ΤΗΝ ΠΑΡΟΥΣΑ [ <i>name of manufacturer</i> ] ΔΗΛΩΝΕΙ ΟΤΙ [ <i>type of equipment</i> ] ΣΥΜΜΟΡΦΩΝΕΤΑΙ ΠΡΟΣ ΤΙΣ ΟΥΣΙΩΔΕΙΣ ΑΠΑΙΤΗΣΕΙΣ ΚΑΙ ΤΙΣ ΛΟΙΠΕΣ ΣΧΕΤΙΚΕΣ ΔΙΑΤΑΞΕΙΣ ΤΗΣ ΟΔΗΓΙΑΣ 1999/5/ΕΚ.
[fr]Français [French]	Par la présente [ <i>nom du fabricant</i> ] déclare que l'appareil [ <i>type d'appareil</i> ] est conforme aux exigences essentielles et aux autres dispositions pertinentes de la directive 1999/5/CE.
[it]Italiano [Italian]	Con la presente [ <i>nome del costruttore</i> ] dichiara che questo [ <i>tipo di apparecchio</i> ] è conforme ai requisiti essenziali ed alle altre disposizioni pertinenti stabilite dalla direttiva 1999/5/CE.

Latviski [Latvian]	Ar šo [ <i>name of manufacturer / izgatavotāja nosaukums</i> ] deklarē, ka [ <i>type of equipment / iekārtas tips</i> ] atbilst Direktīvas 1999/5/EK būtiskajām prasībām un citiem ar to saistītajiem noteikumiem.
Lietuvių [Lithuanian]	Šiuo [ <i>manufacturer name</i> ] deklaruoja, kad šis [ <i>equipment type</i> ] atitinka esminius reikalavimus ir kitas 1999/5/EB Direktyvos nuostatas.
 Nederlands [Dutch]	Hierbij verklaart [ <i>naam van de fabrikant</i> ] dat het toestel [ <i>type van toestel</i> ] in overeenstemming is met de essentiële eisen en de andere relevante bepalingen van richtlijn 1999/5/EG.
 Malti [Maltese]	Hawnhekk, [ <i>isem tal-manifattur</i> ], jiddikjara li dan [ <i>il-mudel tal-prodott</i> ] jikkonforma mal-ħtiġijiet essenzjali u ma provvedimenti oħrajn relevanti li hemm fid-Dirrettiva 1999/5/EC.
 Magyar [Hungarian]	Alulírott, [ <i>gyártó neve</i> ] nyilatkozom, hogy a [ <i>... típus</i> ] megfelel a vonatkozó alapvető követelményeknek és az 1999/5/EC irányelv egyéb előírásainak.
 Polski [Polish]	Niniejszym [ <i>nazwa producenta</i> ] oświadczam, że [ <i>nazwa wyrobu</i> ] jest zgodny z zasadniczymi wymogami oraz pozostałymi stosownymi postanowieniami Dyrektywy 1999/5/EC.
 Português [Portuguese]	[ <i>Nome do fabricante</i> ] declara que este [ <i>tipo de equipamento</i> ] está conforme com os requisitos essenciais e outras disposições da Directiva 1999/5/CE.
 Slovensko [Slovenian]	[ <i>Ime proizvajalca</i> ] izjavlja, da je ta [ <i>tip opreme</i> ] v skladu z bistvenimi zahtevami in ostalimi relevantnimi določili direktive 1999/5/ES.
Slovensky [Slovak]	[ <i>Meno výrobcu</i> ] týmto vyhlasuje, že [ <i>typ zariadenia</i> ] spĺňa základné požiadavky a všetky príslušné ustanovenia Smernice 1999/5/ES.
 Suomi [Finnish]	[ <i>Valmistaja = manufacturer</i> ] vakuuttaa täten että [ <i>type of equipment = laitteen tyyppimerkintä</i> ] tyypinen laite on direktiivin 1999/5/EY oleellisten vaatimusten ja sitä koskevien direktiivin muiden ehtojen mukainen.
 Svenska [Swedish]	Härmed intygar [ <i>företag</i> ] att denna [ <i>utrustningstyp</i> ] står i överensstämmelse med de väsentliga egenskapskrav och övriga relevanta bestämmelser som framgår av direktiv 1999/5/EG.