

User Manual

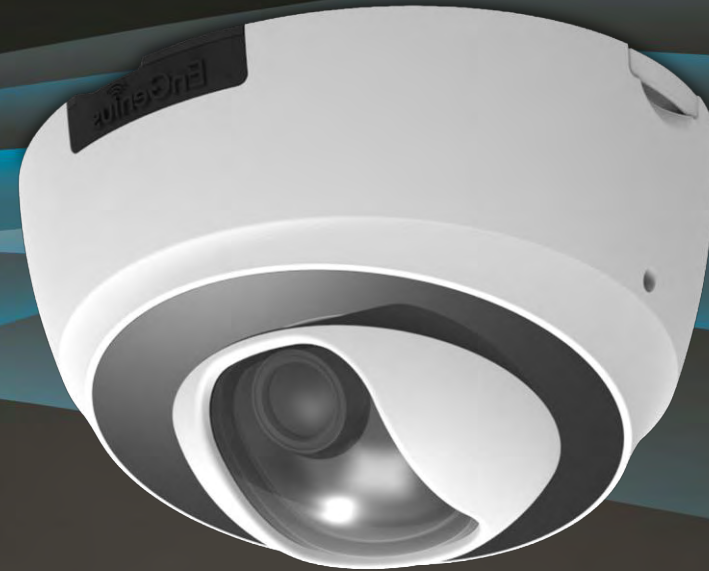

EDS6255
version 1.0

2Megapixel Full HD Wireless Dome Network Camera

Table of Content

1.	Product Overview.....	6
1.1.	Introduction	6
1.2.	Read Before Using	7
1.3.	Key Features	8
1.4.	Package Contents	9
1.5.	Physical Description	10
2.	Installation	11
2.1.	Hardware Setup	11
2.2.	Ceiling / Wall Mount	15
2.3.	IP Camera Connection.....	17
2.3.1.	Connecting via Ethernet Cable.....	18
3.	Accessing the Camera after Installation.....	19
3.1.	Managing using PC or Laptop	20
3.1.1.	EnViewer Finder	20
3.1.1.1.	EnViewer Finder: DDNS	28
3.1.1.2.	EnViewer Finder: Config	30
3.1.1.3.	EnViewer Finder: Upgrade.....	33
3.1.1.4.	EnViewer Finder: Reset.....	34
3.1.1.5.	EnViewer Finder: Reboot.....	35
3.1.2.	Web Browser.....	36

3.2.	Manage using Tablet or Mobile Phones	38
4.	First Time Basic Settings	39
4.1.1.	Setting the Interface Language	44
4.1.2.	Changing the Camera Name	45
4.1.3.	Setting the Camera Time	47
4.1.4.	Setting the Storage Folder	48
4.1.5.	Adding a User Account	49
5.	User Interface	50
5.1.	Navigation Panel	51
5.2.	Live View Settings	54
5.3.	Main Menus	57
5.4.	System	59
5.4.1.	Status	60
5.4.2.	Service Port	61
5.4.3.	Time	62
5.4.4.	PC Storage Path	63
5.4.5.	Firmware	64
5.4.6.	Backup	67
5.4.7.	Reboot/Reset to Default	72
5.4.8.	Language	73
5.5.	Network	74
5.5.1.	IP Configuration	75
5.5.2.	EnGenius Cloud Service	79

5.5.3.	UPnP.....	84
5.6.	Wireless.....	85
5.6.1.	Basic	85
5.6.2.	WPS	88
5.6.3.	AP Profile.....	90
5.6.3.1.	Add	91
5.6.3.2.	Edit	93
5.6.3.3.	Move Up / Down	94
5.6.3.4.	Delete	94
5.6.3.5.	Connect	95
5.7.	Media	96
5.7.1.	Video.....	97
5.7.2.	Camera	99
5.7.2.1.	Light Setting	100
5.7.2.2.	Flicker Control	103
5.7.2.3.	Mirror	104
5.7.2.4.	Day/Night Mode.....	106
5.7.3.	Advanced.....	107
5.7.4.	Privacy Mask	109
5.7.5.	Audio	110
5.8.	Event Management.....	112
5.8.1.	Event Control.....	113
5.8.1.1.	Motion Detection.....	116

5.8.1.2.	Audio Detection	119
5.8.1.3.	Tampering Detection.....	120
5.8.1.4.	Event Action	121
5.9.	Event Server	123
5.9.1.	Network Storage	125
5.9.1.1.	NFS (Network File System).....	126
5.9.1.2.	SAMBA.....	127
5.9.2.	FTP (File Transfer Protocol).....	128
5.9.3.	E-mail Alerts	129
5.10.	Storage Info	131
5.9.	User Management	133
5.10.1.	Add User	135
5.10.2.	Edit User	136
5.10.3.	Delete User.....	138
5.10.4.	Push Message Mobile List.....	140
6.	Camera Connecting to EnGenius Router	141
5.11.	Enable Router Storage Function	144
5.12.	Camera Profile.....	148
5.12.1.	Add Profile.....	148
5.12.2.	Edit Profile.....	151
5.12.3.	Delete Profile	152
5.12.4.	Synchronize	153
5.13.	Fine Tune Camera Configuration set by the Router.....	154

5.14.	Access the Media files on the Router	155
5.14.1.	Using web browser.....	155
5.14.2.	Using Windows File Explorer	159
6.	Camera Connecting to Other Router	162
7.	Application Guide.....	163
7.1.	Example: Remote Surveillance and Motion Detection.....	164
7.1.1.	Step 1: Choose Event Control.....	165
7.1.2.	Step 2: Configure Motion Detection	166
7.1.3.	Step 3: Configure Event Action	167
8.	Trouble Shooting.....	168
8.1.	Viewing Your Video.....	168
8.2.	Networking.....	170
8.3.	Security and Privacy	171
8.4.	Cloud Video Services.....	172
9.	Appendix	173

1. Product Overview

The EDS6255 is a 2-Megapixel Day & Night wireless Dome Network Camera which adds surveillance capability to a variety of network environments. With a built-in removable mechanical IR-cut filter, it helps users keep an eye on what matters and get notified by what just happened on demand allowing 24/7 monitoring remotely.

It features LED Infrared Night Vision with automatic activation system. Megapixel HD with High speed H.264 encoding ensures high quality image recording without losing any details. Infrared Night Vision feature can assist to deliver 24/7 non-stop monitoring. With the support of patented EnGenius Cloud service, users can monitor their surveillance networks remotely in real time any time anywhere on any computer or on iOS or Android based mobile devices using EnGenius APPs.

1.1. Introduction

This document will guide you through detail steps for EDS6255 installation and both basic and advanced configurations. Familiarizing with the product features can help you to fully utilize the camera for various application scenarios. Please note that the product feature may improve over time, be sure to check out the latest firmware and user's manual for most updated changes on EnGenius web site.

Thank you for choosing **EnGenius** products.

1.2. Read Before Using

For users' convenience, the camera is configured with DHCP enabled by default which allows the camera to get an IP address for itself automatically. This applies to majority of the surveillance network settings. However, if you are connecting the product in an office (or any public setting), you may need to consult the IT department in charged for IP setting detail to avoid IP address conflict.

Like all electronic devices, do not install the product in hazardous environment where humidity or temperature is high to avoid danger. This camera is designed for indoor usage; when the camera is wall-mount installed, please secure the camera and wires in place to prevent it from dangling.

1.3. Key Features



- Megapixel HD Resolution to Deliver Quality Streaming on A Variety of Mobile Devices and PCs
- LED Infrared Night Vision up to 49 Feet (15 Meters) with Automatic Activation System
- Wireless N Network Compliant with Optimum Wi-Fi Performance
- Supports Simultaneous Dual-Stream Recording with High Speed H.264 Encoding
- Built-in Microphone
- Multiple Storage Options—Built-in Micro SD/SDHC Slot for Onboard Storage and Samba/FTP Client to Save to an External Storage
- Supports Push Message and Play Back on Smart Devices triggered by Motion
- EnGenius Cloud Services Supported (Apps and Web-based Services)

1.4. Package Contents

The package should contain all of following items shown below.



EDS6255



CD with User Manual and Software



Ceiling Mount Hooks



Power Adapter

RJ-45 Ethernet Cable

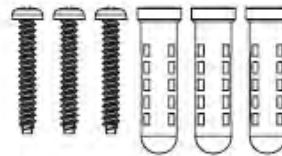

Screws / Plastic Anchors

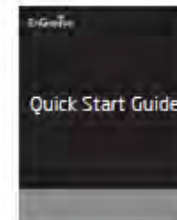

Quick Start Guide

1.5. Physical Description

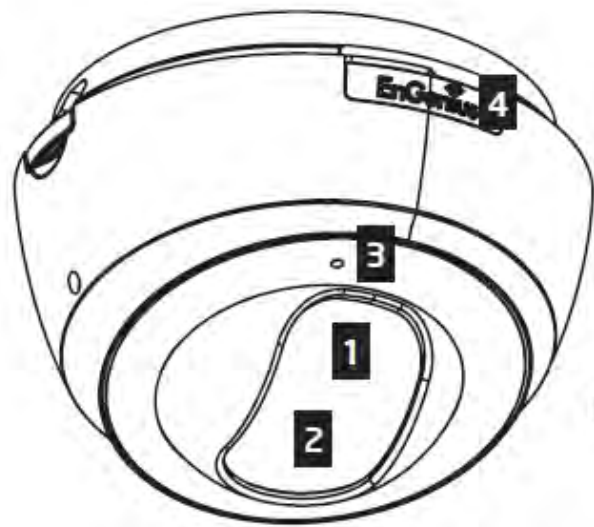

- 1** IR LEDs
- 2** Built-in LENSs
- 3** Built-in MIC
- 4** Micro SDHC Slot / Reset button

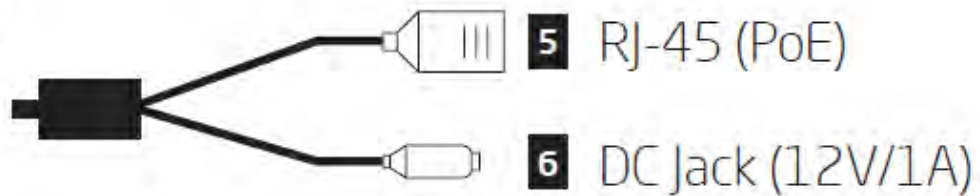

5 RJ-45 (PoE)

6 DC Jack (12V/1A)

2. Installation

2.1. Hardware Setup

Before installing the camera, please make sure the camera is properly configured and tested before hardware installation especially if it is mounted on a wall. Please also make sure the power outlet is available near the installation site.

I. **Basic Connection (without PoE)**

A) Connect the camera to a switch via Ethernet Cable.

B) Connect the supplied power cable from the camera to the power outlet.

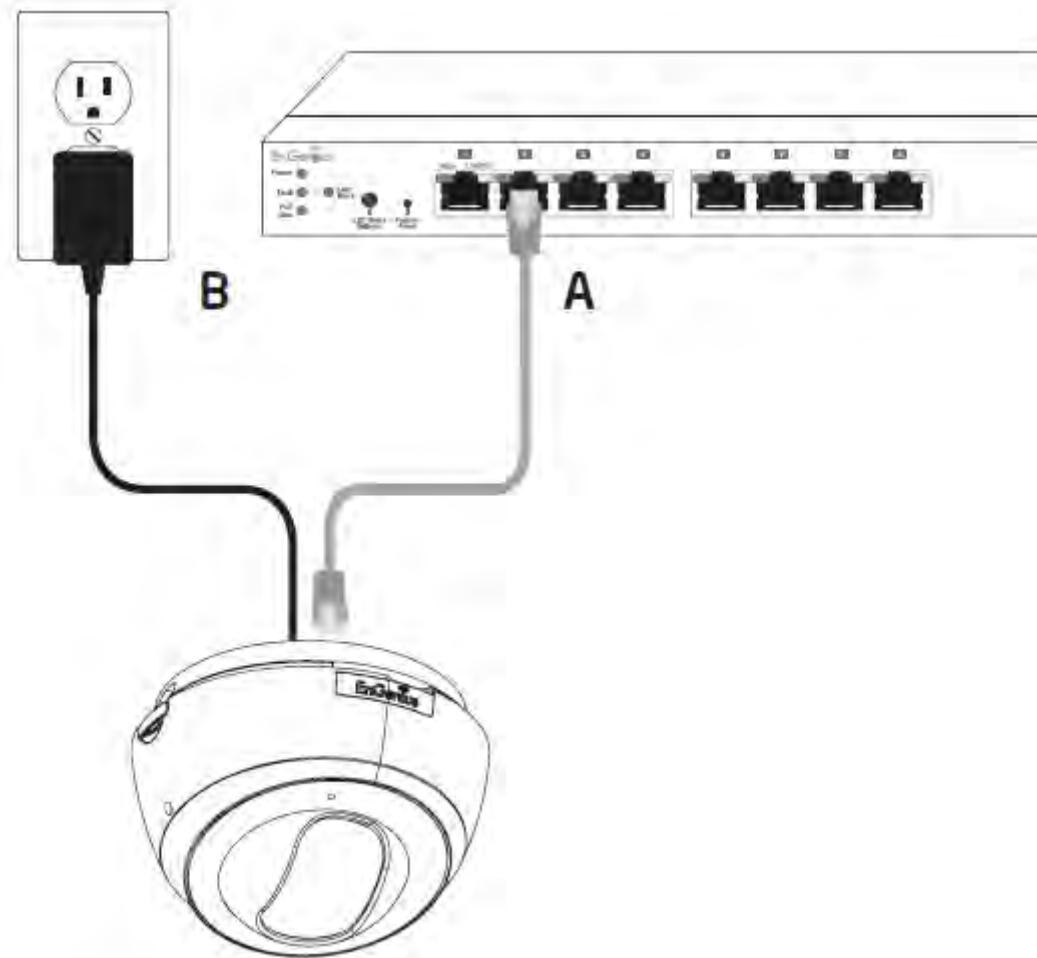

II. Power over Ethernet (PoE) Connection

A) When connecting to PoE-Enabled Switch:

The camera is PoE compliant, please connect the Ethernet Port from the Cable Harness to a PoE-enabled Switch using single Ethernet Cable.

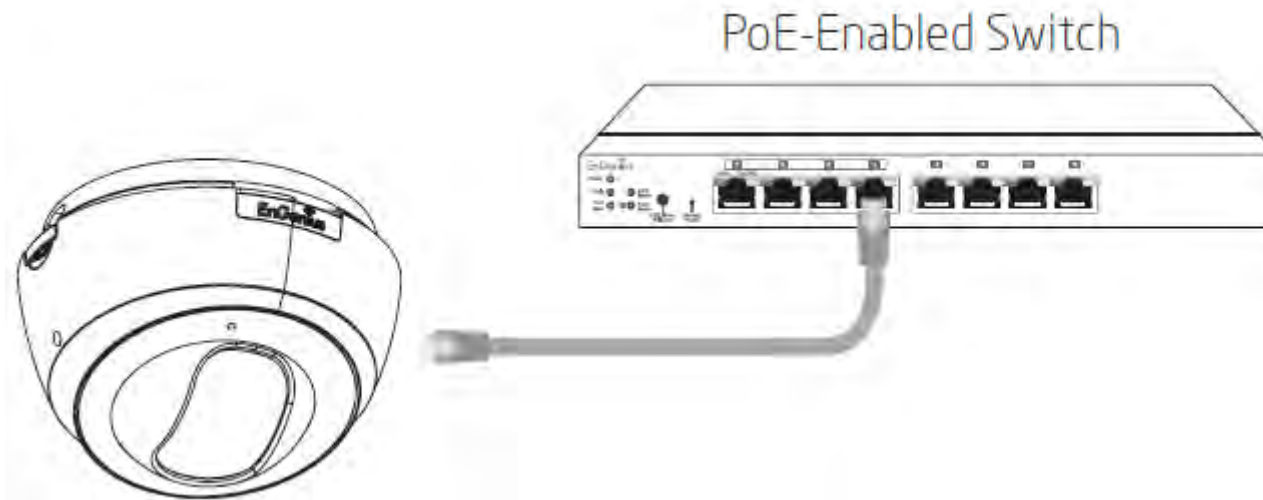

B) When connecting to a non-PoE Switch:

Connect the camera to a non-PoE Switch via PoE Injector (optional).

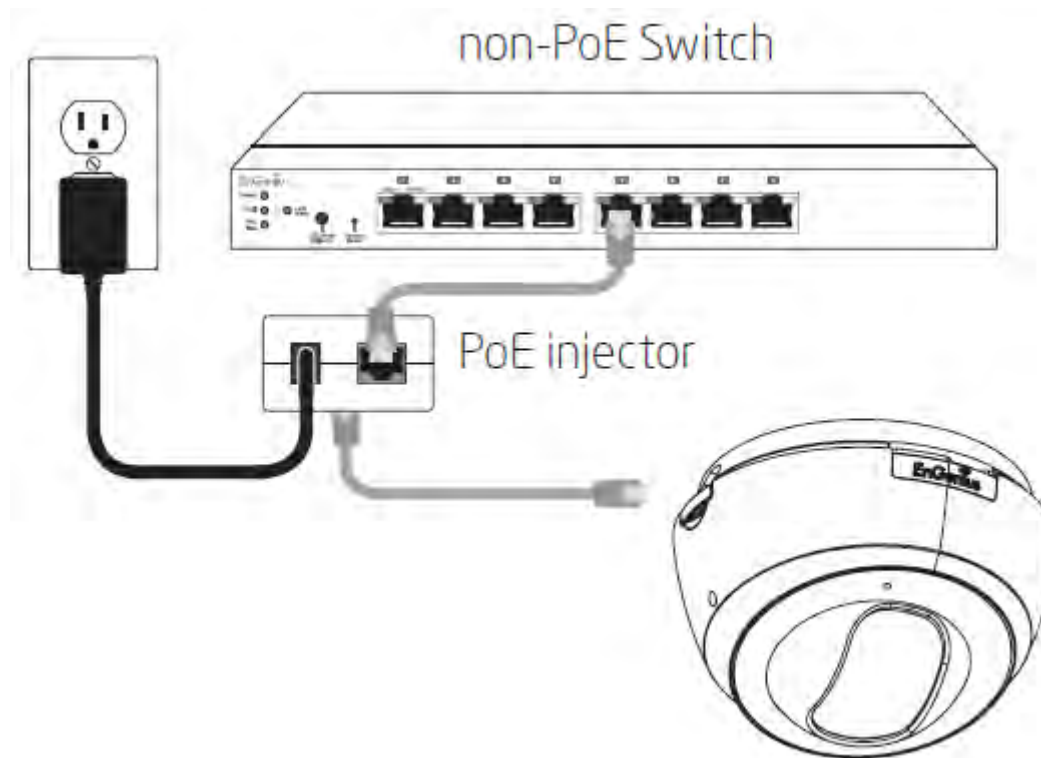

2.2. Ceiling / Wall Mount

- Locate an area on the ceiling / wall and make sure the area is capable of supporting the weight of camera.
- Use the ceiling mount bracket screw slots to drill the mounting screws into the ceiling or wall.
- Twist the camera body into the ceiling mount bracket and route cables into the side of conduit entry tunnel.
- Twist the camera to set counter-clockwise carefully and slowly until it is secured firmly.

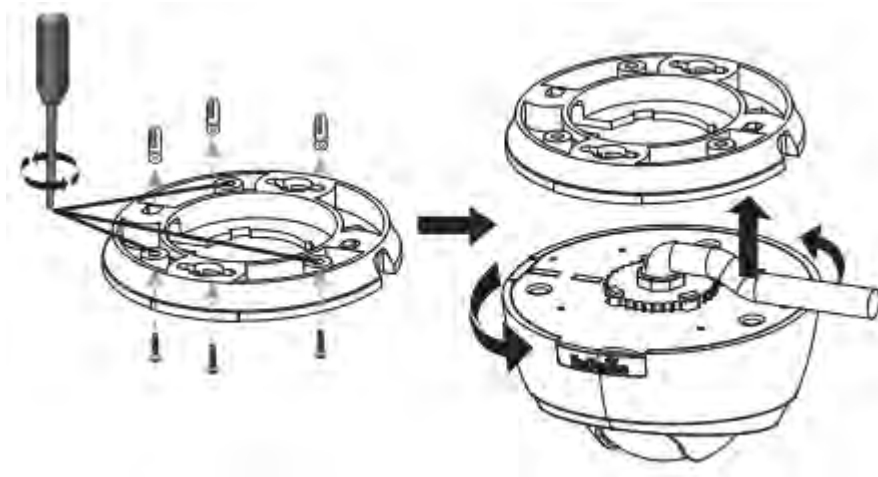

For Installation with ceiling mount hooks into the ceiling light grid steel framing, first use the hooks and screw into the ceiling mount bracket until fixed upon the ceiling light grid steel framing. When done, twist the camera until it is secured.

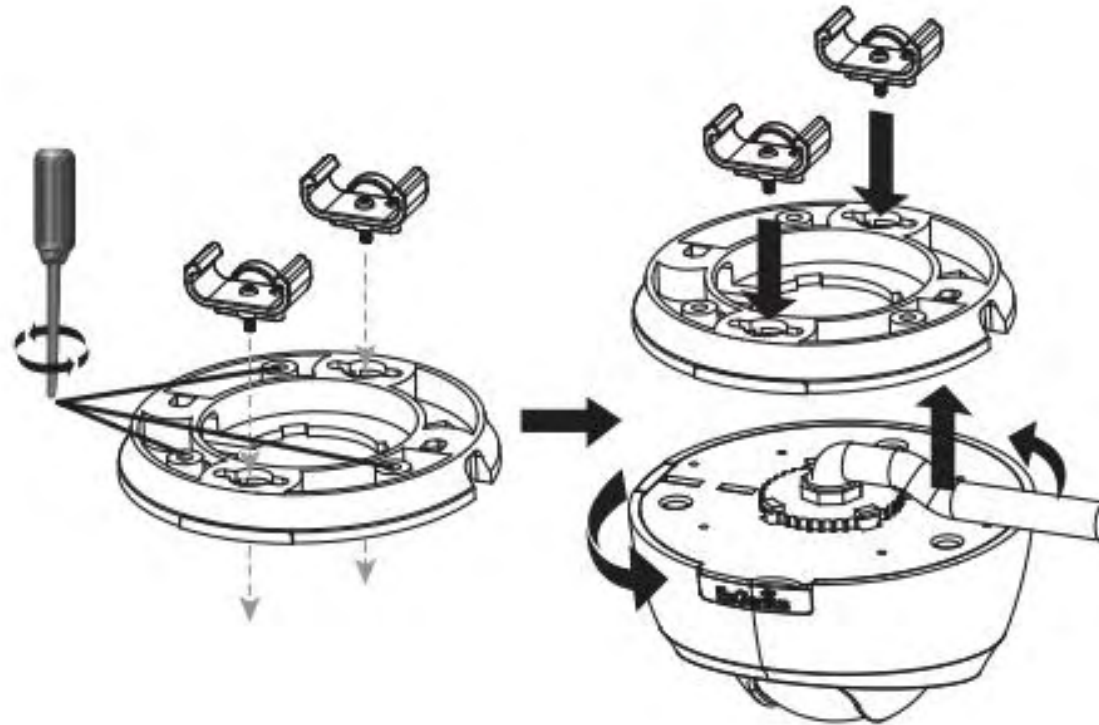

2.3. IP Camera Connection

Before setting up the camera with your router, please ensure the Internet is ready. When camera is configured with the router with Internet connection, you can then access the camera through the Internet anytime anywhere. This section will guide you through the connection setup. Please follow the following guide step by step to setup the connection between your camera and the router. There are two ways to establish connection between the camera and router: Wired (Ethernet) and Wireless (Wi-Fi).

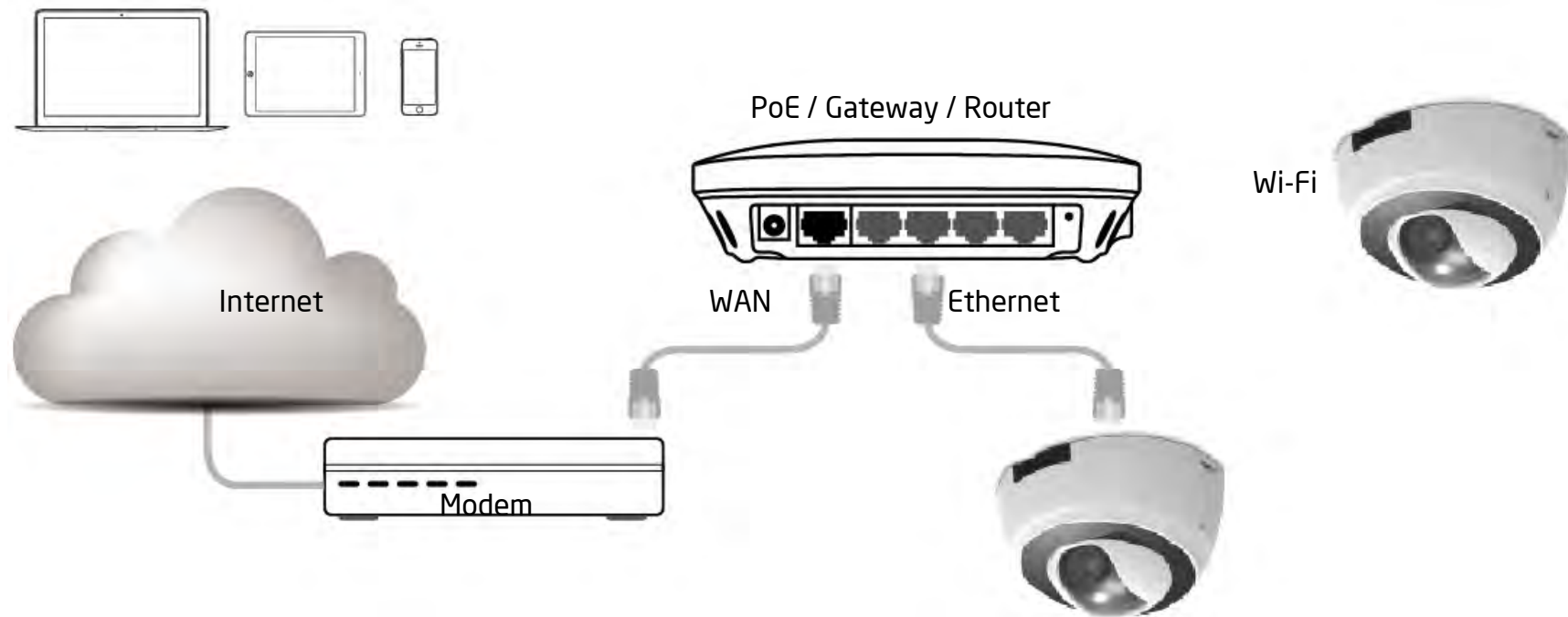

2.3.1. Connecting via Ethernet Cable

Connect the camera to the router on the LAN ports with a network RJ45 Ethernet cable (shown below). You may use the cable that came with the package for initial setup; however, you may be required to switch to wireless setting or purchase a longer cable to extend the camera for longer range. As a rule of thumb, if your camera is close enough to the router use Ethernet cable if possible for optimized result; and for wall mount installation, it's best to adopt wireless setup. You can choose either way for the application you find suitable.

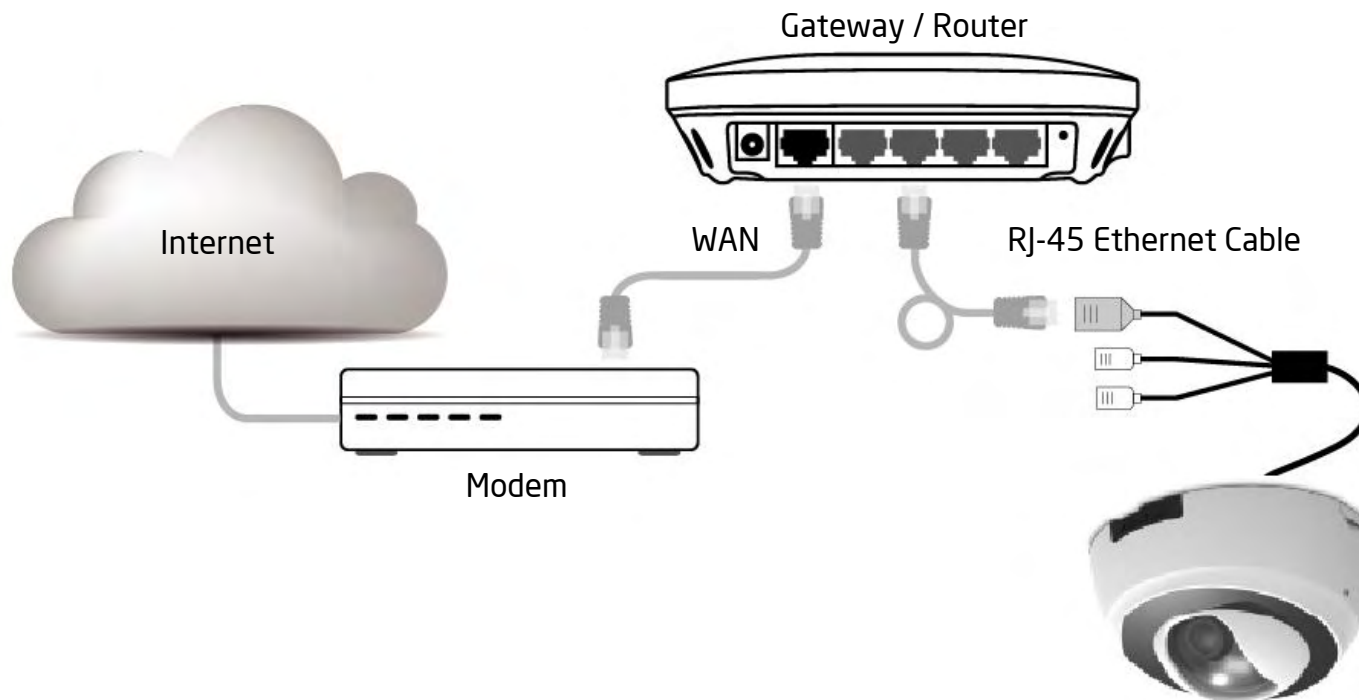

3. Accessing the Camera after Installation

There are several ways to get access to your camera on your network. You should probably have a setup similar to the following diagram. You can manage the camera using your PC, Laptop, Tablet or iOS/Android based on mobile phone; we will call it **management station** in the following context. The key point is that management station and the camera must be connected under the same subnet.

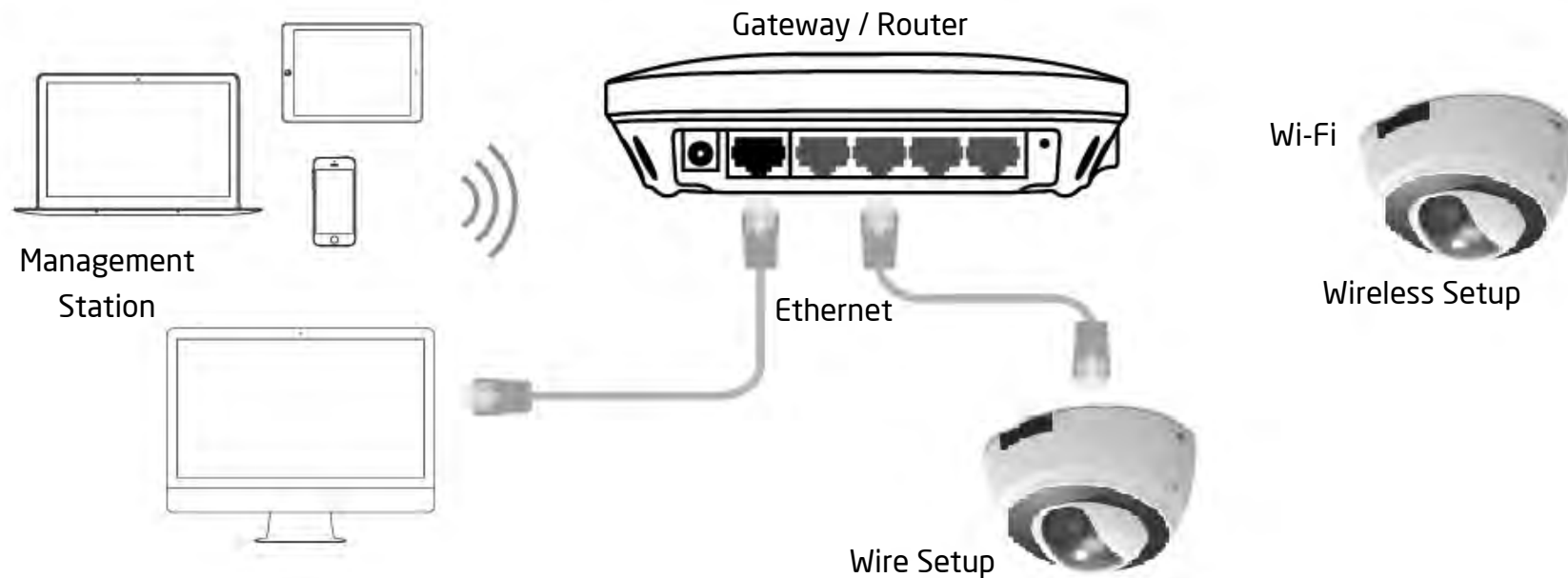

3.1. Managing using PC or Laptop

3.1.1. EnViewer Finder

EnViewer Finder is a tool provided by EnGenius that helps you discover the camera within a local network. You should be able to find the tool inside the CD. Please install the tool to your **management station** desktop for quick access when you need it. Please take note of the IP address shown. In this example, **192.168.0.101** is the camera IP address.



Double-click on the icon to run.

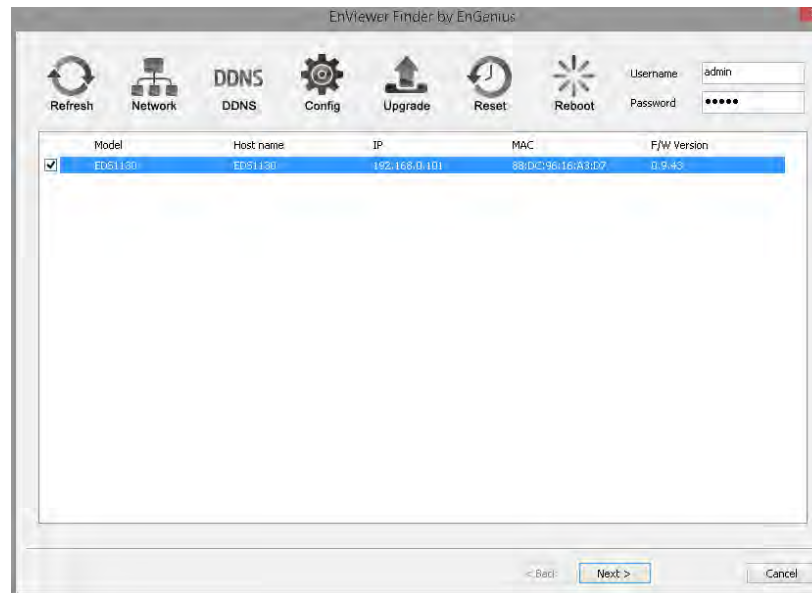

The camera list at the center displays the discovered cameras currently connected to your router (local network). If you do not find the one you intend to configure, please click on **Refresh**  to rescan the network until it appears on the list. Please turn off any heavy-loading applications such as P2P that may occupy your network.

Enter **Username** and **Password** for the selected camera on the list.
Click on **Next** to start configuration.

The **EnViewer Finder** will guide you step by step through the basic settings Network, DDNS and Config. You can also switch between settings by clicking the icons on the panel.



Rescan the network for camera.



Go to Network setting



Go to DDNS setting



Go to Camera Video Configuration setting



Upgrade the current camera firmware



Reset the current camera to factory default



Reboot/restart the current camera

EnViewer Finder: Network

Home Network DDNS Config Upgrade Reset Reboot

Mode
 DHCP Manually PPPoE

TCP/IP
IP: 192 . 168 . 0 . 101
Subnet mask: 255 . 255 . 255 . 0
Gateway IP: 192 . 168 . 0 . 1
DNS IP: 192 . 168 . 0 . 1

PPPoE
Username: _____
Password: _____

LPrP
 Enable LPrP

System time
Time setup: Sync with NTP
Timezone: (GMT+08:00) Taipei, Taiwan
NTP server: pool.ntp.org

Enable daylight saving
Start: JAN 1st - SUN 12AM
End: JAN 1st - SUN 12AM

Authorization
Password of 'admin': _____
Confirm password: _____
Camera name: EDS

< Back Next >

MODE: There are three modes that your camera can get its IP address. **DHCP**, **Manually**, or **PPPoE**.

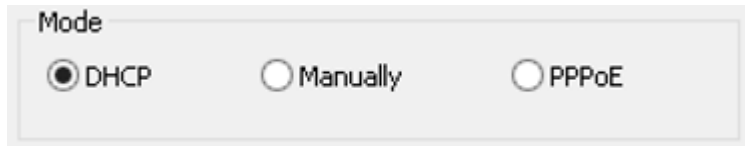

Mode

DHCP Manually PPPoE

DHCP:

It is the most popular way in the home network setting. It will request IP address from your router automatically. The requirement is that your router should enable DHCP (which is basically the default setting for most of the home router vendors). You are not required to enter any IP related information.

Manual:



TCP/IP

IP	192 . 168 . 0 . 101
Subnet mask	255 . 255 . 255 . 0
Gateway IP	192 . 168 . 0 . 1
DNS IP	192 . 168 . 0 . 1

You will need to assign the IP address details in TCP/IP section. Please ensure that the IP address is not being used by someone else in the network.

PPPoE:

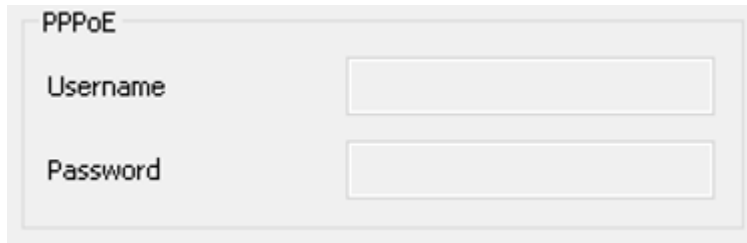

PPPoE

Username

Password

If you are connecting to the Internet without going through your router, you can connect the camera directly to your modem (given that your Internet service is using PPPoE protocol). Please consult your local ISP provider for more detail. Basically, the PPPoE setting is exactly the same as your router. You need to provide at least the **Username** and **Password** to get access.

UPnP: this feature must be enabled so that the camera can be discovered by UPnP services. Leave it **enabled** if you unsure what UPnP is.

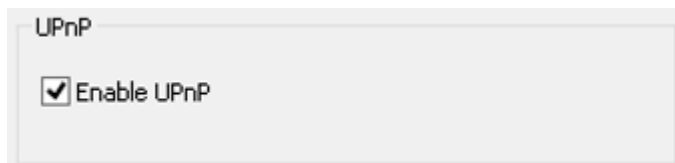

UPnP

Enable UPnP

System Time:

Like any other surveillance system, time is essential because we want to keep track of the time of the events recorded or detected by the camera. By default, the camera is connected to a public NTP server (pool.ntp.org) and its time is always synchronized with the server over the Internet. Normally, you only need to change the **Time Zone**. Choose the one that matches your location. Leave the other setting as default should be fine. Setting the wrong time server or time zone will result in inaccurate scheduling and time stamp.



The screenshot shows a configuration window titled "System time". It contains the following settings:

- Time setup:** Sync with NTP (dropdown menu)
- Timezone:** (GMT+08:00)Taipei, Taiwan (dropdown menu)
- NTP server:** pool.ntp.org (text input field)
- Enable daylight saving**
- Start:** JAN 1st SUN 12AM
- End:** JAN 1st SUN 12AM

Authorization:

You may change the **Password of 'admin'** or **Camera Name** here. Please note that, once you changed the password. You will need to provide your new password next time upon login to the camera through EnViewer Finder or Web Browser. The Camera Name is the camera host name that represents the identity of the camera. If you installed several cameras, please assign a unique name for each camera for better identification.



The screenshot shows a configuration window titled "Authorization" with three input fields:

- Password of 'admin'**: A text box containing six black dots, indicating a masked password.
- Confirm password**: A text box containing six black dots, indicating a masked password.
- Camera name**: A text box containing the text "EDS".

3.1.1.1. EnViewer Finder: DDNS

The screenshot shows the DDNS configuration page in the EnViewer Finder interface. At the top, there is a navigation bar with icons for Home, Network, DDNS (highlighted), Config, Upgrade, Reset, and Reboot. Below the navigation bar, the page title is "Engenius DDNS". The configuration fields are as follows:

- Default DDNS name:
- DDNS alias: .engeniusddns.com
- Refresh time: (dropdown menu)

At the bottom of the page, there are two buttons: "< Back" and "Next >".



Engenius DDNS

Default DDNS name: 0e95c28.engeniusddns.com

DDNS alias: superman .engeniusddns.com

Refresh time: 24hr

Default DDNS name: Each camera has a unique DDNS name printed on the back of your camera. It is the default DDNS name.

DDNS Alias: You may try to rename it (**alias**) to a name so that you can memorize it better. For instance, you can use your initials with your birthday as a combination; for example, **ab19791220**. Then you need to check whether the name has been taken by someone else by clicking on **Check Availability** button. If the alias is not being used by others, then you can access the camera with both your default DDNS and the new alias DDNS (**ab19791220.engeniusddns.com**).

Refresh Time: options are 3HR, 6HR, 9HR, 12HR and 24HR. DDNS server needs to synchronize with your IP address often so that you can access your device over the Internet with DDNS name. Depends on your Internet Service provider, your WAN IP address lease time will be different. You can check with your local Internet Service provider for WAN IP address refresh time. The default setting is **24HR** (which means DDNS server will check the synchronization **every 24 hours**). Normally, the default setting 24HR is okay for most cases.

3.1.1.2. EnViewer Finder: Config

The screenshot displays the configuration page for EnViewer Finder. At the top, there is a navigation bar with icons for Home, Network, DDNS, Config (highlighted), Upgrade, Reset, and Reboot. Below this, the configuration is organized into two sections: Stream 1 and Stream 2. Each section includes a URL input field, a Resolution dropdown menu, a Codec dropdown menu, and a Max. frame rate slider. At the bottom right, there is a checkbox labeled "Open the device web browser". At the very bottom, there are two buttons: "< Back" and "Finish".

Stream 1

URL:

Resolution: Codec:

Max. frame rate:

Stream 2

URL:

Resolution: Codec:

Max. frame rate:

Open the device web browser

< Back Finish

The image shows a configuration interface for two RTSP streams. It is divided into two sections: Stream 1 and Stream 2. Each section contains a URL input field, a Resolution dropdown menu, a Codec dropdown menu, and a Max. frame rate slider. Stream 1 is configured with URL 'rtsp://192.168.0.101:5540/live/ch01_0', Resolution '720P', Codec 'H264', and a slider for Max. frame rate. Stream 2 is configured with URL 'rtsp://192.168.0.101:5540/live/ch02_0', Resolution 'VGA', Codec 'H264', and a slider for Max. frame rate.

URL

The URLs are provided for your reference. There are many 3rd party media player that supports RTSP streams. You can provide these URLs to those players and view the camera streams in real time.

Resolution

Usually you do not need to worry about this page setting. However, you may need to know that the camera has two concurrent video streams running at the same time. **Stream 1** serves for monitoring over browser while **Stream 2** serves mobile APP EnViewer. The reason that Stream 2 has lower resolution (VGA) is that mobile devices have smaller screens and have limited network bandwidth than regular PC/Laptop; therefore, keeping lower resolution helps to smoother the view.

Codec

This setting determines what codec used for video compression. Please use the default for optimized performance. The compression method affects overall performance and media file size. The options are reserved for advanced purposes only.

Max frame rate

This setting determines how many frames are taken per second. This setting affects the quality of the video. High frame rate results in smoother video but larger video file.

Open the device web browser

Please **Select** this option before hitting **Finish** button. This will open the web browser with the detect Camera IP address entered in the web browser URL for you. Please bookmark it to your favorite so that you don't have to memorize the IP address when next time you want to login into the camera. You can also use your DDNS name to access the camera management page. Either way works fine.

Click **Finish** when completed.

3.1.1.3. EnViewer Finder: Upgrade



EnViewer Finder also allows you to upgrade your camera firmware. The product feature may improve over time, you may check EnGenius official web site for the latest firmware. New firmware may contain bug fixes or feature improvement; please download the latest firmware file to your local computer first before proceeding further:

Click **Browse** and select the firmware file you downloaded.

Click **Update** to proceed with upgrade process.

It may take a moment for the upgrade process; please wait patiently.

WARNING: Do not turn off the device in the middle of upgrade process. Terminating the device during the process will damage the device and may cause the device to fail.

3.1.1.4. EnViewer Finder: Reset



You can **reset** the camera to its factory default state and your settings on the camera will be erased.

Note: It will take a while for the camera to come back on again. Therefore, the camera will not appear on the camera list if you rescan the network before it resets to default and boots up.

3.1.1.5. EnViewer Finder: Reboot



You can **reboot** the camera on EnViewer Finder if the camera stops responding for unknown reason.

Click on **Yes** to proceed.

Note: It will take a while for the camera to come back on again. Therefore, the camera will not appear on the camera list if you rescan the network before it boots up.

3.1.2. Web Browser

You can use web browser on the management station to access the camera by entering IP address or DDNS of your camera. DDNS works only if your router is connected to the Internet. Please refer to the previous section if you do not know the IP address or DDNS of your camera.

For this example we have our DDNS and IP address as follows:

DDNS: ab19791220.engeniusddns.com

IP Address: 192.168.0.101

If you are using EnGenius **Intelligent Router** or **IoT Gateway** please proceed to **Manage camera over EnGenius Router** chapter. If not, please proceed to **First Time Basic Setting** chapter for more detail guide on camera initial settings.

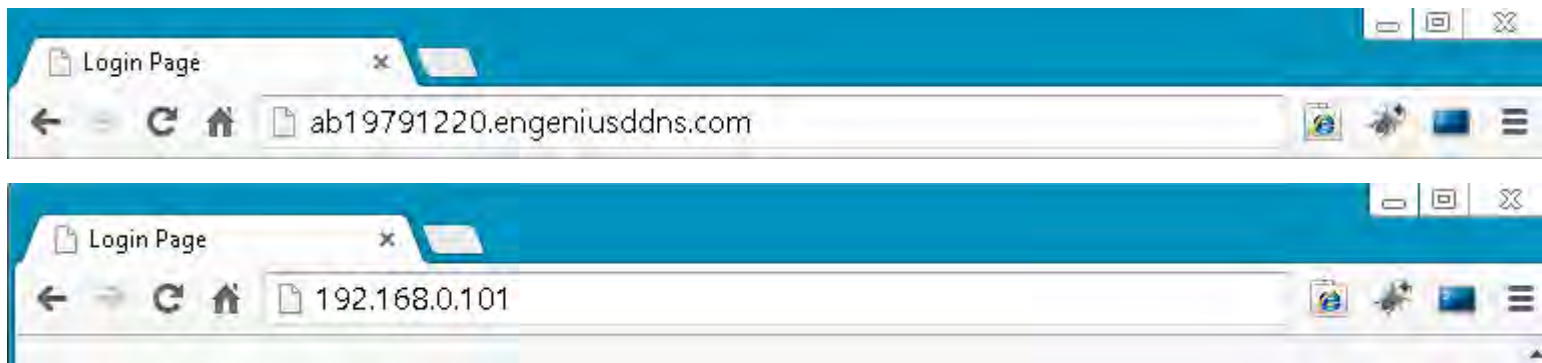

EnGenius Router/Gateway

If you are using EnGenius Intelligent Router or IoT Gateway, you can manage the camera through the router management interface. The benefit of this is that you can manage both the router and the camera on a single integrated user interface. Please refer to **Manage camera over EnGenius Router** section for detail.

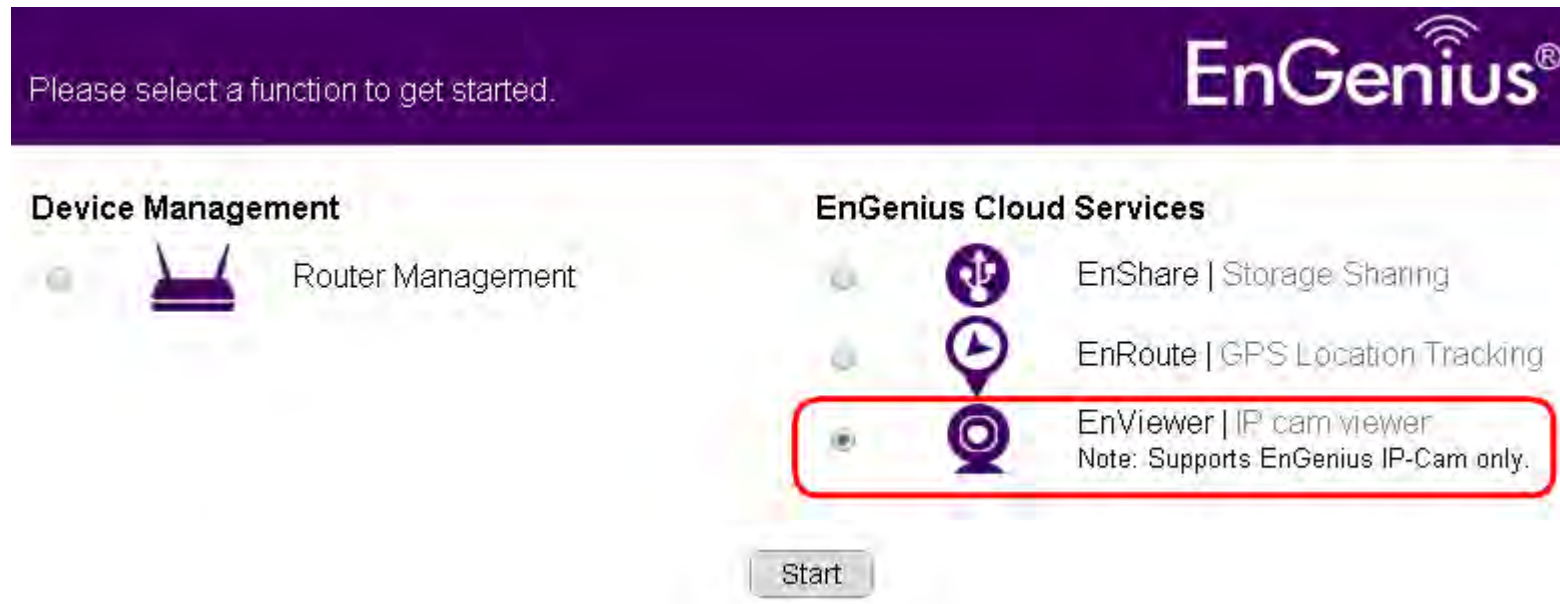

3.2. Manage using Tablet or Mobile Phones

You can manage your camera over Tablet or Mobile Phones using the free EnGenius APP **EnViewer**. EnViewer currently supports the two most popular Android and iOS platforms. Please search the keyword “EnViewer” in Google Play or iOS Store.

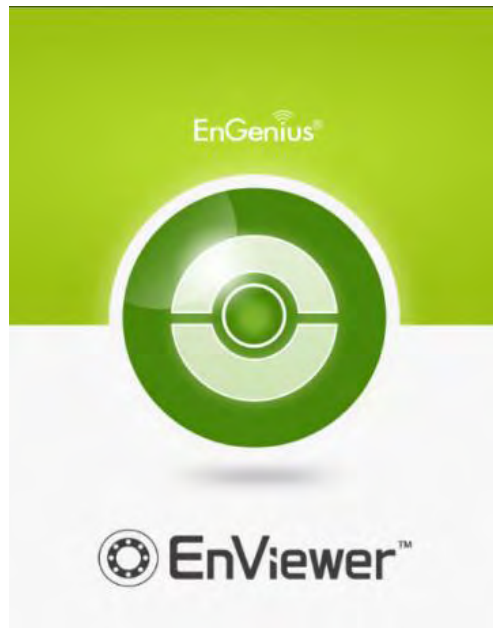

4. First Time Basic Settings

Open your browser and type in the camera IP (e.g. 192.168.0.103) address or the given DDNS name printed on the label on the back of your camera (e.g. 0f9e76a.engeniusddns.com) using a regular web browser.

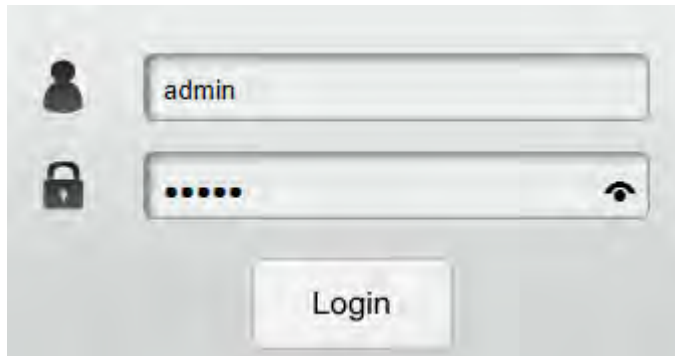

A login form with a light gray background. On the left side, there are two icons: a person icon above a padlock icon. To the right of the person icon is a text input field containing the word "admin". Below the text input field is a password input field with six black dots and a small eye icon on the right side. Below the password input field is a rectangular button with the word "Login" centered on it.

Enter the default username **admin** and password **admin**. Click **Login** to proceed.

For the first time of login, you will be informed to download and install “**WebCMS**”. Please click on “**Download WebCMS**” to start download (you will be required to have Internet connection on your router). WebCMS enables browsers to support camera feature. Don’t worry if you are prompted with a different version number because the software upgrades from time to time.

WebCMS 0.2.3.0

Installation of IP Camera "WebCMS" plug-in control requires your attention.
You need to download the latest "WebCMS" plug-in and install to continue view
camera web user interface.

Download WebCMS

If prompted with the following question, click on **Save (Internet Explorer)**.

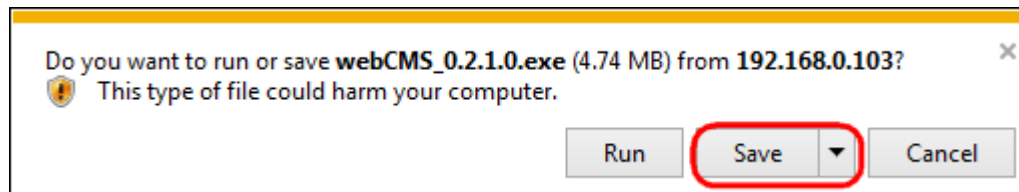

Save the downloaded file.

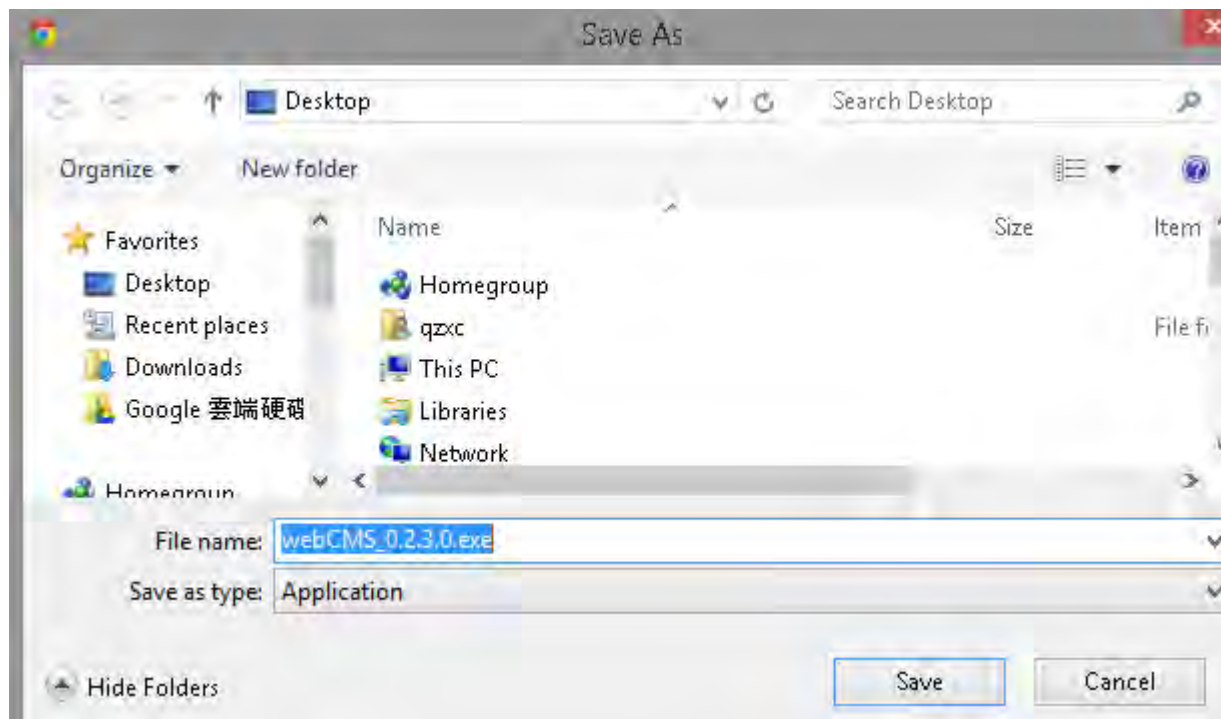

Once download is completed, you **MUST close all the browsers** before install WebCMS.



Double click on **WebCMS** to install the program. You may not have noticed, the installation is very fast, it only takes a few seconds for **WebCMS** to be installed.

When installation is completed, open the browser and login into the camera again. You should be able to see the camera viewer in live as shown below. If you do not see the viewer that means you did not install **WebCMS** properly or try login using other browsers.

NOTE: If you are seeing grey color in the viewer, it is because the camera has detected insufficient of light in the room and enabled night vision mode automatically. If you point your camera to a brighter area, you should be able to see it switched to normal color mode. Try a few places to get a feeling on how it works. If listening closely, you may hear the click sound from the camera when night vision is switched on and off.

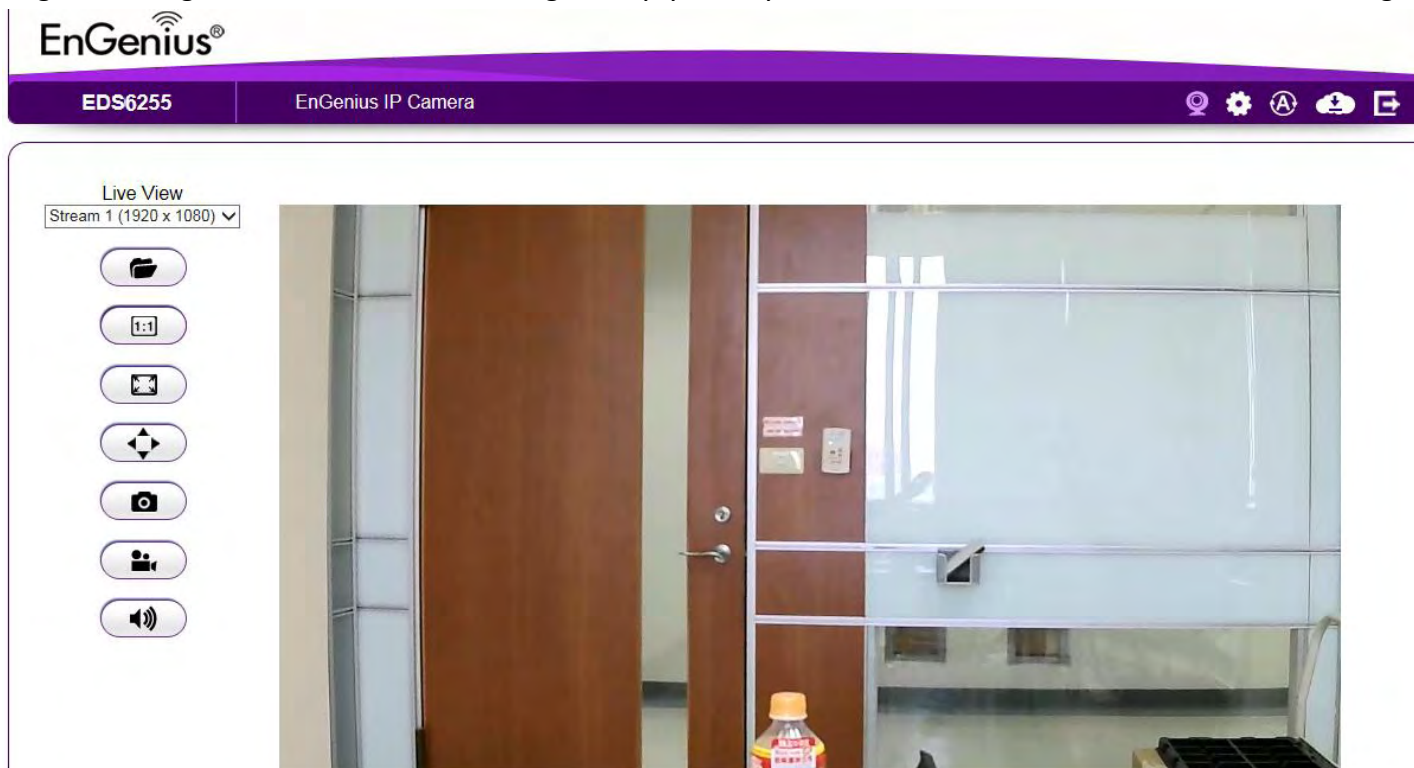

Congratulations, you are now ready to proceed with further camera settings!

4.1.1. Setting the Interface Language

First of all you may want to change the user interface language. The default factory language is English. To change the language, click on



icon to make the change. On the language list, click to select the one you feel comfortable with from the list. The user interface will refresh automatically with your chosen language.

Select Display Language

Choose your language ▼
Choose your language
English
繁體中文
Español
Português
Français
Deutsch

4.1.2. Changing the Camera Name



On the management page, click  to access the configuration Main Menu.

On the Main Menu, select **Network** → **UPnP**

Then, you may want to assign the camera with proper names for better identification if you have several cameras at the same time. Meaningful names such as living room, kitchen, baby room or any other descriptions you find suitable to describe the space being monitored.

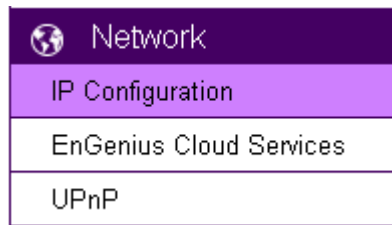

Select **Network** → **UPnP**

Host Name

UPnP

Enable Disable

UPnPc

Enable Disable

Apply

Cancel

Hostname: Enter a new name into this field

Click **Apply** to change the camera name.

4.1.3. Setting the Camera Time

It is crucial to setup camera time properly so that scheduling can be arranged and events be recorded with accurate date and time.

On the Main Menu, select **System**→ **Time**

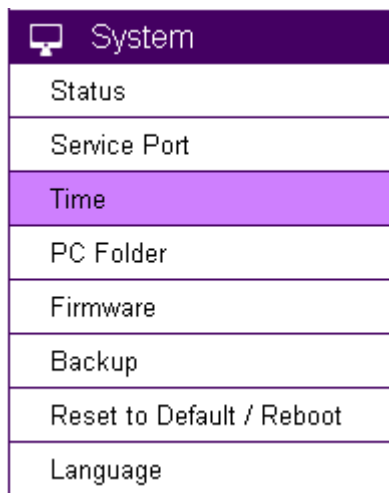

 System
Status
Service Port
Time
PC Folder
Firmware
Backup
Reset to Default / Reboot
Language

Please refer to **Chapter 5** for time setting detail.

4.1.4. Setting the Storage Folder

The Storage Folder is the location where media files will be placed.

On the Main Menu, select **System** → **PC Storage Path**

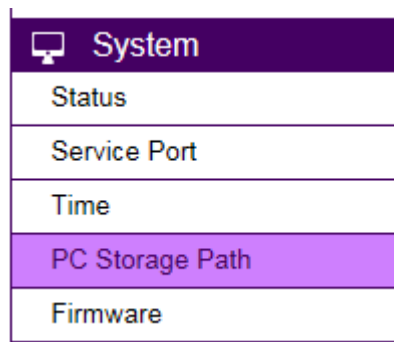

 System
Status
Service Port
Time
PC Storage Path
Firmware

Please refer to **Chapter 5** for detail setting

4.1.5. Adding a User Account

On the Main Menu, select **User Management** → **User Account**

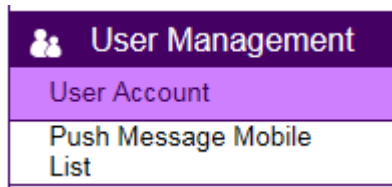

Please refer to **Chapter 5** for User Management for adding a User.

5. User Interface

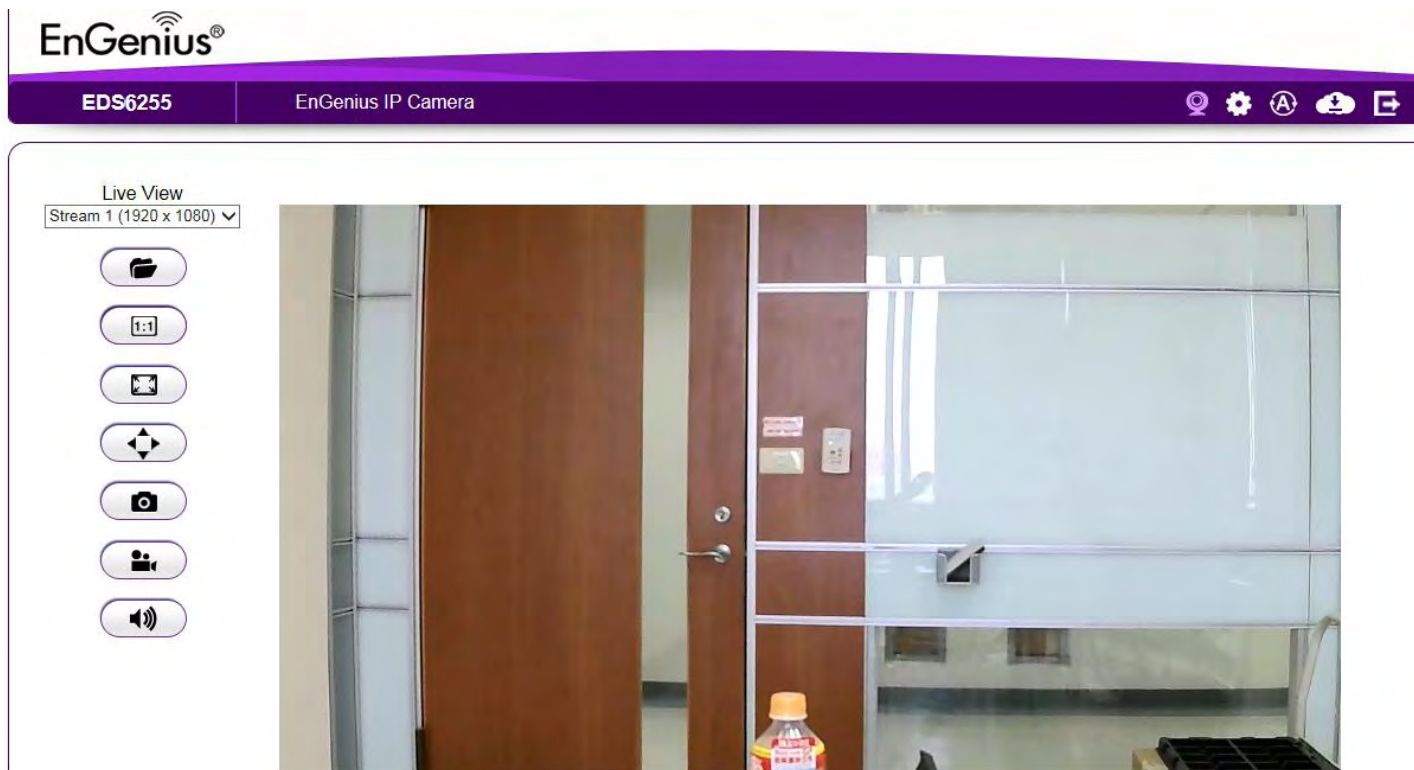

Camera management page allows you to view and configure the camera at real time. This chapter will introduce all supported features and detail configurations.

5.1. Navigation Panel

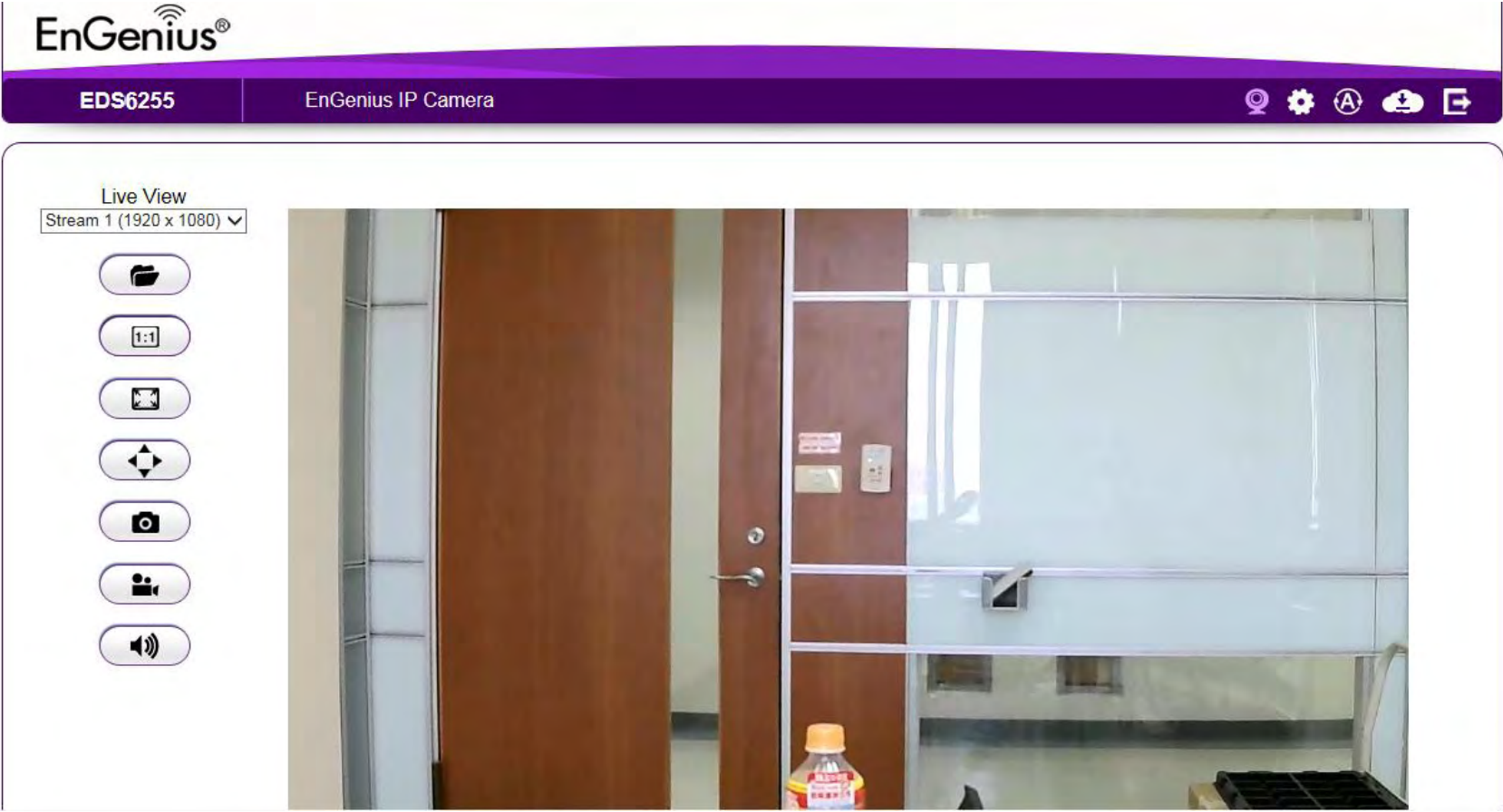

The **Navigation Panel** is located at the top-right corner of the page. Since there are two different user levels (Administrator and Viewer), the functions shown on the Navigation Panel also vary accordingly. For more information about user account, please refer to **User Management** section.







Administrator has full control of all the camera settings.



The viewer only has camera view features.

The descriptions are as follows

	Switch the management page to camera viewer within which snapshots or video clips can be taken at real time.
	Switch the management page to camera setting. Please refer to Main Menu section for detail camera setting.
	Allows user to change management page language setting.
	Cloud Service Page



Download NOW !

moving your workforce and enjoyment toward a mobile lifestyle.

Android



iOS (for iPhone and iPad)





Logout

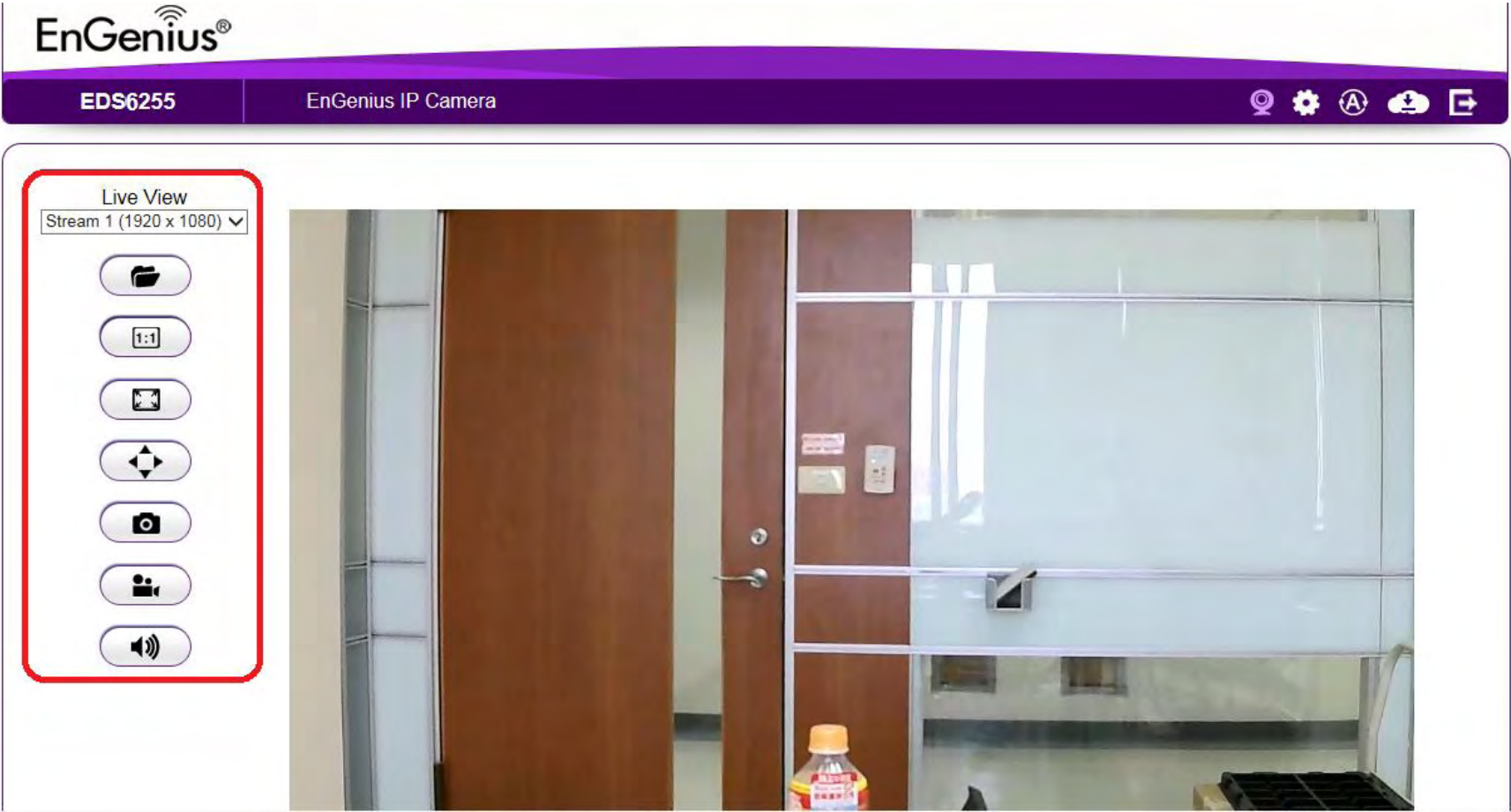

5.2. Live View Settings

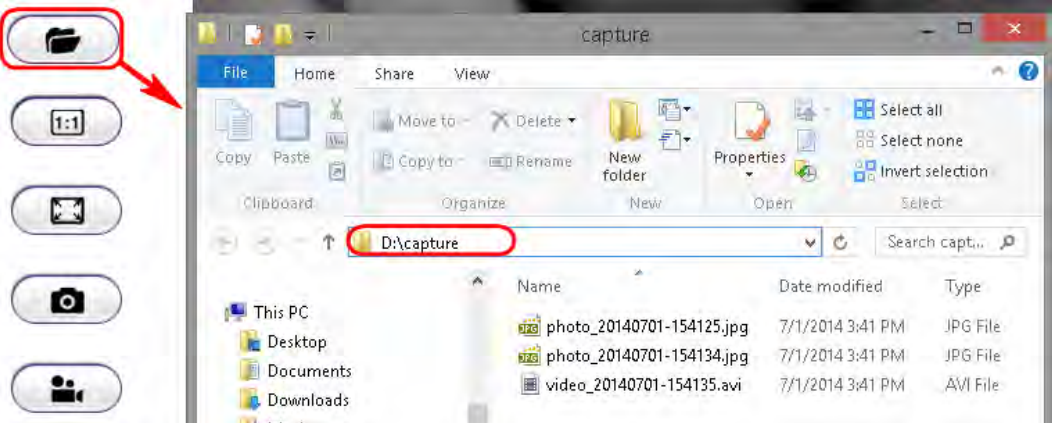
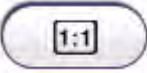

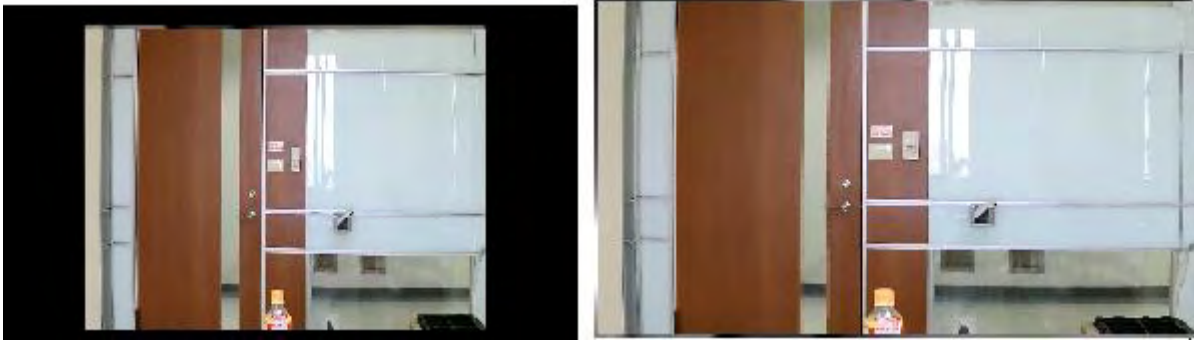
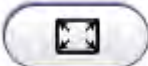
The **Live View Management** menu is located at the right side of the page.

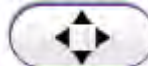
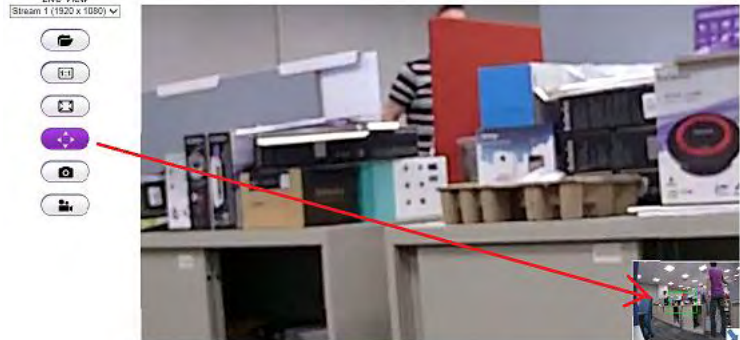
<p style="text-align: center;">Live View</p> <div style="border: 1px solid black; padding: 2px;"> <p style="background-color: #0070C0; color: white; padding: 2px;">Stream 1 (1920 x 1080)</p> <p style="padding: 2px;">Stream 2 (640 x 360)</p> </div>	<p>There are two streams running concurrently: Stream1 (1920x1080) and Stream2 (640x360). Stream1 has the higher resolution than stream2. Stream2 serves lower resolution for mobile devices which has smaller screens. You can preview each stream at real time by selecting it from the list.</p>
	<p>This opens the local folder where the real time captured images and clips are stored. You may change the folder path at Main Menu → System → PC Storage Path</p> 
	<p>This switch only applies to resolution 640 x 360. When enabled, the preview image will be switched to 1:1 mode. By default the image will expand and fill the view screen if the actual image is smaller than the view.</p>

	
	<p>This switch will hide the browser and expand the view to full screen. You can press ESC button to cancel the full screen mode.</p>
	<p>This button takes a snap-shot on the real time view and store the image in the local folder.</p>
	<p>ePTZ display the digital zoom in for the region of interest, use your mouse to move the green window at the left bottom to the area you intend to monitor.</p> 

	<p>Toggle this button to start recording movie clip at real time. Click on the button to start recording. Please note that when icon changed to purple  icon the camera is recording. To stop recording, simply click the button again.</p>
-----------------------------------------------------------------------------------	--------------------------------------------------------------------------------------------------------------------------------------------------------------------------------------------------------------------------------------------------------------------------------------------------------------------------------

5.3. Main Menus

Only Administrator Users can get access to Main Menus. Viewers do not have the privilege of changing camera settings.



To get access to the Main Menu, click on the setting icon .

The Main Menu is shown below.

System	
Status	
Service Port	
Time	
PC Storage Path	
Firmware	
Backup	
Reset to Default / Reboot	
Language	
Network	
Wireless	
Media	
Event Management	
Event Server	
Storage Info	
User Management	

System		
Model		EDS6255
Uptime		1 hours 4 min 4 sec
Current Date/Time		2015/11/05 07:01:22
Serial Number		157266096
Firmware		0.0.1
WebCMS Version		1.0.18
Default UID		105f7ba
Default DDNS Name		105f7ba.engeniussdns.com

Network		
Attain IP Protocol		
IP Address		10.0.92.70
Subnet Mask		255.255.255.0
Default Gateway		10.0.92.254
MAC Address		88:DC:96:FA:08:45
Primary DNS		10.0.92.240
Secondary DNS		10.0.200.182

Video		
Stream 1		
Resolution		1920 x 1080

5.4. System

The System setting menu consists of system related configurations.

System
Status
Service Port
Time
PC Storage Path
Firmware
Backup
Reset to Default / Reboot
Language

5.4.1. Status

Status Page displays the detail system level information on the page including current time, firmware version, DDNS name, IP address and etc.

System

Model	EDS6255
Uptime	1 hours 4 min 4 sec
Current Date/Time	2015/11/05 07:01:22
Serial Number	157266096
Firmware	0.0.1
WebCMS Version	1.0.18
Default UID	105f7ba
Default DDNS Name	105f7ba.engeniusddns.com

Network

Attain IP Protocol	
IP Address	10.0.92.70
Subnet Mask	255.255.255.0
Default Gateway	10.0.92.254
MAC Address	88:DC:96:FA:08:45
Primary DNS	10.0.92.240
Secondary DNS	10.0.200.182

Video

Stream 1

Resolution	1920 x 1080
------------	-------------

5.4.2. Service Port

The default setting is as follows. This is only reserved for advanced users who want to keep certain ports for other particular services. Changing the ports will result in unexpected result. Unless necessary, please keep the default setting.

Port Settings

Note: We recommend that you keep the default settings to ensure that the service to function properly.

HTTP Port	<input type="text" value="80"/>
HTTP External Port	<input type="text" value="50000"/>
RTSP Port	<input type="text" value="554"/>
RTSP External Port	<input type="text" value="50037"/>
EnViewer Port	<input type="text" value="9091"/>
EnViewer External Port	<input type="text" value="50075"/>

5.4.3. Time

Like any other surveillance system, time is essential because we want to keep track of the time of the events recorded or detected by the camera. By default, the camera is connected to a public time server (pool.ntp.org) and its time is always synchronized with the server over the Internet. Normally, you only need to change the **Time Zone**. Choose the one that matches your location. Leave the other setting as default should be fine. Setting the wrong time server or time zone will result in inaccurate scheduling and time stamp.

Time Settings

Current Date/Time	2015/11/03 01:47:13
Time Setup	<input type="text" value="Synchronize with the NTP Server"/>
Time Zone	<input type="text" value="(GMT)Greenwich Mean Time: Dublin, Edinburgh, Lisbon, London"/>
NTP Time Server	<input type="text" value="pool.ntp.org"/>
	<input checked="" type="checkbox"/> Automatically adjust for daylight saving time changes.
	<input type="button" value="Apply"/> <input type="button" value="Cancel"/>

Time Setup: synchronized with time server/ manually setup or synchronized with PC time

Time Zone: select time zone

NTP Time Server: the time server address

Automatically adjust for daylight saving time changes: check the box if applicable

5.4.4. PC Storage Path

Recording / Snapshot Path

Folder Path

Snapshot File Type ▼

Recording File Type ▼

Note: The video recording and snapshot will be stored in the target folder.

Folder Path: click “Browse” to change the path

Snapshot File Type: support image format JPG, PNG & BMP

Recording File Type: support format AVI & MP4

Compression rate comparison (High to Low):

JPG > PNG > BMP

MP4 > AVI

You should consider keeping the default setting because it reduces image or clip file size.

5.4.5. Firmware

The product feature may improve over time; you may check EnGenius official web site for the latest firmware. New firmware may contain bug fixes or feature improvement which is beneficial to you.

Either download the latest firmware file to your local computer or use Auto Firmware Upgrade when Internet connection is available. For manual upgrade, click **Browse** and select the firmware file to start upgrading firmware.

Manual Firmware Upgrade

To upgrade the device firmware, please ensure that you have saved the target firmware in the computer. Then, click on **Choose File (or Browse)** and select the file to be uploaded.

Apply Cancel

Auto Firmware Upgrade Enable Disable
Current Firmware version v1.0.0
New Firmware version unknown
Release Date unknown
Firmware File Size 0k

Release Note Upgrade

Select the downloaded new firmware then click on **Open**.

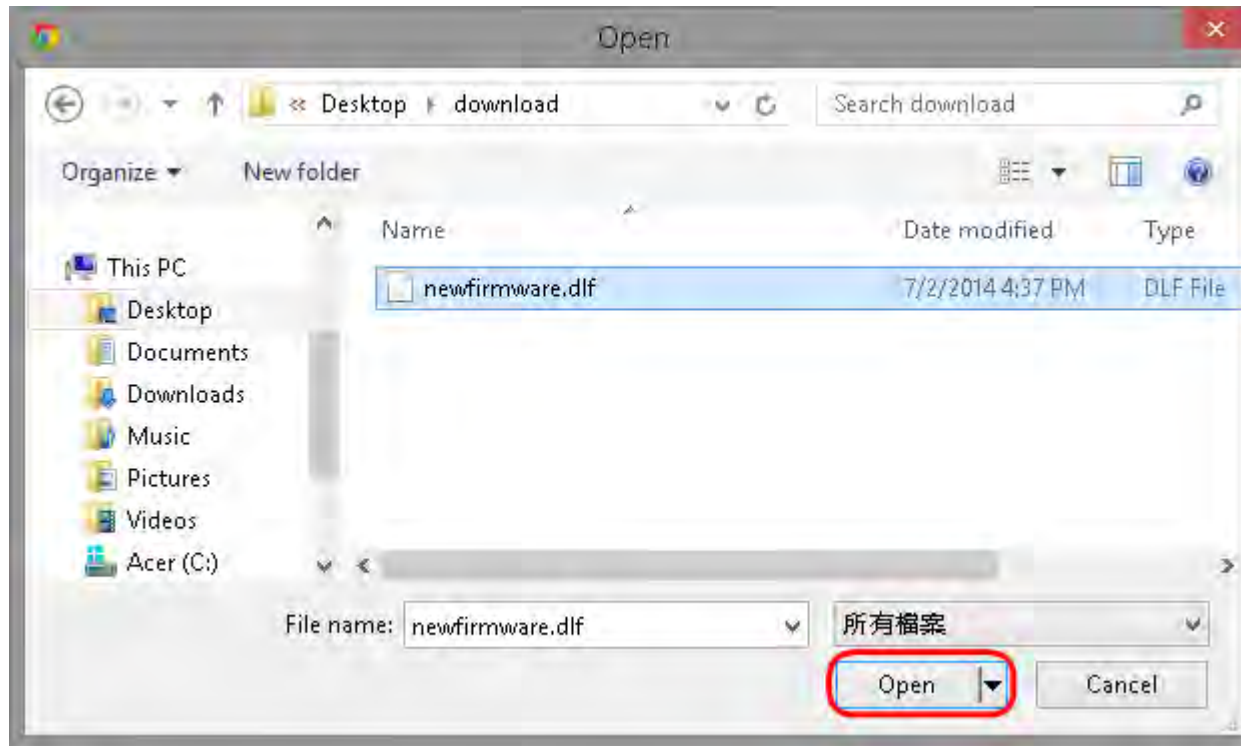

Click **Apply** to start upgrading the firmware.

You can upgrade the firmware of the IP-CAM in this page. Ensure, the firmware you want to use is on the local hard drive of your computer. Click on Browse to browse and locate the firmware to be used for your update.



It may take a moment for the upgrading process, please wait patiently.

WARNING: Do not turn off the device in the middle of upgrade process. Terminating the device during the process will damage the device and may cause the device to fail.

5.4.6. Backup

There are times that you may want to test new settings or keep different settings for different application scenarios. You can do this with following steps:

■ Save Settings

Backup Settings

Backup current settings to file

Backup

Restore saved settings from file

瀏覽...

Upload

Click **Save** to initiate setting backup process.

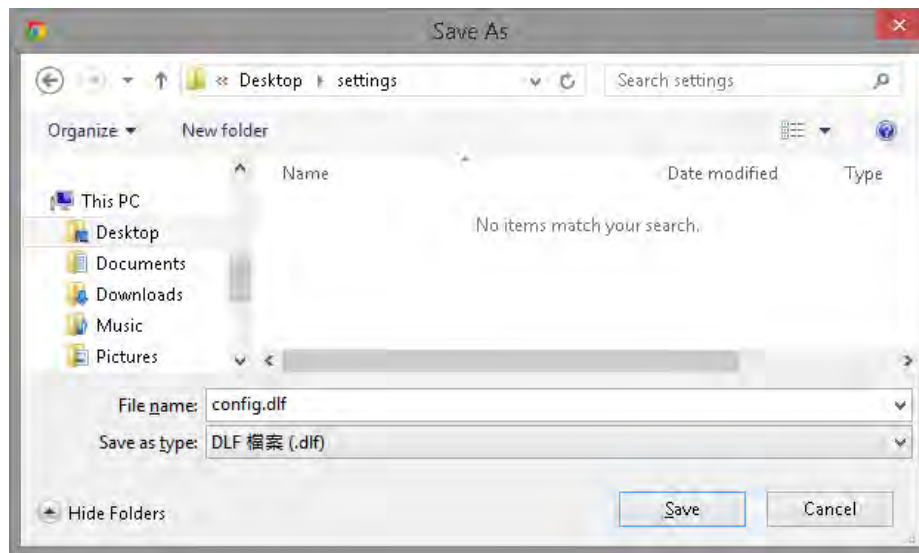

Click **Save** to store the file to the chosen location.

■ **Restore Settings**

Backup Settings

Backup current settings to file

Backup

Restore saved settings from file

瀏覽...

Upload

Click on Browse to select the backup file.

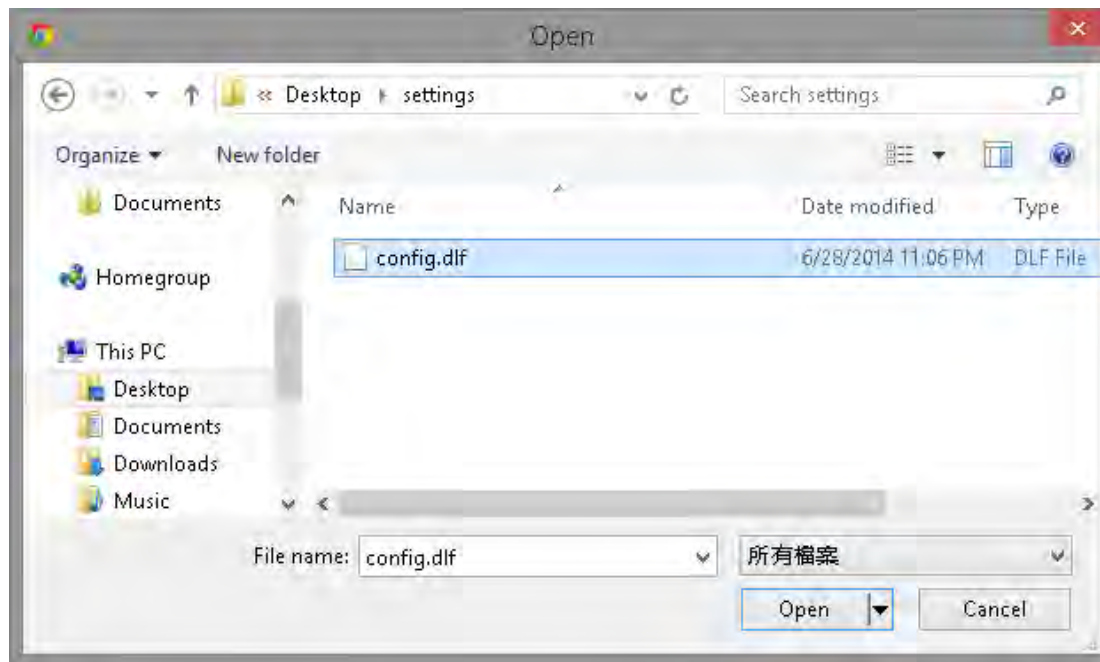

Choose the configuration file and click on **Open**.

Click on **Upload** to start storing process.

Backup Settings

Save

Restore Settings

Browse config.dlf

Upload

It may take a moment for the uploading process, please wait patiently.

WARNING: Do not turn off the device in the middle of the upload. Terminating the device during the process will damage the device and may cause the device to fail.

5.4.7. Reboot/Reset to Default

There may be times that you feel like to restore the settings to factory default. To reset to default click on the button **Reset to Default**

If the camera for some reason stop responding or acting abnormally, you can choose to **Reboot the Device**. If the device still does not recover to normal operation, please consider to perform a hard reset (unplug and re-plug the power adapter).

To proceed **Reset to Default** will erase current settings and restore the device to its original factory settings.

Note: We suggest you to back up current settings before running the reset.

Reset to Default

In case that the system stops responding or functioning incorrectly, you can perform **Reboot the Device** to restart. The current settings will be kept without change.

Reboot the Device

5.4.8. Language

The default User Interface language is English, you can change the language with just a mouse click.

On the language list, click to select the one you feel comfortable with from the list. The user interface will refresh automatically with your chosen language.

Select Display Language

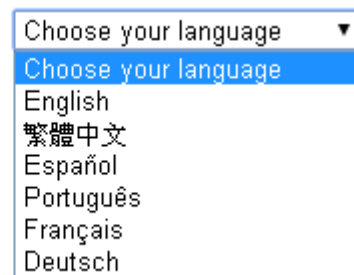

Choose your language ▼
Choose your language
English
繁體中文
Español
Português
Français
Deutsch

5.5. Network

 Network
IP Configuration
EnGenius Cloud Services
UPnP

The **Network** setting menu consists of Network related configurations.

5.5.1. IP Configuration

Each camera should be assigned with an IP address in the network for identification. **IP Configuration** setting allows you to change the method with which the camera obtains its IP address. The default setting **Dynamic IP (DHCP)** is applicable to most of the application scenario. However, advanced users can also change to **Static IP** or **PPPoE** whichever suit the purpose.

Mode

Dynamic IP (DHCP) ▼

MAC Address

88:DC:96:16:A3:D7

Note: We recommend that you keep the default settings to ensure that the service to function properly.

Apply

Cancel

Dynamic IP (DHCP) ▼
Static IP
PPPoE
Dynamic IP (DHCP)

Mode: Static IP, PPPoE and Dynamic IP (DHCP)

Static IP

IP Configuration Settings

Mode	<input type="text" value="Static IP"/>
IP Address	<input type="text"/>
IP Subnet Mask	<input type="text"/>
Default Gateway	<input type="text"/>
Primary DNS	<input type="text"/>
Secondary DNS	<input type="text"/>
MAC Address	<input type="text" value="00:51:31:09:25:04"/>

Note: We recommend that you keep the default settings to ensure that the service to function properly.

If your network requires Static IP, you need to specify the detail IP settings similar to above. Please note that, if you are managing your camera in local network similar to the example shown above, you will need to configure your management PC/Laptop under the same domain.

PPPoE

IP Configuration Settings

Mode	<input type="text" value="PPPoE"/>
Username	<input type="text"/>
Password	<input type="text"/>
Service Name	<input type="text"/>
MAC Address	<input type="text" value="00:51:31:09:25:04"/>

Note: We recommend that you keep the default settings to ensure that the service to function properly.

If you are connecting to the Internet without going through your home router, you can connect the camera directly to your modem (given that you are using PPPoE for your Internet service). Please consult your local network service provider for more detail. Basically, the PPPoE setting is exactly the same as what your home router. You need to provide at least **Username** and **Password** to get access.

Dynamic IP (DHCP)

IP Configuration Settings

Mode

Dynamic IP (DHCP) ▼

MAC Address

00:51:31:09:25:04

Note: We recommend that you keep the default settings to ensure that the service to function properly.

Apply

Cancel

MAC Address: Type in the MAC address to insert the local MAC address into the field.

Click **Apply** when configuration is done to activate new settings.

Note: If you have a working Internet connection through your router, there is no need to type in the MAC address. Providing such MAC address only if the IP address assigner binds each IP with a specific MAC address.

5.5.2. EnGenius Cloud Service

EnGenius Cloud Settings

Status

Enable Disable

Type

Using Default UID / EnGenius DDNS Service ▼

Default UID

0e95c28

UID Status

Connected

Default DDNS Name

0e95c28.engeniusddns.com

Alias DDNS Name

.engeniusddns.com

Availability Check

Refresh Time

24HR ▼

DDNS Status

Connected

You must **Enable** EnGenius Cloud first and then choose the **Type**.

A key part about EnGenius Cloud Service is DDNS. Dynamic DNS (DDNS) is a type of DNS that works with dynamic IP address. DDNS keeps update its mapping regularly and ensures a consistent matching so that your device can be accessed over the Internet using a fixed DDNS name. You can either use the default EnGenius DDNS Service or other 3rd party Service you prefer.

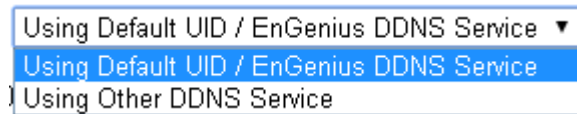

A screenshot of a web interface dropdown menu. The menu is open, showing three options. The top option is "Using Default UID / EnGenius DDNS Service" with a small downward arrow icon. The middle option is "Using Default UID / EnGenius DDNS Service" and is highlighted with a blue background. The bottom option is "Using Other DDNS Service".

Users are recommended to use the free DDNS address printed on the label enclosed in the package. This is because ISP often leases dynamic WAN IP address that changes from time to time. DDNS domain name will always be the same even if the WAN IP address changes. The domain name can also be found on your **System**→ **Status** page.

EnGenius Cloud Settings

Status	<input checked="" type="radio"/> Enable <input type="radio"/> Disable
Type	Using Default UID / EnGenius DDNS Service ▼
Default UID	0e95c28
UID Status	Connected
Default DDNS Name	0e95c28.engeniusddns.com
Alias DDNS Name	<input type="text"/> .engeniusddns.com <input type="button" value="Availability Check"/>
Refresh Time	24HR ▼
DDNS Status	Connected

Default UID: default UID

UID Status: when working properly, it should show “Connected”.

Default DDNS: shows the default DDNS

Alias DDNS Name: You may find that your DDNS is too difficult to remember. EnGenius provides free DDNS name registration as long as the alias is not yet been taken other EnGenius product users. You can check the availability by clicking on the button **Availability Check** for verification. In this example, “superman.engeniusddns.com” is available. That is, when the setting is activated, both DDNS name “superman.engeniusddns.com” and “0e95c28.engeniusddns.com” can be used to access this camera.

Refresh Time: options are 3HR, 6HR, 9HR, 12HR and 24HR. DDNS server needs to synchronize with your IP address often so that you can access your device over the Internet with DDNS name. Depends on your Internet Service provider, your WAN IP address lease time will be different.

You can check with your local Internet Service provider for WAN IP address refresh time. The default setting is **24HR** (which means DDNS server will check the synchronization **every 24 hours**). Normally, the default setting 24HR is okay for most cases.

DDNS Status: when working properly, it should show “Connected”.

Note: DDNS will only work only if your router is connected to the Internet. If router is not connected to the Internet, your DDNS status will show “Disconnected”.

EnGenius Cloud Settings

Status	<input checked="" type="radio"/> Enable <input type="radio"/> Disable
Type	<input type="text" value="Using Other DDNS Service"/>
Server Address	<input type="text" value="3322(qdns)"/>
Host Name	<input type="text"/>
Username	<input type="text"/>
Password	<input type="text"/>

Apply

Cancel

If you prefer to use third-party DDNS server, you can choose this option.

The current supported third-party DDNS services are 3322(qdns), DHS, DynDNS, ZoneEdit and CyberGate. Choose the one that best suits your purpose. You should provide your account information so that the camera can communicate with the selected DDNS vendor.

Your third-party DDNS service account credential should include the following information.

Host Name: please enter your registered Host Name

Username: please enter your registered Username

Password: please enter the password for this

Click **Apply** when configuration is done to activate new settings.

5.5.3. UPnP

Universal Plug and Play (UPnP) allows the other device to detect the presence of the camera so that communication become possible. You should enable UPnP if you wish your camera to be recognized by your router. UPnP Traversal makes camera remote access over the Internet possible using camera DDNS name. You won't be able to access the camera if you disable UPnP feature. Please keep it **Enable** if you are not sure.

Hostname: You may rename your camera to other meaningful names such as storage room, lobby, or any other descriptions you find suitable to describe the space being monitored.

UPnP: Enable or Disable

UPnP Traversal: Enable or Disable

UPnP Settings

Host Name

UPnP

Enable Disable

UPnP Traversal

Enable Disable

Click **Apply** when configuration is done to activate new settings.

5.6. Wireless

Please skip this step if you only use wired setup for your camera. Ensure your router supports wireless connection and enabled.

On the management page, click  to access the configuration **Main Menu**.



On the other hand, we also need to enable camera's wireless feature; please check again to ensure you have wireless enabled.

All wireless related settings can be found under Wireless menu. The camera store several AP profiles (candidate AP list) although only one AP will be connected at any given time.

5.6.1. Basic

On the Main Menu, select **Wireless** → **Basic**

📶 Wireless
Basic
WPS
AP Profile

Wireless Settings

Status Enable Disable

Site Survey

Wireless Information

SSID ---
 Status Disconnected
 Channel ---

To setup a wireless connection, you must first enable wireless by choosing **Enable** option

Click on **Scan** button to search for existing wireless access points (AP).

When prompted with Site Survey window, click on **Refresh** button if you do not find your AP on the list.

On the site list, choose your preferred AP and then click **Add to AP Profile**.

Site Survey

No.	Select	Channel	SSID	BSSID	Encryption	Auth	Signal(%)	Mode
1	<input checked="" type="radio"/>	6	home	D0:22:BE:C8:2F:41	AES	WPA2PSK	7	11b/g/n

Then, on the AP Profile Settings window, please check if the security settings are correct. Please review the settings: **Encryption, WPA type, and**

Pre-Shared Key type. They are automatically detected. Normally, you only need to provide the **Pre-Shared Key** (password). However, you can still change the settings if they do not match with the actual AP wireless security settings.

Enter your Pre-Shared Key and press **Save** to complete the setting.

AP Profile Settings

Network Name (SSID) :	<input type="text" value="home"/>
Encryption :	<input type="text" value="WPA pre-shared key"/>
WPA Type :	<input type="radio"/> WPA(TKIP) <input checked="" type="radio"/> WPA2(AES)
Pre-Shared Key Type :	<input type="text" value="Passphrase"/>
Pre-Shared Key :	<input type="text" value="12345678"/>

Save

Please wait for a moment for the setup to complete.

Module is reloading, please wait **10** seconds

While waiting, you can remove RJ45 Ethernet Cable from the camera. It may take a moment for the camera to detach from wired network and

switch to the newly established wireless connection with the chosen AP (your router).

To check if the connection is successful, you can verify it by login into your camera again. In case the camera is still not accessible, please check your router again to see whether your camera is connected. Also, check the security setting again just for sure.

5.6.2. WPS

Wi-Fi Protected Setup (WPS) is a network security standard that allows users to easily secure a wireless network. This feature allows user to setup wireless connection between the camera and AP without entering any detail wireless security configurations such as SSID, encryption method or pre-shared key (password). However, you need to initiate WPS process on both the camera and the AP **at the same time** so that they can find each other.

Normally, for WPS-enabled products, you should be able to find the WPS button on the product. Only few rare cases that require user to initiate WPS process over web page. Make sure WPS feature is **Enabled** on **both** the camera and your AP or wireless router. Then, you need to know how to initiate AP or wireless router's WPS process first. It is mostly likely a simple push of the WSP button on your AP or wireless router. On EDS6255, you can initiate WPS process on the web page or by **pressing the WPS button**.

WPS Button

The simplest way to setup wireless connection with an AP or wireless router is by pressing on the WPS button.

First, press the WPS button on the AP (there may be changes on the LED lights as signs of initiation).

Then, press the WPS button of the camera.

Wait a minute for two devices to establish the wireless connection.

Done!

WPS over web page

You can initiate camera's WPS process on the web page.

First, press the WPS button on the AP or wireless router (there may be changes on the LED lights as signs of initiation).

On camera's WPS page, press **Start to Process**.

Wait a minute for two devices to establish the wireless connection.

Done!

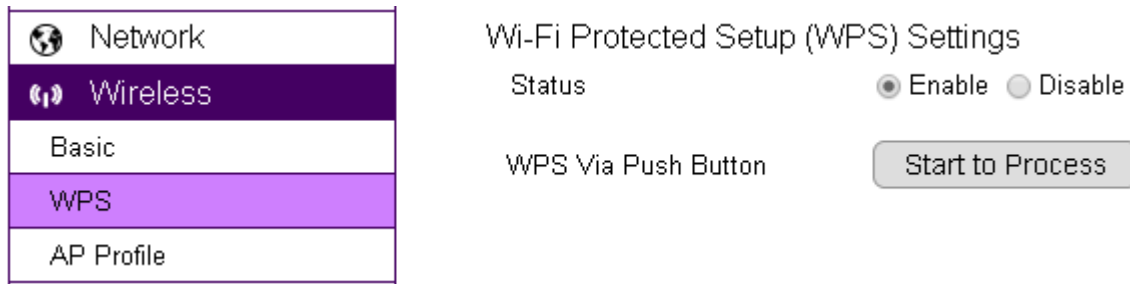

NOTE: For WPS to setup wireless connection successfully, timing is essential. Once AP or wireless router has initiated WPS process, your camera WPS process must be initiated within a given time range. It would be best if you have two devices in close range so that WPS process on both sides can be initiated immediately after another.

5.6.3. AP Profile

You can keep several AP Profiles (settings) if your application may need to switch between APs in case one of them failed. Each profile matches to a specific AP.

AP Profile Table

Select	No.	SSID	MAC	Authentication	Encryption
<input type="checkbox"/>	1	SNWL	00:02:6F:DB:9F:D5	WPA2_PSK	AES

[Add](#) [Edit](#) [Move Up](#) [Move Down](#) [Delete Selected](#) [Delete All](#) [Connect](#)

5.6.3.1. Add

AP Profile Settings

Network Name (SSID) :	<input type="text" value="hallAP"/>
Encryption :	<input type="text" value="WPA pre-shared key"/>
WPA Type :	<input checked="" type="radio"/> WPA(TKIP) <input type="radio"/> WPA2(AES)
Pre-Shared Key Type :	<input type="text" value="Passphrase"/>
Pre-Shared Key :	<input type="text" value="EMUE3ZLJB85G"/>

Save

WPA pre-shared key

Network Name (SSID): enter the SSID of the target AP

Encryption: supports **Disabled**, **WEP** and **WPA pre-shared key**

WPA Type: supports **WPA (TKIP)** and **WPS2(AES)**

Pre-Shared Key Type: **Passphrase** or **HEX (64 character)**

WEP

Please note that WEP has proven be insure, this security option is reserved only for legacy products that supports WEP only.

Authentication Type: supports **Open System** and **Shared Key**

Key Length: 64bit and 128bit (the longer the safer)

Key Type: ASCII or HEX

Default Key: the key that will be used for authentication

Encryption Key 1~4: the candidate keys for authentication

AP Profile Settings

Network Name (SSID) :	<input type="text" value="hallAP"/>
Encryption :	<input type="text" value="WEP"/>
Authentication Type :	<input checked="" type="radio"/> Open System <input type="radio"/> Shared Key
Key Length :	<input type="text" value="64-bit"/>
Key Type :	<input type="text" value="ASCII (5 characters)"/>
Default key :	<input type="text" value="Key 1"/>
Encryption Key 1 :	<input type="text" value="*****"/>
Encryption Key 2 :	<input type="text" value="*****"/>
Encryption Key 3 :	<input type="text" value="*****"/>
Encryption Key 4 :	<input type="text" value="*****"/>

Save

5.6.3.2. Edit

On the table **Select** the profile and then click on **Edit** to modify the profile setting.

AP Profile Table

Select	No.	SSID	MAC	Authentication	Encryption
<input checked="" type="checkbox"/>	1	SNWL	00:02:6F:DB:9F:D5	WPA2_PSK	AES

Once complete the modification, click **Save** to make the changes effective.

AP Profile Settings

Network Name (SSID) :

Encryption :

WPA Type : WPA(TKIP) WPA2(AES)

Pre-Shared Key Type :

Pre-Shared Key :

5.6.3.3. Move Up / Down

Each profile is ordered by the number at the front, the one on top has higher priority when camera tries to search for the existing AP. You can change the AP priority by moving them up or down. Select the profile and then click either on **Move Up** or **Move Down**.

AP Profile Table

Select	No.	SSID	MAC	Authentication	Encryption
<input checked="" type="checkbox"/>	1	SNWL	00:02:6F:DB:9F:D5	WPA2_PSK	AES
<input type="checkbox"/>	2	EAP900H-2.4GHz	8A:DC:96:1A:B7:F5	WPA2_PSK	AES

5.6.3.4. Delete

Delete Selected: only delete the selected profile.

Select the profile to be deleted and then click on **Delete Selected** button.

AP Profile Table

Select	No.	SSID	MAC	Authentication	Encryption
<input checked="" type="checkbox"/>	1	SNWL	00:02:6F:DB:9F:D5	WPA2_PSK	AES
<input type="checkbox"/>	2	EAP900H-2.4GHz	8A:DC:96:1A:B7:F5	WPA2_PSK	AES

Delete All: this will delete all the AP profiles on the table

5.6.3.5. Connect

AP Profile Table

Select	No.	SSID	MAC	Authentication	Encryption
<input checked="" type="checkbox"/>	1	SNWL	00:02:6F:DB:9F:D5	WPA2_PSK	AES
<input type="checkbox"/>	2	EAP900H-2.4GHz	8A:DC:96:1A:B7:F5	WPA2_PSK	AES

Select a profile to be connected and then click on **Connect** to initiate the wireless connection.

5.7. Media



All media quality related settings can be found under **Media** menu. These settings will have direct effect on the captured image or video.

5.7.1. Video

Display overlay

Timestamp and Video Title (A-Z , 0-9 , : , / , -)

Stream 1

Compression Format	H.264	▼
Resolution	1920 x 1080	▼
Max. Frame per Second	30 fps	▼
Bit Rate Encoding	Constant Bit Rate	▼
Bit Rate Value	4 Mbps	▼

Stream 2

Compression Format	H.264	▼
Resolution	640 x 360	▼
Max. Frame per Second	15 fps	▼
Bit Rate Encoding	Constant Bit Rate	▼
Bit Rate Value	256 Kbps	▼

Note: You may adjust Bit Rate Value according to your connectivity mode or bandwidth conditions. Higher bit rates delivers excellence resolution when video is viewed in full-screen on PC. Lower bit rates may be better choices in limited-bandwidth environments or via remote Wi-Fi network.

Enable: it is recommended that you enable **Time Stamp and Video Title**; the timestamp will show on the top-left corner of your video as shown below.

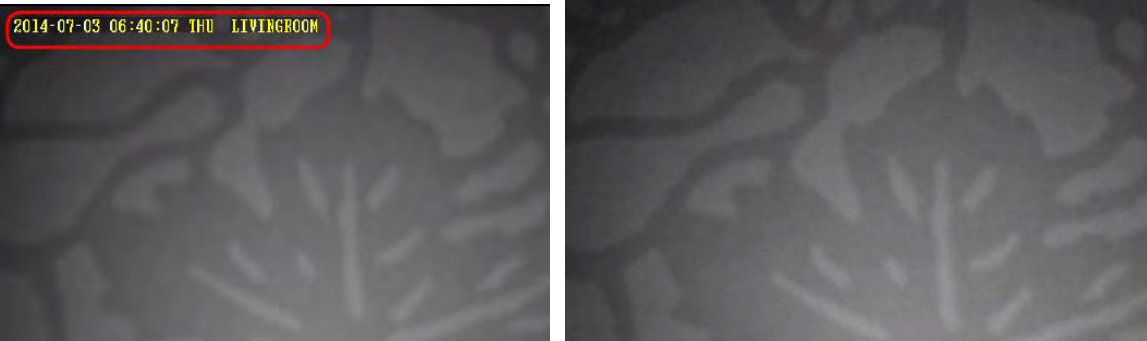

5.7.2. Camera

Image Settings

Brightness	<input type="range" value="50"/>	50
Contrast	<input type="range" value="50"/>	50
Saturation	<input type="range" value="50"/>	50
Sharpness	<input type="range" value="20"/>	20
Denoise	<input type="range" value="20"/>	20

Flicker Control ▼

Mirror/Flip ▼

Day/Night Mode ▼



Default Settings

Apply

Cancel

You can get better quality by tuning the lighting condition of the camera. For example, in a dark room you may want to set the Brightness higher to generate clearer result. When directly facing an outdoor window (too much light) you may want to lower the Brightness a bit. There may be different settings under different circumstance; therefore, you should tune the setting if the image quality has become too low to serve its purpose. Please refer to the following examples for comparison between low and high for each of the light settings.

5.7.2.1. Light Setting

Brightness



Contrast



Sturation



Sharpness



De-noise



Please note that some of the effects will be more obvious in higher resolution at real time.

5.7.2.2. Flicker Control

The supported options are: **60Hz & 50Hz**

Flicker Control is an anti-flicker feature setting.

AC lamp can cause a flicker effect, which is a consequence of the AC power frequency (50 or 60 Hz). As the light can change from picture to picture, causing light flicker. This will lead to inconsistent light source between each snapshot. To eliminate flicker, configure your camera to PAL (60Hz) or NTSC (50Hz) modes to compensate the effects. Check the power supply of your region for proper setting.

5.7.2.3. Mirror

Support Mirrors: **None**, **Mirror**, **Flip** and **Both**

There are times that the camera will have to be mounted upside down for sideways. That is, the view become difficult to monitor when it is upside down. The **Mirror** settings does not reflect on the preview at real time (unlike lighting condition settings). Therefore, you have to click on **Apply** to see the result.

The following examples compares **none** with a **chosen mirror effect**.

Mirror (Horizontal)

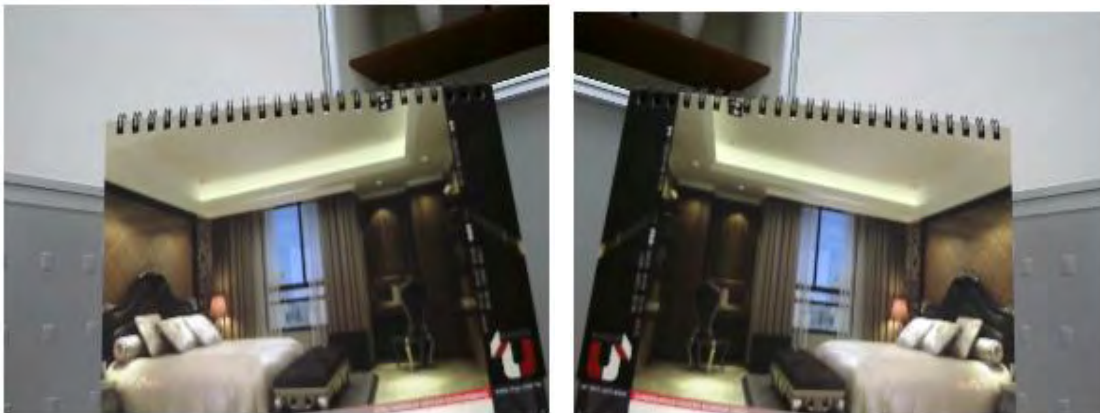

None

Mirror

Flip (Vertical)

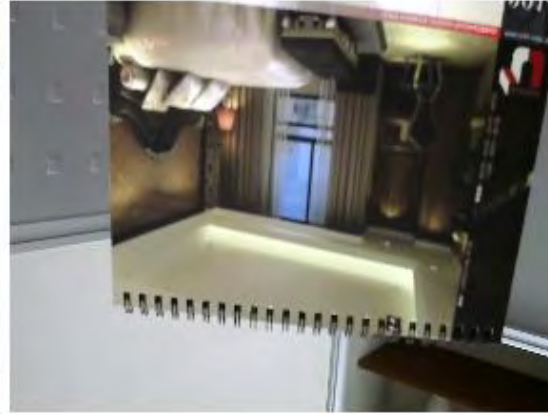

None

Flip

Both (Horizontal and Vertical)



None

Both

5.7.2.4. Day/Night Mode

This controls **Night Vision** ON and OFF.

Auto: auto detect light sufficiency and switch between Day and Night automatically.

Day: force the camera to turn **OFF** Night Vision.

Night: force the camera to turn Night Vision **ON**.

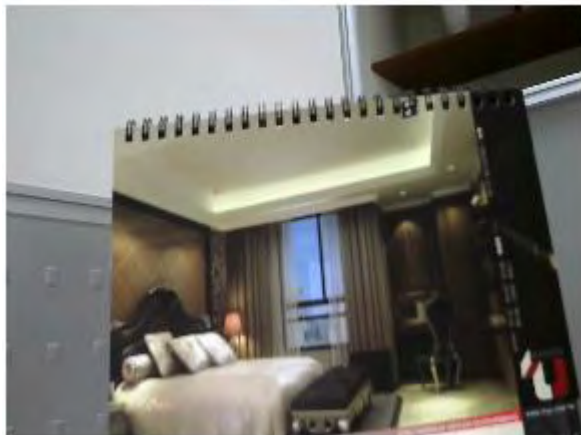

Day



Night

5.7.3. Advanced

Exposure Settings

Mode

Gain Control

Shutter Time

Max (sec)

Min (sec)

Others

EV Compensation

WDR Status Enable Disable

WDR Level

Low Light Compensation Enable Disable



Default Settings

Apply

Cancel

Exposure Settings

Mode: Manual, Indoor, Outdoor

For regular users, please choose indoor or outdoor, if you are not sure about the terms and behavior, the default values will be the preconfigured. The areas are grey out for preconfigured settings when you choose **Indoor** or **Outdoor**.

Manual

Choose **Manual** if you would like to fine tune some of the settings that suits your application. Please be noted that these settings may have impacts on the image quality and performance.

Exposure Settings

Mode ▼
Gain Control ▼

Shutter Time

Max (sec) ▼
Min (sec) ▼

Others

EV Compensation ▼
WDR Status Enable Disable
WDR Level ▼
Low Light Compensation Enable Disable



Default Settings

Apply

Cancel

5.7.4. Privacy Mask

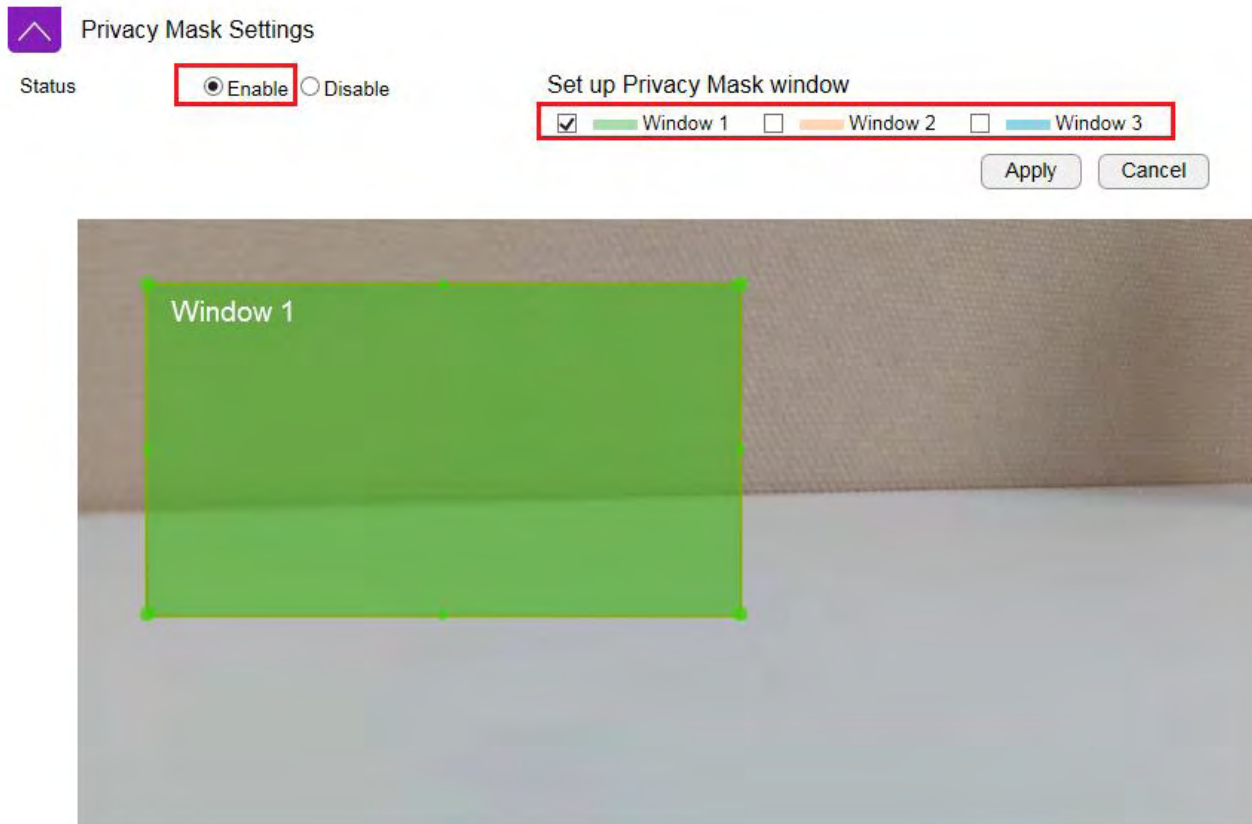

Choose **Enable** if you would like to put certain areas in private. Please use selected window to hide certain area for privacy purpose.

5.7.5. Audio

Status

If you audio is important to what you are monitoring, you need to set the audio status to Enable. So that the microphone can pick up sounds in the environment. On the other hand, if audio is not necessary (for instance an open space with a lot of noises), you are advised to Disable the audio to reduce the clips file size.

Audio Settings

Status	<input checked="" type="radio"/> Enable <input type="radio"/> Disable
Mode	Only Mic ▾
Microphone (Input) Gain	<input type="range" value="50"/> 50
Encoding	G711U ▾
Sample Rate	8 K
Bit Rate	16 Bit

Mode

Only Mic: enable only the microphone

Input Gain: setting the sensitivity of the microphone. High gain will result in higher volume and but picks up more noise.

Encoding: supports G711A, AAC and G711U.

Sample Rate: 8 K

Bit Rate: 16 Bit

Changing Sample Rate and Bit Rate will impact the audio quality. The higher the rate, the better the quality and the larger the file will become.

5.8. Event Management

 Event Management
Event Control
Motion Detection
Tampering Detection
Event Action

This camera supports many smart features that allows you to utilize the camera in many application scenarios. This section will introduce each of them in detail.

5.8.1. Event Control

 Event Management
Event Control
Motion Detection
Audio Detection
Tampering Detection
Event Action

Event Control

Enable	Name	Schedule	Trigger Type	Action Type	Storage Destination	Action
<input type="checkbox"/>	Schedule Record	Always	Time	Record	SD Card	Edit
<input type="checkbox"/>	Motion Detection	Always	Motion Detection	Disable	---	Edit
<input type="checkbox"/>	Audio Detection	Always	Audio Detection	Disable	---	Edit

[Add](#)

When camera detects an event that matches the predefined condition an **event** will be triggered and proceed with the defined actions; for instance, taking snapshots or recording videos for the specified length of time and interval. There are two profiles for default setting, you can click “Edit” for detail settings or create a new profile by “Add”.

Event Control

Enable	<input type="radio"/> Enable <input checked="" type="radio"/> Disable
Name	<input type="text"/>
Schedule	<input type="checkbox"/> Every Day <input type="checkbox"/> Mon <input type="checkbox"/> Tue <input type="checkbox"/> Wed <input type="checkbox"/> Thu <input type="checkbox"/> Fri <input type="checkbox"/> Sat <input type="checkbox"/> Sun
Time of day	<input type="checkbox"/> All Day From <input type="text"/> : <input type="text"/> To <input type="text"/> : <input type="text"/>
Trigger Type	<input type="radio"/> Time <input checked="" type="radio"/> Detectors <input checked="" type="radio"/> Motion Detection <input type="radio"/> Audio Detection <input type="radio"/> Tampering Detection

Event Notification

Push Message	<input type="radio"/> Enable <input checked="" type="radio"/> Disable
E-Mail	<input type="radio"/> Enable <input checked="" type="radio"/> Disable

Event Action

Action Type	<input type="text" value="Disable"/> ▼
-------------	----------------------------------------

Enable/Disable the event control

Schedule to set the camera to record video regularly based on a predefined schedule.

Time of day can specify the time range for each schedule.

Trigger Type by Time or Detectors, if you select the detectors, it can be trigger by Motion detection, Audio detection or Tampering detection.

Event Notification can send the message to user when event triggered, you can select Push message, E-mail and VMS at the same time.

Event Action includes two types of the action when event triggered.

Event Action

Action Type

Disable
Record
Snapshot

Record to Network Storage or FTP, please remember to setup and enable the correlate settings of Network Storage and FTP, you can refer to Ch5.8.1 and 5.8.2.

 ▼

Network Storage FTP

Snapshot to Network Storage, FTP or E-Mail , please remember to setup and enable the correlate settings of Network Storage, FTP, E-mail, you can refer to Ch5.8.1, 5.8.2 and 5.8.3.

 ▼

Network Storage FTP E-Mail

5.8.1.1. Motion Detection

Motion Detection Settings

Video OSD Prompt Enable Disable

Set up motion detecting window

<input checked="" type="checkbox"/>	Window 1	Sensitivity : 60 %	<input type="range"/>
<input checked="" type="checkbox"/>	Window 2	Sensitivity : 60 %	<input type="range"/>
<input checked="" type="checkbox"/>	Window 3	Sensitivity : 60 %	<input type="range"/>

Apply Cancel

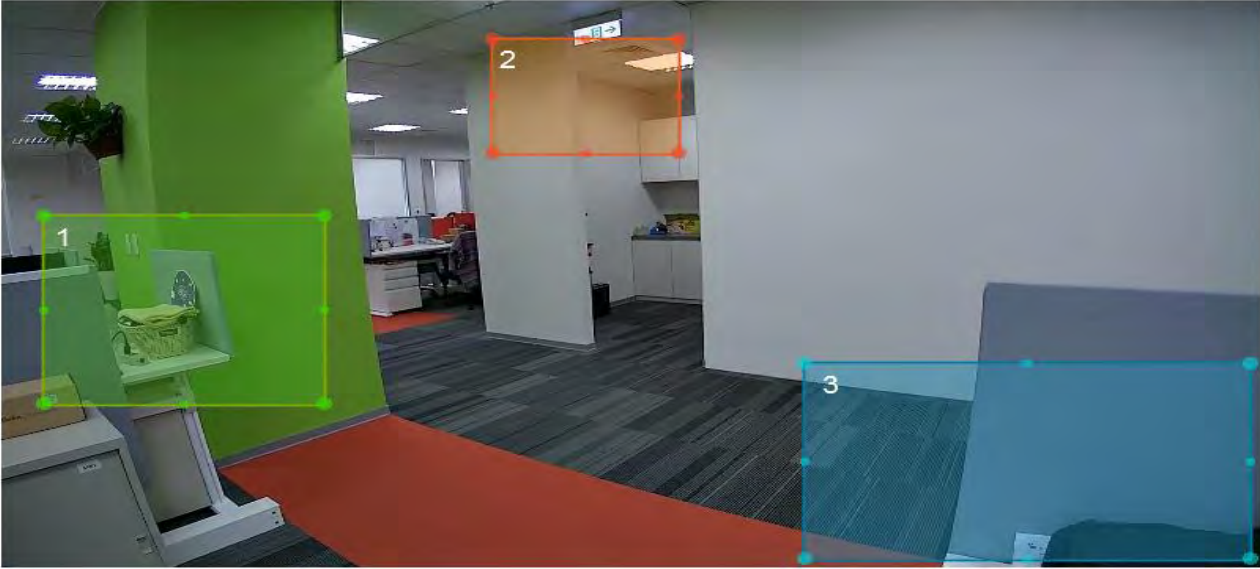

Motion Detection Window is a hot zone that the camera analyzes for motion (image changes). When a motion is detected within the zone an event will be triggered.

When the window is selected, use your mouse to move the window to the area you intend to monitor. There can be 3 windows at the most. The Windows are differentiated by color; Window 1 is Green, Window 2 is Red and Window 3 is Blue.

Video OSD Prompt displays the warning on the top left of the live view page when motion triggered.

Uncheck the window to remove the window from the view.

Sensitivity: Level 0% to Level 100% (with Level 100% being the most sensitive)

Depends on your application, high sensitivity will trigger event more often than low sensitivity and produce more snapshots or videos. However, overly sensitive events will fill up the storage very quickly. Even if you have unlimited storage space, large amount of files can become a problem when you need search through each of the files to find what you are really looking for. It may take some time for you to fine tune the optimal sensitivity for your application.

You can adjust the motion detecting area by dragging the four corners to resize the window.

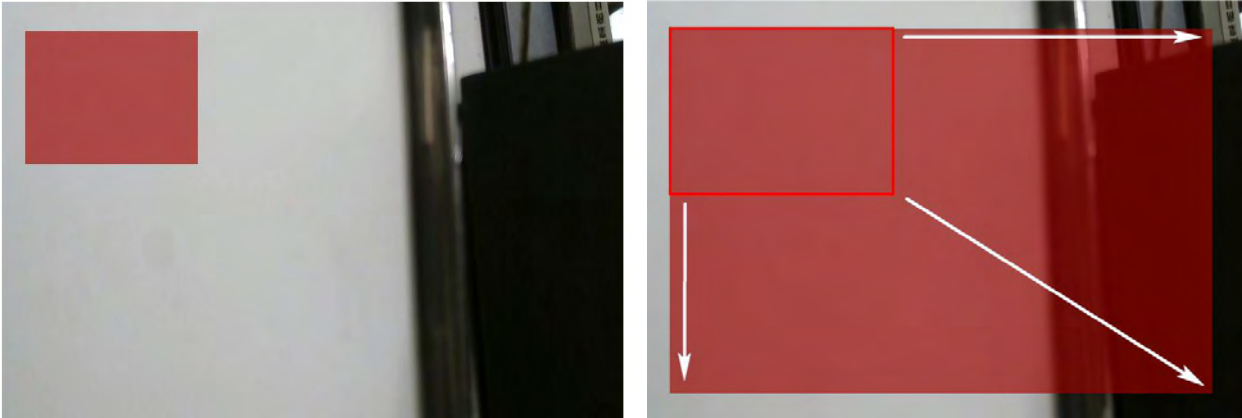

Therefore, you can have a combination of three different detection window sizes.

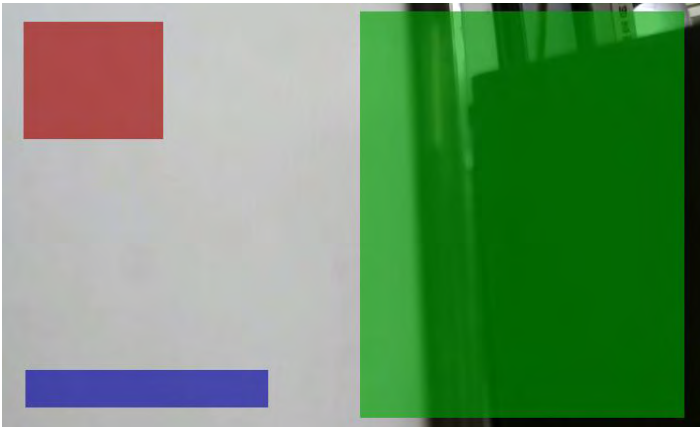

5.8.1.2. Audio Detection

Audio Detection Settings

Sensitivity Level



Sensitivity Level: 0% to 100% (with 100% being the most sensitive)

Similar to motion detection, high sensitivity will trigger events more often than low sensitivity and produce more snapshots or videos. However, over-sensitive events will fill up the storage very quickly. Even if you have unlimited storage space, large amount of files can become a problem when you need to search through each of the files to find what you are really looking for. It may take some time for you to fine tune the optimal sensitivity for your application.

5.8.1.3. Tampering Detection

Tampering Detection Settings

Video OSD Prompt

Enable Disable

Sensitivity Level

 60 %

Apply

Cancel

Tamper detection is a setting within your IP camera that will send you an alert when the camera is tampered with. Once an action has been detected, whether it's someone trying to knock the camera down or blocking its view, the alert lets you know to log into the actions to see what happened.

Video OSD Prompt displays the warning on the top left of the live view page when motion triggered.

Sensitivity Level: Level 0% to Level 100% (with Level 100% being the most sensitive)

Depends on your application, high sensitivity will trigger event more often than low sensitivity and produce more snapshots or videos. However, overly sensitive events will fill up the storage very quickly. Even if you have unlimited storage space, large amount of files can become a problem when you need search through each of the files to find what you are really looking for. It may take some time for you to fine tune the optimal sensitivity for your application.

5.8.1.4. Event Action

Event Action	
Buffer Duration Until Next Event	20 sec(s) ▼
Event Snapshot	
Snapshot Duration	10 sec(s) ▼
Event Recording	
Video Format	AVI
Stream Type	H.264 (1920 x 1080) ▼
Time	
Video Length	1 min(s) ▼
Detectors	
Pre-event Buffer	1 sec(s) ▼
Record Duration	20 sec(s) ▼

Apply Cancel

This page provides **Event**-related settings.

Event Action/Buffer Duration until Next Event: can set 20sec(s), 30sec(s), 1min(s), 5min(s), 10min(s), if you set 20sec(s) for this item, system will ignore any trigger during this 20sec(s).

Event Snapshot/Snapshot Duration: can set 10sec(s), 20sec(s), if you set 10sec(s) for this item, system will send a snapshot in every 10sec(s).

Event Recording Stream Type: H.264 (1920x1080) or H.264 (640x360)

Video Length: the maximum video length of time per file

Detectors Pre-event Buffer: the length of pre-event time (1~5 seconds)

Record Duration: the length of recording time when alarm is triggered.

Note:

If setting **Buffer Duration Until Next Event** to 30 seconds, the camera will keep recording for 30 seconds when event is triggered. In this case, if the **Video Length** is 10 seconds, then 3 files will be generated for single instance of event. If **Video Length** is 30 seconds, then only 1 file will be generated. Please note that pre-event buffer will extend the length of the video clip for the chosen extra length of time.

5.9. Event Server

 Event Server
Network Storage
FTP
E-Mail

It is required for users to configure **Event Server** settings before setting camera **Event** or **Schedule Recording**. You will have to tell **where** the captured images or clips are going to be stored. The following concept diagram depicts the flow of the image file when and when captured. The file is stored at one of the predefined storage locations.

For EDS6255, **Network Storage and FTP** are required to have existing servers ready for upload. **SMTP** is good for small image capture since it sends the file through email. You should choose what is best for your application.



5.9.1. Network Storage

This camera supports two types of Network Storage: **NFS** and **SAMBA**.

Before going further, you need to **Enable** to configure the network storage first.

Status

Enable Disable

Apply

Cancel

Please refer to the following sections for **NFS** and **SMABA**.

5.9.1.1. NFS (Network File System)

Network Storage Settings

Status	<input checked="" type="radio"/> Enable <input type="radio"/> Disable
Protocol	Network File System (NFS) ▼
Server	<input type="text"/>
Path	<input type="text" value="/"/> (insert / if the path contains the subfolder, i.e. folder/subfolder)
Storage Size	---
Folder Size	<input type="text" value="0"/> GB (Integer only. 0 is no limit.)
<input checked="" type="checkbox"/> Overwrite	

Apply Cancel

Server: IP address of the NFS server

Path: enter the initial path if applicable

Folder Size: storage allocated for the camera; the default value 0 signifies infinity.

Overwrite: when the defined folder is full, the oldest files will be overwritten to accommodate the new one.

Click **Apply** when done.

5.9.1.2. SAMBA

Network Storage Settings

Status	<input checked="" type="radio"/> Enable <input type="radio"/> Disable
Protocol	SAMBA <input type="button" value="v"/>
Server	<input type="text"/>
Path	<input type="text" value="/"/> <small>(insert / if the path contains the subfolder, i.e. folder/subfolder)</small>
Username	<input type="text"/>
Password	<input type="text"/>
Storage Size	---
Folder Size	<input type="text" value="0"/> GB (Integer only. 0 is no limit.)
<input checked="" type="checkbox"/> Overwrite	

Server: IP address of the SAMBA server

Path: enter the initial path if applicable

User Name: username for accessing SAMBA server

Password: password for accessing SAMBA server

Folder Size: storage allocated for the camera; the default value 0 signifies infinity.

Overwrite: when the defined folder is full, the oldest files will be overwritten to accommodate the new one.

Click **Test** to verify the connection with the server using the username and password. Click **Apply** when done.

5.9.2. FTP (File Transfer Protocol)

FTP Settings

Server IP address	<input type="text"/>	e.g. 192.168.0.100
Port	<input type="text" value="21"/>	
Username	<input type="text"/>	
Password	<input type="password"/>	
FTP Path	<input type="text" value="/"/>	(insert / if the path contains the subfolder, i.e. folder/subfolder)

Server: IP address of the FTP server

Port: the FTP server port; default 21

User Name: username for accessing FTP server

Password: password for accessing FTP server

FTP Path: enter the initial path if applicable

Click **Test** to verify the connection with the server using the username and password.

Click **Apply** when done.

5.9.3. E-mail Alerts

E-mail SMTP Settings

Please refer to the settings from your email service provider to configure correctly.

Email Service Provider	<input type="text" value="Manual"/>	
SSL/TLS	<input type="text" value="None"/>	
SMTP Server	<input type="text"/>	
Port	<input type="text" value="25"/>	
Account	<input type="text"/>	e.g. user@domain.com
Password	<input type="text"/>	
From	<input type="text"/>	e.g. user@domain.com
To	<input type="text"/>	e.g. user1@domain.com,user2@domain.com
<p>Note: If you'd like to add multiple recipients, simply separate each email with a comma.</p>		
Subject	<input type="text" value="EDS5250 IPCam Alert"/>	

EDS6255 allows camera to send captured images to the predefined email box to notify about an event or alarm.

SMTP is an email sender's server. You need to check whether your email service provider supports SMTP and obtain the required information for this setting.

Email Server Provider: supported Gmail, Yahoo and Hotmail.

SSL/TSL: select the type of the authentication as Transport Layer Security (TLS) protocol or Secure Sockets Layer (SSL) protocol

SMTP Server: enter the SMTP server address (e.g. smtp.gmail.com).

Port: enter SMTP server port (normally 587 or 465)

Account: the email account name; if your email is myemail@gmail.com, **myemail** is the account name.

Password: the password you use to login into your email box.

From: you can type in your email address or other address if you would like the receiver to reply the email to.

To: enter the receiver email here (usually your or the administrator's email).

Subject: enter the email subject here.

5.10. Storage Info

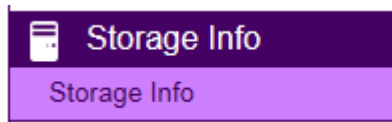

System will display the storage information on this page; it includes the network storage status, total size and available size. User can click the “Refresh” button to get the latest information of these information.

Storage Info

	Status	Total Size	Available Size		
SD Card	Ready	15.30 GB	15.28 GB	Dismount	Format
Network Storage	Ready	100.00 GB	11.22 GB		

Refresh

Name	Size	Last Modified	Action
..			
tmp	---	2015/09/25 15:08:06	Delete
timelapse-20150925-1343.avi	10123K	2015/09/25 14:49:16	Delete
timelapse-20150925-1402.avi	8999K	2015/09/25 15:08:28	Delete

It depends on different browsers, user can double click the mouse on the records of .avi or .jpg file to save and view the video or snapshot.

This camera supports **MicroSD** card slot. Please be careful when choosing the SD card type. You need to insert a blank SD card into the slot as shown below. It may take a few seconds for the camera to recognize the inserted SD card.





You will be seeing the file list after inserted the SD card. If not, refresh the page by clicking on **Refresh** button and double check if the Micro SD card has been properly inserted into the slot.

Dismount: you should dismount the SD card before physically removing it from the slot to avoid file damage.

Format: You can clean a SD card by formatting it (all data will be erased).

You can browse through the folder like any other file manager by clicking on the folder name.

Click on the files to view it directly as shown below.

Name	Size	Last Modified	Action
 ..			
 tmp	---	2015/09/25 15:08:06	<input type="button" value="Delete"/>
 timelapse-20150925-1343.avi	10123K	2015/09/25 14:49:16	<input type="button" value="Delete"/>
 timelapse-20150925-1402.avi	8999K	2015/09/25 15:08:28	<input type="button" value="Delete"/>

5.9. User Management

 User Management
User Account
Push Message Mobile List

User List

Select	No.	Username	Authority
<input type="checkbox"/>	1	admin	Administrator
<input type="checkbox"/>	2	guest	Viewer

There are two types of user accounts: **Administrator** and **Viewer**. Administrator has full control over the camera settings while viewer only has the accessibility of watching the real time video. Viewer account is particularly useful when you have multiple users such as other staff members. You may have many administrators as well as viewers depending on your needs.

Administrator has full control of the camera interface with configuration features as shown below.



Viewer only has basic camera view interface.



5.10.1.Add User

User Name	<input type="text"/>
Password	<input type="password"/>
Confirm Password	<input type="password"/>
Authority	<input type="text" value="Administrator"/>
<input type="button" value="Add"/>	<input type="button" value="Reset"/>

User Name: enter username

Password: enter password

Confirm Password: enter password for confirmation

Authority: select **Administrator** or **Viewer**

Click **Add** to add the user

5.10.2.Edit User

User List

No.	User Name	Authority	Select
1	admin	Administrator	<input type="checkbox"/>
2	guest	Viewer	<input type="checkbox"/>
3	family	Viewer	<input checked="" type="checkbox"/>

Select a user from the list by click on the check box.

Click **Edit** to change the user account setting.

User Name

Password

Confirm Password

Authority

Make the changes and then click **Edit** to save the changes.

Once all necessary changes are made to the accounts, click **Apply** to make the changes affective.

User List

No.	User Name	Authority	Select
1	admin	Administrator	<input type="checkbox"/>
2	guest	Viewer	<input type="checkbox"/>
3	friend	Viewer	<input type="checkbox"/>

5.10.3.Delete User

On the user list, **select** the user account to be deleted.
Click on **Delete** Selected to delete the account.

User List

No.	User Name	Authority	Select
1	admin	Administrator	<input type="checkbox"/>
2	guest	Viewer	<input type="checkbox"/>
3	friend	Viewer	<input checked="" type="checkbox"/>

When prompted with delete confirmation, click **Yes** to delete.

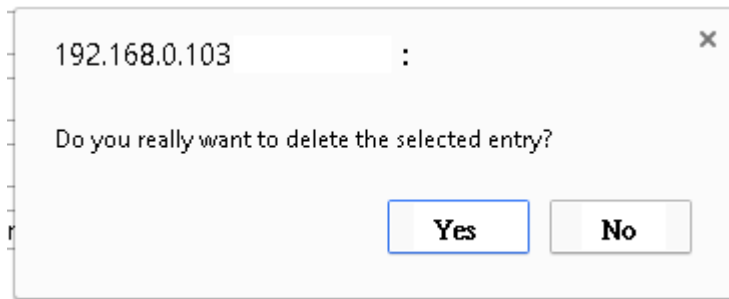

Once all necessary changes are made to the accounts, click **Apply** to make the changes affective.

User List





No.	User Name	Authority	Select
1	admin	Administrator	<input type="checkbox"/>
2	guest	Viewer	<input type="checkbox"/>

Edit Delete Selected Delete All Reset

Apply Cancel

5.10.4. Push Message Mobile List

Here will list the devices which enable the feature of push message on this camera. When an event triggered, camera will send the message to all the devices in this list. You can click “Delete” to disable the feature of the mobile device.

 System
 Network
 Wireless
 Media
 Event Management
 Event Server
 Storage Info
 User Management
User Account
Push Message Mobile List

Description	Platform	Device Token	Action
John	iOS	7ef97c571d...	Delete
Mary	Android	APA91bGz0f...	Delete

6. Camera Connecting to EnGenius Router

Smart Recording is an intelligent camera management technology that allows EnGenius users to manage cameras collectively with ease. EnGenius bundles cameras with **Intelligent Router** and **IoT gateway** series and provides a single point of entrance for integrated management. Traditionally, if you have multiple cameras installed you will need to go through the tedious configurations on each of the camera. The benefits of Smart Recording are as follows:

1. Easy and Integrated Access

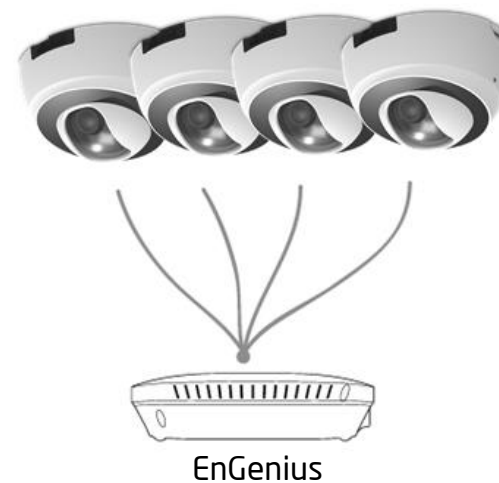
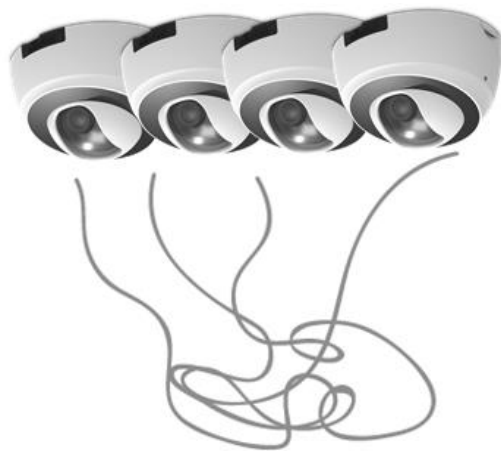

2. Integrated Storage

Smart Recording technology integrates the EnGenius **Intelligent Router** and **IoT Gateway** storage feature and allows you to store the media files on the centralized storage over the router.

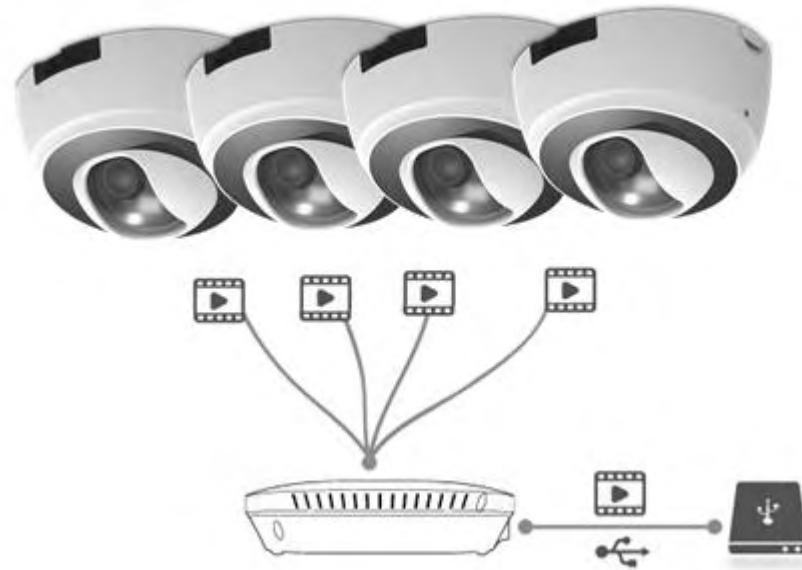

3. Easy Remote Access over Internet

Traditionally, you cannot get access to your Camera over the Internet without some manual configuration known as Port Forwarding because your camera is installed under a local network. **Smart Recording** technology takes care of all the complicated setup and leave you with ease of control. That is, you will be able to access any of the cameras in your home by providing their DDNS names on EnViewer or web browser if you are using PC/Laptop.

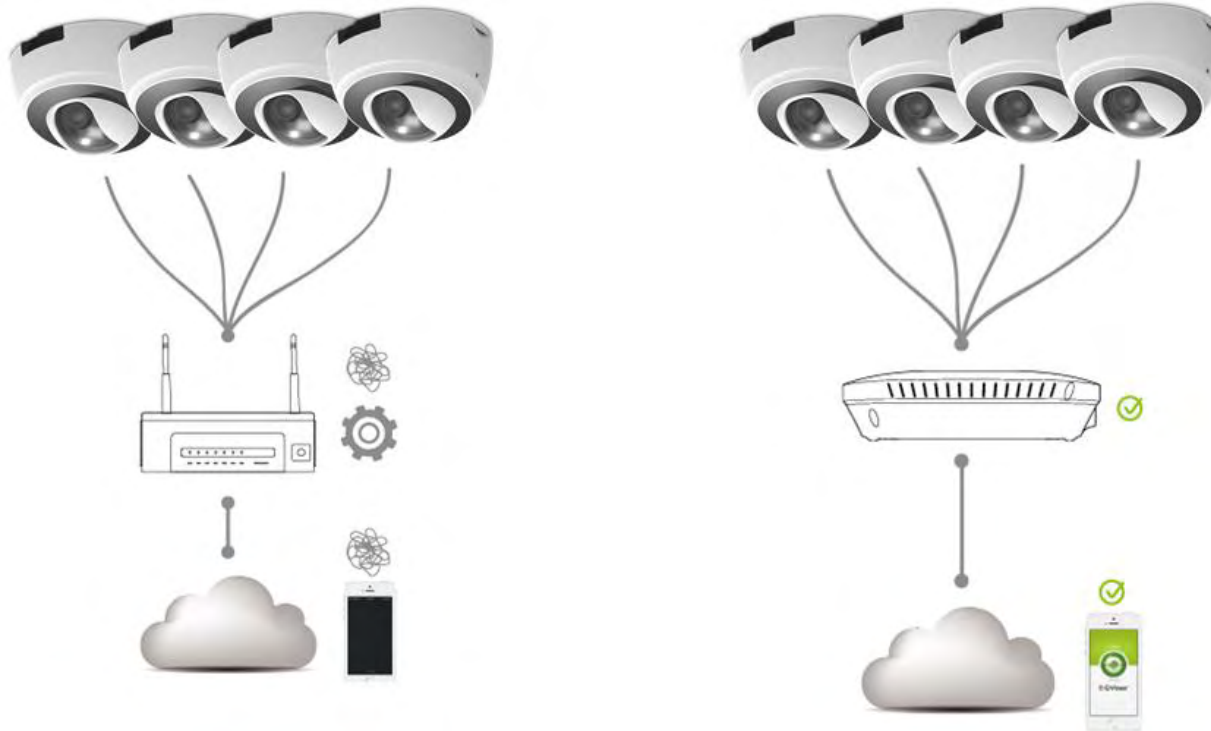

5.11. Enable Router Storage Function

The best thing about **Smart Recording** is that you can make use of the EnGenius Router Storage function. You should attach an external USB storage device (portable hard-disk or USB flash drive) to your router. Enter the Username and Password of **your router** and press **Login**.

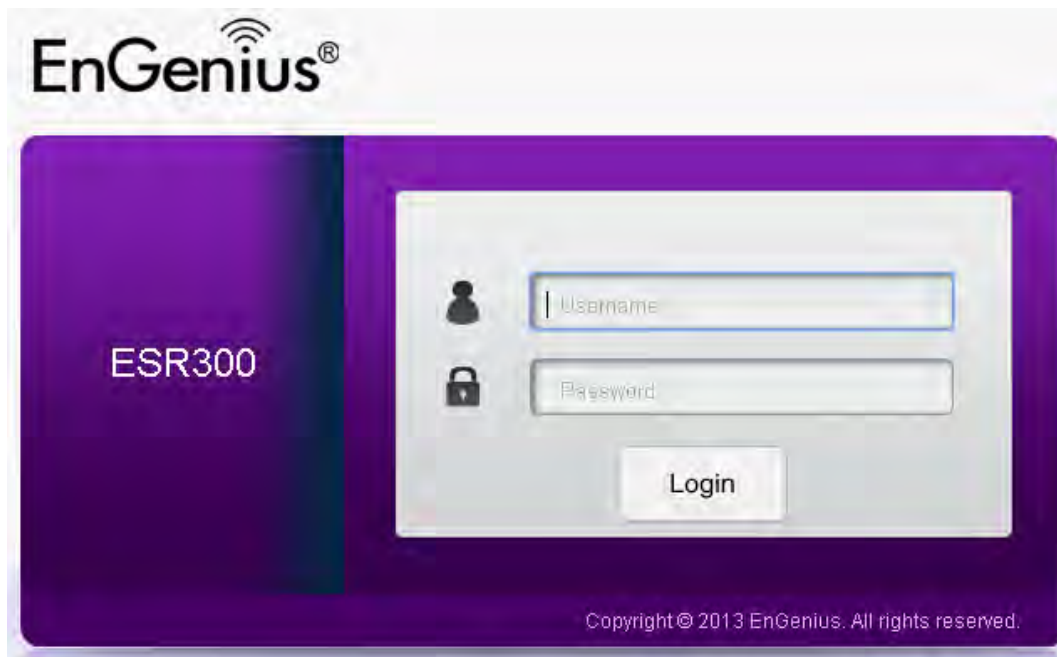



If you have not yet enable Samba Server on your router, choose **USB Port**→ **File Sharing**. Skip this step if samba is already enabled. Then, **Enable** Samba Service and click on **Apply** to activate the function.

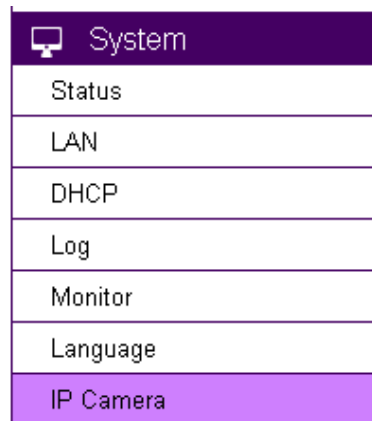

On your router's Main Menu, Click **System**→ **IP Camera** to access the connected cameras.

Note: that **only EnGenius Cameras** can be managed collectively by EnGenius Router. For other vendor's cameras, you still have to configure them one by one manually.



 **Cloud Services**
 EnShare
 EnRoute
 EnTalk

 **Router Management**
 System
 Status
 LAN
 DHCP
 Log
 Monitor
 Language
IP Camera

IP Camera Client Table

192.168.0.101 88DC9616A3D7 EDS5110

Current IP-Camera Profile

No.	Name	IP Address	MAC	Recording	Motion	Over-Write	Folder Name
-----	------	------------	-----	-----------	--------	------------	-------------

You should be see all your cameras listed on the **IP Camera Client Table**. If not, click **Refresh** button to scan the network again. Please be noted that only EnGenius Cameras will be listed on the table.

IP Camera Client Table

192.168.1.107	88DC9604CEE1	EDS3200Lobby	Connect	Add Profile
192.168.1.105	88DC9604CF38	EDS5200ParkingEntrance	Connect	Add Profile
192.168.1.106	88DC96025E7B	EDS5200SecuritySideWalk	Connect	Add Profile
192.168.1.113	004270003077	EDS5110	Connect	Add Profile

Refresh

Connect: You can get access to the selected cameras' camera manage page.

Add Profile: Add the selected camera to a profile (please refer to next section for more detail on **Profile**)

5.12. Camera Profile

A Profile is an entry that represents the added camera. You must add the camera to a profile so that the router has the privilege to configure your camera and link them together.

5.12.1. Add Profile

This example shows 4 connecting cameras on the router. We have chosen to add two cameras (Lobby and Entrance) for demonstration purpose.

Click on **Add Profile** button to add the chosen camera.

IP Camera Client Table

192.168.1.113	004270003077	EDS1130	Connect	Add Profile
192.168.1.107	88DC9604CEE1	EDS5110Lobby	Connect	Add Profile
192.168.1.100	003110016621	EDS3110	Connect	Add Profile
192.168.1.105	88DC9604CF38	EDS5110ParkingEntrance	Connect	Add Profile

USB Available Space		855.730 GB (98%)
IP Camera Name	<input type="text" value="Lobby"/>	
Schedule-Recording	<input type="button" value="Disable"/>	
Motion-Recording	<input type="button" value="Enable"/>	
Over-Write	<input type="button" value="Enable"/>	
Folder Name	<input type="text" value="Lobby"/>	
Storage Size	<input type="text" value="0"/> GB, 0 is Infinity.	

USB Available Space		855.730 GB (98%)
IP Camera Name	<input type="text" value="Entrance"/>	
Schedule-Recording	<input type="button" value="Enable"/>	
Motion-Recording	<input type="button" value="Disable"/>	
Over-Write	<input type="button" value="Disable"/>	
Folder Name	<input type="text" value="Entrance"/>	
Storage Size	<input type="text" value="0"/> GB, 0 is Infinity.	

IP Camera Name: Lobby (use meaningful name for better identification)

Scheduled-Recording: Enable/Disable this type of recording

Motion-Recording: Enable/Disable this type of recording

Over-Write: Enable/Disable over-writing the old files when there's no space for storing the new files

Folder Name: The name of the folder where the media files of this camera will be stored on the router storage.

Storage Size: put **0** if storage is unlimited.

Click **Apply** when done.

The added cameras will be listed as shown below.

Current IP-Camera Profile

No.	Name	IP Address	MAC	Recording	Motion	Over-Write	Folder Name	Storage Size	Select
1	Lobby	192.168.1.107	88DC9604CEE1	<input type="checkbox"/>	<input checked="" type="checkbox"/>	<input checked="" type="checkbox"/>	Lobby	0	<input type="checkbox"/>
2	Entrance	192.168.1.105	88DC9604CF38	<input checked="" type="checkbox"/>	<input type="checkbox"/>	<input type="checkbox"/>	Entrance	0	<input type="checkbox"/>

You can **Edit** or **Delete** profile by selecting the profile and click on the buttons below.

5.12.2.Edit Profile

Current IP-Camera Profile

No.	Name	IP Address	MAC	Recording	Motion	Over-Write	Folder Name	Storage Size	Select
1	Lobby	192.168.1.107	88DC9604CEE1	<input type="checkbox"/>	<input checked="" type="checkbox"/>	<input checked="" type="checkbox"/>	Lobby	0	<input type="checkbox"/>
2	Entrance	192.168.1.105	88DC9604CF38	<input checked="" type="checkbox"/>	<input type="checkbox"/>	<input type="checkbox"/>	Entrance	0	<input type="checkbox"/>

Select the camera profile and then click **Edit** button to make the changes.

5.12.3.Delete Profile

Current IP-Camera Profile

No.	Name	IP Address	MAC	Recording	Motion	Over-Write	Folder Name	Storage Size	Select
1	Lobby	192.168.1.107	88DC9604CEE1	<input type="checkbox"/>	<input checked="" type="checkbox"/>	<input checked="" type="checkbox"/>	Lobby	0	<input type="checkbox"/>
2	Entrance	192.168.1.105	88DC9604CF38	<input checked="" type="checkbox"/>	<input type="checkbox"/>	<input type="checkbox"/>	Entrance	0	<input type="checkbox"/>

Edit

Delete Selected

Delete All

Synchronize with IPCAM

Select the camera profile and then click **Delete Selected** button to delete the profile.

Click **Delete All** to delete all the profiles.

5.12.4.Synchronize

Current IP-Camera Profile

No.	Name	IP Address	MAC	Recording	Motion	Over-Write	Folder Name	Storage Size	Select
1	Lobby	192.168.1.107	88DC9604CEE1	<input type="checkbox"/>	<input checked="" type="checkbox"/>	<input checked="" type="checkbox"/>	Lobby	0	<input type="checkbox"/>
2	Entrance	192.168.1.105	88DC9604CF38	<input checked="" type="checkbox"/>	<input type="checkbox"/>	<input type="checkbox"/>	Entrance	0	<input type="checkbox"/>

5.13. Fine Tune Camera Configuration set by the Router

This section provides extra information on what actually happened to your camera's setting after you added it to the **Profile** on the router. It is helpful for you to go through the automatically configured camera settings and make proper changes when necessary.

Click on **Connect** button to open the chosen camera's login page.

IP Camera Client Table

192.168.1.113	004270003077	EDS1130	Connect	Add Profile
192.168.1.105	88DC9604CF38	EDS5200ParkingEntrance	Connect	Add Profile
192.168.1.106	88DC96025E7B	EDS5200SecuritySideWalk	Connect	Add Profile
192.168.1.107	88DC9604CEE1	EDS5110Lobby	Connect	Add Profile
192.168.1.100	003110016621	EDS3110	Connect	Add Profile

5.14. Access the Media files on the Router

5.14.1. Using web browser

Please refer to EnGenius Router user's manual for more detail on the Shared Storage feature.

You can click on USB Port  icon to access the storage.



Please select an account

EnGenius®



Admin (The Admin user is allowed to access all the folders of the storage page)



Guest (The Guest user has right to access the Guest folder only)

Start

Choose **Admin** and click on **Start** button.

EnShare Web Access

Select a target USB device to access the storage sharing

Note: Connecting single USB drive is suggested if there is no device shown on the list.













Generic Flash Disk ,7.358G / 8G

Choose the storage device to access the file.

EnShare Web Access

Index of /usb_admin/sda1/

Name	Last Modified	Size	Type	Rename	Select
 Parent Directory		-	Directory		<input type="checkbox"/>
 Album_Uploads	2011-Jan-01 00:01:34	-	Directory		<input type="checkbox"/>
 Guest	2011-Jan-01 00:01:34	-	Directory		<input type="checkbox"/>
 IP_Camera	2014-Jul-13 22:53:56	-	Directory		<input type="checkbox"/>
 System Volume Information	2014-May-30 09:16:44	-	Directory		<input type="checkbox"/>
 video	2011-Jan-01 00:01:32	-	Directory		<input type="checkbox"/>

In the previous example, the **Lobby** camera profile defines the path **/sda1/IP_Camera/Lobby/**

The media files will be stored as shown below.

EnShare Web Access

Index of /usb_admin/sda1/IP_Camera/Lobby/video/20140713/



Name	Last Modified	Size	Type	Rename	Select
Parent Directory		-	Directory		<input type="checkbox"/>
alarm_video_20140713-065601.avi	2014-Jul-13 14:56:10	5.5M	video/x-msvideo		<input type="checkbox"/>
alarm_video_20140713-065612.avi	2014-Jul-13 14:56:20	5.0M	video/x-msvideo		<input type="checkbox"/>
alarm_video_20140713-065622.avi	2014-Jul-13 14:56:32	5.0M	video/x-msvideo		<input type="checkbox"/>

Click the file to download it.

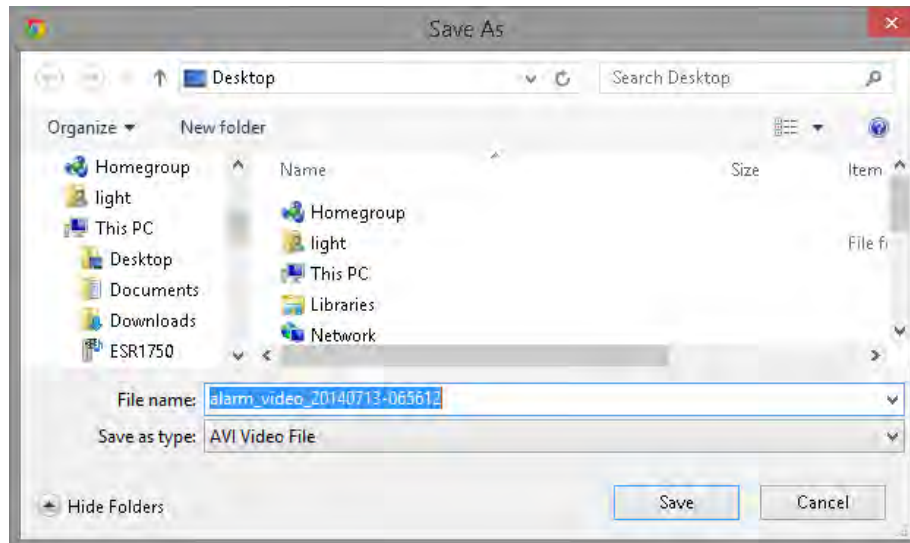

5.14.2. Using Windows File Explorer

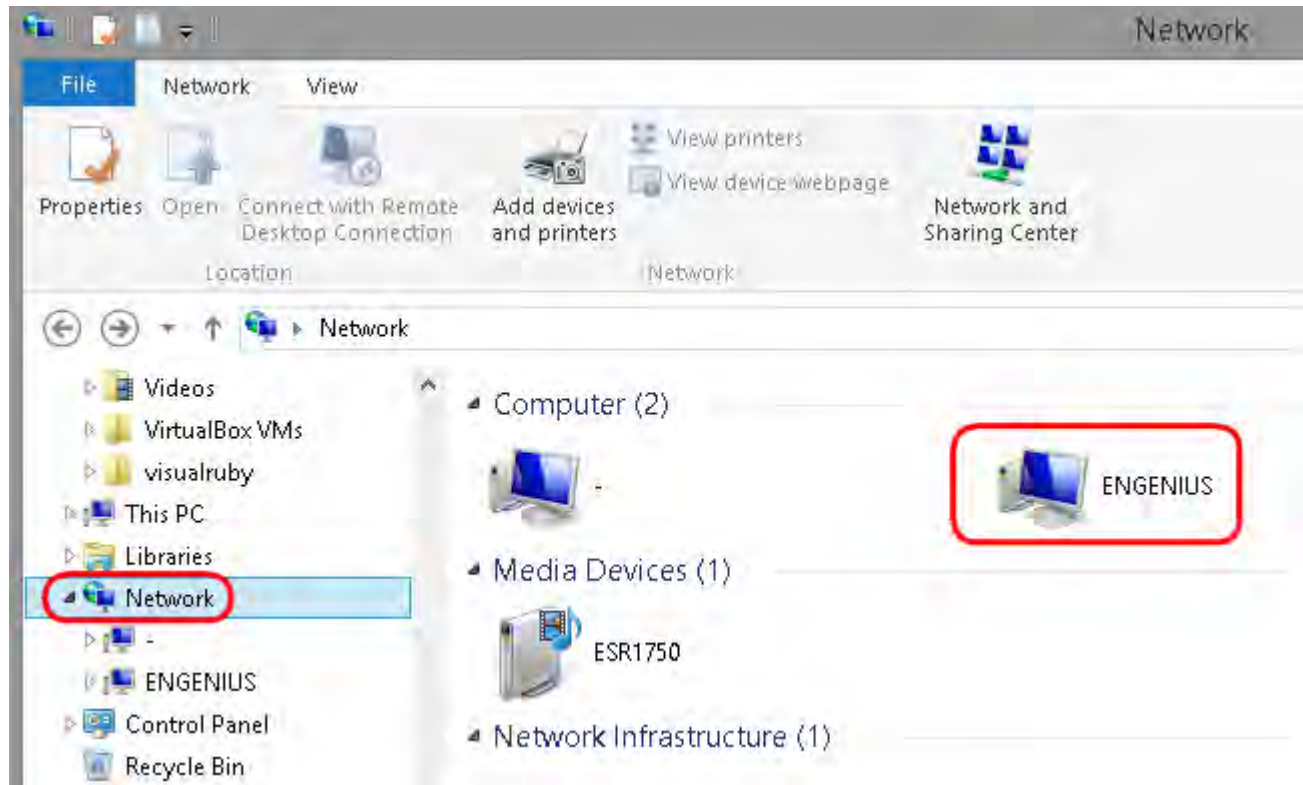

Once enabled Samba on the EnGenius router, you should find the router under Network in your File Explorer as shown above.

Double click on ENGENIUS to get access to the storage space.

Upon security prompt, enter the **router's username** and **password** to continue.

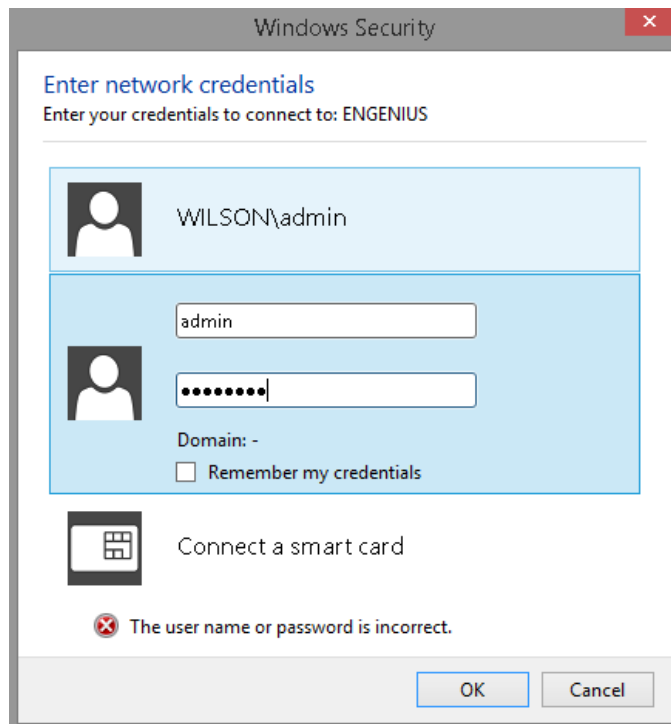

You can access the media files located under **\\ENGENIUS\sda1\IP_Camera\Lobby**

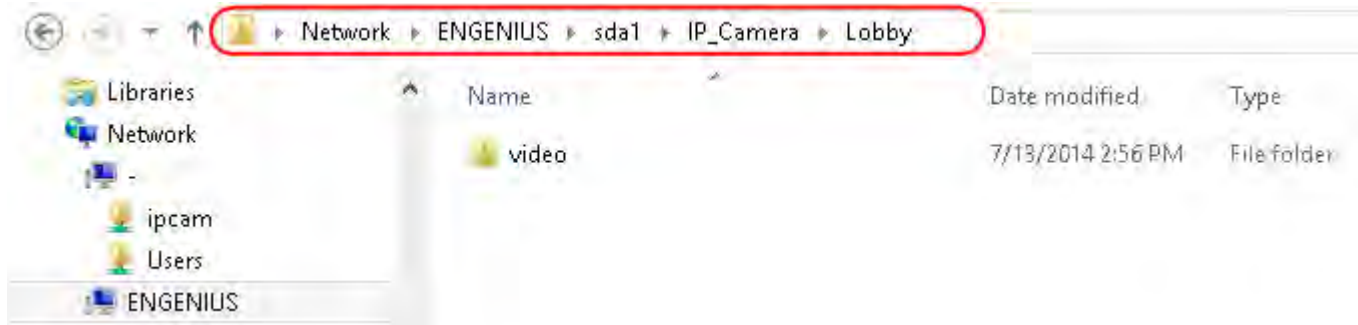

6. Camera Connecting to Other Router

Normally, you do not need to make any changes to your router setting to be able to use the camera. However, in case if you experience issues in connecting the camera, you should probably check for the following settings. UPnP, UPnP Traversal and Firewall.

UPnP and UPnP Traversal:

Universal Plug and Play (UPnP) allows the other device to detect the presence of the camera so that communication become possible. Please ensure that your router supports UPnP Traversal and has it enabled. Most of the modern wireless router today supports this feature. You should enable UPnP if you wish your camera to be recognized by the home router. If you can't find the related settings, they are most likely enabled by default. UPnP Traversal makes camera remote access over the Internet possible using camera DDNS name.

Firewall:

By default, the firewall function of the router is not configured to filter out specific traffic. However, in case if you have trouble accessing the camera view, it's likely that the traffic has been blocked by the firewall on your router. You may want to double check whether you have blocked the service ports. Check the camera setting **System** → **Service Port**. Make sure you do not block the following ports: 80, 50000, 554, 50045, 9091 and 50075.

System
Status
Service Port
Time

7. Application Guide

This chapter demonstrates a common application using EnGenius Camera. The examples assume that the camera is already connected to a router that has Internet accessibility.

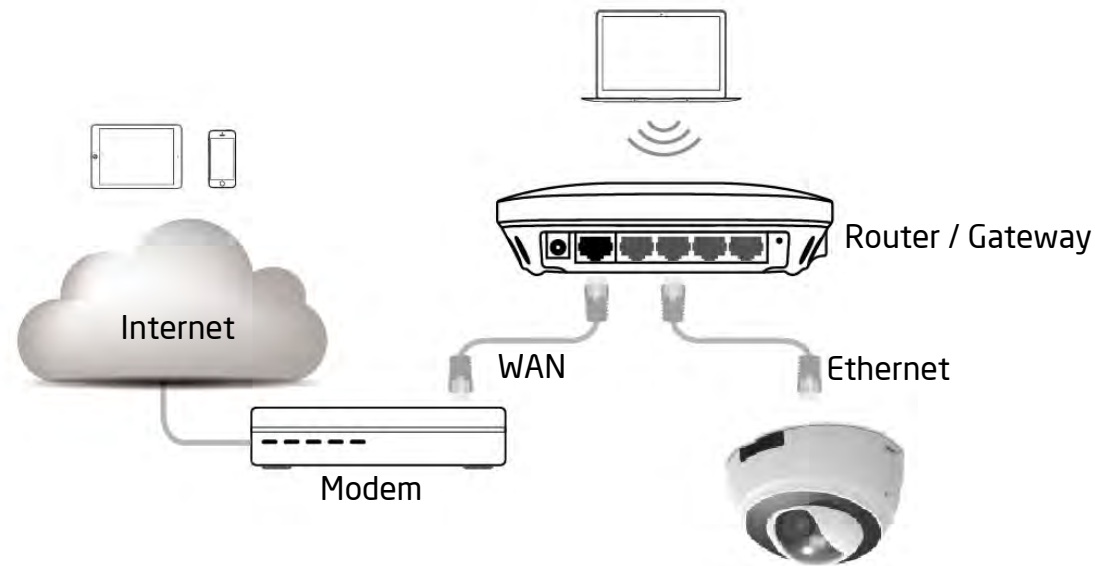





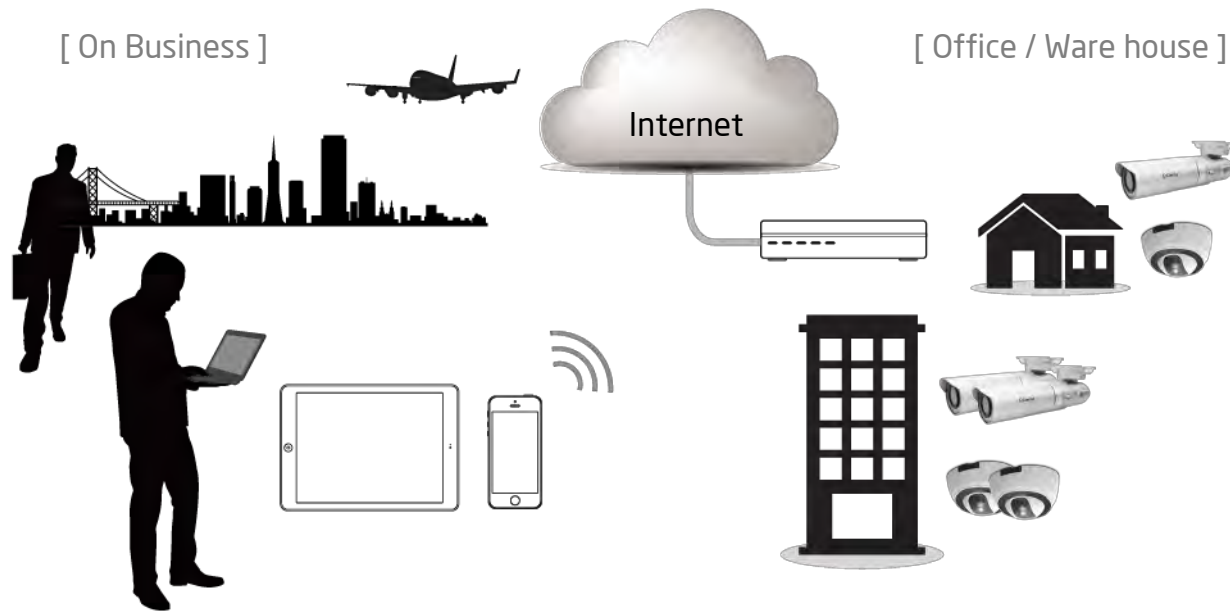

Note: Please ensure that your router supports UPnP Traversal and has it enabled. Most of the modern wireless router today supports this feature. If you can't find the related settings, they are most likely enabled by default. UPnP Traversal makes camera remote access over the Internet possible using camera DDNS name (0e95c28.engeniusddns.com).

7.1. Example: Remote Surveillance and Motion Detection.



The application concept diagram shows a camera monitoring the property like office or warehouse. The management staff wants to remotely monitor their responsible property and needs to be alarmed when motion (intrusion) is detected.

7.1.1. Step 1: Choose Event Control

 System	Event Control
 Network	Enable <input type="radio"/> Enable <input checked="" type="radio"/> Disable
 Media	Name <input type="text"/>
 Event Management	Schedule <input type="checkbox"/> Every Day
Event Control	<input type="checkbox"/> Mon <input type="checkbox"/> Tue <input type="checkbox"/> Wed <input type="checkbox"/> Thu <input type="checkbox"/> Fri <input type="checkbox"/> Sat <input type="checkbox"/> Sun
Motion Detection	<input type="checkbox"/> All Day
Tampering Detection	Time of day From <input type="text"/> : <input type="text"/> To <input type="text"/> : <input type="text"/>
Event Action	Trigger Type <input type="radio"/> Time <input checked="" type="radio"/> Detectors
 Event Server	<input checked="" type="radio"/> Motion Detection <input type="radio"/> Tampering Detection
 Storage Info	Event Notification
 User Management	Push Message <input type="radio"/> Enable <input checked="" type="radio"/> Disable
	E-Mail <input type="radio"/> Enable <input checked="" type="radio"/> Disable
	VMS <input type="radio"/> Enable <input checked="" type="radio"/> Disable
	Event Action
	Action Type <input type="text" value="Disable"/> ▼

Please select preferred Event Action; for example here, E-Mail would be suggested.

7.1.2. Step 2: Configure Motion Detection

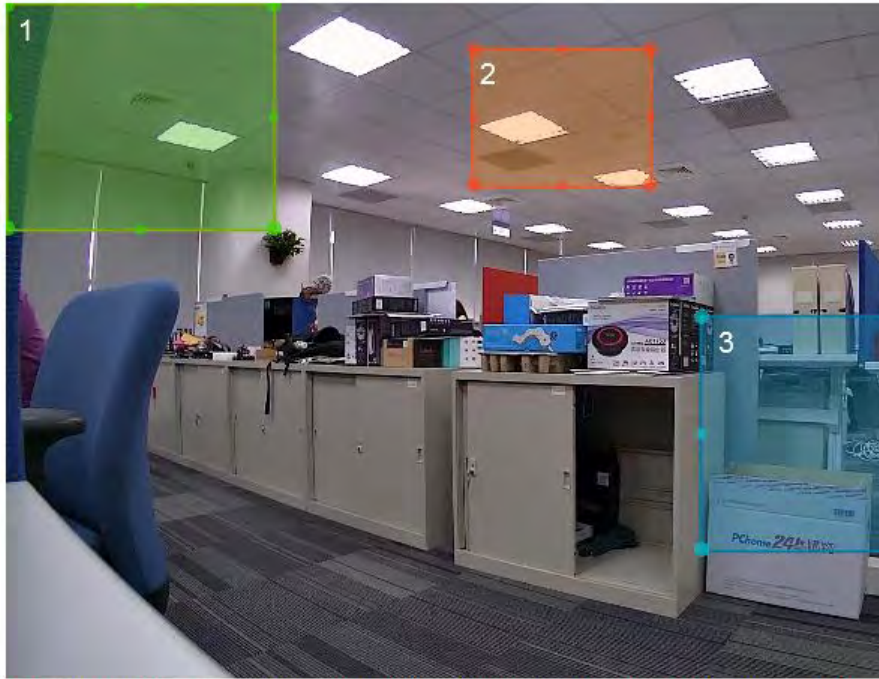
System	<p>Motion Detection Settings</p>  <p>Note: You can adjust the motion detecting area by dragging the four corners to resize the window.</p>
Network	
Media	
Event Management	
Event Control	
Motion Detection	
Tampering Detection	
Event Action	
Event Server	
Storage Info	
User Management	

Please specify **Window** of your interest and click **Apply**.

7.1.3. Step 3: Configure Event Action

System	
Network	
Media	
Event Management	
Event Control	
Motion Detection	
Tampering Detection	
Event Action	
Event Server	
Storage Info	
User Management	

Event Action	
Buffer Duration Until Next Event	20 sec(s) ▼
Event Snapshot	
Snapshot Duration	10 sec(s) ▼
Event Recording	
Video Format	AVI
Stream Type	H.264 (1920 x 1080) ▼
Time	
Video Length	1 min(s) ▼
Detectors	
Pre-event Buffer	1 sec(s) ▼
Record Duration	20 sec(s) ▼

Select desired **Event Duration** and **Interval**; if you enable **Event Recording** via available methods such as **Network Storage** or **FTP**, please also review related settings regarding length and resolution. Once done, click **Apply** to activate the settings.

8. Trouble Shooting

8.1. Viewing Your Video

How do I view using a mobile?

You can view your video on your mobile devices (iOS or Android) by using **EnViewer**. EnViewer is an App that allows you to view and manage your camera at real time.

Where can I download my app?

You can download it by searching APP store (iOS) or Google Play(Android) for “EnViewer”. You can also scan the following QR code to download **EnViewer** directly.



How do I use the web viewer on a computer?

You can view the camera at real time using a web browser. The supported web browsers are Google **Chrome** and Microsoft **Internet Explorer**. Given that you have configured your camera properly, you should be able to get access to your camera by entering its **DDNS** or **IP address**.

If you may have troubles finding your camera on your network, please use the provided utility on the enclosed CD, **EnViewer Finder**, to find out your camera's current IP address.

8.2. Networking

How can I minimize interference?

Make sure there is no electrical appliance near the camera, such as microwave or devices that may interfere with the camera. Upon experiencing interference, try to turn off possible electrical devices that are currently running.

8.3. Security and Privacy

Accessing the camera from the Internet is convenient; however, it is also possible for anyone who has your username and password to login into your camera. Therefore, it is crucial to keep your username and password safe and change them regularly. Your videos or images are stored either locally or in network storage. The images and videos are accessible only when provided with proper security check.

Can EnGenius employees view my video?

No! No one can view your video or login into your camera without security check. The username and password is stored locally in your camera and it is not accessible by anyone but yourself. Therefore, it is important to keep your security information safely.

8.4. Cloud Video Services

If I cannot connect to the cloud service, what should I do next?

Please check your router's Internet settings. You can first check the Internet connectivity from other devices connecting to the router and determine possible sources to cause the issue. If other connecting devices can connect to the Internet through the router, the problem may be caused from other router settings. Check wireless security settings and turn off any firewall rules on the router to see if connection can get through.

9. Appendix

Federal Communication Commission Interference Statement

This device complies with Part 15 of the FCC Rules. Operation is subject to the following two conditions: (1) This device may not cause harmful interference, and (2) this device must accept any interference received, including interference that may cause undesired operation.

This equipment has been tested and found to comply with the limits for a Class B digital device, pursuant to Part 15 of the FCC Rules. These limits are designed to provide reasonable protection against harmful interference in a residential installation. This equipment generates, uses and can radiate radio frequency energy and, if not installed and used in accordance with the instructions, may cause harmful interference to radio communications. However, there is no guarantee that interference will not occur in a particular installation. If this equipment does cause harmful interference to radio or television reception, which can be determined by turning the equipment off and on, the user is encouraged to try to correct the interference by one of the following measures:

- Reorient or relocate the receiving antenna.
- Increase the separation between the equipment and receiver.
- Connect the equipment into an outlet on a circuit different from that to which the receiver is connected.

- Consult the dealer or an experienced radio/TV technician for help.

FCC Caution: Any changes or modifications not expressly approved by the party responsible for compliance could void the user's authority to operate this equipment.

This transmitter must not be co-located or operating in conjunction with any other antenna or transmitter.

Radiation Exposure Statement:

This equipment complies with FCC radiation exposure limits set forth for an uncontrolled environment. This equipment should be installed and operated with minimum distance 20cm between the radiator & your body.