

User Manual



EnStation5-AC/EnStationAC
version 1.1

AC867 5GHz Ultra Long-Range Wireless Outdoor Customer
Premises Equipment

IMPORTANT

To install this Access Point please refer to the **Quick Installation Guide** included in the product packaging.

Table of Contents

Chapter 1 Product Overview.....	4	Wireless MAC Filtering.....	41
Key Features/Introduction.....	5	Wireless Advanced.....	42
System Requirements.....	6	WPS Mixed-Enterprise: AP/WDS AP Mode.....	43
Package Contents.....	7	WDS Link Settings.....	44
Technical Specifications.....	8	Client Bridge Settings.....	45
Physical Interface.....	10	Guest Network Settings.....	46
Chapter 2 Before You Begin.....	11	Chapter 8 Management	47
Computer Settings.....	12	Management VLAN Settings.....	48
Hardware Installation.....	15	Advanced Settings.....	49
Mounting the EnStationAC.....	16	CLI Settings/Email Alert.....	50
Chapter 3 Configuring Your Access Point.....	19	Time Zone.....	52
Default Settings./Web Configuration.....	20	Auto Reboot Settings.....	53
Chapter 4 Building a Wireless Network.....	21	Wi-Fi Scheduler.....	54
Access Point / WDS AP Mode.....	22	Tools.....	55
Client Bridge Mode.....	23	Account/Firmware.....	57
WDS Bridge Mode.....	24	Backup/Restore	58
WDS Station Mode.....	26	Log.....	60
Chapter 5 Status.....	27	Logout/Reset.....	61
Main Status.....	28	Appendix.....	62
Connection.....	30	FCC Interference Statement.....	63
Chapter 6 Network	32	CE Interference Statement.....	64
Basic IP Settings.....	33	Professional Installation Instrution.....	71
Spanning Tree Protocol Setting.....	34		
Chapter 7 2.4 GHz/5 GHz Wireless.....	35		
Wireless Settings.....	36		
Wireless Network.....	37		
SSID Profile.....	39		
Wireless Security.....	40		

Chapter 1

Product Overview



Introduction

Key Features

- Up to 23/26 dBm transmit power enabling long range connectivity
- Supports IEEE802.11ac/a/n wireless standards with up to 867 Mbps data rate.
- Internal 19dBi high gain directional antenna
- Can be used with included PoE adapter or via 802.3at PoE 802.3at - capable switches. (EnStationAC)
- Can be used with included 24V PoE adapter (EnStation5-AC)
- Can be supply 802.3af power source used with included PoE adapter power adapter or via 802.3at PoE - capable switches (EnStationAC)
- Secured Guest Network option available
- Advanced 256-QAM technology to achieve optimal performance throughout ultra-long distance



Introduction

The EnStationAC/EnStation5-AC is a high-powered, ultra long-range 2x2 Wireless 802.11ac/a/n Outdoor Access Point with speeds up to 867 Mbps on both its high-powered 5 GHz radios. It can be configured as an: Access Point, Client Bridge or WDS (AP, Station & Bridge). The EnStationAC is designed to operate in a variety of outdoor environments.

Its high-powered, long-range characteristics make it a cost effective alternative to ordinary Access Points that don't have the range and reach to connect to a growing number of wireless CPEs who wish to connect to a business network. The EnStationAC supports the 5 GHz frequency band for communicating to other 5GHz frequency bands

Maximum data rates are based on IEEE 802.11 standards. Actual throughput and range may vary depending on many factors including environmental conditions, distance between devices, radio interference in the operating environment, and mix of devices in the network. Features and specifications subject to change without notice. Trademarks and registered trademarks are the property of their respective owners. For United States of America: Copyright © 2011 EnGenius Technologies, Inc. All rights reserved.

Access Points concurrently. Several EnStationACs can be networked in a campus setting using the 5 GHz band between countries. The EnStationAC is easy to install in virtually any location with its included PoE (Power over Ethernet) Adapter for quick outdoor installation. The EnStationAC enables network administrators to control its transmit power and features settings for selecting VHT80 bandwidth to perform ture AC transmission. The EnStationAC also supports wireless encryption including Wi-Fi Protected Access (WPA-PSK/ WPA2-PSK) Encryption and IEEE 802.1X with RADIUS.)

System Requirements

The following are the Minimum System Requirements in order to configure the device.

- Computer with an Ethernet interface or wireless network capability
- Windows OS (XP, Vista, 7, 8, 10), Mac OS, or Linux-based operating systems
- Web-Browsing Application (i.e.: Internet Explorer, Firefox, Safari, or another similar browser application)

Package Contents

The EnStationAC package contains the following items:*

- EnStationAC Customer Premises Equipment
- PoE Adapter (EPA5006GP)
- Pole Mount Strap
- Wall Mount Bracket Base
- Screw Sets Kit
- Rubber
- Sealing Nut
- Dynamic Stick
- Quick Installation Guide

*(all items must be in package to issue a refund):

Package Contents

The EnStation5-AC package contains the following items:*

- EnStationAC Customer Premises Equipment
- PoE Adapter (EPA2406GP)
- Pole Mount Strap
- Wall Mount Bracket Base
- Screw Sets Kit
- Rubber
- Sealing Nut
- Dynamic Stick
- Quick Installation Guide

*(all items must be in package to issue a refund):

Technical Specifications - EnStationAC

Standard:

IEEE802.11ac/a/n on 5 GHz

IEEE802.3at

IEEE802.3af

Antenna

Internal 19dBi high gain directional antenna

Physical Interface

2 x 10/100/1000 Gigabit Ethernet Port with PoE support

LAN(PoE) Port supports IEEE802.3at PoE Input

LAN Port supports IEEE802.3af PoE Output

LED Indicator

Power

LAN 1

LAN 2

WLAN

WLAN LED (Weak, Medium, Strong)

Power Requirements

Include PoE Adapter, 54V/0.6A

IEEE802.3at support

Operation Modes

Access Point

Client Bridge

WDS

WDS Detail

WDS AP

WDS Bridge

WDS Station

Optimal Performance

Distance Control (Ack Timeout)

Multicast Supported

Data Rate Selection

Auto Channel Selection

BSSID Support

Easily Management

VLAN Tag / VLAN Pass-through

Guest Network

QoS: Complaint with IEEE 802.11e /WMM

RADIUS Accounting

Wireless STA (Client) connection list

Traffic Shaping (Per SSID)

Intuitive Tools

SNMP v1/v2c/v3 support

MIB I/II, Private MIB

Save Configuration as Default

CLI Support

WiFi-Scheduler/Auto Reboot

E-mail Alert

Reinforcement Security

WEP Encryption-64/128/152 bit

WPA/WPA2 Enterprise (WPA-EAP using TKIP or AES)

Hide SSID in beacons

MAC address filtering up to 32 MACs per SSID

Https Support

SSH

QoS (Quality of Service)

Compliant with IEEE 802.11e standard

Physical/Environment Conditions

Operating:

Temperature: -20 °C to 60 °C (-4 °F to 140 °F)

Humidity (non-condensing): 90% or less

Storage:

Temperature: -30 °C to 80 °C (-22 °F to 176 °F)

Humidity (non-condensing): 90% or less

Technical Specifications - EnStation5-AC

Standard:

IEEE802.11ac wave2/a/n on 5 GHz

Antenna

Internal 19dBi high gain directional antenna

Physical Interface

2 x 10/100/1000 Gigabit Ethernet Port with PoE support
LAN(PoE) Port supports 24V PoE Input

LED Indicator

Power
LAN 1
LAN 2
WLAN
WLAN LED (Weak, Medium, Strong)

Power Requirements

Include PoE Adapter, 24V/0.6A

Operation Modes

Access Point
Client Bridge
WDS

WDS Detail

WDS AP
WDS Bridge
WDS Station

Optimal Performance

Distance Control (Ack Timeout)

Multicast Supported

Data Rate Selection

Auto Channel Selection

BSSID Support

Easily Management

VLAN Tag / VLAN Pass-through

Guest Network

QoS: Complaint with IEEE 802.11e /WMM

RADIUS Accounting

Wireless STA (Client) connection list

Traffic Shaping (Per SSID)

Intuitive Tools

SNMP v1/v2c/v3 support

MIB I/II, Private MIB

Save Configuration as Default

CLI Support

WiFi-Scheduler/Auto Reboot

E-mail Alert

Reinforcement Security

WEP Encryption-64/128/152 bit

WPA/WPA2 Enterprise (WPA-EAP using TKIP or AES)

Hide SSID in beacons

MAC address filtering, up to 32 MACs per SSID

Wireless STA (Client) connection list

Https Support

SSH Support

QoS (Quality of Service)

Compliant with IEEE 802.11e standard

Physical/Environment Conditions

Operating:

Temperature: -20 °C to 60 °C (-4 °F to 140 °F)

Humidity (non-condensing): 90% or less

Storage:

Temperature: -30 °C to 80 °C (-22 °F to 176 °F)

Humidity (non-condensing): 90% or less

Physical Interface

Dimensions and Weights

Dimension: 190mm (7.48")

Height: 38mm (1.9")

Weight: 527g (1.16 lbs)



1 WLAN Signal LED: Applied on Client Bridge/WDS

(1) Red: Weak Signal: Connecting quality is bad.

(2) Yellow: Connecting quality is Normal.

(3) Green: Connection quality is Good.

2 LAN(PoE) Signal LED

3 LAN Signal LED of the 2nd Port

4 Power Signal:

5 LAN Port 1: Gigabit Ethernet port for RJ-45 cable.

6 LAN Port 2: Gigabit Ethernet port for RJ-45 cable.

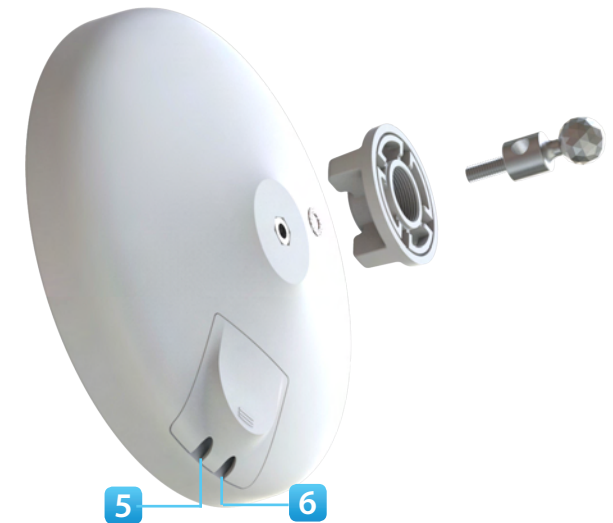

Chapter 2

Before You Begin



Computer Settings

Windows XP/Windows 7/Windows 8/Windows 10

In order to use the Access Point, you must first configure the TCP/IPv4 connection of your Windows OS computer system.

1a. Click the **Start** button and open the **Control Panel**

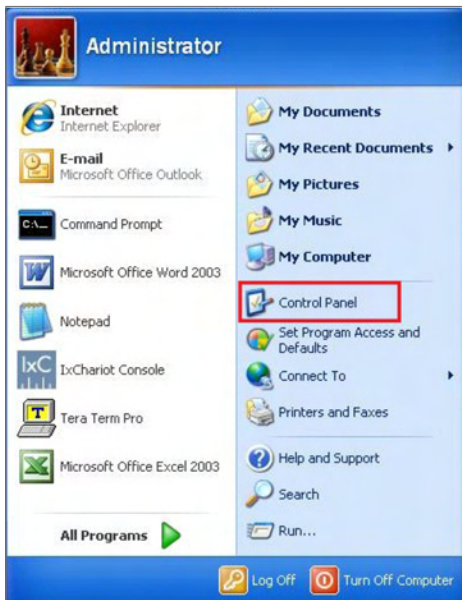

Windows XP

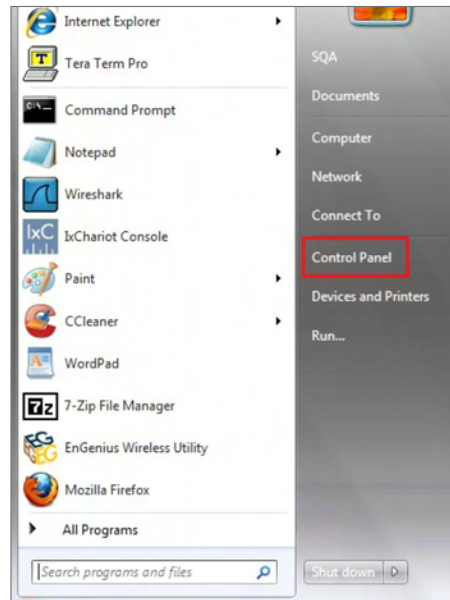

Windows 7

1b. Move your mouse to the lower right hot corner to display the Charms Bar and select the **Control Panel** in Windows 8 OS.

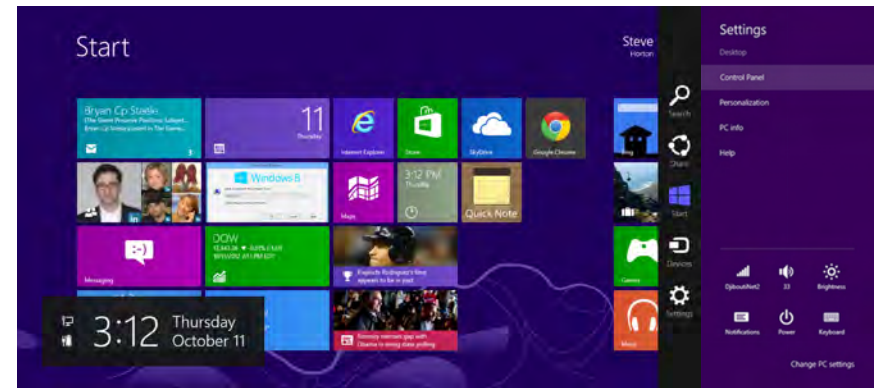

Windows 8

1c. In Windows 10, click **Start** to select **All APPs** to enter the folder of **Windows system** for selecting **Control Panel**.

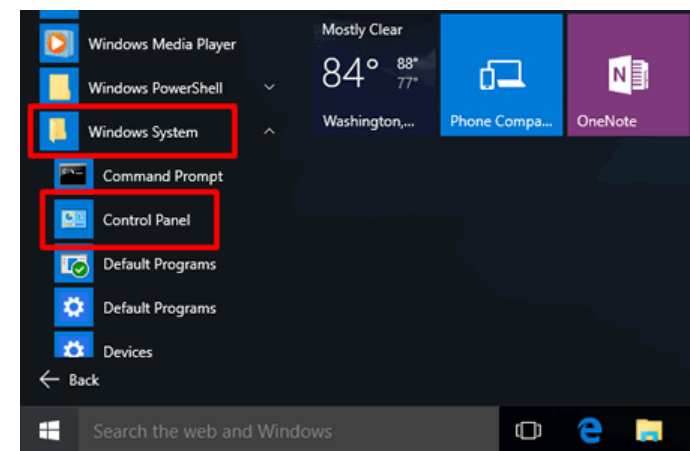

Windows 10

2a. In Windows XP, click **Network Connections**.



2b. In Windows 7/Windows 8/Windows 10, click **View Network Status and Tasks** in the **Network and Internet** section, then select **Change adapter settings**.

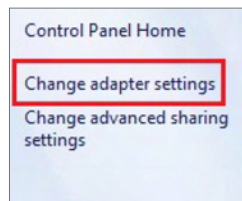

3. Right click on **Local Area Connection** and select **Properties**.

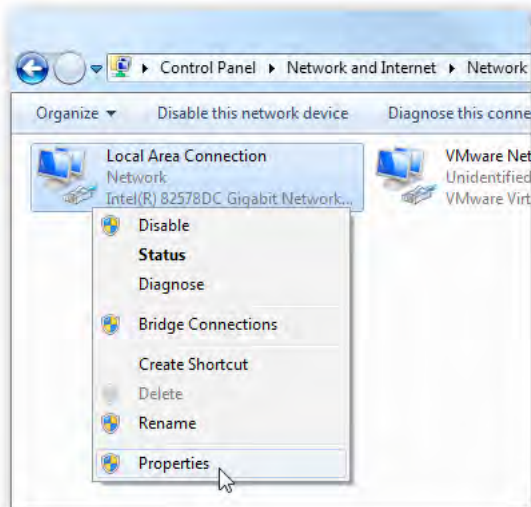

4. Select **Internet Protocol Version 4 (TCP/IPv4)** and then select **Properties**.

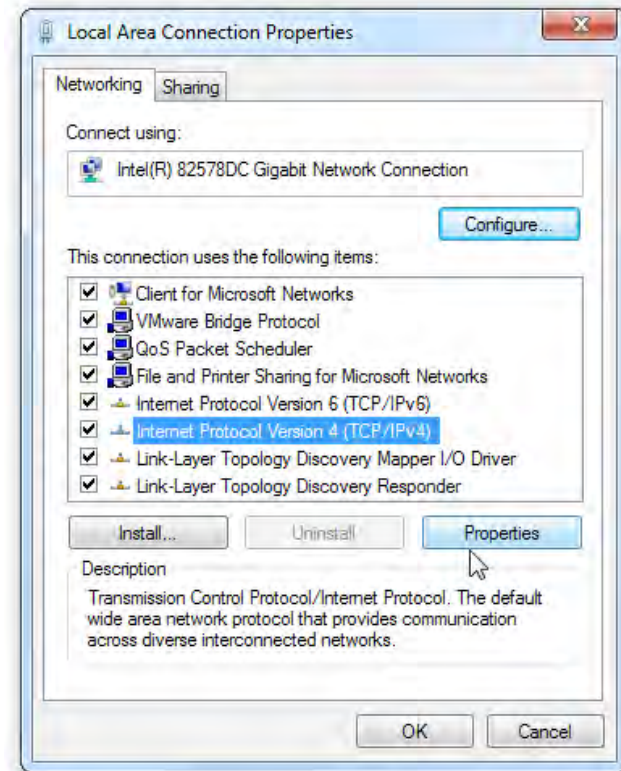

5. Select **Use the following IP address** and enter an IP address that is different from the Access Point and Subnet mask, then click **OK**.

Note: Ensure that the IP address and Subnet mask are on the same subnet as the device.

For example: ENH220EXT IP address: 192.168.1.1

PCIP address: 192.168.1.2 - 192.168.1.255

PC Subnet mask: 255.255.255.0

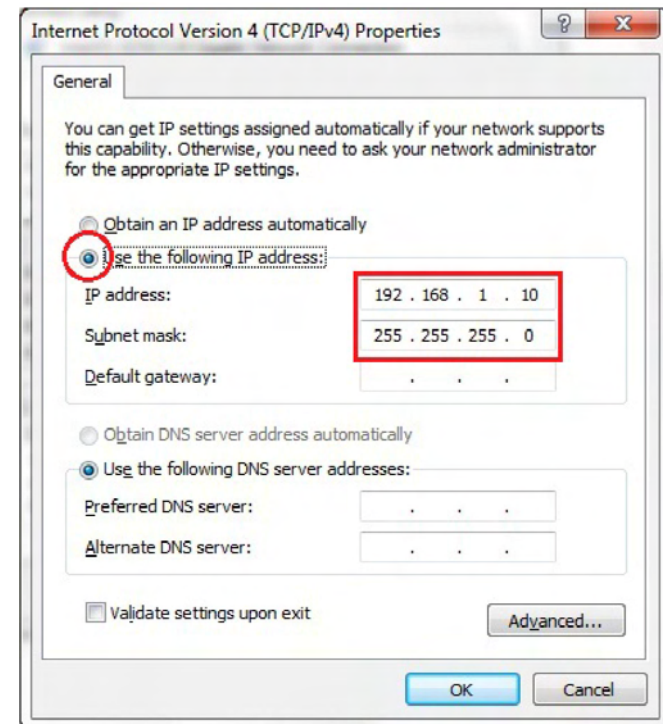

Apple Mac OS X

1. Go to **System Preferences** (Which can be opened in the Applications folder or selecting it in the Apple Menu).
2. Select **Network** in the **Internet & Network** section.



3. Highlight **Ethernet**.

4. In **Configure IPv4**, select **Manually**.
5. Enter an IP address that is different from the Access Point and Subnet mask then press **OK**.

Note: Ensure that the IP address and Subnet mask are on the same subnet as the device.

For example: ENH900EXT IP address: 192.168.1.1

PC IP address: 192.168.1.2 - 192.168.1.255

PC Subnet mask: 255.255.255.0

6. Click **Apply** when done.

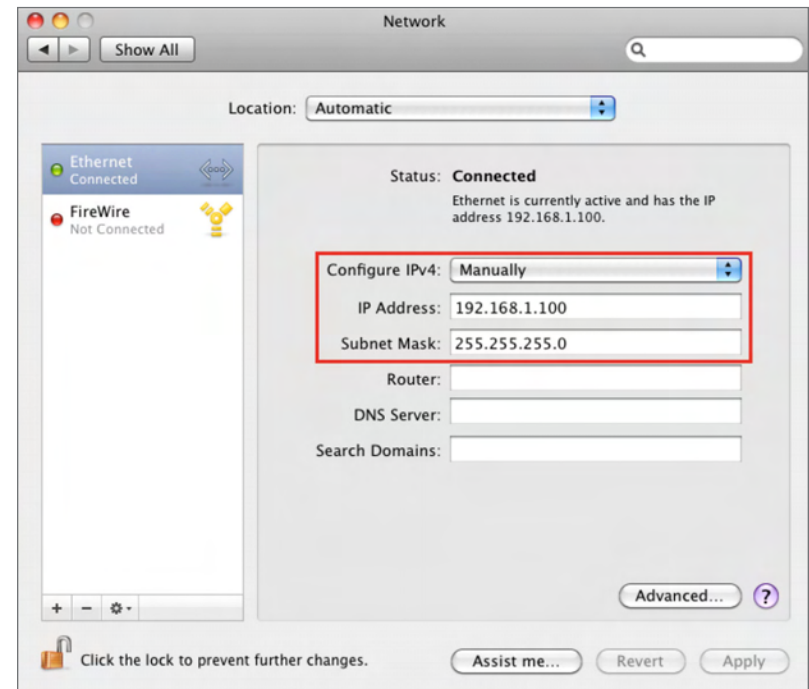

Hardware Installation

1. Remove the rear bottom panel.
2. Connect one end of the Ethernet cable into the main LAN port (PoE) of the Access Point and the other end to the AP Ethernet port on the PoE Adapter.
3. Connect the Power cord to the **PoE Adapter** and plug the other end in to an electrical outlet.
4. Connect the second Ethernet cable into the **LAN port** of the PoE Adapter and the other end to the Ethernet port on the computer.
5. Place the panel back into device

Note: The EnStationAC should ONLY be powered via Ethernet cable connected to included supports both IEEE 802.3at PoE (Power over Ethernet) or the included PoE Adapter. You may use either one as the power source. **Do NOT use both at the same time.**

Note: The EnStationAC can supply the 802.3af power source when used with included PoE Adapter.

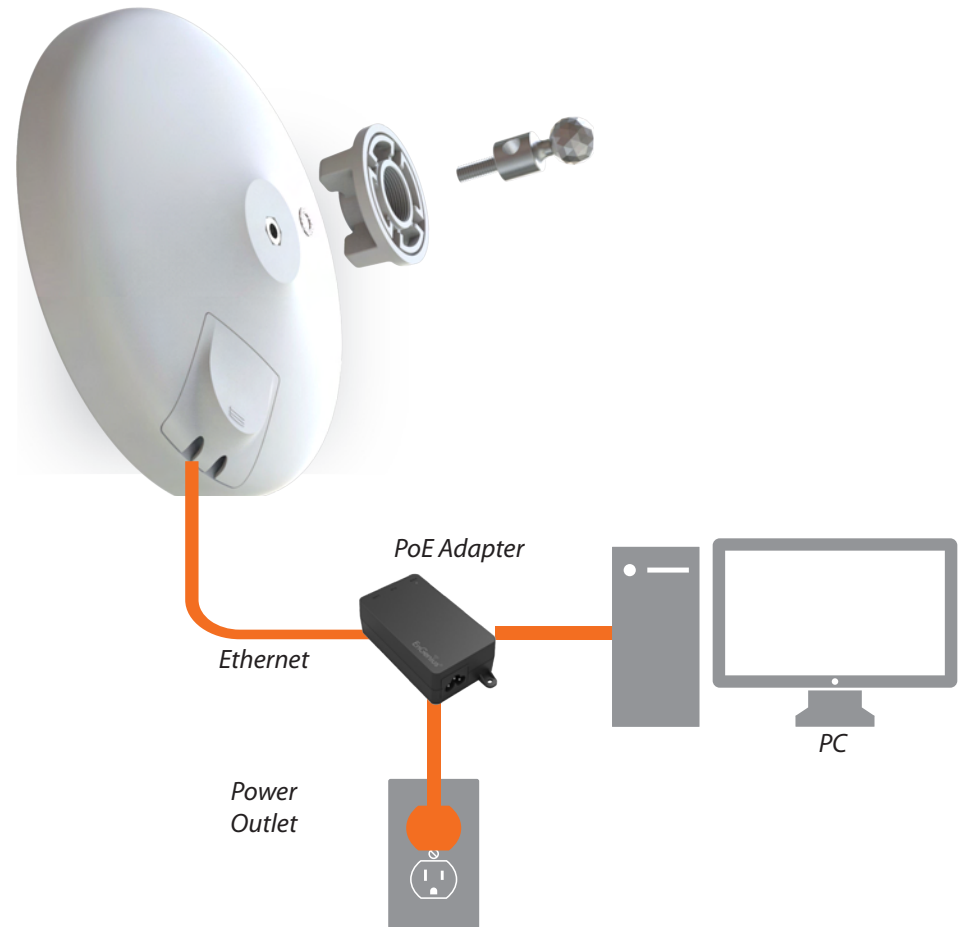

Mounting the EnStation

Using the provided hardware, the EnStationAC can be attached to a wall or a pole.

1. EnStation

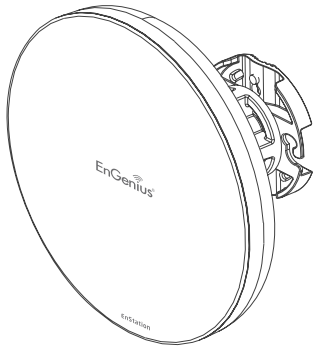

2. PoE Adapter & Power Cord



3. Bracket

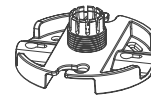

4. Pole Mounting Strap



5. Screw Set Kit

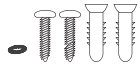

6. Sealing Nut

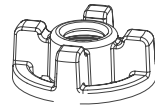

7. Dynamic Stick



8. Rubber



Wall mounting the EnStation

1. Put the included rubber into the bracket.
2. Plug the dynamic stick into the bracket.
3. Screw the sealing nut and assembled parts, as well as tighten it.
4. Put the nock washer on the dynamic stick.
5. Assemble the mounting parts to the EnStation.

6. Determine the mounting location. Mark and drill two pilot holes aligning to the screw holes of the bracket.
7. Put wall anchors into the holes and insert screw into the wall anchor.
8. Screw and secure the bracket in the place.

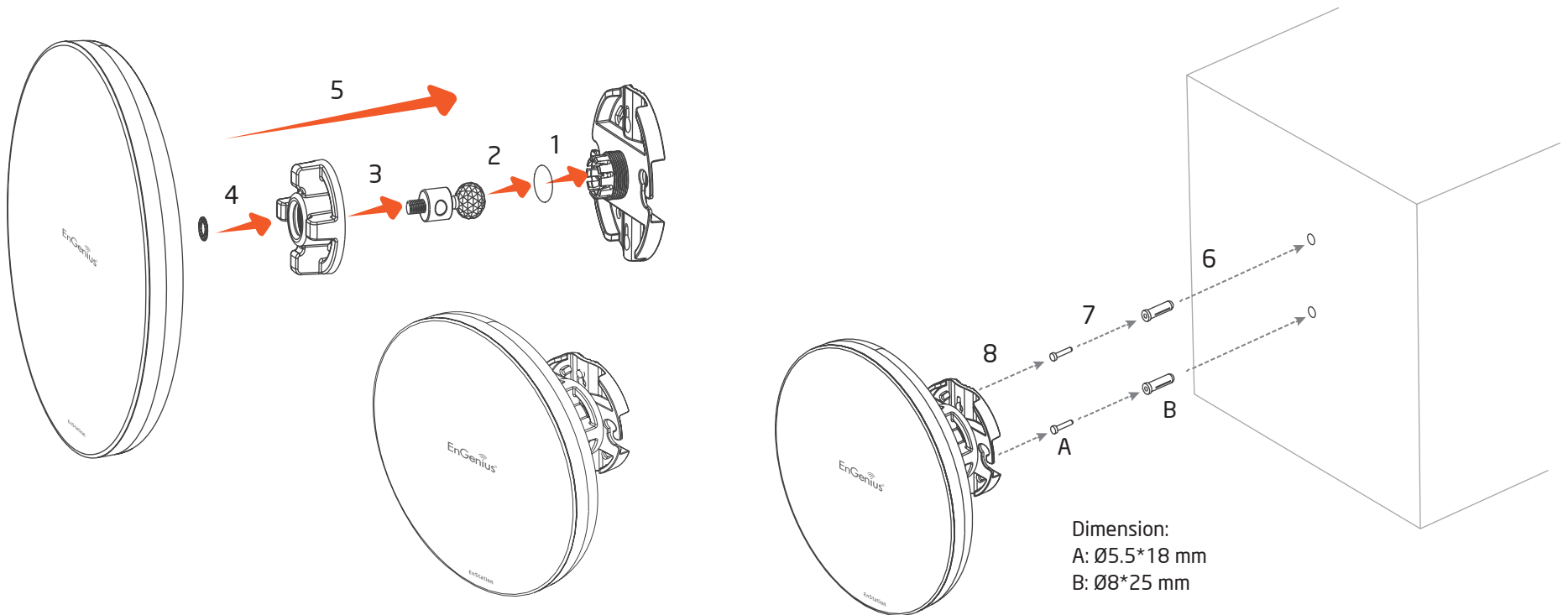

Pole mounting the EnStation

1. Put the included rubber into the bracket.
2. Plug the dynamic stick into the bracket.
3. Screw the sealing nut and assembled parts, as well as tighten it.
4. Put the nock washer on the dynamic stick.
5. Assemble the mounting parts to the EnStation.

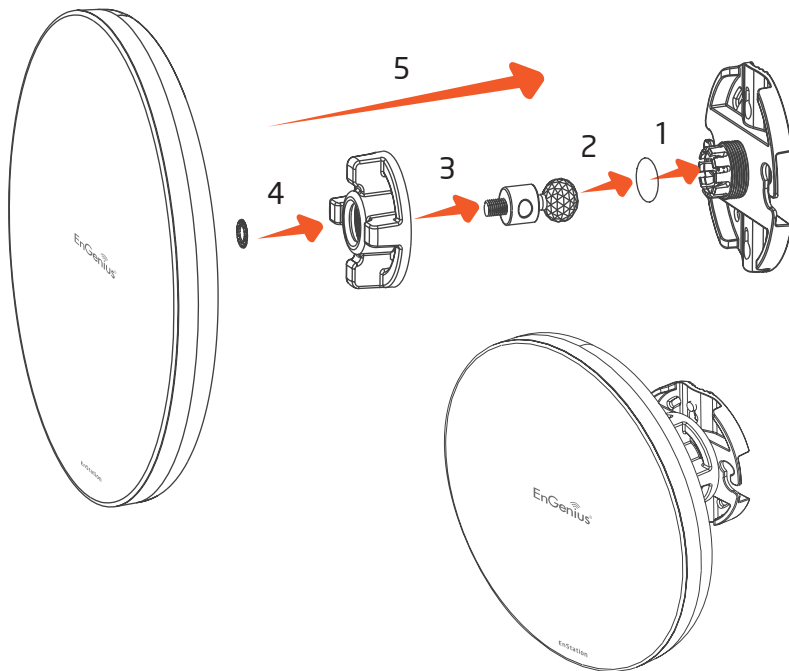

6. Thread the open end of the pole strap through the two tabs on the bracket.
7. Lock and tighten pole strap to secure bracket to the pole.

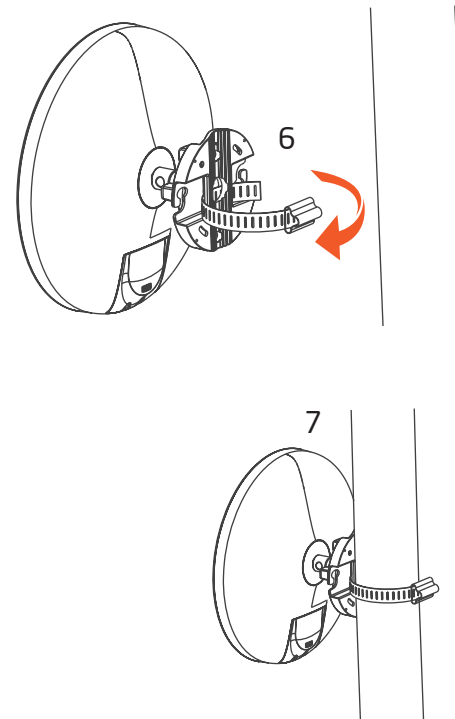

Chapter 3

Configuring Your Access Point



Configuring Your Access Point

This section will show you how to configure the device using the web-based configuration interface.

Default Settings

Please use your Ethernet port or wireless network adapter to connect the Access Point.

IP Address	192.168.1.1
Username / Password	admin / admin

Web Configuration

1. Open a web browser (Internet Explorer/Firefox/Safari/Chrome) and enter the IP Address **http://192.168.1.1**

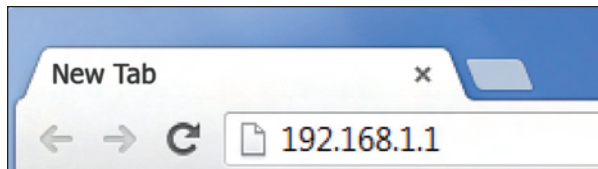

Note: If you have changed the default LAN IP Address of the Access Point, ensure you enter the correct IP Address.

2. The default username and password are **admin**. Once you have entered the correct username and password, click the **Login** button to open the web-base configuration page.

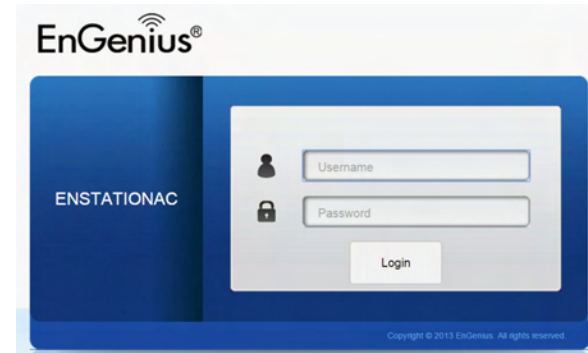

- * The model name will be varied by different models
3. If successful, you will be logged in and see the EnStationAC User Interface.

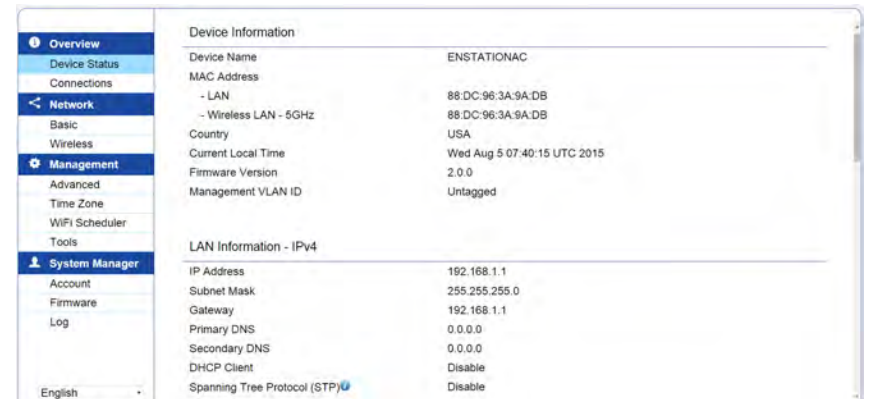

Chapter 4

Building a Wireless Network



The EnStationAC has the ability to operate in various modes. This chapter describes the operating modes of the EnStationAC.

Access Point Mode

In Access Point Mode, EnStationAC behaves like a central connection for stations or clients that support IEEE 802.11 a/b/g/n networks. The stations and clients must be configured to use the same SSID (Service Set Identifier) and security password to associate with the EnStationAC. The EnStationAC supports up to eight (8) SSIDs per band at the same time for secure access.

WDS AP Mode



Client Bridge Mode

The EnStationAC essentially acts as a wireless adapter that connects to an access point to allow a system of wireless access to the network in the Client Bridge mode. Since the computers are on the same subnet, the EnStationAC can broadcast to reach all end-devices.

If you use the client bridge mode in the EnStationAC, you can use the AP Detection feature to scan for Access Points within range. When you find an Access Point, configure the EnStationAC to use the same SSID and Security Password as the Access Point to associate with it.

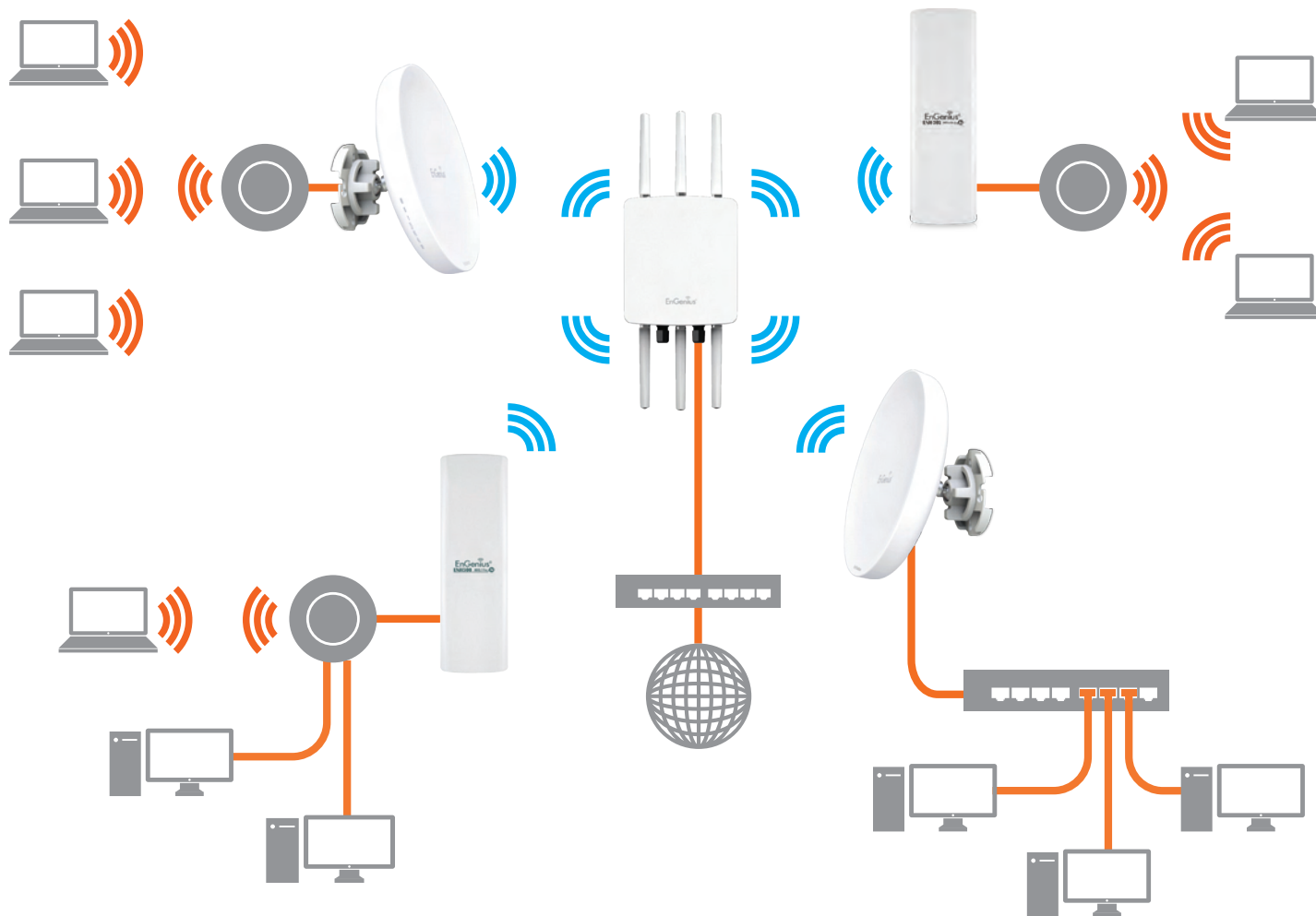

WDS AP Mode

The EnStationAC also supports WDS AP mode. This operating mode allows wireless connections to the EnStationAC using WDS technology. In this mode, configure the MAC addresses in both Access Points to enlarge the wireless area by enabling WDS Link settings. WDS supports up to four (4) AP MAC addresses.



WDS Bridge Mode

In WDS Bridge Mode, the EnStationAC can wirelessly connect different LANs by configuring the MAC address and security settings of each EnStationAC device. Use this mode when two wired LANs located a small distance apart want to communicate with each other. The best solution is to use the EnStationAC to wirelessly connect two wired LANs, as shown in the following diagram.

WDS Bridge Mode can establish up to four WDS links, creating a star-like network.

Note: WDS Bridge Mode does not act as an Access Point. Access Points linked by WDS are using the same frequency channel. More Access Points connected together may lower throughput. This configuration can be susceptible to generate endless network loops in your network, so it is recommended to enable the Spanning Tree function to prevent this from happening.



WDS Station Mode

Station mode expands the WDS by receiving a wireless signal/service and sharing it through the Ethernet port.



Chapter 5

Status



Main Status

Save Changes

This page lets you save and apply the settings shown under **Unsaved changes list**, or cancel the unsaved changes and revert to the previous settings that were in effect.

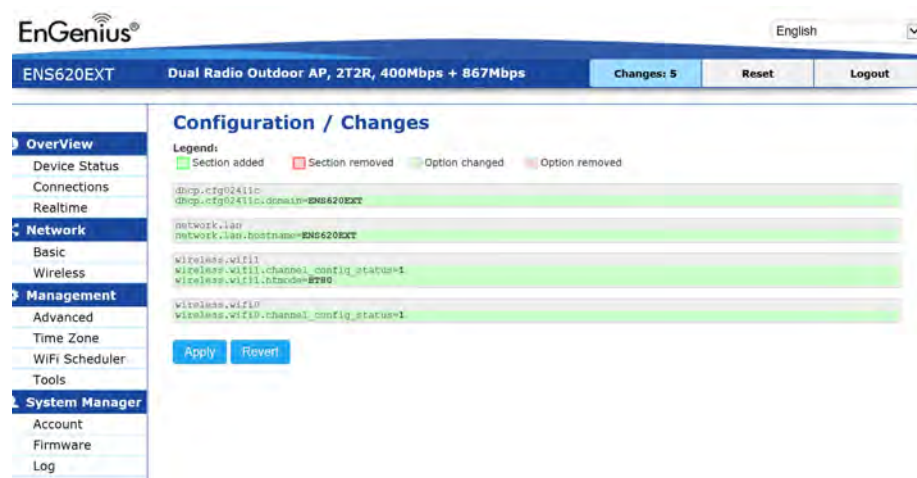

Device Status

Clicking the **Device Status** link under the **Overview** menu shows the status information about the current operating mode.

- The **Device Information** section shows general system information such as Device Name, MAC Address, Current Time, Firmware Version, and Management VLAN ID

Note: VLAN ID information is only applicable in Access Point or WDS AP mode.

Device Information

Device Name	ENS620EXT
MAC Address	
- LAN1	88:DC:96:00:00:10
- LAN2	88:DC:96:00:00:11
- Wireless LAN - 2.4GHz	88:DC:96:00:00:12
- Wireless LAN - 5GHz	88:DC:96:00:00:13
Country	USA
Current Local Time	Tue Jul 12 11:45:00 2016
Uptime	0h 4m 57s
Firmware Version	1.0.0
Management VLAN ID	Untagged

- The **Memory Information** section shows usage of memory such as Total Available, Free, Cached, Buffered

Memory Information

Total Available	128884 kB / 236336 kB (54%)
Free	95352 kB / 236336 kB (40%)
Cached	24908 kB / 236336 kB (10%)
Buffered	8624 kB / 236336 kB (3%)

- The **LAN Information** section shows the Local Area Network settings such as the LAN IP Address, Subnet mask, and DNS Address.

LAN Information - IPv4	
IP Address	192.168.1.1
Subnet Mask	255.255.255.0
Gateway	192.168.1.1
Primary DNS	0.0.0.0
Secondary DNS	0.0.0.0
DHCP Client	Disable
Spanning Tree Protocol (STP)	Disable

- The **Statistics** section shows Mac information such as SSID, MAC address, RX and TX.

Statistics				
	SSID	MAC	RX(Packets)	TX(Packets)
Ethernet		00:02:6F:FF:FF:FF	75.57KB(856 PKts.)	455.926KB(399 PKts.)
	EnGenius063C96_1-2.4GHz	88:DC:96:06:3C:96	0KB(0 PKts.)	0.792KB(4 PKts.)
	EnGenius063C97_1-5GHz	88:DC:96:06:3C:97	0KB(0 PKts.)	0KB(0 PKts.)

- The **Wireless LAN Information 5 GHz** section shows wireless information such as Operating Mode, Frequency, and Channel. Since the EnStationAC supports multiple-SSIDs, information about each SSID, the ESSID, and security settings, are displayed

Note: Profile Settings are only applicable in Access Point and WDS AP modes.

Wireless LAN Information - 5GHz					
Operation Mode	AP				
Wireless Mode	802.11 A/N				
Channel Bandwidth	40 MHz				
Channel	5.66 GHz (Channel 132)				
Distance	1000 M				
Profile	SSID	Security	VID	802.1Q	
#1	EnGenius063C97_1-5GHz	None	51	Disable	
#2	EnGenius063C97_2-5GHz	None	52	Disable	
#3	EnGenius063C97_3-5GHz	None	53	Disable	
#4	EnGenius063C97_4-5GHz	None	54	Disable	
#5	EnGenius063C97_5-5GHz	None	55	Disable	
#6	EnGenius063C97_6-5GHz	None	56	Disable	
#7	EnGenius063C97_7-5GHz	None	57	Disable	
#8	EnGenius063C97_8-5GHz	None	58	Disable	

Connection

5 GHz Connection List

Click the connection link under the Overview menu displays the connection list of clients associated to the EnStationAC's 5 GHz, along with the MAC addresses and signal strength for each client. Clicking **Refresh** updates the client list.

Note: Only applicable in Access Point and WDS AP modes.

WDS Link List

Click the connection link under the Overview menu. This page displays the current status of the WDS link, including WDS Link ID, MAC Address, Link Status and RSSI.

Note: Only applicable in WDS AP and WDS Bridge modes.

The screenshot shows the 'Connections' tab in the EnStationAC web interface. The left sidebar contains a navigation menu with 'Overview' selected. The main content area is titled 'Connection List - 5GHz' and features a table with the following data:

SSID	MAC Address	TX	RX	RSSI	Block
EnGenius3A9ADB_1-5GHz	B4:52:7E:80:C2:37	0Kb	1Kb	-80dBm	Kick

Below the table is a blue 'Refresh' button.

Realtime

Realtime

The Realtime section contains the following options:

CPU Loading: 3 minutes CPU loading percentage information, it displays current loading, average loading and peak loading status. Left bar is loading percentage; button is time tracing. Interval is every 3 seconds

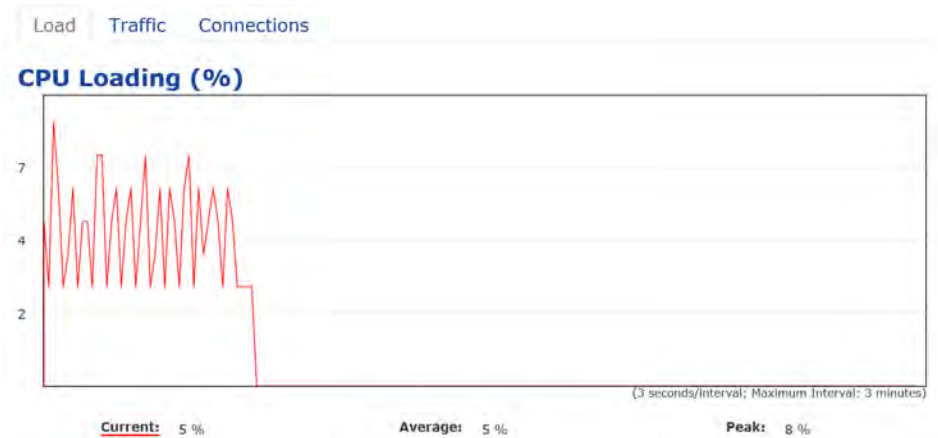

Traffic Loading: 2.4GHz and 5GHz and Ethernet port inbound and outbound traffic by current, average and peak time.

including associated SSID, BSSID, connection status, wireless mode, current channel, security, Tx Data Rate(Mbps), Current noise level and signal strength.

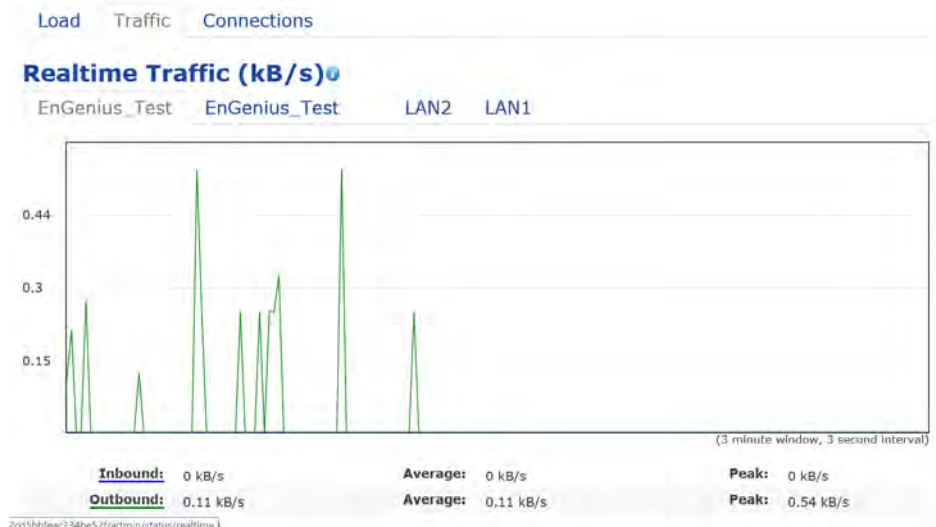

Realtime Connection (Pkts): Overview on current active network connections. It displays UDP and TCP packets information and other connection status. UDP connections curve is in blue; TCP connection curve is in green; others curve is in red. Below of chart shows connections source and destination.

Client Bridge Connection Status

Click the connection link under the Overview menu. This page displays the connection status between Access Point,

Chapter 6

Network



Basic IP Settings

IPv4/IPv6 Settings

This page allows you to modify the device's IP settings.

IPv4 Settings	
IP Network Setting	Static IP ▾
IP Address	192.168.1.1
Subnet Mask	255.255.255.0
Gateway	192.168.1.1
Primary DNS	0.0.0.0
Secondary DNS	0.0.0.0

IPv6 Settings	
	<input checked="" type="checkbox"/> Link-local Address
IP Address	
Subnet Prefix Length	
Gateway	
Primary DNS	
Secondary DNS	

IP Network Settings: Select whether the device IP address will use a static IP address specified in the IP address field or be obtained automatically when the device connects to a DHCP server.

IP Address: The IP address of this device.

Subnet Mask: The IP Subnet mask of this device.

Gateway: The Default Gateway of this device. Leave it blank if you are unsure of this setting.

Primary/Secondary DNS: The primary/secondary DNS address for this device.

Save: Click **Save** to confirm the changes.

Spanning Tree Protocol (STP) Settings

This page allows you to modify the Spanning Tree settings. Enabling the Spanning Tree protocol will prevent network loops in your LAN network.

Spanning Tree Protocol (STP) Settings		
Status	Disable ▾	
Hello Time	2	seconds (1-10)
Max Age	20	seconds (6-40)
Forward Delay	4	seconds (4-30)
Priority	32768	(0-65535)

Spanning Tree Status: Enables or disables the Spanning Tree function.

Hello Time: Specifies Bridge Hello Time in seconds. This value determines how often the device sends handshake packets to communicate information about the topology throughout the entire Bridged Local Area Network.

Max Age: Specifies Bridge Max Age in seconds. If another bridge in the spanning tree does not send a hello packet for a long period of time, it is assumed to be inactive.

Forward Delay: Specifies Bridge Forward Delay in seconds. Forwarding delay time is the time spent in each of the Listening and Learning states before the Forwarding state is entered. This delay is provided so that when a new bridge comes onto a busy network, it analyzes data traffic before participating in the network.

Priority: Specifies the Priority Number. A smaller number has a greater priority than a larger number.

Save: Click **Save** to confirm the changes.

Chapter 7

Wireless



Wireless

Wireless Settings

Wireless Settings

Device Name	<input type="text" value="ENSTATIONAC"/>
Country/Region	<input type="text" value="USA"/>

Device Name: Enter a name for the device. The name you type appears in SNMP management. This name is not the SSID and is not broadcast to other devices.

Save: Click **Save** to confirm the changes.

This page displays the current status of the Wireless settings of the EnStationAC.

Wireless Network

5GHz	
Operation Mode	Access Point <input checked="" type="checkbox"/> Green <input type="checkbox"/>
Wireless Mode	802.11 AC/N
Channel HT Mode	80MHz(AC Only)
Extension Channel	Lower Channel
Channel	Auto
Transmit Power	Auto
Data Rate	Auto
RTS / CTS Threshold (1 - 2346)	2346
Client Limit	127 <input checked="" type="radio"/> Enable <input type="radio"/> Disable
AP Detection	Scan
Distance (1-30km)	1 (0.6miles)

Operation Mode: Select **Operation Mode**. The EnStation supports multi-operation modes: Access Point, Client Bridge, or WDS(WDS AP, WDS Bridge, and WDS Station).

Wireless Mode: Supports 802.11ac/a/n mixed mode in 5 GHz.

Channel HT Mode: The default channel bandwidth is 20 MHz/ 40 /80 MHz. The larger the channel, the greater the transmission quality and speed.

Extension Channel: Select the **upper** or **lower** channel. Your selection may affect the Auto channel function.

Channel: Select the appropriate channel and frequency.

Select **Auto** to enable auto-channel selection.

Transmit Power: Sets the power output of the wireless signal.

Data Rate: Select a data rate from the drop-down list. The data rate affects throughput of data in the EnStationAC. Select the best balance for you and your network but note that the lower the data rate, the lower the throughput, though transmission distance is also lowered.

RTS/CTS Threshold: Specifies the threshold package size for RTC/CTS. A small number causes RTS/CTS packets to be sent more often and consumes more bandwidth.

Client Limits: Limits the total number of clients.

Aggregation: Merges data packets into one packet. This option reduces the number of packets, but also increases packet sizes.

AP Detection: AP Detection can select the best channel to use by scanning nearby areas for Access Points.

Distance: Specifies the distance between Access Points and clients. Note that longer distances may drop higher-speed connections.

Save: Click **Save** to confirm the changes or **Cancel** to cancel and return to previous settings.

Site Survey		I.Infrastructure				A.Ad_hoc
BSSID	SSID	Channel	Signal Level	Type	Security	Mode
00:02:6F:ED:58:90	EnGeniusED5890_1-5GHz	36	-75 dBm	11a/n	None	[--]
88:DC:96:0C:95:9A	EnGenius0C959A_1-5GHz	36	-80 dBm	11a/n	None	[--]
88:DC:96:21:FF:F5		60	-76 dBm	11a/n	None	[--]
88:DC:96:21:FF:F8		60	-84 dBm	11a/n	None	[--]
F0:B0:52:36:38:CC	FREE_WIFI	140	-84 dBm	11ac	None	[--]
00:30:AC:03:27:04	ADANT_5G_TEST	149	-82 dBm	11ac	None	[--]
DC:9F:DB:70:21:B1	UBNTguest	157	-86 dBm	11ac	None	[--]
00:02:6F:A0:42:D2	EnGeniusHome_5G	36	-66 dBm	11ac	WPA2-PSK	[--]
88:DC:96:16:A1:39	EnGenius16A139	44	-78 dBm	11a/n	WPA2-PSK	[--]
88:DC:96:33:49:F2	SNWL	60	-67 dBm	11a/n	WPA2-PSK	[--]
88:DC:96:27:C2:34	SNWL	100	-63 dBm	11ac	WPA2-PSK	[--]
88:DC:96:27:C2:37	SNWL	100	-64 dBm	11ac	WPA2-PSK	[--]
88:DC:96:3A:3C:4A	ezNU_5G_1	108	-74 dBm	11ac	WPA2-PSK	[--]
88:DC:96:3A:3C:41	ezNU_5G_1	108	-73 dBm	11ac	WPA2-PSK	[--]
88:DC:96:3A:3C:47	ezNU_5G_1	108	-77 dBm	11ac	WPA2-PSK	[--]
88:DC:96:3A:3C:50	ezNU_5G_1	108	-75 dBm	11ac	WPA2-PSK	[--]
88:DC:96:3A:3C:44	ezNU_5G_1	108	-77 dBm	11ac	WPA2-PSK	[--]
88:DC:96:17:3F:C8	ezNU_5G_1	149	-77 dBm	11a/n	WPA2-PSK	[--]
88:DC:96:23:91:0F	EPG_NTCS	149	-69 dBm	11a/n	WPA2-PSK	[--]
88:DC:96:3B:FB:AC	ezNU_5G_1	149	-79 dBm	11a/n	WPA2-PSK	[--]

SSID Profile

Wireless Settings - 5GHz

No.	Enable	SSID	Edit	Security	Suppressed SSID	Station Separation	Isolation	VID
1	<input checked="" type="checkbox"/>	EnGenius063C97_1-5GHz	<input type="button" value="Edit"/>	None	<input type="checkbox"/>	<input type="checkbox"/>	<input type="checkbox"/>	51
2	<input type="checkbox"/>	EnGenius063C97_2-5GHz	<input type="button" value="Edit"/>	None	<input type="checkbox"/>	<input type="checkbox"/>	<input type="checkbox"/>	52
3	<input type="checkbox"/>	EnGenius063C97_3-5GHz	<input type="button" value="Edit"/>	None	<input type="checkbox"/>	<input type="checkbox"/>	<input type="checkbox"/>	53
4	<input type="checkbox"/>	EnGenius063C97_4-5GHz	<input type="button" value="Edit"/>	None	<input type="checkbox"/>	<input type="checkbox"/>	<input type="checkbox"/>	54
5	<input type="checkbox"/>	EnGenius063C97_5-5GHz	<input type="button" value="Edit"/>	None	<input type="checkbox"/>	<input type="checkbox"/>	<input type="checkbox"/>	55
6	<input type="checkbox"/>	EnGenius063C97_6-5GHz	<input type="button" value="Edit"/>	None	<input type="checkbox"/>	<input type="checkbox"/>	<input type="checkbox"/>	56
7	<input type="checkbox"/>	EnGenius063C97_7-5GHz	<input type="button" value="Edit"/>	None	<input type="checkbox"/>	<input type="checkbox"/>	<input type="checkbox"/>	57
8	<input type="checkbox"/>	EnGenius063C97_8-5GHz	<input type="button" value="Edit"/>	None	<input type="checkbox"/>	<input type="checkbox"/>	<input type="checkbox"/>	58

Current Profile: You can configure up to sixteen (16) different SSIDs (eight (8) per band). If multiple client devices will be accessing the network, you can arrange the devices into SSID groups. Click **Edit** to configure the profile and check whether you want to enable extra SSID.

SSID: Specifies the SSID for the current profile.

Suppressed SSID: Check this option to hide the SSID from clients. If checked, the SSID will not appear in the site survey.

Station Separation: Click the appropriate radio button to allow or prevent communication between client devices.

VID: Specifies the VLAN tag for each profile. If your network

includes VLANs, you can specify a VLAN ID for packets pass through the Access Point with a tag.

Wireless Security: See the Wireless Security section.

VLAN Isolation: Restrict clients communicating with different VLANs by selecting the radio button.

L2 Isolation: Enable this function prevent client devices to communicate on the both WLAN and LAN.

Save: Click **Save** to accept the changes.

Wireless Security

The Wireless Security section lets you configure the EnStationAC's security modes: WEP, WPA-PSK, WPA2-PSK, WPA-PSK Mixed, WPA, WPA2, and WPA Mixed. It is strongly recommend that you use WPA2-PSK.

Wireless Security - 5GHz

Security Mode	WEP
Auth Type	Open System
Input Type	Hex
Key Length	40/64-bit (10 hex digits or 5 ASCII char)
Default Key	1
Key1	
Key2	
Key3	
Key4	

Auth Type: Select **Open System** or **Shared Key**.

Input Type:

ASCII: Regular Text (recommended)

Hexadecimal Numbers (For advanced users)

Key Length: Select the desired option and ensure that wireless clients use the same setting. Your choices are 64, 128, and 152-bit password lengths.

Default Key: Select the Key you wish to be the default. Transmitted data is **ALWAYS** encrypted using the Default Key; the other Keys are for decryption only. You must enter a Key Value for the Default Key.

Encryption Key Number: Enter the Key Value or values you wish to use. Only the Key selected as Default is required. The others are optional.

Wireless Security - 5GHz

Security Mode	WPA-PSK
Encryption	AES
Passphrase	
Group Key Update Interval	3600

*** Setting of WPA-PSK, WPA2-PSK and WPA-PSK Mixed (Pre-Shared Key):**

Encryption: You may select AES, TKIP or Both (TKIP+AES) to be the encryption type you would like. Please ensure that your wireless clients use the same settings.

Passphrase: Wireless clients must use the same Key to

associate the device. If using ASCII format, the Key must be from 8 to 63 characters in length. If using HEX format, the Key must be 64 HEX characters in length.

Group Key Update Interval: Specifies how often, in seconds, the Group Key changes. The default value is 3600.

Wireless Security - 5GHz	
Security Mode	WPA-Enterprise ▾
Encryption	AES ▾
Group Key Update Interval	3600
Radius Server	
Radius Port	1812 Default 1812
Radius Secret	
Radius Accounting	Disable ▾
Radius Accounting Server	
Radius Accounting Port	1813
Radius Accounting Secret	
Interim Accounting Interval	600

* Setting of WPA-Enterprise & WPA2-Enterprise (Pre-Shared Key):

Encryption: Select the WPA encryption type you would like. Please ensure that your wireless clients use the same settings.

Radius Server: Enter the IP address of the Radius server.

Radius Port: Enter the port number used for connections to the Radius server.

Radius Secret: Enter the secret required to connect to the Radius server.

Radius Accounting: Enable or disable accounting feature.

Radius Accounting Server: Enter the IP address of the Radius accounting server.

Radius Accounting Port Enter the port number used for connections to the Radius accounting server.

Radius Accounting Secret: Enter the secret required to connect to the Radius accounting server.

Interim Accounting Interval: Specifies how often, in seconds, the accounting data sends.

Note: 802.11n does not allow WEP/WPA-PSK TKIP/WPA2-PSK TKIP security mode. The connection mode will automatically change from 802.11n to 802.11g

Wireless MAC Filtering

Wireless MAC Filtering is used to allow or deny network access to wireless clients (computers, tablet PCs, NAS, smartphones, etc.) according to their MAC addresses. You can manually add a MAC address to restrict permission to access the EnStationAC. The default setting is: **Disable Wireless MAC Filter**.

Note: Only applicable in Access Point and WDS AP modes.

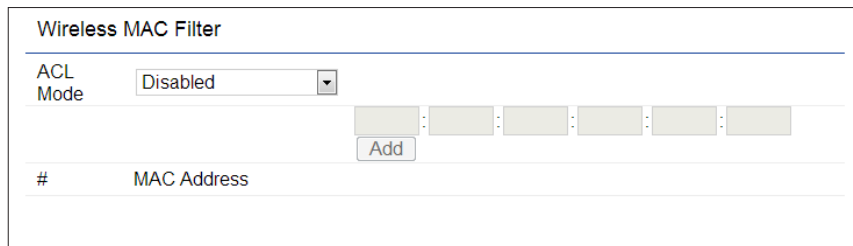

The screenshot shows the 'Wireless MAC Filter' configuration page. At the top, there is a title 'Wireless MAC Filter'. Below it, the 'ACL Mode' is set to 'Disabled' in a dropdown menu. Underneath, there is a row of six input fields for entering a MAC address, separated by dots and colons. An 'Add' button is positioned below the first input field. At the bottom, there is a table header with a '#' column and a 'MAC Address' column.

ACL Mode: Determines whether network access is granted or denied to clients whose MAC addresses appear in the MAC address table on this page. Your choices are: Disabled, Deny MAC in the list, or Allow MAC in the list.

MAC Address: Enter the MAC address of the wireless client.

Add: Click **Add** to add the MAC address to the MAC address table.

Delete: Delete the selected entries.

Save: Click **Save** to apply the changes.

Wireless Advanced

Wireless Traffic Shaping

Traffic shaping regulates the flow of packets leaving an interface to deliver improved Quality of Service. The function will allow administrators to restrict the wireless bandwidth per SSID.

Wireless Traffic Shaping	
Enable Traffic Shaping	<input type="radio"/> Enable <input checked="" type="radio"/> Disable
Download Limit	<input type="text" value="100"/> <input type="checkbox"/> Per User Mbps (1-999)
Upload Limit	<input type="text" value="100"/> <input type="checkbox"/> Per User Mbps (1-999)

Enable Traffic Shaping: Check this option to enable Wireless Traffic Shaping.

Download Limit: Specifies the wireless transmission bandwidth used for downloading.

Upload Limit: Specifies the wireless transmission bandwidth used for uploading.

Save: Click **Save** to confirm the changes.

WDS Link Settings

Using the WDS (Wireless Distribution System) feature will allow a network administrator or installer to connect to Access Points wirelessly. Doing so will extend the wired infrastructure to locations where cabling is not possible or inefficient to implement.

Note: Compatibility between different brands and models of Access Points is not guaranteed. It is recommended that the WDS network be created using the same models for maximum compatibility.

Also note: All Access Points in the WDS network need to use the same Channel and Security settings.

To create a WDS network, please enter the MAC addresses of the Access Points that you want included in the WDS. There can be a maximum of four Access Points.

Note: Only applicable in WDS AP and WDS Bridge modes.

WDS Link Settings

ID	MAC Address	Mode
1		Disable
2		Disable
3		Disable
4		Disable

Security: Select **None** or **AES** from the drop-down list.

AES Passphrase: Enter the Key Values you wish to use. Other Access Points must use the same Key to establish a WDS link.

MAC Address: Enter the Access Point's MAC address to where you want to extend the wireless area.

Mode: Select to disable or enable from the drop-down list.

Save: Click **Save** to confirm the changes.

Client Bridge/WDS Station Settings

Save: Click Save to accept the changes

Wireless Settings - 5GHz

No.	SSID	Edit	Security
AP SSID	AP SSID_5G	<input type="button" value="Edit"/>	None

No.: Display the setting value

SSID: You can click **scan** under AP detection to search perform the AP detection to select the proper SSID.

Edit: Click it to implement the advanced settings

Wireless Setting - 5GHz

Preferred BSSID

SSID

Wireless Security - 5GHz

Security Mode

Save current setting(s)

Prefer BSSID: You can insert the prefer BSSID or enter the specific SSID to be associated with the Access Point.

SSID: You can implement the AP detection to select the proper SSID.

Security Mode: Select the correct security mode and insert the correct encryption type. Please refer the wireless security section in page 42.

Guest Network Settings

Adding a guest network allows visitors to use the Internet without giving out your office or company wireless security key. You can add a guest network to each wireless network in the 5 GHz ac/a/n frequencies.

Guest Network Settings [?](#)

Enable	SSID	Edit	Security	Hidden SSID	Client Isolation
<input type="checkbox"/>	EnGenius-5GHz_GuestNetwork	Edit	None	<input type="checkbox"/>	<input checked="" type="checkbox"/>

Manual IP Settings

- IP Address	192.168.200.1
- Subnet Mask	255.255.255.0

Automatic DHCP Server Settings

- Starting IP Address	192.168.200.100
- Ending IP Address	192.168.200.200
- WINS Server IP	0.0.0.0

SSID: Specifies the SSID for the current profile.

Suppressed SSID: Check this option to hide the SSID from clients. If checked, the SSID will not appear in the site survey.

Station Separation: Click the appropriate radio button to allow or prevent communication between client devices.

IP Address: The IP Address of this device.

Subnet Mask: The IP Subnet mask of this device.

Starting IP Address: The first IP Address in the range of the addresses by the DHCP server.

Ending IP Address: The last IP Address in the range of addresses assigned by the DHCP server.

RSSI Threshold

RSSI Threshold [?](#)

Status Enable Disable

RSSI dBm (Range: -60dBm ~ -100dBm)

RSSI Threshold: Enable the Fast Handover feature by ensuring that each client is served by at least one Access Point at any time. Access Points continuously monitor the connectivity quality of any client in their range and efficiently share this information with other Access Points in the vicinity of that client to coordinate which of them should serve the client best.

RSSI: Enter the RSSI (Received Signal Strength Index) in order to determine the handover procedure which the current wireless link will terminate. RSSI is an indication of the power level being received by the antenna. Therefore, the higher the RSSI number, the stronger the signal.

Chapter 8

Management



Management VLAN Settings

This page allows you to assign a VLAN tag to packets sent over the network. A VLAN is a group of computers on a network whose software has been configured so that they behave as if they were on a separate Local Area Network (LAN). Computers on VLAN do not have to be physically located next to one another on the LAN.

Note: Only applicable in Access Point and WDS AP modes.

Management VLAN Settings	
CAUTION: If you reconfigure the Management VLAN ID, you may lose connectivity to the access point. Verify that the switch and DHCP server can support the reconfigured VLAN ID, and then re-connect to the new IP address.	
Management VLAN	Enable <input type="checkbox"/> 4096

Management VLAN: If your network includes VLANs, you can enable **Management VLAN ID** for packets passing through the Access Point with a tag.

Save: Click **Save** to confirm the changes or **Cancel** to cancel and return to previous settings.

Note: If you reconfigure the Management VLAN ID, you may lose your connection to the EnStationAC. Verify that the DHCP server supports the reconfigured VLAN ID and then reconnect to the EnStationAC using the new IP address.

Advanced Settings

SNMP Settings

This page allows you to assign the Contact Details, Location, Community Name, and Trap Settings for a Simple Network Management Protocol (SNMP). SNMP is a networking management protocol used to monitor network attached devices. SNMP allows messages (called protocol data units) to be sent to various parts of the network. Upon receiving these messages, SNMP compatible devices (called agents) returns the data stored in their Management Information Bases.

SNMP Settings	
Status	Enable
Contact	
Location	
Port	161
Community Name (Read Only)	public
Community Name (Read Write)	private
Trap Destination	
- Port	162
- IP Address	
- Community Name	public
SNMPv3 Settings	
- Status	Enable
- Username	admin (1-31 Characters)
- Authorized Protocol	MD5
- Authorized Key	12345678 (8-32 Characters)
- Private Protocol	DES
- Private Key	12345678 (8-32 Characters)
- Engine ID	

SNMP Enable/Disable: Enables or disables the SNMP feature.

Contact: Specifies the contact details of the device.

Location: Specifies the location of the device.

Community Name (Read Only): Specifies the password for the SNMP community for read only access.

Community Name (Read/Write): Specifies the password for the SNMP community with read/write access.

Trap Destination Address: Specifies the IP address of the computer that will receive the SNMP traps.

Trap Destination Community Name: Specifies the password for the SNMP trap community.

SNMPv3: Enables or disables the SNMPv3 feature.

User Name: Specifies the username for SNMPv3.

Auth Protocol: Selects the authentication protocol type: MDS or SHA.

Auth Key: Specifies the authentication key.

Priv Protocol: Selects the privacy protocol type: DES.

Priv Key: Specifies the privacy key for privacy.

Engine ID: Specifies the engine ID for SNMPv3.

Apply Save: Click **Apply Save** to apply the changes.

CLI Settings

CLI Setting	
CLI	Enable ▾
SSH Setting	
SSH	Disable ▾
HTTPS Setting	
HTTPS	Enable ▾
HTTPS forward	Disable ▾

CLI: The Command Line Interface (CLI) allows you to type commands instead of choosing them from a menu or selecting an icon.

SSH: Enable Secure Shell (SSH) to make secure, encrypted connections in the network. Secure Shell is a network protocol that allows data to be exchanged using a secure channel between two network devices.

HTTPS: Enable HTTPS to transfer and display web content securely. The Hypertext Transfer Protocol over SSL (Secure Socket Layer) is a TCP/IP protocol used by web servers to transfer and display web content securely.

Email Alert

You can use the Email Alert feature to send messages to the configured email address when particular system events occur.

Note: Do **NOT** use your personal email address as it can unnecessarily expose your personal email login credentials. Use a separate email account made for this feature instead

Email Alert	
Status	<input checked="" type="checkbox"/> Enable
- From	<input type="text"/>
- To	<input type="text"/>
- Subject	[Email-Alert][ENH900EXT][00.02.6F:FF:FF:FF] Config
Email Account	
- Username	<input type="text"/>
- Password	<input type="password"/>
- SMTP Server	<input type="text"/> Port: 25
- Security Mode	None ▾ <input type="button" value="Send Test Mail"/>

From: Enter the email address to show the sender of the email.

To: Enter the address that you wish to send emails to.

Subject: Enter the text that you wish to appear in the email's subject line.

Username: Enter the username for the email account that will be used to send emails.

Password: Enter the password for the email account that will be used to send emails.

SMTP Server: Enter the IP address or hostname of the outgoing SMTP server.

Port: Enter the SMTP port number to use for outbound emails.

Time Zone

Time Setting

This page allows you to set the internal clock of the EnStationAC.

Start: Select the day, month, and time when daylight savings time starts.

End: Select the day, month, and time when daylight savings times ends.

Date and Time Settings

Manually Set Date and Time

Date: 2013 / 09 / 25

Time: 08 : 10 (24-Hour)

Automatically Get Date and Time

NTP Server: 209.81.9.7

Time Zone

Time Zone: UTC+00:00 Gambia, Liberia, Morocco

Enable Daylight Saving

Start: January 1st Sun 12 am

End: January 1st Mon 12 am

Manually Set Date and Time: Manually specify the date and time.

Automatically Get Date and Time: Select and check whether you wish to enter the IP address of an NTP server or use the default NTP server to have the internal clock set automatically.

Enable Daylight Saving: Check whether daylight savings applies to your area.

Auto Reboot Settings

You can specify how often you wish to reboot the EnStationAC.

Auto Reboot Setting	
Auto Reboot Status	<input type="button" value="Disable"/>
Timer	<input type="checkbox"/> Sunday <input type="checkbox"/> Monday <input type="checkbox"/> Tuesday <input type="checkbox"/> Wednesday <input type="checkbox"/> Thursday <input type="checkbox"/> Friday <input type="checkbox"/> Saturday
	0 : 0

Auto Reboot Setting: Enables or disables the Auto Reboot function.

Frequency of Auto Reboot: Specifies how often you wish to reboot the EnStationAC by Min, Hour, Day or Week.

Timer: Select the day and enter the time you would like to reboot automatically.

Save: Click **Save** to apply the changes.

Wi-Fi Scheduler

The Wi-Fi Scheduler can be created for use in enforcing rules. For example, if you wish to restrict web access to Mon-Fri from 3pm to 8pm, you could create a schedule selecting Mon, Tue, Wed, Thu and Fri while entering a Start time of 3pm and End Time of 8pm to limit access to these times.

Day	Availability	Duration
Sunday	available ▾	00 : 00 ~ 24 : 00
Monday	available ▾	00 : 00 ~ 24 : 00
Tuesday	available ▾	00 : 00 ~ 24 : 00
Wednesday	available ▾	00 : 00 ~ 24 : 00
Thursday	available ▾	00 : 00 ~ 24 : 00
Friday	available ▾	00 : 00 ~ 24 : 00
Saturday	available ▾	00 : 00 ~ 24 : 00

Status: Enables or disables the Wi-Fi scheduler function.

Wireless Radio: Select 2.4 GHz or 5 GHz from the drop-down list for the preferred band type.

SSID Selection: Select a SSID from the drop-down list.

Schedule Templates: Select a schedule template from the

drop-down list.

Day(s): Place a checkmark in the boxes for the desired days or select the **All Week** radio button to select all seven days of the week.

Duration: The Start Time is entered in two fields. The first box is for hours and the second box is for minutes. The End Time is entered in the same format as the Start time.

Tools

Ping Test Parameters

This page allows you to analyze the connection quality of the EnStationAC and trace the routing table to a target in the network.

Ping Test Parameters	
Target IP / Domain Name	<input type="text"/>
Ping Packet Size	<input type="text" value="64"/> Bytes
Number of Pings	<input type="text" value="4"/>
<input type="button" value="Start"/>	

Target IP: Enter the IP address you would like to search.

Ping Packet Size: Enter the packet size of each ping.

Number of Pings: Enter the number of times you wish to ping.

Traceroute Test Parameter

Traceroute Test Parameters	
Target IP / Domain Name	<input type="text"/>
<input type="button" value="Start"/> <input type="button" value="Stop"/>	

Target IP: Enter the IP address you would like to trace

Speed Test Parameters

Speed Test Parameters	
Target IP / Domain Name	<input type="text"/>
Time Period	<input type="text" value="20"/> sec
Check Interval	<input type="text" value="5"/> sec
<input type="button" value="Start"/>	
IPv4 Port	5001
IPv6 Port	5002

Target IP: Enter the IP address you would like to test.

Start Ping: Click **Start Ping** to begin pinging the target device (via IP).

Traceroute Target: Enter the IP address or domain name you wish to trace.

Start Traceroute: Click **Start Traceroute** to begin the trace route operation.

Device Discovery

This page allows you to discover devices from network for Operation Mode, IP Address, System MAC Address and Firmware version.

Device Discovery				
Device Name	Operation Mode	IP Address	System MAC Address	Firmware Version
<input type="button" value="Scan"/>				

Account

This page allows you to change the EnStationAC username and password. By default, the username is: **admin** and the password is: **admin**. The password can contain from 0 to 12 alphanumeric characters and is case sensitive.

Account Settings

Account Settings

Administrator Username	admin
Current Password	
New Password	
Verify Password	

Apply saved settings to take effect

Administrator Username: Enter a new username for logging in to the New Name entry box.

Current Password: Enter the old password for logging in to the Old Password entry box.

New Password: Enter the new password for logging in to the New Password entry box.

Verify Password: Re-enter the new password in the Confirm Password entry box for confirmation.

Apply: Click **Apply** to apply the changes.

Firmware

Firmware Upgrade

This page allows you to upgrade the firmware of the EnStationAC.

Firmware Upgrade

Current Firmware Version: 2.0.0

Select the new firmware from your hard disk.

No file selected.

To Perform the Firmware Upgrade:

1. Click the **Choose File** button and navigate the OS file system to the location of the upgrade file.
2. Select the upgrade file. The name of the file will appear in the Upgrade File field.
3. Click the **Upload** button to commence the firmware upgrade.

Note: The device is unavailable during the Firmware upgrade process and must restart when the upgrade is completed. Any connections to or through the device will be lost.

Backup/Restore

Backup/Restore

This page allows you to save the current device configurations. When you save your configurations, you also can reload the saved configurations into the device through the Restore Saved Settings from a file section. If extreme problems occur, or if you have set the AP incorrectly, you can use the **Reset** button in the Revert to Factory Default Settings section to restore all the configurations of the AP to the original default settings.

Backup Setting: Click **Export** to save the current configured settings.

Restore New Setting: To restore settings that have been previously backed up, click **Browse**, select the file, and click **Restore**.

Restore to Default: Click **Reset** button to restore the AP to its factory default settings.

Backup/Restore Settings

Factory Setting

- Backup Setting ⓘ

Export

- Restore New Setting

選擇檔案 未選擇任何檔案

Import

- Reset to Default ⓘ

Reset

User Setting

- Back Up Setting as Default

Backup

- Restore to User Default ⓘ

Restore

- **Caution:** Please write down your account number and password before saving. The user settings will now become the new default settings at the next successful login.

User Setting

The function allows you to backup the current device configurations into the EnStationAC as the default value. If extreme problems occur, or if you have set the EnStationAC incorrectly, you can push the Reset button to revert all the configurations of the EnStationAC to the user default.

Back Up Setting as Default: Click **Backup** to backup the user settings you would like to the device's memory for the default settings.

Restore to User Default: Click **Restore** to restore user settings to the factory standard settings.

Note1: After setting the current settings as the default, you should click the **Restore to Default** on the web interface for reverting the settings into the factory default instead of pushing the reset button.

Note2: Please **write down** your account and password before saving. The user settings will now become the new default settings at the next successful login.

Log

System Log

The EnStationAC automatically logs (records) events of possible interest in its internal memory. To view the logged information, click the **Log** link under the System Manager menu. If there is not enough internal memory to log all events, older events are deleted from the log. When powered down or rebooted, the log will be cleared.

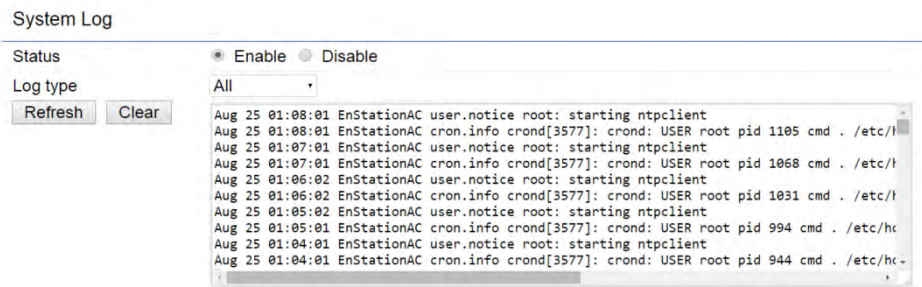

Remote Log

This page allows you to setup the Remote Log functions for the EnStationAC.

The screenshot shows the 'Remote Log' configuration form. It has two fields: 'Remote Log' with a dropdown menu set to 'Disable', and 'Log Server IP Address' with a text input field containing '0.0.0.0'.

Syslog: Enables or disables the syslog function.

Log Server IP Address: Enter the IP address of the log server.

Remote Log: Enable or disable the remote log service.

Apply: Click **Apply** to apply the changes.

Logout

Click **Logout** in Management menu to logout.

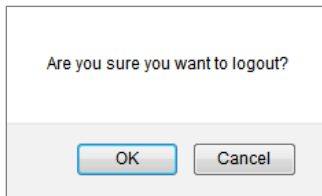
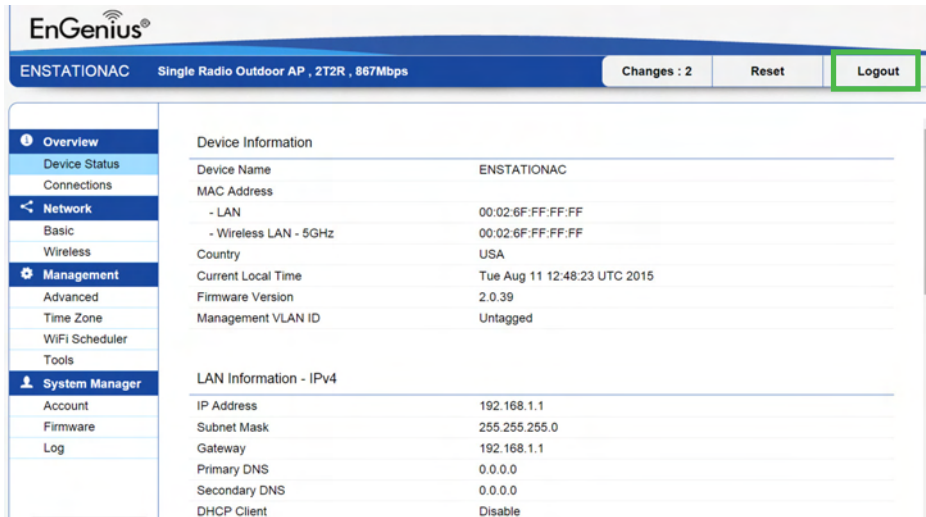

Reset

In some circumstances, it may be required to force the device to reboot. Click on **Reset** to reboot or to reset the EnStationAC.

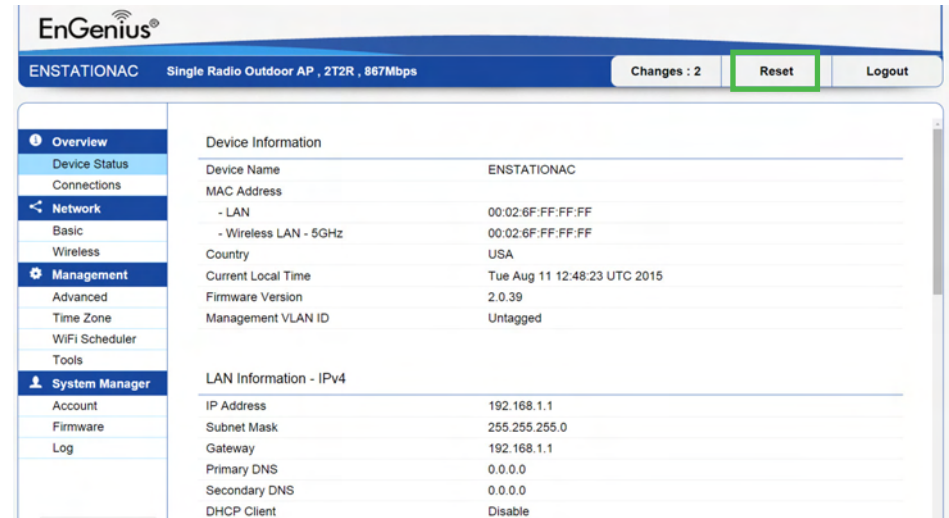

Reboot the Device

CAUTION: The device will be rebooted when pressing this button.

Reboot the Device

Restore the device to default settings

CAUTION: All settings will be cleared and reset to either factory default or user default.

Restore to Factory Defaults

Restore to User Default

Appendix



Appendix A

Federal Communication Commission Interference Statement

This device complies with Part 15 of the FCC Rules. Operation is subject to the following two conditions: (1) This device may not cause harmful interference, and (2) this device must accept any interference received, including interference that may cause undesired operation.

This equipment has been tested and found to comply with the limits for a Class B digital device, pursuant to Part 15 of the FCC Rules. These limits are designed to provide reasonable protection against harmful interference in a residential installation. This equipment generates, uses and can radiate radio frequency energy and, if not installed and used in accordance with the instructions, may cause harmful interference to radio communications. However, there is no guarantee that interference will not occur in a particular installation. If this equipment does cause harmful interference to radio or television reception, which can be determined by turning the equipment off and on, the user is encouraged to try to correct the interference by one of the following measures:

- Reorient or relocate the receiving antenna.
- Increase the separation between the equipment and receiver.
- Connect the equipment into an outlet on a circuit different from that to which the receiver is connected.
- Consult the dealer or an experienced radio/TV technician for help



FCC Caution:

Any changes or modifications not expressly approved by the party responsible for compliance could void the user's authority to operate this equipment.

This transmitter must not be co-located or operating in conjunction with any other antenna or transmitter.

IMPORTANT NOTE: Radiation Exposure Statement

EnStationAC: This equipment complies with FCC radiation exposure limits set forth for an uncontrolled environment. This equipment should be installed and operated with minimum distance 26 cm between the radiator & your body.

EnStation5-AC: This equipment complies with FCC radiation exposure limits set forth for an uncontrolled environment. This equipment should be installed and operated with minimum distance 25 cm between the radiator & your body.

Appendix B - CE Interference Statement

Europe - EU Declaration of Conformity

This device complies with the essential requirements of the R&TTE Directive 1999/5/EC. The following test methods have been applied in order to prove presumption of conformity with the essential requirements of the R&TTE Directive 1999/5/EC:

- **EN60950-1**
Safety of Information Technology Equipment
- **EN50385**
Generic standard to demonstrate the compliance of electronic and electrical apparatus with the basic restrictions related to human exposure to electromagnetic fields (0 Hz - 300 GHz)
- **EN 300 328**
Electromagnetic compatibility and Radio spectrum Matters (ERM); Wideband Transmission systems; Data transmission equipment operating in the 2,4 GHz ISM band and using spread spectrum modulation techniques; Harmonized EN covering essential requirements under article 3.2 of the R&TTE Directive
- **EN 301 893**
Broadband Radio Access Networks (BRAN); 5 GHz high performance RLAN; Harmonized EN covering essential requirements of article 3.2 of the R&TTE Directive
- **EN 301 489-1**
Electromagnetic compatibility and Radio Spectrum Matters (ERM); ElectroMagnetic Compatibility (EMC) standard for radio equipment and services; Part 1: Common technical requirements
- **EN 301 489-17**
Electromagnetic compatibility and Radio spectrum Matters (ERM); ElectroMagnetic Compatibility (EMC) standard for radio equipment and services; Part 17: Specific conditions for 2,4 GHz wideband transmission systems and 5 GHz high performance RLAN equipment

This device is a 5GHz wideband transmission system (transceiver), intended for use in all EU member states and EFTA countries, except in France and Italy where restrictive use applies.

In Italy the end-user should apply for a license at the national spectrum authorities in order to obtain authorization to use the device for setting up outdoor radio links and/or for supplying public access to telecommunications and/or network services.

This device may not be used for setting up outdoor radio links in France and in some areas the RF output power may be limited to 10 mW EIRP in the frequency range of 2454 – 2483.5 MHz. For detailed information the end-user should contact the national spectrum authority in France.

CE 0560

Česky [Czech]	[Jméno výrobce] tímto prohlašuje, že tento [typ zařízení] je ve shodě se základními požadavky a dalšími příslušnými ustanoveními směrnice 1999/5/ES.
Dansk [Danish]	Undertegnede [fabrikantens navn] erklærer herved, at følgende udstyr [udstyrets typebetegnelse] overholder de væsentlige krav og øvrige relevante krav i direktiv 1999/5/EF.
Deutsch [German]	Hiermit erkläre [Name des Herstellers], dass sich das Gerät [Gerätetyp] in Übereinstimmung mit den grundlegenden Anforderungen und den übrigen einschlägigen Bestimmungen der Richtlinie 1999/5/EG befindet.
Eesti [Estonian]	Käesolevaga kinnitab [tootja nimi = name of manufacturer] seadme [seadme tüüp = type of equipment] vastavust direktiivi 1999/5/EÜ põhinõuetele ja nimetatud direktiivist tulenevatele teistele asjakohastele sätetele.
English	Hereby, [name of manufacturer], declares that this [type of equipment] is in compliance with the essential requirements and other relevant provisions of Directive 1999/5/EC.
Español [Spanish]	Por medio de la presente [nombre del fabricante] declara que el [clase de equipo] cumple con los requisitos esenciales y cualesquiera otras disposiciones aplicables o exigibles de la Directiva 1999/5/CE.
Ελληνική [Greek]	ΜΕ ΤΗΝ ΠΑΡΟΥΣΑ [name of manufacturer] ΔΗΛΩΝΕΙ ΟΤΙ [type of equipment] ΣΥΜΜΟΡΦΩΝΕΤΑΙ ΠΡΟΣ ΤΙΣ ΟΥΣΙΩΔΕΙΣ ΑΠΑΙΤΗΣΕΙΣ ΚΑΙ ΤΙΣ ΛΟΙΠΕΣ ΣΧΕΤΙΚΕΣ ΔΙΑΤΑΞΕΙΣ ΤΗΣ ΟΔΗΓΙΑΣ 1999/5/ΕΚ.

Français [French]	Par la présente [nom du fabricant] déclare que l'appareil [type d'appareil] est conforme aux exigences essentielles et aux autres dispositions pertinentes de la directive 1999/5/CE.
Italiano [Italian]	Con la presente [nome del costruttore] dichiara che questo [tipo di apparecchio] è conforme ai requisiti essenziali ed alle altre disposizioni pertinenti stabilite dalla direttiva 1999/5/CE.
Latviski [Latvian]	Ar šo [name of manufacturer / izgatavotāja nosaukums] deklarē, ka [type of equipment / iekārtas tips] atbilst Direktīvas 1999/ 5/EK būtiskajām prasībām un citiem ar to saistītajiem noteikumiem.
Lietuvių [Lithuanian]	Šiuo [manufacturer name] deklaruoja, kad šis [equipment type] atitinka esminius reikalavimus ir kitas 1999/5/EB Direktyvos nuostatas.
Nederlands [Dutch]	Hierbij verklaart [naam van de fabrikant] dat het toestel [type van toestel] in overeenstemming is met de essentiële eisen en de andere relevante bepalingen van richtlijn 1999/5/EG.
Malti [Maltese]	Hawnhekk, [isem tal-manifattur], jiddikjara li dan [il-mudal tal-prodott] jikkonforma mal-ħtiġijiet essenzjali u ma provvedimenti oħrajn relevanti li hemm fid-Dirrettiva 1999/5/EC.
Magyar [Hungarian]	Alulírott, [gyártó neve] nyilatkozom, hogy a [... típus] megfelel a vonatkozó alapvető követelményeknek és az 1999/5/EC irányelv egyéb előírásainak.
Polski [Polish]	Niniejszym [nazwa producenta] oświadczam, że [nazwa wyrobu] jest zgodny z zasadniczymi wymogami oraz pozostałymi stosownymi postanowieniami Dyrektywy 1999/5/EC.
Português [Portuguese]	[Nome do fabricante] declara que este [tipo de equipamento] está conforme com os requisitos essenciais e outras disposições da Directiva 1999/5/CE.
Slovensko [Slovenian]	[Ime proizvajalca] izjavlja, da je ta [tip opreme] v skladu z bistvenimi zahtevami in ostalimi relevantnimi določili direktive 1999/5/ES.
Slovensky [Slovak]	[Meno výrobcu] týmto vyhlasuje, že [typ zariadenia] spĺňa základné požiadavky a všetky príslušné ustanovenia Smernice 1999/5/ES.
Suomi [Finnish]	[Valmistaja = manufacturer] vakuuttaa täten että [type of equipment = laitteen tyyppimerkintä] tyyppinen laite on direktiivin 1999/5/EY oleellisten vaatimusten ja sitä koskevien direktiivin muiden ehtojen mukainen.

Svenska [Swedish]	<p>Härmed intygar [företag] att denna [utrustningstyp] står i överensstämmelse med de väsentliga egenskapskrav och övriga relevanta bestämmelser som framgår av direktiv 1999/5/EG. This equipment has been tested and found to comply with the limits for a Class B digital device, pursuant to Part 15 of the FCC Rules. These limits are designed to provide reasonable protection against harmful interference in a residential installation. This equipment generates, uses and can radiate radio frequency energy and, if not installed and used in accordance with the instructions, may cause harmful interference to radio communications. However, there is no guarantee that interference will not occur in a particular installation. If this equipment does cause harmful interference to radio or television reception, which can be determined by turning the equipment off and on, the user is encouraged to try to correct the interference by one of the following measures:</p>
-------------------	--

Appendix C - Professional Installation Instruction

Installation Personal

This product is designed for specific application and needs to be installed by a qualified personal who has RF and related rule knowledge. The general user shall not attempt to install or change the setting.

Installation Location

The product shall be installed at a location where the radiating antenna can be kept 25cm from nearby person in normal operation condition to meet regulatory RF exposure requirement.

Internal Antenna

Use only the antennas which have been approved by the applicant. The non-approved antenna(s) may produce unwanted spurious or excessive RF transmitting power which may lead to the violation of FCC limit and is prohibited.

Installation Procedure

Please refer to user's manual for the detail.



Warning:

Please carefully select the installation position and make sure that the final output power does not exceed the limit set force in relevant rules. The violation of the rule could lead to serious federal penalty.