

User Manual



**ENS500-AC/ENS500EXT-AC/
ENS610EXT/ENS620EXT**
version 1.1

11AC Wave2 Outdoor Access Point / CPE

IMPORTANT

To install this Access Point please refer to the **Quick Installation Guide** included in the product packaging.

Table of Contents

| | | | |
|---|-----------|--|-----------|
| Chapter 1 Product Overview..... | 4 | Wireless Security..... | 51 |
| Introduction..... | 5 | Wireless MAC Filtering..... | 54 |
| Technical Specifications..... | 8 | Wireless Advanced..... | 55 |
| Physical Interface..... | 16 | Fast Roaming..... | 56 |
| Chapter 2 Before You Begin..... | 19 | WDS Link Settings..... | 57 |
| Computer Settings..... | 20 | Guest Network Settings..... | 58 |
| Hardware Installation..... | 24 | Chapter 8 Management | 58 |
| Mounting the AP..... | 25 | Management VLAN Settings..... | 60 |
| Install Ground cable..... | 28 | Advanced Settings..... | 61 |
| Chapter 3 Configuring Your Access Point..... | 29 | Time Zone..... | 64 |
| Default Settings./Web Configuration..... | 30 | Auto Reboot Settings..... | 65 |
| Chapter 4 Building a Wireless Network..... | 31 | Wi-Fi Scheduler..... | 66 |
| Access Point Mode..... | 32 | Tools..... | 67 |
| Client Bridge Mode..... | 33 | Account/Firmware..... | 70 |
| WDS AP Mode..... | 35 | Backup/Restore | 71 |
| WDS Bridge Mode..... | 36 | Log..... | 73 |
| WDS Station Mode..... | 37 | Logout/Reset..... | 74 |
| Chapter 5 Status..... | 38 | Appendix..... | 75 |
| Overview..... | 39 | FCC Interference Statement..... | 76 |
| Connection..... | 41 | CE Interference Statement..... | 77 |
| Realtime..... | 41 | Professional Installation Instruction..... | 80 |
| Chapter 6 Network | 43 | | |
| Basic IPv4/IPv6 Settings..... | 44 | | |
| Spanning Tree Protocol Setting..... | 44 | | |
| Chapter 7 2.4 GHz/5 GHz Wireless..... | 46 | | |
| WirelessSettings..... | 47 | | |
| 2.4 GHz/5 GHz Wireless Network..... | 48 | | |
| 2.4GHz/5 GHz SSID Profile..... | 50 | | |

Chapter 1

Product Overview



Introduction

Key Features - ENS620EXT

- Up to 26 dBm transmit power enabling long range connectivity
- Supports IEEE802.11ac wave2/ac/a/b/g/n wireless standards with up to 400 Mbps data rate on 2.4GHz band and 867Mbps on 5GHz band
- Support Wave 2 MU-MIMO function on 5GHz radio.
- Support Tx Beamforming to enlarge the transmitting distance.
- Perform 256-QAM to enhance air performance up to 400Mbps under the 2.4GHz radio
- Two detachable 5 dBi 2.4 GHz Omni-directional antennas
- Two detachable 5 dBi 5 GHz Omni-directional antennas
- Proprietary 24V Input design with Gigabits port supports.
- Flexible application by the built-in 2nd LAN port.
- More customized items on Band Steering for intelligent Management.
- Traffic Shaping to control bandwidth per SSID/user
- Secured Guest Network option available

The AP is 802.11 ac wave2/a/b/g/n Outdoor Access Point with speeds up to 400 Mbps on 2.4GHz and 867Mbps on 5GHz band. It can be configured as an Access Point, Client Bridge, or WDS (AP, Station & Bridge). The AP is an affordable solution which is built in high-powered radios and long-range settings to replace the ordinary Access



Points that do not have the range and reach to connect to a growing number of wireless users. With Wave2 features, the Access Point could reduce the handling period on client devices and network with more client devices at the same time. Meanwhile, the beamforming will gather energy to a specific direction and increase the transmitting distance.

Key Features - ENS500-AC/ENS500EXT-AC

- Up to 23 dBm transmit power enabling long range connectivity
- Supports IEEE802.11 ac wave2/ac/n wireless standards with up to 867Mbps on 5GHz band
- ENS500EXT-AC ANT: Two detachable 5 dBi 5 GHz Omni-directional antennas
- ENS500-AC ANT: 14dBi 5GHzdirectional antennas
- Support Wave 2 MU-MIMO function on 5GHz radio.
- Support Tx Beamforming to enlarge the transmitting distance.
- Proprietary 24V Input design with Gigabits port supports.
- Flexible application by the built-in 2nd LAN port.
- Traffic Shaping to control bandwidth per SSID/user
- Secured Guest Network option available

The AP is 802.11 ac wave2/ac/a/n Outdoor Access Point with speeds up to 867Mbps on 5GHz band. It can be configured as an Access Point, Client Bridge, or WDS (AP, Station & Bridge). The AP is an affordable solution which is built in high-powered radios and long-range settings



to replace the ordinary Access Points that do not have the range and reach to connect to a growing number of wireless users. With Wave2 features, the Access Point could reduce the handling period on client devices and network with more client devices at the same time. Meanwhile, the beamforming features will gather energy to a specific direction and increase the transmitting distance.

Maximum data rates are based on IEEE 802.11 standards. Actual throughput and range may vary depending on many factors including environmental conditions, distance between devices, radio interference in the operating environment, and mix of devices in the network. Features and specifications subject to change without notice. Trademarks and registered trademarks are the property of their respective owners. For United States of America: Copyright © 2017 EnGenius Technologies, Inc. All rights reserved.

System Requirements

The following are the Minimum System Requirements in order to configure the device.

- Computer with an Ethernet interface or wireless network capability
- Windows OS (XP, Vista, 7, 8, 10), Mac OS, or Linux-based operating systems
- Web-Browsing Application (i.e.: Edge, Internet Explorer, Firefox, Safari, or another similar browser application)

Package Contents

The ENS620EXT package contains the following items:*

- Access Point
- 2 detachable 5 dBi 2.4 GHz Omni-directional Antennas
- 2 detachable 5 dBi 5 GHz Omni-directional Antennas
- PoE Adapter(EPA2410GP)
- 3-pin IEC 320-C6 Power Cord
- Pole Mount Ring x 1
- Wall Mount Screw Set
- Quick Installation Guide

*(all items must be in package to issue a refund):

The ENS500-AC package contains the following items:*

- Access Point
- PoE Adapter(EPA2406GP)
- 3-pin IEC 320-C6 Power Cord
- Pole Mount Ring x 1
- Wall Mount Screw Set
- Quick Installation Guide

*(all items must be in package to issue a refund):

The ENS500EXT-AC package contains the following items:*

- Access Point
- 2 detachable 5 dBi 5 GHz Omni-directional Antennas
- PoE Adapter(EPA2406GP)
- 3-pin IEC 320-C6 Power Cord
- Pole Mount Ring x 1
- Wall Mount Screw Set
- Quick Installation Guide

*(all items must be in package to issue a refund):

Technical Specifications

ENS620EXT

Standard:

IEEE802.11 ac wave2/ac/a/n on 5 GHz

IEEE802.11 b/g/n on 2.4 GHz

Antenna

2 x detachable 5 dBi 2.4 GHz Omni-directional Antennas

2 x detachable 5 dBi 5 GHz Omni-directional Antennas

Physical Interface

2 x 10/100/1000 Gigabit Ethernet Ports with PoE support

LAN1 Port: Proprietary 24V Input

LAN2 Port: Data Transmission

LED Indicator

Power

LAN 1

LAN 2

2.4 GHz

5 GHz

Power Requirements

Proprietary 24V Power over Ethernet (PoE),

Use included EPA2410GP only

Operation Modes

Access Point

WDS

Client Bridge

WDS Detail

WDS AP

WDS Bridge

WDS Station

Management

Auto Channel Selection

Multiple SSID: 16 SSIDs, 8 SSIDs per Radio

BSSID

SNMP V1/V2c/V3

MIB I/II, Private MIB

VLAN Tag/VLAN Pass-through

Clients Statistics

Save Configuration as User Default

Fast Roaming

E-Mail Alert

RADIUS Accounting

Guest Network

Traffic Shaping per SSID/user

Control

CLI Supported

Distance Control (Ack Timeout)

802.1X Supplicant (CB Mode)

Multicast Supported

Auto Reboot

Obey Regulatory Power

Security

WEP Encryption - 64/128/152 bit

WPA/WPA2 Personal (WPA-PSK using TKIP or AES)

WPA/WPA2 Enterprise (WPA-PSK using TKIP or AES)

Hides SSID in beacons

MAC address filtering, up to 32 MACs per SSID

Wireless STA (Client) connection list

Https Support

SSH Support

QoS (Quality of Service)

Compliant with IEEE 802.11e standard

Physical/Environment Conditions

Operating:

Temperature: -20 °C to 60 °C (-4 °F to 140 °F)

Humidity (non-condensing): 90% or less

Storage:

Temperature: -30 °C to 80 °C (-22 °F to 176 °F)

Humidity (non-condensing): 90% or less

ENS610EXT

Standard:

IEEE802.11 ac wave2/ac/a/n on 5 GHz

IEEE802.11 b/g/n on 2.4 GHz

Antenna

2 x detachable 5 dBi 2.4 GHz Omni-directional Antennas

2 x detachable 5 dBi 5 GHz Omni-directional Antennas

Physical Interface

2 x 10/100/1000 Gigabit Ethernet Ports with PoE support

LAN1 Port: Proprietary 24V Input

LAN2 Port: Data Transmission

LED Indicator

Power

LAN 1

LAN 2

2.4 GHz

5 GHz

Power Requirements

Proprietary 24V Power over Ethernet (PoE),

Use included EPA2406GP only

Operation Modes

Access Point

WDS

Client Bridge

WDS Detail

WDS AP

WDS Bridge

WDS Station

Management

Auto Channel Selection

Multiple SSID: 16 SSIDs, 8 SSIDs per Radio

BSSID

SNMP V1/V2c/V3

MIB I/II, Private MIB

VLAN Tag/VLAN Pass-through

Clients Statistics

Save Configuration as User Default

Fast Roaming

E-Mail Alert

RADIUS Accounting

Guest Network

Traffic Shaping per SSID/user

Control

CLI Supported

Distance Control (Ack Timeout)

802.1X Supplicant (CB Mode)

Multicast Supported

Auto Reboot

Obey Regulatory Power

Security

WEP Encryption - 64/128/152 bit

WPA/WPA2 Personal (WPA-PSK using TKIP or AES)

WPA/WPA2 Enterprise (WPA-PSK using TKIP or AES)

Hides SSID in beacons

MAC address filtering, up to 32 MACs per SSID

Wireless STA (Client) connection list

Https Support

SSH Support

QoS (Quality of Service)

Compliant with IEEE 802.11e standard

Physical/Environment Conditions

Operating:

Temperature: -20 °C to 60 °C (-4 °F to 140 °F)

Humidity (non-condensing): 90% or less

Storage:

Temperature: -30 °C to 80 °C (-22 °F to 176 °F)

Humidity (non-condensing): 90% or less

ENS500-AC

Standard:

IEEE802.11 ac wave2/ac/a/n on 5 GHz

Antenna

Internal 14dBi high gain directional antenna

Physical Interface

2 x 10/100/1000 Gigabit Ethernet Ports with PoE support

LAN1 Port: Proprietary 24V Input

LAN2 Port: Data Transmission

LED Indicator

Power

LAN 1

LAN 2

WLAN

Weak

Normal

Strong

Power Requirements

Proprietary 24V Power over Ethernet (PoE),

Use included EPA2406GP only

Operation Modes

Access Point

WDS

Client Bridge

WDS Detail

WDS AP

WDS Bridge

WDS Station

Management

Auto Channel Selection

Multiple SSID: 8 SSIDs

BSSID

SNMP V1/V2c/V3

MIB I/II, Private MIB

VLAN Tag/VLAN Pass-through

Clients Statistics

Save Configuration as User Default

Traffic Shaping per SSID/user

E-Mail Alert

RADIUS Accounting

Guest Network

Control

CLI Supported

Distance Control (Ack Timeout)

802.1X Supplicant (CB Mode)

Multicast Supported

Auto Reboot

Obey Regulatory Power

Security

WEP Encryption - 64/128/152 bit

WPA/WPA2 Personal (WPA-PSK using TKIP or AES)

WPA/WPA2 Enterprise (WPA-PSK using TKIP or AES)

Hides SSID in beacons

MAC address filtering, up to 32 MACs per SSID

Wireless STA (Client) connection list

Https Support

SSH Support

QoS (Quality of Service)

Compliant with IEEE 802.11e standard

Physical/Environment Conditions

Operating:

Temperature: -20 °C to 60 °C (-4 °F to 140 °F)

Humidity (non-condensing): 90% or less

Storage:

Temperature: -30 °C to 80 °C (-22 °F to 176 °F)

Humidity (non-condensing): 90% or less

ENS500EXT-AC

Standard:

IEEE802.11 ac wave2/ac/a/n on 5 GHz

Antenna

2 x detachable 5 dBi 5 GHz Omni-directional Antennas

Physical Interface

2 x 10/100/1000 Gigabit Ethernet Ports with PoE support

LAN1 Port: Proprietary 24V Input

LAN2 Port: Data Transmission

LED Indicator

Power

LAN 1

LAN 2

WLAN

Weak

Normal

Strong

Power Requirements

Proprietary 24V Power over Ethernet (PoE),

Use included EPA2406GP only

Operation Modes

Access Point

WDS

Client Bridge

WDS Detail

WDS AP

WDS Bridge

WDS Station

Management

Auto Channel Selection

Multiple SSID: 8 SSIDs

BSSID

SNMP V1/V2c/V3

MIB I/II, Private MIB

VLAN Tag/VLAN Pass-through

Clients Statistics

Save Configuration as User Default

Traffic Shaping per SSID/user

E-Mail Alert

RADIUS Accounting

Guest Network

Control

CLI Supported

Distance Control (Ack Timeout)

802.1X Supplicant (CB Mode)

Multicast Supported

Auto Reboot

Obey Regulatory Power

Security

WEP Encryption - 64/128/152 bit

WPA/WPA2 Personal (WPA-PSK using TKIP or AES)

WPA/WPA2 Enterprise (WPA-PSK using TKIP or AES)

Hides SSID in beacons

MAC address filtering, up to 32 MACs per SSID

Wireless STA (Client) connection list

Https Support

SSH Support

QoS (Quality of Service)

Compliant with IEEE 802.11e standard

Physical/Environment Conditions

Operating:

Temperature: -20 °C to 60 °C (-4 °F to 140 °F)

Humidity (non-condensing): 90% or less

Storage:

Temperature: -30 °C to 80 °C (-22 °F to 176 °F)

Humidity (non-condensing): 90% or less

Physical Interface (ENS620EXT)

Dimensions and Weights

Length: 191.6 mm (7.54")

Width: 114.3 (4.49")

Depth: 47.7mm (1.88")

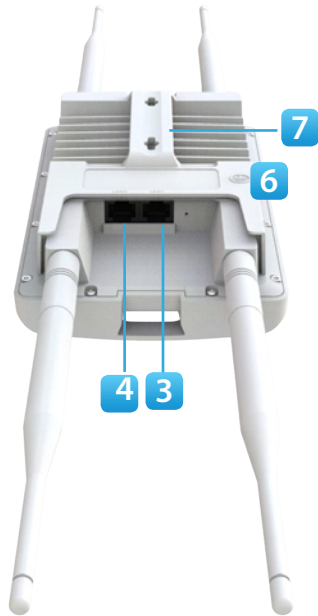

- 1 **2.4 GHz Antennas:** Detachable 5 dBi 2.4 GHz Omni-directional
- 2 **5 GHz Antennas** Detachable 5 dBi 5 GHz Omni-directional
- 3 **LAN Port 1 (Proprietary24V PoE):** Ethernet port for RJ-45 cable.
- 4 **LAN Port 2 :** Ethernet port for RJ-45 cable.
- 5 **LED Indicators:** LED lights for Power, LAN Port 1, LAN Port 2, 2.4 GHz Connection and 5 GHz Connection.
- 6 **Ground Cable**
- 7 **Mounting Holes:** Using the provided hardware, the AP can be attached to a wall or pole.

Physical Interface (ENS610EXT)

Dimensions and Weights

Length: 191.6 mm (7.54")

Width: 114.3 (4.49")

Depth: 47.7mm (1.88")

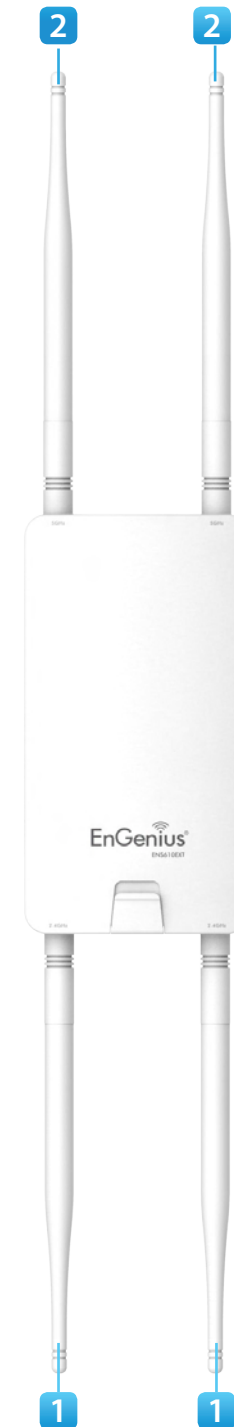
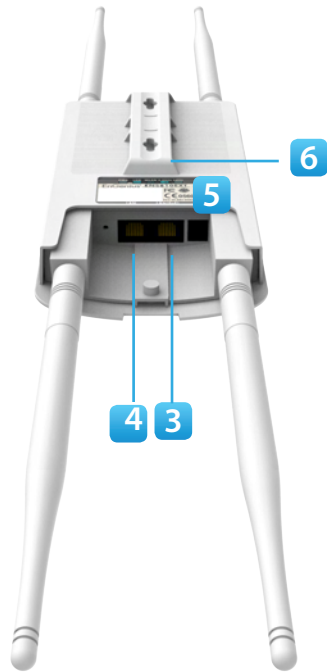

- 1 **2.4 GHz Antennas:** Detachable 5 dBi 2.4 GHz Omni-directional
- 2 **5 GHz Antennas** Detachable 5 dBi 5 GHz Omni-directional
- 3 **LAN Port 1 (Proprietary24V PoE):** Ethernet port for RJ-45 cable.
- 4 **LAN Port 2 :** Ethernet port for RJ-45 cable.
- 5 **LED Indicators:** LED lights for Power, LAN Port 1, LAN Port 2, 2.4 GHz Connection and 5 GHz Connection.
- 6 **Mounting Holes:** Using the provided hardware, the AP can be attached to a wall or pole..

Physical Interface - ENS500-AC/ENS500EXT-AC

Dimensions and Weights

Length: 186 mm (7.32")

Width: 100 (3.94")

Depth: 29mm (1.14")

- 1 **5 GHz Antennas** Detachable 5 dBi 5 GHz Omni-directional Antennas (ENS500EXT-AC Only)
- 2 **LAN Port 1 (Proprietary 24V PoE)**: Ethernet port for RJ-45 cable.
- 3 **LAN Port 2** : Ethernet port for RJ-45 cable.
- 4 **LED Indicators**: LED lights for Power, LAN Port 1, LAN Port 2, 2.4 GHz Connection and 5 GHz Connection.
- 5 **Mounting Holes**: Using the provided hardware, the AP can be attached to a wall or pole.

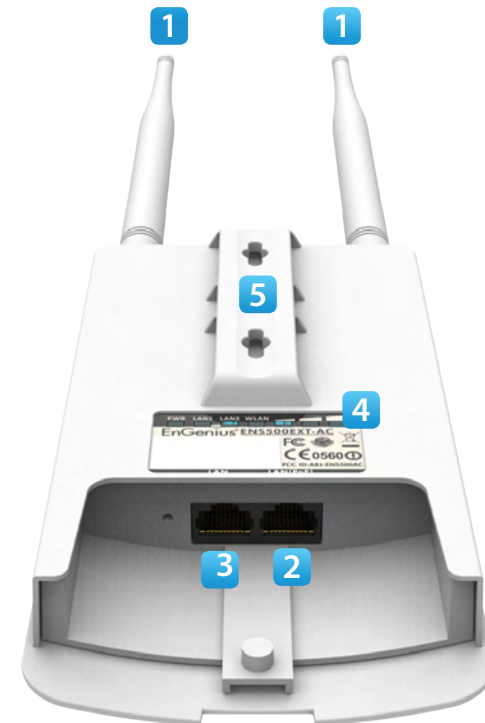

Chapter 2

Before You Begin



Computer Settings

Windows XP/Windows 7/Windows 8/Windows 10

In order to use the Access Point, you must first configure the TCP/IPv4 connection of your Windows OS computer system.

1a. Click the **Start** button and open the **Control Panel**

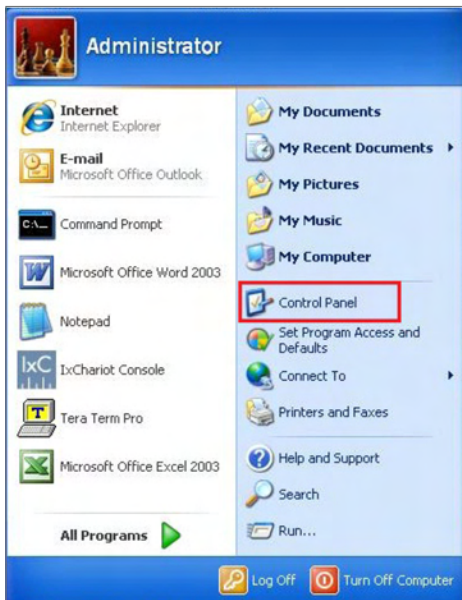

Windows XP

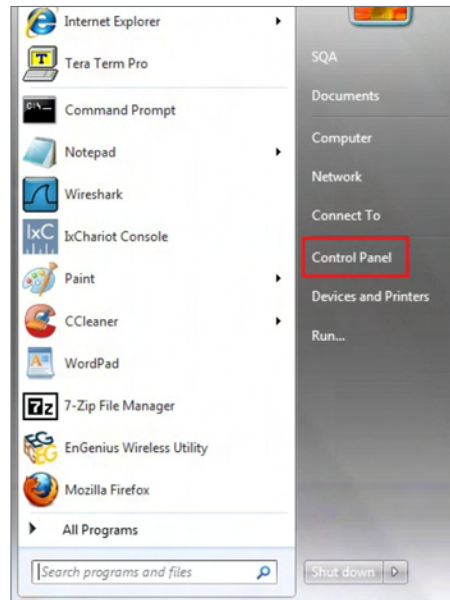

Windows 7

1b. Move your mouse to the lower right hot corner to display the Charms Bar and select the **Control Panel** in Windows 8 OS.

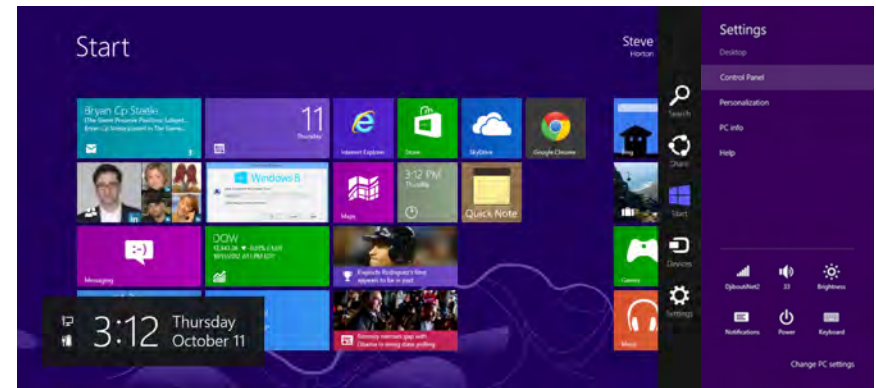

Windows 8

1c. In Windows 10, click **Start** to select **All APPs** to enter the folder of **Windows system** for selecting **Control Panel**.

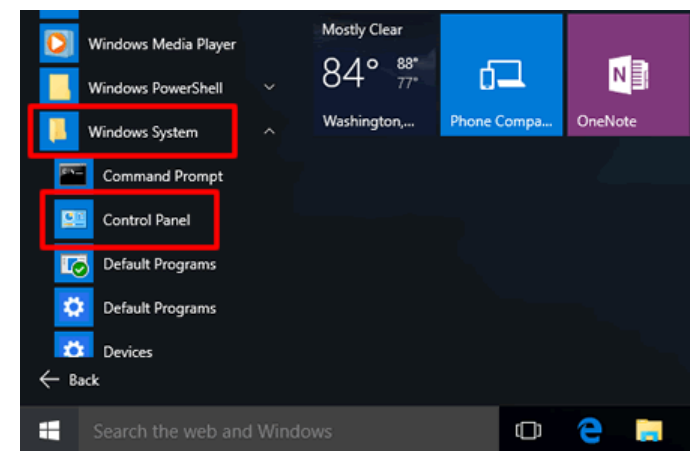

Windows 10

2a. In Windows XP, click **Network Connections**.



2b. In Windows 7/Windows 8/Windows 10, click **View Network Status and Tasks** in the **Network and Internet** section, then select **Change adapter settings**.

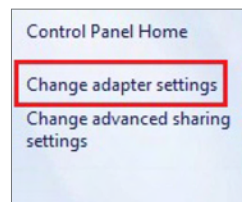

3. Right click on **Local Area Connection** and select **Properties**.

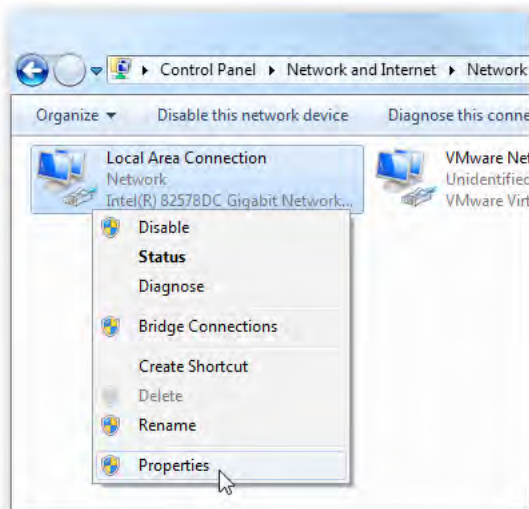

4. Select **Internet Protocol Version 4 (TCP/IPv4)** and then select **Properties**.

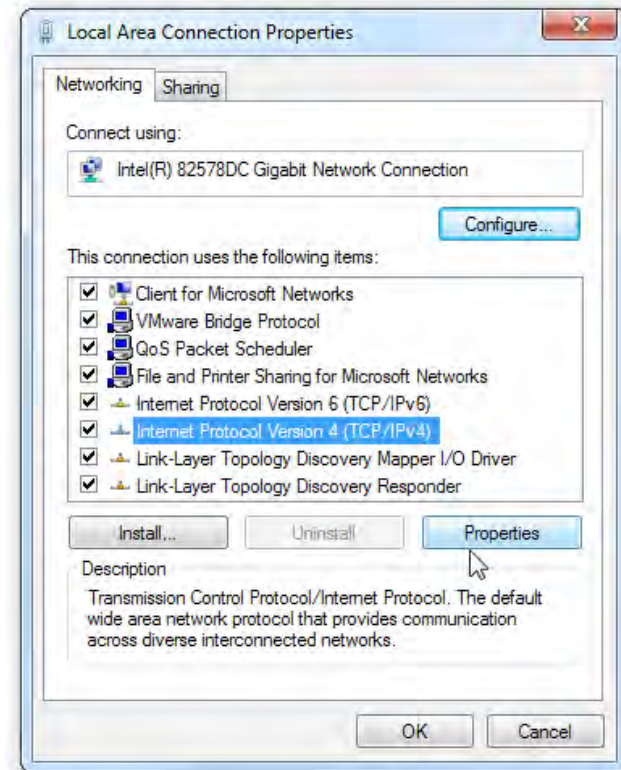

5. Select **Use the following IP address** and enter an IP address that is different from the Access Point and Subnet mask, then click **OK**.

Note: Ensure that the IP address and Subnet mask are on the same subnet as the device.

For example: ENH220EXT IP address: 192.168.1.1

PCIP address: 192.168.1.2 - 192.168.1.255

PC Subnet mask: 255.255.255.0

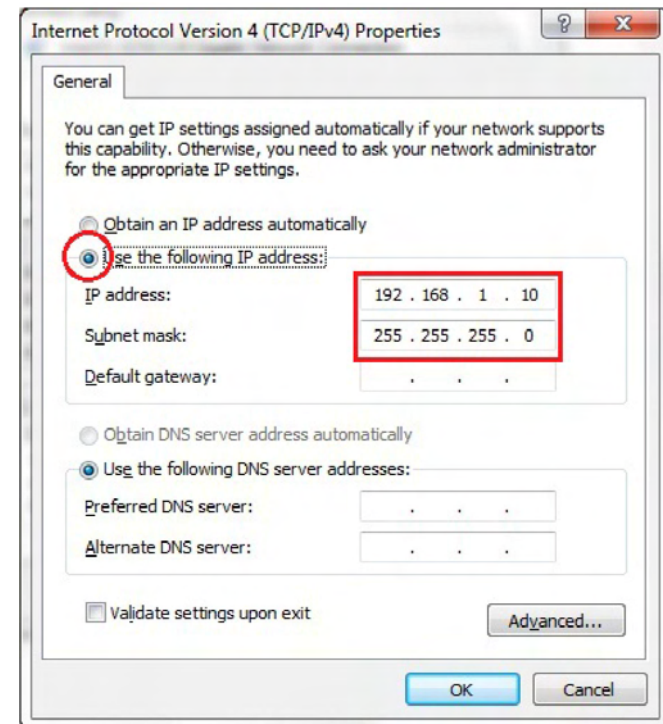

Apple Mac OS X

1. Go to **System Preferences** (Which can be opened in the Applications folder or selecting it in the Apple Menu).
2. Select **Network** in the **Internet & Network** section.



3. Highlight **Ethernet**.

4. In **Configure IPv4**, select **Manually**.
5. Enter an IP address that is different from the Access Point and Subnet mask then press **OK**.

Note: Ensure that the IP address and Subnet mask are on the same subnet as the device.

For example: ENH900EXT IP address: 192.168.1.1

PC IP address: 192.168.1.2 - 192.168.1.255

PC Subnet mask: 255.255.255.0

6. Click **Apply** when done.

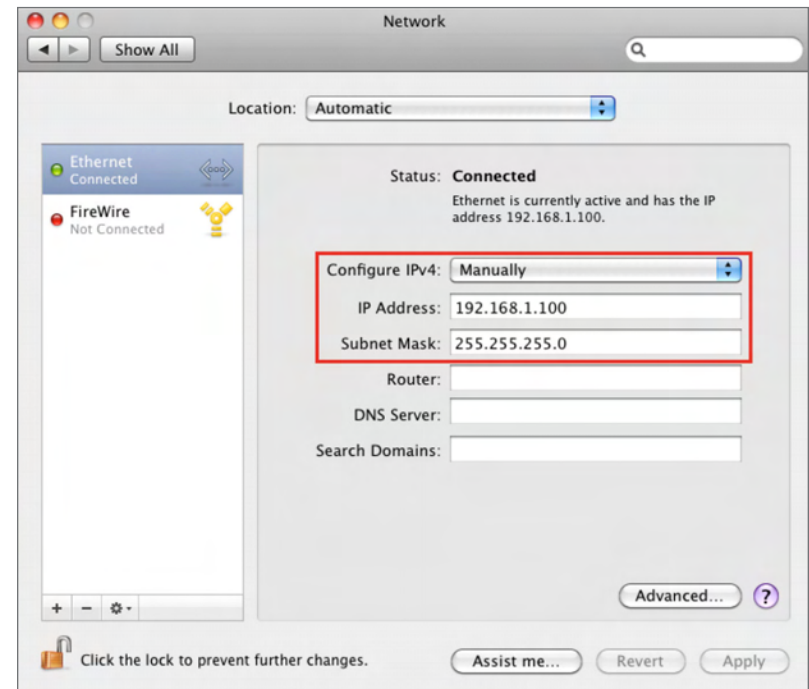

Hardware Installation

- A. Remove the rear bottom panel.
- B. Connect one end of the Ethernet cable into the LAN(PoE) port of the AP/Bridge and the other end to the PE port on the PoE Adapter.
- C. Connect the Power cord with the PoE Adapter and plug the other end into an electrical outlet.
- D. Connect the second Ethernet cable into the LAN port of the PoE adapter and the other end to the Ethernet port on the computer.
- E. Place the pane removed from step A back into the device.
- F. Screw on the provided antennas to the top of this device.
(Applied on the ENS500EXT-AC / ENS610EXT/ENS620EXT)

This diagram depicts the hardware configuration.

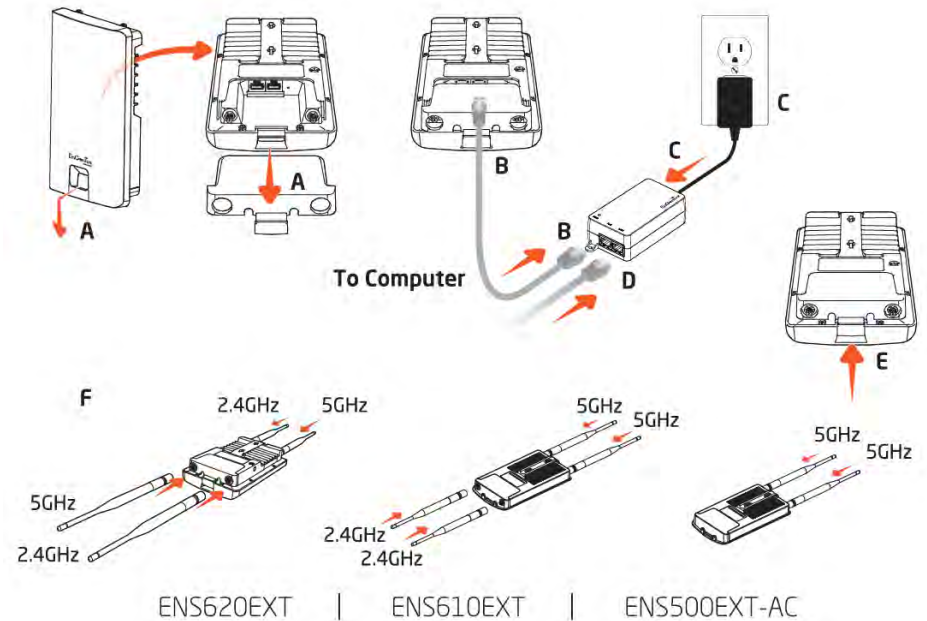

Note: The Access Point **NOLY** supports the included proprietary 24V PoE adapter.

Mounting the AP

Using the provided hardware, the AP can be attached to a wall or a pole.

1. Wall Mounting Kit

(Anchors: $\Phi 5.5 \times 18$ mm & Bolts: $\Phi 8 \times 25$ mm)

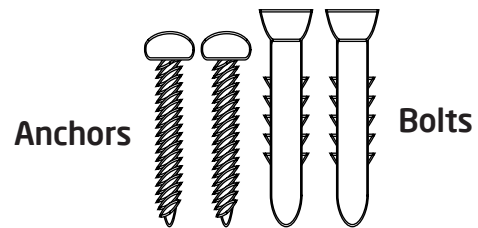

2. Pole Mounting Strap

($\Phi 63.5 \times 12.7$ mm)

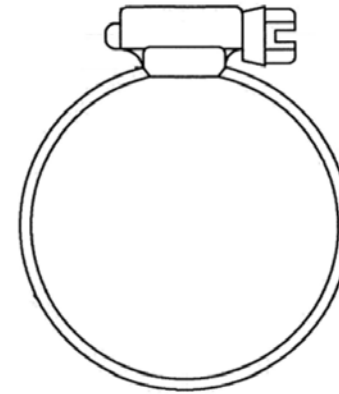

To attach the AP to a wall using wall mounting kit.

1. Determine where the Access Point to be placed and mark locations on a surface for the two mounting holes. Use an appropriate drill bit to drill two 8.1mm diameter and 26mm depth holes in the markings and hammer the bolts into the opening.
2. Screw the anchors onto the holes until they are flush with the wall.
3. Screw the included screws into the anchors.
4. Place this Access Point against wall with the mounting heads.

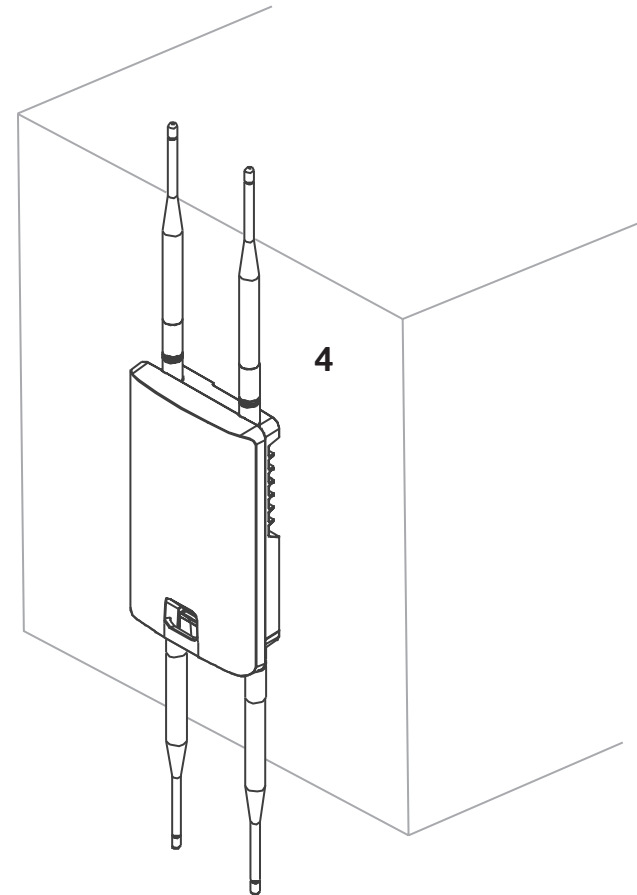
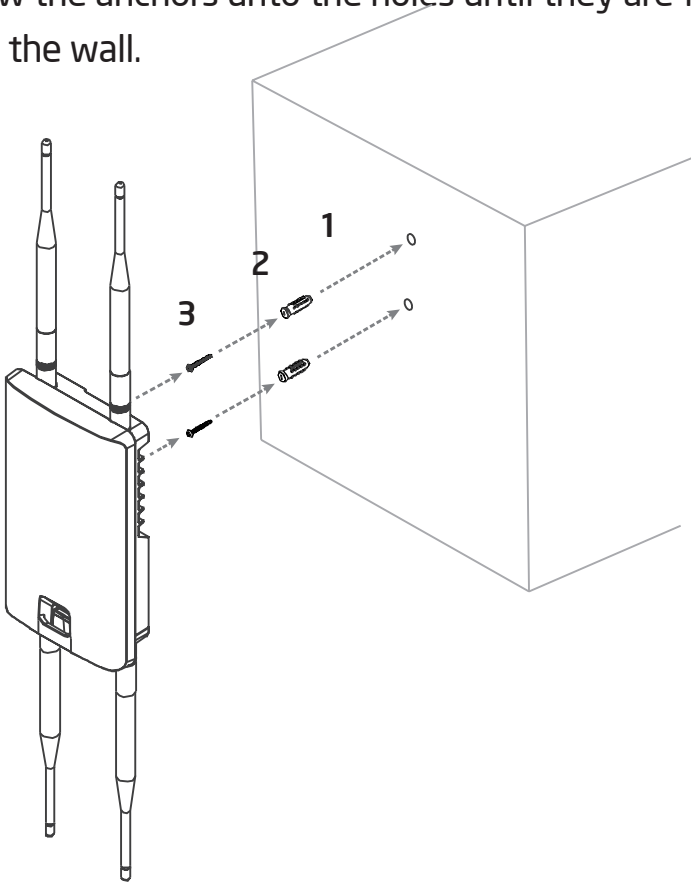

To attach the AP to a pole using the provided pole mounting kit:

1. Thread the open end of the pole strap through the two tabs on the Pole Mount Bracket.
2. Lock and tighten pole strap to secure pole mount bracket to the pole.

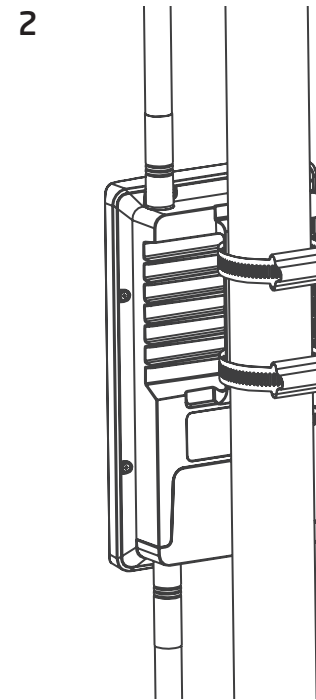
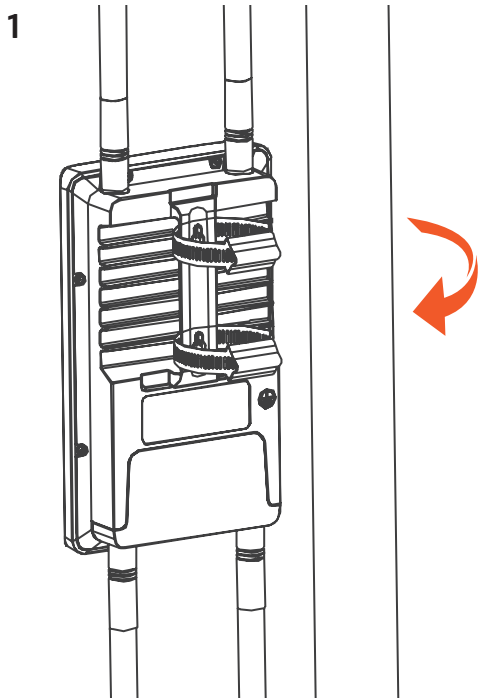

Install Ground cable (ENS620EXT Only)

No outdoor APs are built to withstand a direct lightning strike. To prevent a directly lightning strike into outdoor APs, they should be properly grounded to a viable path for lightning surge to deliver to ground so that it does not go into the building network. This AP have a ground lug on the left side of this AP which is applied to attach a proper ground to.

***Attention: You must always install an external grounding wire ensure that you have completed grounding before you connect power to the unit.**

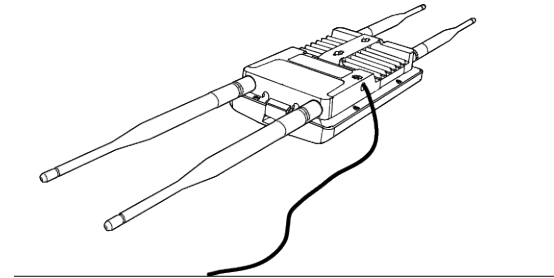
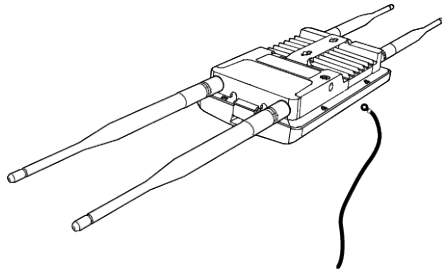

Chapter 3

Configuring Your Access Point



Configuring Your Access Point

This section will show you how to configure the device using the web-based configuration interface.

Default Settings

Please use your Ethernet port or wireless network adapter to connect the Access Point.

| | |
|---------------------|---------------|
| IP Address | 192.168.1.1 |
| Username / Password | admin / admin |

Web Configuration

1. Open a web browser (Internet Explorer/Firefox/Safari/Chrome) and enter the IP Address **http://192.168.1.1**

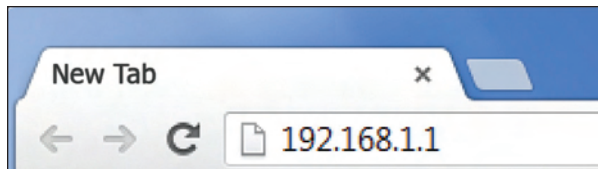

Note: If you have changed the default LAN IP Address of the Access Point, ensure you enter the correct IP Address.

2. The default username and password are **admin**. Once you have entered the correct username and password, click the **Login** button to open the web-base configuration page.

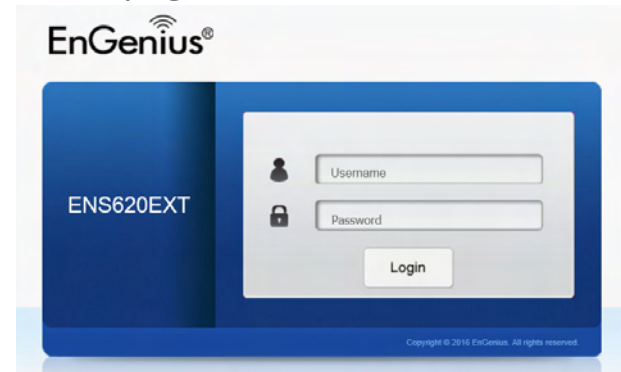

- * The model name will be varied by different models.
3. If successful, you will be logged in and see the User Menu of this Access Point.

Chapter 4

Building a Wireless Network



Before starting to configure this Access Point, you may realize the used scenario under varied operating modes. The AP has the ability to operate in various modes. This chapter describes purpose of different operating modes and lists down the operating modes for outdoor Access Points or Client Premise Equipments (CPE).

Access Point Mode

In Access Point Mode, AP behaves like a central connection for stations or clients that support IEEE 802.11 ac/a/b/g/n networks. The stations and clients must be configured to use the same SSID (Service Set Identifier) and security password to associate with the AP. The AP supports up to eight SSIDs per band at the same time for secure access.

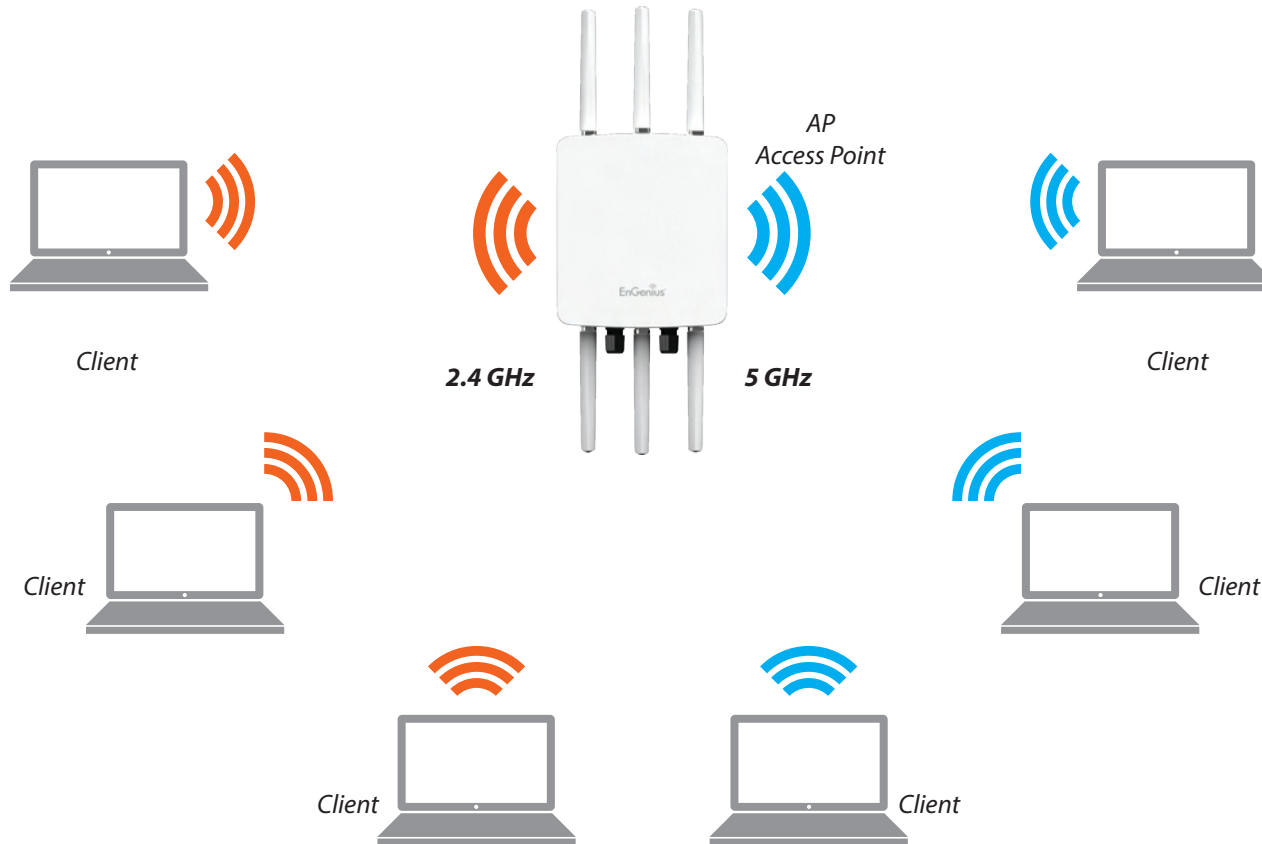

Client Bridge Mode

The Access Point essentially acts as a wireless adapter that connects to an access point to allow a system of wireless access to the network in the Client Bridge mode. Since the computers are on the same subnet, the Access Point can broadcast to reach all end-devices.

If you use the client bridge mode in this Access Point, you can use the AP Detection feature to scan for Access Points within range. When you find an Access Point, configure this Access Point to use the same SSID and Security Password as the Access Point to associate with it.

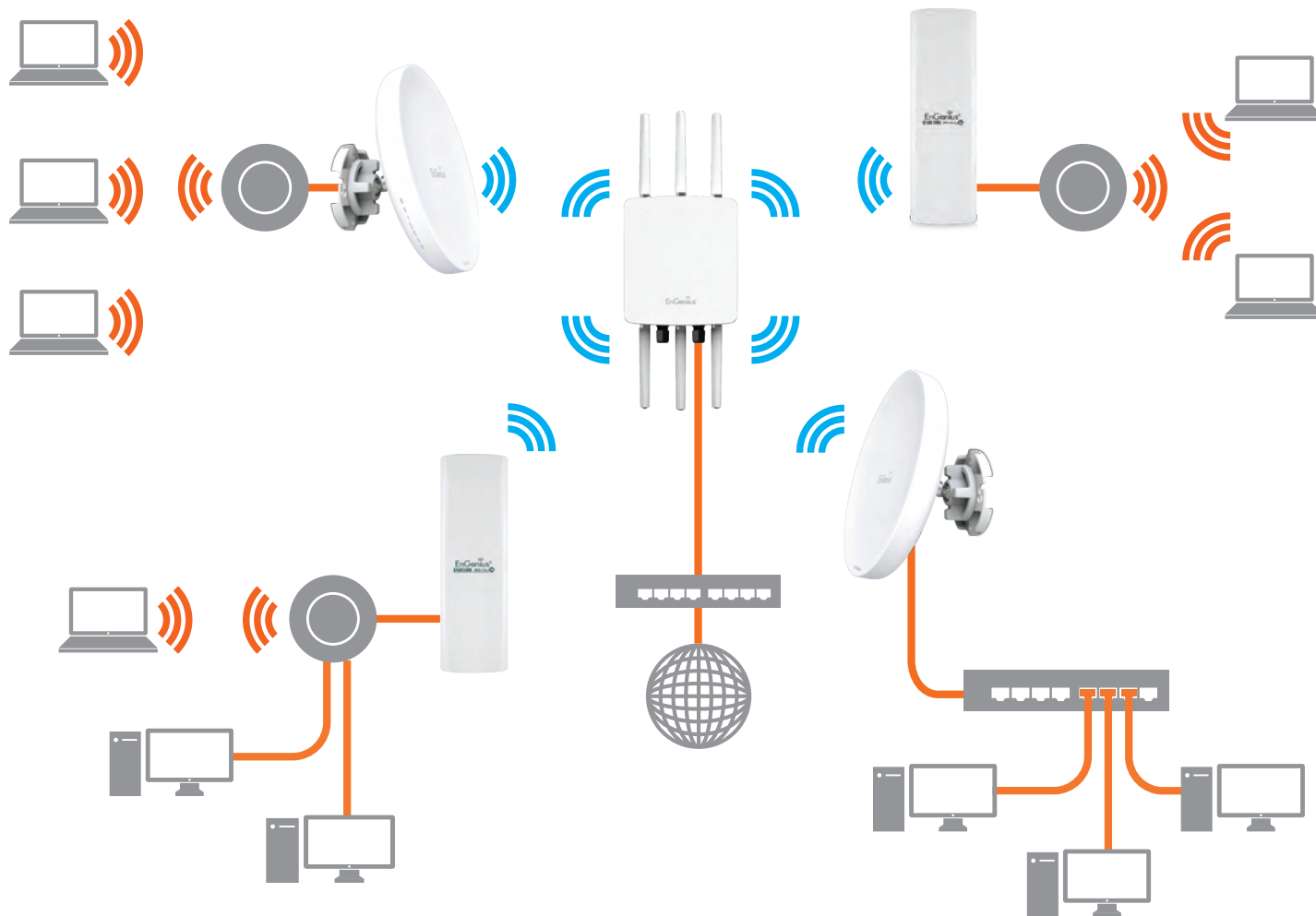

The AP can be used as a centralized Outdoor Access Point with which other EnGenius Wireless 802.11b/g/n 2.4 or ac/a/n 5 GHz Outdoor Client Bridges can associate; leveraging the long-range capability of their internal high-gain directional antennas, resulting in a very cost-effective solution to expand a company network over a multiple building campus.

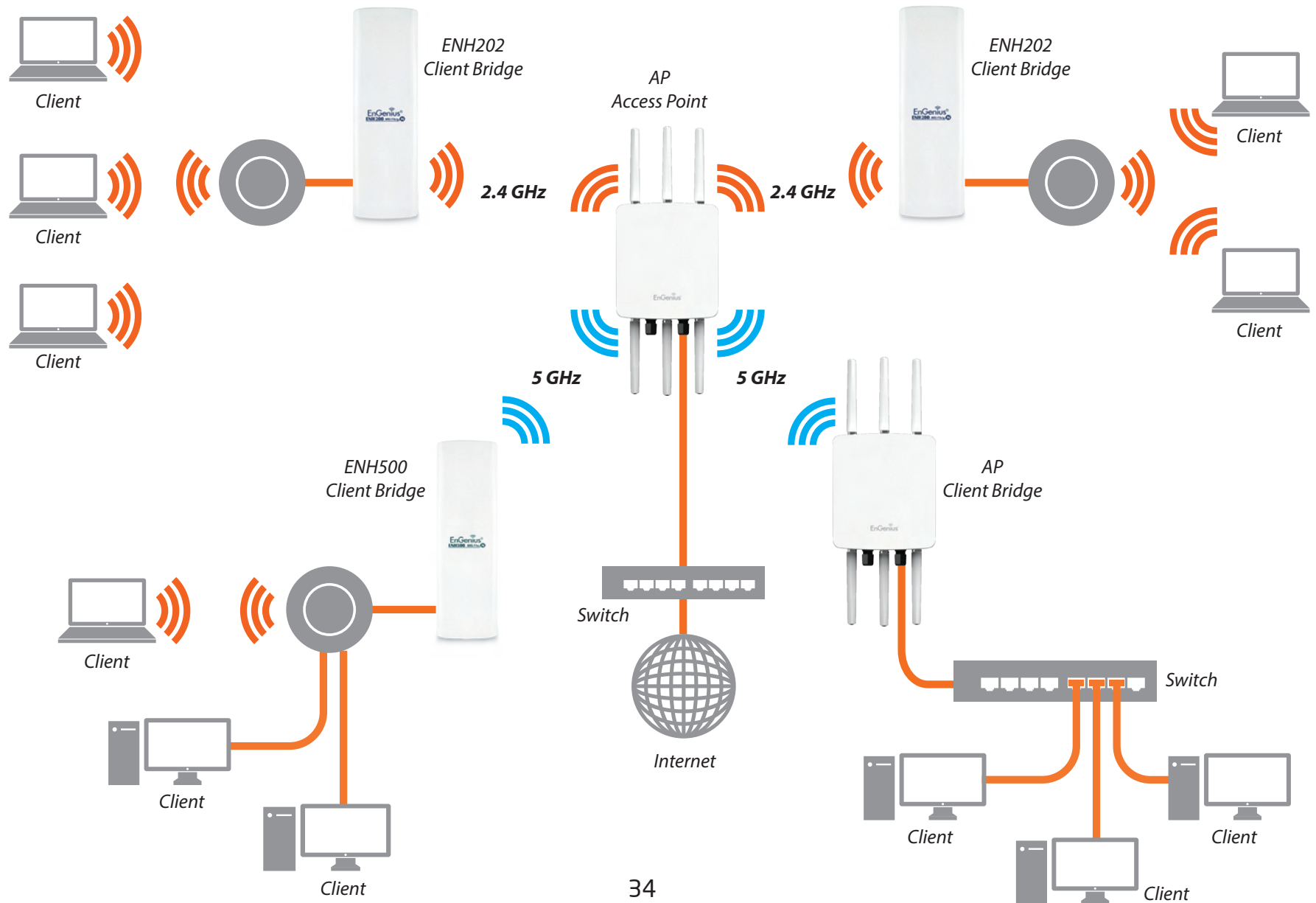

WDS AP Mode

The AP also supports WDS AP mode. This operating mode allows wireless stations to connect with Access Point via using WDS technology. In this mode, configure the MAC addresses or SSIDs in both Access Points to enlarge the wireless area by enabling WDS Link settings. WDS AP mode supports up to four (4) AP MAC addresses and four (4) SSIDs at the same time.

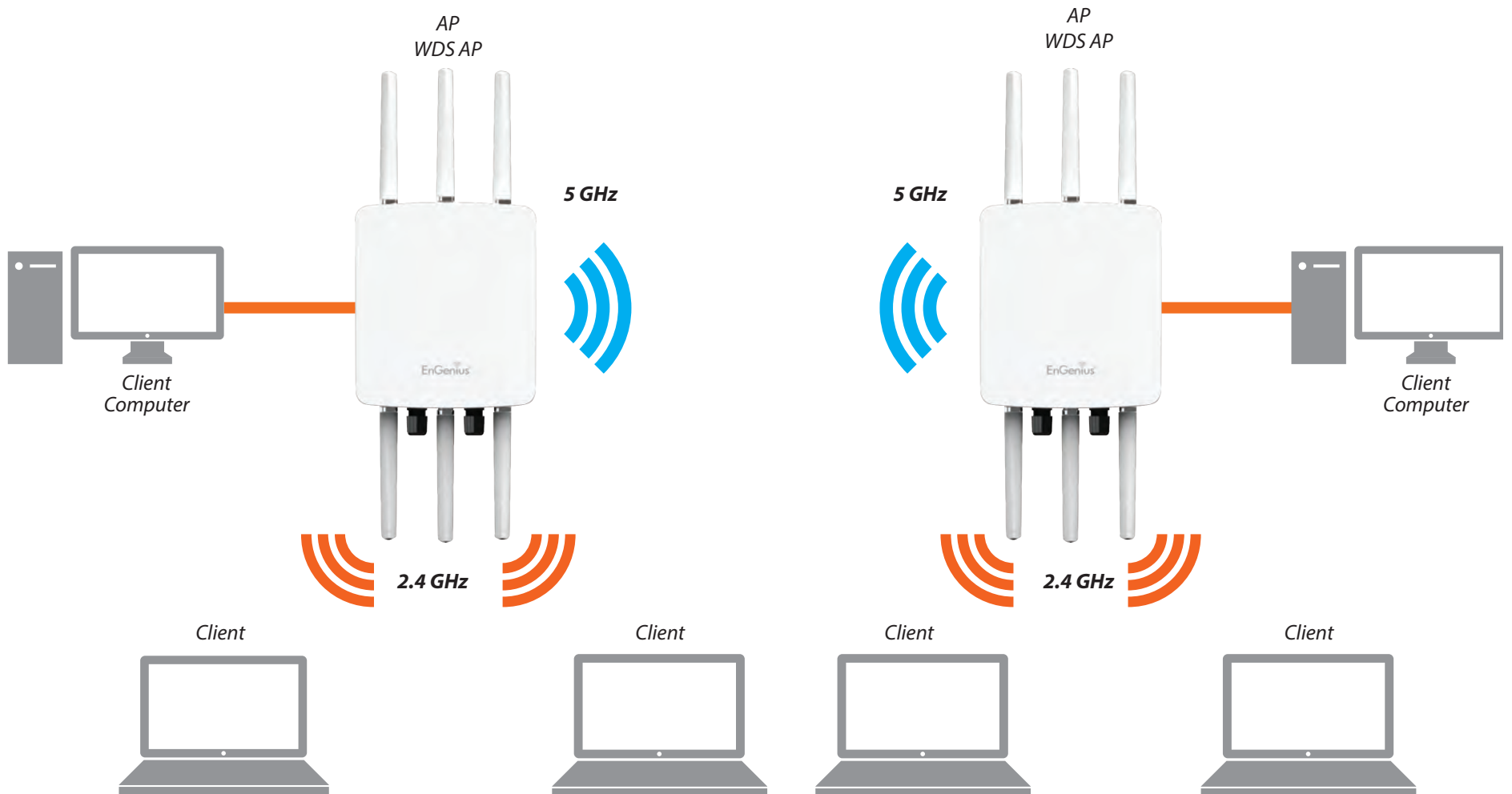

WDS Bridge Mode

In WDS Bridge Mode, the Access Point can wirelessly connect different LANs by configuring the MAC address and security settings of each Access Point. Use this operating mode when two wired LANs located a small distance apart want to communicate with each other. The best solution is to use the Access Point to wirelessly connect two wired LANs, as shown in the following diagram.

WDS Bridge Mode can establish up to four (4) to eight (8) WDS links, creating a star-like network.

Note: WDS Bridge Mode does not act as an Access Point. Access Points linked by WDS are using the same frequency channel. More Access Points connected together may lower throughput. This configuration can be susceptible to generate endless network loops in your network, so it is recommended to enable the Spanning Tree function to prevent this from happening.

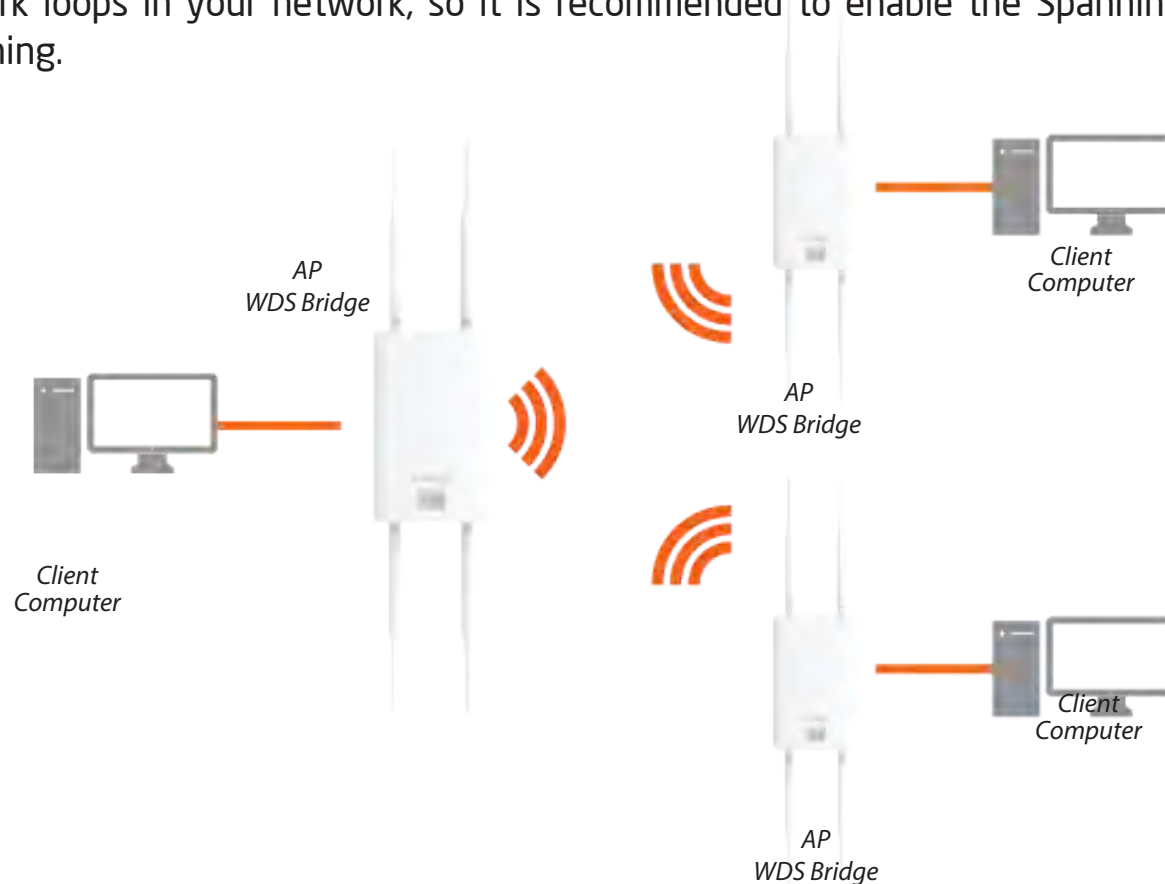

WDS Station Mode

WDS station (WDS STA) mode expands the WDS by receiving a wireless signal/service and sharing it through the Ethernet port. With WDS STA mode,

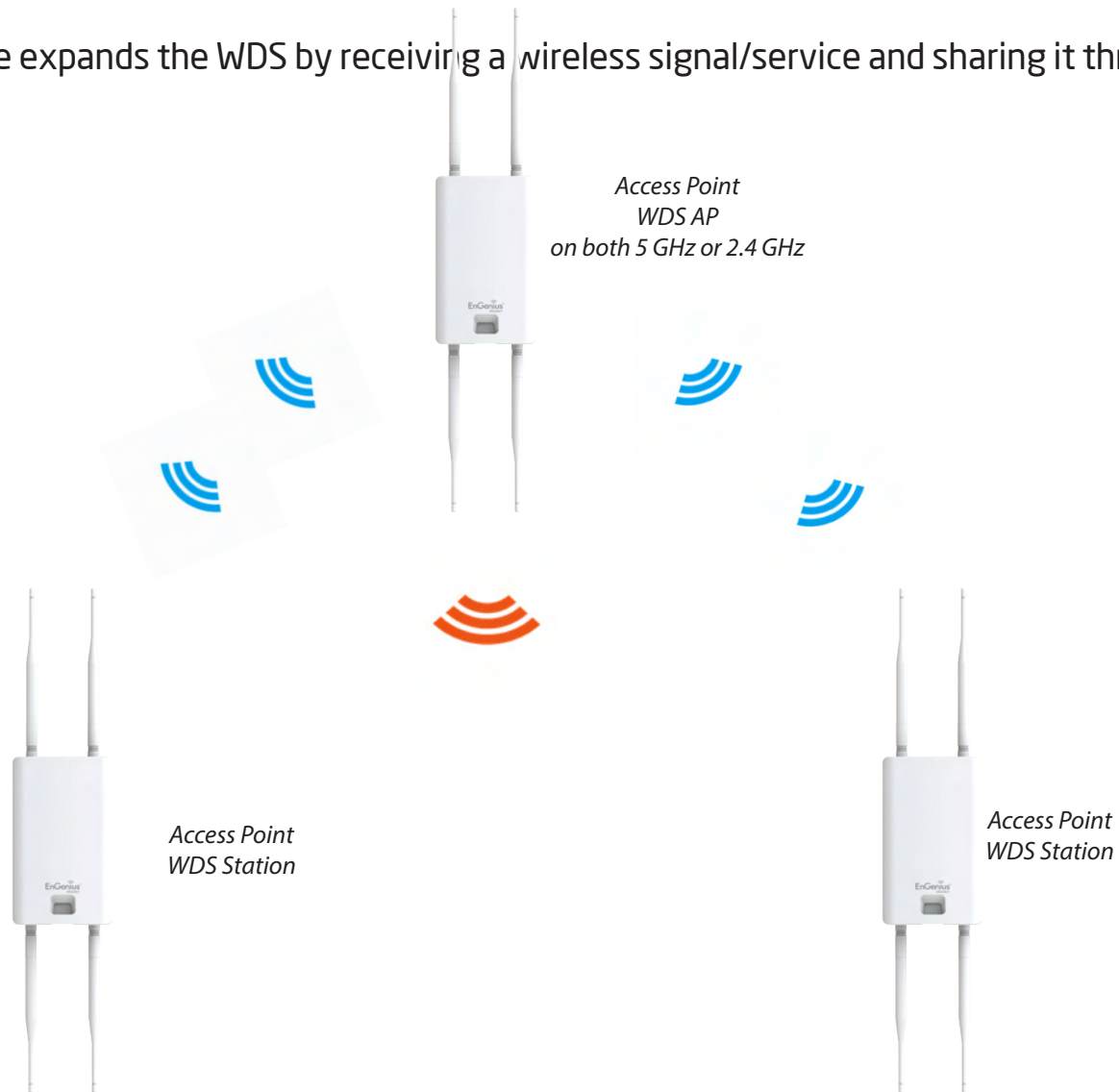

Chapter 5

Status



Overview

Save Changes

This page lets you save and apply the settings shown under **Unsaved changes list**, or Revert the unsaved changes and revert to the previous settings that were in effect.

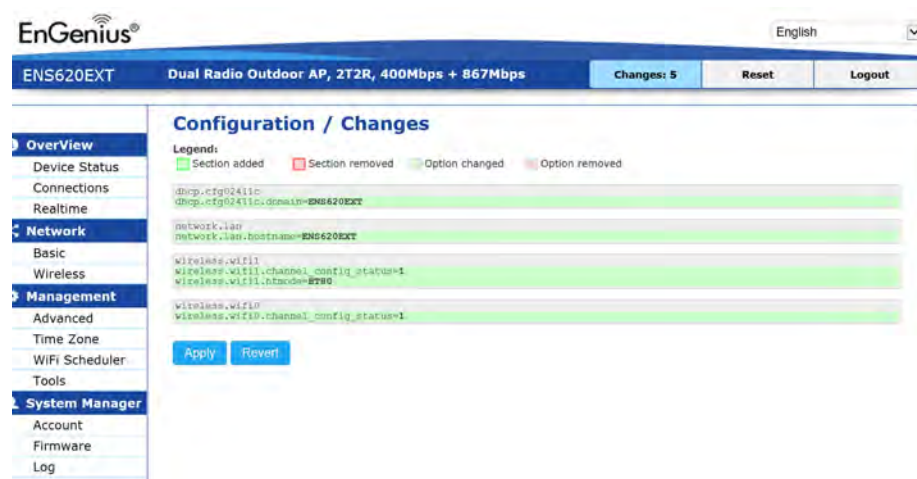

Device Status

Clicking the **Device Status** link under the **Overview** menu shows the status information about the current operating mode.

- The **Device Information** section shows general system information such as Device Name, MAC Address, Current Time, Firmware Version, and Management VLAN ID

Note: VLAN ID is only applicable in Access Point, WDS AP or WDS BR mode.

Device Information

| | |
|-------------------------|--------------------------|
| Device Name | ENS620EXT |
| MAC Address | |
| - LAN1 | 88:DC:96:00:00:10 |
| - LAN2 | 88:DC:96:00:00:11 |
| - Wireless LAN - 2.4GHz | 88:DC:96:00:00:12 |
| - Wireless LAN - 5GHz | 88:DC:96:00:00:13 |
| Country | USA |
| Current Local Time | Tue Jul 12 11:45:00 2016 |
| Uptime | 0h 4m 57s |
| Firmware Version | 1.0.0 |
| Management VLAN ID | Untagged |

- The **Memory Information** section shows usage of memory such as Total Available, Free, Cached, Buffered

Memory Information

| | |
|-----------------|-----------------------------|
| Total Available | 128884 kB / 236336 kB (54%) |
| Free | 95352 kB / 236336 kB (40%) |
| Cached | 24908 kB / 236336 kB (10%) |
| Buffered | 8624 kB / 236336 kB (3%) |

- The **LAN Information** section shows the Local Area Network settings such as the LAN IP Address, Subnet mask, Primary DNS Address, Secondary DNS Address, status of DHCP client, and status of Spanning Tree protocol (STP).

LAN Information - IPv4

| | |
|-----------------------------|---------------|
| IP Address | 192.168.1.1 |
| Subnet Mask | 255.255.255.0 |
| Gateway | 192.168.1.1 |
| Primary DNS | 0.0.0.0 |
| Secondary DNS | 0.0.0.0 |
| DHCP Client | Disable |
| Spanning Tree Protocol(STP) | Disable |

The **Wireless LAN Information 2.4 GHz/5 GHz** section shows wireless information such as Operation Mode, Frequency, and Channel. Since this Access Point supports multiple-SSIDs, information about each SSID, the ESSID, and security settings, are displayed

Note: Profile Settings are only applicable in Access Point and WDS AP modes.

Wireless LAN Information - 2.4GHz

| Operation Mode | Access Point | | | |
|-------------------|------------------------------|----------|-----|---------|
| Wireless Mode | 802.11 B/G/N | | | |
| Channel Bandwidth | 20 MHz | | | |
| Channel | 2.412 GHz(Channel 1) | | | |
| Profile | SSID | Security | VID | 802.1Q |
| #1 | EnGenius_Test | None | 1 | Disable |
| #2 | EnGenius-mac-_2-2.4GHz | None | 2 | Disable |
| #3 | EnGenius-mac-_3-2.4GHz | None | 3 | Disable |
| #4 | EnGenius-mac-_4-2.4GHz | None | 4 | Disable |
| #5 | EnGenius-mac-_5-2.4GHz | None | 5 | Disable |
| #6 | EnGenius-mac-_6-2.4GHz | None | 6 | Disable |
| #7 | EnGenius-mac-_7-2.4GHz | None | 7 | Disable |
| #8 | EnGenius-mac-_8-2.4GHz | None | 8 | Disable |
| #9 | EnGenius-2.4GHz_GuestNetwork | None | | Disable |

Wireless LAN Information - 5GHz

| Operation Mode | WDS Access Point | | | |
|-------------------|-----------------------|----------|-----|---------|
| Wireless Mode | 802.11 N/AC | | | |
| Channel Bandwidth | 80 MHz | | | |
| Channel | 5.180 GHz(Channel 36) | | | |
| Profile | SSID | Security | VID | 802.1Q |
| #1 | EnGenius_Test | None | 51 | Disable |
| #2 | EnGenius-mac-_2-5GHz | None | 52 | Disable |
| #3 | EnGenius-mac-_3-5GHz | None | 53 | Disable |
| #4 | EnGenius-mac-_4-5GHz | None | 54 | Disable |

- The **Statistics** section shows Mac information such as SSID, MAC address, RX and TX.

Statistics

| SSID | MAC | RX(Packets) | TX(Packets) |
|------------------------|-------------------|----------------------|----------------------|
| Ethernet | 88:DC:96:00:00:10 | 134.37 KB(829 Pkts.) | 893.75 KB(857 Pkts.) |
| EnGenius-mac-_1-2.4GHz | 88:DC:96:00:00:12 | 0.00 B(0 Pkts.) | 21.34 KB(149 Pkts.) |
| EnGenius-mac-_1-5GHz | 88:DC:96:00:00:13 | 0.00 B(0 Pkts.) | 8.02 KB(44 Pkts.) |

Connections

2.4 GHz/5 GHz Connection List

Click the connection link under the Overview menu displays the connection list of clients associated to the AP's 2.4 GHz/5 GHz, along with the MAC addresses and signal strength for each client. Clicking **Refresh** updates the client list.

Note: Only applicable in Access Point and WDS AP modes.

2.4 GHz/5 GHz WDS Link List

Click the connection link under the Overview menu. This page displays the current status of the WDS link, including WDS Link ID, MAC Address, Link Status and RSSI.

Note: Only applicable in WDS AP and WDS Bridge modes.

| Connection List - 2.4GHz | | | | | |
|--------------------------|-------------|----|----|------|-------|
| SSID | MAC Address | TX | RX | RSSI | Block |
| | | | | | |

| WDS Link List - 5GHz | | | |
|----------------------|-------------|-------------|-----------|
| WDS Link ID# | MAC Address | Link Status | RSSI(dBm) |
| | | | |

[Refresh](#)

Realtime

Realtime

The Realtime section contains the following options:

CPU Loading: 3 minutes CPU loading percentage information, it displays current loading, average loading and peak loading status. Left bar is loading percentage; button is time tracing. Interval is every 3 seconds

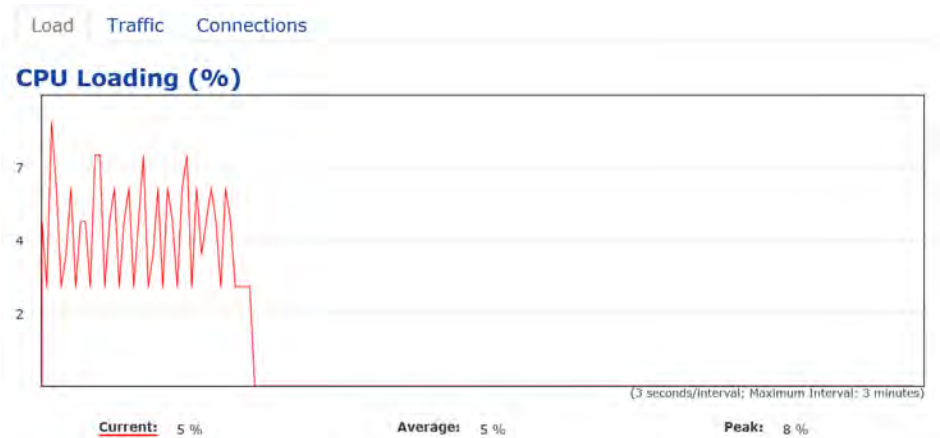

Traffic Loading: 2.4GHz and 5GHz and Ethernet port inbound and outbound traffic by current, average and peak time.

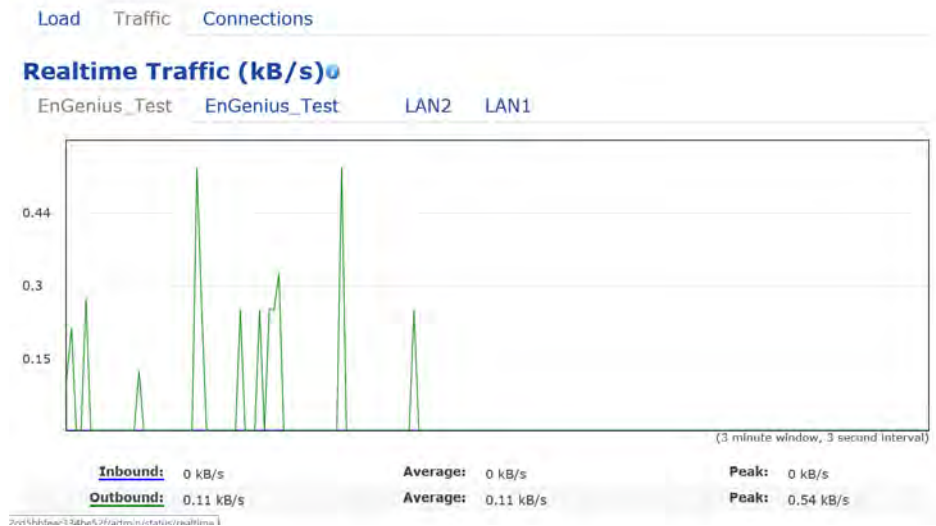

Realtime Connection (Pkts): Overview on current active network connections. It displays UDP and TCP packets information and other connection status. UDP connections curve is in blue; TCP connection curve is in green; others curve is in red. Below of chart shows connections source and destination.

Chapter 6

Network



Basic

IPv4/IPv6 Settings

This page allows you to modify the device's IP settings.

| IPv4 Settings | |
|--------------------|---|
| IP Network Setting | <input type="radio"/> DHCP <input checked="" type="radio"/> Static IP |
| IP Address | <input type="text" value="192.168.1.1"/> |
| Subnet Mask | <input type="text" value="255.255.255.0"/> |
| Gateway | <input type="text" value="192.168.1.1"/> |
| Primary DNS | <input type="text" value="0.0.0.0"/> |
| Secondary DNS | <input type="text" value="0.0.0.0"/> |

| IPv6 Settings | |
|----------------------|--|
| | <input checked="" type="checkbox"/> Link-local Address |
| IP Address | <input type="text"/> |
| Subnet Prefix Length | <input type="text"/> |
| Gateway | <input type="text"/> |
| Primary DNS | <input type="text"/> |
| Secondary DNS | <input type="text"/> |

IP Network Settings: Select whether the device IP address will use a static IP address specified in the IP address field or be obtained automatically when the device connects to a DHCP server.

IP Address: The IP address of this device.

Subnet Mask: The IP Subnet mask of this device.

Gateway: The Default Gateway of this device. Leave it blank if you are unsure of this setting.

Primary/Secondary DNS: The primary/secondary DNS address for this device.

Save: Click **Save** to confirm the changes.

Spanning Tree Protocol (STP) Settings

This page allows you to modify the Spanning Tree settings. Enabling the Spanning Tree protocol will prevent network loops in your LAN network.

| Spanning Tree Protocol (STP) Settings | | |
|---------------------------------------|---|----------------|
| Status | <input type="radio"/> Enable <input checked="" type="radio"/> Disable | |
| Hello Time | <input type="text" value="2"/> | seconds (1-10) |
| Max Age | <input type="text" value="20"/> | seconds (6-40) |
| Forward Delay | <input type="text" value="15"/> | seconds (4-30) |
| Priority | <input type="text" value="32768"/> | (0-65535) |

Spanning Tree Status: Enables or Disables the Spanning Tree function. Default is Disable.

Hello Time: Specifies Bridge Hello Time in seconds. This value determines how often the device sends handshake packets to communicate information about the topology throughout the entire Bridged Local Area Network.

Max Age: Specifies Bridge Max Age in seconds. If another

bridge in the spanning tree does not send a hello packet for a long period of time, it is assumed to be inactive.

Forward Delay: Specifies Bridge Forward Delay in seconds. Forwarding delay time is the time spent in each of the Listening and Learning states before the Forwarding state is entered. This delay is provided so that when a new bridge comes onto a busy network, it analyzes data traffic before participating in the network.

Priority: Specifies the Priority Number. A smaller number has a greater priority than a larger number.

Save: Click **Save** to confirm the changes.

Chapter 7

2.4 GHz & 5 GHz Wireless



Wireless

Wireless Settings

Wireless Settings

| | |
|------------------|-----------|
| Device Name | ENS620EXT |
| Country / Region | USA |
| Band Steering | Disabled |

NOTE: In order for Band Steering function to work properly, both 2.4GHz and 5GHz SSID and Security Settings must be the same.

Device Name: Enter a name for the device. The name you type appears in SNMP management. This name is not the SSID and is not broadcast to other devices.

Band Steering (Available on ENS620EXT): Enable Band Steering to send 802.11n clients to the 5 GHz band, where 802.11b/g clients cannot go, and leave 802.11b/g clients in 2.4GHz to operate at their slower rates. Before implementing this feature, we suggest you to assure the both 2.4GHz and 5GHz SSID, as well as security settings must be the same. EnGenius Band Steering supports following advanced settings,

Wireless Settings

| | |
|------------------|------------|
| Device Name | ENS620EXT |
| Country / Region | USA |
| Band Steering | Force 5GHz |

INFORMATION: When band steering is configured to Force 5GHz mode, the AP will not allow a dual band client to connect to the 2.4GHz band only if the client is not currently associated on the 2.4GHz radio of this AP.
NOTE: In order for Band Steering function to work properly, both 2.4GHz and 5GHz SSID and Security Settings must be the same.

***Force 5GHz:** When band steering is configured to Force 5GHz mode, the AP will not dual band capable client

devices to network to the 2.4GHz band only if the client devices are not currently associated on 2.4GHz radio in this AP.

Wireless Settings

| | |
|---------------|-------------|
| Band Steering | Prefer 5GHz |
|---------------|-------------|

5GHz RSSI -75 dBm

NOTE: In order for Band Steering function to work properly, both 2.4GHz and 5GHz SSID and Security Settings must be the same.

***Prefer 5GHz:** When band steering is configured to Prefer 5GHz mode, the AP will steer dual band capable client devices to 5GHz radio when the RSSI value of these client devices on 5GHz radio is more than set one. The allowed RSSI value for default setting is -75dBm.

Wireless Settings

| | | |
|--------------|-------------------|---------------------------------------|
| Band Balance | 5GHz RSSI -75 dBm | Percent of clients on 5GHz radio 75 % |
|--------------|-------------------|---------------------------------------|

NOTE: In order for Band Steering function to work properly, both 2.4GHz and 5GHz SSID and Security Settings must be the same.

***Band Balance:** When band steering is configured to Band Balance mode, the AP will steer dual band capable client devices to 5GHz when the RSSI value of these client devices on 5GHz radio is more than set one. To evenly allocate RF resource on the both 2.4GHz and 5GHz radios, users also can set the portion of client devices on 5GHz radio to assure smoothly connection. The default value of the 5GHz radio is 75%.

Save: Click **Save** to confirm the changes.

This page displays the current status of the Wireless settings of this AP.

2.4 GHz/5 GHz Wireless Network

| | 2.4GHz | 5GHz |
|------------------------------|--|---|
| Operation Mode | Access Point <input checked="" type="checkbox"/> Green | Access Point <input checked="" type="checkbox"/> Green |
| Wireless Mode | 802.11 B/G/N | 802.11 AC/N |
| Channel HT Mode | 20MHz | 40MHz |
| Channel | Configuration | |
| Transmit Power | Auto | Auto |
| Data Rate | Auto | Auto |
| RTS/CTS Threshold (1 - 2346) | 2346 | 2346 |
| Client Limits | 127 <input checked="" type="radio"/> Enable <input type="radio"/> Disable | 127 <input checked="" type="radio"/> Enable <input type="radio"/> Disable |
| Aggregation | <input checked="" type="radio"/> Enable <input type="radio"/> Disable 32 Frames 50000 Bytes(Max) | |
| AP Detection | Scan | Scan |
| Distance (1-30km) | 1 (0.6miles) | 1 (0.6miles) |

Operation Mode: Scrow down this list to select operation modes for implementing on this radio. The default operation mode is **Access Point** on base stations and Access Points and is **Client Bridge** on Client Premise Equipements (CPE). Meanwhile, EnGenius outdoor devices also support WDS modes for peer to peer or peer to multi-peer connections.

Wireless Mode: Scrow down this list to select wireless broadcasting standard on 2.4GHz and 5GHz frequency bands.

Channel HT Mode: Scrow down this list to select bandwidth for operating under a frequency band. The default channel bandwidth is 20 MHz on 2.4GHz frequency radio and 40 MHz on 5GHz frequency radio. Considering the different applications, users can decide to implement a channel bandwidth to fulfill real applications. The larger the channel, the greater the transmission quality and speed.

Transmit Power (Tx Power): Default Tx power is Auto to obey regularatory power of each country.

Channel: Click Configuration button to open a new windows to configure channels for performing wireless service.

| 2.4GHz | | 5GHz | |
|-------------------|-------------------|-------------------|-------------------|
| All | None | All | None |
| 1,6,11 | 1,4,8,11 | U-NII-1 | U-NII-2A |
| 1,7 | 1,5,9 | U-NII-2B | U-NII-3 |
| Ch 01 : 2.412 GHz | Ch 02 : 2.417 GHz | Ch 36 : 5.180 GHz | Ch 40 : 5.200 GHz |
| Ch 03 : 2.422 GHz | Ch 04 : 2.427 GHz | Ch 44 : 5.220 GHz | Ch 48 : 5.240 GHz |
| Ch 05 : 2.432 GHz | Ch 06 : 2.437 GHz | Ch 52 : 5.260 GHz | Ch 56 : 5.280 GHz |
| Ch 07 : 2.442 GHz | Ch 08 : 2.447 GHz | Ch 60 : 5.300 GHz | Ch 64 : 5.320 GHz |
| Ch 09 : 2.452 GHz | Ch 10 : 2.457 GHz | Ch100 : 5.500 GHz | Ch104 : 5.520 GHz |
| Ch 11 : 2.462 GHz | | Ch108 : 5.540 GHz | Ch112 : 5.560 GHz |
| | | Ch132 : 5.660 GHz | Ch136 : 5.680 GHz |
| | | Ch149 : 5.745 GHz | Ch153 : 5.765 GHz |
| | | Ch157 : 5.785 GHz | Ch161 : 5.805 GHz |

[Save](#) Save current setting(s)

***Default configuration:** Default setting of channel selection is “All” to perform auto channel on the exist channel list.

***None:** Click “None” to disable the setting on this radio. This radio is disabled.

***Group Configuration:** Click specific groups of channels for performing auto channel function. For example, users can click U-NII-1 and U-NII-3 to perform auto channel on these bands; the mechanism of this AP will select the relatively optimal channel to perform wireless service.

Data Rate: Select a data rate from the drop-down list. The data rate affects throughput of data in the AP. Select the best balance for you and your network but note that the lower the data rate, the lower the throughput, though transmission distance is also lowered.

RTS/CTS Threshold: Specifies the threshold package size for RTS/CTS. A small number causes RTS/CTS packets to be sent more often and consumes more bandwidth.

Client Limits: Limits the total number of clients on this radio. Once setting the ceiling of client numbers, the maximum

associated client devices will be restricted at this number.

Aggregation: Integrate multiple data packets into one packet to deliver to client devices. This option reduces the number of packets, but also increases packet sizes.

AP Detection: AP Detection can select the best channel to use by scanning nearby areas for Access Points.

Distance: Specifies the distance between Access Points and client devices. The proper setting for this parameter may assist Access Points to avoid the improper operation when transmitting data under a filed application.

Save: Click **Save** to confirm the changes or **Cancel** to cancel and return to previous settings.

2.4 GHz/5 GHz SSID Profile

Wireless Settings - 2.4GHz

| No. | Enable | SSID | Edit | Security | Suppressed SSID | Station Separation | Isolation | VID |
|-----|-------------------------------------|-------------------------|------|----------|--------------------------|--------------------------|--------------------------|-----|
| 1 | <input checked="" type="checkbox"/> | EnGenius063C96_1-2.4GHz | Edit | None | <input type="checkbox"/> | <input type="checkbox"/> | <input type="checkbox"/> | 1 |
| 2 | <input type="checkbox"/> | EnGenius063C96_2-2.4GHz | Edit | None | <input type="checkbox"/> | <input type="checkbox"/> | <input type="checkbox"/> | 2 |
| 3 | <input type="checkbox"/> | EnGenius063C96_3-2.4GHz | Edit | None | <input type="checkbox"/> | <input type="checkbox"/> | <input type="checkbox"/> | 3 |
| 4 | <input type="checkbox"/> | EnGenius063C96_4-2.4GHz | Edit | None | <input type="checkbox"/> | <input type="checkbox"/> | <input type="checkbox"/> | 4 |
| 5 | <input type="checkbox"/> | EnGenius063C96_5-2.4GHz | Edit | None | <input type="checkbox"/> | <input type="checkbox"/> | <input type="checkbox"/> | 5 |
| 6 | <input type="checkbox"/> | EnGenius063C96_6-2.4GHz | Edit | None | <input type="checkbox"/> | <input type="checkbox"/> | <input type="checkbox"/> | 6 |
| 7 | <input type="checkbox"/> | EnGenius063C96_7-2.4GHz | Edit | None | <input type="checkbox"/> | <input type="checkbox"/> | <input type="checkbox"/> | 7 |
| 8 | <input type="checkbox"/> | EnGenius063C96_8-2.4GHz | Edit | None | <input type="checkbox"/> | <input type="checkbox"/> | <input type="checkbox"/> | 8 |

Wireless Settings - 5GHz

| No. | Enable | SSID | Edit | Security | Suppressed SSID | Station Separation | Isolation | VID |
|-----|-------------------------------------|-----------------------|------|----------|--------------------------|--------------------------|--------------------------|-----|
| 1 | <input checked="" type="checkbox"/> | EnGenius063C97_1-5GHz | Edit | None | <input type="checkbox"/> | <input type="checkbox"/> | <input type="checkbox"/> | 51 |
| 2 | <input type="checkbox"/> | EnGenius063C97_2-5GHz | Edit | None | <input type="checkbox"/> | <input type="checkbox"/> | <input type="checkbox"/> | 52 |
| 3 | <input type="checkbox"/> | EnGenius063C97_3-5GHz | Edit | None | <input type="checkbox"/> | <input type="checkbox"/> | <input type="checkbox"/> | 53 |
| 4 | <input type="checkbox"/> | EnGenius063C97_4-5GHz | Edit | None | <input type="checkbox"/> | <input type="checkbox"/> | <input type="checkbox"/> | 54 |
| 5 | <input type="checkbox"/> | EnGenius063C97_5-5GHz | Edit | None | <input type="checkbox"/> | <input type="checkbox"/> | <input type="checkbox"/> | 55 |
| 6 | <input type="checkbox"/> | EnGenius063C97_6-5GHz | Edit | None | <input type="checkbox"/> | <input type="checkbox"/> | <input type="checkbox"/> | 56 |
| 7 | <input type="checkbox"/> | EnGenius063C97_7-5GHz | Edit | None | <input type="checkbox"/> | <input type="checkbox"/> | <input type="checkbox"/> | 57 |
| 8 | <input type="checkbox"/> | EnGenius063C97_8-5GHz | Edit | None | <input type="checkbox"/> | <input type="checkbox"/> | <input type="checkbox"/> | 58 |

Current Profile: You can configure up to sixteen (16) different SSIDs (eight (8) per band). If multiple client devices will be accessing the network, you can arrange the devices into SSID groups. Click **Edit** to configure the profile and check whether you want to enable extra SSID.

Enable: Click this check box to enable this SSID interface. The default SSIDs are enable on the both first 2.4GHz and 5GHz SSID.

SSID: Specifies the SSID for the current profile.

Hidden SSID: Check this option to hide the SSID from clients. If checked, the SSID will not appear in the site survey.

Client Isolation: Click the appropriate radio button to enable this function for allowing or preventing communication between client devices.

VID: Specifies the VLAN tag for each profile. If your network includes VLANs, you can specify a VLAN ID for packets pass through the Access Point with a tag.

Wireless Security: See the Wireless Security section.

VLAN Isolation: Restrict clients communicating with different VIDs by selecting the radio button.

L2 Isolation: Enable this function prevent client devices to communicate on the both WLAN and LAN.

Save: Click **Save** to accept the changes.

Wireless Security

The *Wireless Security* section lets you configure the AP's security modes

| Wireless Security - 2.4GHz | |
|----------------------------|-----------------------------------|
| Security Mode | WEP ▼ |
| Auth Type | Open System ▼ |
| Input Type | Hex ▼ |
| Key Length | 40/64-bit (10 hex digits or 5 A ▼ |
| Default Key | Key #1 ▼ |
| Key #1 | <input type="text"/> |
| Key #2 | <input type="text"/> |
| Key #3 | <input type="text"/> |
| Key #4 | <input type="text"/> |

Security Mode: Including WEP, WPA-PSK, WPA2-PSK, WPA-PSK Mixed, WPA, WPA2, and WPA Mixed. We strongly recommend you to use WPA2-PSK mode.

* **Setting of WEP mode:**

Auth Type: Select **Open System** or **Shared Key**.

Input Type:

ASCII: Regular Text (recommended)

Hexadecimal Numbers (For advanced users)

Key Length: Select the desired option and ensure that wireless clients use the same setting. Your choices are 64, 128, and 152-bit password lengths.

Default Key: Select the Key you wish to be the default. Transmitted data is **ALWAYS** encrypted using the Default Key; the other Keys are for decryption only. You must enter a Key Value for the Default Key.

Encryption Key Number: Enter the Key Value or values you wish to use. Only the Key selected as Default is required. The others are optional.

| Wireless Security - 5GHz | |
|---------------------------|----------------------|
| Security Mode | WPA-PSK ▼ |
| Encryption | AES ▼ |
| Passphrase | <input type="text"/> |
| Group Key Update Interval | 3600 |

*** Setting of WPA-PSK, WPA2-PSK and WPA-PSK Mixed (Pre-Shared Key):**

Encryption: You may select AES, TKIP or Both (TKIP+AES) to be the encryption type you would like. Please ensure that your wireless clients use the same settings.

Passphrase: Wireless clients must use the same Key to associate the device. If using ASCII format, the Key must be from 8 to 63 characters in length. If using HEX format, the Key must be 64 HEX characters in length.

Group Key Update Interval: Specifies how often, in seconds, the Group Key changes. The default value is 3600.

| Wireless Security - 5GHz | |
|-----------------------------|----------------------|
| Security Mode | WPA-Enterprise ▼ |
| Encryption | AES ▼ |
| Group Key Update Interval | 3600 |
| Radius Server | <input type="text"/> |
| Radius Port | 1812 Default 1812 |
| Radius Secret | <input type="text"/> |
| Radius Accounting | Disable ▼ |
| Radius Accounting Server | <input type="text"/> |
| Radius Accounting Port | 1813 |
| Radius Accounting Secret | <input type="text"/> |
| Interim Accounting Interval | 600 |

*** Setting of WPA-Enterprise & WPA2-Enterprise (Pre-Shared Key):**

Encryption: Select the WPA encryption type you would like. Please ensure that your wireless clients use the same settings.

Radius Server: Enter the IP address of the Radius server.

Radius Port: Enter the port number used for connections to the Radius server.

Radius Secret: Enter the secret required to connect to the Radius server.

Radius Accounting: Enable or disable accounting feature.

Radius Accounting Server: Enter the IP address of the Radius accounting server.

Radius Accounting Port Enter the port number used for connections to the Radius accounting server.

Radius Accounting Secret: Enter the secret required to connect to the Radius accounting server.

Interim Accounting Interval: Specifies how often, in seconds, the accounting data sends.

Note: 802.11n does not allow WEP/WPA-PSK TKIP/WPA2-PSK TKIP security mode. The connection mode will automatically change from 802.11n to 802.11g.

Wireless MAC Filtering

Wireless MAC Filtering is used to allow or deny network access to wireless clients (computers, tablet PCs, NAS, smartphones, etc.) according to their MAC addresses. You can manually add a MAC address to restrict permission to access this AP. The default setting is: **Disable Wireless MAC Filter**.

Note: Only applicable in Access Point and WDS AP modes.

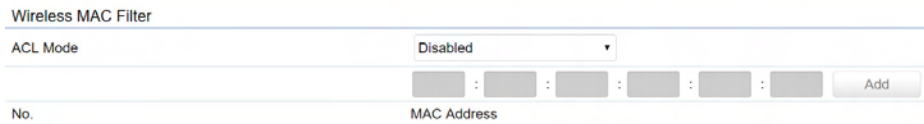

The screenshot shows the 'Wireless MAC Filter' configuration page. At the top, there is a section titled 'Wireless MAC Filter'. Below it, the 'ACL Mode' is set to 'Disabled' in a dropdown menu. Underneath, there is a row of six input fields for entering a MAC address, each followed by a colon, and an 'Add' button to the right. Below this row is a table with two columns: 'No.' and 'MAC Address'.

ACL Mode: Determines whether network access is granted or denied to clients whose MAC addresses appear in the MAC address table on this page. Your choices are: Disabled, Deny MAC in the list, or Allow MAC in the list.

MAC Address: Enter the MAC address of the wireless client.

Add: Click **Add** to add the MAC address to the MAC address table.

Delete: Delete the selected entries.

Save: Click **Save** to apply the changes.

Wireless Advanced

Wireless Traffic Shaping

Traffic shaping regulates the flow of packets leaving an interface to deliver improved Quality of Service.

The screenshot shows the 'Wireless Traffic Shaping' configuration page. It features three main sections: 'Enable Traffic Shaping', 'Download Limit', and 'Upload Limit'. Each section has a text input field, a 'Per User' checkbox, and a unit label 'Mbps (1-999)'. The 'Enable Traffic Shaping' section has radio buttons for 'Enable' and 'Disable', with 'Disable' selected. The 'Download Limit' and 'Upload Limit' sections have input fields containing the value '100'.

| Wireless Traffic Shaping | |
|--------------------------|--|
| Enable Traffic Shaping | <input type="radio"/> Enable <input checked="" type="radio"/> Disable |
| Download Limit | <input type="text" value="100"/> <input type="checkbox"/> Per User Mbps (1-999) |
| Upload Limit | <input type="text" value="100"/> <input type="checkbox"/> Per User Mbps (1-999) |

Save: Click **Save** to confirm the changes.

Enable Traffic Shaping: Default is disable. You may check this option to enable Wireless Traffic Shaping per SSID.

Download Limit: Specifies the wireless transmission speed used for downloading.

Upload Limit: Specifies the wireless transmission speed used for uploading.

Per User: Check this option to enable wireless traffic shaping per user function. This function allow users to limit the maximum download / upload bandwidth for each client devices on this SSID.

Fast Roaming

Enable the function to serve mobile client devices that roam from Access Point to Access Point. Some applications running on Client devices require fast re-association when they roam to a different Access Point

Please enter the settings of the SSID and initialize the Security mode to WPA enterprise, as well as to set the Radius Server firstly. Users can enable the Fast Roaming and implement the advanced search.

Please also set the same enterprise Encryption under the same SSID on other Access Points and enable the Fast Roaming. When the configuration is realized on different Access Point, the mobile client devices can run the voice service and require seamless roaming to prevent delay in conversation from Access Point to Access Point.

Fast Roaming 

Enable Fast Roaming

Enable Disable

Enable Fast Roaming: Enable or disable fast roaming feature.

Enable Advanced Search: Enable or disable advanced search feature.

WDS Link Settings

Using the WDS (Wireless Distribution System) feature will allow a network administrator or installer to connect to Access Points wirelessly. Doing so will extend the wired infrastructure to locations where cabling is not possible or inefficient to implement.

Note: Compatibility between different brands and models of Access Points is not guaranteed. It is recommended that the WDS network be created using the same models for maximum compatibility.

Also note: All Access Points in the WDS network need to use the same Channel and Security settings.

To create a WDS network, please enter the MAC addresses of the Access Points that you want included in the WDS. There can be a maximum of four Access Points.

Note: Only applicable in WDS AP and WDS Bridge modes.

2.4 GHz/5 GHz WDS Link Settings

| WDS Link Settings - 2.4GHz | | | |
|----------------------------|--|----------------------|-----------|
| Security | None ▾ | | |
| AES Passphrase | <input type="text"/> (8-63 ASCII characters or 64 hexadecimal digits) | | |
| ID | MAC Address | | Mode |
| 1 | <input type="text"/> | <input type="text"/> | Disable ▾ |
| 2 | <input type="text"/> | <input type="text"/> | Disable ▾ |
| 3 | <input type="text"/> | <input type="text"/> | Disable ▾ |
| 4 | <input type="text"/> | <input type="text"/> | Disable ▾ |

| WDS Link Settings - 5GHz | | | |
|--------------------------|--|----------------------|-----------|
| Security | None ▾ | | |
| AES Passphrase | <input type="text"/> (8-63 ASCII characters or 64 hexadecimal digits) | | |
| ID | MAC Address | | Mode |
| 1 | <input type="text"/> | <input type="text"/> | Disable ▾ |
| 2 | <input type="text"/> | <input type="text"/> | Disable ▾ |
| 3 | <input type="text"/> | <input type="text"/> | Disable ▾ |
| 4 | <input type="text"/> | <input type="text"/> | Disable ▾ |

Security: Select **None** or **AES** from the drop-down list.

AES Passphrase: Enter the Key Values you wish to use. Other Access Points must use the same Key to establish a WDS link.

MAC Address: Enter the Access Point's MAC address to where you want to extend the wireless area.

Mode: Select to disable or enable from the drop-down list.

Save: Click **Save** to confirm the changes.

Guest Network Settings

Adding a guest network allows visitors to use the Internet without giving out your office or company wireless security key. You can add a guest network to each wireless network in the 2.4 GHz b/g/n and 5 GHz ac/a/n frequencies.

| Enable | SSID | Edit | Security | Suppressed SSID | Station Separation |
|--------------------------|--------------------------|------|----------|--------------------------|-------------------------------------|
| <input type="checkbox"/> | EnGenius-2.4GHz_GuestNet | Edit | None | <input type="checkbox"/> | <input checked="" type="checkbox"/> |
| <input type="checkbox"/> | EnGenius-5GHz_GuestNetw | Edit | None | <input type="checkbox"/> | <input checked="" type="checkbox"/> |

Manual IP Settings

| | |
|---------------|---------------|
| - IP Address | 192.168.200.1 |
| - Subnet Mask | 255.255.255.0 |

Automatic DHCP Server Settings

| | |
|-----------------------|-----------------|
| - Starting IP Address | 192.168.200.100 |
| - Ending IP Address | 192.168.200.200 |
| - WINS Server IP | 0.0.0.0 |

SSID: Specifies the SSID for the current profile.

Suppressed SSID: Check this option to hide the SSID from clients. If checked, the SSID will not appear in the site survey.

Station Separation: Click the appropriate radio button to allow or prevent communication between client devices.

IP Address: The IP Address of this device.

Subnet Mask: The IP Subnet mask of this device.

Starting IP Address: The first IP Address in the range of

the addresses by the DHCP server.

Ending IP Address: The last IP Address in the range of addresses assigned by the DHCP server.

| | | |
|----------------|---|---|
| RSSI Threshold | 2.4GHz | 5GHz |
| Status | <input type="radio"/> Enable <input checked="" type="radio"/> Disable | <input type="radio"/> Enable <input checked="" type="radio"/> Disable |
| RSSI | -85 dBm (Range: -60dBm ~ -100dBm) | -90 dBm (Range: -60dBm ~ -100dBm) |

RSSI Threshold: Enable the RSSI Threshold feature by ensuring that each client is served by at least one Access Point at any time. Access Points continuously monitor the connectivity quality of any client in their range and efficiently share this information with other Access Points in the vicinity of that client to coordinate which of them should serve the client best.

RSSI: Enter the RSSI (Received Signal Strength Index) in order to determine the handover procedure which the current wireless link will terminate. RSSI is an indication of the power level being received by the antenna. Therefore, the higher the RSSI number, the stronger the signal.

Chapter 8

Management



Management VLAN Settings

This page allows you to assign a VLAN tag to packets sent over the network. A VLAN is a group of computers on a network whose software has been configured so that they behave as if they were on a separate Local Area Network (LAN). Computers on VLAN do not have to be physically located next to one another on the LAN.

Note: Only applicable in Access Point and WDS AP modes.

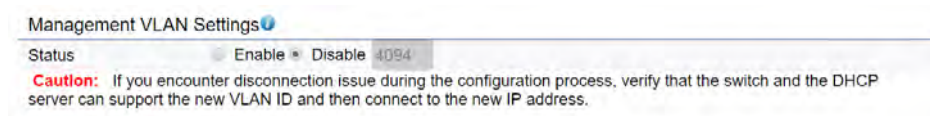

Management VLAN: If your network includes VLANs, you can enable **Management VLAN ID** for packets passing through the Access Point with a tag.

Save: Click **Save** to confirm the changes or **Cancel** to cancel and return to previous settings.

Note: If you reconfigure the Management VLAN ID, you may lose your connection to this AP. Verify that the

DHCP server supports the reconfigured VLAN ID and then reconnect to this AP using the new IP address.

Advanced Settings

SNMP Settings

This page allows you to assign the Contact Details, Location, Community Name, and Trap Settings for a Simple Network Management Protocol (SNMP). SNMP is a networking management protocol used to monitor network attached devices. SNMP allows messages (called protocol data units) to be sent to various parts of the network. Upon receiving these messages, SNMP compatible devices (called agents) returns the data stored in their Management Information Bases.

| SNMP Settings | |
|-----------------------------|---|
| Status | <input checked="" type="radio"/> Enable <input type="radio"/> Disable |
| Contact | <input type="text"/> |
| Location | <input type="text"/> |
| Community Name (Read Only) | public |
| Community Name (Read Write) | private |
| Trap Destination | |
| - Port | 162 |
| - IP Address | <input type="text"/> |
| - Community Name | public |
| SNMPv3 Settings | |
| - Status | <input checked="" type="radio"/> Enable <input type="radio"/> Disable |
| - Username | admin (1-31 Characters) |
| - Authorized Protocol | MD5 |
| - Authorized Key | 12345678 (8-32 Characters) |
| - Private Protocol | DES |
| - Private Key | 12345678 (8-32 Characters) |
| - Engine ID | <input type="text"/> |

SNMP Enable/Disable: Enables or disables the SNMP feature.

Contact: Specifies the contact details of the device.

Location: Specifies the location of the device.

Community Name (Read Only): Specifies the password for the SNMP community for read only access.

Community Name (Read/Write): Specifies the password for the SNMP community with read/write access.

Trap Destination Address: Specifies the IP address of the computer that will receive the SNMP traps.

Trap Destination Community Name: Specifies the password for the SNMP trap community.

SNMPv3: Enables or disables the SNMPv3 feature.

User Name: Specifies the username for SNMPv3.

Auth Protocol: Selects the authentication protocol type: MD5 or SHA.

Auth Key: Specifies the authentication key.

Priv Protocol: Selects the privacy protocol type: DES.

Priv Key: Specifies the privacy key for privacy.

Engine ID: Specifies the engine ID for SNMPv3.

Apply Save: Click **Apply Save** to apply the changes.

CLI Settings

The image shows three stacked settings panels. The first is 'CLI Setting' with a 'Status' field set to 'Enable'. The second is 'SSH Setting' with a 'Status' field set to 'Enable'. The third is 'HTTPS Settings' with 'Status' and 'HTTPS forward' fields, both set to 'Enable'.

CLI: The Command Line Interface (CLI) allows you to type commands instead of choosing them from a menu or selecting an icon.

SSH: Enable Secure Shell (SSH) to make secure, encrypted connections in the network. Secure Shell is a network protocol that allows data to be exchanged using a secure channel between two network devices.

HTTPS: Enable HTTPS to transfer and display web content securely. The Hypertext Transfer Protocol over SSL (Secure Socket Layer) is a TCP/IP protocol used by web servers to transfer and display web content securely.

Email Alert

You can use the Email Alert feature to send messages to the configured email address when particular system events occur.

Note: Do **NOT** use your personal email address as it can unnecessarily expose your personal email login credentials. Use a separate email account made for this feature instead

The image shows the 'Email Alert' configuration form. The 'Status' is checked and set to 'Enable'. Fields include: '- From' (empty), '- To' (empty), '- Subject' (pre-filled with '[Email-Alert][ENS620EXT][88:]', with a cursor at the end), 'Email Account' (empty), '- Username' (empty), '- Password' (empty with a green eye icon), '- SMTP Server' (empty) with 'Port: 25' to its right, and '- Security Mode' (set to 'None'). A 'Send Test Mail' button is at the bottom right. Below the form is a blue 'Apply' button and the text 'Apply saved settings to take effect'.

Status: Enable this function for further settings.

From: Enter the email address to show the sender of the email.

To: Enter the address to receive email alerts.

Subject: Enter the text to appear in the email subject line.

Username: Enter the username for the email account that will be used to send emails.

Password: Enter the password for the email account that will be used to send emails.

SMTP Server: Enter the IP address or hostname of the outgoing SMTP server.

Port: Enter the SMTP port number to use for outbound emails.

Time Zone

Time Setting

This page allows you to set the internal clock of the AP.

Date and Time Settings

Manually Set Date and Time

Date: 2016 / 06 / 16

Time: 07 : 21 (24-Hour)

Synchronize with PC

Automatically Get Date and Time

NTP Server: pool.ntp.org

Time Zone

Time Zone: UTC+00:00 Gambia, Liberia, Morocco

Enable Daylight Saving

Start: January 1st Sun 00:00

End: January 1st Mon 00:00

Apply

Apply saved settings to take effect

Manually Set Date and Time: Manually specify the date and time.

Synchronize with PC: Click this button to synchronize Date and time of this AP with the PC.

Automatically Get Date and Time: Select Automatically Get Date and Time and check whether you wish to enter the IP address of an NTP server or use the default NTP server to have the internal clock set automatically.

Time Zone: Choose a time zone to implement the service for this AP.

Enable Daylight Saving: Check whether daylight savings applies to your area.

Start: Select the day, month, and time when daylight savings time starts.

Enable Daylight Saving: Select the day, month, and time when daylight savings times ends.

Auto Reboot Settings

You can specify how often you wish to reboot the AP.

Auto Reboot Setting

| | |
|--------|---|
| Status | <input type="checkbox"/> Enable <input checked="" type="radio"/> Disable |
| Timer | <input type="checkbox"/> Sunday <input type="checkbox"/> Monday <input type="checkbox"/> Tuesday <input type="checkbox"/> Wednesday <input type="checkbox"/> Thursday <input type="checkbox"/> Friday <input type="checkbox"/> Saturday |
| | 0 : 0 |

Auto Reboot Setting: Enables or disables the Auto Reboot function.

Timer: Select the day and enter the time you would like to reboot automatically.

Save: Click **Save** to apply the changes.

Wi-Fi Scheduler

The Wi-Fi Scheduler can be created for use in enforcing rules. For example, if you wish to restrict web access to Mon-Fri from 3pm to 8pm, you could create a schedule selecting Mon, Tue, Wed, Thu and Fri while entering a Start time of 3pm and End Time of 8pm to limit access to these times.

Wi-Fi Scheduler

Status Enable Disable
NOTE: Please assure that the Time Zone Settings is synced with your local time when enabling the Wi-Fi Scheduler

Wireless Radio 2.4GHz ▾

SSID Selection EnGenius330052_1-2.4GHz ▾

Schedule Templates Choose a template ▾

| Day | Available | Duration |
|-----------|-----------|---------------------|
| Sunday | available | ▾ 00 : 00 ~ 24 : 00 |
| Monday | available | ▾ 00 : 00 ~ 24 : 00 |
| Tuesday | available | ▾ 00 : 00 ~ 24 : 00 |
| Wednesday | available | ▾ 00 : 00 ~ 24 : 00 |
| Thursday | available | ▾ 00 : 00 ~ 24 : 00 |
| Friday | available | ▾ 00 : 00 ~ 24 : 00 |
| Saturday | available | ▾ 00 : 00 ~ 24 : 00 |

Status: Enables or disables the Wi-Fi scheduler function.

Wireless Radio: Select 2.4 GHz or 5 GHz from the drop-down list for the preferred band type.

SSID Selection: Select a SSID from the drop-down list.

Schedule Templates: Select a schedule template from the drop-down list.

Day(s): Place a checkmark in the boxes for the desired days or select the **All Week** radio button to select all seven days of the week.

Duration: The Start Time is entered in two fields. The first box is for hours and the second box is for minutes. The End Time is entered in the same format as the Start time.

Tools

Ping Test Parameters

This page allows you to analyze the connection quality of the AP and trace the routing table to a target in the network.

| Ping Test Parameters | |
|--------------------------------------|---|
| Target IP / Domain Name | <input type="text"/> |
| Ping Packet Size | <input type="text" value="64"/> Bytes |
| Number of Pings | <input type="text" value="4"/> |
| <input type="button" value="Start"/> | <div style="border: 1px solid #ccc; height: 150px; width: 100%;"></div> |

| Traceroute Test Parameters | |
|--|---|
| Target IP / Domain Name | <input type="text"/> |
| <input type="button" value="Start"/> <input type="button" value="Stop"/> | <div style="border: 1px solid #ccc; height: 150px; width: 100%;"></div> |

Target IP: Enter the IP address you would like to search.

Ping Packet Size: Enter the packet size of each ping.

Number of Pings: Enter the number of times you wish to ping.

Start Ping: Click **Start Ping** to begin pinging the target device (via IP).

Traceroute Target: Enter the IP address or domain name you wish to trace.

Start Traceroute: Click **Start Traceroute** to begin the trace route operation.

Speed Test Parameters / LED Control

This page allows you to implement speed test to realize the throughput of a target DUT.

Speed Test Parameters

| | |
|--------------------------------------|-------------------------------------|
| Target IP / Domain Name | <input type="text"/> |
| Time Period | <input type="text" value="20"/> Sec |
| Check Interval | <input type="text" value="5"/> Sec |
| IPv4Port | <input type="text" value="5001"/> |
| IPv6Port | <input type="text" value="5002"/> |
| <input type="button" value="Start"/> | |

Target IP / Domain Name: Enter an IP address or domain name you wish to implement a speed test for realizing the variance on wireless speed.

Time Period: Enter the time in seconds that you would like the test to implement for and in how many intervals.

IPv4/IPv6 Port: This Access Points uses IPv4 5001 and IPv6 5002 port for the speed test.

Start: Click start to implement speed test.

LED Control

Control LED on/off for Power, LAN interface, or 2.4 GHz/5 GHz WLAN interface.

LED Control

| | |
|--|---|
| Power | <input checked="" type="radio"/> Enable <input type="radio"/> Disable |
| LAN | <input checked="" type="radio"/> Enable <input type="radio"/> Disable |
| WLAN-2.4GHz | <input checked="" type="radio"/> Enable <input type="radio"/> Disable |
| WLAN-5GHz | <input checked="" type="radio"/> Enable <input type="radio"/> Disable |
| <input type="button" value="Apply"/> Apply saved settings to take effect | |

Power: Enables or disables the Power LED indicator.

LAN: Enables or disables the LAN LED indicator.

WLAN-2.4 GHz: Enables or disables the WLAN-2.4 GHz LED indicator.

WLAN-5 GHz: Enables or disables the WLAN-5 GHz LED indicator.

Device Discovery

This page allows you to discover devices from network for Operation Mode, IP Address, System MAC Address and Firmware version.

Device Discovery

| Device Name | Operation Mode | IP Address | System MAC Address | Firmware Version |
|-------------|----------------|------------|--------------------|------------------|
|-------------|----------------|------------|--------------------|------------------|

Scan

Account

This page allows you to change the AP username and password. By default, the username is: **admin** and the password is: **admin**. The password can contain from 0 to 12 alphanumeric characters and is case sensitive.

Account Settings

| Account Settings | |
|------------------------|--------------------------|
| Administrator Username | <input type="text"/> |
| Current Password | <input type="password"/> |
| New Password | <input type="password"/> |
| Verify Password | <input type="password"/> |

Administrator Username: Enter a new username for logging in to the New Name entry box.

Current Password: Enter the old password for logging in to the Old Password entry box.

New Password: Enter the new password for logging in to the New Password entry box.

Verify Password: Re-enter the new password in the Confirm Password entry box for confirmation.

Apply: Click **Apply** to apply the changes.

Firmware

Firmware Upgrade

This page allows you to upgrade the firmware of the AP.

Firmware Upgrade

Current Firmware Version: 1.0.0

Select the new firmware from your hard disk.

| | | |
|----------------------|----|--------|
| <input type="text"/> | 瀏覽 | Upload |
|----------------------|----|--------|

To Perform the Firmware Upgrade:

1. Click the **Choose File** button and navigate the OS file system to the location of the upgrade file.
2. Select the upgrade file. The name of the file will appear in the Upgrade File field.
3. Click the **Upload** button to commence the firmware upgrade.

Note: The device is unavailable during the Firmware upgrade process and must restart when the upgrade is completed. Any connections to or through the device will be lost.

Backup/Restore

This page allows you to save the current device configurations. When you save your configurations, you also can reload the saved configurations into the device through the Restore Saved Settings from a file section. If extreme problems occur, or if you have set the AP incorrectly, you can use the **Reset** button in the Revert to Factory Default Settings section to restore all the configurations of the AP to the original default settings.

Backup Setting: Click **Export** to save the current configured settings.

Restore New Setting: To restore settings that have been previously backed up, click **Browse**, select the file, and click **Restore**.

Restore to Default: Click **Reset** button to restore the AP to its factory default settings.

Backup/Restore Settings

Factory Setting

- Backup Setting ⓘ

Export

- Restore New Setting

選擇檔案 未選擇任何檔案

Import

- Reset to Default ⓘ

Reset

User Setting

- Back Up Setting as Default

Backup

- Restore to User Default ⓘ

Restore

- **Caution:** Please write down your account number and password before saving. The user settings will now become the new default settings at the next successful login.

User Setting

The function allows you to backup the current device configurations into the AP as the default value. If extreme problems occur, or if you have set the AP incorrectly, you can push the Reset button to revert all the configurations of the AP to the user default.

Back Up Setting as Default: Click **Backup** to backup the user settings you would like to the device's memory for the default settings.

Restore to User Default: Click **Restore** to restore user settings to the factory standard settings.

Note1: After setting the current settings as the default, you should click the **Restore to Default** on the web interface for reverting the settings into the factory default instead of pushing the reset button.

Note2: Please **write down** your account and password before saving. The user settings will now become the new default settings at the next successful login.

Log

System Log

The AP automatically logs (records) events of possible interest in its internal memory. To view the logged information, click the **Log** link under the System Manager menu. If there is not enough internal memory to log all events, older events are deleted from the log. When powered down or rebooted, the log will be cleared.

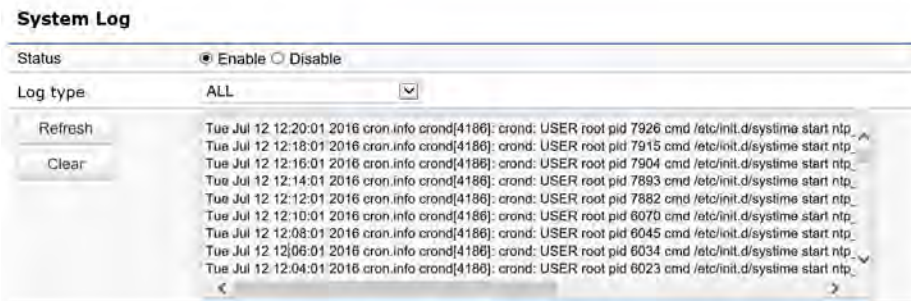

Status: Enable/Disable this function.

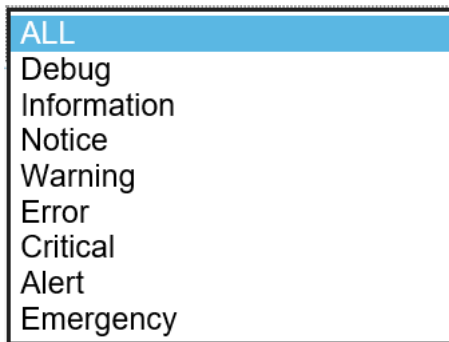

Log type: You may choose one of log types to display logs in the following window. The default log types is All.

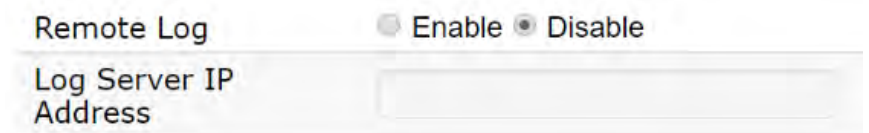

Remote Log

This page allows you to setup the Remote Log functions for this AP.

Remote Log: Enable/Disable this function.

Log Server IP Address: Enter the IP address of the log server.

Apply: Click **Apply** to apply the changes.

Logout

Logout: Click Logout in Management menu to logout.



Please confirm again to logout the system or not.

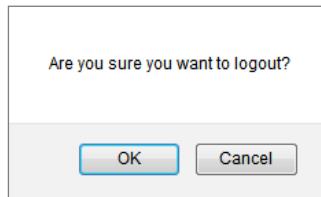

Reset

In some circumstances, it may be required to force the device to reboot. Click on **Reset** to reboot the AP.

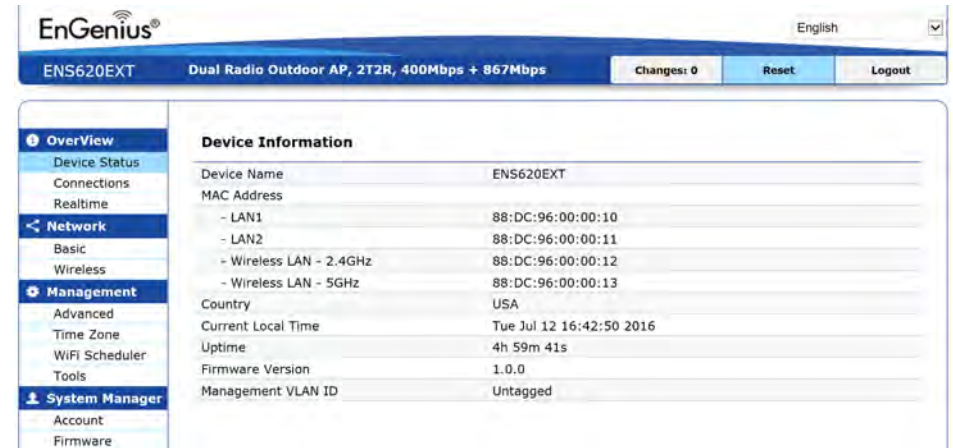

Once you click reset button, you will see the options for reboot or restore this AP.

Reboot the device: Click it to reboot this device.

Restore to Factory Default: Click it to reset this device to factory default setting.

Restore to User Default: Click it to reset this device to user default settings. For realizing the setting method, you may refer page 65 and page 66.

Reboot the device

Caution: Pressing this button will cause the device to reboot.

Reboot the device

Restore the device to default settings

Caution: All settings will be cleared and reset to either factory default or user default.

Restore to Factory Default

Restore to User Default

Appendix



Appendix A - FCC Interference Statement

Federal Communication Commission Interference Statement

This equipment has been tested and found to comply with the limits for a Class B digital device, pursuant to Part 15 of the FCC Rules. These limits are designed to provide reasonable protection against harmful interference in a residential installation. This equipment generates, uses and can radiate radio frequency energy and, if not installed and used in accordance with the instructions, may cause harmful interference to radio communications. However, there is no guarantee that interference will not occur in a particular installation. If this equipment does cause harmful interference to radio or television reception, which can be determined by turning the equipment off and on, the user is encouraged to try to correct the interference by one of the following measures:

- Reorient or relocate the receiving antenna.
- Increase the separation between the equipment and receiver.
- Connect the equipment into an outlet on a circuit different from that to which the receiver is connected.
- Consult the dealer or an experienced radio/TV technician for help



FCC Caution:

Any changes or modifications not expressly approved by the party responsible for compliance could void the user's authority to operate this equipment.

This device complies with Part 15 of the FCC Rules. Operation is subject to the following two conditions: (1) This device may not cause harmful interference, and (2) this device must accept any interference received, including interference that may cause undesired operation.

This transmitter must not be co-located or operating in conjunction with any other antenna or transmitter.

IMPORTANT NOTE:

Radiation Exposure Statement

ENS620EXT: This equipment complies with FCC radiation exposure limits set forth for an uncontrolled environment. This equipment should be installed and operated with minimum distance 21 cm between the radiator & your body.

ENS610EXT: This equipment complies with FCC radiation exposure limits set forth for an uncontrolled environment. This equipment should be installed and operated with minimum distance 25 cm between the radiator & your body.

ENS500-AC/ENS500EXT-AC: This equipment complies with FCC radiation exposure limits set forth for an uncontrolled environment. This equipment should be installed and operated with minimum distance 21 cm between the radiator & your body.

Appendix B - CE Interference Statement

Europe - EU Declaration of Conformity

This device complies with the essential requirements of the R&TTE Directive 1999/5/EC. The following test methods have been applied in order to prove presumption of conformity with the essential requirements of the R&TTE Directive 1999/5/EC:

- **EN60950-1**
Safety of Information Technology Equipment
- **EN50385**
Generic standard to demonstrate the compliance of electronic and electrical apparatus with the basic restrictions related to human exposure to electromagnetic fields (0 Hz - 300 GHz)
- **EN 300 328**
Electromagnetic compatibility and Radio spectrum Matters (ERM); Wideband Transmission systems; Data transmission equipment operating in the 2,4 GHz ISM band and using spread spectrum modulation techniques; Harmonized EN covering essential requirements under article 3.2 of the R&TTE Directive
- **EN 301 893**
Broadband Radio Access Networks (BRAN); 5 GHz high performance RLAN; Harmonized EN covering essential requirements of article 3.2 of the R&TTE Directive
- **EN 301 489-1**
Electromagnetic compatibility and Radio Spectrum Matters (ERM); ElectroMagnetic Compatibility (EMC) standard for radio equipment and services; Part 1: Common technical requirements
- **EN 301 489-17**
Electromagnetic compatibility and Radio spectrum Matters (ERM); ElectroMagnetic Compatibility (EMC) standard for radio equipment and services; Part 17: Specific conditions for 2,4 GHz wideband transmission systems and 5 GHz high performance RLAN equipment

This device is a 5GHz wideband transmission system (transceiver), intended for use in all EU member states and EFTA countries, except in France and Italy where restrictive use applies.

In Italy the end-user should apply for a license at the national spectrum authorities in order to obtain authorization to use the device for setting up outdoor radio links and/or for supplying public access to telecommunications and/or network services.

This device may not be used for setting up outdoor radio links in France and in some areas the RF output power may be limited to 10 mW EIRP in the frequency range of 2454 – 2483.5 MHz. For detailed information the end-user should contact the national spectrum authority in France.

CE 0560 

| | |
|-------------------|--|
| Česky [Czech] | [Jméno výrobce] tímto prohlašuje, že tento [typ zařízení] je ve shodě se základními požadavky a dalšími příslušnými ustanoveními směrnice 1999/5/ES. |
| Dansk [Danish] | Undertegnede [fabrikantens navn] erklærer herved, at følgende udstyr [udstyrets typebetegnelse] overholder de væsentlige krav og øvrige relevante krav i direktiv 1999/5/EF. |
| Deutsch [German] | Hiermit erkläre [Name des Herstellers], dass sich das Gerät [Gerätetyp] in Übereinstimmung mit den grundlegenden Anforderungen und den übrigen einschlägigen Bestimmungen der Richtlinie 1999/5/EG befindet. |
| Eesti [Estonian] | Käesolevaga kinnitab [tootja nimi = name of manufacturer] seadme [seadme tüüp = type of equipment] vastavust direktiivi 1999/5/EÜ põhinõuetele ja nimetatud direktiivist tulenevatele teistele asjakohastele sätetele. |
| English | Hereby, [name of manufacturer], declares that this [type of equipment] is in compliance with the essential requirements and other relevant provisions of Directive 1999/5/EC. |
| Español [Spanish] | Por medio de la presente [nombre del fabricante] declara que el [clase de equipo] cumple con los requisitos esenciales y cualesquiera otras disposiciones aplicables o exigibles de la Directiva 1999/5/CE. |
| Ελληνική [Greek] | ΜΕ ΤΗΝ ΠΑΡΟΥΣΑ [name of manufacturer] ΔΗΛΩΝΕΙ ΟΤΙ [type of equipment] ΣΥΜΜΟΡΦΩΝΕΤΑΙ ΠΡΟΣ ΤΙΣ ΟΥΣΙΩΔΕΙΣ ΑΠΑΙΤΗΣΕΙΣ ΚΑΙ ΤΙΣ ΛΟΙΠΕΣ ΣΧΕΤΙΚΕΣ ΔΙΑΤΑΞΕΙΣ ΤΗΣ ΟΔΗΓΙΑΣ 1999/5/ΕΚ. |

| | |
|------------------------|--|
| Français [French] | Par la présente [nom du fabricant] déclare que l'appareil [type d'appareil] est conforme aux exigences essentielles et aux autres dispositions pertinentes de la directive 1999/5/CE. |
| Italiano [Italian] | Con la presente [nome del costruttore] dichiara che questo [tipo di apparecchio] è conforme ai requisiti essenziali ed alle altre disposizioni pertinenti stabilite dalla direttiva 1999/5/CE. |
| Latviski [Latvian] | Ar šo [name of manufacturer / izgatavotāja nosaukums] deklarē, ka [type of equipment / iekārtas tips] atbilst Direktīvas 1999/ 5/EK būtiskajām prasībām un citiem ar to saistītajiem noteikumiem. |
| Lietuvių [Lithuanian] | Šiuo [manufacturer name] deklaruoja, kad šis [equipment type] atitinka esminius reikalavimus ir kitas 1999/5/EB Direktyvos nuostatas. |
| Nederlands [Dutch] | Hierbij verklaart [naam van de fabrikant] dat het toestel [type van toestel] in overeenstemming is met de essentiële eisen en de andere relevante bepalingen van richtlijn 1999/5/EG. |
| Malti [Maltese] | Hawnhekk, [isem tal-manifattur], jiddikjara li dan [il-mudal tal-prodott] jikkonforma mal-ħtiġijiet essenzjali u ma provvedimenti oħrajn relevanti li hemm fid-Dirrettiva 1999/5/EC. |
| Magyar [Hungarian] | Alulírott, [gyártó neve] nyilatkozom, hogy a [...] típus] megfelel a vonatkozó alapvető követelményeknek és az 1999/5/EC irányelv egyéb előírásainak. |
| Polski [Polish] | Niniejszym [nazwa producenta] oświadczam, że [nazwa wyrobu] jest zgodny z zasadniczymi wymogami oraz pozostałymi stosownymi postanowieniami Dyrektywy 1999/5/EC. |
| Português [Portuguese] | [Nome do fabricante] declara que este [tipo de equipamento] está conforme com os requisitos essenciais e outras disposições da Directiva 1999/5/CE. |
| Slovensko [Slovenian] | [Ime proizvajalca] izjavlja, da je ta [tip opreme] v skladu z bistvenimi zahtevami in ostalimi relevantnimi določili direktive 1999/5/ES. |
| Slovensky [Slovak] | [Meno výrobcu] týmto vyhlasuje, že [typ zariadenia] spĺňa základné požiadavky a všetky príslušné ustanovenia Smernice 1999/5/ES. |
| Suomi [Finnish] | [Valmistaja = manufacturer] vakuuttaa täten että [type of equipment = laitteen tyyppimerkintä] tyyppinen laite on direktiivin 1999/5/EY oleellisten vaatimusten ja sitä koskevien direktiivin muiden ehtojen mukainen. |
| Svenska [Swedish] | Härmed intygar [företag] att denna [utrustningstyp] står i överensstämmelse med de väsentliga egenskapskrav och övriga relevanta bestämmelser som framgår av direktiv 1999/5/EG. |

Appendix C - Professional Installation Instruction

Installation Personal

This product is designed for specific application and needs to be installed by a qualified personal who has RF and related rule knowledge. The general user shall not attempt to install or change the setting.

Installation Location

The product shall be installed at a location where the radiating antenna can be kept 20cm from nearby person in normal operation condition to meet regulatory RF exposure requirement.

External Antenna

Use only the antennas which have been approved by the applicant. The non-approved antenna(s) may produce unwanted spurious or excessive RF transmitting power which may lead to the violation of FCC limit and is prohibited.

Installation Procedure

Please refer to user's manual for the detail.



Warning:

Please carefully select the installation position and make sure that the final output power does not exceed the limit set force in relevant rules. The violation of the rule could lead to serious federal penalty.