



Are You Ready to Race?

Install batteries

charge it!

4a. Turn the switch on the bottom of the car to the Off position. (See Fig. 5)

4b. Locate charge contacts and Lock Platform.

4c. Align slot on rear of car with Lock Tab.

4d. Press vehicle down and back (gently) until it locks into place.

4e. Press charge button to charge the vehicle. The red light should blink while charging. When completed, the red light will shut off.

4f. Push vehicle backward and tilt front up to remove from charger. Car should remove easily from charger. Do not use excessive force!

what you get

Each Nakamichi Racer set includes the following items:

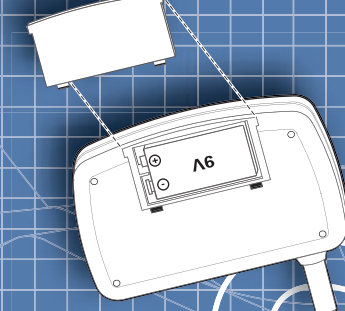
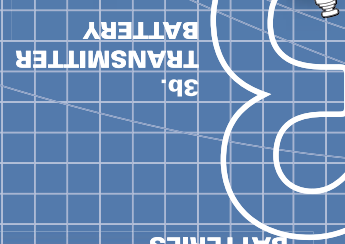
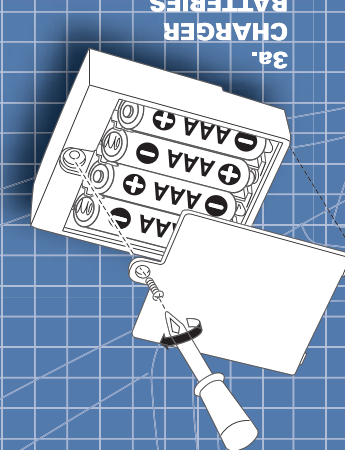
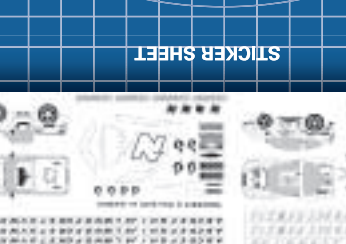
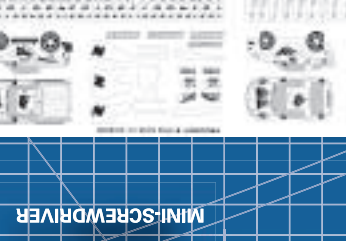
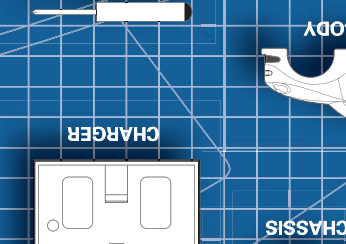
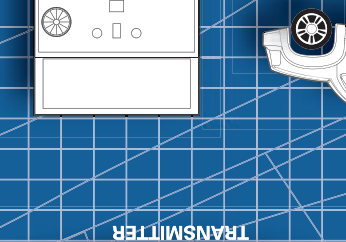
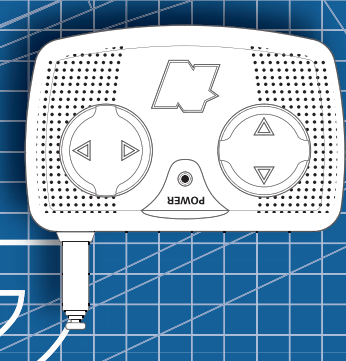

Although your Nakamichi Racer vehicle includes an internal rechargeable battery, you'll still need to buy some batteries for the transmitter and charger. The transmitter requires (1) 9V alkaline battery, and the charger requires (4) AAA alkaline batteries. You will need a small screwdriver to replace the batteries. Adult supervision is recommended when replacing batteries.

- BATTERY WARNINGS**
- DO NOT ATTEMPT TO RECHARGE RACER WITH ANY OTHER TYPE CHARGERS.
 - FOR BEST PERFORMANCE, USE ONLY ALKALINE BATTERIES.
 - DISPOSE OF BATTERIES SAFELY AND CORRECTLY.
 - DO NOT DISPOSE OF OLD BATTERIES IN FIRE.
 - BATTERIES MAY LEAK OR EXPLODE.
 - DO NOT ATTEMPT TO REMOVE NI-MH BATTERY FROM RACER.
 - DO NOT MIX OLD AND NEW BATTERIES.
 - DO NOT MIX ALKALINE BATTERIES WITH EITHER STANDARD (CARBON ZINC) OR RECHARGEABLE (NICKEL CADMIUM) BATTERIES.
 - EXHAUSTED BATTERIES SHOULD BE REMOVED FROM THE TOY.

start here

Congratulations! You've just become the proud owner of a Nakamichi Racer. This product is designed for hours of fun.

To ensure proper use and care, please take a minute and read the following instructions.

Don't sweat it, you'll be on the road in no time...

VEHICLE FEATURES

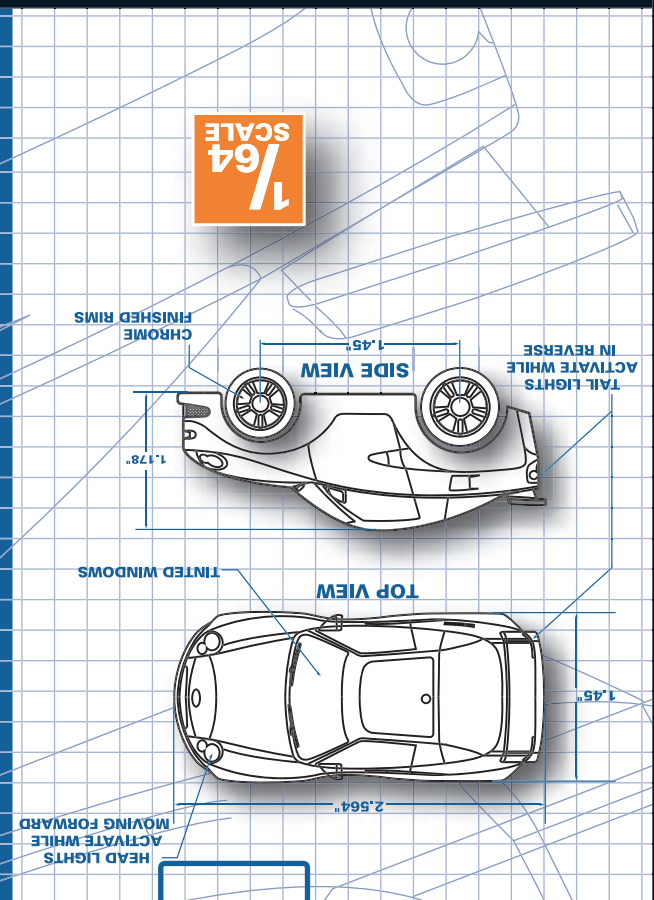

SCALE 1/64