

IMPORTANT NOTICE:

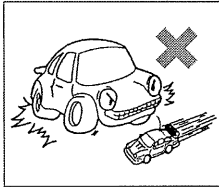

1. Do not mix old and new batteries.
2. Do not mix alkaline, standard (Carbon Zinc) or rechargeable (Nickel-Cadmium) batteries.
3. Batteries should be replaced by adults because of small parts.
4. Batteries are to be inserted with correct polarity.
5. Non-rechargeable batteries are not to be charged.
6. Only batteries of the same or equivalent type as recommended are to be used.

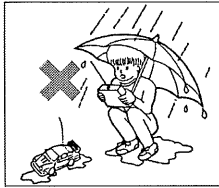

7. Expired batteries are to be removed from the toy and disposed of safely.
8. Don't operate your car in dangerous places.
9. Don't put your car and transmitter near any source of HEAT.
10. Don't run through water, including pools or puddles.
11. Avoid all possible collisions. Check the road ahead and watch for obstacles.

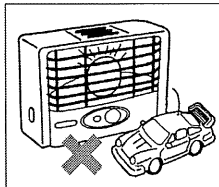

12. Avoid your car and transmitter antennas touching each other.
13. Don't operate your car in the vicinity of another radio-controlled car with the same frequency.
14. Don't leave your car and transmitter outside overnight. Night dampness will cause harm.
15. Don't forget to remove batteries from your car and transmitter if you are not going to operate the car again soon.
16. If malfunction occurs, replace batteries.
17. The supply terminals must not be short-circuited.
18. Rechargeable batteries are to be removed from the toy before being charged.
19. Rechargeable batteries are only to be charged under adult supervision.

Warning: Changes or modifications to this unit not expressly approved by the party responsible for compliance could void the user authority to operate the equipment.

NOTE: This equipment has been tested and found to comply with the limits for a Class B digital device, pursuant to Part 15 of the FCC Rules. These limits are designed to provide reasonable protection against harmful interference in a residential installation. This equipment generates, uses and can radiate radio frequency energy and, if not installed and used in accordance with the instructions, may cause harmful interference to radio communications.

However, there is no guarantee that interference will not occur in a particular installation. If this equipment does cause harmful interference to radio or television reception, which can be determined by turning the equipment off and on, the user is encouraged to try to correct the interference by one or more of the following measures:

- Reorient or relocate the receiving antenna.
- Increase the separation between the equipment and receiver.
- Connect the equipment into an outlet on a circuit different from that to which the receiver is connected.
- Consult the dealer or an experienced radio/TV technician for help.

INSTRUCTION MANUAL

USE UNDER SUPERVISION OF AN ADULT

RADIO CONTROL

• PLEASE READ CAREFULLY BEFORE STARTING TO OPERATE

Licensed

HUMMER

- FULLY DIRECTIONAL
- WHEEL ALIGNMENT

1:14 SCALE



NO. 1803
(BATTERIES NOT INCLUDED)
BATTERIES REQUIREMENTS:

- CAR: 5 x 'AA' (R6) 1.5V BATTERIES (Not Included)
- TRANSMITTER: 1 x '9V' (6LR1) BATTERY (Not Included)

NO. 18031
(BATTERIES INCLUDED)

BATTERIES REQUIREMENTS:

- CAR: 5 x 'AA' (R6) 1.5V BATTERIES (Included)
- TRANSMITTER: 1 x '9V' (6LR1) BATTERY (Included)

WARNING:
CHOKING HAZARD—Small parts.
Not for children under 3 years.

ENERTEC
Enertec Enterprises Ltd

(Retain packaging as it contains important information.)

BATTERY & ON/OFF SWITCH DIAGRAM AND BATTERY INSTALLATION

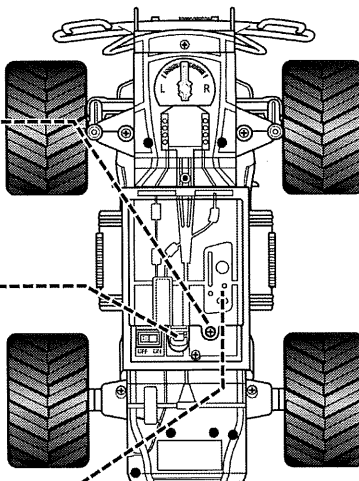
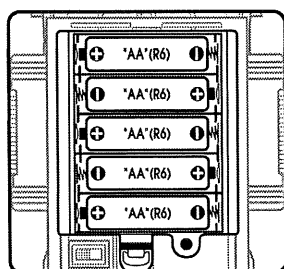
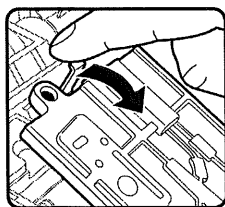
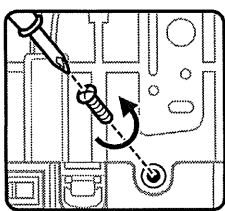

VEHICLE

- LOOSEN THE SCREW AND OPEN THE BATTERY COMPARTMENT AT THE BOTTOM OF THE CHASSIS.
- INSERT 5 x 'AA' (R6) BATTERIES INTO THE BATTERY COMPARTMENT. ENSURE THE POLARITIES OF THE BATTERIES (+ AND -) MATCH THE MARKINGS ON THE BATTERY COMPARTMENT.
- CLOSE AND TIGHTEN THE BATTERY COVER.

***IMPORTANT!**
SWITCH TO 'OFF' POSITION AFTER USE TO AVOID DRAINAGE OF BATTERIES.

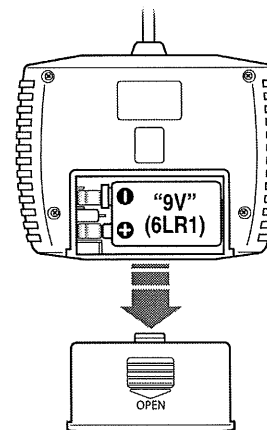

TRANSMITTER

- SLIDE THE BATTERY COMPARTMENT COVER OFF AND INSTALL 1 x '9V' (6LR1) BATTERY.
- ENSURE THE POLARITY SIGNS OF BATTERY MATCH THOSE ON BATTERY COMPARTMENT.
- REPLACE COVER.

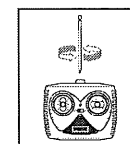

- SCREW THE ANTENNA IN THE CAVITY OF THE TRANSMITTER, AND ENSURE IT IS FULLY EXTENDED WHEN IN USE.

HOW TO OPERATE:

1. TURN ON/OFF SWITCH AT BOTTOM OF VEHICLE TO 'ON' POSITION.
2. FORWARD. PUSH LEFT JOYSTICK FORWARD.
3. REVERSE. PULL LEFT JOYSTICK BACKWARD.
4. STEERING. MOVE RIGHT JOYSTICK IN EITHER DIRECTION TO TURN LEFT OR RIGHT.
5. JOYSTICKS AUTOMATICALLY RETURN TO NEUTRAL WHEN RELEASED.

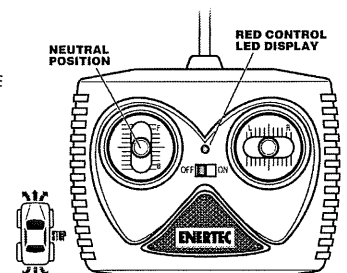

WHEEL ALIGNMENT

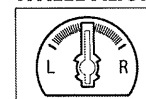

ADJUST THE DIRECTION TRIMMER ON UNDERSIDE OF VEHICLE IF THE VEHICLE DOES NOT RUN STRAIGHT. TURN TO LEFT OR RIGHT UNTIL YOUR DESIRED ALIGNMENT IS REACHED.